

TOSHIBA

ENGLISH

INSTALLATION MANUAL
AIR CONDITIONER (SPLIT TYPE)



Indoor unit
RAS-B10, 13, 16N3KV2-E1

Outdoor unit
RAS-10, 13N3AV2-E1
RAS-16N3AV2-E



1115551126

PRECAUTIONS FOR SAFETY	1
INSTALLATION DIAGRAM OF INDOOR AND OUTDOOR UNITS	3
■ Optional Installation Parts	3
INDOOR UNIT	4
■ Installation Place.....	4
■ Cutting a Hole and Mounting Installation Plate.....	4
■ Wiring Connection.....	4
■ How to Connect Remote Controller for Wire Operation.....	5
■ Piping and Drain Hose Installation.....	6
■ Indoor Unit Fixing.....	7
■ Drainage	7
OUTDOOR UNIT	7
■ Installation Place.....	7
■ Precautions about Installation in Regions with Snowfall and Cold Temperatures	7
■ Refrigerant Piping Connection.....	7
■ Evacuating	8
■ Electrical Work.....	8
■ Wiring Connection.....	9
OTHERS	9
■ Gas Leak Test	9
■ Remote Control A-B Selection	9
■ Test Operation	9
■ Auto Restart Setting	9

PRECAUTIONS FOR SAFETY

The manufacturer shall not assume any liability for the damage caused by not observing the description of this manual.

Be sure to read this installation manual carefully before installing.

Recommend to the owner to perform maintenance periodically when using over long periods of time.

Be sure to follow the precautions provided here to avoid safety risks. The symbols and their meanings are shown below.

DANGER : It indicates that incorrect use of this unit can result in a high possibility of severe injury (*1) or death.

WARNING : It indicates that incorrect use of this unit may cause severe injury or death.

CAUTION : It indicates that incorrect use of this unit may cause personal injury (*2), or property damage (*3).

*1 : A severe injury refers to blindness, injury, burns (hot or cold), electrical shock, bone fracture, or poisoning that leaves aftereffects and requires hospitalization or extended out-patient treatment.

*2 : Personal injury means a slight accident, burn, or electrical shock which does not require admission or repeated hospital treatment.

*3 : Property damage means greater damage which affects assets or resources.

For general public use

Power supply cord and connecting cable of appliance use shall be at least polychloroprene sheathed flexible cord (design H07RN-F) or cord designation 60245 IEC66. (Shall be installed in accordance with national wiring regulations.)

CAUTION

New refrigerant air conditioner installation

• **THIS AIR CONDITIONER USES THE NEW HFC REFRIGERANT (R410A), WHICH DOES NOT DESTROY THE OZONE LAYER.**

R410A refrigerant is apt to be affected by impurities such as water, oxidizing membranes, and oils because the pressure of R410A refrigerant is approx. 1.6 times of refrigerant R22. As well as the adoption of this new refrigerant, refrigerating machine oil has also been changed. Therefore, during installation work, be sure that water, dust, former refrigerant, or refrigerating machine oil does not enter the refrigeration cycle of a new-refrigerant air conditioner. To avoid mixing refrigerant and refrigerating machine oil, the sizes of charging port connecting sections on the main unit are different from those for the conventional refrigerant, and different size tools are also required. For connecting pipes, use new and clean piping materials with high pressure withstand capabilities, designed for R410A only, and ensure that water or dust does not enter. Moreover, do not use any existing piping as its pressure withstand may be insufficient and may contain impurities.

DANGER

- FOR USE BY QUALIFIED PERSONS ONLY.
- MEANS FOR DISCONNECTION FROM THE SUPPLY HAVING A CONTACT SEPERATION OF AT LEAST 3 mm IN ALL POLES MUST BE INCORPORATED IN THE FIXED WIRING.
- TURN OFF MAIN POWER SUPPLY BEFORE ATTEMPTING ANY ELECTRICAL WORK. MAKE SURE ALL POWER SWITCHES ARE OFF. FAILURE TO DO SO MAY CAUSE ELECTRIC SHOCK.
- CONNECT THE CONNECTING CABLE CORRECTLY. IF THE CONNECTING CABLE IS CONNECTED WRONGLY, ELECTRIC PARTS MAY BE DAMAGED.
- CHECK THE EARTH WIRE THAT IT IS NOT BROKEN OR DISCONNECTED BEFORE INSTALLATION.
- DO NOT INSTALL NEAR CONCENTRATIONS OF COMBUSTIBLE GAS OR GAS VAPORS. FAILURE TO FOLLOW THIS INSTRUCTION CAN RESULT IN FIRE OR EXPLOSION.
- TO PREVENT OVERHEATING THE INDOOR UNIT AND CAUSING A FIRE HAZARD, PLACE THE UNIT WELL AWAY (MORE THAN 2 M) FROM HEAT SOURCES SUCH AS RADIATORS, HEATERS, FURNACE, STOVES, ETC.
- WHEN MOVING THE AIR CONDITIONER FOR INSTALLING IT IN ANOTHER PLACE AGAIN, BE VERY CAREFUL NOT TO GET THE SPECIFIED REFRIGERANT (R410A) WITH ANY OTHER GASEOUS BODY INTO THE REFRIGERATION CYCLE. IF AIR OR ANY OTHER GAS IS MIXED IN THE REFRIGERANT, THE GAS PRESSURE IN THE REFRIGERATION CYCLE BECOMES ABNORMALLY HIGH AND IT RESULTINGLY CAUSES BURST OF THE PIPE AND INJURIES ON PERSONS.
- IN THE EVENT THAT THE REFRIGERANT GAS LEAKS OUT OF THE PIPE DURING THE INSTALLATION WORK, IMMEDIATELY LET FRESH AIR INTO THE ROOM. IF THE REFRIGERANT GAS IS HEATED BY FIRE OR SOMETHING ELSE, IT CAUSES GENERATION OF POISONOUS GAS.
- WHEN INSTALLING OR RE-INSTALLING THE AIR CONDITIONER, DO NOT INJECT AIR OR OTHER SUBSTANCES BESIDES THE DESIGNATED REFRIGERANT "R410A" INTO THE REFRIGERATING CYCLE. IF AIR OR OTHER SUBSTANCES ARE MIXED, AN ABNORMAL PRESSURE CAN OCCUR IN THE REFRIGERATING CYCLE, AND THIS CAN CAUSE AN INJURY DUE TO A PIPE RUPTURE.

WARNING

- Installation work must be requested from the supplying retail dealership or professional vendors. Self-installation may cause water leakage, electrical shock, or fire as a result of improper installation.
- Specified tools and pipe parts for model R410A are required, and installation work must be done in accordance with the manual. HFC type refrigerant R410A has 1.6 times more pressure than that of conventional refrigerant (R22). Use the specified pipe parts, and ensure correct installation, otherwise damage and/or injury may be caused. At the same time, water leakage, electrical shock, and fire may occur.
- Be sure to install the unit in a place which can sufficiently bear its weight. If the load bearing of the unit is not enough, or installation of the unit is improper, the unit may fall and result in injury.
- Electrical work must be performed by a qualified electrical engineer in accordance with the code governing such installation work, internal wiring regulations, and the manual. A dedicated circuit and the rated voltage must be used. Insufficient power supply or improper installation may cause electrical shock or fire.
- Use a cabtyre cable to connect wires in the indoor/outdoor units. Midway connection, stranded wire, and single-wire connections are not allowed. Improper connection or fixing may cause a fire.
- Wiring between the indoor unit and outdoor units must be well shaped so that the cover can be firmly placed. Improper cover installation may cause increased heat, fire, or electrical shock at the terminal area.
- Be sure to use only approved accessories or the specified parts. Failure to do so may cause the unit to fall, water leakage, fire or electrical shock.
- After the installation work, ensure that there is no leakage of refrigerant gas. If the refrigerant gas leaks out of the pipe into the room and is heated by fire or something else from a fan heater, stove or gas range, it causes generation of poisonous gas.
- Make sure the equipment is properly earthed. Do not connect the earth wire to a gas pipe, water pipe, lightning conductor, or telephone earth wire. Improper earth work may be the cause of electrical shock.
- Do not install the unit where flammable gas may leak. If there is any gas leakage or accumulation around the unit, it can cause a fire.
- Do not select a location for installation where there may be excessive water or humidity, such as a bathroom. Deterioration of insulation may cause electrical shock or fire.
- Installation work must be performed following the instructions in this installation manual. Improper installation may cause water leakage, electrical shock or fire. Check the following items before operating the unit.
 - Be sure that the pipe connection is well placed and there are no leaks.
 - Check that the service valve is open. If the service valve is closed, it may cause overpressure and result in compressor damage. At the same time, if there is a leak in the connection part, it may cause air suction and overpressure, resulting burst or injury.
- In pump down operations, ensure to perform the following procedures.
 - Do not inject air into the refrigeration cycle.
 - Be sure to close both service valves and stop the compressor before removing the refrigerant pipe. If removing the refrigerant pipe while the compressor is operating with the service valves opened, it may cause to air absorbed and abnormal high pressure inside the refrigeration cycle and resulting burst or injury.
- Do not modify the power cable, connect the cable midway, or use a multiple outlet extension cable. Doing so may cause contact failure, insulation failure, or excess current, resulting in fire or electrical shock.
- Do not use any refrigerant different from the one specified for complement or replacement. Otherwise, abnormally high pressure may be generated in the refrigeration cycle, which may result in a failure or explosion of the product or an injury to your body.
- Be sure to comply with local regulations/codes when running the wire from the outdoor unit to the indoor unit. (Size of wire and wiring method etc.)
- Places where iron or other metal dust is present. If iron or other metal dust adheres to or collects on the interior of the air conditioner, it may spontaneously combust and start a fire.
- If you detect any damage, do not install the unit. Contact your supplying dealer immediately.
- Never modify this unit by removing any of the safety guards.
- Do not install in a place which cannot bear the weight of the unit. Personal injury and property damage can result if the unit falls.

CAUTION

- Please read this installation manual carefully before installing the unit. It contains further important instructions for proper installation.
- Exposure of unit to water or other moisture before installation could result in electric shock. Do not store it in a wet basement or expose to rain or water.
- After unpacking the unit, examine it carefully for possible damage.
- Do not install in a place that can increase the vibration of the unit. Do not install in a place that can amplify the noise level of the unit or where noise and discharged air might disturb neighbors.
- This appliance must be connected to the main power supply by means of a circuit breaker depending on the place where the unit is installed. Failure to do so may cause electrical shock.
- Follow the instructions in this installation manual to arrange the drain pipe for proper drainage from the unit. Ensure that drained water is discharged. Improper drainage can result in water leakage, causing water damage to furniture.
- Tighten the flare nut with a torque wrench using the prescribed method. Do not apply excess torque. Otherwise, the nut may crack after a long period of usage and it may cause the leakage of refrigerant.
- Wear gloves (heavy gloves such as cotton gloves) for installation work. Failure to do so may cause personal injury when handling parts with sharp edges.
- Do not touch the air intake section or the aluminum fins of the outdoor unit. It may cause injury.
- Do not install the outdoor unit in a place which can be a nest for small animals. Small animals could enter and contact internal electrical parts, causing a failure or fire.
- Request the user to keep the place around the unit tidy and clean.
- Make sure to conduct a trial operation after the installation work, and explain how to use and maintain the unit to the customer in accordance with the manual. Ask the customer to keep the operation manual along with the installation manual.

REQUIREMENT OF REPORT TO THE LOCAL POWER SUPPLIER

Please make absolutely sure that the installation of this appliance is reported to the local power supplier before installation. If you experience any problems or if the installation is not accepted by the supplier, the service agency will take adequate countermeasures.

INSTALLATION DIAGRAM OF INDOOR AND OUTDOOR UNITS

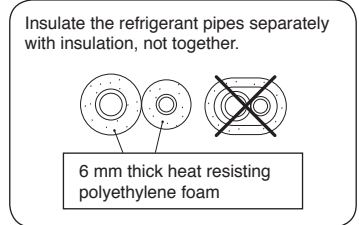
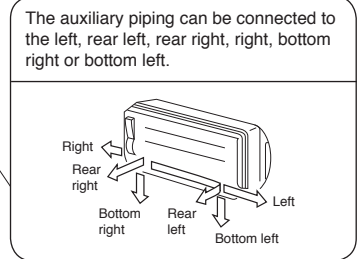
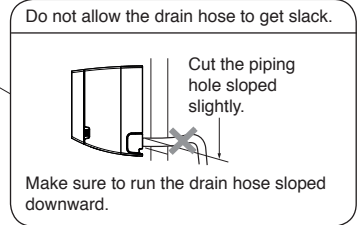
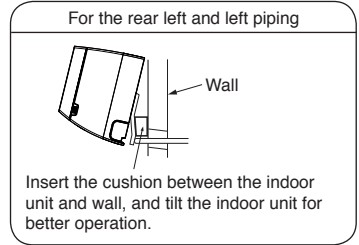
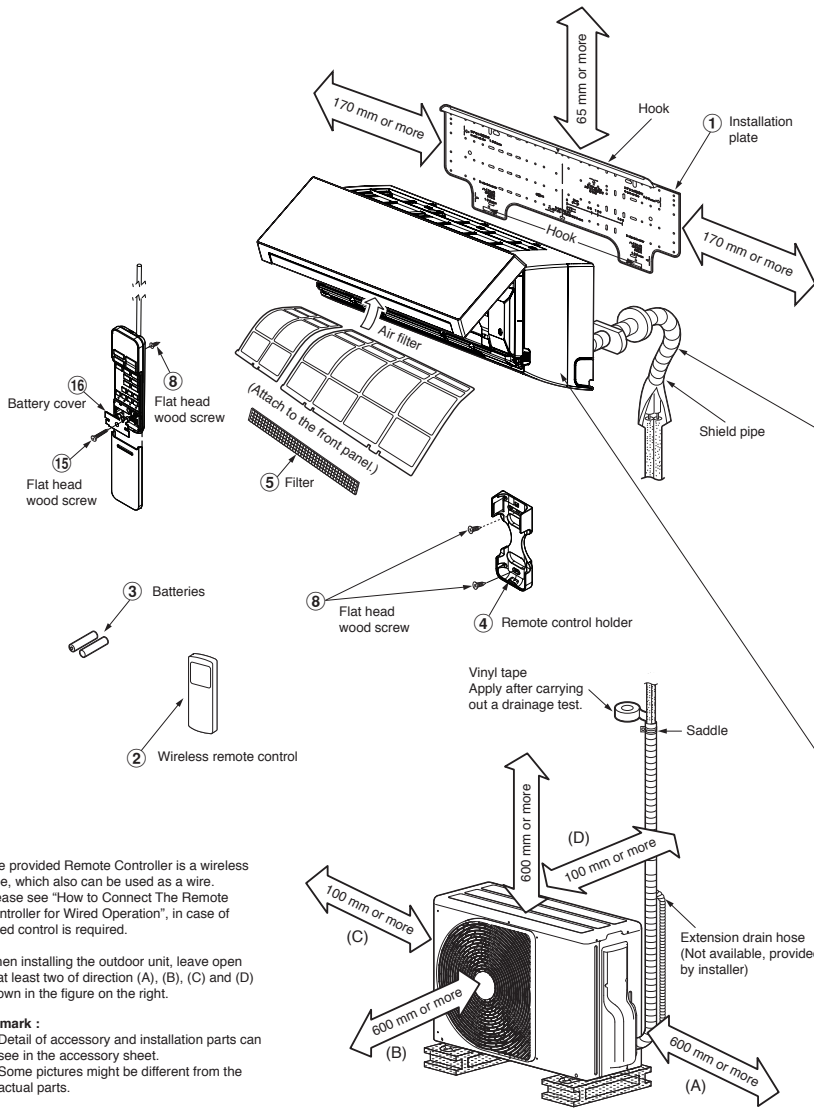

The provided Remote Controller is a wireless type, which also can be used as a wire. Please see "How to Connect The Remote Controller for Wired Operation", in case of wired control is required.

When installing the outdoor unit, leave open in at least two of direction (A), (B), (C) and (D) shown in the figure on the right.

Remark :

- Detail of accessory and installation parts can see in the accessory sheet.
- Some pictures might be different from the actual parts.

Optional Installation Parts

Part code	Parts name	Q'ty
(A)	Refrigerant piping Liquid side : $\text{Ø}6.35$ mm Gas side : $\text{Ø}9.52$ mm (RAS-B10, 13N3KV2-E1) : $\text{Ø}12.70$ mm (RAS-B16N3KV2-E1)	One each
(B)	Pipe insulating material (polyethylene foam, 6 mm thick)	1
(C)	Putty, PVC tapes	One each

Fixing bolt arrangement of outdoor unit

- Secure the outdoor unit with fixing bolts and nuts if the unit is likely to be exposed to a strong wind.
- Use $\text{Ø}8$ mm or $\text{Ø}10$ mm anchor bolts and nuts.
- If it is necessary to drain the defrost water, attach drain nipple (9) and cap water proof (10) to the bottom plate of the outdoor unit before installing it.

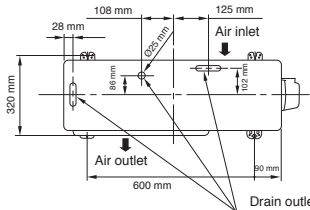

* Drain nipple and cap water proof are packed in outdoor unit.

※ When using a multi-system outdoor unit is used, refer to the installation manual provided with the model concerned.

INDOOR UNIT

Installation Place

- A place which provides the spaces around the indoor unit as shown in the diagram
- A place where there are no obstacles near the air inlet and outlet
- A place which allows easy installation of the piping to the outdoor unit
- A place which allows the front panel to be opened
- The indoor unit shall be installed as top of the indoor unit comes to at least 2 m height. Also, it must be avoided to put anything on the top of the indoor unit.

CAUTION

- Direct sunlight to the indoor unit's wireless receiver should be avoided.
- The microprocessor in the indoor unit should not be too close to RF noise sources.
(For details, see the owner's manual.)

Remote control

- A place where there are no obstacles such as a curtain that may block the signal from the indoor unit
- Do not install the remote control in a place exposed to direct sunlight or close to a heating source such as a stove.
- Keep the remote control at least 1 m apart from the nearest TV set or stereo equipment. (This is necessary to prevent image disturbances or noise interference.)
- The location of the remote control should be determined as shown below.

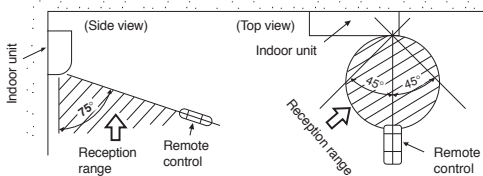

Cutting a Hole and Mounting Installation Plate

Cutting a hole

When installing the refrigerant pipes from the rear

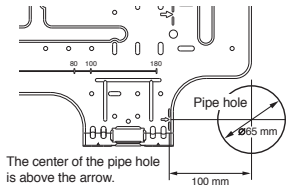

1. After determining the pipe hole position on the mounting plate (➔), drill the pipe hole (Ø65 mm) at a slight downward slant to the outdoor side.

NOTE

- When drilling a wall that contains a metal lath, wire lath or metal plate, be sure to use a pipe hole brim ring sold separately.

Mounting the installation plate

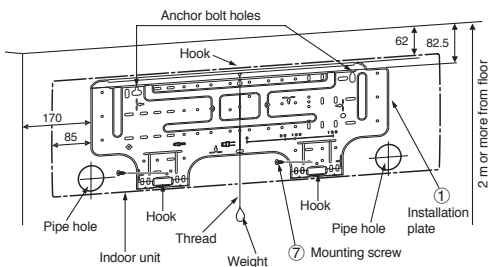

When the installation plate is directly mounted on the wall

1. Securely fit the installation plate onto the wall by screwing it in the upper and lower parts to hook up the indoor unit.
2. To mount the installation plate on a concrete wall with anchor bolts, use the anchor bolt holes as illustrated in the below figure.
3. Install the installation plate horizontally in the wall.

CAUTION

When installing the installation plate with a mounting screw, do not use the anchor bolt holes. Otherwise, the unit may fall down and result in personal injury and property damage.

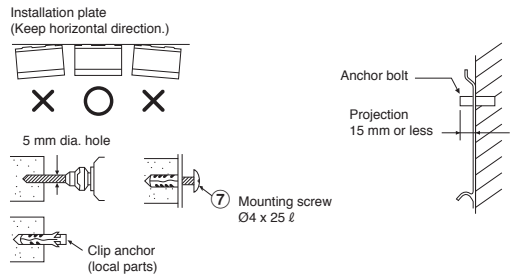

CAUTION

Failure to firmly install the unit may result in personal injury and property damage if the unit falls.

- In case of block, brick, concrete or similar type walls, make 5 mm dia. holes in the wall.
- Insert clip anchors for appropriate mounting screws ⑦.

NOTE

- Secure four corners and lower parts of the installation plate with 4 to 6 mounting screws to install it.

Wiring Connection

How to connect the connecting cable

Wiring of the connecting cable can be carried out without removing the front panel.

1. Remove the air inlet grille.
Open the air inlet grille upward and pull it toward you.
2. Remove the terminal cover and cord clamp.
3. Insert the connecting cable (according to the local cords) into the pipe hole on the wall.
4. Take out the connecting cable through the cable slot on the rear panel so that it protrudes from the front show on the figure below.
5. Insert the connecting cable fully into the terminal block and secure it tightly with screws.
6. Tighten firmly but not over 1.2 N·m (0.12 kgf·m).
7. Secure the connecting cable with the cord clamp.
8. Fix the terminal cover, rear plate bushing and air inlet grille on the indoor unit.

CAUTION

- Be sure to refer to the wiring system diagram labeled inside the front panel.
- Check local electrical cords and also any specific wiring instructions or limitations.

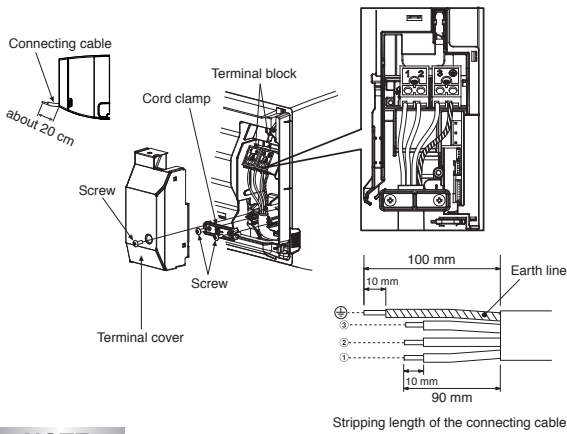

Stripping length of the connecting cable

NOTE

- Use stranded wire only.
- Wire type : More than H07RN-F or 60245 IEC66 (1.5 mm² or more)

How to Connect Remote Controller for Wire Operation

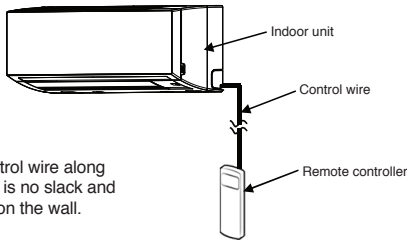

CAUTION

- Be sure to install control wire along the wall so that there is no slack and fix remote controller on the wall.

For indoor unit

1. Open the air inlet grille upward.
2. Securely remove two screws at the front panel.
3. Slightly open the lower part of the front panel then pull the upper part of the front panel toward you to remove it from the rear plate as shown on figure ①.
4. After removing the front panel, remove the Display unit and open the cover as shown on figure ② and ③.
5. Arrange the control wire as detail and specification as shown on figure ④.
6. Securely connect the control wire to terminal of Display unit board as shown on figure ⑤ (tighten firmly but not over 0.12 N·m (0.01 kgf·m)).
7. Set the control wire throughout at slot on front cover of Display unit then reassembly Display with main casing by reverse process of figure ② and ③. Make sure the control wire must not be pressed by front and rear cover of Display unit.
8. Set the control wire out from indoor unit same portion as power supply and connecting cable as shown on figure ⑥.
9. Reassembly the indoor unit by reverse process of 1 to 3.

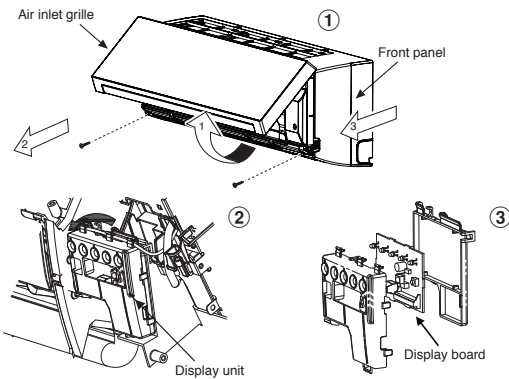

* Wire size 28-22AWG
or 0.08-0.32 mm²
Outer diameter not over 4.7 mm,
control wire length less than 30 m.

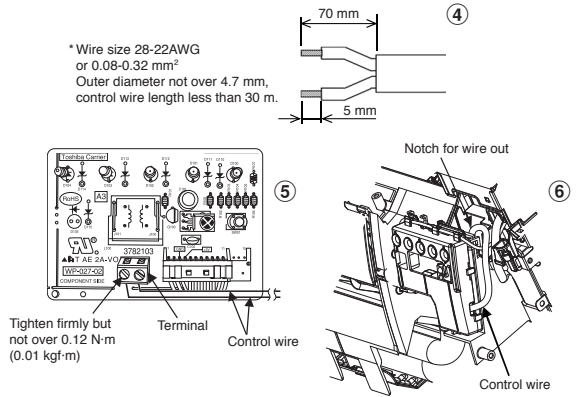

For remote controller

1. Remove cover of remote controller by sliding down and take it out.
2. If batteries are exist, please take them out. The combination of using wire controller and batteries may cause of batteries explosion.
3. Make hole for insert control wire by use screwdriver break the polyester sheet as shown on figure ⑦.
4. Insert control wire from rear side of remote controller as shown on figure ⑧.
5. Fix control wire which arrange as shown on figure ⑨ and ⑩ to terminal by provided screws (tighten firmly but not over 0.25 N·m (0.03 kgf·m)).
6. Set control wire through gutter way at rear side of remote controller as shown on figure ⑪.
7. Fix provided screw (Ø3.1×16L) on the wall to hang remote controller as shown on figure ⑫.
8. Mark and arrange hole for fix below screw (Ø3.1×25L) as shown on figure ⑬.
9. Assembly battery cover which provided with accessory bag then use provide screw (Ø3.1×25L) to fix battery cover together with wall as shown on figure ⑭ (tighten firmly but not over 0.15 N·m (0.02 kgf·m)).
10. Reassembly cover of remote controller.

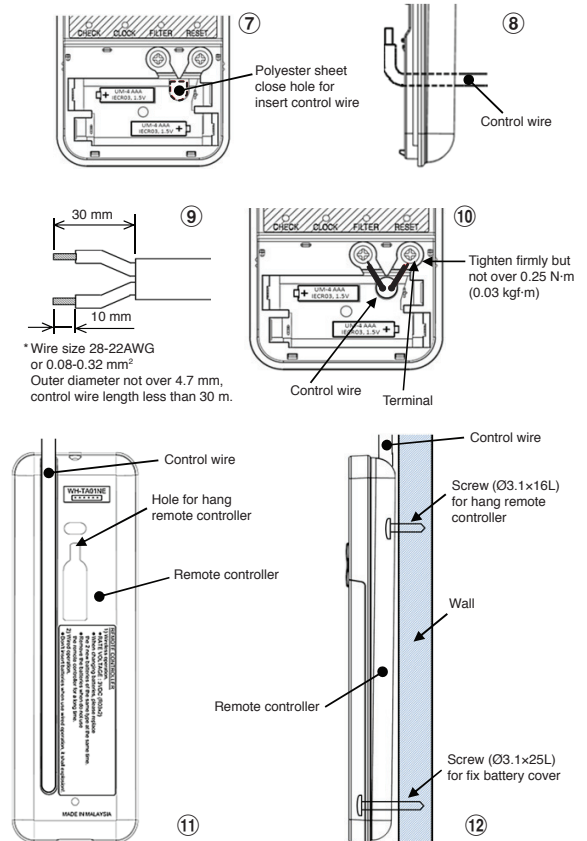

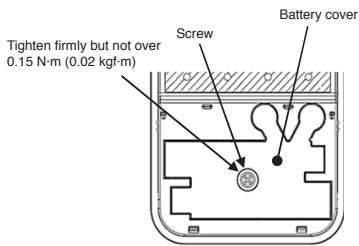

13

- *Remark :**
1. Recommend to use double insulation lead wire for connect remote control and air conditioner.
 2. For wire operation, 1 remote control can control only 1 indoor unit.
 3. In wire operation, remote controller will return to initial condition (PRESET, TIMER and CLOCK will return to initial condition) when user shutdown power supply of air conditioner.

How to install the air inlet grille on the indoor unit

- When attaching the air inlet grille, the contrary of the removed operation is performed.



Piping and Drain Hose Installation

Piping and drain hose forming

- Since dewing results in a machine trouble, make sure to insulate both connecting pipes. (Use polyethylene foam as insulating material.)

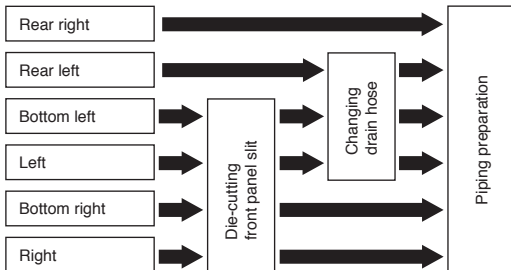

1. Die-cutting front panel slit

Cut out the slit on the leftward or right side of the front panel for the left or right connection and the slit on the bottom left or right side of the front panel for the bottom left or right connection with a pair of nippers.

2. Changing drain hose

For leftward connection, bottom-leftward connection and rearleftward connection's piping, it is necessary to change the drain hose and drain cap.

How to remove the drain hose

- The drain hose can be removed by removing the screw securing the drain hose and then pulling out the drain hose.
- When removing the drain hose, be careful of any sharp edges of steel plate. The edges can injure.
- To install the drain hose, insert the drain hose firmly until the connection part contacts with heat insulator, and then secure it with original screw.

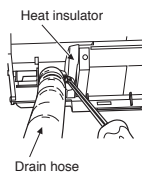

How to remove the drain cap

Clip the drain cap by needle-nose pliers and pull out.

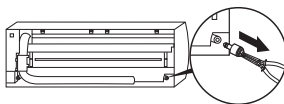

How to fix the drain cap

- 1) Insert hexagon wrench (4 mm) in a center head.

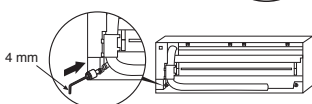

- 2) Firmly insert the drain cap.

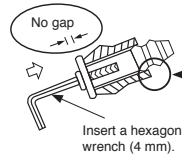

Do not apply lubricating oil (refrigerant machine oil) when inserting the drain cap. Application causes deterioration and drain leakage of the plug.

CAUTION

Firmly insert the drain hose and drain cap; otherwise, water may leak.

In case of right or left piping

- After scribing slits of the front panel with a knife or a making-off pin, cut them with a pair of nippers or an equivalent tool.

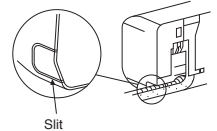

In case of bottom right or bottom left piping

- After scribing slits of the front panel with a knife or a making-off pin, cut them with a pair of nippers or an equivalent tool.

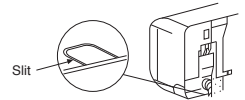

Left-hand connection with piping

- Bend the connecting pipe so that it is laid within 43 mm above the wall surface. If the connecting pipe is laid exceeding 43 mm above the wall surface, the indoor unit may unstably be set on the wall. When bending the connecting pipe, make sure to use a spring bender so as not to crush the pipe.

Bend the connecting pipe within a radius of 30 mm.

To connect the pipe after installation of the unit (figure)

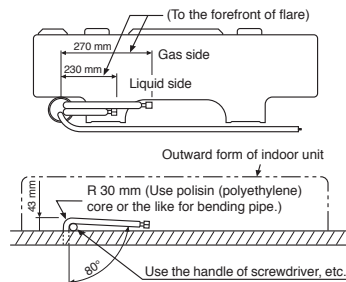

NOTE

If the pipe is bent incorrectly, the indoor unit may unstably be set on the wall. After passing the connecting pipe through the pipe hole, connect the connecting pipes to the auxiliary pipes and wrap the facing tape around them.

CAUTION

- Bind the auxiliary pipes (two) and connecting cable with facing tape tightly. In case of leftward piping and rear-leftward piping, bind the auxiliary pipes (two) only with facing tape.

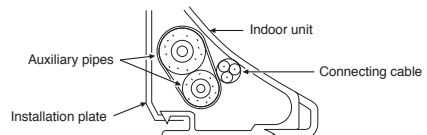

- Carefully arrange pipes so that any pipe does not stick out of the rear plate of the indoor unit.
- Carefully connect the auxiliary pipes and connecting pipes to one another and cut off the insulating tape wound on the connecting pipe to avoid double-taping at the joint; moreover, seal the joint with the vinyl tape, etc.
- Since dewing results in a machine trouble, make sure to insulate both connecting pipes. (Use polyethylene foam as insulating material.)
- When bending a pipe, carefully do it, not to crush it.

Indoor Unit Fixing

1. Pass the pipe through the hole in the wall and hook the indoor unit on the installation plate at the upper hook.
2. Swing the indoor unit to right and left to confirm that it is firmly hooked up on the installation plate.
3. While pressing the indoor unit onto the wall, hook it at the lower part on the installation plate. Pull the indoor unit toward you to confirm that it is firmly hooked up on the installation plate.

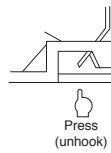
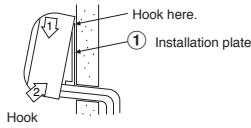

- For detaching the indoor unit from the installation plate, pull the indoor unit toward you while pushing its bottom up at the specified parts.

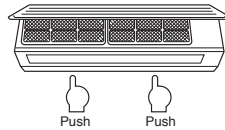

Drainage

1. Run the drain hose sloped downwards.

NOTE

- The hole should be made at a slight downward slant on the outdoor side.

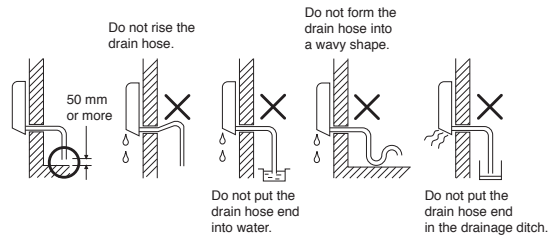

2. Put water in the drain pan and make sure that the water is drained out of doors.
3. When connecting extension drain hose, insulate the connecting part of extension drain hose with shield pipe.

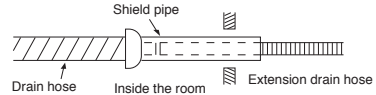

CAUTION

Arrange the drain pipe for proper drainage from the unit. Improper drainage can result in dew-dropping.

This air conditioner has the structure designed to drain water collected from dew, which forms on the back of the indoor unit, to the drain pan. Therefore, do not store the power cord and other parts at a height above the drain guide.

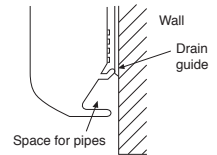

OUTDOOR UNIT

Installation Place

- A place which provides the spaces around the outdoor unit as shown in the diagram
- A place which can bear the weight of the outdoor unit and does not allow an increase in noise level and vibration
- A place where the operation noise and discharged air do not disturb your neighbors
- A place which is not exposed to a strong wind
- A place free of a leakage of combustible gases
- A place which does not block a passage
- When the outdoor unit is to be installed in an elevated position, be sure to secure its feet.
- An allowable length of the connecting pipe is up to 20 m. If the length is over 15 m, add 20g of refrigerant for every additional meter of the pipe length for all models.
- An allowable height level is up to 10 m.
- A place where the drain water does not raise any problems

CAUTION

1. Install the outdoor unit without anything blocking the air discharging.
2. When the outdoor unit is installed in a place always exposed to strong wind like a coast or on a high storey of a building, secure the normal fan operation using a duct or a windshield.
3. In particularly windy areas, install the unit such as to avoid admission of wind.
4. Installation in the following places may result in trouble. Do not install the unit in such places.
 - A place full of machine oil
 - A saline-place such as the coast
 - A place full of sulfide gas
 - A place where high-frequency waves are likely to be generated as from audio equipment, welders, and medical equipment

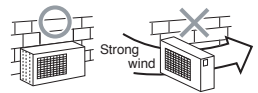

Precautions about Installation in Regions with Snowfall and Cold Temperatures

- Do not use the supplied drain nipple for draining water. Drain the water from all the drain holes directly.
- To protect the outdoor unit from snow accumulation, install a holding frame, and attach a snow protection hood and plate.
- Do not use a double-stacked design.

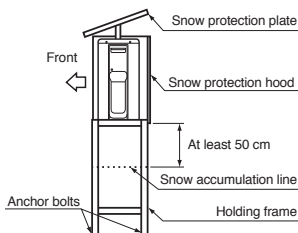

Install at least 50 cm above the snow accumulation line.

Refrigerant Piping Connection

Flaring

1. Cut the pipe with a pipe cutter.

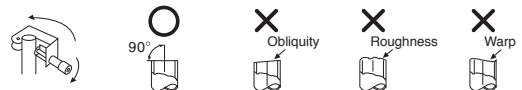

2. Insert a flare nut into the pipe and flare the pipe.

- Projection margin in flaring : A (Unit : mm)

RIGID (clutch type)

Outer dia. of copper pipe	R410A tool used	Conventional tool used
6.35	0 to 0.5	1.0 to 1.5
9.52	0 to 0.5	1.0 to 1.5
12.70	0 to 0.5	1.0 to 1.5

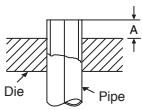

IMPERIAL (wing nut type)

Outer dia. of copper pipe	R410A
6.35	1.5 to 2.0
9.52	1.5 to 2.0
12.70	2.0 to 2.5

Tightening connection

Align the centers of the connecting pipes and tighten the flare nut as far as possible with your fingers. Then tighten the nut with a spanner and torque wrench as shown in the figure.

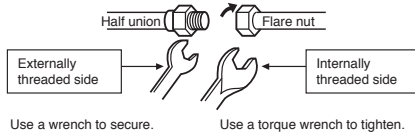

Use a wrench to secure.

Use a torque wrench to tighten.

CAUTION

Do not apply excess torque. Otherwise, the nut may crack depending on the conditions.

(Unit : N·m)

Outer dia. of copper pipe	Tightening torque
Ø6.35 mm	14 to 18 (1.4 to 1.8 kgf·m)
Ø9.52 mm	33 to 42 (3.3 to 4.2 kgf·m)
Ø12.70 mm	50 to 62 (5.0 to 6.2 kgf·m)

Tightening torque of flare pipe connections

The operating pressure of R410A is higher than that of R22 (approx. 1.6 times). It is therefore necessary to firmly tighten the flare pipe connecting sections (which connect the indoor and outdoor units) up to the specified tightening torque. Incorrect connections may cause not only a gas leakage, but also damage to the refrigeration cycle.

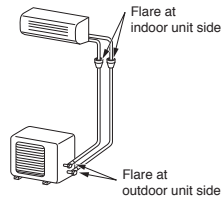

Shaping pipes

- How to shape the pipes
Shape the pipes along the incused line on the outdoor unit.
- How to fit position of the pipes
Put the edges of the pipes to the place with a distance of 85 mm from the incused line.

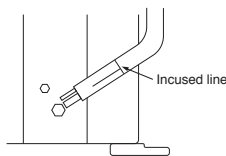

Evacuating

After the piping has been connected to the indoor unit, you can perform the air purge together at once.

AIR PURGE

Evacuate the air in the connecting pipes and in the indoor unit using a vacuum pump. Do not use the refrigerant in the outdoor unit. For details, see the manual of the vacuum pump.

Using a vacuum pump

Be sure to use a vacuum pump with counter-flow prevention function so that inside oil of the pump does not flow backward into pipes of the air conditioner when the pump stops.
(If oil inside of the vacuum pump enters the air conditioner, which use R410A, refrigeration cycle trouble may result.)

- Connect the charge hose from the manifold valve to the service port of the packed valve at gas side.
- Connect the charge hose to the port of the vacuum pump.
- Open fully the low pressure side handle of the gauge manifold valve.
- Operate the vacuum pump to start evacuating. Perform evacuating for about 15 minutes if the piping length is 20 meters. (15 minutes for 20 meters) (assuming a pump capacity of 27 liters per minute) Then confirm that the compound pressure gauge reading is -101 kPa (-76 cmHg).
- Close the low pressure side valve handle of the gauge manifold valve.
- Open fully the valve stem of the packed valves (both gas and liquid sides).
- Remove the charging hose from the service port.
- Securely tighten the caps on the packed valves.

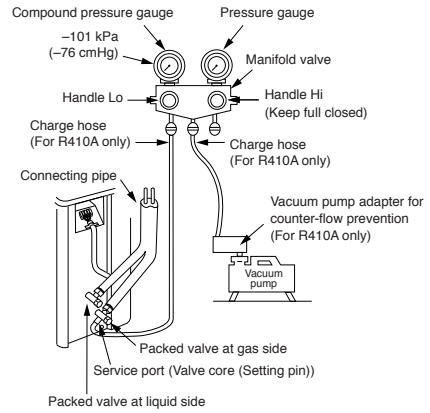

CAUTION

KEEP IMPORTANT 5 POINTS FOR PIPING WORK.

- Take away dust and moisture (inside of the connecting pipes).
- Tighten the connections (between pipes and unit).
- Evacuate the air in the connecting pipes using a VACUUM PUMP.
- Check gas leak (connected points).
- Be sure to fully open the packed valves before operation.

Packed valve handling precautions

- Open the valve stem all the way out, but do not try to open it beyond the stopper.

Pipe size of Packed Valve	Size of Hexagon wrench
12.70 mm and smaller	A = 4 mm
15.88 mm	A = 5 mm

- Securely tighten the valve cap with torque in the following table.

Cap	Cap Size (H)	Torque
Valve Rod Cap	H17 - H19	14~18 N·m (1.4 to 1.8 kgf·m)
	H22 - H30	33~42 N·m (3.3 to 4.2 kgf·m)
Service Port Cap	H14	8~12 N·m (0.8 to 1.2 kgf·m)
	H17	14~18 N·m (1.4 to 1.8 kgf·m)

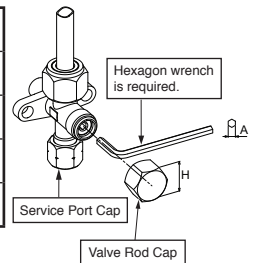

Electrical Work

- The power supply line must be supplied to outdoor unit.
- The supply voltage must be the same as the rated voltage of the air conditioner.
- Prepare the power source for exclusive use with the air conditioner.

NOTE

- Wire type : More than H07RN-F or 245 IEC66 (1.5 mm² or more)

CAUTION

- Connection to fixed wiring:
A switch or circuit breaker which disconnects all poles and has a contact separation of at least 3 mm must be incorporated in the fixed wiring. An approved circuit breaker or switches must be used.
- Perform wiring works so as to allow a general wiring capacity.

Wiring Connection

1. Remove the valve cover from the outdoor unit.
2. Connect power cord to the terminal block [L], [N] and [⊕] then connect the connecting cable to the terminals as identified with their respective matched numbers on the terminal block of indoor and outdoor unit.
3. Insulate the unused cords (conductors) from any water coming in the outdoor unit. Proceed them so that they do not touch any electrical or metal parts.

Stripping length of the connecting cable

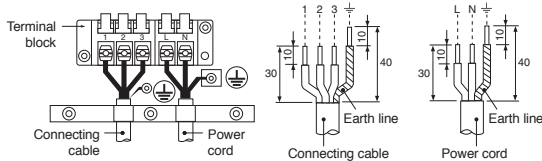

* When using a multi-system outdoor unit is used, refer to the installation manual provided with the model concerned.

Model	RAS-B10N3KV2-E1	RAS-B13N3KV2-E1	RAS-B16N3KV2-E1
Power source	50Hz, 220 – 240 V Single phase 60Hz, 220 – 230 V Single phase		
Maximum running current	8.5A	9.2A	11.0A
Circuit breaker	11.0A	12.0A	14.0A
Power cord	H07RN-F or 60245 IEC66 (1.5 mm ² or more)		
Connecting cable	H07RN-F or 60245 IEC66 (1.5 mm ² or more)		

CAUTION

- Wrong wiring connection may cause some electrical parts burn out.
- Be sure to comply with local cords on running the wire from indoor unit to outdoor unit (size of wire and wiring method, etc.).
- Every wire must be connected firmly.
- This installation circuit breaker must be used specified for the power supply line of this air conditioner.
- If incorrect or incomplete wiring is carried out, it will cause an ignition or smoke.
- Prepare the power supply for exclusive use with the air conditioner.
- This product can be connected to the mains.
Connection to fixed wiring: A switch which disconnects all poles and has a contact separation of at least 3 mm must be incorporated in the fixed wiring.

OTHERS

Gas Leak Test

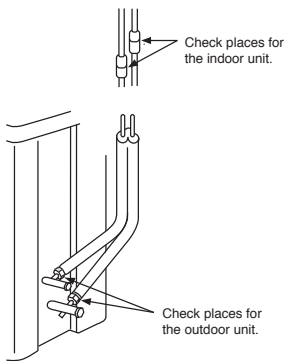

- Check the flare nut connections for the gas leak with a gas leak detector or soap water.

Remote Control A-B Selection

- When two indoor units are installed in the same room or adjacent two rooms, if operating a unit, two units may receive the remote control signal simultaneously and operate. In this case, the operation can be preserved by setting either one remote control to B setting. (Both are set to A setting in factory shipment.)
- The remote control signal is not received when the settings of indoor unit and remote control are different.
- There is no relation between A setting/B setting and A room/B room when connecting the piping and cables.

To separate using of remote control for each indoor unit in case of 2 air conditioner are installed near.

Remote Control B Setup.

1. Press [RESET] button on the indoor unit to turn the air conditioner ON.
2. Point the remote control at the indoor unit.
3. Push and hold [CHECK] button on the Remote Control by the tip of the pencil. "00" will be shown on the display (Picture ①).
4. Press [MODE] during pushing [CHECK]. "B" will show on the display and "00" will disappear and the air conditioner will turn OFF. The Remote Control B is memorized (Picture ②).

Note : 1. Repeat above step to reset Remote Control to be A.
2. Remote Control A has not "A" display.
3. Default setting of Remote Control from factory is A.



Test Operation

To switch to the TEST RUN (COOL) mode, press [RESET] button for 10 seconds. (The beeper will make a short beep.)

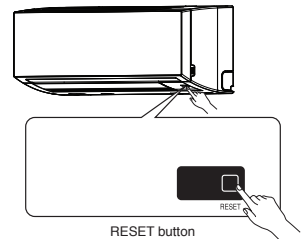

Auto Restart Setting

This product is designed so that, after a power failure, it can restart automatically in the same operating mode as before the power failure.

Information

The product was shipped with Auto Restart function in the off position. Turn it on as required.

How to set the Auto Restart

1. Press and hold the [RESET] button on the indoor unit for 3 seconds to set the operation. (3 beep sound and OPERATION lamp blink 5 time/sec for 5 seconds)
2. Press and hold the [RESET] button on the indoor unit for 3 seconds to cancel the operation. (3 beep sound but OPERATION lamp does not blink)
 - In case of ON timer or OFF timer are set, AUTO RESTART OPERATION does not activate.

The image features the Toshiba logo in a bold, black, sans-serif font, centered on a white background. The logo is surrounded by several semi-transparent, gray, spherical bubbles of varying sizes, some of which have a slight shadow, giving them a three-dimensional appearance. The bubbles are scattered across the page, with a larger one near the top center and others of various sizes around it. In the bottom right corner, there is a gray curved shape that partially overlaps the white background.

TOSHIBA



1115551126