

TOSHIBA

Leading Innovation >>>

AIR CONDITIONER (SPLIT TYPE)

Installation Manual

Indoor Unit

Model name: _____

High Wall Type

RAV-SM566KRT-E

RAV-SM806KRT-E

For commercial use

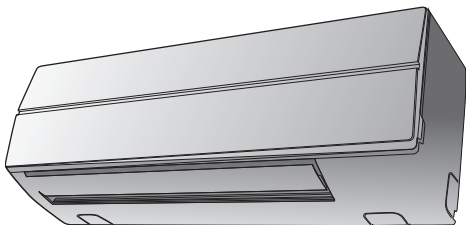

Original instruction

- Please read this Installation Manual carefully before installing the Air Conditioner.
- This Manual describes the installation method of the indoor unit.
 - For installation of the outdoor unit, refer to the Installation Manual attached to the outdoor unit.

ADOPTION OF NEW REFRIGERANT

This Air Conditioner uses R410A an environmentally friendly refrigerant.

Contents

1	Precautions for safety	3
2	Accessory parts	4
3	Selection of installation place	5
4	Installation	6
5	Cutting a hole and mounting installation plate	6
6	Piping and drain hose installation	7
7	Indoor unit fixing	8
8	Drainage	8
9	Refrigerant piping	8
10	Electrical connection	10
11	Applicable controls	12
12	Test run	19
13	Maintenance	20
14	Troubleshooting	21

Thank you for purchasing this Toshiba air conditioner.
 Please read carefully through these instructions that contain important information which complies with the "Machinery" Directive (Directive 2006 / 42 / EC), and ensure that you understand them.
 After completing the installation work, hand over this Installation Manual as well as the Owner's Manual provided to the user, and ask the user to keep them in a safe place for future reference.

Generic Denomination: Air Conditioner

Definition of Qualified Installer or Qualified Service Person

The air conditioner must be installed, maintained, repaired and removed by a qualified installer or qualified service person. When any of these jobs is to be done, ask a qualified installer or qualified service person to do them for you. A qualified installer or qualified service person is an agent who has the qualifications and knowledge described in the table below.

Agent	Qualifications and knowledge which the agent must have
Qualified installer	<ul style="list-style-type: none"> • The qualified installer is a person who installs, maintains, relocates and removes the air conditioners made by Toshiba Carrier Corporation. He or she has been trained to install, maintain, relocate and remove the air conditioners made by Toshiba Carrier Corporation or, alternatively, he or she has been instructed in such operations by an individual or individuals who have been trained and is thus thoroughly acquainted with the knowledge related to these operations. • The qualified installer who is allowed to do the electrical work involved in installation, relocation and removal has the qualifications pertaining to this electrical work as stipulated by the local laws and regulations, and he or she is a person who has been trained in matters relating to electrical work on the air conditioners made by Toshiba Carrier Corporation or, alternatively, he or she has been instructed in such matters by an individual or individuals who have been trained and is thus thoroughly acquainted with the knowledge related to this work. • The qualified installer who is allowed to do the refrigerant handling and piping work involved in installation, relocation and removal has the qualifications pertaining to this refrigerant handling and piping work as stipulated by the local laws and regulations, and he or she is a person who has been trained in matters relating to refrigerant handling and piping work on the air conditioners made by Toshiba Carrier Corporation or, alternatively, he or she has been instructed in such matters by an individual or individuals who have been trained and is thus thoroughly acquainted with the knowledge related to this work. • The qualified installer who is allowed to work at heights has been trained in matters relating to working at heights with the air conditioners made by Toshiba Carrier Corporation or, alternatively, he or she has been instructed in such matters by an individual or individuals who have been trained and is thus thoroughly acquainted with the knowledge related to this work.
Qualified service person	<ul style="list-style-type: none"> • The qualified service person is a person who installs, repairs, maintains, relocates and removes the air conditioners made by Toshiba Carrier Corporation. He or she has been trained to install, repair, maintain, relocate and remove the air conditioners made by Toshiba Carrier Corporation or, alternatively, he or she has been instructed in such operations by an individual or individuals who have been trained and is thus thoroughly acquainted with the knowledge related to these operations. • The qualified service person who is allowed to do the electrical work involved in installation, repair, relocation and removal has the qualifications pertaining to this electrical work as stipulated by the local laws and regulations, and he or she is a person who has been trained in matters relating to electrical work on the air conditioners made by Toshiba Carrier Corporation or, alternatively, he or she has been instructed in such matters by an individual or individuals who have been trained and is thus thoroughly acquainted with the knowledge related to this work. • The qualified service person who is allowed to do the refrigerant handling and piping work involved in installation, repair, relocation and removal has the qualifications pertaining to this refrigerant handling and piping work as stipulated by the local laws and regulations, and he or she is a person who has been trained in matters relating to refrigerant handling and piping work on the air conditioners made by Toshiba Carrier Corporation or, alternatively, he or she has been instructed in such matters by an individual or individuals who have been trained and is thus thoroughly acquainted with the knowledge related to this work. • The qualified service person who is allowed to work at heights has been trained in matters relating to working at heights with the air conditioners made by Toshiba Carrier Corporation or, alternatively, he or she has been instructed in such matters by an individual or individuals who have been trained and is thus thoroughly acquainted with the knowledge related to this work.

Definition of Protective Gear





When the air conditioner is to be transported, installed, maintained, repaired or removed, wear protective gloves and 'safety' work clothing.

In addition to such normal protective gear, wear the protective gear described below when undertaking the special work detailed in the table below.

Failure to wear the proper protective gear is dangerous because you will be more susceptible to injury, burns, electric shocks and other injuries.

Work undertaken	Protective gear worn
All types of work	Protective gloves 'Safety' working clothing
Electrical-related work	Gloves to provide protection for electricians and from heat Insulating shoes Clothing to provide protection from electric shock
Work done at heights (50 cm or more)	Helmets for use in industry
Transportation of heavy objects	Shoes with additional protective toe cap
Repair of outdoor unit	Gloves to provide protection for electricians and from heat

Warning indications on the air conditioner unit

Warning indication	Description		
 <table border="1"> <tr> <td>WARNING</td> </tr> <tr> <td>ELECTRICAL SHOCK HAZARD Disconnect all remote electric power supplies before servicing.</td> </tr> </table>	WARNING	ELECTRICAL SHOCK HAZARD Disconnect all remote electric power supplies before servicing.	<p>WARNING</p> <p>ELECTRICAL SHOCK HAZARD Disconnect all remote electric power supplies before servicing.</p>
WARNING			
ELECTRICAL SHOCK HAZARD Disconnect all remote electric power supplies before servicing.			
 <table border="1"> <tr> <td>WARNING</td> </tr> <tr> <td>Moving parts. Do not operate unit with grille removed. Stop the unit before the servicing.</td> </tr> </table>	WARNING	Moving parts. Do not operate unit with grille removed. Stop the unit before the servicing.	<p>WARNING</p> <p>Moving parts. Do not operate unit with grille removed. Stop the unit before the servicing.</p>
WARNING			
Moving parts. Do not operate unit with grille removed. Stop the unit before the servicing.			
 <table border="1"> <tr> <td>CAUTION</td> </tr> <tr> <td>High temperature parts. You might get burned when removing this panel.</td> </tr> </table>	CAUTION	High temperature parts. You might get burned when removing this panel.	<p>CAUTION</p> <p>High temperature parts. You might get burned when removing this panel.</p>
CAUTION			
High temperature parts. You might get burned when removing this panel.			
 <table border="1"> <tr> <td>CAUTION</td> </tr> <tr> <td>Do not touch the aluminum fins of the unit. Doing so may result in injury.</td> </tr> </table>	CAUTION	Do not touch the aluminum fins of the unit. Doing so may result in injury.	<p>CAUTION</p> <p>Do not touch the aluminium fins of the unit. Doing so may result in injury.</p>
CAUTION			
Do not touch the aluminum fins of the unit. Doing so may result in injury.			
 <table border="1"> <tr> <td>CAUTION</td> </tr> <tr> <td>BURST HAZARD Open the service valves before the operation, otherwise there might be the burst.</td> </tr> </table>	CAUTION	BURST HAZARD Open the service valves before the operation, otherwise there might be the burst.	<p>CAUTION</p> <p>BURST HAZARD Open the service valves before the operation, otherwise there might be the burst.</p>
CAUTION			
BURST HAZARD Open the service valves before the operation, otherwise there might be the burst.			

1 Precautions for safety

The manufacturer shall not assume any liability for the damage caused by not observing the description of this manual.

WARNING

General

- Before starting to install the air conditioner, read through the Installation Manual carefully, and follow its instructions to install the air conditioner.
- Only a qualified installer(*1) or qualified service person(*1) is allowed to do installation work. Inappropriate installation may result in water leakage, electric shock or fire.
- Do not use any refrigerant different from the one specified for complement or replacement. Otherwise, abnormally high pressure may be generated in the refrigeration cycle, which may result in a failure or explosion of the product or an injury to your body.
- Before opening the front panel of the indoor unit or service panel of the outdoor unit, set the circuit breaker to the OFF position. Failure to set the circuit breaker to the OFF position may result in electric shocks through contact with the interior parts. Only a qualified installer(*1) or qualified service person(*1) is allowed to remove the front panel of the indoor unit or service panel of the outdoor unit and do the work required.
- Before carrying out the installation, maintenance, repair or removal work, be sure to set the circuit breaker to the OFF position. Otherwise, electric shocks may result.
- Place a "Work in progress" sign near the circuit breaker while the installation, maintenance, repair or removal work is being carried out. There is a danger of electric shocks if the circuit breaker is set to ON by mistake.
- Only a qualified installer(*1) or qualified service person(*1) is allowed to undertake work at heights using a stand of 50 cm or more or to remove the front panel of the indoor unit to undertake work.
- Wear protective gloves and safety work clothing during installation, servicing and removal.
- Do not touch the aluminium fin of the unit. You may injure yourself if you do so. If the fin must be touched for some reason, first put on protective gloves and safety work clothing, and then proceed.
- Do not climb onto or place objects on top of the outdoor unit. You may fall or the objects may fall off of the outdoor unit and result in injury.
- When work is performed at heights, use a ladder which complies with the ISO 14122 standard, and follow the procedure in the ladder's instructions. Also wear a helmet for use in industry as protective gear to undertake the work.
- Before cleaning the filter or other parts of the outdoor unit, set the circuit breaker to OFF without fail, and place a "Work in progress" sign near the circuit breaker before proceeding with the work.
- Before working at heights, put a sign in place so that no-one will approach the work location, before proceeding with the work. Parts and other objects may fall from above, possibly injuring a person below. While carrying out the work, wear a helmet for protection from falling objects.
- The refrigerant used by this air conditioner is the R410A.
- The air conditioner must be transported in stable condition. If any part of the product is broken, contact the dealer.
- When the air conditioner must be transported by hand, carry it by two or more people.
- Do not move or repair any unit by yourself. There is high voltage inside the unit. You may get electric shock while removing the cover and main unit.

Selection of installation location

- When the air conditioner is installed in a small room, provide appropriate measures to ensure that the concentration of refrigerant leakage occur in the room does not exceed the critical level.
- Do not install the air conditioner in a location that may be subject to a risk of expire to a combustible gas. If a combustible gas leaks and becomes concentrated around the unit, a fire may occur.
- To transport the air conditioner, wear shoes with additional protective toe caps.
- To transport the air conditioner, do not take hold of the bands around the packing carton. You may injure yourself if the bands should break.
- Do not place any combustion appliance in a place where it is directly exposed to the wind of air conditioner, otherwise it may cause imperfect combustion.

Installation

- Install the air conditioner securely in a location where the base can sustain the weight adequately. If the strength is not enough, the unit may fall down resulting in injury.
- Follow the instructions in the Installation Manual to install the air conditioner. Failure to follow these instructions may cause the product to fall down or topple over or give rise to noise, vibration, water leakage or other trouble.
- Carry out the specified installation work to guard against the possibility of high winds and earthquake. If the air conditioner is not installed appropriately, a unit may topple over or fall down, causing an accident.
- If refrigerant gas has leaked during the installation work, ventilate the room immediately. If the leaked refrigerant gas comes in contact with fire, noxious gas may generate.

Refrigerant piping

- Install the refrigerant pipe securely during the installation work before operating the air conditioner. If the compressor is operated with the valve open and without refrigerant pipe, the compressor sucks air and the refrigeration cycles is over pressurized, which may cause a injury.
- Tighten the flare nut with a torque wrench in the specified manner. Excessive tighten of the flare nut may cause a crack in the flare nut after a long period, which may result in refrigerant leakage.
- After the installation work, confirm that refrigerant gas does not leak. If refrigerant gas leaks into the room and flows near a fire source, such as a cooking range, noxious gas may be generated.
- When the air conditioner has been installed or relocated, follow the instructions in the Installation Manual and purge the air completely so that no gases other than the refrigerant will be mixed in the refrigerating cycle. Failure to purge the air completely may cause the air conditioner to malfunction.
- Nitrogen gas must be used for the airtight test.
- The charge hose must be connected in such a way that it is not slack.

Electrical wiring

- Only a qualified installer(*1) or qualified service person(*1) is allowed to carry out the electrical work of the air conditioner. Under no circumstances must this work be done by an unqualified individual since failure to carry out the work properly may result in electric shocks and/or electrical leaks.
- To connect the electrical wires, repair the electrical parts or undertake other electrical jobs, wear gloves to provide protection for electricians and from heat, insulating shoes and clothing to provide protection from electric shocks. Failure to wear this protective gear may result in electric shocks.
- Use wiring that meets the specifications in the Installation Manual and the stipulations in the local regulations and laws. Use of wiring which does not meet the specifications may give rise to electric shocks, electrical leakage, smoking and/or a fire.
- Connect earth wire. (grounding work)
Incomplete grounding causes an electric shock.
- Do not connect earth wires to gas pipes, water pipes, and lightning conductor or telephone earth wires.
- After completing the repair or relocation work, check that the earth wires are connected properly.
- Install a circuit breaker that meets the specifications in the installation manual and the stipulations in the local regulations and laws.
- Install the circuit breaker where it can be easily accessed by the agent.
- To install the circuit breaker outdoors, install one which is designed to be used outdoors.
- Under no circumstances the power wire must not be extended. Connection trouble in the places where the wire is extended may give rise to smoking and/or a fire.
- Electrical wiring work shall be conducted according to law and regulation in the community and installation manual. Failure to do so may result in electrocution or short circuit.

Test run

- Before operating the air conditioner after having completed the work, check that the electrical control box cover of the indoor unit and service panel of the outdoor unit are closed, and set the circuit breaker to the ON position. You may receive an electric shock if the power is turned on without first conducting these checks.
- If there is any kind of trouble (such as an error display has appeared, smell of burning, abnormal sounds, the air conditioner fails to cool or heat or water is leaking) has occurred in the air conditioner, do not touch the air conditioner yourself but set the circuit breaker to the OFF position, and contact a qualified service person. Take steps to ensure that the power will not be turned on (by marking "out of service" near the circuit breaker, for instance) until qualified service person(*1) arrives. Continuing to use the air conditioner in the trouble status may cause mechanical problems to escalate or result in electric shocks or other trouble.
- After the work has finished, use an insulation tester set (500 V Megger) to check the resistance is 1 MΩ or more between the charge section and the non-charge metal section (earth section). If the resistance value is low, a disaster such as a leak or electric shock is caused at user's side.
- Upon completion of the installation work, check for refrigerant leaks and check the insulation resistance and water drainage. Then conduct a test run to check that the air conditioner is operating properly.

Explanations given to user

- Upon completion of the installation work, tell the user where the circuit breaker is located. If the user does not know where the circuit breaker is, he or she will not be able to turn it off in the event that trouble has occurred in the air conditioner.
- If the fan grille is damaged, do not approach the outdoor unit but set the circuit breaker to the OFF position, and contact a qualified service person(*1) to have the repairs done. Do not set the circuit breaker to the ON position until the repairs are completed.
- After the installation work, follow the Owner's Manual to explain to the customer how to use and maintain the unit.

Relocation

- Only a qualified installer(**1) or qualified service person(**1) is allowed to relocate the air conditioner. It is dangerous for the air conditioner to be relocated by an unqualified individual since a fire, electric shocks, injury, water leakage, noise and/or vibration may result.
- While carrying out the pump-down work shut down the compressor before disconnecting the refrigerant pipe. Disconnecting the refrigerant pipe with the service valve left open and the compressor still operating will cause air or other gas to be sucked in, raising the pressure inside the refrigeration cycle to an abnormally high level, and possibly resulting in rupture, injury or other trouble.

CAUTION

New refrigerant air conditioner installation

- **This air conditioner adopts the new HFC refrigerant (R410A) which does not destroy ozone layer.**
- The characteristics of R410A refrigerant are; easy to absorb water, oxidizing membrane or oil, and its pressure is approx. 1.6 times higher than that of refrigerant R22. Accompanied with the new refrigerant, refrigerating oil has also been changed. Therefore, during installation work, be sure that water, dust, former refrigerant, or refrigerating oil does not enter the refrigerating cycle.
- To prevent charging an incorrect refrigerant and refrigerating oil, the sizes of connecting sections of charging port of the main unit and installation tools are changed from those for the conventional refrigerant.
- Accordingly the exclusive tools are required for the new refrigerant (R410A).
- For connecting pipes, use new and clean piping designed for R410A, and please care so that water or dust does not enter.

To disconnect the appliance from main power supply.









- This appliance must be connected to the main power supply by means of a switch with a contact separation of at least 3 mm.

The installation fuse (all types can be used) must be used for the power supply line of this conditioner.

Install the indoor unit at least 2.0 m above the floor level since otherwise the users may injure themselves or receive electric shocks if they poke their fingers or other objects into the indoor unit while the air conditioner is running.

(*1) Refer to the "Definition of Qualified Installer or Qualified Service Person."

2 Accessory parts

Part name	Q'ty	Shape	Usage
Installation Manual	1	This manual	(Hand over to customers) (For other languages that do not appear in this Installation Manual, please refer to the enclosed CD-R.)
Owner's Manual	1		(Hand over to customers) (For other languages that do not appear in this Installation Manual, please refer to the enclosed CD-R.)
CD-ROM	1	—	Owner's Manual and Installation Manual.
Installation plate	1		
Wireless remote controller	1		
Battery	2		
Remote controller holder	1		
Mounting screw Ø4 × 25ℓ	6		
Pan head wood screw Ø3.1 × 16ℓ	2		
Screw Ø4 × 10ℓ	2		
Heat insulator	1		

3 Selection of installation place

Avoid installing in the following places

Select a location for the indoor unit where the cool or warm air will circulate evenly.

Avoid installation in the following kinds of locations.

- Saline area (coastal area).
- Locations with acidic or alkaline atmospheres (such as areas with hot springs, factories where chemicals or pharmaceuticals are made and places where the exhaust air from combustion appliances will be sucked into the unit).
Doing so may cause the heat exchanger (its aluminum fins and copper pipes) and other parts to become corroded.
- Locations with atmospheres with mist of cutting oil or other types of machine oil.
Doing so may cause the heat exchanger to become corroded, mists caused by the blockage of the heat exchanger to be generated, the plastic parts to be damaged, the heat insulators to peel off, and other such problems to result.
- Places where iron or other metal dust is present. If iron or other metal dust adheres to or collects on the interior of the air conditioner, it may spontaneously combust and start a fire.
- Locations where vapors from food oils are formed (such as kitchens where food oils are used).
Blocked filters may cause the air conditioner's performance to deteriorate, condensation to form, the plastic parts to be damaged, and other such problems to result.
- Locations near obstructions such as ventilation openings or lighting fixtures where the flow of the blown air will be disrupted (a disruption of the air flow may cause the air conditioner's performance to deteriorate or the unit to shut down).
- Locations where an in-house power generator is used for the power supply.
The power line frequency and voltage may fluctuate, and the air conditioner may not work properly as a result.
- On truck cranes, ships or other moving conveyances.
- The air conditioner must not be used for special applications (such as for storing food, plants, precision instruments or art works).
(The quality of the items stored may be degraded.)
- Locations where high frequencies are generated (by inverter equipment, in-house power generators, medical equipment or communication equipment).
(Malfunctioning or control trouble in the air conditioner or noise may adversely affect the equipment's operation.)
- Locations where there is anything under the unit installed that would be compromised by wetness.
(If the drain has become blocked or when the humidity is over 80 %, condensation from the indoor unit will drip, possibly causing damage to anything underneath.)
- In the case of the wireless type of system, rooms with the inverter type of fluorescent lighting or locations exposed to direct sunlight.
(The signals from the wireless remote controller may not be sensed.)
- Locations where organic solvents are being used.
- The air conditioner cannot be used for liquefied carbonic acid cooling or in chemical plants.
- Location near doors or windows where the air conditioner may come into contact with high-temperature, high-humidity outdoor air.
(Condensation may occur as a result.)
- Locations where special sprays are used frequently.

Installation diagram of Indoor and outdoor units

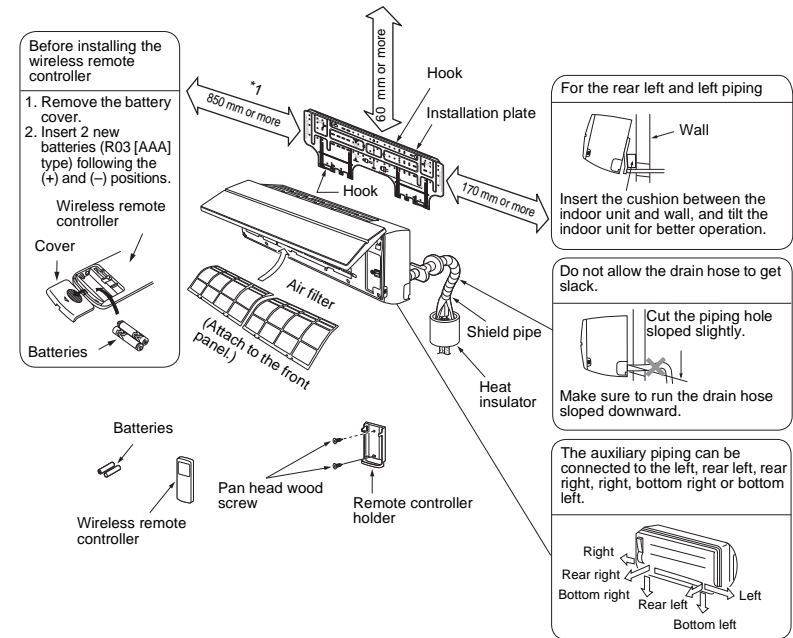

Installation space

The indoor unit shall be installed so that its top surface comes at a height of 2 m or more.

Also it must be avoided to put anything on top of the indoor unit.

*1 Provide a space as shown for service clearance for the cross flow fan.

Installation place

- A place which provides the spaces around the indoor unit as shown in the above diagram.
- A place where there is no obstacle near the air intake and discharge.
- A place that allows easy installation of the piping to the outdoor unit.
- A place which allows the front panel to be opened.

CAUTION

- Direct sunlight to the indoor unit's wireless receiver should be avoided.
- The microprocessor in the indoor unit should not be too close to RF noise sources.
(For details, see the owner's manual.)

■ Wireless remote controller

- A place where there are no obstacles such as a curtain that may block the signal from the indoor unit.
- Do not install the remote controller in a place exposed to direct sunlight or close to a heating source, such as a stove.
- Keep the remote controller at least 1 m apart from the nearest TV set or stereo equipment. (This is necessary to prevent image disturb-bounces or noise interference.)
- The location of the remote controller should be determined as shown below.

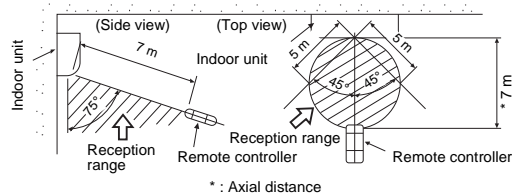

4 Installation

⚠ WARNING

Install the air conditioner certainly to sufficiently withstand the weight. If the strength is insufficient, the unit may fall down resulting in human injury. Perform a specified installation work to guard against strong wind or earthquake. An incomplete installation can cause accidents by the units falling and dropping.

REQUIREMENT

- Strictly comply with the following rules to prevent damage of the indoor units and human injury.
- Do not put a heavy article on the indoor unit. (even units are packaged)
 - Carry in the indoor unit as it is packaged if possible. If carrying in the indoor unit unpacked by necessity, be sure to use buffering cloth, etc. to not damage the unit.
 - To move the indoor unit, do not apply force to the refrigerant pipe, drain pan, foamed parts, or resin parts, etc.
 - Carry the package by two or more persons, and do not bundle it with plastic band at positions other than specified.

Be careful to the following items when installing the unit.

- Considering air discharge direction, select an installation place where discharge air can circulate evenly in a room. Avoid to install the unit at place with "NO GOOD" mark in the right figure.

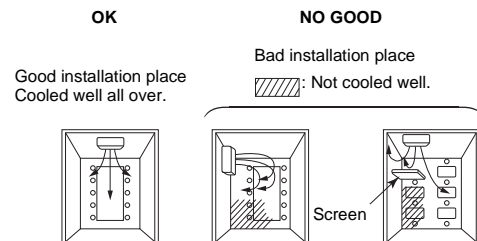

5 Cutting a hole and mounting installation plate

■ Cutting a hole

In case of installing the refrigerant pipes from the rear:

- 1 Decide the hole position for piping at 180 mm from the arrow mark (⇒) on the installation plate and drill a hole at a slight downward slant toward outdoor side.

Pipe hole; dia.65 mm: SM56 type
Pipe hole; dia.80 mm: SM80 type

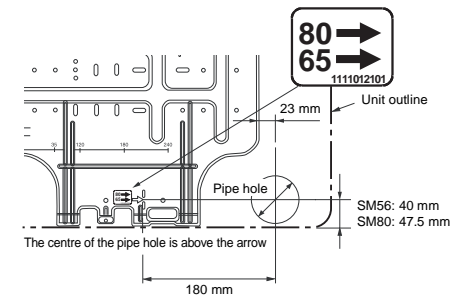

NOTE

When drilling a wall that contains a metal lath, wire lath or metal plate, be sure to use a pipe hole brim ring sold separately.

■ Mounting the installation plate

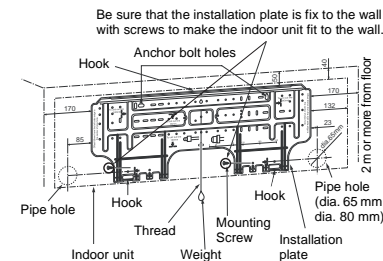

■ When the installation plate is directly mounted on the wall

- 1 Securely fit the installation plate onto the wall by screwing it in the upper and lower parts to hook up the indoor unit.
- 2 To mount the installation plate on a concrete wall with anchor bolts, utilize the anchor bolt holes as illustrated in the above figure.
- 3 Install the installation plate horizontally in the wall.

⚠ CAUTION

When installing the installation plate with a mounting screw, do not use the anchor bolt hole. Otherwise the unit may fall down and result in personal injury and property damage.

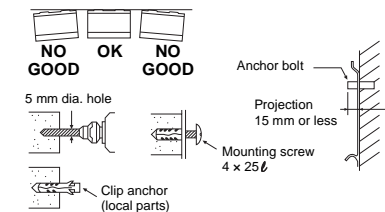

⚠ CAUTION

Failure to firmly install the unit may result in personal injury and property damage if the unit falls.

- In case of block, brick, concrete or similar type walls, make 5 mm dia. holes in the wall.
- Insert clip anchors for appropriate mounting screws.

NOTE

Secure four corners and lower parts of the installation plate with 6 mounting screws to install it.

6 Piping and drain hose installation

■ Piping and drain hose forming

* Apply heat-insulation for both refrigerant pipe and drain hose surely so that no dew generates inside of the equipment. (use polyethylene foam for insulating material.)

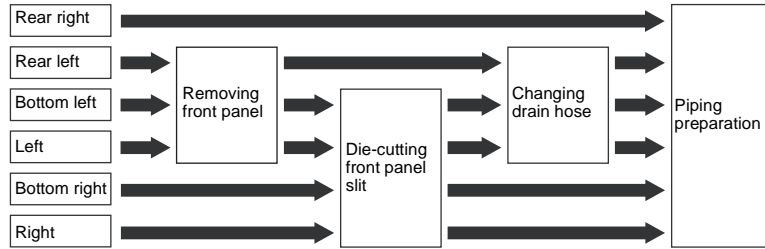

1. Remove the front panel

The front panel must be removed for piping connections in the left, bottom left, and rear left directions.

- Open the air intake grille upward.
- Remove the four screws securing the front panel.
- Slightly open the lower part of the front panel, and then pull the upper part of the front panel toward you to remove it from the rear plate.

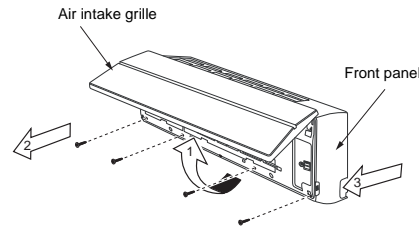

2. Die-cutting front panel slit

Cut out the slit on the leftward or right side of the front panel for the left or right connection and the slit on the bottom left or right side of the front panel for the bottom left or right connection with a pair of nippers.

3. Changing drain hose

For leftward connection, bottom-leftward connection and rear leftward connection's piping, it is necessary to change the drain hose and drain cap.

Without changing the drain hose position, the indoor unit will not fit to the wall.

How to remove the drain hose

- The drain hose can be removed by removing the screw securing the drain hose and then pulling out the drain hose.
- When removing the drain hose, be careful of any sharp edges of steel plate. The edges can injuries.
- To install the drain hose, insert the drain hose firmly until the connection part contacts with heat insulator, and the secure it with original screw.

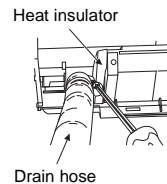

How to remove the drains cap

Clip the drain cap by needle-nose pliers and pull out.

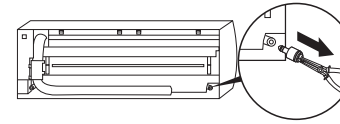

How to fix the drains cap

- 1 Insert hexagonal wrench (dia. 4 mm) in a centre head.

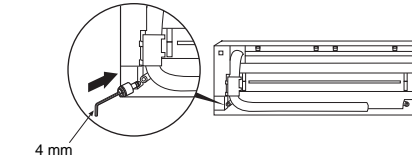

- 2 Firmly insert drains cap.

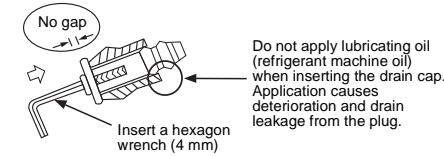

CAUTION

Firmly insert the drain hose and drain cap; otherwise, water may leak.

How to remove the drain hose

- 1 Remove the front panel.
- 2 Remove the screws of drain hose.
- 3 Pull out the drain hose.

How to fix the drain hose

- 1 Place the drain hose in the specified position.
- 2 Screw the drain hose to the indoor unit.
- 3 Install the front panel.

▼ In case of right or left piping

After scribing slits of the front panel with a knife or a marking-off pin, cut them with a pair of nippers or an equivalent tool.

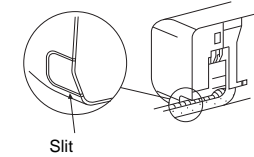

▼ In case of bottom right or bottom left piping

After scribing slits of the front panel with a knife or a marking-off pin, cut them with a pair of nippers or an equivalent tool.

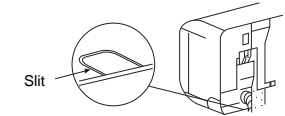

▼ Left-hand connection with piping

Bend the connecting pipe so that it is laid within 43 mm above the wall surface. If the connecting pipe is laid exceeding 43 mm above the wall surface, the indoor unit may unstably be set on the wall. When bending the connecting pipe, make sure to use a spring bender so as not to crush the pipe.

Bend the connection pipe within a radius of 30 mm.
To connect the pipe after installation of the unit (figure)

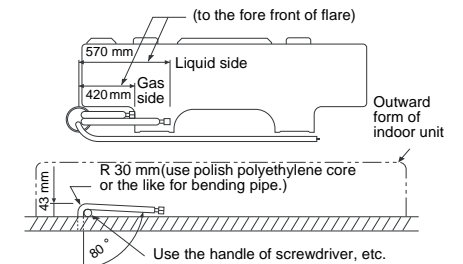

NOTE

If the pipe is bent incorrectly, the indoor unit may unstably be set on the wall. After passing the connecting pipe through the pipe hole, connect the connecting pipe to the auxiliary pipes and wrap the facing tape around them.

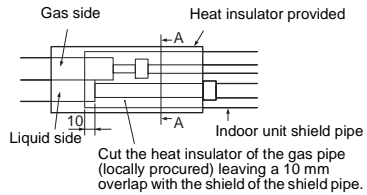

Heat insulator wrapping cross section A-A
Make the slit part of heat insulator to upward.

▼ Insulating the pipes

Insulate the indoor unit completely so there are no gaps using the heat insulator provided.

⚠ CAUTION

Securely apply insulation all the way up to the pipe connecting section of the indoor unit so that there is no exposed area. (the pipe exposed to the outside causes water leak.)

When wrapping the heat insulator around pipes, make sure the slit aperture toward the ceiling surface.

⚠ CAUTION

- Bind the auxiliary pipes (two) and system interconnection wire and control wiring with facing tape tightly. In case of leftward piping and rear leftward piping, bind the auxiliary pipes (two) only with facing tape.

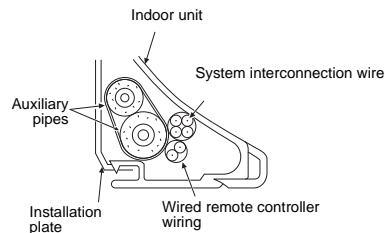

- Carefully arrange pipes so that any pipe does not stick out of the rear plate of the indoor unit.
- Carefully connect the auxiliary pipes and connecting pipes to one another and cut off the insulating tape wound on the connecting pipe to avoid double-taping at the joint, moreover, seal the joint with the vinyl tape, etc.
- Since dew results in a machine trouble, make sure to insulate both the connecting pipes. (Use polyethylene foam as insulating material.)
- When bending a pipe, carefully do it, not to crush it.

7 Indoor unit fixing

- Pass the pipe through the hole in the wall, and hook the indoor unit on the installation plate at the upper hooks.
- Swing the indoor unit to right and left to confirm that it is firmly hooked up on the installation plate.
- While pressing the indoor unit onto the wall, hook it at the lower part on the installation plate. Pull the indoor unit toward you to confirm that it is firmly hooked up on the installation plate.

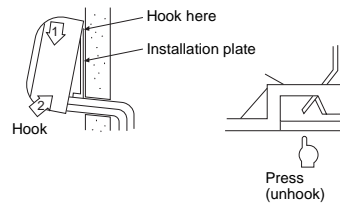

For detaching the indoor unit from the installation plate, pull the indoor unit toward you while pushing its bottom up at the specified parts.

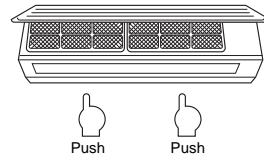

REQUIREMENT

The lower part of indoor unit may float, due to the condition of piping and you cannot fix it to the installation plate. In that case, use the screws provided to fix the unit and the installation plate.

Especially when the pipes are pulled out from the left side, the unit must be screwed to the installation plate.

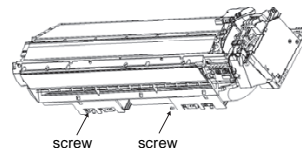

8 Drainage

- Run the drain hose sloped downwards.

NOTE

Hole should be made at a slight downward slant on the outdoor side.

- Put water in the drain pan and make sure that the water is drained out of doors.
- When connecting extension drain hose, insulate the connecting part of extension drain hose with shield pipe.

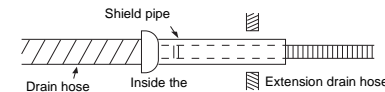
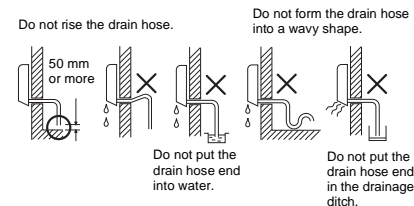

⚠ CAUTION

Arrange the drain pipe for proper drainage from the unit. Improper drainage can result in dew-dropping.

This air conditioner has the structure designed to drain water collected from dew, which forms on the back of the indoor unit, to the drain pan.

Therefore, do not store the power cord and other parts at a height above the drain guide.

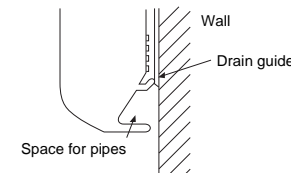

9 Refrigerant piping

⚠ CAUTION

When the refrigerant pipe is long, provide support brackets at intervals of 2.5 m to 3 m to clamp the refrigerant pipe. Otherwise, abnormal sound may be generated.

Use the flare nut attached with the indoor unit or R410A flare nut.

■ Permissible piping length and height difference

They vary depending on the outdoor unit. For details, refer to the Installation Manual attached to the outdoor unit.

■ Pipe size

Model: RAV-	Pipe size (mm)	
	Gas side	Liquid side
SM56	Ø12.7	Ø6.4
SM80	Ø15.9	Ø9.5

■ Connecting refrigerant piping

Flaring

- Cut the pipe with a pipe cutter. Remove burrs completely. (remaining burrs may cause gas leakage.)

- Insert a flare nut into the pipe, and flare the pipe.

Use the flare nut provided with the unit or the one used for the R410A refrigerant. The flaring dimensions for R410A are different from the ones used for the conventional R22 refrigerant. A new flare tool manufactured for use with the R410A refrigerant is recommended, but the conventional tool can still be used if the projection margin of the copper pipe is adjusted to be as shown in the following table.

Projection margin in flaring: B (unit: mm)

Outer dia. of copper pipe	R410A tool used	Conventional tool used
6.4, 9.5	0 to 0.5	1.0 to 1.5
12.7, 15.9		

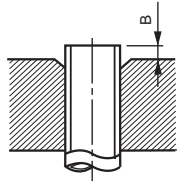

Flaring diameter size: A (unit: mm)

Outer dia. of copper pipe	A
6.4	9.1
9.5	13.2
12.7	16.6
15.9	19.7

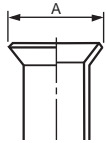

- * In case of flaring for R410A with the conventional flare tool, pull it out approx. 0.5 mm more than that for R22 to adjust to the specified flare size. The copper pipe gauge is useful for adjusting projection margin size.
- The sealed gas was sealed at the atmospheric pressure so when the flare nut is removed, there will no "whooshing" sound: This is normal and is not indicative of trouble.
- Use two wrenches to connect the indoor unit pipe.

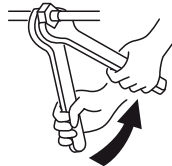

Work using double spanner

- Use the tightening torque levels as listed in the table below.

Outer dia. of connecting pipe (mm)	Tightening torque (N•m)
6.4	14 to 18 (1.4 to 1.8 kgf•m)
9.5	33 to 42 (3.3 to 4.2 kgf•m)
12.7	50 to 62 (5.0 to 6.2 kgf•m)
15.9	63 to 77 (6.3 to 7.7 kgf•m)

- Tightening torque of flare pipe connections. Pressure of R410A is higher than that of R22. (approx. 1.6 times) Therefore, using a torque wrench, tighten the flare pipe connecting sections which connect the indoor and outdoor units of the specified tightening torque. Incorrect connections may cause not only a gas leak, but also a trouble of the refrigeration cycle.

CAUTION

Tightening with an excessive torque may crack the nut depending on installation conditions.

Evacuation

Perform vacuuming from the charge port of valve of the outdoor unit by using a vacuum pump. For details, follow to the Installation Manual attached to the outdoor unit.

- Do not use the refrigerant sealed in the outdoor unit for evacuation.

REQUIREMENT

For the tools such as charge hose, use those manufactured exclusively for R410A.

Refrigerant amount to be added

For addition of the refrigerant, add refrigerant "R410A" referring to the attached Installation Manual of outdoor unit.

Use a scale to charge the refrigerant of specified amount.

REQUIREMENT

- Charging an excessive or too little amount of refrigerant causes a trouble of the compressor. Charge the refrigerant of specified amount.
- A personnel who charged the refrigerant should write down the pipe length and the added refrigerant amount in the F-GAS label of the outdoor unit. It is necessary to fix the compressor and refrigeration cycle malfunction.

Open the valve fully

Open the valve of the outdoor unit fully. A hexagonal wrench is required for opening the valve. For details, refer to the Installation Manual attached to the outdoor unit.

	Hexagonal wrench size
SM56 type	4 mm
SM80 type	6 mm

Gas leak check

Check with a leak detector or soap water whether gas leaks or not, from the pipe connecting section or cap of the valve.

REQUIREMENT

Use a leak detector manufactured exclusively for HFC refrigerant (R410A, R134a).

Heat insulation process

- For the heat insulation to the pipes at gas side, be sure to use the material with heat-resisting temperature 120 °C or higher.
- To use the attached heat insulation pipe, apply the heat insulation to the pipe connecting section of the indoor unit securely without gap.

REQUIREMENT

Apply the heat insulation to the pipe connecting section of the indoor unit securely up to the root without exposure of the pipe. (the pipe exposed to the outside causes water leak.)

Wireless remote controller A-B selection

Using 2 wireless remote controllers for the respective air conditioners, when the 2 air conditioners are closely installed.

Wireless remote controller B setup

- 1 Push **TEMPORARY** button on the indoor unit to turn the air conditioner ON.
- 2 Point the wireless remote controller at the indoor unit.
- 3 Push and hold **CHK** button on the wireless remote controller by the tip of the pencil. "00" will be shown on the display.
- 4 Push **CHK** during pushing **CHK**. "B" will be shown on the display and "00" will be disappear and the air conditioner will turn OFF. The wireless remote controller B is memorized.

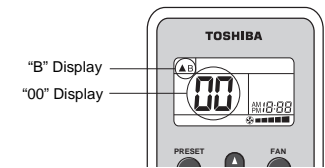

NOTE

- Repeat above step to reset wireless remote controller to be A.
- The wireless remote controllers do not display "A".
- The factory default of the wireless remote controllers is "A".

10 Electrical connection

⚠ WARNING

- Use the specified wires for wiring connect the terminals. Securely fix them to prevent external forces applied to the terminals from affecting the terminals.
Incomplete connection or fixation may cause a fire or other trouble.
- Connect earth wire. (grounding work)
Incomplete grounding cause an electric shock.
Do not connect earth wires to gas pipes, water pipes, lightning conductor or telephone earth wires.
- Appliance shall be installed in accordance with national wiring regulations.
Capacity shortage of power circuit or incomplete installation may cause an electric shock or a fire.

⚠ CAUTION

- For power supply specifications, follow the Installation Manual of outdoor unit.
 - Do not connect 220 – 240 V power to the terminal blocks (A, B) for control wiring.
Otherwise, the system will fail.
 - Do not damage or scratch the conductive core and inner insulator of power and system interconnection wires while peeling them.
 - Perform the electric wiring so that it does not come to contact with the high-temperature part of the pipe.
The coating may melt resulting in an accident.
- Do not turn on the power of the indoor unit until vacuuming of the refrigerant pipes completes.

■ System interconnection wires specifications

System interconnection wires*	4 x 1.5 mm ² or more (H07 RN-F or 60245 IEC 66)	Up to 70 m
-------------------------------	---	------------

*Number of wire x wire size

Remote controller wiring

Remote controller wiring, remote controller inter-unit wiring	Wire size: 2 x 0.5 to 2.0 mm ²	
Total wire length of remote controller wiring and remote controller inter-unit wiring = L + L1 + L2 + ... Ln	In case of wired type only	Up to 500 m
	2 remote controllers	Up to 300 m
Total wire length of remote controller inter-unit wiring = L1 + L2 + ... Ln	2 remote controllers including a wireless remote controller	Up to 400 m
		Up to 200 m

⚠ CAUTION

The remote controller wire and system interconnection wires cannot be parallel to contact each other and cannot be stored in the same conduits. If doing so, a trouble may be caused on the control system due to noise or other factor.

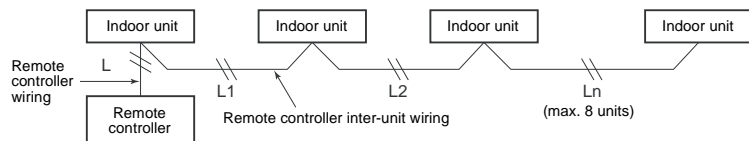

■ Wiring between indoor unit and outdoor unit

- 1 Figure below shows the wiring connections between the indoor and outdoor units and between the indoor units and remote controller. The wires indicated by the broken lines or dot-and-dash lines are provided at the locally.
- 2 Refer to the both indoor and outdoor unit wiring diagrams.
- 3 The power of the indoor unit is supplied from the outdoor unit.

Wiring diagram

▼ Single system

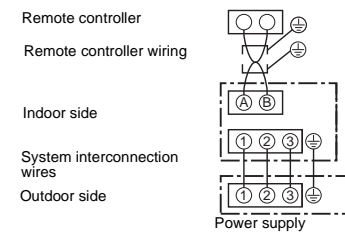

▼ Simultaneous twin system

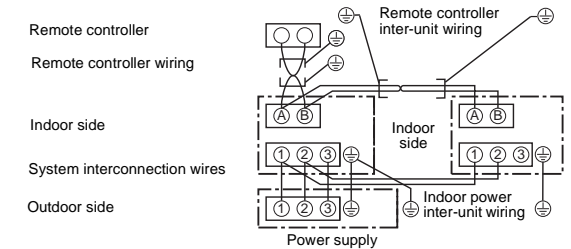

▼ Simultaneous triple and double twin system

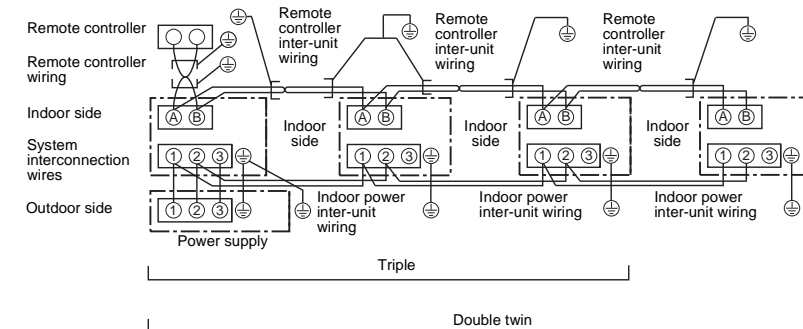

* Use 2-core shield wire (MVVS 0.5 to 2.0 mm² or more) for the remote controller wiring in the simultaneous twin, simultaneous triple and simultaneous double twin systems to prevent noise problems. Be sure to connect both ends of the shield wire to earth leads.

* Connect earth wires for each indoor unit in the simultaneous twin, simultaneous triple and simultaneous double twin systems.

■ Wiring connection (single system)

REQUIREMENT

- Be sure to connect the wires matching the terminal numbers. Incorrect connection causes a trouble.
- Keep a margin (approx. 100 mm) on a wire to hang down the electrical control box at servicing, etc.
- The low-voltage circuit is provided for the wired remote controller. (Do not connect the high-voltage circuit)

▼ When using the supplied wireless remote controller

The system interconnection wire can be connected without removing the front panel.

- 1 Remove the air intake grille.**
Open the air intake grille upward and pull it toward you.
- 2 Remove the terminal cover.**
- 3 Insert the system interconnection wire (according to the local rule) into the pipe hole on the wall.**
- 4 Take the system interconnection wire out of the cable slot on the rear panel so that it protrudes about 150 mm from the front.**
- 5 Insert the system interconnection wire fully into the terminal block and secure it tightly with screws.**
Tightening torque: 1.2 N·m (0.12 kgf·m)
Secure the earth wire with the earth screw.
- 6 Clamp the system interconnection wire with the cord clamp.**
- 7 Attach the terminal cover and the air intake grille to the indoor unit.**

⚠ CAUTION

- Be sure to refer to the wiring diagram attached inside the front panel.
- Check local electrical cords and also any specific wiring instructions and limitations.

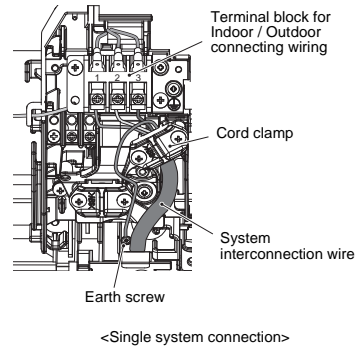
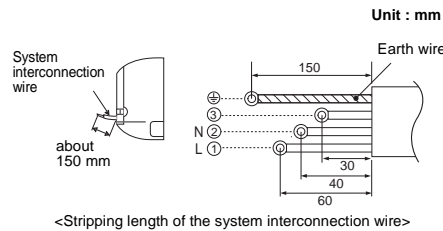
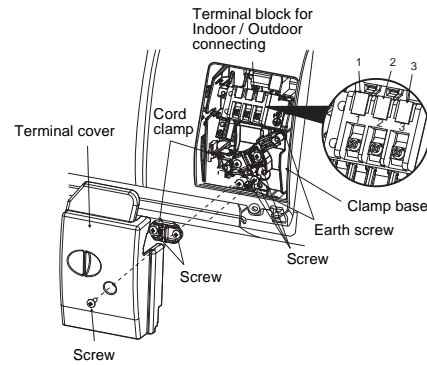

<Single system connection>

■ Wiring connection (twin, triple, double twin system)

- 1 Connect a header unit by following the procedure of wiring connection for single system.**

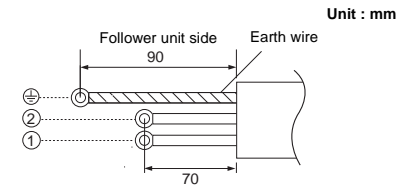

<Stripping length of the system interconnection wire>

- 2 Connect system interconnection wire 1 and 2 of follower unit to terminal 1 and 2 on terminal block respectively.**
System interconnection wire 3 is not used.
- 3 Connect the earth wire to the earth screw located on the underside of the electrical control box.**
- 4 Clamp the system interconnection wire with the cord clamp.**
- 5 Attach the terminal cover and the air intake grille to the indoor unit.**

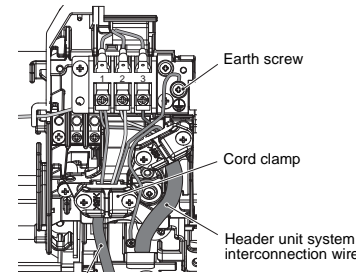

Follower unit system interconnection wire

<Twin, triple, double twin system connection>

▼ When using optional wired remote controller
The system interconnection wire and the wired remote controller wire can be connected without removing the front panel.

- 1 Remove the air intake grille.**
Open the air intake grille upward and pull it toward you.
- 2 Remove the terminal cover and the clamp base.**
- 3 Insert the system interconnection wire and wired remote controller wire (according to the local rule) into the pipe hole on the wall.**
- 4 Take the system interconnection wire and wired remote controller wire out of the cable slot on the rear panel so that it protrudes about 150 mm from the front.**
- 5 Insert the wired remote controller wire fully into the wired remote controller / central control terminal block, (A), (B), and secure it tightly with screws.**
 - Strip off approx. 9 mm the wire to be connected.
 - Non polarity, 2 core wire is used for wiring of the wired remote controller. (0.5 mm² to 2.0 mm² wires)
- 6 Clamp the wired remote controller wire with the cord clamp.**
- 7 Install the clamp base with a screw.**
- 8 Insert the system interconnection wire fully into the terminal block and secure it tightly with screws.**
Tightening torque: 1.2 N·m (0.12 kgf·m)
Secure the earth wire with the earth screw.
- 9 Clamp the system interconnection wire with the cord clamp.**
- 10 Attach the terminal cover and the air intake grille to the indoor unit.**

⚠ CAUTION

- Be sure to refer to the wiring diagram attached inside the front panel.
- Check local electrical cords and also any specific wiring instructions and limitations.
- Do not catch the wired remote controller wire when installing the clamp base.

11 Applicable controls

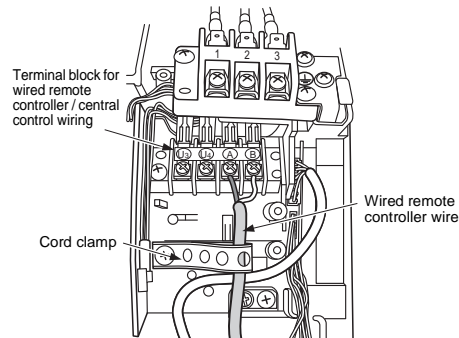
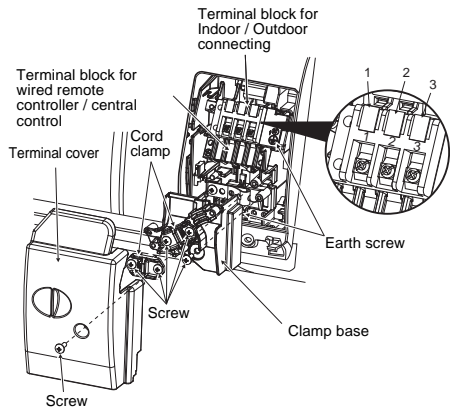

◆ Wiring diagram

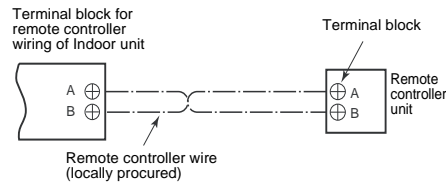

REQUIREMENT

- When this air conditioner is used for the first time, it takes approx. 5 minutes until the remote controller becomes available after power-on. This is normal. **<When power is turned on for the first time after installation>** It takes **approx. 5 to 10 minutes** until the remote controller becomes available.

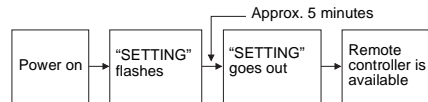

- <When power is turned on for the second (or later) time>**
It takes **approx. 1 minute** until the remote controller becomes available.

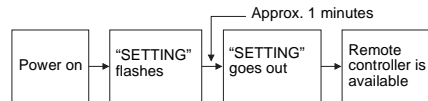

- Normal settings were made as factory default. Change the indoor unit settings as required.
- Use the wired remote controller to change the settings.
- * The settings cannot be changed using the wireless remote controller, simple wired remote controller, or remote-controller-less system (for central remote controller only). Therefore, install the wired remote controller to change the settings.

Basic procedure for changing settings

Change the settings while the air conditioner is not working.
(Stop the air conditioner before making settings.)

CAUTION

Set only the CODE No. shown in the following table: Do NOT set any other CODE No.
If a CODE No. not listed is set, it may not be possible to operate the air conditioner or other trouble with the product may result.

- * The displays appearing during the setting process differ from the ones for previous remote controllers (AMT31E). (there are more CODE No.)

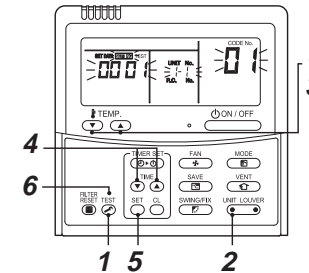

1 Push **TEST** button and **TEMP.** button simultaneously for 4 seconds or more.

After a while, the display flashes as shown in the figure.

Confirm that the CODE No. is [01].

- If the CODE No. is not [01], push **TEST** button to erase the display content, and repeat the procedure from the beginning. (No operation of the remote controller is accepted for a while after **TEST** button is pushed.)

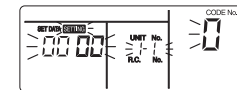

(* Display content varies with the indoor unit model.)

2 Each time **UNIT LOCKER** button is pushed, indoor unit numbers in the control group change cyclically. Select the indoor unit to change settings for.

The fan of the selected unit runs. The indoor unit can be confirmed for which to change settings.

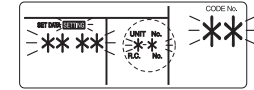

3 Specify CODE No. [**] with **TEMP.** button.

4 Select SET DATA [****] with **TIME** button.

5 Push **SET** button. When the display changes from flashing to lit, the setup is completed.

- To change settings of another indoor unit, repeat from Procedure 2.
- To change other settings of the selected indoor unit, repeat from Procedure 3. Use **SET** button to clear the settings. To make settings after **SET** button was pushed, repeat from Procedure 2.

6 When settings have been completed, push **TEST** button to determine the settings.

When **TEST** button is pushed, "SETTING" flashes and then the display content disappears and the air conditioner enters the normal stop mode. (While "SETTING" is flashing, no operation of the remote controller is accepted.)

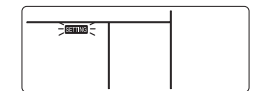

Filter sign setting

According to the installation condition, the filter sign term (notification of filter cleaning) can be changed.

Follow to the basic operation procedure (1 → 2 → 3 → 4 → 5 → 6).

- For the CODE No. in Procedure 3, specify [01].
- For the [SET DATA] in Procedure 4, select the SET DATA of filter sign term from the following table.

SET DATA	Filter sign term
0000	None
0001	150 H (factory default)
0002	2500 H
0003	5000 H
0004	10000 H

To secure better effect of heating

When it is difficult to obtain satisfactory heating due to installation place of the indoor unit or structure of the room, the detection temperature of heating can be raised. Also use a circulator or other device to circulate heat air near the ceiling.

Follow to the basic operation procedure (1 → 2 → 3 → 4 → 5 → 6).

- For the CODE No. in Procedure 3, specify [06].
- For the set data in Procedure 4, select the SET DATA of shift value of detection temperature to be set up from the table below.

SET DATA	Detection temperature shift value
0000	No shift
0001	+1 °C
0002	+2 °C (factory default)
0003	+3 °C
0004	+4 °C
0005	+5 °C
0006	+6 °C

Power saving mode

Performing settings of the power saving mode

* When an outdoor unit RAV-SP***2AT / RAV-SM***3AT or earlier is used, the power level is fixed to 75 % regardless of the value on the display.

1 Push **SAVE** button for 4 seconds or more when the air conditioner is not working.

SETTING flashes.
Indicates CODE No. "C2."

2 Select an indoor unit to be set by pushing **UNIT LOUVER** (left side of the button).
Each time the button is pushed, unit numbers change as follows:

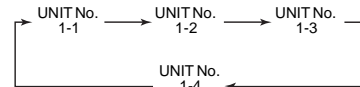

The fan of the selected unit runs.

3 Adjust the power save setting by pushing **TIME** / **▲** buttons.
Each push of the button changes the power level by 1 % within the range from 100 % to 50 %.

* The factory default is 75 %.

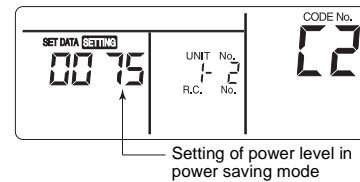

4 Determine the setting by pushing **SET** button.

5 Push **TEST** button to complete the setting.

Remote controller switch monitoring function

This function is available to call the service monitor mode from the remote controller during a test run to acquire temperatures of sensors of the remote controller, indoor unit, and outdoor unit.

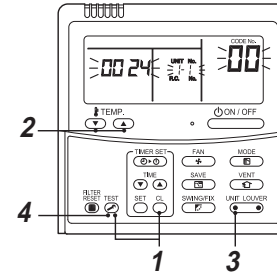

1 Push **CL** and **TEST** buttons simultaneously for at least 4 seconds to call the service monitor mode.

The service monitor indicator lights up and the header indoor unit number is displayed first. CODE No. 00 is also displayed.

2 Pushing **TEMP.** / **▲** buttons, select the number of sensor (CODE No.) to be monitored. (See the following table.)

3 Pushing **UNIT LOUVER** (left side of the button), select an indoor unit to be monitored. The sensor temperatures of indoor units and their outdoor unit in the control group are displayed.

4 Push **TEST** button to return to the normal display.

Indoor unit data	
CODE No.	Data name
01	Room temperature (remote controller)
02	Indoor unit intake air temperature (TA)
03	Indoor unit heat exchanger (coil) temperature (TCJ)
04	Indoor unit heat exchanger (coil) temperature (TC)
F3	Indoor unit fan cumulative operating hours (x1 h)

Outdoor unit data	
CODE No.	Data name
60	Outdoor unit heat exchanger (coil) temperature (TE)
61	Outside air temperature (TO)
62	Compressor discharge temperature (TD)
63	Compressor suction temperature (TS)
64	—
65	Heatsink temperature (THS)
6A	Operating current (x1/10)
F1	Compressor cumulative operating hours (x100 h)

■ Group control

Simultaneous twin, triple or double twin system

A combination with an outdoor unit allows simultaneous ON / OFF operation of the indoor units. The following system patterns are available.

- Two indoor units for the twin system
- Three indoor units for the triple system
- Four indoor units for the double-twin system

▼ Twin system

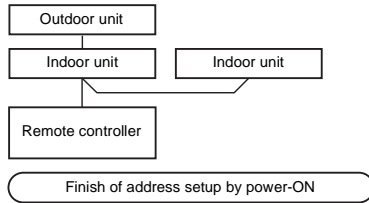

▼ Triple system

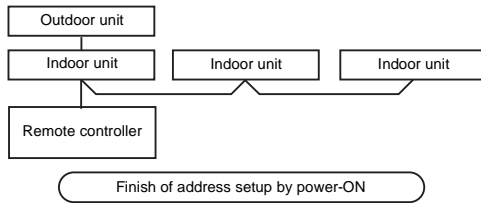

▼ Double twin

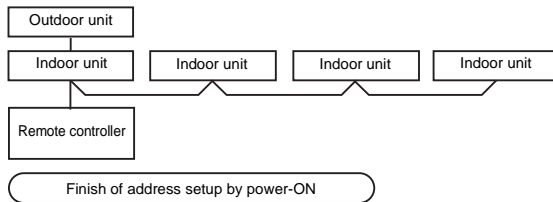

- For wiring procedure and wiring method, follow to the “Electrical connection” in this manual.
- When the power supply has been turned on, the automatic address setup starts and which indicates that address is being set up flashes on the display part.
During setup of automatic address, the remote controller operation is not accepted.

Required time up to the finish of automatic addressing is approx. 5 minutes.

Group control for system of multiple units

One remote controller can control maximum 8 indoor units as a group.

▼ Group control in single system

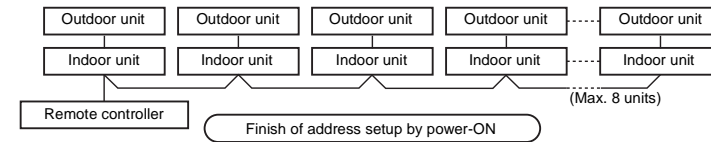

- For wiring procedure and wiring method of the individual line (identical refrigerant line) system, follow to “Electrical connection”.
- Wiring between lines is performed in the following procedure.
Connect the terminal block (A / B) of the indoor unit connected with a remote controller to the terminal blocks (A / B) of the indoor units of other indoor units by wiring the inter-unit wire of the remote controller.
- When the power supply has been turned on, the automatic address setup starts and which indicates that address is being set up flashes on the display part in about 3 minutes. During setup of automatic address, the remote controller operation is not accepted.

Required time up to the finish of automatic addressing is approx. 5 minutes.

NOTE

In some cases, it is necessary to change the address manually after setup of the automatic address according to the system configuration of the group control.

- The follow mentioned system configuration is a case when complex systems in which systems of the simultaneous twin and simultaneous triple unit is controlled as a group by a remote controller.

(Example) Group control for complex system

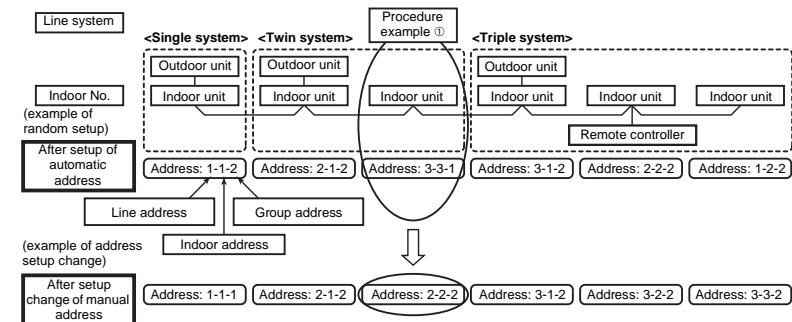

The above address is set by the automatic addressing when the power is turned on. However, line addresses and indoor addresses are set randomly. For this reason, change the setting to match line addresses with indoor addresses.

[Procedure example]

Manual address setup procedure

While the operation stops, change the setup.
(Stop the operation of the unit.)

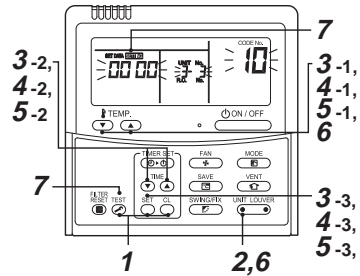

- 1) Push **SET** + **CL** + **TEST** buttons simultaneously for 4 seconds or more. After a while, the display part flashes as shown below. Check the displayed CODE No. is [10].
 - When the CODE No. is other than [10], push **TEST** button to erase the display and repeat procedure from the first step.
(After pushing **TEST** button, operation of the remote controller is not accepted for approx. 1 minute.)
(For a group control, No. of the firstly displayed indoor unit becomes the header unit.)

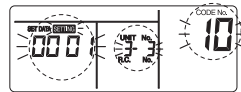

(* Display changes according to the model No. of indoor unit.)

- 2) Every time **UNIT LOUVER** button is pushed, the indoor UNIT No. in the group control is displayed in order. Select the indoor unit of which setup is changed.
In this time, the position of the indoor unit of which setup is changed can be confirmed because fan of the selected indoor unit operate.
- 3)
 - 1) Specify CODE No. [12] with **TEMP.** ∇ / \blacktriangle buttons.
(CODE No. [12]: Line address)
 - 2) Change the line address from [3] to [2] with **TIME** ∇ / \blacktriangle buttons.

- 3) Push **SET** button.
In this time, the setup finishes when the display changes from flashing to lighting.

Indoor unit No. before setup change is displayed.

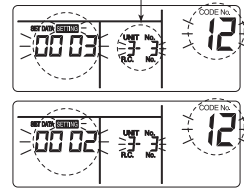

- 4)
 - 1) Specify CODE No. [13] with **TEMP.** ∇ / \blacktriangle buttons.
(CODE No. [13]: Indoor address)
 - 2) Change the indoor address from [3] to [2] **TIME** ∇ / \blacktriangle buttons.
 - 3) Push **SET** button.
In this time, the setup finishes when the display changes from flashing to lighting.

Indoor unit No. before setup change is displayed.

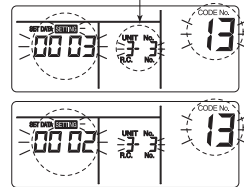

- 5)
 - 1) Specify CODE No. [14] **TEMP.** ∇ / \blacktriangle buttons.
(CODE No. [14]: Group address)
 - 2) Change the SET DATA from [0001] to [0002] **TIME** ∇ / \blacktriangle buttons.
(SET DATA [Header unit: 0001] [Follower unit: 0002])
 - 3) Push **SET** button.
In this time, the setup finishes when the display changes from flashing to lighting.

Indoor UNIT No. before setup change is displayed.

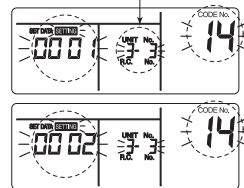

- 6) If there is other indoor unit to be changed, repeat procedure 2 to 5 to change the setup.
When the above setup has finished, push **UNIT LOUVER** button to select the indoor UNIT No. before change of setup, specify CODE No. [12], [13], [14] in order with **TEMP.** ∇ / \blacktriangle buttons, and then check the changed contents.

Address change check Before change:
[3-3-1] → After change: [2-2-2]

Pushing **CL** button clears the contents of which setup was changed.
(In this case, procedure from 2 is repeated.)

Indoor UNIT No. before setup change is displayed.

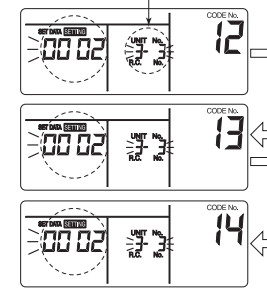

- 7) After check of the changed contents, push **TEST** button. (setup is determined.) When **TEST** button is pushed, the display disappears and the status becomes the usual stop status. (when **TEST** button is pushed the operation from the remote controller is not accepted for approx. 1 minute.)

* If the operation from the remote controller is not accepted even 1 minute or more passed after pushing **TEST** button, it is considered that the address setup is incorrect.
In this case, the automatic address must be again set up.
Therefore repeat procedure of the setup change from the Procedure 1.

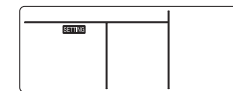

To recognize the position of the corresponding indoor unit through the indoor UNIT No. is known

Check the position during operation stop.
(Stop operation of the set.)

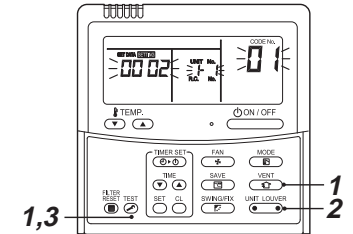

- 1) Push **TEST** + **VENT** buttons simultaneously for 4 seconds or more.
After a while, the display part flashes and the display appears as shown below.
In this time, the position can be checked because fan of the indoor unit operate.
 - For the group control, the indoor UNIT No. is displayed as [ALL] and fans of all the indoor units in the group control operate.
Check the displayed CODE No. is [01].
 - When the CODE No. is other than [01], push **TEST** button to erase the display and repeat procedure from the first step.
(After pushing **TEST** button, operation of the remote controller is not accepted for approx. 1 minute.)

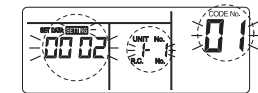

(* Display changes according to the model No. of indoor unit.)

- 2) In the group control, every time **UNIT LOUVER** button is pushed, the indoor UNIT No. in the group control is displayed in order.
In this time, the position of the indoor unit can be confirmed because only fan of the selected indoor unit operate.
(For a group control, No. of the firstly displayed indoor unit becomes the header unit.)
- 3) After confirmation, push **TEST** button to return the mode to the usual mode.
When **TEST** button is pushed, the display disappears and the status becomes the usual stop status.
(When **TEST** button is pushed the operation from the remote controller is not accepted for approx. 1 minute.)

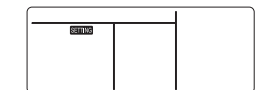

■ 8 °C operation (SDI series4 and DI series4 only)

Pre-heating operation can be set for cold regions where room temperature drops to below zero.

- 1 Push **SET** + **CL** + **TEST** buttons simultaneously for 4 seconds or more when the air conditioner is not working.

After a while, the display part flashes as shown below. Check the Displayed CODE No. is [10].

When the CODE No. is other than [10], push **TEST** button to erase the display and repeat procedure from the first step.

(After pushing **TEST** button, operation of the remote controller is not accepted for approx. 1 minute.)

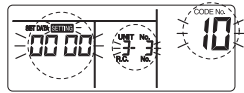

(* Display changes according to the model No. of indoor unit.)

- 2 Every time **UNIT LOUVER** button is pushed, the indoor unit No. in the group control is displayed in order. Select the indoor unit of which setup is changed. In this time, the position of the indoor unit of which setup is changed can be confirmed because fan of the selected indoor unit operate.

- 3 Specify CODE No. [d1] TEMP. **▼** / **▲** buttons.

- 4 Select SET DATA [0001] TIME **▼** / **▲** buttons.

SET DATA	8 °C Operation setting
0000	None (factory default)
0001	8 °C Operation setting

- 5 Push **SET** button.

In this time, the setup finishes when the display changes from flashing to lighting.

- 6 Push **TEST** button. (setup is determined.)

When **TEST** button is pushed, the display disappears and the status becomes the usual stop status. (when **TEST** button is pushed the operation from the remote controller is not accepted for approx. 1 minute.)

■ Central control system

Air conditioners at multiple locations can be controlled individually for each refrigeration system from a control room.

Central control is not available with the supplied wireless remote controller. Use the optional wired remote controller.

▼ Wiring for central control

The terminal block for central control wiring (Ⓛ and Ⓜ) is the same as that for optional wired remote controller. Connect the central control wire to the terminals (Ⓛ) and (Ⓜ) on the terminal block in the same way as the optional wired remote controller. For details, refer to the installation manual of the applicable central control system.

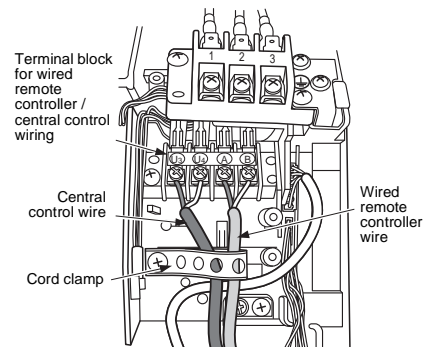

▼ Centrally control the system by the SDI, DI series on their own setting for the terminating resistor is required.

- Use switch SW01 for the setting.
- Make the terminating resistor setting only for the indoor unit with the smallest line address number.

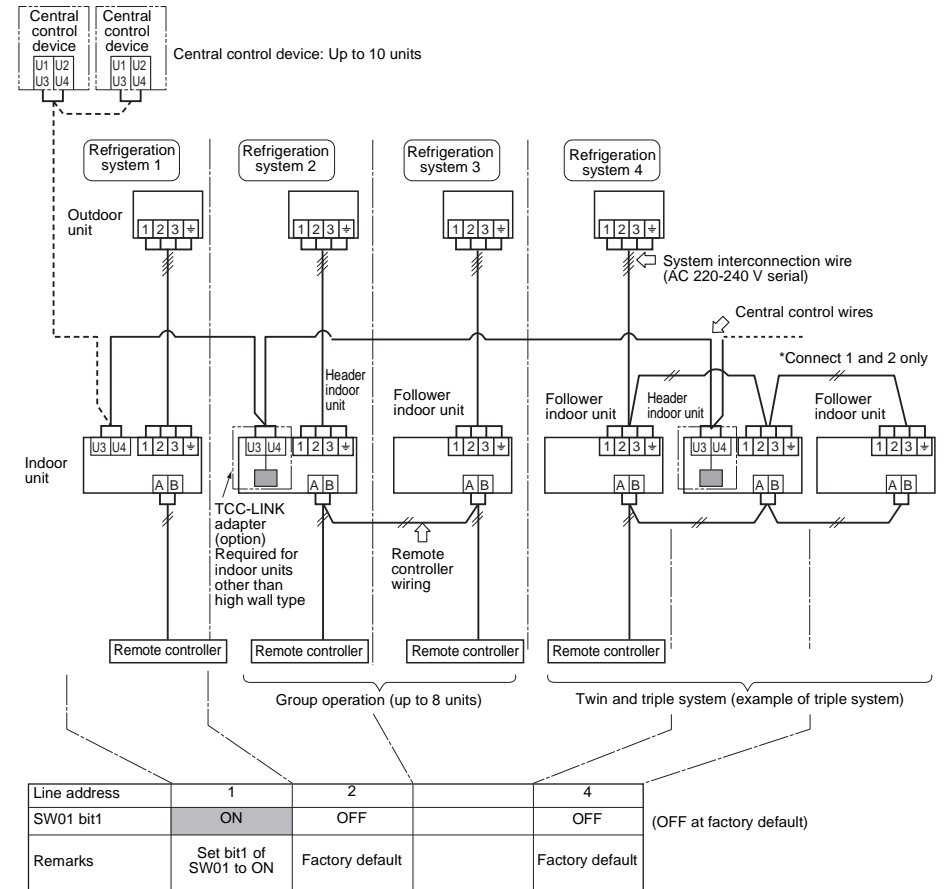

How to set the SW01

1 Remove the front panel.

- Before removing the front panel, direct the horizontal louvers to the direction shown in the figure below.
- Remove the screws securing the front panel, and detach it from the indoor unit.

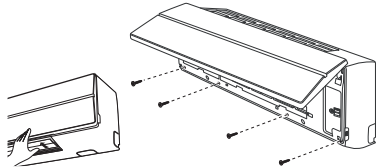

2 Remove the drain guide and disconnect TCJ sensor.

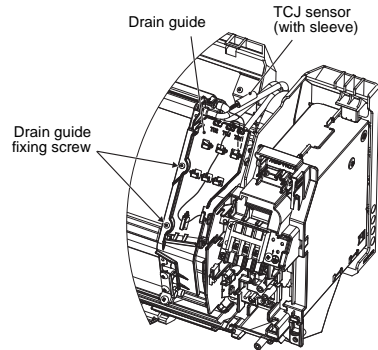

3 Remove the earth wire, TC sensor, and motor lead (louver motor, fan motor).

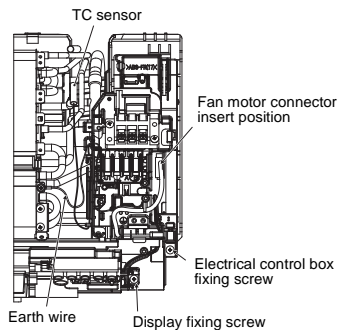

4 Remove the screws and detach the electrical control box.

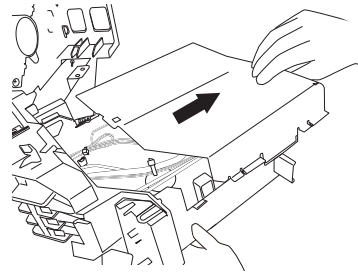

5 Remove the electrical control box cover and set bit1 of SW01 on the board to ON.
(Do not touch SW02 as it is used for other setting.)

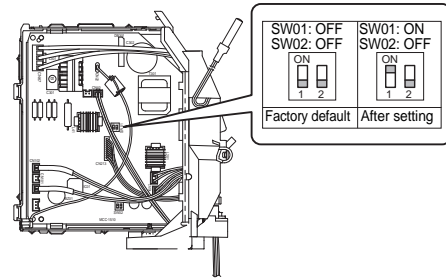

6 Assemble the removed parts by reversing steps 1 to 4.
Insert the sensors and motor lead (louver motor, fan motor) into the original positions.

CAUTION

Connect the sensor and the motor lead certainly back to the previous position. If they are not properly connected, the system will not operate or other errors may occur.

▼ Centrally control the system by connecting to the TCC-LINK central control system.

Setting central control addresses

When air conditioners of the SDI, DI series are connected to the TCC-LINK central control system for central control using this product, set the addresses of indoor units using the following procedure.

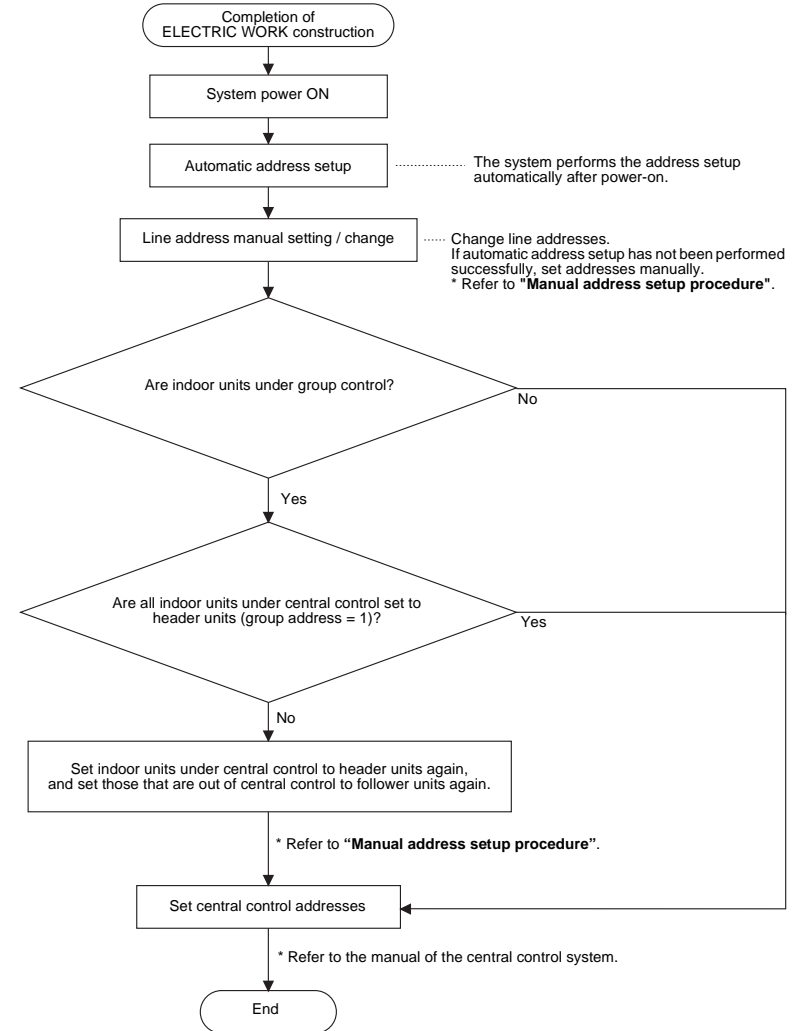

1 Indoor unit line address manual setting / change

[For 29 or less refrigeration systems (when they are used together with the SMMS series, the number of refrigeration systems of the SMMS series is included.)]

Since all line addresses are set to “1” except for group control by the automatic address setup function after system power-on, change the line addresses for each refrigeration system using the wired remote controller.

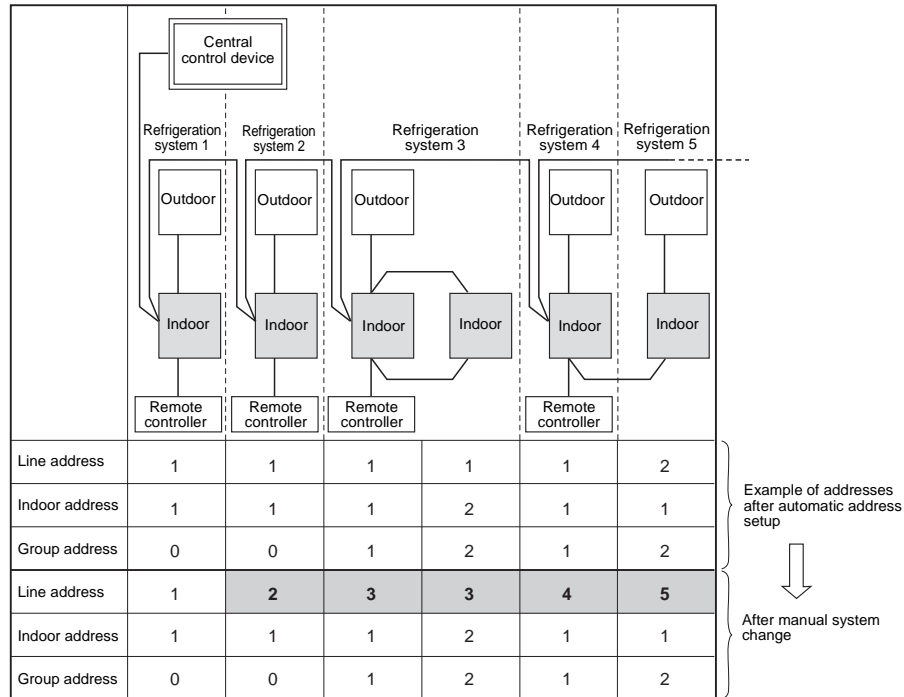

NOTE

- For changing / setting line addresses using the wired remote controller, refer to “**Manual address setup procedure**”.
- Line addresses must be unique for each refrigeration system. Set a line address that is different from any of line addresses of other refrigeration systems.
(If indoor units of the SDI, DI series are operated under central control together with those of the SMMS series, set line addresses different from those of the SMMS series.)

2 Indoor unit line address manual setting / change

[For 30 or more refrigeration systems (when they are used together with the SMMS series, the number of refrigeration systems of the SMMS series is included.)]

The line address change / setting procedure for up to the 29th refrigeration system is the same as that described in step 1 on the previous page.

Since all line addresses are set to “1” except for group control by the automatic address setup function after system power-on, change the line addresses for each refrigeration system using the wired remote controller. Also change the indoor addresses so that they are not duplicated.

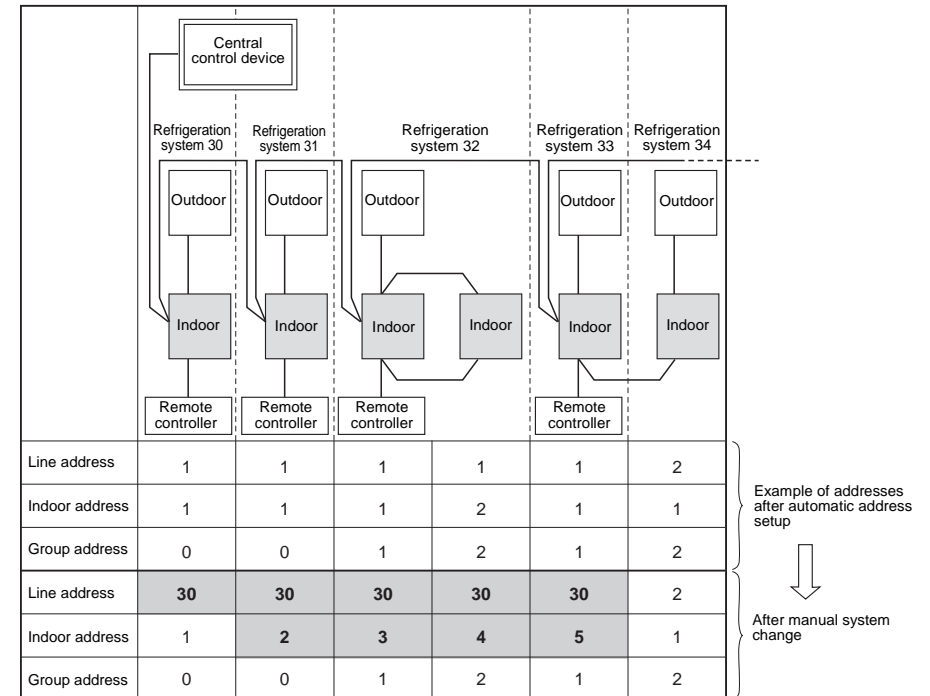

NOTE

- For changing / setting line addresses using the wired remote controller, refer to “**Manual address setup procedure**”.
- Line addresses must be unique for each refrigeration system. Set a line address that is different from any of line addresses of other refrigeration systems.
(If indoor units of the SDI, DI series are operated under central control together with those of the SMMS series, set line addresses different from those of the SMMS series.)

12 Test run

■ Before test run

- Before turning on the power supply, carry out the following procedure.
 - 1) By using 500 V-megger, check that resistance of 1 MΩ or more exists between the terminal block 1 to 3 and the earth (grounding). If resistance of less than 1 MΩ is detected, do not run the unit.
 - 2) Check the valve of the outdoor unit being opened fully.
- To protect the compressor at activation time, leave power-ON for 12 hours or more before operating.

■ Execute a test run

Operate the unit with the wired remote controller as usual.
 For the procedure of the operation, refer to the attached Owner's Manual.
 A forced test run can be executed in the following procedure even if the operation stops by thermostat-OFF.
 In order to prevent a serial operation, the forced test run is released after 60 minutes have passed and returns to the usual operation.

⚠ CAUTION

Do not use the forced test run for cases other than the test run because it applies an excessive load to the devices.

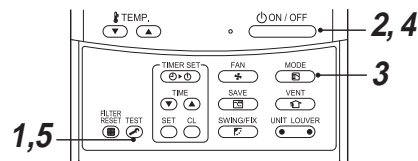

- 1 Push **TEST** button for 4 seconds or more. [TEST] is displayed on the display part and the selection of mode in the test mode is permitted.

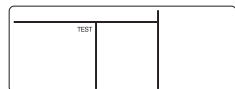

- 2 Push **ON/OFF** button.

- 3 Select the operation mode with button, [**Cool**] or [**Heat**].

- Do not run the air conditioner in a mode other than [**Cool**] or [**Heat**].
- The temperature controlling function does not work during test run.
- The detection of error is performed as usual.

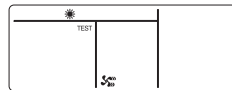

- 4 After the test run, push **ON/OFF** button to stop a test run. (Display part is same as procedure 1.)

- 5 Push **TEST** check button to cancel (release from) the test run mode. ([TEST] disappears on the display and the status returns to a normal.)

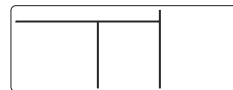

■ When a test run is not performed properly

When a test run is not performed properly, refer to the error code and the part to be checked on "Troubleshooting".

In case of wireless remote controller (Forced test operation is performed in a different way.)

REQUIREMENT

- For the operation procedure, be sure to follow the Owner's Manual.
- Finish the forced cooling operation in a short time because it applies excessive strength to the air conditioner.
- A test operation of forced heating is unavailable. Perform a test operation by heating operation using the switches of the remote controller. However heating operation may be not carried out according to the temperature conditions.

Check wiring / piping of indoor and outdoor units

- 1 When **ON/OFF** button is pushed for 10 seconds or more, "Pi!" sound is heard and the operation changes to a forced cooling operation. After approx. 3 minutes, a cooling operation starts forcedly. Check cool air starts blowing. If the operation does not start, check wiring again.
- 2 To stop a test operation, push **ON/OFF** button once again (approx. 1 second). The louver closes and the operation stops.

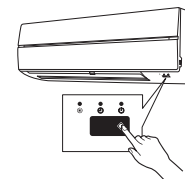



- Check transmission of remote controller
- 3 Push **ON/OFF** button of the remote controller to check an operation can also start by the remote controller.
 - "Cooling" operation by the remote controller may be unavailable according to the temperature conditions. Check wiring / piping of the indoor and outdoor units in forced cooling operation.

13 Maintenance

◆ Daily maintenance

Cleaning of air filter

If  is displayed on the remote controller, maintain the air filter.

- 1 Push the  button to stop the operation, then turn off the circuit breaker. After the cooling or dry operation, the ventilation fan keeps running for self-cleaning. Push the  button twice to stop the operation.

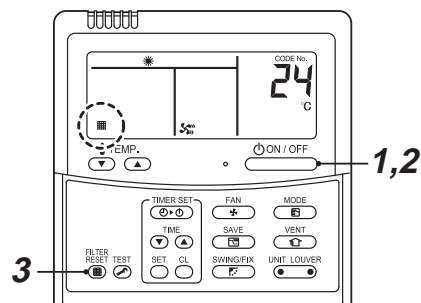

Take out the air filter

- 1 Open the air intake grille until it stops, and slightly raise the hook on the lower centre of the air filter.

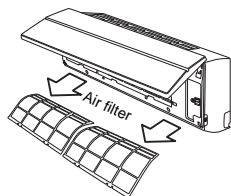

The air intake grille should not be opened further; otherwise, the arms may come off and the air intake grille may fall down.



Cleaning with water or vacuum cleaner

- If dirt is heavy, clean the air filter by tepid water with neutral detergent or water.
- After cleaning with water, dry the air filter sufficiently in a shade place.

Mount the air filter

- 2 Turn on the circuit breaker, then push the  button on the remote controller to start the operation.
- 3 After cleaning, push .  display disappears.

⚠ CAUTION

- Do not start the air conditioner while leaving air filter removed.
- Push the filter reset button. ( indication will be turn off.)

◆ Periodic maintenance

For environmental conservation, it is strongly recommended that the indoor and outdoor units of the air conditioner in use be cleaned and maintained regularly to ensure efficient operation of the air conditioner.

When the air conditioner is operated for a long time, periodic maintenance (once a year) is recommended. Furthermore, regularly check the outdoor unit for rust and scratches, and remove them or apply rustproof treatment, if necessary.

As a general rule, when an indoor unit is operated for 8 hours or more daily, clean the indoor unit and outdoor unit at least once every 3 months. Ask a professional for this cleaning / maintenance work.

Such maintenance can extend the life of the product though it involves the owner's expense.

Failure to clean the indoor and outdoor units regularly will result in poor performance, freezing, water leakage, and even compressor failure.

Inspection before maintenance

Following inspection must be carried out by a qualified installer or qualified service person.

Part	Inspection method
Heat exchanger	Access from inspection opening and remove the access panel. Examine the heat exchanger if there is any clogging or damages.
Fan motor	Access from inspection opening and check if any abnormal noise can be heard.
Fan	Access from inspection opening and remove the access panel. Examine the fan if there are any waggles, damages or adhesive dust.
Filter	Go to installed location and check if there are any stains or breaks on the filter.
Drain pan	Access from inspection opening and remove the access panel. Check if there is any clogging or drain water is polluted.

▼ Maintenance list

Part	Unit	Check (visual / auditory)	Maintenance
Heat exchanger	Indoor / outdoor	Dust / dirt clogging, scratches	Wash the heat exchanger when it is clogged.
Fan motor	Indoor / outdoor	Sound	Take appropriate measures when abnormal sound is generated.
Filter	Indoor	Dust / dirt, breakage	<ul style="list-style-type: none"> • Wash the filter with water when it is contaminated. • Replace it when it is damaged.
Fan	Indoor	<ul style="list-style-type: none"> • Vibration, balance • Dust / dirt, appearance 	<ul style="list-style-type: none"> • Replace the fan when vibration or balance is terrible. • Brush or wash the fan when it is contaminated.
Air intake / discharge grilles	Indoor / outdoor	Dust / dirt, scratches	Fix or replace them when they are deformed or damaged.
Drain pan	Indoor	Dust / dirt clogging, drain contamination	Clean the drain pan and check the downward slope for smooth drainage.
Ornamental panel, louvres	Indoor	Dust / dirt, scratches	Wash them when they are contaminated or apply repair coating.
Exterior	Outdoor	<ul style="list-style-type: none"> • Rust, peeling of insulator • Peeling / lift of coat 	Apply repair coating.

14 Troubleshooting

Confirmation and check

When an error occurred in the air conditioner, an error code and indoor UNIT No. appear on the display part of the remote controller.

The error code is only displayed during the operation. If the display disappears, operate the air conditioner according to the following "Confirmation of error log" for confirmation.

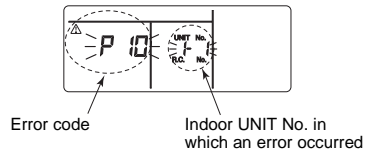

Confirmation of error log

When an error occurred on the air conditioner, the error log can be confirmed with the following procedure. (The error log is stored in memory up to 4 errors.) The log can be confirmed from both operating status and stop status.

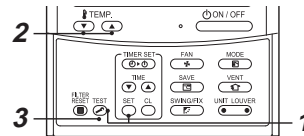

- When **SET** and **TEST** buttons are pushed simultaneously for 4 seconds or more, the following display appears. If **✓** is displayed, the mode enters in the error log mode.
 - [01: Order of error log] is displayed in CODE No..
 - [Error code] is displayed in CHECK.
 - [Indoor unit address in which an error occurred] is displayed in Unit No..

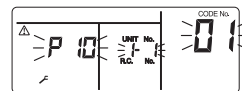

- Every pushing of **TEMP.** button used to set temperature, the error log stored in memory is displayed in order. The numbers in CODE No. indicate CODE No. [01] (latest) → [04] (oldest).

REQUIREMENT

Do not push **TEST** button because all the error log of the indoor unit will be deleted.

- After confirmation, push **TEST** button to return to the usual display.

Error codes and parts to be checked

Wired remote controller display	Wireless remote controller Sensor block display of receiving unit	Main defective parts	Judging device	Parts to be checked / error description	Air conditioner status
Indication	Operation Timer Ready GR GR OR				
E01	⊙ ● ●	No header remote controller Remote controller communication error	Remote controller	Incorrect remote controller setting --- The header remote controller has not been set (including two remote controllers). No signal can be received from the indoor unit.	*
E02	⊙ ● ●	Remote controller transmission error	Remote controller	System interconnection wires, indoor P.C. board, remote controller. --- No signal can be sent to the indoor unit.	*
E03	⊙ ● ●	Indoor unit-remote controller regular communication error	Indoor	Remote controller, network adapter, indoor P.C. board --- No data is received from the remote controller or network adapter.	Auto-reset
E04	● ● ⊙	Indoor unit-outdoor unit serial communication error IPDU-CDB communication error	Indoor	System interconnection wires, indoor P.C. board, outdoor P.C. board --- Serial communication error between indoor unit and outdoor unit	Auto-reset
E08	⊙ ● ●	Duplicated indoor addresses ★	Indoor	Indoor address setting error --- The same address as the self-address was detected.	Auto-reset
E09	⊙ ● ●	Duplicated header remote controllers	Remote controller	Remote controller address setting error - -- Two remote controllers are set as header in the double-remote controller control. (* The header indoor unit stops raising alarm and follower indoor units continue to operate.)	*
E10	⊙ ● ●	CPU-CPU communication error	Indoor	Indoor P.C. board --- Communication error between main MCU and motor microcomputer MCU.	Auto-reset
E18	⊙ ● ●	Header unit follower unit regular communication error	Indoor	Indoor P.C. board --- Regular communication is not possible between header and follower indoor units or between twin header (main) and follower (sub) units.	Auto-reset
E31	● ● ⊙	IPDU communication error	Outdoor	Communication error between IPDU and CDB.	Entire stop
F01	⊙ ⊙ ●	ALT Indoor unit heat exchanger sensor (TCJ) error	Indoor	Heat exchanger sensor (TCJ), indoor P.C. board --- Open-circuit or short-circuit of the heat exchanger sensor (TCJ) was detected.	Auto-reset
F02	⊙ ⊙ ●	ALT Indoor unit heat exchanger sensor (TC) error	Indoor	Heat exchanger sensor (TC), indoor P.C. board --- Open-circuit or short-circuit of the heat exchanger sensor (TC) was detected.	Auto-reset
F04	⊙ ⊙ ○	ALT Outdoor unit discharge temp. sensor (TD) error	Outdoor	Outdoor temp. sensor (TD), outdoor P.C. board --- Open-circuit or short-circuit of the discharge temp. sensor was detected.	Entire stop
F06	⊙ ⊙ ○	ALT Outdoor unit temp. sensor (TE / TS) error	Outdoor	Outdoor temp. sensors (TE / TS), outdoor P.C. board --- Open-circuit or short-circuit of the heat exchanger temp. sensor was detected.	Entire stop
F07	⊙ ⊙ ○	ALT TL sensor error	Outdoor	TL sensor may be displaced, disconnected or short-circuited.	Entire stop
F08	⊙ ⊙ ○	ALT Outdoor unit outside air temp. sensor error	Outdoor	Outdoor temp. sensor (TO), outdoor P.C. board --- Open-circuit or short-circuit of the outdoor air temp. sensor was detected.	Operation continued

Wired remote controller display	Wireless remote controller Sensor block display of receiving unit		Main defective parts	Judging device	Parts to be checked / error description	Air conditioner status
	Indication	Operation Timer Ready GR GR OR				
F10	○ ○ ●	ALT	Indoor unit room temp. sensor (TA) error	Indoor	Room temp. sensor (TA), indoor P.C. board --- Open-circuit or short-circuit of the room temp. sensor (TA) was detected.	Auto-reset
F12	○ ○ ○	ALT	TS sensor error	Outdoor	TS sensor may be displaced, disconnected or short-circuited.	Entire stop
F13	○ ○ ○	ALT	Heat sink sensor error	Outdoor	Abnormal temperature was detected by the temp. sensor of the IGBT heat sink.	Entire stop
F15	○ ○ ○	ALT	Temp. sensor connection error	Outdoor	Temp. sensor (TE / TS) may be connected incorrectly.	Entire stop
F29	○ ○ ●	SIM	Indoor unit, other P.C. board error	Indoor	Indoor P.C. board --- EEPROM error.	Auto-reset
F31	○ ○ ○	SIM	Outdoor unit P.C. board	Outdoor	Outdoor P.C. board ---- In the case of EEPROM error.	Entire stop
H01	● ○ ●		Outdoor unit compressor breakdown	Outdoor	Current detect circuit, power voltage --- Minimum frequency was reached in the current releasing control or short-circuit current (Idc) after direct excitation was detected.	Entire stop
H02	● ○ ●		Outdoor unit compressor lock	Outdoor	Compressor circuit --- Compressor lock was detected.	Entire stop
H03	● ○ ●		Outdoor unit current detect circuit error	Outdoor	Current detect circuit, outdoor unit P.C. board --- Abnormal current was detected in AC-CT or a phase loss was detected.	Entire stop
H04	● ○ ●		Case thermostat operation	Outdoor	Malfunction of the case thermostat	Entire stop
H06	● ○ ●		Outdoor unit low-pressure system error	Outdoor	Current, high-pressure switch circuit, outdoor P.C. board --- Pressure sensor error was detected or low-pressure protective operation was activated.	Entire stop
L03	○ ● ○	SIM	Duplicated header indoor units ★	Indoor	Indoor address setting error --- There are two or more header units in the group.	Entire stop
L07	○ ● ○	SIM	Group line in individual indoor unit ★	Indoor	Indoor address setting error --- There is at least one group-connected indoor unit among individual indoor units.	Entire stop
L08	○ ● ○	SIM	Indoor group address not set ★	Indoor	Indoor address setting error --- Indoor address group has not been set.	Entire stop
L09	○ ● ○	SIM	Indoor unit capacity not set	Indoor	Indoor unit capacity has not been set.	Entire stop
L10	○ ○ ○	SIM	Outdoor unit P.C. board	Outdoor	In the case of outdoor P.C. board jumper wire (for service) setting error.	Entire stop
L20	○ ○ ○	SIM	LAN communication error	Network adapter central control	Address setting, central control remote controller, network adapter - Duplication of address in central control communication.	Auto-reset
L29	○ ○ ○	SIM	Other outdoor unit error	Outdoor	Other outdoor unit error.	Entire stop
					1) Communication error between IPDU MCU and CDB MCU. 2) Abnormal temperature was detected by the heat sink temp. sensor in IGBT.	Entire stop
L30	○ ○ ○	SIM	Abnormal external input into indoor unit (interlock)	Indoor	External devices, outdoor unit P.C. board --- Abnormal stop due to incorrect external input into CN80.	Entire stop
L31	○ ○ ○	SIM	Phase sequence error, etc.	Outdoor	Power supply phase sequence, outdoor unit P.C. board --- Abnormal phase sequence of the 3-phase power supply.	Operation continued (thermostat OFF)
P01	● ○ ○	ALT	Indoor unit fan error	Indoor	Indoor fan motor, indoor P.C. board --- Indoor AC fan error (fan motor thermal relay activated) was detected.	Entire stop

Wired remote controller display	Wireless remote controller Sensor block display of receiving unit		Main defective parts	Judging device	Parts to be checked / error description	Air conditioner status
	Indication	Operation Timer Ready GR GR OR				
P03	○ ● ○	ALT	Outdoor unit discharge temp. error	Outdoor	An error was detected in the discharge temp. releasing control.	Entire stop
P04	○ ● ○	ALT	Outdoor unit high-pressure system error	Outdoor	High-pressure switch --- The IOL was activated or an error was detected in the high-pressure releasing control using the TE.	Entire stop
P05	○ ● ○	ALT	Open phase detected	Outdoor	The power wire may be connected incorrectly. Check open phase and voltages of the power supply.	Entire stop
P07	○ ● ○	ALT	Heat sink overheat	Outdoor	Abnormal temperature was detected by the temp. sensor of the IGBT heat sink.	Entire stop
P10	● ○ ○	ALT	Indoor unit water overflow detected	Indoor	Drain pipe, clogging of drainage, float switch circuit, indoor P.C. board --- Drainage is out of order or the float switch was activated.	Entire stop
P12	● ○ ○	ALT	Abnormal operation of the fan of the indoor unit	Indoor	Abnormal operation of the indoor fan motor, indoor P.C. board, or indoor DC fan (over current or lock, etc.) is detected.	Entire stop
P15	○ ● ○	ALT	Gas leakage detected	Outdoor	There may be gas leakage from the pipe or connecting part. Check for gas leakage.	Entire stop
P19	○ ● ○	ALT	4-way valve error	Outdoor (Indoor)	4-way valve, indoor temp. sensors (TC / TCJ) --- An error was detected due to temperature drop of the indoor unit heat exchanger sensor during heating.	Auto-reset
P20	○ ● ○	ALT	High-pressure protective operation	Outdoor	High-pressure protection.	Entire stop
P22	○ ● ○	ALT	Outdoor unit fan error	Outdoor	Outdoor unit fan motor, outdoor unit P.C. board --- An error (overcurrent, locking, etc.) was detected in the outdoor unit fan drive circuit.	Entire stop
P26	○ ● ○	ALT	Outdoor unit inverter Idc activated	Outdoor	IGBT, outdoor unit P.C. board, inverter wiring, compressor --- Short-circuit protection for compressor drive circuit devices (G-Tr / IGBT) was activated.	Entire stop
P29	○ ● ○	ALT	Outdoor unit position error	Outdoor	Outdoor unit P.C. board, high-pressure switch --- Compressor motor position error was detected.	Entire stop
P31	○ ● ○	ALT	Other indoor unit error	Indoor	Another indoor unit in the group is raising an alarm.	Entire stop
					E03 / L07 / L03 / L08 alarm check locations and error description.	Auto-reset

○ : Lighting ○ : Flashing ● : OFF ★ : The air conditioner automatically enters the auto-address setting mode.
 ALT: When two LEDs are flashing, they flash alternately. SIM: When two LEDs are flashing, they flash in synchronization.
 Receiving unit display OR: Orange GR: Green

TOSHIBA CARRIER CORPORATION

1111055801