



Cassette Type Series

1 Way cassette : AM***FN1DEH*
AM***HN1DEH*
AM***JN1DEH*
2 Way cassette : AM***FN2DEH*
4 Way cassette : AM***FN4DEH*
AM***KN4FEH*

Air Conditioner user manual

imagine the possibilities

Thank you for purchasing this Samsung product.

SAMSUNG

features of your new air conditioner

- **Cool Summer Offer**

On those hot sweltering summer days and long restless nights, there is no better escape from the heat than the cool comforts of home. Your new air conditioner brings an end to exhausting hot summer days and lets you rest. This summer, beat the heat with your own air conditioner.

- **Cost Efficient System**

Your new air conditioner not only provides maximum cooling power in the summer, but can also be an efficient heating method in the winter with the advanced “Heat pump” system. This technology is up to 300 % more efficient than electrical heating, so you can further reduce its running cost. Now, meet year-round needs with one air conditioner.

- **A Look for Everywhere**

The elegant and harmonious design gives priority to the esthetics of your space and complements any of your existing interior décor. With its soft color and rounded-edge shape, the new air conditioner adds class to any room. Enjoy what your air conditioner offers both functionally and esthetically.

- **Compact and easy-to-use Cassette type**

Designed to be installed into most types of suspended ceiling, the cassette type air conditioner is ideal for business and commercial accommodations. Fresh cool/warm air can be provided through the controllable 1, 2 or 4 sides of the unit. All functions of the air conditioner will be controlled easily via a remote control.

safety information



To prevent electric shock, disconnect the power before servicing, cleaning, and installing the unit.

SAFETY INFORMATION









Before using your new air conditioner, please read this manual thoroughly to ensure that you know how to safely and efficiently operate the extensive features and functions of your new appliance.

Because the following operating instructions cover various models, the characteristics of your air conditioner may differ slightly from those described in this manual. If you have questions, call your nearest contact center or find help and information online at www.samsung.com.

What the icons and signs in this user manual mean:

| | |
|---|--|
|  WARNING | Risk of death or serious personal injury. |
|  CAUTION | Potential risk of personal injury or material damage. |
|  CAUTION | To reduce the risk of fire, explosion, electric shock, or personal injury when using your air conditioner, follow these basic safety instructions: |

safety information

| | |
|---|--|
|  | Do NOT attempt. |
|  | Do NOT disassemble. |
|  | Do NOT touch. |
|  | Follow directions carefully. |
|  | Unplug the power plug from the wall socket. |
|  | Make sure the machine is grounded to prevent electric shock. |
|  | Call the contact center for help. |
|  | Recommended instructions or useful information for use. |

These warning signs are here to prevent injury to you and others.

Please follow them carefully.

After reading this section, keep it in a safe place for future reference.



SEVERE WARNING SIGNS

 Do not place the air conditioner near hazardous substances or equipment that releases free flames to avoid fire, explosions or injuries.

- Potential risk of fire hazard or explosion.

Do not block or place items in front of the air conditioner. Do not step, hang onto, or place heavy items on the air conditioner.

- Potential risk of personal injury.

Do not install the outdoor unit at an unstable place or elevated surface where there is potential risk of falling.

- If the outdoor unit falls, it may cause personal injury or loss of property.

Any changes or modifications performed not following by the installation manual, failure or damage may occur on the condition. In this case, user will be responsible for all the repair expenses.

If any gas or impurities other than R-410A refrigerant come into the refrigerant pipe, serious problem may occur and it may cause injury.

Do not spray flammable gases such as insecticide near the air conditioner.

- Potential risk of electric shock, fire or unit malfunction.

Do not insert anything such as fingers or branches into the air conditioner vents.

- Keep children away from the air conditioner. Potential risk of personal injury.

Do not cut the power plug and connect to a different power cable.

Never attempt to lengthen the power cable.

- Potential risk of fire or electric shock.

Do not yank the power cable and touch the power plug with hands.

- Potential risk of fire or electric shock.

safety information



SEVERE WARNING SIGNS

 **Never use a damaged power plug, power cable, or loosened power receptacle.**

- Potential risk of fire or electric shock.

The electric work must be done by qualified service technician in accordance with the national wiring regulations with rated cables.

- If the capacity of the power cable is insufficient or electric work have not done properly, electric shock or fire may occur.

You should connect the power cable into the power cable terminal and fasten it with a clamp.

 **Do not connect the air conditioner with heating apparatus or attempt to disassemble, remodel or repair it by yourself.**

- Potential risk of malfunction, electric shock or fire. If repairs are needed, consult the contact center.

Consult the place of purchase or a contact center to disassemble or reinstall the air conditioner.

- Potential risk of unit malfunction, water leakage, electric shock, or fire.

★ Consult the place of purchase or contact center to install the air conditioner.

- Improper installation carries a risk of unit malfunction, water leakage, electric shock or fire.
- If installing in specialty areas, such as a factory complex or saline coastal area, consult the place of purchase or contact center for specific installation details.

Install the air conditioner with the support bracket securely fastened to use for an extended period of time.

- If the air conditioner falls, it may cause personal injury or loss of property.

If the indoor unit gets wet, turn the power off immediately and call your nearest contact center.

- Potential risk of fire or electric shock.

Install an exclusive circuit breaker and short-circuit breaker for the air conditioner.

- Potential risk of electric shock or fire.

If the power cable is damaged, the manufacturer or a qualified service technician must replace it.

Always make sure that the power supply is compliant with current safety standards. Always install the air conditioner in compliance with current local safety standards.

Verify that the voltage and frequency of the power supply comply with the specifications and that the installed power is sufficient to ensure the operation of any other domestic appliance connected to the same electric lines.



SEVERE WARNING SIGNS

- ★ **The air conditioner must be installed in accordance with national wiring regulations and safety regulations wherever applicable.**

Install the supplied cables firmly. Fix them securely so that external force is not exerted to the terminal block.

- If the connection is loose, heat may generate and cause electric shock or fire.

Use a rated circuit breaker only.

- Never use steel wires or copper wires as a circuit breaker. It may cause fire or unit malfunction.

Use an exclusive power source for the air conditioner.

- Potential risk of electric shock or fire.

Do not put undue stress or place heavy object on the power cable.

Do not bend the power cable excessively.

- Potential risk of fire or electric shock.

Always verify that electric connections (cable entry, section of leads, protections...) are compliant with the electric specifications and with the instructions provided in the wiring scheme.

Always verify that all connections comply with the standards applicable to the installation of air conditioners.



Use a receptacle that has a ground terminal. The receptacle must be used exclusively for the air conditioner.

- Improper electrical grounding may cause electric shock or fire.

Be sure to ground the unit. Do not connect the ground wire to gas or water pipes, lighting rods, or telephone grounding lines.

- If the unit is not properly grounded, electric shock may result.

Always verify that a suitable grounding connection is available.



Disconnect the air conditioner from power supply before it is repaired or disassembled.



CAUTION SIGNS



Connect the refrigerant tubes first then the electrical lines, when installing the unit.

Always disassemble the electric lines before the refrigerant tubes.

Verify that the air conditioner is connected to the power supply in accordance with the instructions provided in the wiring diagram included in the manual.

The manufacturer shall not be responsible for damage originating from unauthorized changes or the improper connection of electric and hydraulic lines.

safety information



CAUTION SIGNS

 **Failure to comply with these instructions or to comply with the requirements set forth in the “Operating limits” table, included in the manual, and shall immediately invalidate the warranty.**

Ensure no water gets into the air conditioner.

- Potential risk or electric shock.

Turn off the air conditioner using the provided remote control or control accessory (if provided). Do not unplug to turn off the unit (unless there is an immediate danger).

Do not open the front grille during operation.

- Potential risk of electric shock or unit malfunction.

Cool air should not flow directly towards people, pets, and plants.

- It is harmful to your health, pets, and plants.

Do not run the air conditioner for an extended period of time in a room with the door closed or with babies, elderly or disabled people.

- Open the door or windows to ventilate your room at least once an hour to prevent oxygen shortage.

Do not drink drain water coming out of the air conditioner.

- Potential risk of health hazard.

Do not expose the dust filter to direct sunlight while drying.

- Strong direct sunlight may deform the dust filter.

Do not allow children to climb on the air conditioner.

Use only rated accessories and install the air conditioner with rated equipments.

- If you do not use the rated accessories, the air conditioner may drop from its place, water may leak or electric shock or fire may occur.

Do not use the air conditioner as a cooling precision instrument for food, pets, plants, cosmetics or machinery.

Do not give excessive shock to the air conditioner.

- Potential risk of fire or unit malfunction.

Do not spray water directly on the air conditioner or use benzene, thinner or alcohol to clean the surface of the unit.

- Potential risk of electric shock or fire.
- Potential risk of damage to the air conditioner.

Do not place any objects, especially containers with liquid.



Do not touch the pipe connected to the air conditioner.



This appliance should be installed according to the provided installation manual.

Install the shortest possible length of pipe.

- If the length of pipe gets unnecessarily long, the life of air conditioner can be shorten and become inefficient.

safety information



CAUTION SIGNS

- ★ **Install the power cable and communication cable of the indoor and outdoor unit at least 1m away from the electric appliance.**

Install the indoor unit away from lighting apparatus using the ballast.

- If you use the wireless remote control, reception error may occur due to the ballast of the lighting apparatus.

For maximum safety, installers should always carefully read the following warnings.

Do not install the air conditioner in following places.

- Place where there is mineral oil or arsenic acid.
- Resin parts flame and the accessories may drop or water may leak. The capacity of the heat exchanger may reduce or the air conditioner may be out of order.
- The place where corrosive gas such as sulfurous acid gas generates from the vent pipe or air outlet.
- The copper pipe or connection pipe may corrode and refrigerant may leak.
- The place where there is a machine that generates electromagnetic waves.
The air conditioner may not operate normally due to control system.
- The place where there is a danger of existing combustible gas, carbon fiber or flammable dust.

- The place where thinner or gasoline is handled
Gas may leak and it may cause fire.

If the air conditioner is installed in a small room, measures must be taken to prevent the refrigerant concentration in the room from exceeding the safety limit in the event of refrigerant leakage.

Consult a dealer regarding the appropriate measures to prevent the allowable concentration from being exceeded.

- If the refrigerant leaks, and cause the concentration limit to be exceeded, hazards due to lack of oxygen in the room may result.

Install the air conditioner away from direct exposure to sunlight, heating apparatus, and humid places.

- Hang curtains on windows to boost cooling efficiency and to avoid the risk of electric shock.

The air conditioner is composed of moving parts. Keep children away from the unit to avoid physical injury.

Check for damage on delivery. If damaged, do not install the air conditioner and call the place of purchase immediately.

Insert the dust filter before operating the air conditioner.

- If there is no dust filter inside the air conditioner, accumulated dust may shorten the life of the air conditioner and cause electricity waste.

safety information



CAUTION SIGNS

- ★ Keep indoor temperatures stable and not extremely cold, especially where there are children, elderly or disabled people.

Clean the dust filter every 2 weeks. Clean the filter more frequently if the air conditioner is operated in dusty areas.

The packaging material and used batteries of the remote controller (optional) must be disposed of in accordance with the national standards.

The refrigerant used in the air conditioner must be treated as chemical waste. Dispose the refrigerant following national standards.

Have a qualified service technician install the air conditioner and perform a trial operation.

Firmly connect the drain hose to the air conditioner for proper water drainage.

Install the outdoor unit where operating noise and vibration will not disturb your neighbor and in a well-ventilated area with no obstacle.

- Potential risk of malfunction.
- Operating noise may disturb your neighbor.

Make sure that children take precautions against access to the air conditioner and they do not play with the unit.

When using a wireless remote control, the distance should not be more than 7 meters from the air conditioner.

If the remote control is not used for a long period of time, remove the batteries to prevent leakage of electrolyte.

When cleaning the outdoor unit, touch the heat exchanger radiator fins with extreme care.

- **Wearing thick gloves can protect your hands.**

Make sure that the condensed water dripping from the drain hose runs out properly and safely.

Store the operation and installation manual in a safe location and remember to hand it over to the new owner if the air conditioner is sold or transferred.

All the materials used for the manufacture and packaging of the air conditioner are recyclable.

After completing the installation, always carry out a functional test and provide the instructions on how to operate the air conditioner to the user.

safety information



CAUTION SIGNS

★ The appliance is not intended for use by young children or infirm persons without supervision: Young children should be supervised to ensure that they do not play with the appliance.

Clean the air conditioner after the inner fan stops operating.

- Potential risk of injury or electric shock.

Inspect the condition, electric connections, pipes and external case of the air conditioner regularly by a qualified service technician.

Do not open doors and windows in the room being cooled during operation unless necessary.

Do not block the air conditioner vents. If objects block the air flow, it may cause unit malfunction or poor performance.

Make sure there are no obstacles under the indoor unit.

- Potential risk of fire or loss of property.

Make sure that there are no obstacles or covers that block the air conditioner.

Allow sufficient space for air circulation.

- Insufficient ventilation may result in poor performance.

This appliance is not intended for use by persons (including children) with reduced physical, sensory or mental capabilities, or lack of experience and knowledge, unless they have been given supervision or instruction concerning use of the appliance by a person responsible for their safety. Children should be supervised to ensure that they do not play with the appliance.

For use in Europe : This appliance can be used by children aged from 8 years and above and persons with reduced physical, sensory or mental capabilities or lack of experience and knowledge if they have been given supervision or instruction concerning use of the appliance in a safe way and understand the hazards involved. Children shall not play with the appliance. Cleaning and user maintenance shall not be made by children without supervision.

safety information



CAUTION SIGNS

- ★ Make sure the voltage and frequency of the electric system are compatible with the air conditioner.

If a power outage occurs while the air conditioner is working, turn off the power source immediately.

Max current is measured according to IEC standard for safety and current is measured according to ISO standard for energy efficiency.

The unit must be plugged into an independent circuit if applicable or connect the power cable to the auxiliary circuit breaker. An all pole disconnection from the power supply must be incorporated in the fixed wiring with a contact opening of >3 mm.

After connecting the power cable between the indoor/outdoor unit, attach the cover of component box securely and make sure it is not loose.

Power supply cords of parts of appliances for outdoor use shall not be lighter than polychloroprene sheathed flexible cord. (Code designation IEC:60245 IEC 57 / CENELEC:H05RN-F or IEC:60245 IEC 66 / CENELEC: H07RN-F)

The unbalanced power must be maintained within 10 % of supply rating among whole indoor units.

If the power is unbalanced greatly, it may shorten the life of the condenser.

If the unbalanced power is exceeded over 10 % of supply rating, the indoor unit is protected, stopped and the error mode indicates.

To protect the product from water and possible shock, you should keep the power cable and the connection cord of the indoor and outdoor units in the protection tube.

Connect the power cable to the auxiliary circuit breaker.

You must keep the cable in a protection tube.

Keep distances of 50 mm or more between power cable and communication cable.

Maximum length of power cable is decided within 10 % of power drop. If it exceeds, you must consider another power supplying method.



CAUTION SIGNS

- ★ The circuit breaker (MCCB, ELB) should be considered more capacity, if many indoor units are connected from one breaker.

Use solderless ring terminal to connect the power cable to the power terminal block.

Use an appropriate screwdriver for tightening the terminal screws.

Over-tightening the terminal screws may break them.

The air conditioner should be used only for the applications for which it has been designed: the indoor unit is not suitable to be installed in areas used for laundry.

Our units must be installed in compliance with the spaces indicated in the installation manual to ensure either accessibility from both sides or ability to perform routine maintenance and repairs. The units' components must be accessible and that can be disassembled in conditions of complete safety either for people or things. For this reason, where it is not observed as indicated into the Installation Manual, the cost necessary to reach and repair the unit (in safety, as required by current regulations in force) with slings, trucks, scaffolding or any other means of elevation won't be considered in-warranty and charged to end user.

safety information



CAUTION SIGNS



Ensure the off-on and protection switches are properly installed.

Do not use the air conditioner if damaged. If problems occur, immediately stop operation and disconnect the plug from the power supply.

If the air conditioner will not be used for an extended period of time (for example, over several months), unplug the power from the wall.



Call the place of purchase or a contact center if repairs are needed.

- Potential risk of fire or electric shock if disassembly or repairs are attempted by a non-qualified service technician.

If you smell burning plastic, hear strange sounds, or see smoke coming from the unit, unplug the air conditioner immediately and call a contact center.

- Potential risk of fire or electric shock.

contents

| | | |
|---|-----------|---|
| VIEWING YOUR AIR CONDITIONER | 24 | Slim 1 way cassette |
| | 25 | 2 way cassette |
| | 25 | 4 way cassette |
| | 24 | |
| USING YOUR AIR CONDITIONER | 26 | Tips on using your air conditioner |
| | 26 | |
| CLEANING AND MAINTAINING THE AIR CONDITIONER | 28 | Cleaning the exterior |
| | 28 | Cleaning the grille |
| | 28 | Slim 1 way cassette |
| | 30 | 2 way cassette |
| | 31 | 4 way cassette |
| | 32 | Cleaning the filter |
| | 32 | Slim 1 way cassette |
| | 36 | 2 way cassette |
| | 37 | 4 way cassette |
| | 38 | Maintaining your air conditioner |
| | 38 | Periodical checks |
| | 39 | Internal protections via the unit control system |
| | 40 | Troubleshooting |
| APPENDIX | 43 | Operation ranges |
| | 43 | Model specification (Weight and dimension) |
| | 40 | |
| INSTALLING YOUR AIR CONDITIONER | 44 | Installation part |
| | 44 | |



Correct Disposal of This Product (Waste Electrical & Electronic Equipment)

(Applicable in countries with separate collection systems)

This marking on the product, accessories or literature indicates that the product and its electronic accessories (e.g. charger, headset, USB cable) should not be disposed of with other household waste at the end of their working life. To prevent possible harm to the environment or human health from uncontrolled waste disposal, please separate these items from other types of waste and recycle them responsibly to promote the sustainable reuse of material resources.

Household users should contact either the retailer where they purchased this product, or their local government office, for details of where and how they can take these items for environmentally safe recycling.

Business users should contact their supplier and check the terms and conditions of the purchase contract. This product and its electronic accessories should not be mixed with other commercial wastes for disposal.

For information on Samsung's environmental commitments and product specific regulatory obligations e.g. REACH visit: samsung.com/uk/aboutsamsung/samsungelectronics/corporatecitizenship/data_corner.html

viewing your air conditioner

Congratulations on the purchase of the air conditioner. We hope you enjoy the features of your air conditioner and stay cool or warm with optimal efficiency.

Please read the user manual to get started and to make the best use of the air conditioner.

SLIM 1 WAY CASSETTE

Main parts

◆ PC1NUSMAN

◆ PC1NUPMAN

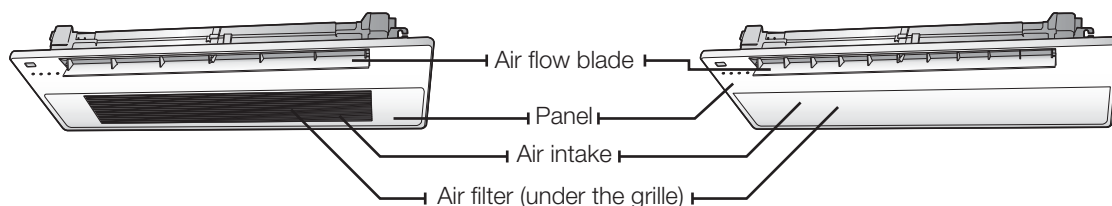

◆ PC1MWSKAN/PC1NWSMAN/PC1BWSMAN

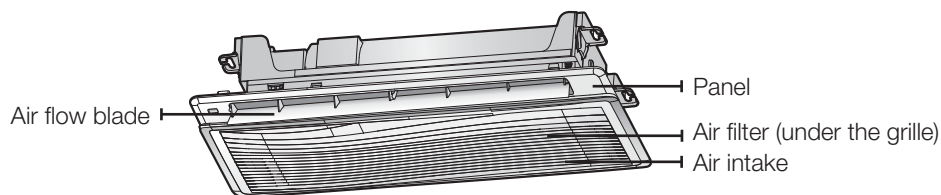

Display

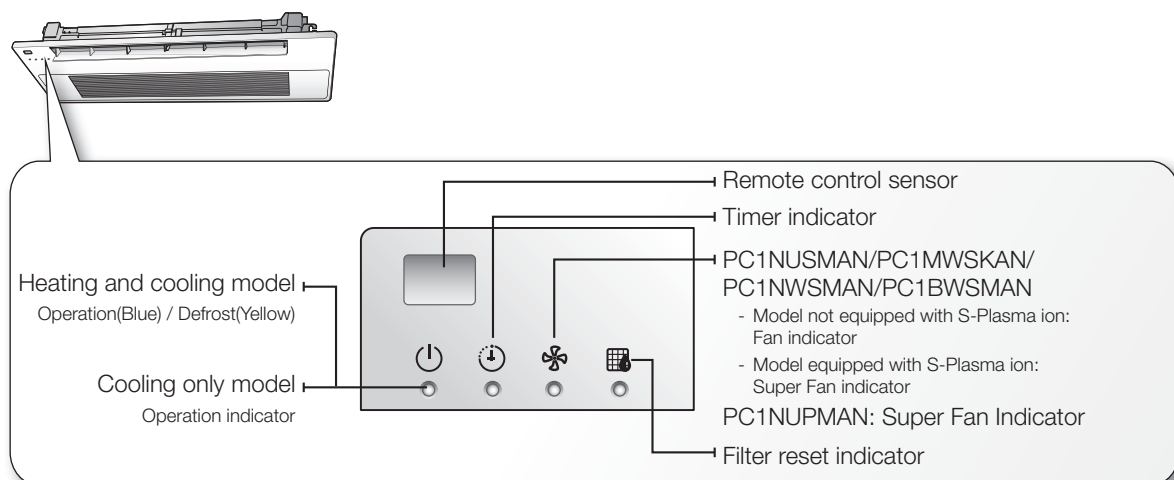

 When operating an indoor unit (including Fan mode), SPi will not operate automatically. So, press the [Super Fan] button on the wireless remote controller to operate SPi.

2 WAY CASSETTE

Main parts

◆ PC2NUSMEN

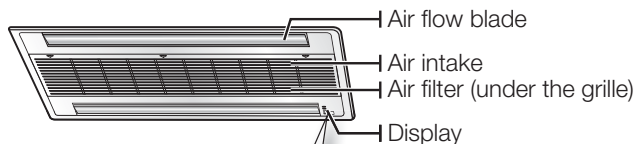

Display

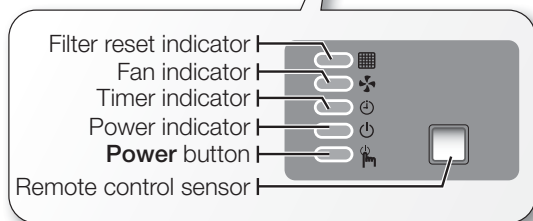

 Your air conditioner and display may look slightly different from the illustration shown above depending on your model.

4 WAY CASSETTE

Main parts

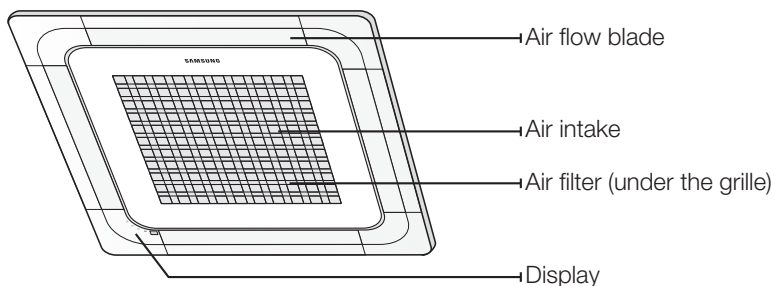

Indicator

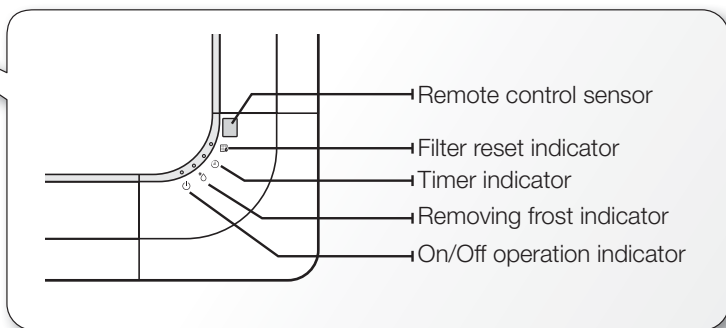
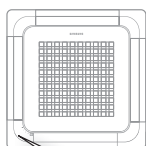

 Your air conditioner and display may look slightly different from the illustration shown above depending on your model.

using your air conditioner

TIPS ON USING AIR CONDITIONER

Here are some tips that you would follow when using your air conditioner.

| TOPIC | RECOMMENDATION |
|---------------------------|---|
| Cooling | <ul style="list-style-type: none">• If current outside temperatures are much higher than the selected indoor temperature, it may take time to bring the inner temperature to the desired coolness.• Avoid drastically turning down the temperature. Energy is wasted and the room does not cool faster. |
| Heating | <ul style="list-style-type: none">• Since the air conditioner heats the room by taking heat energy from outdoor air, the heating capacity may decrease when outdoor temperatures are extremely low. If you feel the air conditioner insufficiently heats, using an additional heating appliance in combination with the air conditioner is recommended. |
| Frost & De-ice | <ul style="list-style-type: none">• When the air conditioner runs in Heat mode, due to temperature difference between the unit and the outside air, frost will form. If this happens:<ul style="list-style-type: none">- The air conditioner stops heating.- The air conditioner will operate automatically in De-ice mode for 10 minutes. |

| | |
|--|---|
| Frost & De-ice | <p>- The steam produced on the outdoor unit in De-ice mode is safe.</p> <p>No intervention is required; after about 10 minutes, the air conditioner operates again normally.</p> <p> The unit will not operate when it starts to de-ice.</p> |
| Fan | <ul style="list-style-type: none"> • Fan may not operate for about 3~5 minutes at the beginning to prevent any cold blasts while the air conditioner is warming up. |
| High indoor/ outdoor temperatures | <ul style="list-style-type: none"> • If both indoor and outdoor temperatures are high and the air conditioner is running in Heat mode, the outdoor unit's fan and compressor may stop at times. This is normal; wait until the air conditioner turns on again. |
| Power failure | <ul style="list-style-type: none"> • If a power failure occurs during the operation of the air conditioner, the operating immediately stops and unit will be off. When power returns, the air conditioner will run automatically. |
| Protection mechanism | <ul style="list-style-type: none"> • If the air conditioner has just been turned on after operation stops or being plugged in, cool/warm air does not come out for 3 minutes to protect the compressor of the outdoor unit. |

cleaning and maintaining the air conditioner

For the best performance of your air conditioner, clean it periodically. When cleaning, make sure to unplug the unit for user's safety.

CLEANING THE EXTERIOR

1. Wipe the surface of the unit with a slightly wet or dry cloth when needed. Wipe off dirt of odd-shaped area by using a soft brush.

Example : 4 way cassette



Do not use benzene or thinner. They may damage the surface of the air conditioner and can create a risk of fire.

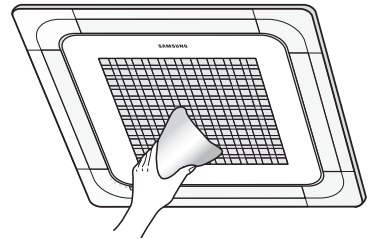

CLEANING THE GRILLE

When cleaning the grille, make sure to unplug the unit. No special tools are needed to clean it.

Slim 1 way cassette

1. Open the grille.

Press the [Push] signs (PC1NUSMAN : Located in 3 places) and open the grille.

◆ PC1NUSMAN

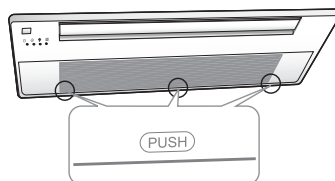

◆ PC1NUPMAN

- When detaching the panel, grip the link part where the panel and intake panel are connected ① and push up the link at the panel part ② to disconnect as shown in the picture (1).
- When power supply malfunctions, detach the panel by using a driver at the marked point (2) and proceed with the same method as shown in the picture (1) to detach the panel and then check the power connection status.

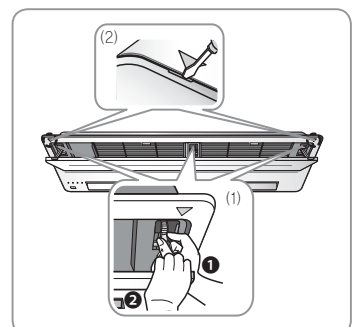

2. Unhook the safety clips by holding the front grille.

3. Detach the front grille.

Hold the front grille at a 45° angle, lift it up slightly and then pull the grille forward.

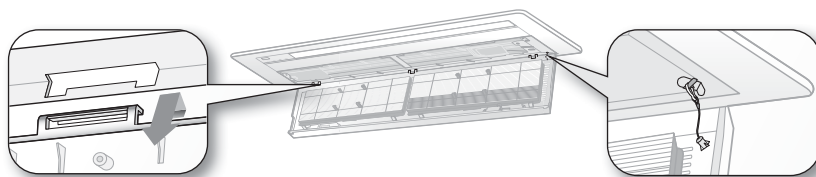

CAUTION

Hold the grille to prevent dropping outside from the opening of the front grille. If not, it may cause a potential risk of personal injury.



Cleaning the grille is also available while being attached to the panel.

4. Pull out the Air filter.

Grab the Air filter and lift it upwards while pushing slightly, and then pull the Air filter forward.

5. Clean the grille with a vacuum cleaner or soft brush. If dust is too heavy, then rinse it with running water and dry it in a ventilated area.

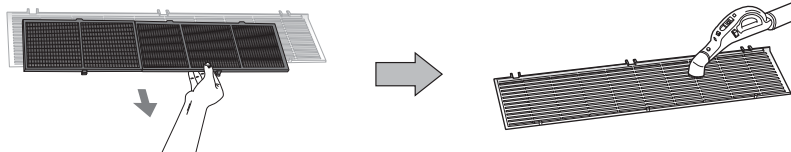

6. Insert the Air filter back in its original position.

7. Reattach the front grille.

Place the hook on the unit to the right place then push the front grille upward. Mount the safety clips to its original position.



The illustration shown above may differ from yours depending on your model.

cleaning and maintaining the air conditioner

CLEANING THE GRILLE

2 way cassette

◆ PC2NUSMEN

1. Open the front grille.

Push the [▼] tabs located in 3 places to unlock the groove on the front grille.

The grille automatically drops. Two safety clips are mounted to the inside front grille to prevent dropping downward.



2. Unhook the safety clips by holding the front grille.

3. Detach the front grille.

Hold the front grille at a 45° angle, lift it up slightly and then pull the grille forward.

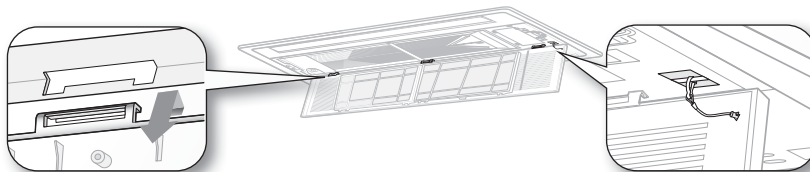

Hold the grille to prevent dropping outside from the opening of the front grille. If not, it may cause a potential risk of personal injury.

 Cleaning the grille is also available while being attached to the panel.

4. Pull out the Air filter.

Grab the Air filter and lift it upwards while pushing slightly, and then pull the Air filter forward.

5. Clean the grille with a vacuum cleaner or soft brush. If dust is too heavy, then rinse it with running water and dry it in a ventilated area.

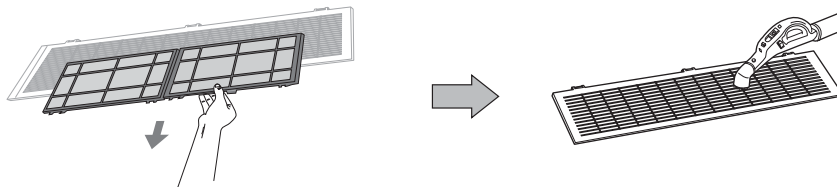

6. Insert the Air filter back in its original position.

7. Reattach the front grille.

Place the hook on the unit to the right place then push the front grille upward. Mount the safety clips to its original position.

4 way cassette

◆ PC4NUSKAN / PC4NUSKEN / PC4NBSKAN

1. Open the front grille.

Open the blades on the left and right side of the Samsung logo. Press both of the levers and pull the grille downward. Two safety clips are mounted to the front grille to prevent it from dropping.

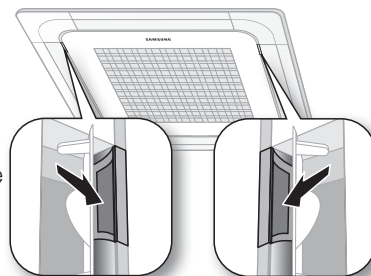

2. Detach the front grille.

Remove the safety clip first and then remove the hinge. Pull the green switch on the hinge part down and then press and pull the hinge part to remove the grillae. (There are two hinges on the grille and you must apply this step on both of them to remove the grille.)

✳ If you want to clean the filter only, you do not have to detach the grille. Follow step 4 and 5

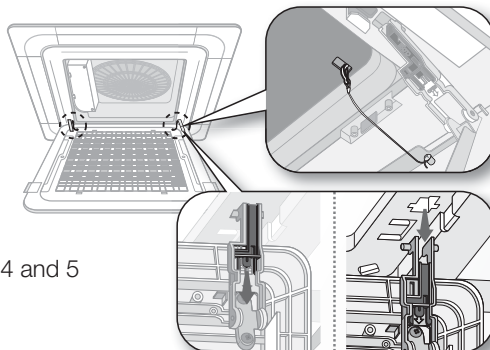

3. Pull out the Air filter.

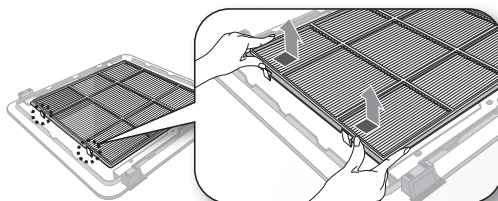

4. Clean the grille and Air filter with a vacuum cleaner or soft brush. If dust is too heavy, then rinse it with running water and dry it in a ventilated area.

For best conditions, repeat every two weeks.

If the Air filter dries in a confined (or humid) area, odors may generate. If it occurs, re-clean and dry it in a well-ventilated area.

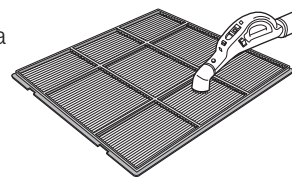

5. Insert the Air filter back in its original position.

You will hear a click sound when the Air filter is properly placed.

6. Attach the front grille.

Reverse the above steps to attach the front grille.



- The illustration shown above may differ from yours depending on your model.
- After cleaning the filter, press the Filter Reset button on the remote control for 2 seconds to reset the filter schedule. Filter sign indicator will be on for cleaning time.
- If the angle on the air flow blades has been changed by user due to opening the front grille for installation or maintenance, you must turn off the circuit breaker and turn it on again before using the air conditioner. Otherwise, angles of the each angle can be different or some of the blade may not close when the product is off.

cleaning and maintaining the air conditioner

CLEANING THE FILTER

When cleaning the filter, make sure to unplug the power from the unit. Washable foam based Air filter captures large particles from the air. The filter is cleaned with a vacuum or by hand washing.

Slim 1 way cassette

1. Open the grille.

Press the [Push] signs (PC1NUSMAN : Located in 3 places) and open the grille.

◆ PC1NUSMAN

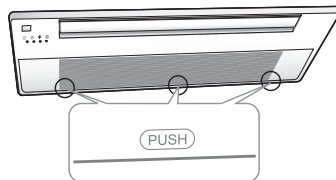

◆ PC1NUPMAN

- When detaching the panel, grip the link part where the panel and intake panel are connected ① and push up the link at the panel part ② to disconnect as shown in the picture (1).
- When power supply malfunctions, detach the panel by using a driver at the marked point (2) and proceed with the same method as shown in the picture (1) to detach the panel and then check the power connection status.

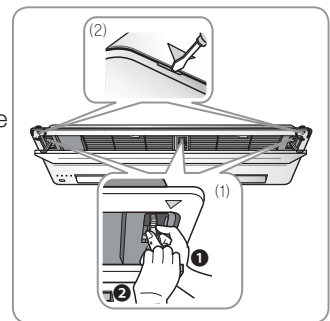

2. Pull out the Air filter.

Grab the Air filter and lift it upwards while pushing slightly, and then pull the Air filter forward.

-  When cleaning the filter you do not need to detach the grille at all times. If you want to detach the front grille, see step 2 and 3 on page 27 for instructions.

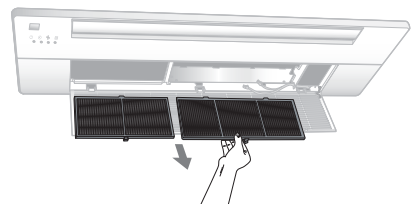

-
3. Clean the Air filter with a vacuum cleaner or soft brush. If dust is too heavy, then rinse it with running water and dry it in a ventilated area.

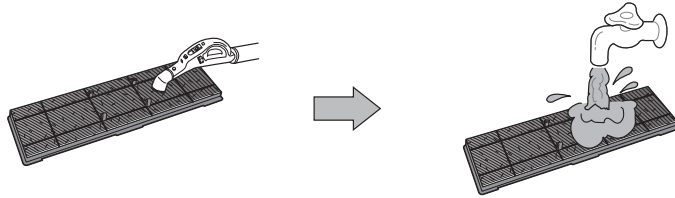

- For best conditions, repeat every two weeks.
- If the Air filter dries in a confined (or humid) area, odors may generate. If it occurs, re-clean and dry it in a well-ventilated area.

-
4. Insert the Air filter back in its original position.
You will hear a click sound when the Air filter is properly placed.
5. Close the front grille by pushing it upward.

- The illustration shown above may differ from yours depending on your model.
- After cleaning the filter, press the **Filter Reset** button on the remote control for 2 seconds to reset the filter schedule. Filter sign indicator will be on for cleaning time.

cleaning and maintaining the air conditioner

CLEANING THE FILTER

Slim 1 way cassette

1. Open the grille.
Pull the transparent part to open the grille.
Do not detach the grille since the filter can be detached while the grille is connected.

◆ PC1MWSKAN/PC1NWSMAN/PC1BWSMAN

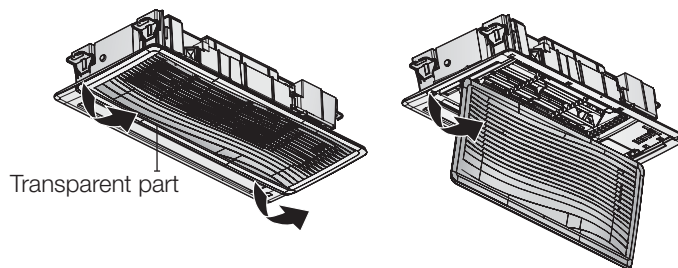

2. Detach the air filter.
Pull the filter handle to detach the filter.

◆ PC1MWSKAN

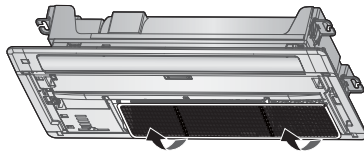

◆ PC1NWSMAN/PC1BWSMAN

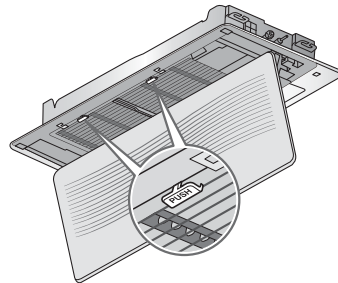

3. Remove the dust on the filter with a vacuum cleaner or brush.
When there is too much dust on the filter, clean the filter softly with the tepid water in which a neutral detergent is dissolved.
If you rub the filter together to wash it, the filter may get damaged.

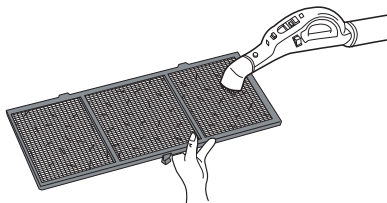

4. Dry the filter completely in the shade.
When drying the air filter, make sure the filter is not exposed to direct sunlight. Otherwise, the form of the air filter may be changed.

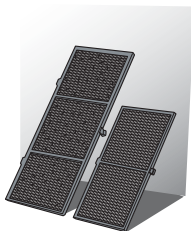

5. Assemble the filter back and then close the grille.
If the center of the grille is not closed tightly, press the center with hands to close the grille completely.

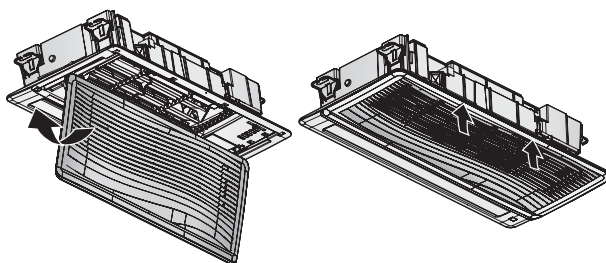

- When the indoor unit is used without the air filter, the indoor unit may get damaged with dust.
 - When opening the grille, you should grip the grille until it hangs safely. Otherwise, the grille may fall down, which may cause an injury.
 - The grille is connected to the panel. Do not forcibly detach the grille. If the connection structure is broken, the grille may fall down, which may cause an injury.
-  • Clean the air filter once in every 2 weeks. However, the cleaning period may differ depending on the hours of filter use and service environment. Therefore, clean the filter every week in a dusty area.
- If the filter reset indicator is turned on on the display of the indoor unit, check and clean the filter if it is dirty.

cleaning and maintaining the air conditioner

CLEANING THE FILTER

When cleaning the filter, make sure to unplug the power from the unit. Washable foam based Air filter captures large particles from the air. The filter is cleaned with a vacuum or by hand washing.

2 way cassette

1. Open the front grille.

Push the [▼] tabs located in 3 places to unlock the hook on the front grille.

The grille automatically drops. Two safety clips are mounted to the inside front grille to prevent dropping downward.

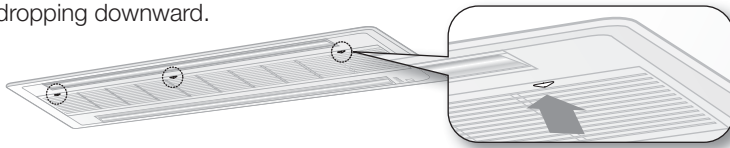

2. Pull out the Air filter.

Grab the Air filter and lift it upwards while pushing slightly, and then pull the Air filter forward.

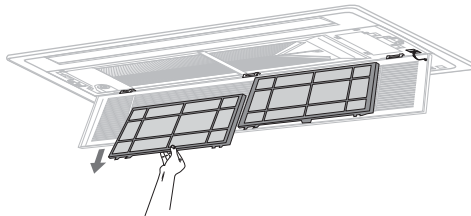

 When cleaning the filter you do not need to detach the grille at all times. If you want to detach the front grille, see step 2 and 3 on page 27 for instructions.

3. Clean the Air filter with a vacuum cleaner or soft brush. If dust is too heavy, then rinse it with running water and dry it in a ventilated area.

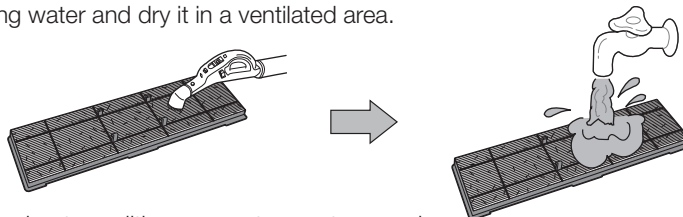

 • For best conditions, repeat every two weeks.
• If the Air filter dries in a confined (or humid) area, odors may generate. If it occurs, re-clean and dry it in a well-ventilated area.

4. Insert the Air filter back in its original position.

You will hear a click sound when the Air filter is properly placed.

5. Close the front grille by pushing it upward.

-  After cleaning the filter, press the **Filter Reset** button on the remote control for 2 seconds to reset the filler schedule. Filter sign indicator will be on for cleaning time.

4 way cassette

1. Push both of the tabs outwards to unlock the hook on the front grille.

The grille automatically drops. Two safety clips are mounted to the inside front grille to prevent dropping downward.

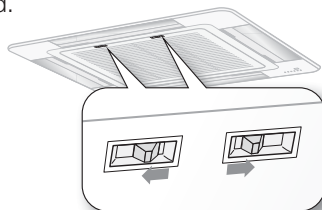

2. Pull out the Air filter.

Grab the Air filter and lift it upwards while pushing slightly, and then pull the Air filter forward.

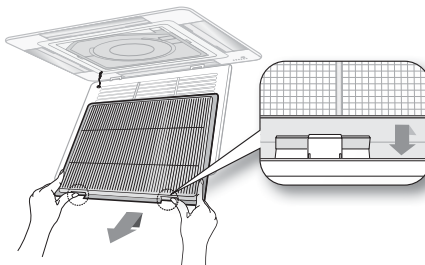

-  When cleaning the filter you do not need to detach the grille at all times. If you want to detach the front grille, see step 2 and 3 on page 27 for instructions.

3. Clean the Air filter with a vacuum cleaner or soft brush. If dust is too heavy, then rinse it with running water and dry it in a ventilated area.

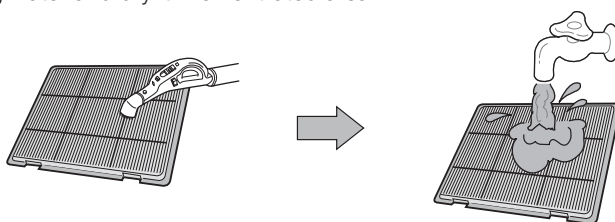

-  • For best conditions, repeat every two weeks.
• If the Air filter dries in a confined (or humid) area, odors may generate. If it occurs, re-clean and dry it in a well-ventilated area.

4. Insert the Air filter back in its original position.

You will hear a click sound when the Air filter is properly placed.

5. Close the front grille by pushing it upward.

-  • The illustration shown above may differ from yours depending on your model.
• After cleaning the filter, press the **Filter Reset** button on the remote control for 2 seconds to reset the filler schedule. Filter sign indicator will be on for cleaning time.

cleaning and maintaining the air conditioner

MAINTAINING YOUR AIR CONDITIONER

If the air conditioner will not be used for an extended period of time, dry the air conditioner to maintain it in best condition.

1. Dry the air conditioner thoroughly by operating in Fan mode for 3 to 4 hours and disconnect the power plug. There may be internal damage if moisture is left in components.
2. Before using the air conditioner again, dry the inner components of the air conditioner again by running in Fan mode for 3 to 4 hours. This helps remove odors which may have generated from dampness.

Periodical checks

Refer to the following chart to maintain the air conditioner properly.

| Type | Description | Monthly | Every 4 months | Once a year |
|--------------|--|---------|----------------|-------------|
| Indoor unit | Clean the air filter (1) | ● | | |
| | Clean the condensate drain pan (2) | | | ● |
| | Thoroughly clean the heat exchanger (2) | | | ● |
| | Clean the condensate drain pipe (2) | | ● | |
| | Replace the remote control batteries (1) | | | ● |
| Outdoor unit | Clean the heat exchanger on the outside of the unit (2) | | ● | |
| | Clean the heat exchanger on the inside of the unit (2) | | | ● |
| | Clean the electric components with jets of air (2) | | | ● |
| | Verify that all the electric components are firmly tightened (2) | | | ● |
| | Clean the fan (2) | | | ● |
| | Verify that all the fan assembly is firmly tightened (2) | | | ● |
| | Clean the condensate drain pan (2) | | | ● |

 The checks and maintenance operations described are essential to guarantee the efficiency of the air conditioner. The frequency of these operations varies according to the characteristics of the area, the amount of dust, etc.

(1) The described operations should be performed more frequently if the area of installation is very dusty.

(2) These operations must always be performed by qualified personnel. For more detailed information, see the Installation Manual.

Internal protections via the unit control system

This internal protection operates if an internal fault occurs in the air conditioner.

| Type | Description |
|--|---|
| Against cold air | The internal fan will be off to against cold air when the heat pump is heating. |
| De-ice cycle | The internal fan will be off to against cold air when the heat pump is heating. |
| Anti-protection of internal battery | The compressor will be off to protect internal battery when the air conditioner operates in Cool mode. |
| Protect compressor | The air conditioner does not start operating immediately to protect the compressor of the outdoor unit after it has been started. |

 If the heat pump is operating in Heat mode, De-ice cycle is actuated to remove frost from an outdoor unit that may have deposited at low temperatures.

The internal fan is switched off automatically and restarted only after the de-ice cycle is completed.

TROUBLESHOOTING

Refer to the following chart if the air conditioner operates abnormally. This may save time and unnecessary expenses.

| PROBLEM | SOLUTION |
|---|---|
| <p>The air conditioner does not operate immediately after it has been restarted.</p> | <ul style="list-style-type: none"> • Because of the protective mechanism, the appliance does not start operating immediately to keep the unit from overloading. The air conditioner will start in 3 minutes. |
| <p>The air conditioner does not work at all.</p> | <ul style="list-style-type: none"> • Check that the power plug is properly connected. Insert the power plug into the wall socket correctly. • Check if the circuit breaker is switched off. • Check if there is a power failure. • Check your fuse. Make sure it is not blown out. |
| <p>The temperature does not change.</p> | <ul style="list-style-type: none"> • Check if you selected Fan mode. Press the Mode button on the remote control to select another mode. |
| <p>The cool (warm) air does not come out of the air conditioner.</p> | <ul style="list-style-type: none"> • Check if the set temperature is higher (lower) than the current temperature. Press the Temperature button on the remote control to change the set temperature. Press the Temperature button to decrease or increase the temperature. • Check if the air filter is blocked by dirt. Clean the air filter every two weeks. |

| | |
|---|--|
| <p>The cool (warm) air does not come out of the air conditioner.</p> | <ul style="list-style-type: none"> • Check if the air conditioner has just been turned on. If so, wait 3 minutes. Cool air does not come out to protect the compressor of the outdoor unit. • Check if the air conditioner is installed in a place with a direct exposure to sunlight. Hang curtains on windows to boost cooling efficiency. • Check if the cover or any obstacle is not near the outdoor unit. • Check if the refrigerant pipe is too long. • Check if the air conditioner is only available in Cool mode. • Check if the remote control is only available for cooling model. |
| <p>The fan speed does not change.</p> | <ul style="list-style-type: none"> • Check if you selected Auto or Dry mode. The air conditioner automatically adjusts the fan speed to Auto in Auto/Dry mode. |
| <p>Timer function does not set.</p> | <ul style="list-style-type: none"> • Check if you press the Power button on the remote control after you have set the time. |
| <p>Odors permeate in the room during operation.</p> | <ul style="list-style-type: none"> • Check if the appliance is running in a smoky area or if there is a smell entering from outside. Operate the air conditioner in Fan mode or open the windows to air out the room. |
| <p>The air conditioner makes a bubbling sound.</p> | <ul style="list-style-type: none"> • A bubbling sound may be heard when the refrigerant is circulating through the compressor. Let the air conditioner operate in a selected mode. |

appendix

| PROBLEM | SOLUTION |
|--|---|
| The air conditioner makes a bubbling sound. | <ul style="list-style-type: none">• When you press the Power button on the remote control, noise may be heard from the drain pump inside the air conditioner. |
| Water is dripping from the air flow blades. | <ul style="list-style-type: none">• Check if the air conditioner has been cooling for an extended period of time with the air flow blades pointed downwards. Condensation may generate due to the difference in temperature. |
| Remote control is not working. | <ul style="list-style-type: none">• Check if your batteries are depleted.• Make sure batteries are correctly installed.• Make sure nothing is blocking your remote control sensor.• Check that there are strong lighting apparatus near the air conditioner. Strong light which comes from fluorescent bulbs or neon signs may interrupt the electric waves. |
| The air conditioner does not turn on or off with the wired remote control. | <ul style="list-style-type: none">• Check if you set the wired remote control for group control. |
| The wired remote control does not operate. | <ul style="list-style-type: none">• Check if TEST indicator is displayed on the wired remote control. If so, turn off the unit and switch off the circuit breaker. Call your nearest contact center. |
| The indicators of the digital display flashes. | <ul style="list-style-type: none">• Press the Power button on the remote control to turn the unit off and switch the circuit breaker off. Then, switch it on again. |

OPERATION RANGES

The table below indicates the temperature and humidity ranges the air conditioner can be operated within. Refer to the table for efficient use.

| MODE | Indoor temperature | Outdoor temperature | Indoor humidity |
|---------|--------------------|---------------------|-----------------|
| Cooling | 18~32 °C | -5~48 °C | 80 % or less |
| Heating | 27 °C or less | -20~24 °C | - |
| Drying | 18~32 °C | -5~48 °C | - |

MODEL SPECIFICATION (WEIGHT AND DIMENSION)

| Type | Model | Net weight | Net dimension (W x D x H) |
|-----------------------|----------------|--------------------|---------------------------|
| Indoor unit (NASA) | AM017HN1DEH/EU | 8.0 kg | 740 x 360 x 135 mm |
| | AM022HN1DEH/EU | 8.0 kg | 740 x 360 x 135 mm |
| | AM022FN1DEH/EU | 10.5 kg | 970 x 410 x 135 mm |
| | AM028FN1DEH/EU | 10.5 kg | 970 x 410 x 135 mm |
| | AM036FN1DEH/EU | 10.5 kg | 970 x 410 x 135 mm |
| | AM056JN1DEH/EU | 14.5 kg | 1200 x 450 x 138 mm |
| | AM071JN1DEH/EU | 14.5 kg | 1200 x 450 x 138 mm |
| | AM056FN2DEH/EU | 21.0 kg | 890 x 575 x 230 mm |
| | AM071FN2DEH/EU | 21.0 kg | 890 x 575 x 230 mm |
| | AM045FN4DEH/EU | 15.5 kg | 840 x 840 x 204 mm |
| | AM056FN4DEH/EU | 15.5 kg | 840 x 840 x 204 mm |
| | AM071FN4DEH/EU | 15.5 kg | 840 x 840 x 204 mm |
| | AM090FN4DEH/EU | 15.5 kg | 840 x 840 x 204 mm |
| | AM112FN4DEH/EU | 17.0 kg | 840 x 840 x 246 mm |
| | AM128FN4DEH/EU | 19.0 kg | 840 x 840 x 288 mm |
| | AM140FN4DEH/EU | 19.0 kg | 840 x 840 x 288 mm |
| | AM060KN4FEH/EU | 21.0 kg | 840 x 840 x 288 mm |
| AM071KN4FEH/EU | 21.0 kg | 840 x 840 x 288 mm | |
| AM080KN4FEH/EU | 21.0 kg | 840 x 840 x 288 mm | |

Installation Part

Indoor Unit Installation

It is recommended to install the Y-joint before installing the indoor unit.

- Place the pattern sheet on the ceiling at the spot where you want to install the indoor unit.

Note Since the diagram is made of paper, it may shrink or stretch slightly due to temperature or humidity. For this reason, before drilling the holes maintain the correct dimensions between the markings.

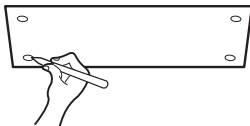

- Insert bolt anchors, use existing ceiling supports or construct a suitable support as shown in figure.

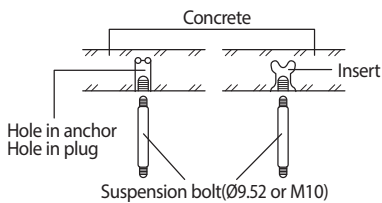

- Install the suspension bolts depending on the ceiling type.



- Ensure that the ceiling is strong enough to support the weight of the indoor unit. Before hanging the unit, test the strength of each attached suspension bolt.
- If the length of suspension bolt is more than 1.5 m, it is required to prevent vibration.
- If this is not possible, create an opening on the false ceiling in order to be able to use it to perform the required operations on the indoor unit.

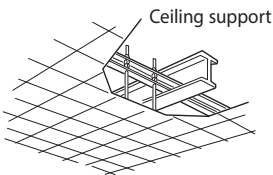

- Screw eight nuts to the suspension bolts making space for hanging the indoor unit.



You must install the suspension bolts more than four when installing the indoor unit.

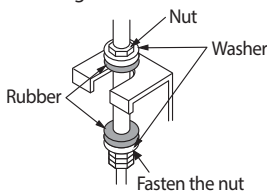

- Check the level of the indoor unit by using a leveler.

- A tilt of the indoor unit may cause malfunction of a built-in float switch and water leaks.

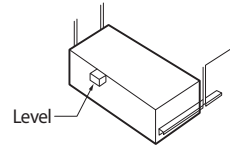

- Adjust the height of the indoor unit by using the gauge of dimensions.

- You should adjust the jigs and the pattern sheet to fit the cutting dimensions of ceiling.
- Noise may occur if you do not adjust the location of the indoor unit according to location of the jigs during installation.
 - Adjust the location of the indoor unit according to the jigs.
- Make sure that the indoor unit is installed at a level if the indoor unit slants too much, there can be water leaks.
- AM***HN1DEH* models have installation guide on the product. Make sure to adjust the height of the suspension bolt so that surface of the ceiling and the installation guide on the indoor unit is parallel to each other.

Slim 1 way cassette

AM***FN1DEH*/AM***JN1DEH*

AM***HN1DEH*

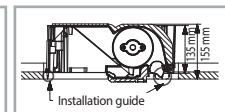
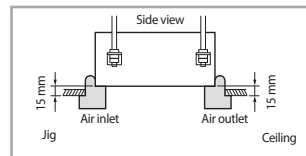

* Make sure surface of the ceiling and the installation guide is parallel to each other.

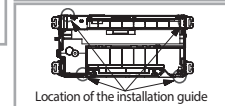

2 way cassette

AM***FN2DEH*

4 way cassette

AM***FN4DEH*/AM***KN4FEH*

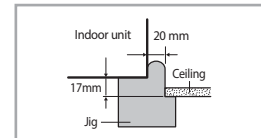
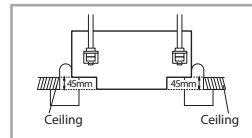

- Tighten the upper part nuts.

- Remove the gauge of dimensions after installing the indoor unit.

Performing Leak Test & Insulation

Leak test

LEAK TEST WITH NITROGEN(before opening valves)

In order to detect basic refrigerant leaks, before recreating the vacuum and recirculating the R-410A, it's responsible of installer to pressurize the whole system with nitrogen(using a pressure regulator) at a pressure above 4.1MPa(gauge).

LEAK TEST WITH R-410A(after opening valves)

Before opening valves, discharge all the nitrogen into the system and create vacuum. After opening valves check leaks using a leak detector for refrigerant R-410A.

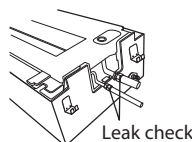

* The designs and shape are subject to change according to the model.



Discharge all the nitrogen to create a vacuum and charge the system.

Insulation

Once you have checked that there are no leaks in the system, you can insulate the piping and hose.

- To avoid condensation problems, place **T13.0 or thicker Acrylonitrile Butadiene Rubber** separately around each refrigerant pipe.

Note Always make the seam of pipes face upwards.

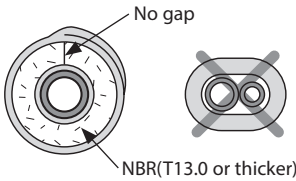

- Wind insulating tape around the pipes and drain hose avoiding to compress the insulation too much.

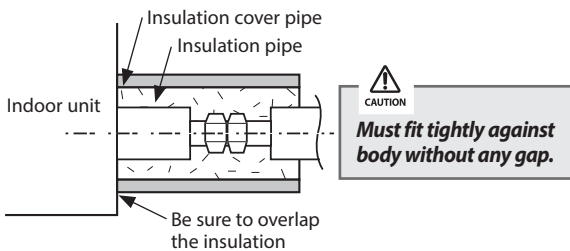

- Finish wrapping insulating tape around the rest of the pipes leading to the outdoor unit.
- The pipes and electrical cables connecting the indoor unit with the outdoor unit must be fixed to the wall with suitable ducts.



All refrigerant connection must be accessible, in order to permit either unit maintenance or removing it completely.

- Select the insulation of the refrigerant pipe.
 - Insulate the gas side and liquid side pipe referring to the thickness according to the pipe size.
 - Indoor temperature of 30 °C and humidity of 85 % is the standard condition. If installing in a high humidity condition, use one grade thicker insulator by referring to the table below.
 - Insulator's heat-resistance temperature should be more than 120 °C.

| Pipe | Pipe size | Insulation Type (Heating/Cooling) | | Remarks |
|-------------|-----------------|-----------------------------------|----------------------------------|--|
| | | Standard [30 °C, 85 %] | High humidity [30 °C, over 85 %] | |
| Liquid pipe | Ø6.35 ~ Ø9.52 | 9 t | ← | Internal temperature is higher than 120 °C |
| | Ø12.7 ~ Ø50.80 | 13 t | ← | |
| Gas pipe | Ø6.35 | 13 t | 19 t | |
| | Ø9.52 ~ Ø25.40 | 19 t | 25 t | |
| | Ø28.58 ~ Ø44.45 | | 32 t | |
| | Ø50.80 | 25 t | 38 t | |

- When installing insulation in places and conditions below, use the same insulation that is used for high humidity conditions.

<Geological condition>

- High humidity places such as shoreline, hot spring, near lake or river, and ridge (when the part of the building is covered by earth and sand.)

<Operation purpose condition>

- Restaurant ceiling, sauna, swimming pool etc.

<Building construction condition>

- The ceiling frequently exposed to moisture and cooling is not covered.

e.g. The pipe installed at a corridor of a dormitory and studio or near an exit that opens and closes frequently.

- The place where the pipe is installed is highly humid due to the lack of ventilation system.



- Install the insulation not to get wider and use the adhesives on the connection part of it to prevent moisture from entering.
- Wind the refrigerant pipe with insulation tape if it is exposed to outside sunlight.
- Install the refrigerant pipe respecting that the insulation does not get thinner on the bent part or hanger of pipe.
- Add the additional insulation if the insulation plate gets thinner.

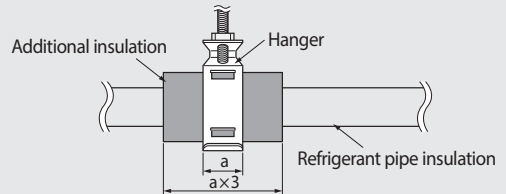

Drain pipe and Drain Hose Installation

- Install the drain pipe as shortly as possible.
 - Give a slightly slant to the drainpipe for proper drainage of condensate water.
 - There must be no gap on the connected part so that the drainpipe is not separated from the flexible hose.
- Insulate the drainpipe, and then fix it as indicated.
 - Whole drainpipe should be insulated by 5t(or more) insulation to prevent water condensation.

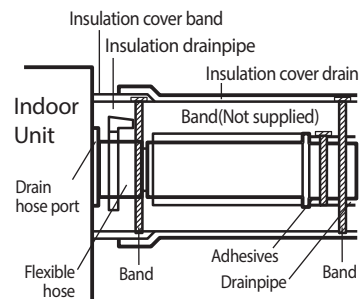

* Flexible hose Installation

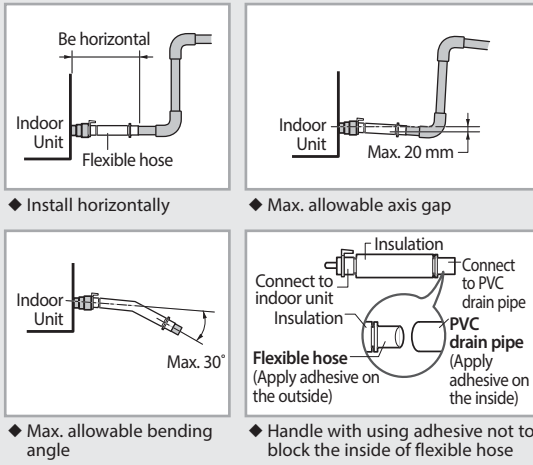

Drainpipe Connection

- The drain pipe should be installed within 100 mm from the flexible hose, lift up from 100 mm to 550 mm and lift down 20 mm or more.
- Install horizontal drainpipe with a slope of 1/100 or more and fix it by hanger space of 1~1.5 m.
- Install the air vent in the horizontal drainpipe to prevent water flow back to the indoor unit.
Note You may not need to install it if there were proper slope in the horizontal drainpipe.
- The flexible hose should not be installed upward position, it may cause water flow back to the indoor unit.
- Install U-trap at the end of the drainpipe to prevent a nasty smell to reach the indoor unit.

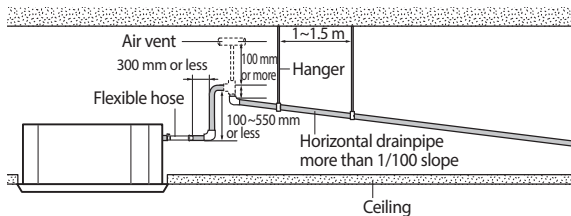

Centralized Drainage

- Install main air vent at the front of the farthest indoor unit from the main drain when installed indoor units are more than 3.
- You may need to install individual air vent to prevent water flow back at the top of each indoor unit drainpipe.

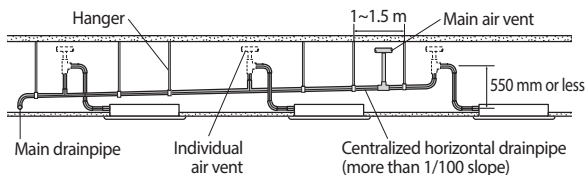

Wiring Work

Power and communication cable connection

- Before wiring work, you must turn off all power source.
- Indoor unit power should be supplied through the breaker(MCCB, ELB) separated by the outdoor power.
- The power cable should be used only copper wires.
- Connect the power cable(1(L), 2(N)) among the units within maximum length and communication cable(F1, F2) each.
- Connect F3, F4(for communication) when installing the wired remote Control.

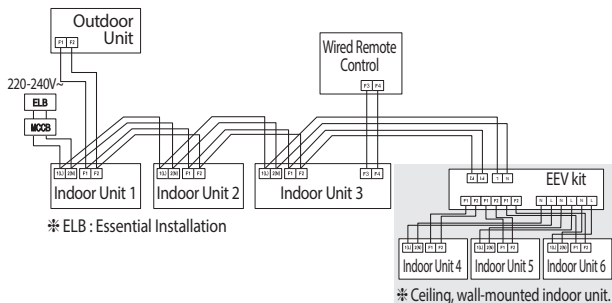

Selecting compressed ring terminal

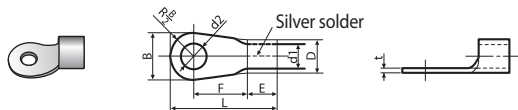

| Nominal dimensions for cable (mm ²) | Nominal dimensions for screw (mm) | B | | D | | d1 | E | F | L | d2 | | t | |
|---|-----------------------------------|-------------------------|----------------|-------------------------|----------------|-----|------|-----|---|-------------------------|----------------|-----------|-----|
| | | Standard dimension (mm) | Allowance (mm) | Standard dimension (mm) | Allowance (mm) | | | | | Standard dimension (mm) | Allowance (mm) | | |
| 1.5 | 4 | 6.6 | ±0.2 | 3.4 | +0.3 -0.2 | 1.7 | ±0.2 | 4.1 | 6 | 16 | 4.3 | +0.2 0 | 0.7 |
| | 4 | 8 | | | | | | | | | | | |
| 2.5 | 4 | 6.6 | ±0.2 | 4.2 | +0.3 -0.2 | 2.3 | ±0.2 | 6 | 6 | 17.5 | 4.3 | +0.2 0 | 0.8 |
| | 4 | 8.5 | | | | | | | | | | | |
| 4 | 4 | 9.5 | ±0.2 | 5.6 | +0.3 -0.2 | 3.4 | ±0.2 | 6 | 5 | 20 | 4.3 | +0.2 0 | 0.9 |

Specification of electronic wire

| Power supply | MCCB | ELB | Power cable | Earth cable | Communication cable |
|--------------------------|------|---------------------|---------------------|---------------------|--------------------------|
| Max: 242 V Min: 198 V | X A | X A, 30 mA 0.1 s | 2.5 mm ² | 2.5 mm ² | 0.75~1.5 mm ² |

- ◆ Decide the capacity of ELB and MCCB by below formula.

$$\text{The capacity of ELB, MCCB } X [A] = 1.25 \times 1.1 \times \sum A_i$$

- * X: The capacity of ELB, MCCB
- * $\sum A_i$: Sum of Rating currents of each indoor unit.
- * Refer to each installation manual about the rating current of indoor unit.

- ◆ Decide the power cable specification and maximum length within 10 % power drop among indoor units.

$$\sum_{k=1}^n \left(\frac{\text{Coef} \times 35.6 \times L_k \times i_k}{1000 \times A_k} \right) < 10 \% \text{ of input voltage [V]}$$

- * Coef: 1.55
- * L_k : Distance among each indoor unit[m],
- * A_k : Power cable specification[mm²], i_k : Running current of each unit[A]

Setting an indoor unit address and installation option

Set the indoor unit address and installation option with remote controller option.
 Set the each option separately since you cannot set the ADDRESS setting and indoor unit installation setting option at the same time. You need to set twice when setting indoor unit address and installation option.

The procedure of option setting

MR-DC00, MR-DH00

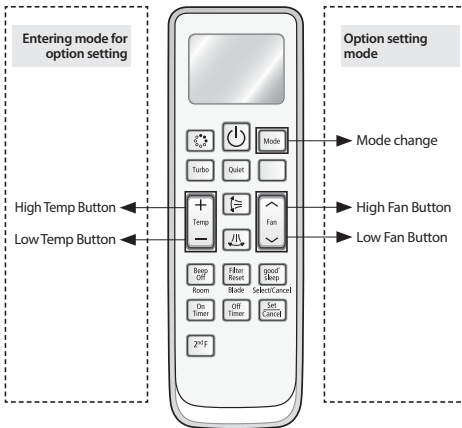

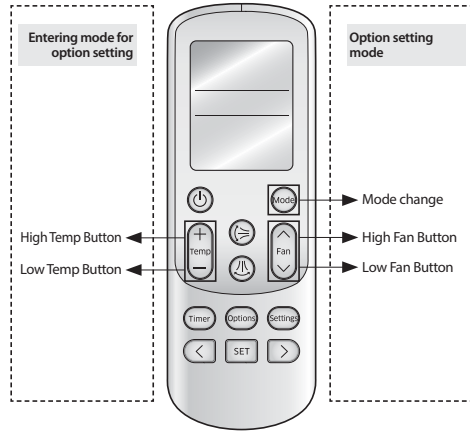

MR-EC00, MR-EH00



* The display of the remote controller may be different depending on the model.

Step 1. Entering mode to set option

1. Remove batteries from the remote controller.
2. Insert batteries and enter the option setting mode while pressing High Temp button and Low Temp button. 
3.  Check if you have entered the option setting status.

Step 2. The procedure of option setting

After entering the option setting status, select the option as listed below.









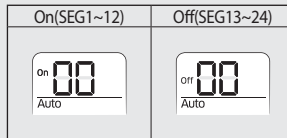







































Option setting is available from SEG1 to SEG 24

































- ◆ **SEG1, SEG7, SEG13, SEG19 are not set as page option.**
- ◆ **Set the SEG2~SEG6, SEG8~SEG12 as ON status and SEG14~18, SEG20~24 as OFF status.**

| SEG1 | SEG2 | SEG3 | SEG4 | SEG5 | SEG6 | SEG7 | SEG8 | SEG9 | SEG10 | SEG11 | SEG12 |
|-------|-------|-------|-------|-------|-------|-------|-------|-------|-------|-------|-------|
| 0 | X | X | X | X | X | 1 | X | X | X | X | X |
| SEG13 | SEG14 | SEG15 | SEG16 | SEG17 | SEG18 | SEG19 | SEG20 | SEG21 | SEG22 | SEG23 | SEG24 |
| 2 | X | X | X | X | X | 3 | X | X | X | X | X |



Setting an indoor unit address and installation option

| Option setting | Status |
|--|--|
| <p>1. Setting SEG2, SEG3 option Press Low Fan button(V) to enter SEG2 value. Press High Fan button(^) to enter SEG3 value. Each time you press the button,  →  → ...  →  will be selected in rotation.</p> | <div style="display: flex; justify-content: space-around; align-items: center;"> <div style="text-align: center;">  SEG2 </div> <div style="text-align: center;">  SEG3 </div> </div> |
| <p>2. Setting Cool mode  Press Mode button to be changed to Cool mode in the ON status.</p> | <div style="text-align: center;">  </div> |
| <p>3. Setting SEG4, SEG5 option Press Low Fan button(V) to enter SEG4 value. Press High Fan button(^) to enter SEG5 value. Each time you press the button,  →  → ...  →  will be selected in rotation.</p> | <div style="display: flex; justify-content: space-around; align-items: center;"> <div style="text-align: center;">  SEG4 </div> <div style="text-align: center;">  SEG5 </div> </div> |
| <p>4. Setting Dry mode  Press Mode button to be changed to DRY mode in the ON status.</p> | <div style="text-align: center;">  </div> |
| <p>5. Setting SEG6, SEG8 option Press Low Fan button(V) to enter SEG6 value. Press High Fan button(^) to enter SEG8 value. Each time you press the button,  →  → ...  →  will be selected in rotation.</p> | <div style="display: flex; justify-content: space-around; align-items: center;"> <div style="text-align: center;">  SEG6 </div> <div style="text-align: center;">  SEG8 </div> </div> |
| <p>6. Setting Fan mode  Press Mode button to be changed to FAN mode in the ON status.</p> | <div style="text-align: center;">  </div> |
| <p>7. Setting SEG9, SEG10 option Press Low Fan button(V) to enter SEG9 value. Press High Fan button(^) to enter SEG10 value. Each time you press the button,  →  → ...  →  will be selected in rotation.</p> | <div style="display: flex; justify-content: space-around; align-items: center;"> <div style="text-align: center;">  SEG9 </div> <div style="text-align: center;">  SEG10 </div> </div> |
| <p>8. Setting Heat mode  Press Mode button to be changed to HEAT mode in the ON status.</p> | <div style="text-align: center;">  </div> |
| <p>9. Setting SEG11, SEG12 option Press Low Fan button(V) to enter SEG11 value. Press High Fan button(^) to enter SEG12 value. Each time you press the button,  →  → ...  →  will be selected in rotation.</p> | <div style="display: flex; justify-content: space-around; align-items: center;"> <div style="text-align: center;">  SEG11 </div> <div style="text-align: center;">  SEG12 </div> </div> |
| <p>10. Setting Auto mode  Press Mode button to be changed to AUTO mode in the OFF status.</p> | <div style="text-align: center;">  </div> |
| <p>11. Setting SEG14, SEG15 option Press Low Fan button(V) to enter SEG14 value. Press High Fan button(^) to enter SEG15 value. Each time you press the button,  →  → ...  →  will be selected in rotation.</p> | <div style="display: flex; justify-content: space-around; align-items: center;"> <div style="text-align: center;">  SEG14 </div> <div style="text-align: center;">  SEG15 </div> </div> |

| Option setting | Status |
|---|--|
| 12. Setting Cool mode  Press Mode button to be change to Cool mode in the OFF status. |  |
| 13. Setting SEG16, SEG17 option Press Low Fan button(∨) to enter SEG16 value. Press High Fan button(∧) to enter SEG17 value. Each time you press the button,  →  → ...  →  will be selected in rotation. |   SEG16 SEG17 |
| 14. Setting Dry mode  Press Mode button to be change to Dry mode in the OFF status. |  |
| 15. Setting SEG18, SEG20 option Press Low Fan button(∨) to enter SEG18 value. Press High Fan button(∧) to enter SEG20 value. Each time you press the button,  →  → ...  →  will be selected in rotation. |   SEG18 SEG20 |
| 16. Setting Fan mode  Press Mode button to be change to Fan mode in the OFF status. |  |
| 17. Setting SEG21, SEG22 option Press Low Fan button(∨) to enter SEG21 value. Press High Fan button(∧) to enter SEG22 value. Each time you press the button,  →  → ...  →  will be selected in rotation. |   SEG21 SEG22 |
| 18. Setting Heat mode  Press Mode button to be change to HEAT mode in the OFF status. |  |
| 19. Setting SEG23, SEG24 mode Press Low Fan button(∨) to enter SEG23 value. Press High Fan button(∧) to enter SEG24 value. Each time you press the button,  →  → ...  →  will be selected in rotation. |   SEG23 SEG24 |

Step 3. Check the option you have set

After setting an option, press  button to check whether the option code you input is correct or not.

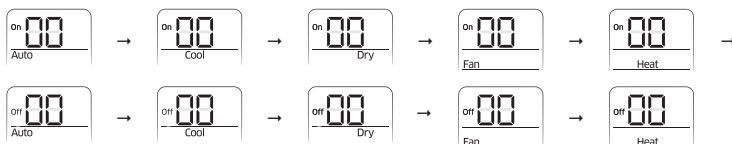

Step 4. Input option

Press the operation button  with the direction of remote control for set.
 For the correct option setting, you must input the option twice.

Step 5. Check operation

1. Reset the indoor unit by pressing the RESET button of indoor unit or outdoor unit.
2. Take the batteries out of the remote controller and insert them again and then press the operation button.

Setting an indoor unit address and installation option

Setting an indoor unit address (MAIN/RMC/MCU)

1. Check whether power is supplied or not.
 - When the indoor unit is not plugged in, there should be additional power supply in the indoor unit.
2. The panel(display) should be connected to an indoor unit to receive option.
3. Before installing the indoor unit, assign an address to the indoor unit according to the air conditioning system plan.
4. Assign an indoor unit address by wireless remote controller.
 - The initial setting status of indoor unit ADDRESS(MAIN/RMC/MCU port) is "0A0000-100000-200000-300000."

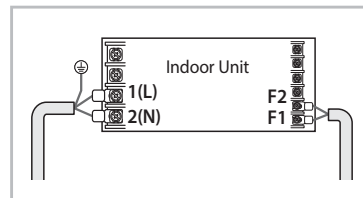

- Notes**
- Also set the MCU and Indoor units address by using Add-on > Change address on S-NET Pro 2. (For more information, see the S-NET Pro 2 Help.)
 - From SEG13 to SEG18 is for setting MCU address.
 - **MCU models that can set address:** MCU-S*NEK2N, MCU-S4NEK3N, MCU-S1NEK1N

Option No. : 0AXXXX-1XXXXX-2XXXXX-3XXXXX

| Option | SEG1 | | SEG2 | | SEG3 | | SEG4 | | SEG5 | | SEG6 | |
|------------------------|------------|---------|------------|---------|--------------------------|-------------------------------|----------------------------------|----------|-------------------------|---------|----------------------------------|---------------|
| Explanation | PAGE | | MODE | | Setting Main address | | 100-digit of indoor unit address | | 10-digit of indoor unit | | The unit digit of an indoor unit | |
| Indication and Details | Indication | Details | Indication | Details | Indication | Details | Indication | Details | Indication | Details | Indication | Details |
| | | 0 | | A | | 0 | No Main address | 0~9 | 100-digit | 0~9 | 10-digit | 0~9 |
| | | | | | 1 | Main address setting mode | | | | | | |
| Option | SEG7 | | SEG8 | | SEG9 | | SEG10 | | SEG11 | | SEG12 | |
| Explanation | PAGE | | | | Setting RMC address | | | | Group channel(*16) | | Group address | |
| Indication and Details | Indication | Details | | | Indication | Details | | | Indication | Details | Indication | Details |
| | 1 | | | | 0 | No RMC address | | | | | | |
| | | | | | 1 | RMC address setting mode | | | RMC1 | 0~F | RMC2 | 0~F |
| Option | SEG13 | | SEG14 | | SEG15 | | SEG16 | | SEG17 | | SEG18 | |
| Explanation | PAGE | | | | Setting MCU PORT address | | 10-digit of MCU address | | 1-digit of MCU | | MCU PORT address | |
| Indication and Details | Indication | Details | | | Indication | Details | Indication | Details | Indication | Details | Indication | Details |
| | 2 | | | | 0 | No MCU PORT | 0~1 | 10-digit | 0~9 | 1-digit | A~F | PORT Location |
| | | | | | 1 | MCU PORT address setting mode | | | | | | |



- ◆ When "A"~"F" is entered to SEG5~6, the indoor unit MAIN ADDRESS is not changed.
- ◆ If you set the SEG 3 as 0, the indoor unit will maintain the previous MAIN ADDRESS even if you input the option value of SEG5~6.
- ◆ If you set the SEG 9 as 0, the indoor unit will maintain previous RMC ADDRESS even if you input the option value of SEG11~12.
- ◆ You cannot set SEG11 and SEG12 as F value at the same time.
- ◆ If the indoor unit is connected to the MCU, you can set the SEG 15~18.
 - Ex.) If you want to set the indoor unit to 'A' port of MCU #1. (0A0000 – 100000 – 20101A -30000)

Setting an indoor unit installation option (suitable for the condition of each installation location)

1. Check whether power is supplied or not.
 - When the indoor unit is not plugged in, there should be additional power supply in the indoor unit.
2. The panel(display) should be connected to an indoor unit to receive option.
3. Set the installation option according to the installation condition of an air conditioner.
 - The default setting of an indoor unit installation option is "020010-100000- 200000-300000".
 - Individual control of a remote controller(SEG20) is the function that controls an indoor unit individually when there is more than one indoor unit.
4. Set the indoor unit option by wireless remote controller.

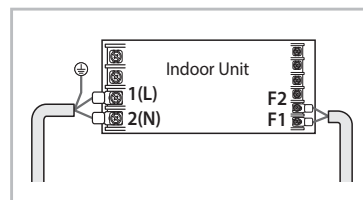

02 series installation option

| SEG1 | SEG2 | SEG3 | SEG4 | SEG5 | SEG6 |
|-------|---|--|---|-----------------------------|-----------------------|
| 0 | 2 | Evaporator Drying | Use of external room temperature sensor / Minimizing fan operation when thermostat is off | Use of central control | FAN RPM compensation |
| SEG7 | SEG8 | SEG9 | SEG10 | SEG11 | SEG12 |
| 1 | Use of drain pump | Use of hot water heater | - | EEV Step when heating stops | - |
| SEG13 | SEG14 | SEG15 | SEG16 | SEG17 | SEG18 |
| 2 | Use of external control | Setting the output of external control / External heater signal / Cooling operation signal / Free Cooling control signal | S-Plasma ion | Buzzer control | Hours of filter usage |
| SEG19 | SEG20 | SEG21 | SEG22 | SEG23 | SEG24 |
| 3 | Individual control of a remote controller | Heating setting compensation / Removing condensate water in heating mode | Adjusted EEV step of stopped unit during oil return /defrost mode. | Motion detect sensor | - |

- ◆ 1WAY/2WAY/4WAY MODEL : Drain pump(SEG8) will be set to 'USE + 3minute delay' even if the drain pump is set to 0.
- ◆ 1 WAY/2WAY/4WAY,DUCT MODEL : Number of hours using filter(SEG18) will be set to '1000hour' even if the SEG18 is set to except for 2 or 6.
- ◆ When setting the option other than above SEG values, the option will be set as "0".
- ◆ SEG5 central control option is basically set as 1 (Use), so you don't need to set the central control option additionally. However, if the central control is not connected but it doesn't indicate an error message, you need to set the central control option as 0 (Disuse) to exclude the indoor unit from the central control.
- ◆ The output of hot water heater in SEG9 is generated from the hot coil part of the terminal board in duct models.

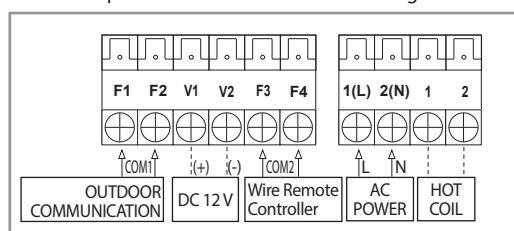

* The output of hot coil terminal is AC 220 V / 230 V (The same as Indoor Unit's input Power)

- ◆ The external output of SEG15 is generated by MIM-B14 connection. (Refer to the manual of MIM-B14.)

Setting an indoor unit address and installation option

■ 02 series installation option (Detailed)

Option No. : 02XXXX-1XXXXX-2XXXXX-3XXXXX

| Option | SEG1 | | SEG2 | | SEG3 | | SEG4 | | | SEG5 | | SEG6 | | | | | | | | | | | |
|------------------------|---|---------|--|---------|--|---------|---|---|---|-----------------------------|---------|-----------------------|---------|---|---|----------------------------------|------------------------------|------------------------------------|---------------------------|---|-----|---|------------------|
| Explanation | PAGE | | MODE | | Evaporator Drying | | Use of external room temperature sensor / Minimizing fan operation when thermostat is off | | | Use of central control | | FAN RPM compensation | | | | | | | | | | | |
| Indication and Details | Indication | Details | Indication | Details | Indication | Details | Indication | Details | | Indication | Details | Indication | Details | | | | | | | | | | |
| | | | | | | | | Use of External room temperature sensor | Minimizing fan operation when thermostat is off | | | | | | | | | | | | | | |
| | 0 | 2 | 0 | 2 | 0 | Disuse | 0 | Default | Default | 0 | Disuse | 0 | Disuse | 0 | Disuse | | | | | | | | |
| | | | | | | | 1 | Use | Disuse | | | | | | | | | | | | | | |
| | | | | | | | 2 | Disuse | Use (Heating) (*2) | | | | | | | | | | | | | | |
| | | | | | | | 3 | Use | Use (Heating) (*2) | | | | | | | | | | | | | | |
| | | | | | | | 4 | Disuse | Use (Cooling) (*2) | | | | | | | | | | | | | | |
| | | | | | | | 5 | Use | Use (Cooling) (*2) | | | | | | | | | | | | | | |
| | | | | | | | 4 | Use (10min) (*1) | 6 | | | | | | | Disuse | Use (Heating / Cooling) (*2) | 1 | Use | 1 | Use | 1 | RPM compensation |
| | | | | | | | | | 7 | | | | | | | Use | Use (Heating / Cooling) (*2) | | | | | | |
| 8 | | | | | | | | | Disuse | | | | | | | Use (Cooling Ultra Low Fan) (*2) | | | | | | | |
| 6 | | | | | | | Use (30min) (*1) | 9 | Use | | | | | | | Use (Cooling Ultra Low Fan) (*2) | 2 | High ceiling KIT (4way model only) | | | | | |
| | A | Disuse | Use (Heating / Cooling Ultra Low Fan) (*2) | | | | | | | | | | | | | | | | | | | | |
| | B | Use | Use (Heating / Cooling Ultra Low Fan) (*2) | | | | | | | | | | | | | | | | | | | | |
| Option | SEG7 | | SEG8 | | SEG9 | | SEG10 | | | SEG11 | | SEG12 | | | | | | | | | | | |
| Explanation | PAGE | | Use of drain pump | | Use of hot water heater | | | | | EEV Step when heating stops | | | | | | | | | | | | | |
| Indication and Details | Indication | Details | Indication | Details | Indication | Details | | | | Indication | Details | | | | | | | | | | | | |
| | | | | | | | | | | | | | | 0 | Disuse | 0 | Disuse | 0 | Default | | | | |
| | | | | | | | | | | | | | | 1 | Use | 1 | Use (*3) | 1 | Adjusted EEV Step setting | | | | |
| | | | | | | | | | | | | | | 2 | When an indoor unit stops, drain pump will operate for 3min | 3 | Use (*3) | | | | | | |
| Option | SEG13 | | SEG14 | | SEG15 | | SEG16 | | | SEG17 | | SEG18 | | | | | | | | | | | |
| Explanation | PAGE | | Use of external control | | Setting the output of external control / External heater signal / Cooling operation signal / Free Cooling control signal | | S-Plasma ion | | | Buzzer control | | Hours of filter usage | | | | | | | | | | | |
| Indication and Details | Indication | Details | Indication | Details | Indication | Details | 0 | | | Disuse | | | 2 | | 1000 Hour | | | | | | | | |
| | | | | | | | | | | | | | | | | | 0 | Disuse | 0 | External control (Thermo On) | | | |
| | | | | | | | | | | | | | | | | | 1 | "ON/OFF control" | 1 | External control (Operation On) | | | |
| | | | | | | | | | | | | | | | | | | | 2 | External heater signal (*4) | | | |
| | | | | | | | | | | | | | | | | | 2 | "OFF control" | 3 | External heater signal (*4) | | | |
| | | | | | | | | | | | | | | | | | | | 4 | Cooling operation signal (*5) | | | |
| | | | | | | | | | | | | | | | | | 3 | "Window ON/OFF control" | 5 | Free Cooling control (Cooling Thermo On) (*6) | | | |
| 6 | Free Cooling control (Cooling/Dry Thermo On) (*6) | | | | | | | | | | | | | | | | | | | | | | |
| | | 1 | | Use | | 1 | | Disuse buzzer | | 6 | | 2000 Hour | | | | | | | | | | | |

| Option | SEG19 | | SEG20 | | SEG21 | | | SEG22 | | SEG23 | | SEG24 |
|------------------------|------------|---------|---|-----------|--|------------------------------|---|--|---------|----------------------|---|-------|
| Explanation | PAGE | | Individual control of a remote controller | | Heating setting compensation / Removing condensate water in heating mode | | | Adjusted EEV step of stopped unit during oil return /defrost mode. | | Motion detect sensor | | |
| | Indication | Details | Indication | Details | Indication | Details | | Indication | Details | Indication | Details | |
| | | | | | | Heating Setting Compensation | Removing Condensate Water in Heating Mode | | | | | |
| Indication and Details | 3 | | 0 or 1 | channel 1 | 0 | Default | Disuse | 0 | Default | 0 | Disuse | |
| | | | | | 1 | 2°C | Disuse | | | 1 | Turn out in 30min. without motion | |
| | | | 2 | channel 2 | 2 | 5°C | Disuse | | | 2 | Turn out in 60min. without motion | |
| | | | | | 3 | Default | Use (*7) | | | 3 | Turn out in 120min. without motion | |
| | | | 3 | channel 3 | 3 | Default | Use (*7) | | | 4 | Turn out in 180min. without motion | |
| | | | | | 4 | 2°C | Use (*7) | | | 5 | Turn out in 30min. without motion or *advanced function | |
| | | | 4 | channel 4 | 4 | 2°C | Use (*7) | | | 6 | Turn out in 60min. without motion & *advanced function | |
| | | | | | 5 | 5°C | Use (*7) | | | 7 | Turn out in 120min. without motion & *advanced function | |
| | | | | | | | | | | 8 | Turn out in 180min. without motion & *advanced function | |
| | | | | | | | | | | | | |

* Advanced function: Controlling cooling/heating current or power saving with motion detect.

(*1) When Cooling or dry mode is off. The indoor fan operate in setting minutes.

(*2) Minimizing fan operation when thermostat is off
 - Fan operates for 20 seconds at an interval of 5 minutes in heat mode.
 - Fan stops or operates Ultra low in Cooling when thermostat is off.

(*3) 1: Fan is turned on continually when the hot water heater is turned on,
 3: Fan is turned off when the hot water heater is turned on with cooling only indoor unit
 Cooling only indoor unit: To use this option, install the Mode Select switch(MCM-C200) on the outdoor unit and fix it as cool mode.

(*4) When the following 2 or 3 is used as external heater On/Off signal, the signal for monitoring external contact control will not be output.
 2: Fan is turned on continually when the external heater is turned on,
 3: Fan is turned off when the external heater is turned on with cooling only indoor unit
 Cooling only indoor unit: To use this option, install the Mode Select switch(MCM-C200) on the outdoor unit and fix it as cool mode.
 - If Fan is set to off for cooling only indoor unit by setting the SEG9=3 or SEG15=3, you need to use an external sensor or wired remote controller sensor to detect indoor temperature exactly.

(*5) When indoor unit is in cooling or Dry mode, The output signal is "ON"

(*6) For free cooling control, Economizer controller is required.

(*7) If the air conditioner operates the heating mode immediately after finishing the cooling mode, the condensate water in the drain pan becomes water vapor by the heat of the indoor unit heat exchanger. Since the water vapor might be condensed on the indoor unit, which may fall into a living space, use this function to get rid of the water vapor out of the indoor unit by operating the fan (for maximum 20 minutes) even when the indoor unit is turned off after cooling mode is turned to heating mode .



◆ **Do not install the electronic heater in the flow channel of the indoor unit fan.**

Electronic heater should not be installed.

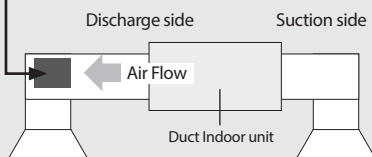

Setting an indoor unit address and installation option

■ 05 series installation option

| SEG1 | SEG2 | SEG3 | SEG4 | SEG5 | SEG6 |
|-------|--|--|---|---|--|
| 0 | 5 | Use of Auto Change Over for HR only in Auto mode / Use of Cooling only indoor unit of HR | (When setting SEG3) Standard heating temp. Offset | (When setting SEG3) Standard cooling temp. Offset | (When setting SEG3) Standard for mode change Heating → Cooling |
| SEG7 | SEG8 | SEG9 | SEG10 | SEG11 | SEG12 |
| 1 | (When setting SEG3) Standard for mode change Cooling → Heating | (When setting SEG3) Time required for mode change | Compensation option for Long pipe or height difference between indoor units | MTFC (*3) | - |
| SEG13 | SEG14 | SEG15 | SEG16 | SEG17 | SEG18 |
| 2 | - | - | - | - | Control variables when using hot water / external heater (*4) |
| SEG19 | SEG20 | SEG21 | SEG22 | SEG23 | SEG24 |
| 3 | - | - | - | Forced FAN Operation for Heating and Cooling | - |

■ 05 series installation option (Detailed)

Option No. : 05XXXX-1XXXXX-2XXXXX-3XXXXX

| Option | SEG1 | SEG2 | SEG3 | SEG4 | SEG5 | SEG6 | | | | | | |
|------------------------|--|--|--|--|--|--|------------|---------|--|---|---|-----------|
| Explanation | PAGE | MODE | Use of Auto Change Over for HR only in Auto mode / Use of Cooling only indoor unit of HR | (When setting SEG3) Standard heating temp. Offset | (When setting SEG3) Standard cooling temp. Offset | (When setting SEG3) Standard for mode change Heating → Cooling | | | | | | |
| Indication and Details | Indication | Details | Indication | Details | Indication | Details | Indication | Details | Indication | Details | Indication | Details |
| | | | | | | | | | | | | |
| | 1 | Use Auto Change Over for HR only | 1 | 0.5°C | 1 | 0.5°C | 1 | 1.5°C | | | | |
| | | | 2 | Use Cooling only indoor unit for HR | 2 | 1°C | 2 | 1°C | 2 | 2°C | | |
| | 3 | 1.5°C | | | 3 | 1.5°C | 3 | 2.5°C | | | | |
| | 4 | 2°C | | | 4 | 2°C | 4 | 3°C | | | | |
| | 5 | 2.5°C | | | 5 | 2.5°C | 5 | 3.5°C | | | | |
| | Option <td rowspan="2">SEG7 <td rowspan="2">SEG8 <td rowspan="2">SEG9 <td rowspan="2">SEG10 <td rowspan="2">SEG11 <td rowspan="2">SEG12 </td></td></td></td></td></td> | SEG7 <td rowspan="2">SEG8 <td rowspan="2">SEG9 <td rowspan="2">SEG10 <td rowspan="2">SEG11 <td rowspan="2">SEG12 </td></td></td></td></td> | SEG8 <td rowspan="2">SEG9 <td rowspan="2">SEG10 <td rowspan="2">SEG11 <td rowspan="2">SEG12 </td></td></td></td> | SEG9 <td rowspan="2">SEG10 <td rowspan="2">SEG11 <td rowspan="2">SEG12 </td></td></td> | SEG10 <td rowspan="2">SEG11 <td rowspan="2">SEG12 </td></td> | SEG11 <td rowspan="2">SEG12 </td> | SEG12 | | | | | |
| Explanation | | | | | | | | PAGE | (When setting SEG3) Standard for mode change Cooling → Heating | (When setting SEG3) Time required for mode change | Compensation option for Long pipe or height difference between indoor units | MTFC (*3) |
| | Indication | Details | Indication | Details | Indication | Details | Indication | | | | | |
| 1 | | | | | | | | 0 | Default | 0 | 1°C | 0 |
| | 1 | 1.5°C | 1 | 7min | 1 | (*1) Height difference is more than 30m or (*2) Distance is longer than 110m | | | | | | |
| | 2 | 2°C | 2 | 9min | | | | | | | | |
| | 3 | 2.5°C | 3 | 11min | | | | | | | | |
| | 4 | 3°C | 4 | 13min | 2 | (*1) Height difference is 15~30m or (*2) Distance is 50~110m | | | | | | |
| | 5 | 3.5°C | 5 | 15min | | | | | | | | |
| | 6 | 4°C | 6 | 20min | | | | | | | | |
| 7 | 4.5°C | 7 | 30min | 2 | | | Use | | | | | |

| Option | SEG13 | SEG14 | SEG15 | SEG16 | SEG17 | SEG18 | | | |
|------------------------|----------------|-------------------------|-------|-------|---|---|-----------------------------|-------------------------------|-------------------------|
| Explanation | | | | | | Control variables when using hot water / external heater (*4) | | | |
| Indication and Details | Indication | Details | | | | Indication | Details | | |
| | | | | | | | Set temp. for heater On/Off | Delay time for heater On | |
| | 2 | | | | | | 0 | At the same time as thermo on | No delay |
| | | | | | | | 1 | At the same time as thermo on | 10 minutes |
| | | | | | | | 2 | At the same time as thermo on | 20 minutes |
| | | | | | | | 3 | 1.5 °C | No delay |
| | | | | | | | 4 | 1.5 °C | 10 minutes |
| | | | | | | | 5 | 1.5 °C | 20 minutes |
| | | | | | | | 6 | 3.0 °C | No delay |
| | | | | | | | 7 | 3.0 °C | 10 minutes |
| | | | | | | | 8 | 3.0 °C | 20 minutes |
| | | | | | | | 9 | 4.5 °C | No delay |
| | | | | | | | A | 4.5 °C | 10 minutes |
| | | | | | | | B | 4.5 °C | 20 minutes |
| | | | | | | | C | 6.0 °C | No delay |
| D | 6.0 °C | 10 minutes | | | | | | | |
| E | 6.0 °C | 20 minutes | | | | | | | |
| Option | SEG19 | SEG20 | SEG21 | SEG22 | SEG23 | SEG24 | | | |
| Explanation | PAGE | | | | Forcing FAN Operation for Heating and Cooling | | | | |
| Indication and Details | Indication | Details | | | Indication | Details | | | |
| | | | | | | Cooling Fan Setting | Heating Fan Setting | | |
| | 3 | | | | | | 0 | Disuse | Disuse |
| | | | | | | | 1 | Disuse | Use (Fan: User setting) |
| | | | | | | | 2 | Disuse | Use (Fan: High) |
| | | | | | | | 3 | Disuse | Use (Fan: Low) |
| | | | | | | | 4 | Use (Fan: User setting) | Disuse |
| | | | | | | | 5 | Use (Fan: User setting) | Use (Fan: User setting) |
| | | | | | | | 6 | Use (Fan: User setting) | Use (Fan: High) |
| | | | | | | | 7 | Use (Fan: User setting) | Use (Fan: Low) |
| | | | | | | | 8 | Use (Fan: High) | Disuse |
| | | | | | | | 9 | Use (Fan: High) | Use (Fan: User setting) |
| | | | | | | | A | Use (Fan: High) | Use (Fan: High) |
| | | | | | | | B | Use (Fan: High) | Use (Fan: Low) |
| | | | | | | | C | Use (Fan: Low) | Disuse |
| D | Use (Fan: Low) | Use (Fan: User setting) | | | | | | | |
| E | Use (Fan: Low) | Use (Fan: High) | | | | | | | |
| F | Use (Fan: Low) | Use (Fan: Low) | | | | | | | |

^{(*)1} Height difference : The difference of the height between the corresponding indoor unit and the indoor unit installed at the lowest place.
For example, When the indoor unit is installed 40m higher than the indoor unit installed at the lowest place, select the option "1".

^{(*)2} Distance : The difference between the pipe length of the indoor unit installed at farthest place from an outdoor unit and the pipe length of the corresponding indoor unit from an outdoor unit.
For example, when the farthest pipe length is 100 m(328 ft.) and the corresponding indoor unit is 40 m away from an outdoor unit, select the option "2". (100 - 40 = 60m)

^{(*)3} For MTFC option, MTFC(Multi Tenant Function Controller) kit is required.

^{(*)4} Heater operation when the SEG9 of O2 series installation option is set to using hot water heater or when SEG15 is set to using external heater

e.g. 1) Setting O2 series SEG9 = "1" / Setting O5 series SEG18 = "0": Hot water heater is turned on at the same time as the heating thermostat is on, and turned off when the heating thermostat is off.

e.g. 2) Setting O2 series SEG15 = "2" / Setting O5 series SEG18 = "A": Room temp. ≤ set temp. + f(heating compensation temp.)

- External heater is turned on when the temperature is maintained as 4.5 °C for 10 minutes. Room temp. > set temp. + f(heating compensation temp.)

- External heater is turned off when the temperature is maintained as 4.5 °C + 1 °C (1 °C is the Hysteresis for On/Off selection.)

Setting an indoor unit address and installation option

SEG 3, 4, 5, 6, 8, 9 additional information



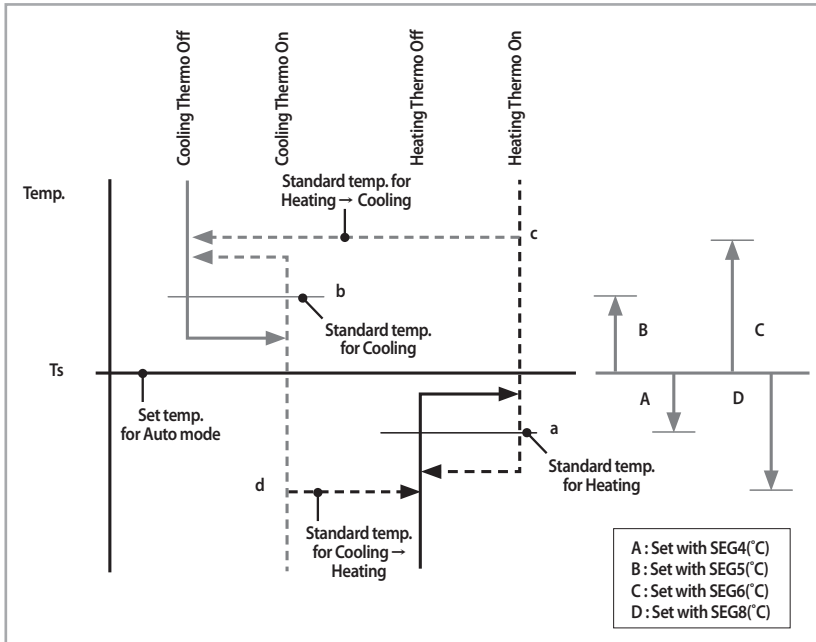

When the SEG 3 is set as "1" and follow Auto Change Over for HR only operation, it will operate as follows.



Cooling/Heating mode can be changed when Thermo Off status is maintained during the time with SEG9.

Changing a particular option

You can change each digit of set option.

| Option | SEG1 | | SEG2 | | SEG3 | | SEG4 | | SEG5 | | SEG6 | |
|---------------------------|------------|---------|---|---------|---|---------|---|---------|--|---------|---|---------|
| Explanation | PAGE | | MODE | | The option mode you want to change | | The tens' digit of an option SEG you will change | | The unit digit of an option SEG you will change | | Changed value | |
| Remote Controller Display | | |  | |  | |  | |  | |  | |
| Indication and Details | Indication | Details | Indication | Details | Indication | Details | Indication | Details | Indication | Details | Indication | Details |
| | 0 | | D | | Option mode | 1~6 | Tens' digit of SEG | 0~9 | Unit digit of SEG | 0~9 | The changed value | 0~F |

- Note**
- When changing a digit of an indoor unit address setting option, set the SEG3 as 'A'.
 - When changing a digit of indoor unit installation option, set the SEG3 as '2'.

Ex) When setting the 'buzzer control' into disuse status.

| Option | SEG1 | | SEG2 | | SEG3 | | SEG4 | | SEG5 | | SEG6 | |
|-------------|------|--|------|--|------------------------------------|--|--|--|---|--|---------------|--|
| Explanation | PAGE | | MODE | | The option mode you want to change | | The tens' digit of an option SEG you will change | | The unit digit of an option SEG you will change | | Changed value | |
| Indication | 0 | | D | | 2 | | 1 | | 7 | | 1 | |

Memo

Memo

QUESTIONS OR COMMENTS?

| COUNTRY | CALL | OR VISIT US ONLINE AT |
|----------------|---|--|
| UK | 0330 SAMSUNG (7267864) | www.samsung.com/uk/support |
| IRELAND (EIRE) | 0818 717100 | www.samsung.com/ie/support |
| GERMANY | 06196 77 555 77 *OTH | www.samsung.com/de/support |
| FRANCE | 01 48 63 00 00 | www.samsung.com/fr/support |
| ITALIA | 800-SAMSUNG (800.7267864) | www.samsung.com/it/support |
| SPAIN | 0034902172678 | www.samsung.com/es/support |
| PORTUGAL | 808 207 267 | www.samsung.com/pt/support |
| LUXEMBURG | 261 03 710 | www.samsung.com/be_fr/support |
| NETHERLANDS | 088 90 90 100 | www.samsung.com/nl/support |
| BELGIUM | 02-201-24-18 | www.samsung.com/be/support (Dutch) www.samsung.com/be_fr/support (French) |
| NORWAY | 21629099 | www.samsung.com/no/support |
| DENMARK | 707 019 70 | www.samsung.com/dk/support |
| FINLAND | 030-6227 515 | www.samsung.com/fi/support |
| SWEDEN | 0771 726 786 | www.samsung.com/se/support |
| POLAND | 801-172-678* lub +48 22 607-93-33* Dedykowana infolinia do obsługi zapytań dotyczących telefonów komórkowych: 801-672-678* lub +48 22 607-93-33* * (opłata według taryfy operatora) | http://www.samsung.com/pl/support/ |
| HUNGARY | 0680SAMSUNG (0680-726-7864) | www.samsung.com/hu/support |
| AUSTRIA | 0800-SAMSUNG (0800-7267864) [Only for KNOX customers] 0800 400848 [Only for Premium HA] 0800-366661 [Only for Dealers] 0810-112233 [Only for E-Store] 0800 100 232 | www.samsung.com/at/support |
| SWITZERLAND | 0800 726 78 64 (0800-SAMSUNG) | www.samsung.com/ch/support (German) www.samsung.com/ch_fr/support (French) |
| CZECH | 800 - SAMSUNG (800-726786) | www.samsung.com/cz/support |
| SLOVAKIA | 0800 - SAMSUNG (0800-726786) | www.samsung.com/sk/support |
| CROATIA | 072 726 786 | www.samsung.com/hr/support |
| BOSNIA | 055 233 999 | www.samsung.com/support |
| MONTENEGRO | 020 405 888 | www.samsung.com/support |
| SLOVENIA | 080 697 267 (brezplačna številka) | www.samsung.com/si/support |
| SERBIA | 011 321 6899 | www.samsung.com/rs/support |
| ALBANIA | 045 620 202 | www.samsung.com/al/support |
| BULGARIA | *3000 Цена в мрежата 0800 111 31, Безплатна телефонна линия | www.samsung.com/bg/support |
| ROMANIA | *8000 (apel in retea) 08008-726-78-64 (08008-SAMSUNG) Apel GRATUIT | www.samsung.com/ro/support |
| CYPRUS | 8009 4000 only from landline, toll free | www.samsung.com/gr/support |
| GREECE | 80111-SAMSUNG (80111 726 7864) only from land line (+30) 210 6897691 from mobile and land line | |
| LITHUANIA | 8-800-77777 | www.samsung.com/lt/support |
| LATVIA | 8000-7267 | www.samsung.com/lv/support |
| ESTONIA | 800-7267 | www.samsung.com/ee/support |

SAMSUNG ELECTRONICS CO., LTD .

107, Hanamsandan 6beon-ro, Gwangsan-gu, Gwangju-si, Korea 62218

Samsung Electronics

Service Department

PO Box 12987, Blackrock, Co. Dublin. Ireland

or

Blackbushe Business Park, Yateley, GU46 6GG. UK



DB68-03568A-10

