

# TOSHIBA

Leading Innovation >>>

## AIR CONDITIONER (MULTI TYPE) Installation Manual



### Indoor Unit

Model name:

Concealed Duct High Static Pressure Type

## MMD-AP0726HP-E

## MMD-AP0966HP-E

For commercial use

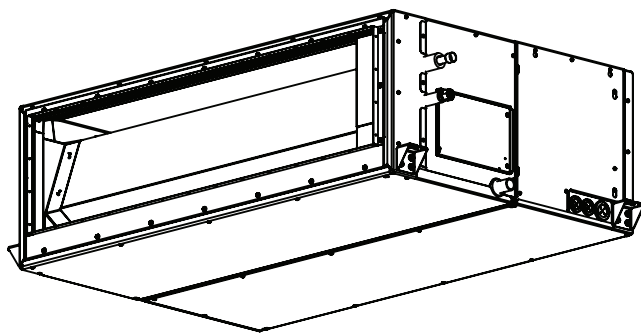

**Original instruction**

- Please read this Installation Manual carefully before installing the Air Conditioner.
- This Manual describes the installation method of the indoor unit.
  - For installation of the outdoor unit, follow the Installation Manual attached to the outdoor unit.

**ADOPTION OF NEW REFRIGERANT**

This Air Conditioner uses R410A an environmentally friendly refrigerant.

**Contents**

<b>1</b>	<b>Precautions for safety</b> .....	<b>3</b>
<b>2</b>	<b>Accessory parts</b> .....	<b>7</b>
<b>3</b>	<b>Selection of installation place</b> .....	<b>7</b>
<b>4</b>	<b>Installation</b> .....	<b>9</b>
<b>5</b>	<b>Drain piping</b> .....	<b>10</b>
<b>6</b>	<b>Duct design</b> .....	<b>13</b>
<b>7</b>	<b>Refrigerant piping</b> .....	<b>14</b>
<b>8</b>	<b>Electrical connection</b> .....	<b>15</b>
<b>9</b>	<b>Applicable controls</b> .....	<b>18</b>
<b>10</b>	<b>Test run</b> .....	<b>20</b>
<b>11</b>	<b>Maintenance</b> .....	<b>20</b>
<b>12</b>	<b>Troubleshooting</b> .....	<b>21</b>
<b>13</b>	<b>Specifications</b> .....	<b>26</b>

Thank you for purchasing this Toshiba air conditioner.

Please read carefully through these instructions that contain important information which complies with the "Machinery" Directive (Directive 2006/42/EC), and ensure that you understand them.

After completing the installation work, hand over this Installation Manual as well as the Owner's Manual provided to the user, and ask the user to keep them in a safe place for future reference.

**Generic Denomination: Air Conditioner**

**Definition of Qualified Installer or Qualified Service Person**

The air conditioner must be installed, maintained, repaired and removed by a qualified installer or qualified service person. When any of these jobs is to be done, ask a qualified installer or qualified service person to do them for you. A qualified installer or qualified service person is an agent who has the qualifications and knowledge described in the following table.

Agent	Qualifications and knowledge which the agent must have
Qualified installer	<ul style="list-style-type: none"> <li>• The qualified installer is a person who installs, maintains, relocates and removes the air conditioners made by Toshiba Carrier Corporation. He or she has been trained to install, maintain, relocate and remove the air conditioners made by Toshiba Carrier Corporation or, alternatively, he or she has been instructed in such operations by an individual or individuals who have been trained and is thus thoroughly acquainted with the knowledge related to these operations.</li> <li>• The qualified installer who is allowed to do the electrical work involved in installation, relocation and removal has the qualifications pertaining to this electrical work as stipulated by the local laws and regulations, and he or she is a person who has been trained in matters relating to electrical work on the air conditioners made by Toshiba Carrier Corporation or, alternatively, he or she has been instructed in such matters by an individual or individuals who have been trained and is thus thoroughly acquainted with the knowledge related to this work.</li> <li>• The qualified installer who is allowed to do the refrigerant handling and piping work involved in installation, relocation and removal has the qualifications pertaining to this refrigerant handling and piping work as stipulated by the local laws and regulations, and he or she is a person who has been trained in matters relating to refrigerant handling and piping work on the air conditioners made by Toshiba Carrier Corporation or, alternatively, he or she has been instructed in such matters by an individual or individuals who have been trained and is thus thoroughly acquainted with the knowledge related to this work.</li> <li>• The qualified installer who is allowed to work at heights has been trained in matters relating to working at heights with the air conditioners made by Toshiba Carrier Corporation or, alternatively, he or she has been instructed in such matters by an individual or individuals who have been trained and is thus thoroughly acquainted with the knowledge related to this work.</li> </ul>
Qualified service person	<ul style="list-style-type: none"> <li>• The qualified service person is a person who installs, repairs, maintains, relocates and removes the air conditioners made by Toshiba Carrier Corporation. He or she has been trained to install, repair, maintain, relocate and remove the air conditioners made by Toshiba Carrier Corporation or, alternatively, he or she has been instructed in such operations by an individual or individuals who have been trained and is thus thoroughly acquainted with the knowledge related to these operations.</li> <li>• The qualified service person who is allowed to do the electrical work involved in installation, repair, relocation and removal has the qualifications pertaining to this electrical work as stipulated by the local laws and regulations, and he or she is a person who has been trained in matters relating to electrical work on the air conditioners made by Toshiba Carrier Corporation or, alternatively, he or she has been instructed in such matters by an individual or individuals who have been trained and is thus thoroughly acquainted with the knowledge related to this work.</li> <li>• The qualified service person who is allowed to do the refrigerant handling and piping work involved in installation, repair, relocation and removal has the qualifications pertaining to this refrigerant handling and piping work as stipulated by the local laws and regulations, and he or she is a person who has been trained in matters relating to refrigerant handling and piping work on the air conditioners made by Toshiba Carrier Corporation or, alternatively, he or she has been instructed in such matters by an individual or individuals who have been trained and is thus thoroughly acquainted with the knowledge related to this work.</li> <li>• The qualified service person who is allowed to work at heights has been trained in matters relating to working at heights with the air conditioners made by Toshiba Carrier Corporation or, alternatively, he or she has been instructed in such matters by an individual or individuals who have been trained and is thus thoroughly acquainted with the knowledge related to this work.</li> </ul>

### Definition of Protective Gear

When the air conditioner is to be transported, installed, maintained, repaired or removed, wear protective gloves and 'safety' work clothing.

In addition to such normal protective gear, wear the protective gear described below when undertaking the special work detailed in the following table.

Failure to wear the proper protective gear is dangerous because you will be more susceptible to injury, burns, electric shocks and other injuries.

Work undertaken	Protective gear to wear
All types of work	Protective gloves 'Safety' working clothing
Electrical-related work	Gloves to provide protection for electricians and from heat Insulating shoes Clothing to provide protection from electric shock
Work at heights (50 cm or more)	Helmets for use in industry
Transportation of heavy objects	Shoes with additional protective toe cap
Repair of outdoor unit	Gloves to provide protection for electricians and from heat



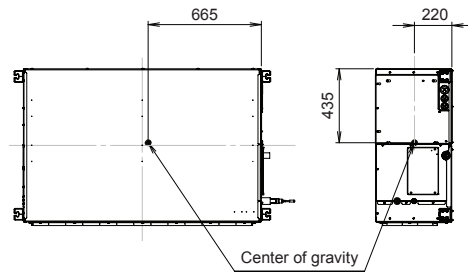

### Center of gravity

(Unit: mm)

Use forklift to carry in the air conditioner units and use winch or hoist at installation of them.



### Warning indications on the air conditioner unit

Warning indication	Description
 <p><b>WARNING</b> <b>ELECTRICAL SHOCK HAZARD</b> Disconnect all remote electric power supplies before servicing.</p>	<p><b>WARNING</b> <b>ELECTRICAL SHOCK HAZARD</b> Disconnect all remote electric power supplies before servicing.</p>
 <p><b>WARNING</b> Moving parts. Do not operate unit with grille removed. Stop the unit before the servicing.</p>	<p><b>WARNING</b> Moving parts. Do not operate unit with grille removed. Stop the unit before the servicing.</p>
 <p><b>CAUTION</b> High temperature parts. You might get burned when removing this panel.</p>	<p><b>CAUTION</b> High temperature parts. You might get burned when removing this panel.</p>
 <p><b>CAUTION</b> Do not touch the aluminum fins of the unit. Doing so may result in injury.</p>	<p><b>CAUTION</b> Do not touch the aluminium fins of the unit. Doing so may result in injury.</p>
 <p><b>CAUTION</b> <b>BURST HAZARD</b> Open the service valves before the operation, otherwise there might be the burst.</p>	<p><b>CAUTION</b> <b>BURST HAZARD</b> Open the service valves before the operation, otherwise there might be the burst.</p>

# 1 Precautions for safety

The manufacturer shall not assume any liability for the damage caused by not observing the description of this manual.

## WARNING

### General

- Before starting to install the air conditioner, read through the Installation Manual carefully, and follow its instructions to install the air conditioner.
  - Only a qualified installer or service person is allowed to do installation work. Inappropriate installation may result in water leakage, electric shock or fire.
  - Do not use any refrigerant different from the one specified for complement or replacement. Otherwise, abnormally high pressure may be generated in the refrigeration cycle, which may result in a failure or explosion of the product or an injury to your body.
  - Before opening the electrical control box cover of the indoor unit or service panel of the outdoor unit, set the circuit breaker to the OFF position. Failure to set the circuit breaker to the OFF position may result in electric shocks through contact with the interior parts. Only a qualified installer(\*1) or qualified service person(\*1) is allowed to remove the electrical control box cover of the indoor unit or service panel of the outdoor unit and do the work required.
  - Before carrying out the installation, maintenance, repair or removal work, set the circuit breaker to the OFF position. Otherwise, electric shocks may result.
  - Place a "Work in progress" sign near the circuit breaker while the installation, maintenance, repair or removal work is being carried out. There is a danger of electric shocks if the circuit breaker is set to ON by mistake.
- Only a qualified installer(\*1) or qualified service person(\*1) is allowed to undertake work at heights using a stand of 50 cm or more or to remove the intake grille of the indoor unit to undertake work.
  - Wear protective gloves and safety work clothing during installation, servicing and removal.
  - Do not touch the aluminium fin of the unit. You may injure yourself if you do so. If the fin must be touched for some reason, first put on protective gloves and safety work clothing, and then proceed.
  - Before opening the inspection opening, set the circuit breaker to the OFF position. Failure to set the circuit breaker to the OFF position may result in injury through contact with the rotation parts. Only a qualified installer (\*1) or qualified service person(\*1) is allowed to remove the inspection opening and do the work required.
  - When work is performed at heights, use a ladder which complies with the ISO 14122 standard, and follow the procedure in the ladder's instructions. Also wear a helmet for use in industry as protective gear to undertake the work.
  - Before cleaning the filter (sold separately) or other parts of the outdoor unit, set the circuit breaker to OFF without fail, and place a "Work in progress" sign near the circuit breaker before proceeding with the work.
  - Before working at heights, put a sign in place so that no-one will approach the work location, before proceeding with the work. Parts and other objects may fall from above, possibly injuring a person below. While carrying out the work, wear a helmet for protection from falling objects.
  - The refrigerant used by this air conditioner is the R410A.
  - The air conditioner must be transported in stable condition. If any part of the product is broken, contact the dealer.

- 
- When the air conditioner must be transported by hand, carry it by four or more people.
  - Do not move or repair any unit by yourself. There is high voltage inside the unit. You may get electric shock when removing the cover and main unit.
  - This appliance is intended to be used by expert or trained users in shops, in light industry and on farms, or for commercial use by lay persons.

### **Selection of installation location**

- When the air conditioner is installed in a small room, provide appropriate measures to ensure that the concentration of refrigerant leakage occur in the room does not exceed the critical level.
- Do not install in a location where flammable gas leaks are possible. If the gas leak and accumulate around the unit, it may ignite and cause a fire.
- To transport the air conditioner, wear shoes with additional protective toe caps.
- To transport the air conditioner, do not take hold of the bands around the packing carton. You may injure yourself if the bands should break.
- Install the indoor unit at least 2.5 m above the floor level since otherwise the users may injure themselves or receive electric shocks if they poke their fingers or other objects into the indoor unit while the air conditioner is running.
- Do not place any combustion appliance in a place where it is directly exposed to the wind of air conditioner, otherwise it may cause imperfect combustion.

---

### **Installation**

- Suction duct length must be longer than 850 mm.
- When the indoor unit is to be suspended, the designated hanging bolts (M10 or W3/8) and nuts (M10 or W3/8) must be used.
- Install the air conditioner securely in a location where the base can sustain the weight adequately. If the strength is not enough, the unit may fall down resulting in injury.
- Follow the instructions in the Installation Manual to install the air conditioner. Failure to follow these instructions may cause the product to fall down or topple over or give rise to noise, vibration, water leakage or other trouble.
- Carry out the specified installation work to guard against the possibility of high winds and earthquake. If the air conditioner is not installed appropriately, a unit may topple over or fall down, causing an accident.
- If refrigerant gas has leaked during the installation work, ventilate the room immediately. If the leaked refrigerant gas comes in contact with fire, noxious gas may generate.
- Use forklift to carry in the air conditioner units and use winch or hoist at installation of them.
- Helmet must be worn to protect your head from falling objects. Especially, when you work under an inspection opening, helmet must be worn to protect your head from falling objects from the opening.

### **Refrigerant piping**

- Install the refrigerant pipe securely during the installation work before operating the air conditioner. If the compressor is operated with the valve open and without refrigerant pipe, the compressor sucks air and the refrigeration cycles is over pressurized, which may cause a injury.

- Tighten the flare nut with a torque wrench in the specified manner. Excessive tightening of the flare nut may cause a crack in the flare nut after a long period, which may result in refrigerant leakage.
- After the installation work, confirm that refrigerant gas does not leak. If refrigerant gas leaks into the room and flows near a fire source, such as a cooking range, noxious gas may be generated.
- When the air conditioner has been installed or relocated, follow the instructions in the Installation Manual and purge the air completely so that no gases other than the refrigerant will be mixed in the refrigerating cycle. Failure to purge the air completely may cause the air conditioner to malfunction.
- Nitrogen gas must be used for the airtight test.
- The charge hose must be connected in such a way that it is not slack.

### **Electrical wiring**

- Only a qualified installer(\*1) or qualified service person(\*1) is allowed to carry out the electrical work of the air conditioner. Under no circumstances must this work be done by an unqualified individual since failure to carry out the work properly may result in electric shocks and/or electrical leaks.
- To connect the electrical wires, repair the electrical parts or undertake other electrical jobs, wear gloves to provide protection for electricians, insulating shoes and clothing to provide protection from electric shocks.  
Failure to wear this protective gear may result in electric shocks.
- Use wiring that meets the specifications in the Installation Manual and the stipulations in the local regulations and laws. Use of wiring which does not meet the specifications may give rise to electric shocks, electrical leakage, smoking and/or a fire.
- Connect earth wire. (Grounding work)  
Incomplete grounding causes an electric shock.

- Do not connect earth wires to gas pipes, water pipes, and lightning conductor or telephone earth wires.
- After completing the repair or relocation work, check that the earth wires are connected properly.
- Install a circuit breaker that meets the specifications in the installation manual and the stipulations in the local regulations and laws.
- Install the circuit breaker where it can be easily accessed by the agent.
- When installing the circuit breaker outdoors, install one which is designed to be used outdoors.
- Under no circumstances the power wire must not be extended. Connection trouble in the places where the wire is extended may give rise to smoking and/or a fire.
- Electrical wiring work shall be conducted according to law and regulation in the community and installation manual. Failure to do so may result in electrocution or short circuit.

### **Test run**

- Before operating the air conditioner after having completed the work, check that the electrical control box cover of the indoor unit and service panel of the outdoor unit are closed, and set the circuit breaker to the ON position. You may receive an electric shock if the power is turned on without first conducting these checks.
- If there is any kind of trouble (such as an error display has appeared, smell of burning, abnormal sounds, the air conditioner fails to cool or heat or water is leaking) has occurred in the air conditioner, do not touch the air conditioner yourself but set the circuit breaker to the OFF position, and contact a qualified service person. Take steps to ensure that the power will not be turned on (by marking "out of service" near the circuit breaker, for instance) until qualified service person arrives. Continuing to use the air conditioner in the trouble status may cause mechanical problems to escalate or result in electric shocks or other trouble.

- 
- After the work has finished, use an insulation tester set (500 V Megger) to check the resistance is 1 MΩ or more between the charge section and the non-charge metal section (Earth section). If the resistance value is low, a disaster such as a leak or electric shock is caused at user's side.
  - Upon completion of the installation work, check for refrigerant leaks and check the insulation resistance and water drainage. Then conduct a test run to check that the air conditioner is operating properly.

#### **Explanations given to user**

- Upon completion of the installation work, tell the user where the circuit breaker is located. If the user does not know where the circuit breaker is, he or she will not be able to turn it off in the event that trouble has occurred in the air conditioner.
- After the installation work, follow the Owner's Manual to explain to the customer how to use and maintain the unit.

#### **Relocation**

- Only a qualified installer(\*1) or qualified service person(\*1) is allowed to relocate the air conditioner. It is dangerous for the air conditioner to be relocated by an unqualified individual since a fire, electric shocks, injury, water leakage, noise and/or vibration may result.
  - When carrying out the pump-down work shut down the compressor before disconnecting the refrigerant pipe. Disconnecting the refrigerant pipe with the service valve left open and the compressor still operating will cause air or other gas to be sucked in, raising the pressure inside the refrigeration cycle to an abnormally high level, and possibly resulting in rupture, injury or other trouble.
- 

---

#### **⚠ CAUTION**

##### **New refrigerant air conditioner installation**

- **This air conditioner adopts the new HFC refrigerant (R410A) which does not destroy ozone layer.**
- The characteristics of R410A refrigerant are; easy to absorb water, oxidizing membrane or oil, and its pressure is approx. 1.6 times higher than that of refrigerant R22. Accompanied with the new refrigerant, refrigerating oil has also been changed. Therefore, do not let water, dust, former refrigerant, or refrigerating oil enter the refrigerating cycle during installation work.
- To prevent charging an incorrect refrigerant and refrigerating oil, the sizes of connecting sections of charging port of the main unit and installation tools are changed from those for the conventional refrigerant.
- Accordingly the exclusive tools are required for the new refrigerant (R410A).
- For connecting pipes, use new and clean piping designed for R410A, and please care so that water or dust does not enter.

##### **To disconnect the appliance from main power supply.**

- This appliance must be connected to the main power supply by means of a switch with a contact separation of at least 3 mm.







##### **The installation fuse (all types can be used) must be used for the power supply line of this conditioner.**

---

(\*1) Refer to the "Definition of Qualified Installer or Qualified Service Person."

## 2 Accessory parts

### ■ Accessory parts

Part name	Q'ty	Shape	Usage
Installation Manual	1	This manual	(Hand over to customers) (For other languages that do not appear in this Installation Manual, please refer to the enclosed CD-R.)
CD-ROM	1	—	Installation Manual
Heat insulating pipe	2	 (200×200×6t)	For heat insulation of gas pipe and liquid pipe connecting section
Washer	8		For hanging-down unit
Hose band	1		For connecting drain pipe
Flexible hose	1		For adjusting center of drain pipe
Heat insulator	1	 (220×300×10t)	For heat insulation of drain connecting section
Seal material	3	 (45×45×3t)	For sealing of wire connecting port

## 3 Selection of installation place

### Avoid installing in the following places

Select a location for the indoor unit where the cool or warm air will circulate evenly.

Avoid installation in the following kinds of locations.

- Saline area (coastal area)
- Locations with acidic or alkaline atmospheres (such as areas with hot springs, factories where chemicals or pharmaceuticals are made and places where the exhaust air from combustion appliances will be sucked into the unit).  
Doing so may cause the heat exchanger (its aluminum fins and copper pipes) and other parts to become corroded.
- Locations with atmospheres with mist of cutting oil or other types of machine oil.  
Doing so may cause the heat exchanger to become corroded, mists caused by the blockage of the heat exchanger to be generated, the plastic parts to be damaged, the heat insulators to peel off, and other such problems to result.
- Places where iron or other metal dust is present. If iron or other metal dust adheres to or collects on the interior of the air conditioner, it may spontaneously combust and start a fire.
- Locations where vapors from food oils are formed (such as kitchens where food oils are used).  
Blocked filters may cause the air conditioner's performance to deteriorate, condensation to form, the plastic parts to be damaged, and other such problems to result.
- Locations near obstructions such as ventilation openings or lighting fixtures where the flow of the blown air will be disrupted (a disruption of the air flow may cause the air conditioner's performance to deteriorate or the unit to shut down).
- Locations where an in-house power generator is used for the power supply.  
The power line frequency and voltage may fluctuate, and the air conditioner may not work properly as a result.
- On truck cranes, ships or other moving conveyances.
- The air conditioner must not be used for special applications (such as for storing food, plants, precision instruments or art works).  
(The quality of the items stored may be degraded.)
- Locations where high frequencies are generated (by inverter equipment, in-house power generators, medical equipment or communication equipment).  
(Malfunctioning or control trouble in the air conditioner or noise may adversely affect the equipment's operation.)
- Locations where there is anything under the unit installed that would be compromised by wetness.  
(If the drain has become blocked or when the humidity is over 80 %, condensation from the indoor unit will drip, possibly causing damage to anything underneath.)
- In the case of the wireless type of system, rooms with the inverter type of fluorescent lighting or locations exposed to direct sunlight.  
(The signals from the wireless remote controller may not be sensed.)
- Locations where organic solvents are being used.
- The air conditioner cannot be used for liquefied carbonic acid cooling or in chemical plants.
- Location near doors or windows where the air conditioner may come into contact with high-temperature, highhumidity outdoor air.  
(Condensation may occur as a result.)
- Locations where special sprays are used frequently.
- Places with poor ventilation.



## ■ Installation under high-humidity atmosphere

In some cases including the rainy season, especially inside of the ceiling may become high-humidity atmosphere (dew-point temperature: 23 °C or higher).

1. Installation to inside of the ceiling with tiles on the roof
  2. Installation to inside of the ceiling with slated roof
  3. Installation to a place where inside of the ceiling is used for pathway to intake the fresh air
  4. Installation to a kitchen
- In the above cases, additionally attach the heat insulator to all positions of the air conditioner, which come to contact with the high-humidity atmosphere. In this case, arrange the side plate (Check port) so that it is easily removed.
  - Apply also a sufficient heat insulation to the duct and connecting part of the duct.

<b>[Reference]</b>	Condensation test conditions
	Indoor side: 27 °C dry bulb temperature 24 °C wet bulb temperature
	Air volume: Low air volume, operation time 4 hours

## ■ Installation space

(Unit: mm)

Reserve sufficient space required for installation or service work.

### Space required for installation and servicing

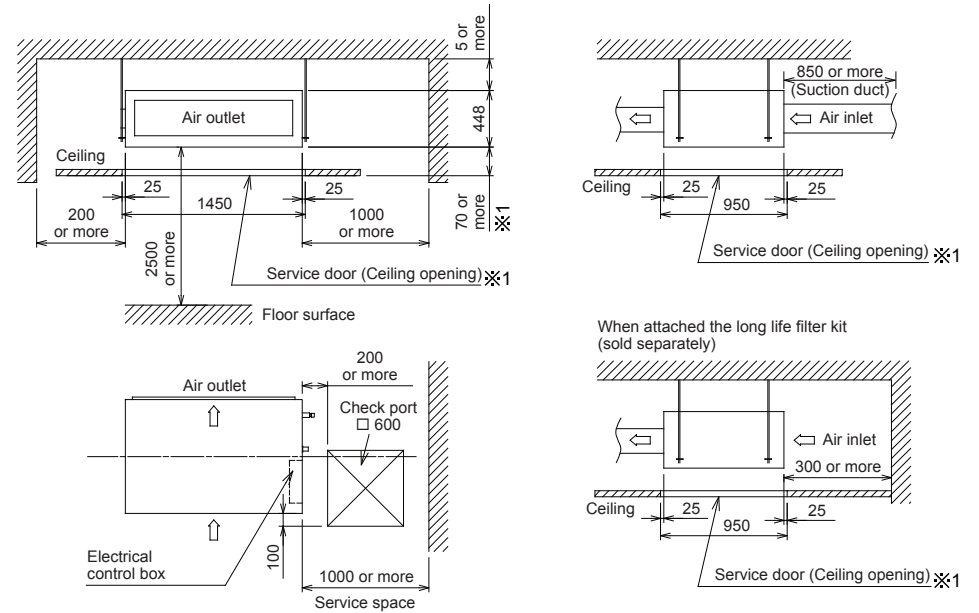

※1 If there are enough space under the unit (more than 1000mm) the service door (Ceiling opening) is not necessary.

## ■ Filter cleaning sign term setting

The lighting term setup of the filter sign (Notification of filter cleaning) of the remote controller can be changed according to the condition of installation.

For setup method, refer to "Filter sign setting" in the Applicable controls of this Manual.

# 4 Installation

## ⚠ CAUTION

- Strictly comply with the following rules to prevent damage of the indoor units and human injury.
- Do not put a heavy article on the indoor unit or let a person get on it. (Even units are packaged)
  - Carry in the indoor unit as it is packaged if possible. If carrying in the indoor unit unpacked by necessity, use buffering cloth or other material to not damage the unit.
  - To move the indoor unit, hold the hooking brackets (4 positions) only.  
Do not apply force to the other parts (such as refrigerant pipe, drain pan, foamed parts, or resin parts).
  - Carry the package by four or more persons, and do not bundle it with plastic band at positions other than specified.
  - To install vibration isolation material to hanging bolts, confirm that it does not increase the unit vibration.

## ■ External dimensions

(Unit: mm)

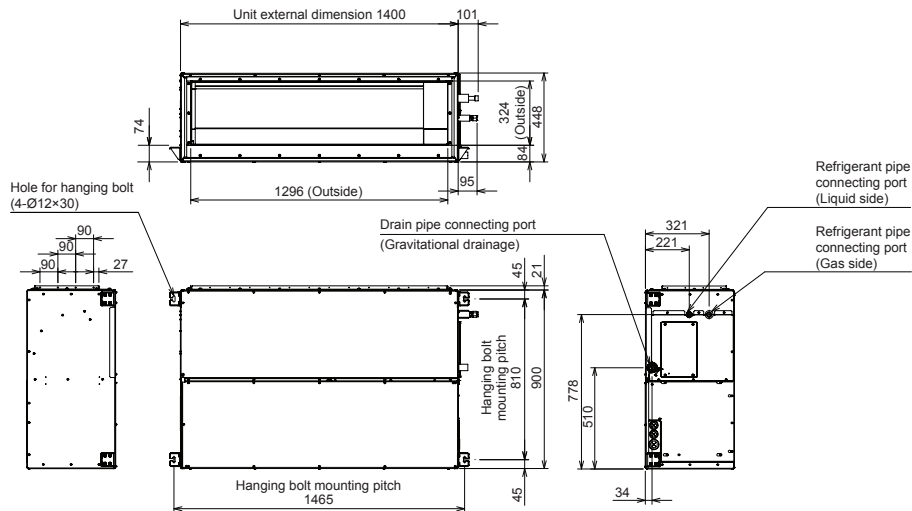

## ■ Installation of hanging bolt

- Consider the piping / wiring after the unit is hung to determine the location of the indoor unit installation and orientation.
- After the location of the indoor unit installation has been determined, install hanging bolts.
- For the dimensions of the hanging bolt pitches, refer to the external view.
- When a ceiling already exists, lay the drain pipe, refrigerant pipe, control wires, and remote controller wires to their connection locations before hanging the indoor unit.

Procure hanging bolts washer and nuts for installing the indoor unit (these are not supplied).

Hanging bolt	M10 or W3/8	4 pieces
Nut	M10 or W3/8	12 pieces
Washer	M10	8 pieces

### Installation of hanging bolt

Use M10 hanging bolts (4 pcs, locally procured). Matching to the existing structure, set pitch according to size in the unit external view as shown below.

New concrete slab	
Install the bolts with insert brackets or anchor bolts.	
(Blade type bracket)	(Slide type bracket)
(Rubber Anchor bolt (Pipe hanging anchor bolt))	
Steel frame structure	
Use existing angles or install new support angles.	
(Hanging bolt, Support angle)	
Existing concrete slab	
Use a hole-in anchors, hole-in plugs, or a hole-in bolts.	

## ■ Installation of indoor unit

### Treatment of ceiling

The ceiling differs according to structure of building. For details, consult your constructor or interior finish contractor.  
In the process after the ceiling board has been removed, it is important to reinforce ceiling foundation (frame) and to keep horizontal level of installed ceiling correctly in order to prevent vibration of ceiling board.

- Attach the nuts and the M10 flat washers to the hanging bolt.
- Put washers at up and down of the hanging bracket of the indoor unit to hang down the indoor unit.
- Check that four sides are horizontal with a level gauge. (Horizontal degree: Within 5 mm)

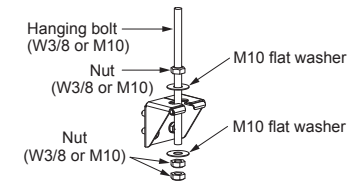

### REQUIREMENT

- Hang the unit in a horizontal position. When unit is hung to slant, it may cause overflow of drainage.
- Install the unit within the dimension according to the figure below.
- Use level gauge to confirm whether the unit is hang horizontally.

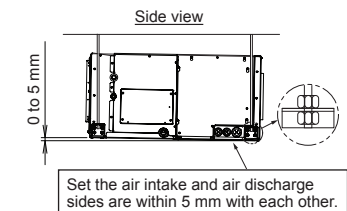
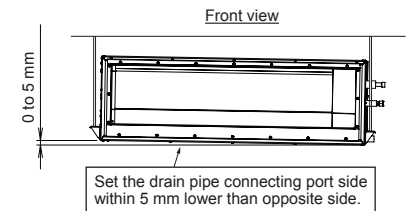

## ■ REQUIREMENT

### Removing the cardboard for transportation

- Make sure to remove the protection cardboard for transportation that is inserted in the gap between the top cabinet and the heat exchanger before installing the indoor unit.

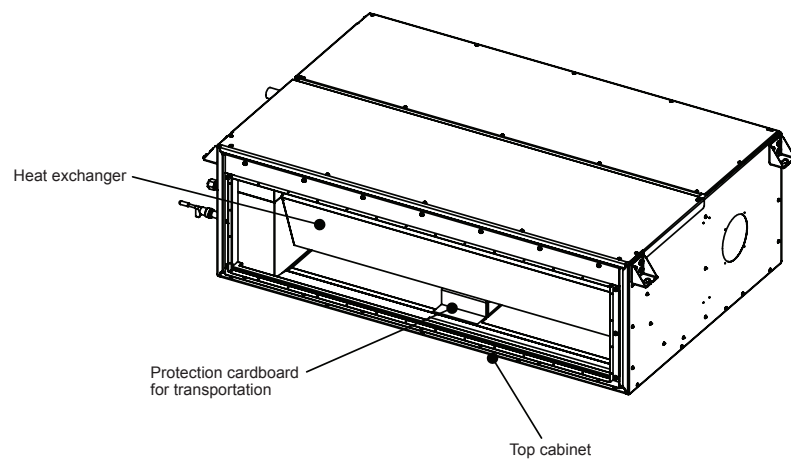

## 5 Drain piping

### ⚠ CAUTION

Following the Installation Manual, perform the drain piping work so that water is properly drained. Apply a heat insulation so as not to cause a dew condensation.

Inappropriate piping work may result in water leakage in the room and wet furniture.

- Provide the indoor drain piping with proper heat insulation.
- Provide the area where the pipe connects to the indoor unit with proper heat insulation. Improper heat insulation will cause condensation to form.
- The drain pipe must be sloping downward (at an angle of 1/100 or more), and do not run the pipe up and down (arched shape) or allow it to form traps. Doing so may cause abnormal sounds.
- Restrict the length of the traversing drain pipe to 20 meters or less. For a long pipe, provide support brackets at intervals of 1.5 to 2 meters to prevent flapping.
- Install the collective piping as shown in the following figure.
- Do not provide any air vents. Otherwise, the drain water will spout, causing water to leak.
- Do not allow any force to be applied to the connection area with the drain pipe.

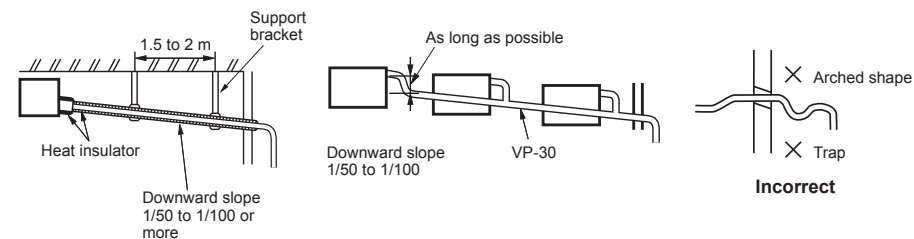

### ■ Pipe material, size and insulator

The following materials for piping work and insulating process are locally procured.

Pipe material	Hard vinyl chloride pipe VP25 (Nominal outer diameter Ø32 mm)
Insulator	Foamed polyethylene foam, thickness: 10 mm or more

### ■ Connecting drain pipe

Insert flexible drain hose into the drain pipe of main unit as far as it will go. Fix it with hose band.

#### REQUIREMENT

Mount the flexible drain hose using the hose band without using adhesive.

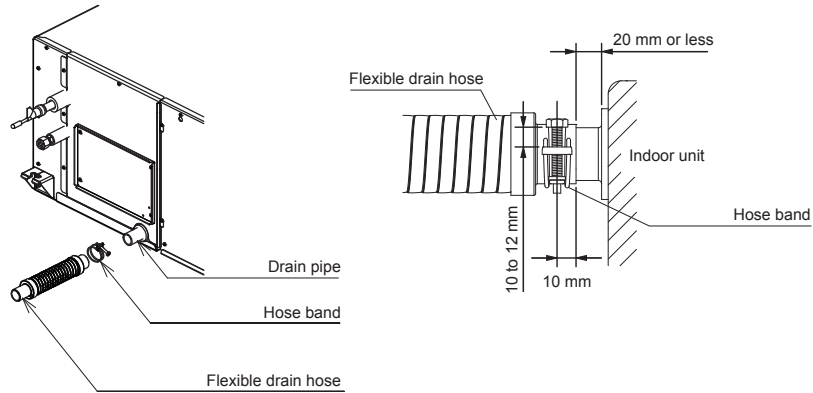

### ■ Drain up

When install the drain pump kit (TCB-DP40DPE) of optional accessory, read the Installation Manual supplied to a drain pump kit.

### ■ Check the draining

Check if the water can flow out properly during the test run. Also, check if no water leakage from the piping connection port.

#### REQUIREMENT

- Conduct the drain test even in the heating season.
- If it is before the duct work, pour water into the drain pan through the air outlet.
- If it is after the duct work, remove the access panel and pour water, then conduct the drain check.

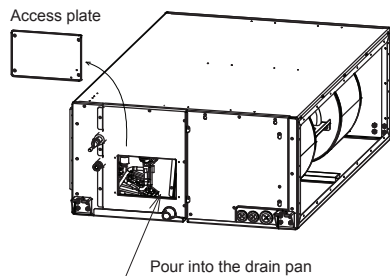

### ■ Heat insulating process

- As shown in the figure, cover the flexible hose and hose band with the attached heat insulator up to the bottom of the indoor unit tightly.
- Cover the drain pipe tightly with a heat insulator procured locally so that it overlaps with the attached heat insulator of the drain connecting section.

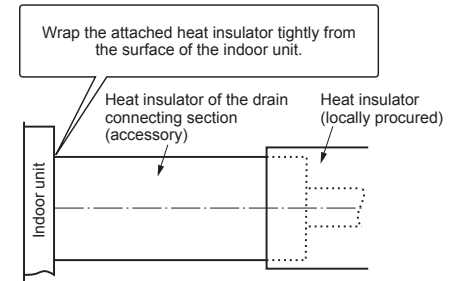

### ■ Connecting method of the duct

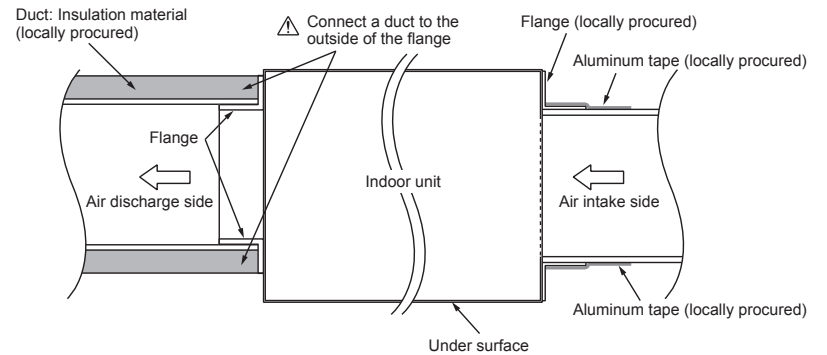

#### ⚠ CAUTION

Incomplete heat insulation of the supply air flange and sealing may occur dewing resulted in falling of water drop.

## Fan characteristics

AP072 type

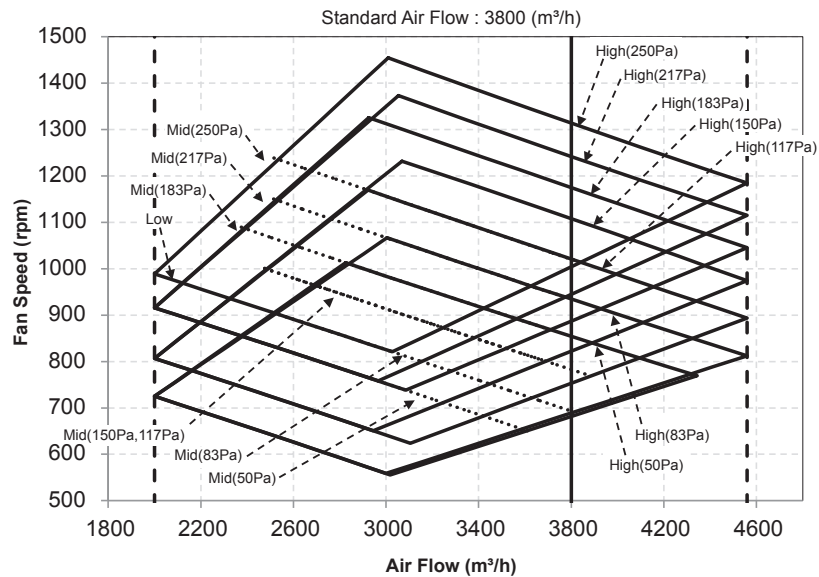
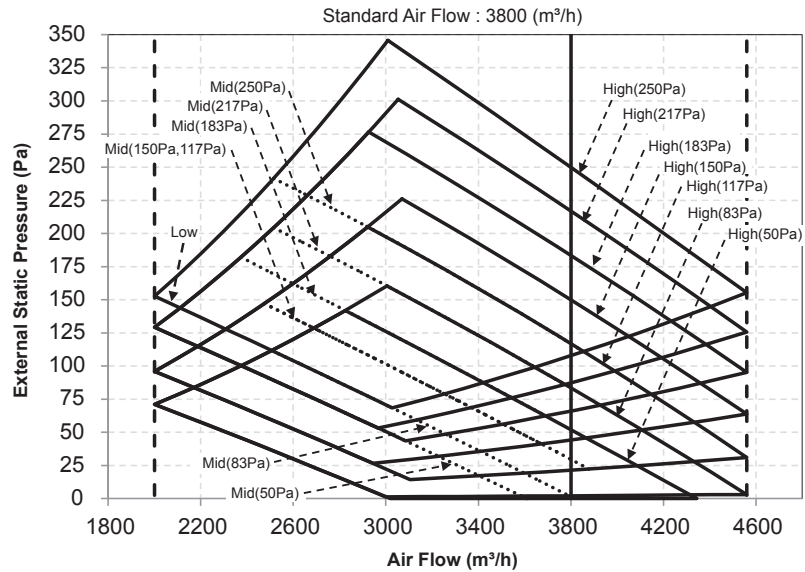

AP096 type

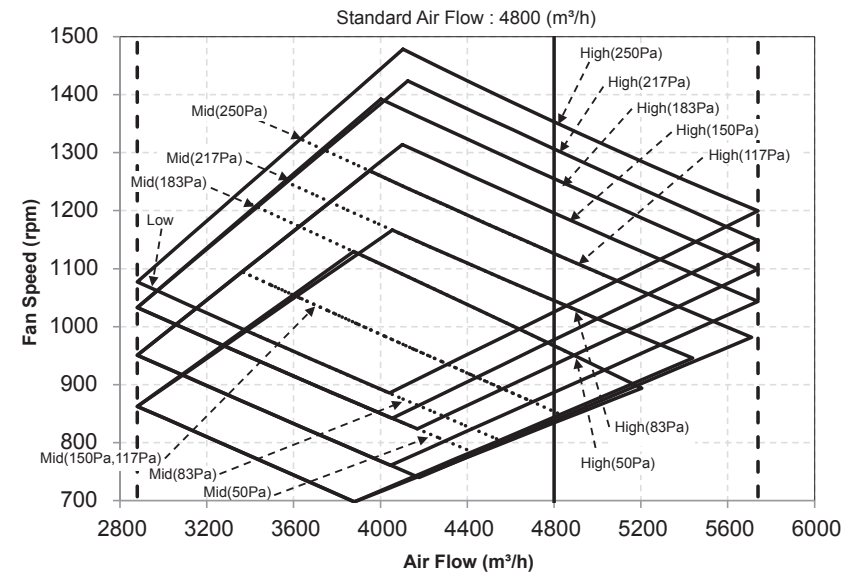
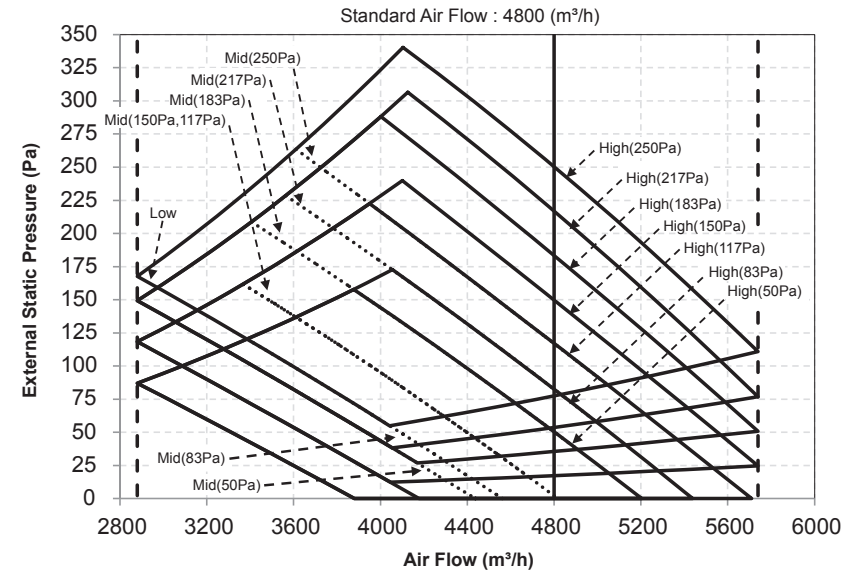

# 6 Duct design

## ■ Duct design

**1** In order to prevent short circuits, design the duct work so that the intake and discharge openings are not adjacent to each other.

**2** The indoor unit does not have a built-in air filter.

Always install the air filter (Local procure) in a location that permits easy maintenance, such as behind the intake grille. (If no air filter is installed, dust will collect in the heat exchanger, which may cause the air conditioner to fail or to leak.)

### <Overview of duct connection>

**NOTE**

Parts except air conditioner unit are to be locally procured.

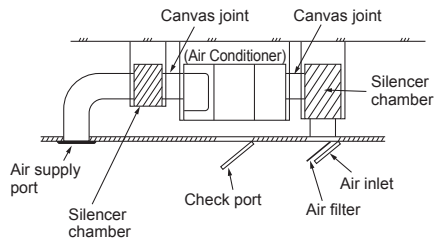

## ■ Arrangement

Referring to the following dimensions, manufacture duct at the local site.

(Unit: mm)

(Thickness of plate : 0.8 mm)

<Air outlet>

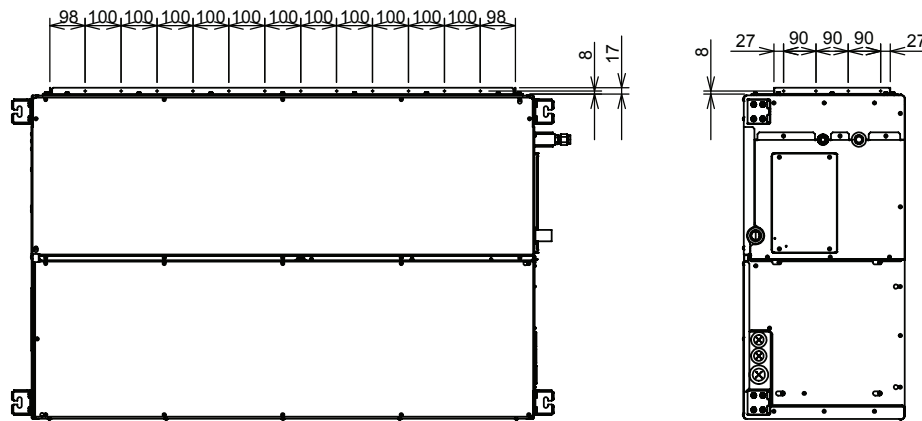
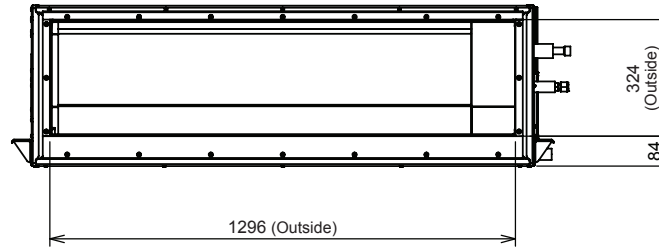

<Air inlet>

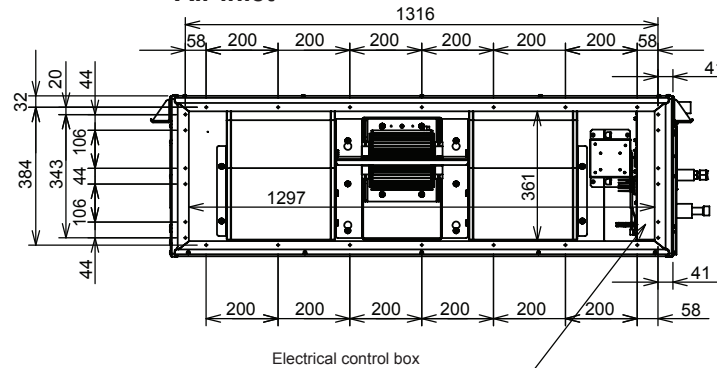

# 7 Refrigerant piping

## Refrigerant piping

- Use general copper pipes with a wall thickness of 0.8 mm for Ø12.7 mm, and with a wall thickness of 1.0 mm for Ø22.2 mm (half hard). Do not use any copper pipes with a wall thickness less than these thicknesses.
- Flare nut and flare works are also different from those of the conventional refrigerant. Take out the flare nut attached to the main unit of the air conditioner, and use it.

### REQUIREMENT

When the refrigerant pipe is long, provide support brackets at intervals of 2.5 to 3 m to clamp the refrigerant pipe. Otherwise, abnormal sound may be generated.

### CAUTION

#### Important 4 points for piping work

- Remove dust and moisture from the inside of the connecting pipes.
- Tight connection (between pipes and unit)
- Evacuate the air in the connecting pipes using VACUUM PUMP.
- Check the gas leakage. (Connected points)

## Pipe size

Pipe size	Gas side	22.2 mm
	Liquid side	12.7 mm

## Liquid side refrigerant pipe connection

### Permissible piping length and height difference

They vary according to the outdoor unit. For details, refer to the Installation Manual attached to the outdoor unit.

## Flaring

- Cut the pipe with a pipe cutter. Remove burrs completely. Remaining burrs may cause gas leakage.
- Insert a flare nut into the pipe, and flare the pipe. As the flaring sizes of R410A differ from those of refrigerant R22, the flare tools newly manufactured for R410A are recommended.

However, the conventional tools can be used by adjusting projection margin of the copper pipe.

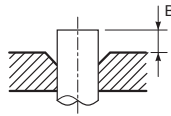

### Projection margin in flaring: B (Unit: mm)

Rigid (Clutch type)

Outer dia. of copper pipe	R410A tool used	Conventional tool used
	R410A	R410A
12.7	0 to 0.5	1.5 to 2.0

### Flaring dia meter size: A (Unit: mm)

Outer dia. of copper pipe	A <sup>+0</sup> / <sub>-0.02</sub> (-0.4)
	R410A
12.7	16.6

- \* In case of flaring for R410A with the conventional flare tool, pull it out approx. 0.5 mm more than that for R22 to adjust to the specified flare size. The copper pipe gauge is useful for adjusting projection margin size.

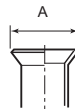

## Tightening connection

### CAUTION

Do not apply excessive torque. Otherwise, the nut may crack depending on the conditions.

(Unit: N·m)

Outer dia. of copper pipe	Tightening torque
12.7 mm (dia.)	50 to 62 (5.0 to 6.2 kgf·m)

### Tightening torque of flare pipe connections

Pressure of R410A is higher than that of R22. (Approx. 1.6 times) Therefore, using a torque wrench, tighten the flare pipe connecting sections which connect the indoor and outdoor units of the specified tightening torque. Incorrect connections may cause not only a gas leak, but also a trouble of the refrigeration cycle. Align the centres of the connecting pipes and tighten the flare nut as far as possible with your fingers. Then tighten the nut with a spanner and torque wrench as shown in the figure.

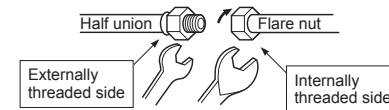

Use a wrench to secure. Use a torque wrench to tighten.

### REQUIREMENT

Tightening with an excessive torque may crack the nut depending on installation conditions. Tighten the nut within the specified tightening torque.

## Gas side refrigerant pipe connection

- Turn up the pipe heat insulator to the unit side.
- Wrap the pipe with wet cloth.

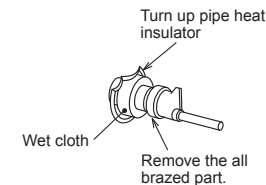

- Remove the cup on the gas side piping by using a brazing machine.

### CAUTION

- Do not burn the pipe heat insulator.
- Be careful for the flame, due to the brazing process on the ceiling.

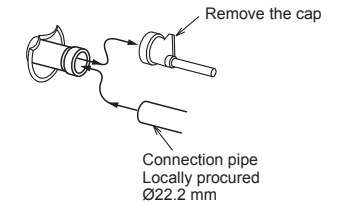

- Braze the connection piping to the joint part.



- Turn back the pipe heat insulator and tie up with a banding band.

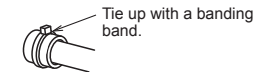

## Piping with outdoor unit

For details of installation, refer to the Installation Manual of the outdoor unit.

## Evacuation

Using a vacuum pump, perform vacuuming from the charge port of valve of the outdoor unit. For details, follow to the Installation Manual attached to the outdoor unit.

- Never use the refrigerant sealed in the outdoor unit for evacuation.

### REQUIREMENT

For the tools such as charge hose, etc., use those manufactured exclusively for R410A.

### Refrigerant amount to be added

For addition of the refrigerant, add refrigerant "R410A" referring to the attached Installation Manual of outdoor unit.

Use a scale to charge the refrigerant of specified amount.

#### REQUIREMENT

- Charging an excessive or too little amount of refrigerant causes a trouble of the compressor. Charge the refrigerant of specified amount.
- A personnel who charged the refrigerant should write down the pipe length and the added refrigerant amount in the F-GAS label of the outdoor unit. It is necessary to fix the compressor and refrigeration cycle malfunction.

### Open the valve fully

Open the valve of the outdoor unit fully. A 4 mm-hexagonal wrench is required for opening the valve of liquid side.

For details, refer to the Installation Manual attached to the outdoor unit.

### Gas leak check

Check with a leak detector or soap water whether gas leaks or not, from the pipe connecting section or cap of the valve.

#### REQUIREMENT

Use a leak detector manufactured exclusively for HFC refrigerant (R410A, R134a).

### Heat insulation process

Apply heat insulation for the pipes separately at liquid side and gas side.

- For the heat insulation to the pipes at gas side, be sure to use the material with heat-resisting temperature 120 °C or higher.
- To use the attached heat insulation pipe, apply the heat insulation to the pipe connecting section of the indoor unit securely without gap.

#### REQUIREMENT

- Apply the heat insulation to the pipe connecting section of the indoor unit securely up to the root without exposure of the pipe. (The pipe exposed to the outside causes water leak.)
- Wrap heat insulator with its slits facing up (ceiling side).

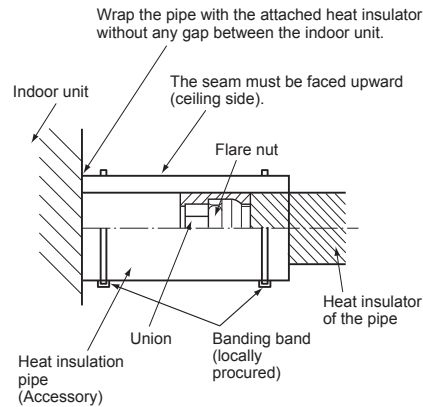

## 8 Electrical connection

### ⚠ WARNING

- **Use the specified wires for wiring connect the terminals. Securely fix them to prevent external forces applied to the terminals from affecting the terminals.**  
Incomplete connection or fixation may cause a fire or other trouble.
- **Connect earth wire. (grounding work)**  
Incomplete grounding cause an electric shock. Do not connect earth wires to gas pipes, water pipes, lightning conductor or telephone earth wires.
- **Appliance shall be installed in accordance with national wiring regulations.**  
Capacity shortage of power circuit or incomplete installation may cause an electric shock or a fire.

### ⚠ CAUTION

- If incorrect/incomplete wiring is carried out, it will cause an electrical fire or smoke.
- Use the cord clamps attached to the product.
- Do not damage or scratch the conductive core and inner insulator of power and system interconnection wires when peeling them.
- Use the power cord and system interconnection wire of specified thickness, type, and protective devices required.
- Do not connect 220 V – 240 V power to the terminal blocks (Ⓛ, Ⓜ, ⓐ, ⓑ) for control wiring. (Otherwise, the system will fail.)
- Do not connect 220 V – 240 V power to the terminal blocks (③, ④) for Flow Selector Unit wiring. (Otherwise, the system will fail.)
- Do not contact the electric wiring with the high-temperature part of the pipe. It causes the coating melted.

#### REQUIREMENT

- For power supply wiring, strictly conform to the Local Regulation in each country.
- For wiring of power supply of the outdoor units, follow the Installation Manual of each outdoor unit.
- After connecting wires to the terminal blocks, provide a trap and fix wires with the cord clamp.
- Run the refrigerant piping line and control wiring line in the same line.
- Do not turn on the power of the indoor unit until the refrigerant pipes are vacuumed.

### ■ Power supply wire and communication wires specifications

Power supply wire and communication wires are procured locally.

For the power supply specifications, follow to the following table. If capacity is little, it is dangerous because overheat or burnout may be caused. For specifications of the power capacity of the outdoor unit and the power supply wires, refer to the Installation Manual attached to the outdoor unit.

#### Indoor unit power supply

- For the power supply of the indoor unit, prepare the exclusive power supply separated from that of the outdoor unit.
- Arrange the power supply, circuit breaker, and main switch of the indoor unit connected to the same outdoor unit so that they are commonly used.
- Power supply wire specification: Cable 3-core 2.5 mm<sup>2</sup>, in conformity with Design 60245 IEC 57.



### ▼ Power supply

Power supply	220 V – 240 V ~, 50 Hz 220 V ~, 60 Hz	
Power supply switch/circuit breaker or power supply wiring/fuse rating for indoor units should be selected by the accumulated total current values of the indoor units.		
Power supply wiring	Below 20 m	2.5 mm <sup>2</sup>
	Below 50 m	4.0 mm <sup>2</sup>

### Control wiring, Central controller wiring

- 2-core with polarity wires are used for the Control wiring between indoor unit and outdoor unit and Central controller wiring.
- To prevent noise trouble, use 2-core shield wire.
- The length of the communication line means the total length of the inter-unit wire length between indoor and outdoor units added with the central control system wire length.

### ▼ Communication line

Control wiring between indoor units, and outdoor unit (2-core shield wire)	Wire size	(Up to 1000 m) 1.25 mm <sup>2</sup> (Up to 2000 m) 2.0 mm <sup>2</sup>
Central control line wiring (2-core shield wire)	Wire size	(Up to 1000 m) 1.25 mm <sup>2</sup> (Up to 2000 m) 2.0 mm <sup>2</sup>

### Remote controller wiring

- 2-core with non-polarity wire is used for wiring of the remote controller wiring and group remote controllers wiring.

Remote controller wiring, remote controller inter-unit wiring	Wire size: 0.5 mm <sup>2</sup> to 2.0 mm <sup>2</sup>	
Total wire length of remote controller wiring and remote controller inter-unit wiring = L + L1 + L2 + ... Ln	In case of wired type only	Up to 500 m
	In case of wireless type included	Up to 400 m
Total wire length of remote controller inter-unit wiring = L1 + L2 + ... Ln		Up to 200 m

### ⚠ CAUTION

The remote controller wire (Communication line) and AC 220 – 240 V wires cannot be parallel to contact each other and cannot be stored in the same conduits. If doing so, it may cause troubles on the control system due to noise or other factor.

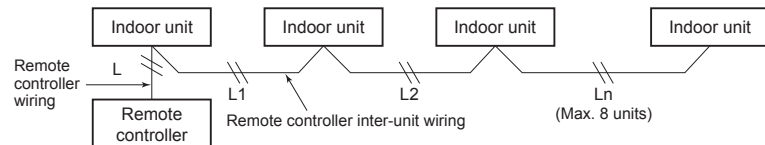

## ■ Wiring between indoor unit and outdoor unit

### NOTE

An outdoor unit connected with control wiring between indoor and outdoor units wire becomes automatically the header unit.

### ▼ Wiring example

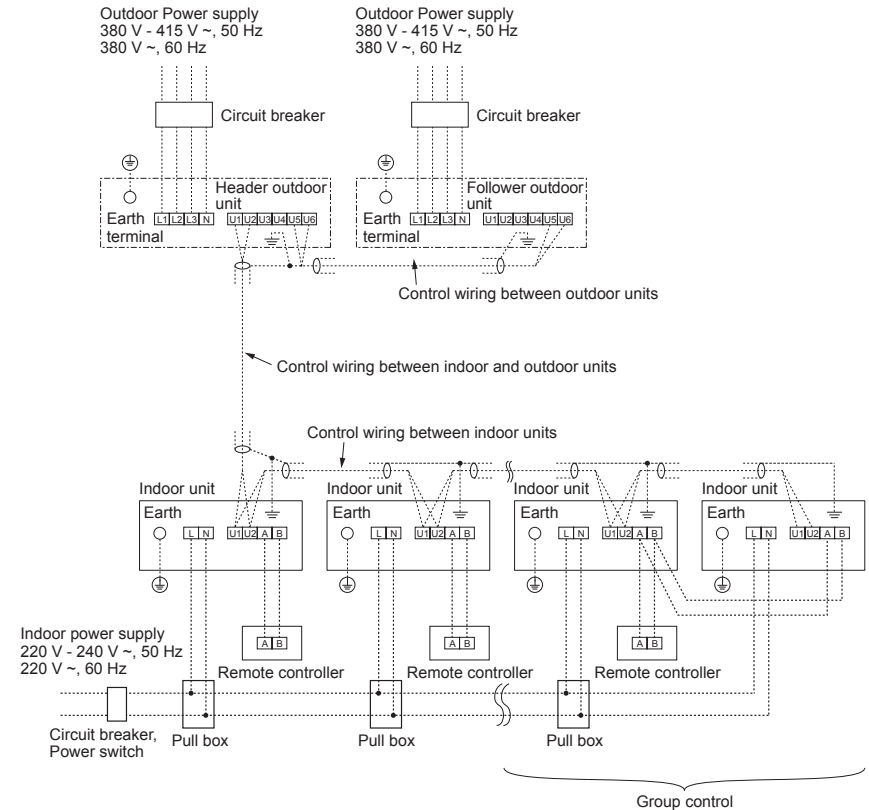

## ■ Wire connection

### REQUIREMENT

- Connect the wires matching the terminal numbers. Incorrect connection causes a trouble.
- Pass the wires through the bushing of wire connection holes of the indoor unit.
- Keep a margin (Approx. 100 mm) on a wire to hang down the electrical control box at servicing or other purpose.
- The low-voltage circuit is provided for the remote controller. (Do not connect the high-voltage circuit)

- Before performing wiring work in the electrical control box, remove the cover of the box (fixed with 6 screws).
- Remove screw A, and loosen screw B.
- Pull up the electrical control box cover and then open it forward.
- Tighten the screws of the terminal block firmly, and fix the wires with the cord clamps attached to the electrical control box. (Do not apply tension to the connecting section of the terminal block.)
- Mount the cover of the electrical control box without pinching wires (fixed with 6 screws).
- Using the attached seal material, seal the wire connecting port.

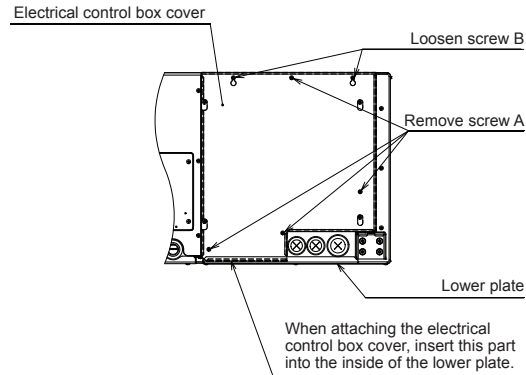

## ■ Remote controller wiring

Strip off approx. 9 mm the wire to be connected.

### Wiring diagram

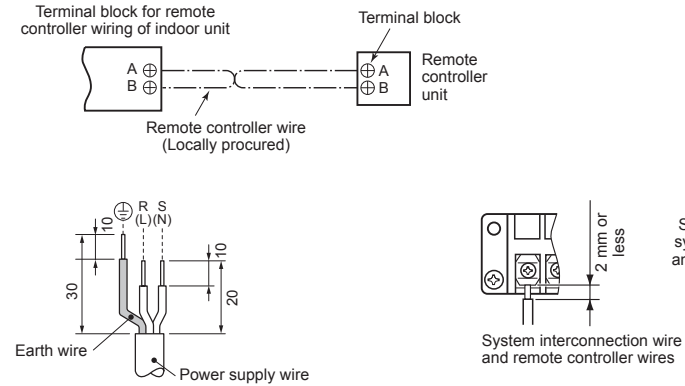

See the figure on the left for system interconnection wires and remote controller wires to the terminal block.

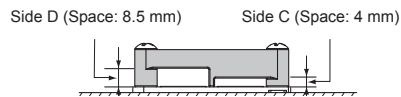

Select side C or D for the power cable clamping position referring to the following table according to the cable type and diameter.

\* Cable clamp can be attached on either right or left side.  
When twin system are connected, clamp two cables with one cable clamp.

Wire type	Specification	Cable clamping position
Cabtyre cable	3-core stranded wire 2.5 mm <sup>2</sup>	Side D
Cabtyre cable	4-core stranded wire 1.5 mm <sup>2</sup>	Side C

※ 3 and 4 terminals is Flow Selector Unit wiring.

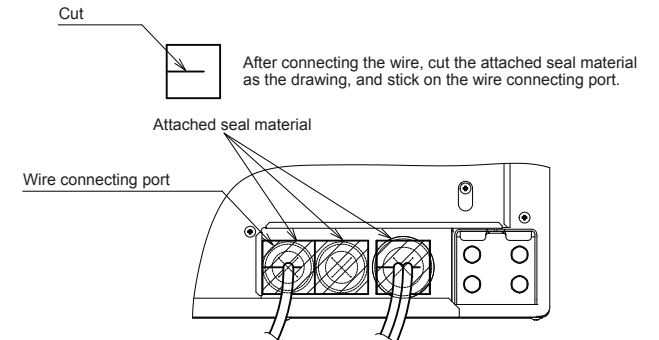
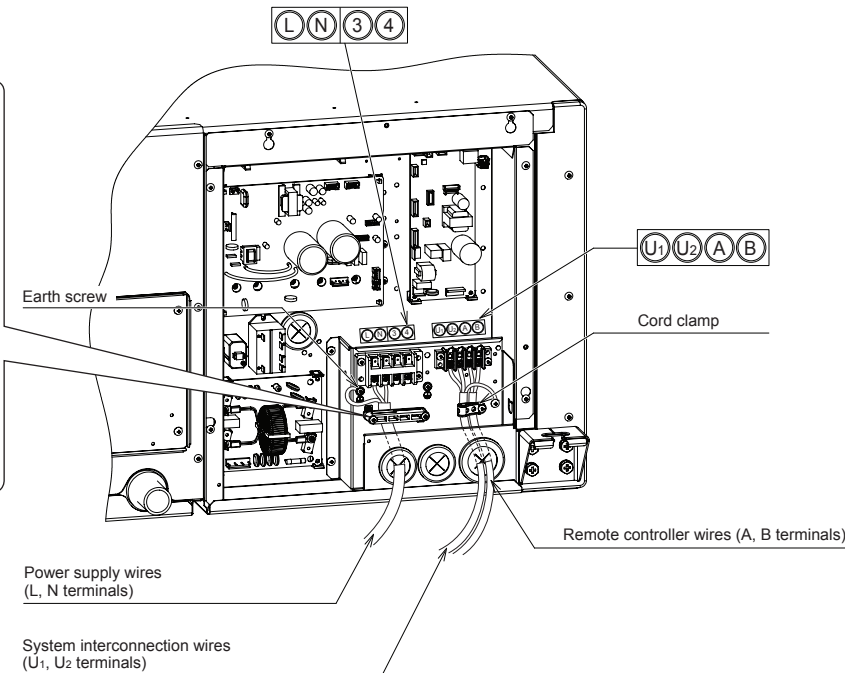

# 9 Applicable controls

## REQUIREMENT

When the air conditioner is used for the first time, it will take some moments after the power has been turned on before the remote controller becomes available for operations: This is normal and is not indicative of trouble.

- Concerning the automatic addresses (The automatic addresses are set up by performing operations on the outdoor interface circuit board.) While the automatic addresses are being set up, no remote controller operations can be performed. Setup takes up to 10 minutes (usually about 5 minutes).
- When the power is turned on after automatic address setup  
It takes up to 10 minutes (usually about 3 minutes) for the outdoor unit to start operating after the power has been turned on.

Before the air conditioner was shipped from the factory, all units are set to [STANDARD] (factory default). If necessary, change the indoor unit settings.

The settings are changed by operating the wired remote controller.

\* The settings cannot be changed using only a wireless remote controller, simple remote controller or group control remote controller by itself so install a wired remote controller separately as well.

## Basic procedure for changing settings

Change the settings while the air conditioner is not working. **(Stop the air conditioner before making settings.)**

### CAUTION

Set only the CODE No. shown in the following table: Do NOT set any other CODE No. If a CODE No. not listed is set, it may not be possible to operate the air conditioner or other trouble with the product may result.

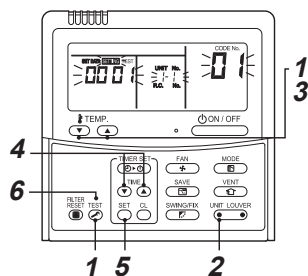

- 1 Push and hold **TEST** button and “TEMP.” button simultaneously for 4 seconds or more. After a while, the display flashes as shown in the figure. Confirm that the CODE No. is [01].

- If the CODE No. is not [01], push **TEST** button to clear the display content, and repeat the procedure from the beginning. (No operation of the **TEST** remote controller is accepted for a while after button is pushed.)  
(While air conditioners are operated under the group control, “ALL” is displayed first. When **UNIT LOUVER** is pushed, the indoor unit number displayed following “ALL” is the header unit.)

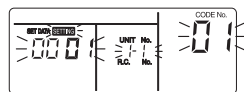

(\* Display content varies with the indoor unit model.)

- 2 Each time **UNIT LOUVER** button is pushed, indoor unit numbers in the control group change cyclically. Select the indoor unit to change settings for.

The fan of the selected unit runs and the louvers start swinging. The indoor unit for change settings can be confirmed.

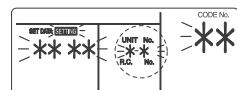

- 3 Specify CODE No. [\*\*] with “TEMP.” button.

- 4 Select SET DATA [\*\*\*\*] with “TIME” button.

- 5 Push **SET** button. When the display changes from flashing to lit, the setup is completed.

- To change settings of another indoor unit, repeat from Procedure 2.
- To change other settings of the selected indoor unit, repeat from Procedure 3.
- Use **CL** button to clear the settings. To make settings after **CL** button was pushed, repeat from Procedure 2.

- 6 When settings have been completed, push **TEST** button to determine the settings.

When **TEST** button is pushed, **SETTING** flashes and then the display content disappears and the air conditioner enters the normal stop mode.

(While **SETTING** is flashing, no operation of the remote controller is accepted.)

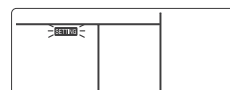

## External static pressure settings

### <Change on wired remote controller>

Set up a tap change based upon the external static pressure of the duct to be connected.

To set up a tap change, follow to the basic operation procedure (1 → 2 → 3 → 4 → 5 → 6).

- Specify [5d] to the CODE No. in procedure 3.
- For the SET DATA of procedure 4, select a SET DATA of the external static pressure to be set up from the following table.

SET DATA	External static pressure	
0000	150 Pa	Factory default
0001	50 Pa	—
0002	83 Pa	—
0003	217 Pa	—
0004	117 Pa	—
0005	183 Pa	—
0006	250 Pa	—

The list above is when SW501-1 and SW501-2 is OFF. If the setting is wrong, “P12” may appear indicating a fan motor error.

**<Setting up on the circuit board of the indoor unit>**

To set up the external static pressure, use the DIP switch on the circuit board of the wireless reception part. For details, refer to the instruction manual of the wireless remote controller kit. Alternatively, use the switch on the indoor micro computer circuit board as shown in the following figure and table.

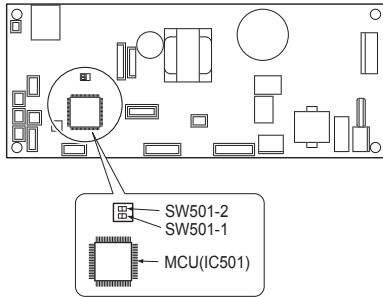

<b>SW501-1</b>	OFF	ON	OFF	ON
<b>SW501-2</b>	OFF	OFF	ON	ON
<b>SET DATA</b>	Factory default	0001	0003	0006

**To reset to the factory default**  
Switch off SW501-1 and SW501-2, connect a separately-sold wired remote controller, and then perform the procedure for external static pressure settings on this page to set the [5d] data to "0000".

**Filter sign setting**

According to the installation condition, the filter sign term (Notification of filter cleaning) can be changed.

Follow to the basic operation procedure (1 → 2 → 3 → 4 → 5 → 6).

- For the CODE No. in Procedure 3, specify [01].
- For the [SET DATA] in Procedure 4, select the SET DATA of filter sign term from the following table.

SET DATA	Filter sign term
0000	None
0001	150 H
0002	2500 H (Factory default)
0003	5000 H
0004	10000 H

**To secure better effect of heating**

When it is difficult to obtain satisfactory heating due to installation place of the indoor unit or structure of the room, the detection temperature of heating can be raised. Also use a circulator or other device to circulate heat air near the ceiling.

Follow to the basic operation procedure (1 → 2 → 3 → 4 → 5 → 6).

- For the CODE No. in Procedure 3, specify [06].
- For the SET DATA in Procedure 4, select the SET DATA of shift value of detection temperature to be set up from the following table.

SET DATA	Detection temperature shift value
0000	No shift
0001	+1 °C
0002	+2 °C (Factory default)
0003	+3 °C
0004	+4 °C
0005	+5 °C
0006	+6 °C

**Remote controller sensor**

The temperature sensor of the indoor unit senses room temperature usually. Set the remote controller sensor to sense the temperature around the remote controller.

Select items following the basic operation procedure (1 → 2 → 3 → 4 → 5 → 6).

- Specify [32] for the CODE No. in Procedure 3.
- Select the following data for the SET DATA in Procedure 4.

SET DATA	0000	0001
Remote controller sensor	Not used (Factory default)	Used

When the sensor flashes, the remote controller sensor is defective.

Select the SET DATA [0000] (not used) or replace the remote controller.

**Group control**

In a group control, a remote controller can control up to maximum 8 units.

- The wired remote controller only can control a group control. The wireless remote controller is unavailable for this control.
- For wiring procedure and wires of the individual line (Identical refrigerant line) system, refer to "Electrical Connection" in this Manual.
- Wiring between indoor units in a group is performed in the following procedure.
- Connect the indoor units by connecting the remote controller wires from the remote controller terminal blocks (A, B) of the indoor unit connected with a remote controller to the remote controller terminal blocks (A, B) of the other indoor unit. (Non-polarity)
- For address setup, refer to the Installation Manual attached to the outdoor unit.

# 10 Test run

## ■ Before test run

- Before turning on the power supply, carry out the following procedure.
  - By using 500 V-megger, check that resistance of 1 MΩ or more exists between the terminal block L to N and the earth (grounding).  
If resistance of less than 1 MΩ is detected, do not run the unit.
  - Check the valve of the outdoor unit being opened fully.
- To protect the compressor at activation time, leave power-ON for 12 hours or more before operating.
- Do not press the electromagnetic contactor to forcibly perform a test run. (This is very dangerous because the protective device does not work.)
- Before starting a test run, set addresses by following the Installation Manual supplied with the outdoor unit.

## ■ Execute a test run

- When a fan operation is to be performed for an individual indoor unit, turn off the power, short CN72 on the circuit board, and then turn the power back on. (First set the operating mode to “fan,” and then operate.) When the test run has been performed using this method, do NOT forget to release the shorting of CN72 after the test run is completed.

Operate the unit with the wired remote controller as usual.

For the procedure of the operation, refer to the attached Owner's Manual to the outdoor unit.

A forced test run can be executed in the following procedure even if the operation stops by thermostat-OFF.

In order to prevent a serial operation, the forced test run is released after 60 minutes have passed and returns to the usual operation.

### ⚠ CAUTION

Do not use the forced test run for cases other than the test run because it applies an excessive load to the devices.

## Wired remote controller

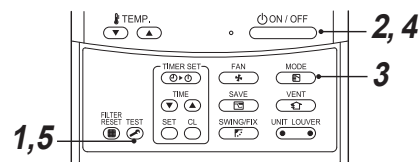

- 1 Push **TEST** button for 4 seconds or more. [TEST] is displayed on the display part and the selection of mode in the test mode is permitted.

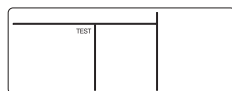

- 2 Push **ON/OFF** button.

- 3 Select the operation mode with **MODE** button, [**\* Cool**] or [**\* Heat**].
  - Do not run the air conditioner in a mode other than [**\* Cool**] or [**\* Heat**].
  - The temperature controlling function does not work during test run.
  - The detection of error is performed as usual.

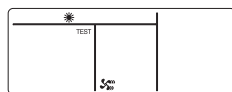

- 4 After the test run, push **ON/OFF** button to stop a test run. (Display part is same as procedure 1.)

- 5 Push **TEST** button to cancel (release from) the test run mode. ([TEST] disappears on the display and the status returns to a normal.)

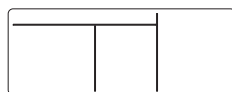

# 11 Maintenance

### ⚠ CAUTION

When connecting a return air duct to the unit, the cleaning method of the air filter differs according to the construction of duct end. Ask a qualified installer or qualified service person.

## <Daily maintenance> (Once every 3 months)

### ▼ Cleaning of the air filter (sold separately : TCB-LK2801DP-E)

If **■** displayed on the remote controller, maintain the air filter (sold separately).

- 1 Push the **ON/OFF** button to stop the operation, then turn off the circuit breaker.

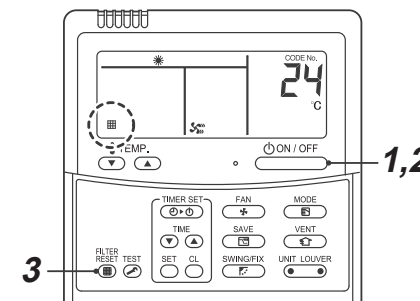

1. Take out the air filter (sold separately).
- Cleaning with water or vacuum cleaner.
  - If dirt is heavy, clean the air filter by tepid water with neutral detergent or water.
  - After cleaning with water, dry the air filter sufficiently in a shade place.
3. Mount the air filter (sold separately).

- 2 Turn on the circuit breaker, then push the **ON/OFF** button on the remote controller to start the operation.

- 3 After cleaning, push **TEST** button. **■** display disappears.

### ⚠ CAUTION

- Do not start the air conditioner while leaving air filter (sold separately) removed.
- Push the filter reset button. (**■** indication will be turn off.)

▼ **Periodic Maintenance**

For environmental conservation, it is strongly recommended that the indoor and outdoor units of the air conditioner in use be cleaned and maintained regularly to ensure efficient operation of the air conditioner.

When the air conditioner is operated for a long time, periodic maintenance (once a year) is recommended. Furthermore, regularly check the outdoor unit for rust and scratches, and remove them or apply rustproof treatment, if necessary.

As a general rule, when an indoor unit is operated for 8 hours or more daily, clean the indoor unit and outdoor unit at least once every 3 months. Ask a professional for this cleaning / maintenance work.

Such maintenance can extend the life of the product though it involves the owner's expense.

Failure to clean the indoor and outdoor units regularly will result in poor performance, freezing, water leakage, and even compressor failure.

▼ **Inspection before maintenance (Once a year)**

Following inspection must be carried out by a qualified installer or qualified service person.

Parts	Inspection method
Fan motor	Access from the access panel and check if any abnormal noise can be heard.
Fan	Access from the access panel and remove the access panel. Examine the fan if there are any waggles, damages or adhesive dust.
Filter (sold separately)	Access from check port and check if there are any stains or breaks on the filter.
Drain pan	Access from the access panel and remove the access panel. Check if there is any clogging or drain water is polluted.

- The unit can be accessed from the access panel shown in the figure.

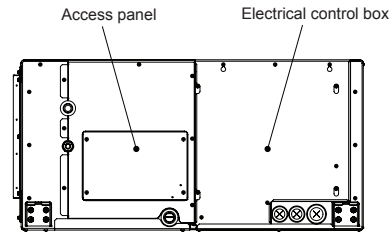

▼ **Maintenance List**

Part	Unit	Check (visual / auditory)	Maintenance
Heat exchanger	Indoor / outdoor	Dust / dirt clogging, scratches	Wash the heat exchanger when it is clogged.
Fan motor	Indoor / outdoor	Sound	Take appropriate measures when abnormal sound is generated.
Filter (sold separately)	Indoor	Dust / dirt, breakage	<ul style="list-style-type: none"> <li>• Wash the filter with water when it is contaminated.</li> <li>• Replace it when it is damaged.</li> </ul>
Fan	Indoor	<ul style="list-style-type: none"> <li>• Vibration, balance</li> <li>• Dust / dirt, appearance</li> </ul>	<ul style="list-style-type: none"> <li>• Replace the fan when vibration or balance is terrible.</li> <li>• Brush or wash the fan when it is contaminated.</li> </ul>
Air intake / discharge grilles	Indoor / outdoor	Dust / dirt, scratches	Fix or replace them when they are deformed or damaged.
Drain pan	Indoor	Dust / dirt clogging, drain contamination	Clean the drain pan and check the downward slope for smooth drainage.
Ornamental panel, louvers	Indoor	Dust / dirt, scratches	Wash them when they are contaminated or apply repair coating.
Exterior	Outdoor	<ul style="list-style-type: none"> <li>• Rust, peeling of insulator</li> <li>• Peeling / lift of coat</li> </ul>	Apply repair coating.

# 12 Troubleshooting

## ■ Confirmation and check

When an error occurred in the air conditioner, an error code and indoor UNIT No. appear on the display part of the remote controller.

The error code is only displayed during the operation. If the display disappears, operate the air conditioner according to the following "Confirmation of error log" for confirmation.

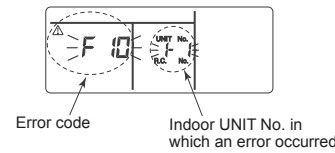

## ■ Confirmation of error log

When an error occurred on the air conditioner, the error log can be confirmed with the following procedure.

(The error log is stored in memory up to 4 errors.)  
The log can be confirmed from both operating status and stop status.

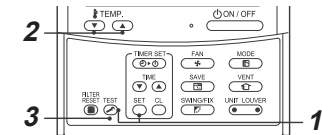

**1** When **SET** and **TEST** buttons are pushed simultaneously for 4 seconds or more, the following display appears.

If **F** is displayed, the mode enters in the error log mode.

- [01: Order of error log] is displayed in CODE No.
- [Error code] is displayed in CHECK.
- [Indoor unit address in which an error occurred] is displayed in Unit No..

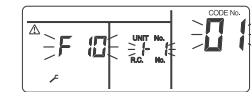

**2** Every pushing of **TEMP.** button used to set temperature, the error log stored in memory is displayed in order.

The numbers in CODE No. indicate CODE No.  
[01] (latest) → [04] (oldest).

**REQUIREMENT**

Do not push **CL** button because all the error log of the indoor unit will be deleted.

**3** After confirmation, push **TEST** button to return to the usual display.

### Check method (The following check code table explain in SMMS-e.)

On the wired remote controller, central control remote controller and the interface P.C. board of the outdoor unit (I/F), a check display LCD (Remote controller) or 7-segment display (on the outdoor interface P.C. board) to display the operation is provided. Therefore the operation status can be known. Using this self-diagnosis function, a trouble or position with error of the air conditioner can be found as shown in the following table.

### Check code list

The following list shows each check code. Find the check contents from the list according to part to be checked.

- In case of check from indoor remote controller: See "Wired remote controller display" in the list.
- In case of check from outdoor unit: See "Outdoor unit 7-segment display" in the list.
- In case of check from indoor unit with a wireless remote controller: See "Sensor block display of receiving unit" in the list.

○ : Lighting, ◻ : Flashing, ● : Goes off  
IPDU: Intelligent Power Drive Unit

ALT: Flashing is alternately when there are two flashing LED.  
SIM: Simultaneous flashing when there are two flashing LED.

Check code			Wireless remote controller				Check code name	Judging device
Wired remote controller display	Outdoor unit 7-segment display		Sensor block display of receiving unit					
		Auxiliary code	Operation	Timer	Ready	Flash		
E01	—	—	◻	●	●		Communication error between indoor unit and remote controller (Detected at remote controller side)	Remote controller
E02	—	—	◻	●	●		Remote controller transmission error	Remote controller
E03	—	—	◻	●	●		Communication error between indoor unit and remote controller (Detected at indoor unit side)	Indoor unit
E04	—	—	●	●	◻		Communication circuit error between indoor/outdoor unit (Detected at indoor unit side)	Indoor unit
E06	E06	No. of indoor units in which sensor has been normally received	●	●	◻		Decrease of No. of indoor units	I/F
—	E07	—	●	●	◻		Communication circuit error between indoor/outdoor unit (Detected at outdoor unit side)	I/F
E08	E08	Duplicated indoor unit addresses	◻	●	●		Duplicated indoor unit addresses	Indoor unit • I/F
E09	—	—	◻	●	●		Duplicated master remote controllers	Remote controller
E10	—	—	◻	●	●		Communication error between indoor unit MC	Indoor unit
E12	E12	01: Indoor/Outdoor units communication 02: Outdoor/Outdoor units communication	◻	●	●		Automatic address start error	I/F
E15	E15	—	●	●	◻		No indoor unit during automatic addressing	I/F
E16	E16	00: Capacity over 01 ~: No. of connected units	●	●	◻		Capacity over / No. of connected indoor units	I/F
E18	—	—	◻	●	●		Communication error between header and follower units Indoor unit	Indoor unit
E19	E19	00: No header 02: Two or more header units	●	●	◻		Outdoor header units quantity error	I/F
E20	E20	01: Outdoor unit of other line connected 02: Indoor unit of other line connected	●	●	◻		Other line connected during automatic address	I/F
E21	E21	02: No header unit 00: Multiple number of header units	●	●	◻		Error in number of heat storage master units	I/F
E22	E22	—	●	●	◻		Reduction in number of heat storage units	I/F
E23	E23	—	●	●	◻		Sending error in communication between outdoor units Error in number of heat storage units (trouble with reception)	I/F
E25	E25	—	●	●	◻		Duplicated follower outdoor addresses	I/F
E26	E26	No. of outdoor units which received signal normally	●	●	◻		Decrease of No. of connected outdoor units	I/F
E28	E28	Detected outdoor unit number	●	●	◻		Follower outdoor unit error	I/F
E31	E31	Number of IPDU (*1)	●	●	◻		IPDU communication error	I/F

Wired remote controller display	Check code		Wireless remote controller				Check code name	Judging device
	Outdoor unit 7-segment display		Sensor block display of receiving unit					
		Auxiliary code	Operation	Timer	Ready	Flash		
F01	—	—	☐	☐	●	ALT	Indoor unit TCJ sensor error	Indoor unit
F02	—	—	☐	☐	●	ALT	Indoor unit TC2 sensor error	Indoor unit
F03	—	—	☐	☐	●	ALT	Indoor unit TC1 sensor error	Indoor unit
F04	F04	—	☐	☐	○	ALT	TD1 sensor error	I/F
F05	F05	—	☐	☐	○	ALT	TD2 sensor error	I/F
F06	F06	01: TE1 sensor 02: TE2 sensor	☐	☐	○	ALT	TE1 sensor error TE2 sensor error	I/F
F07	F07	01: TL1 sensor 02: TL2 sensor 03: TL3 sensor	☐	☐	○	ALT	TL1, TL2 or TL3 sensor error	I/F
F08	F08	—	☐	☐	○	ALT	TO sensor error	I/F
F10	—	—	☐	☐	●	ALT	Indoor unit TA sensor error	Indoor unit
F12	F12	01: TS1 sensor 03: TS3 sensor	☐	☐	○	ALT	TS1 or TS3 sensor error	I/F
F13	F13	01: Comp. 1 side 02: Comp. 2 side	☐	☐	○	ALT	TH sensor error	IPDU
F15	F15	—	☐	☐	○	ALT	Outdoor unit temp. sensor miswiring (TE, TL)	I/F
F16	F16	—	☐	☐	○	ALT	Outdoor unit pressure sensor miswiring (Pd, Ps)	I/F
F22	F22	—	☐	☐	○	ALT	TD3 sensor error	I/F
F23	F23	—	☐	☐	○	ALT	Ps sensor error	I/F
F24	F24	—	☐	☐	○	ALT	Pd sensor error	I/F
F29	—	—	☐	☐	●	SIM	Indoor unit other error	Indoor unit
H01	H01	01: Comp. 1 side 02: Comp. 2 side	●	☐	●		Compressor break down	IPDU
H02	H02	01: Comp. 1 side 02: Comp. 2 side	●	☐	●		Compressor trouble (lock)	IPDU
H03	H03	01: Comp. 1 side 02: Comp. 2 side	●	☐	●		Current detect circuit system error	IPDU
H04	H04	—	●	☐	●		Comp. 1 case thermo operation	I/F
H05	H05	—	●	☐	●		TD1 sensor miswiring	I/F
H06	H06	—	●	☐	●		Low pressure protective operation	I/F
H07	H07	—	●	☐	●		Oil level down detective protection	I/F
H08	H08	01: TK1 sensor error 02: TK2 sensor error 04: TK4 sensor error 05: TK5 sensor error	●	☐	●		Oil level detective temp sensor error	I/F
H14	H14	—	●	☐	●		Comp. 2 case thermo operation	I/F
H15	H15	—	●	☐	●		TD2 sensor miswiring	I/F
H16	H16	01: TK1 oil circuit system error 02: TK2 oil circuit system error 04: TK4 oil circuit system error 05: TK5 oil circuit system error	●	☐	●		Oil level detective circuit error	I/F
L02	L02	—	☐	●	☐	SIM	Model mismatch of indoor and outdoor unit	I/F
L03	—	—	☐	●	☐	SIM	Indoor unit centre unit duplicated	Indoor unit
L04	L04	—	☐	○	☐	SIM	Outdoor unit line address duplicated	I/F



Wired remote controller display	Check code		Wireless remote controller				Check code name	Judging device
	Outdoor unit 7-segment display		Sensor block display of receiving unit					
		Auxiliary code	Operation	Timer	Ready	Flash		
L05	—	—	☐	●	☐	SIM	Duplicated indoor units with priority (Displayed in indoor unit with priority)	I/F
L06	L06	No. of indoor units with priority	☐	●	☐	SIM	Duplicated indoor units with priority (Displayed in unit other than indoor unit with priority)	I/F
L07	—	—	☐	●	☐	SIM	Group line in individual indoor unit	Indoor unit
L08	L08	—	☐	●	☐	SIM	Indoor unit group/Address unset	Indoor unit, I/F
L09	—	—	☐	●	☐	SIM	Indoor unit capacity unset	Indoor unit
L10	L10	—	☐	○	☐	SIM	Outdoor unit capacity unset	I/F
L17	L17	—	☐	○	☐	SIM	Outdoor unit type mismatch error	I/F
L20	—	—	☐	○	☐	SIM	Duplicated central control addresses	Indoor unit
L28	L28	—	☐	○	☐	SIM	Too many outdoor units connected	I/F
L29	L29	Number of IPDU (*1)	☐	○	☐	SIM	No. of IPDU error	I/F
L30	L30	Detected indoor unit address	☐	○	☐	SIM	Indoor unit outside interlock	Indoor unit
—	L31	—	—	—	—	—	Extended I/C error	I/F
P01	—	—	●	☐	☐	ALT	Indoor fan motor error	Indoor unit
P03	P03	—	☐	●	☐	ALT	Discharge temp. TD1 error	I/F
P04	P04	01: Comp. 1 side 02: Comp. 2 side	☐	●	☐	ALT	High-pressure SW system operation	IPDU
P05	P05	00: 01: Comp. 1 side 02: Comp. 2 side	☐	●	☐	ALT	Phase missing detection/Power failure detection Inverter DC voltage error (comp.) Inverter DC voltage error (comp.) Inverter DC voltage error (comp.)	I/F
P07	P07	01: Comp. 1 side 02: Comp. 2 side	☐	●	☐	ALT	Heat sink overheat error	IPDU, I/F
P10	P10	Detected indoor unit address	●	☐	☐	ALT	Indoor unit overflow error	Indoor unit
P12	—	—	●	☐	☐	ALT	Indoor unit fan motor error	Indoor unit
P13	P13	—	●	☐	☐	ALT	Outdoor liquid back detection error	I/F
P15	P15	01: TS condition 02: TD condition	☐	●	☐	ALT	Gas leak detection	I/F
P17	P17	—	☐	●	☐	ALT	Discharge temp. TD2 error	I/F
P18	P18	—	☐	●	☐	ALT	Discharge temp. TD3 error	I/F
P19	P19	Detected outdoor unit number	☐	●	☐	ALT	4-way valve inverse error	I/F
P20	P20	—	☐	●	☐	ALT	High-pressure protective operation	I/F
P22	P22	#0: Element short circuit #E: Vdc voltage error #1: Position detection circuit error #2: Input current sensor error #3: Motor lock error #C: Sensor temperature error (No TH sensor) #4: Motor current error #D: Sensor short circuit/release error (No TH sensor) #5: Synchronization/step-out error *Put in Fan IPDU No. in [#] mark.	☐	●	☐	ALT	Outdoor unit fan IPDU error	IPDU
P26	P26	01: Comp. 1 side 02: Comp. 2 side	☐	●	☐	ALT	G-TR short protection error	IPDU

Check code			Wireless remote controller				Check code name	Judging device
Wired remote controller display	Outdoor unit 7-segment display		Sensor block display of receiving unit					
		Auxiliary code	Operation	Timer	Ready	Flash		
P29	P29	01: Comp. 1 side 02: Comp. 2 side	□	●	□	ALT	Comp, position detective circuit system error	IPDU
P31	—	—	□	●	□	ALT	Other indoor unit error (Group follower indoor unit error)	Indoor unit

\*1 Number of IPDU

01: Compressor 1 error

02: Compressor 2 error

03: Compressor 1 and 2 error

08: Fan 1 error

09: Compressor 1, Fan 1 error

0A: Compressor 2, Fan 1 error

0B: Compressor 1 and 2, Fan 1 error

11: Compressor 1, Fan 2 error

12: Compressor 2, Fan 2 error

13: Compressor 1 and 2, Fan 2 error

18: Fan 1 and 2 error

19: Compressor 1, Fan 1 and 2 error

1A: Compressor 2, Fan 1 and 2 error

1B: All

### Error detected by TCC-LINK central control device

Check code			Wireless remote controller				Check code name	Judging device
Central control device indication	Outdoor unit 7-segment display		Sensor block display of receiving unit					
		Auxiliary code	Operation	Timer	Ready	Flash		
C05	—	—		—			Sending error in TCC-LINK central control device	TCC-LINK
C06	—	—		—			Receiving error in TCC-LINK central control device	TCC-LINK
C12	—	—		—			Batch alarm of general-purpose equipment control interface	General-purpose equipment, I/F
P30	Differs according to error contents of unit with occurrence of alarm						Group control follower unit error	TCC-LINK
	—	—		(L20 is displayed.)			Duplication addresses of indoor units in TCC-LINK central control device	

TCC-LINK: TOSHIBA Carrier Communication Link.

# 13 Specifications

Model	Sound pressure level (dBA)		Weight (kg)
	Cooling	Heating	
MMD-AP0726HP-E	44	44	97
MMD-AP0966HP-E	46	46	97

## Declaration of Conformity

Manufacturer: TOSHIBA CARRIER (THAILAND) CO., LTD.  
144/9 Moo 5, Bangkadi Industrial Park, Tivanon road, Tambol Bangkadi,  
Amphur Muang, Pathumthani 12000, Thailand

Authorized Representative/TCF holder: Nick Ball  
Toshiba EMEA Engineering Director  
Toshiba Carrier UK Ltd.  
Porsham Close, Belliver Industrial Estate,  
PLYMOUTH, Devon, PL6 7DB.  
United Kingdom

Hereby declares that the machinery described below:

Generic Denomination: Air Conditioner

Model/type: MMD-AP0726HP-E,  
MMD-AP0966HP-E

Commercial name: Super Modular Multi System Air Conditioner  
Super Heat Recovery Multi System Air Conditioner  
Mini-Super Modular Multi System Air Conditioner (MiNi-SMMS series)

Complies with the provisions of the "Machinery" Directive (Directive 2006/42/EC) and the regulations transposing into national law

### "Declaration of incorporation of partly completed machinery"

Must not be put into service until the final machinery into which it is to be incorporated has been declared in conformity with the provisions of this Directive, where appropriate.

### NOTE

This declaration becomes invalid if technical or operational modifications are introduced without the manufacturer's consent.

## Warnings on Refrigerant Leakage

### Check of concentration limit

The room in which the air conditioner is to be installed requires a design that in the event of refrigerant gas leaking out, its concentration will not exceed a set limit.

The refrigerant R410A which is used in the air conditioner is safe, without the toxicity or combustibility of ammonia, and is not restricted by laws to be imposed which protect the ozone layer. However, since it contains more than air, it poses the risk of suffocation if its concentration should rise excessively. Suffocation from leakage of R410A is almost non-existent. With the recent increase in the number of high concentration buildings, however, the installation of multi air conditioner systems is on the increase because of the need for effective use of floor space, individual control, energy conservation by curtailing heat and carrying power etc.

Most importantly, the multi air conditioner system is able to replenish a large amount of refrigerant compared with conventional individual air conditioners. If a single unit of the multi conditioner system is to be installed in a small room, select a suitable model and installation procedure so that if the refrigerant accidentally leaks out, its concentration does not reach the limit (and in the event of an emergency, measures can be made before injury can occur).

In a room where the concentration may exceed the limit, create an opening with adjacent rooms, or install mechanical ventilation combined with a gas leak detection device. The concentration is as given below.

$$\frac{\text{Total amount of refrigerant (kg)}}{\text{Min. volume of the indoor unit installed room (m}^3\text{)}} \leq \text{Concentration limit (kg/m}^3\text{)}$$

The concentration limit of R410A which is used in multi air conditioners is 0.3 kg/m<sup>3</sup>.

#### ▼ NOTE 1

If there are 2 or more refrigerating systems in a single refrigerating device, the amounts of refrigerant should be as charged in each independent device.

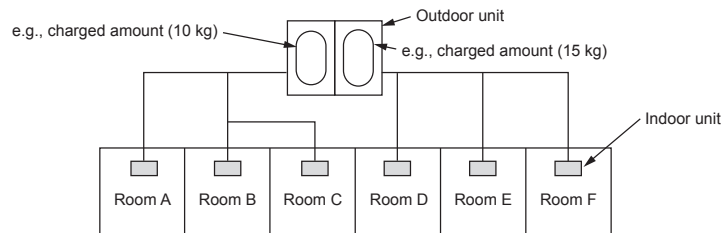

For the amount of charge in this example:

The possible amount of leaked refrigerant gas in rooms A, B and C is 10 kg.

The possible amount of leaked refrigerant gas in rooms D, E and F is 15 kg.

#### ▼ NOTE 2

The standards for minimum room volume are as follows.

- 1) No partition (shaded portion)

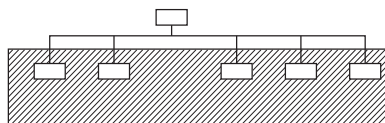

### Important

- 2) When there is an effective opening with the adjacent room for ventilation of leaking refrigerant gas (opening without a door, or an opening 0.15 % or larger than the respective floor spaces at the top or bottom of the door).

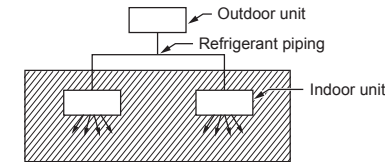

- 3) If an indoor unit is installed in each partitioned room and the refrigerant piping is interconnected, the smallest room of course becomes the object. But when a mechanical ventilation is installed interlocked with a gas leakage detector in the smallest room where the density limit is exceeded, the volume of the next smallest room becomes the object.

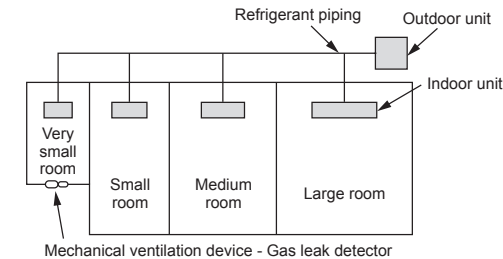

#### ▼ NOTE 3

The minimum indoor floor area compared with the amount of refrigerant is roughly as follows: (When the ceiling is 2.7 m high)

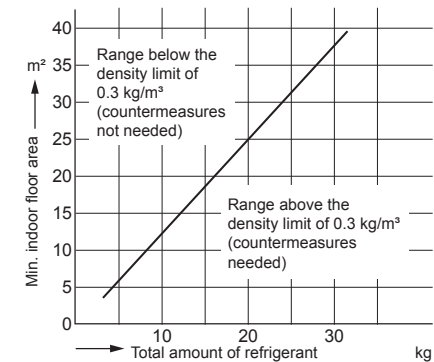

## Confirmation of indoor unit setup

Prior to delivery to the customer, check the address and setup of the indoor unit, which has been installed in this time and fill the check sheet (Following table). Data of four units can be entered in this check sheet. Copy this sheet according to the No. of the indoor units. If the installed system is a group control system, use this sheet by entering each line system into each installation manual attached to the other indoor units.

### REQUIREMENT

This check sheet is required for maintenance after installation. Fill this sheet and then pass this Installation Manual to the customers.

### Indoor unit setup check sheet

Indoor unit		Indoor unit		Indoor unit		Indoor unit	
Room name	Room name	Room name	Room name	Room name	Room name	Room name	Room name
Model	Model	Model	Model	Model	Model	Model	Model
Check indoor unit address. (For check method, refer to APPLICABLE CONTROLS in this manual.)							
*In case of a single system, it is unnecessary to enter the indoor address. (CODE NO.: Line [12], Indoor [13], Group [14], Central control [03])							
Line	Indoor	Group	Line	Indoor	Group	Line	Indoor
Central control address		Central control address		Central control address		Central control address	
Various setup		Various setup		Various setup		Various setup	

Have you changed high ceiling setup? If not, fill check mark [x] in [NO CHANGE], and fill check mark [x] in [ITEM] if changed, respectively.  
(For check method, refer to APPLICABLE CONTROLS in this manual.) \*In case of replacement or jumper blocks on indoor microcomputer p.c. board, setup is automatically changed.

External static pressure (CODE NO. [5d])	External static pressure (CODE NO. [5d])	External static pressure (CODE NO. [5d])	External static pressure (CODE NO. [5d])
<input type="checkbox"/> NO CHANGE	<input type="checkbox"/> NO CHANGE	<input type="checkbox"/> NO CHANGE	<input type="checkbox"/> NO CHANGE
<input type="checkbox"/> STANDARD	<input type="checkbox"/> STANDARD	<input type="checkbox"/> STANDARD	<input type="checkbox"/> STANDARD
<input type="checkbox"/> STATIC 1	<input type="checkbox"/> STATIC 1	<input type="checkbox"/> STATIC 1	<input type="checkbox"/> STATIC 1
<input type="checkbox"/> STATIC 2	<input type="checkbox"/> STATIC 2	<input type="checkbox"/> STATIC 2	<input type="checkbox"/> STATIC 2
<input type="checkbox"/> STATIC 3	<input type="checkbox"/> STATIC 3	<input type="checkbox"/> STATIC 3	<input type="checkbox"/> STATIC 3
<input type="checkbox"/> STATIC 4	<input type="checkbox"/> STATIC 4	<input type="checkbox"/> STATIC 4	<input type="checkbox"/> STATIC 4
<input type="checkbox"/> STATIC 5	<input type="checkbox"/> STATIC 5	<input type="checkbox"/> STATIC 5	<input type="checkbox"/> STATIC 5
<input type="checkbox"/> STATIC 6	<input type="checkbox"/> STATIC 6	<input type="checkbox"/> STATIC 6	<input type="checkbox"/> STATIC 6

Have you changed lighting time of filter sign? If not, fill check mark [x] in [NO CHANGE], and fill check mark [x] in [ITEM] if changed, respectively.  
(For check method, refer to APPLICABLE CONTROLS in this manual.)

Filter sign lighting time (CODE NO. [011])	Filter sign lighting time (CODE NO. [011])	Filter sign lighting time (CODE NO. [011])	Filter sign lighting time (CODE NO. [011])
<input type="checkbox"/> NO CHANGE	<input type="checkbox"/> NO CHANGE	<input type="checkbox"/> NO CHANGE	<input type="checkbox"/> NO CHANGE
<input type="checkbox"/> NONE	<input type="checkbox"/> NONE	<input type="checkbox"/> NONE	<input type="checkbox"/> NONE
<input type="checkbox"/> 150H	<input type="checkbox"/> 150H	<input type="checkbox"/> 150H	<input type="checkbox"/> 150H
<input type="checkbox"/> 2500H	<input type="checkbox"/> 2500H	<input type="checkbox"/> 2500H	<input type="checkbox"/> 2500H
<input type="checkbox"/> 5000H	<input type="checkbox"/> 5000H	<input type="checkbox"/> 5000H	<input type="checkbox"/> 5000H
<input type="checkbox"/> 10000H	<input type="checkbox"/> 10000H	<input type="checkbox"/> 10000H	<input type="checkbox"/> 10000H

Have you changed detected temp, shift value? If not, fill check mark [x] in [NO CHANGE], and fill check mark [x] in [ITEM] if changed, respectively.  
(For check method, refer to APPLICABLE CONTROLS in this manual.)

Detected temp, shift value setup (CODE NO. [06])	Detected temp, shift value setup (CODE NO. [06])	Detected temp, shift value setup (CODE NO. [06])	Detected temp, shift value setup (CODE NO. [06])
<input type="checkbox"/> NO CHANGE	<input type="checkbox"/> NO CHANGE	<input type="checkbox"/> NO CHANGE	<input type="checkbox"/> NO CHANGE
<input type="checkbox"/> NO SHIFT	<input type="checkbox"/> NO SHIFT	<input type="checkbox"/> NO SHIFT	<input type="checkbox"/> NO SHIFT
<input type="checkbox"/> +1°C	<input type="checkbox"/> +1°C	<input type="checkbox"/> +1°C	<input type="checkbox"/> +1°C
<input type="checkbox"/> +2°C	<input type="checkbox"/> +2°C	<input type="checkbox"/> +2°C	<input type="checkbox"/> +2°C
<input type="checkbox"/> +3°C	<input type="checkbox"/> +3°C	<input type="checkbox"/> +3°C	<input type="checkbox"/> +3°C
<input type="checkbox"/> +4°C	<input type="checkbox"/> +4°C	<input type="checkbox"/> +4°C	<input type="checkbox"/> +4°C
<input type="checkbox"/> +5°C	<input type="checkbox"/> +5°C	<input type="checkbox"/> +5°C	<input type="checkbox"/> +5°C
<input type="checkbox"/> +6°C	<input type="checkbox"/> +6°C	<input type="checkbox"/> +6°C	<input type="checkbox"/> +6°C

**Incorporation of parts sold separately**

**Incorporation of parts sold separately**

**Incorporation of parts sold separately**

**Incorporation of parts sold separately**

Have you incorporated the following parts sold separately? If incorporated, fill check mark [x] in each [ITEM].  
(When incorporating, the setup change is necessary in some cases. For setup change method, refer to Installation Manual attached to each part sold separately.)

<input type="checkbox"/> Others ( )	<input type="checkbox"/> Others ( )	<input type="checkbox"/> Others ( )	<input type="checkbox"/> Others ( )
<input type="checkbox"/> Others ( )	<input type="checkbox"/> Others ( )	<input type="checkbox"/> Others ( )	<input type="checkbox"/> Others ( )

**TOSHIBA CARRIER (THAILAND) CO.,LTD.**

**144/9 MOO 5, BANGKADI INDUSTRIAL PARK, TIVANON ROAD, TAMBOL BANGKADI,  
AMPHUR MUANG, PATHUMTHANI 12000, THAILAND.**

**1117880199**