

Model name:

RBC-AMS54E-ES

RBC-AMS54E-EN



- Read this manual before using the RBC-AMS54E-ES, RBC-AMS54E-EN remote controller.
- Refer to the Installation Manual supplied with the indoor unit for any installation instructions other than operations of the remote controller.

Contents



Precautions for Safety	2
Accessory Parts	3
Installation	4
Requirements to install the remote controller	4
Install the remote controller	6
Wire the remote controller	7
Requirements for wiring of group control	7
Requirements for installing two remote controllers	7
For first use	9
Note	9
Part Names and Functions	10
Monitor screen	11
Initial setting	12
1. Clock	12
2. Name of room	13
3. Screen contrast	14
4. Backlight	15
5. Key lock	16
6. Header/Follower	17
7. Language	18
8. Press & hold 4sec	19
Field setting menu	20
1. Test mode	20
2. Register service info	22
3. Alarm history	26
4. Monitor function	27
5. Setting louver position	28
6. Setting timer operation mode	29
7. DN setting	30

Precautions for Safety

- Read these "Precautions for Safety" carefully before installation.
- The precautions described below include important items regarding safety. Observe them without fail. Understand the following details (indications and symbols) before reading the body text, and follow the instructions.
- Ask customer to keep this Manual at accessible place for future reference.

Indication	Meaning of Indication
 WARNING	Text set off in this manner indicates that failure to adhere to the directions in the warning could result in serious bodily harm (*1) or loss of life if the product is handled improperly.
 CAUTION	Text set off in this manner indicates that failure to adhere to the directions in the caution could result in minor bodily injury (*2) or damage (*3) to property if the product is handled improperly.





- *1: Serious bodily harm indicates loss of eyesight, injury, burns, electric shock, bone fracture, poisoning, and other injuries which leave aftereffect and require hospitalization or long-term treatment as an outpatient.
 *2: Bodily injury indicates injury, burns, electric shock, and other injuries which do not require hospitalization or long-term treatment as an outpatient.
 *3: Damage to property indicates damage extending to buildings, household effects, domestic livestock, and pets.

Symbols	Meaning of Symbols
	"⊘" Indicates prohibited items. The actual contents of the prohibition are indicated by a picture or text placed inside or next to the graphic symbol.
	"ⓘ" Indicates compulsory (mandatory) items. The actual contents of the obligation indicated by a picture or text placed inside or next to the graphic symbol.

 **WARNING**

	<ul style="list-style-type: none"> • Only a qualified installer or service person is allowed to do installation work. Inappropriate installation may result in water leakage, electric shock or fire. • Perform installation work properly according to the Installation Manual. Inappropriate installation may result in water leakage, electric shock or fire. • Electrical work must be performed by a qualified electrician in accordance with this installation manual. The work must satisfy all local, national and international regulations. Inappropriate work may result in electric shock or fire. • Use predefined wire and connect them certainly. Keep the connecting terminal free from external force. Improper wire connection or clamping may result in exothermic, fire or malfunction.
---	--

Accessory Parts

No.	Part name	Quantity
(1)	Screws M4 x 20 	2
(2)	Wood screws M3.8 x 16 	2
(3)	Owner's Manual 	1
(4)	Installation Manual (This manual) 	1
(5)	CD-ROM	1

Installation

■ Requirements to install the remote controller

◆ Installation place

- Install the remote controller at a height of 1 to 1.5 m from the floor so that the average temperature in the room can be detected.
- Do not install the remote controller in a place exposed to direct sunlight or direct outside air, such as the side of a window.
- Do not install the remote controller in a place behind something or to the rear side of an object, where air flow is not sufficient.
- Do not install the remote controller in a freezing box or refrigerator, as the remote controller is not waterproof.
- Install the remote controller vertically to the wall.

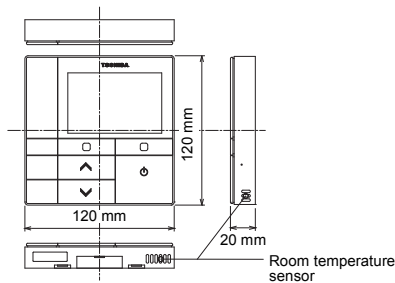

◆ Installation dimension

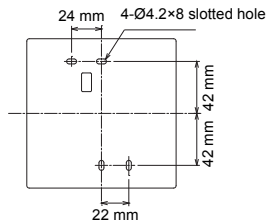

◆ Remote control wiring and inter-unit wiring between indoor units

Do not allow the wire for the remote controller (communication wire) and the wire for AC220-240 V to come into contact or put them together in one electrical conduit; otherwise, the control system may have trouble due to noise.

* Varies depending on the type of remote controller used.

Wiring type	VCTF: 0.5 mm ² to 2.0 mm ² x 2		
Total length of remote control wiring and inter-wiring between indoor units (L+L1+L2+...Ln)	1 remote controller	2 remote controllers	2 remote controllers including a wireless remote controller
	Up to 500 m	Up to 300 m	Up to 400 m
Total length of inter-wiring between indoor units (L1+L2+...Ln)	Up to 200 m		

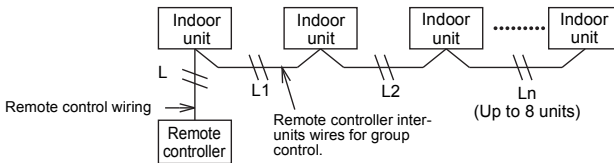

◆ Installation of multiple remote controllers

To install two or more adjacent remote controllers, follow the instructions in the Fig. 1 and 2.

(Fig. 1)

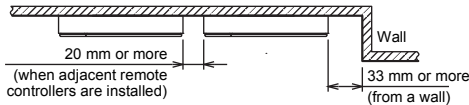

(Fig. 2)

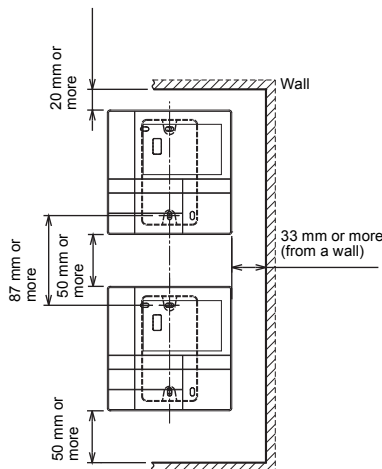

■ Install the remote controller

NOTE

- Wiring for the remote controller should not be bundled or installed in the same conduit with a power cable.; otherwise, malfunction may result.
- Install the remote controller away from sources of electrical interference and electromagnetic fields.

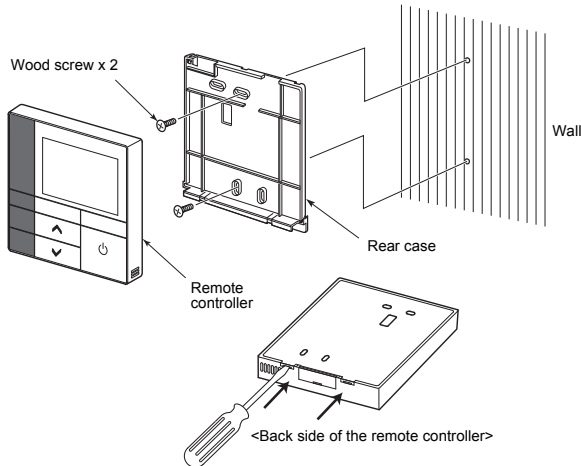

- 1** Insert a flat-blade screwdriver into the groove on the back side of the remote controller to remove the rear case.
- 2** Use the wood screws (2 pieces) supplied with the remote controller to attach the rear case of the remote controller to the wall. Do not use an electrical screwdriver. Do not over-tighten the screw (Tightening torque is up to 2 kg / f·cm.); otherwise, the rear case may be damaged.
- 3** Connect the electrical wire from the indoor unit to the terminal block of remote controller. (Refer to “■ Wire the remote controller”.)
Check the terminal number of electrical wire from the indoor unit to avoid miswiring. (If AC 200-240 V is applied, the remote controller and indoor unit will break down.)

■ Wire the remote controller

Wiring diagram

Terminal block for the remote control wiring on the indoor unit

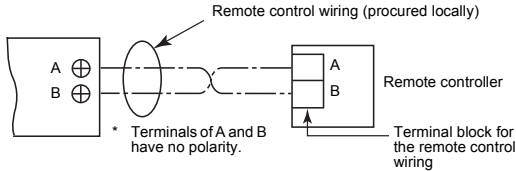

- * Use wire of 0.5 mm² to 2.0 mm².
- * A crimp-style terminal cannot be used.

■ Requirements for wiring of group control

To make wiring of group control for indoor units of 4-way cassette type and other types, set the 4-way cassette type as the header unit; otherwise, some settings such as the individual louver setting are not available.

■ Requirements for installing two remote controllers

In the dual remote controller system, one or more units are operated from two remote controllers. (Up to two remote controllers can be installed.)

Set the Follower remote controller

Set from "6. Header/Follower" in "Initial setting" on the MENU screen.
For details, refer to the page 17.

Install the remote controllers

For the dual remote controller system, install the remote controllers as follows:

- 1** Set one remote controller as the Header remote controller.
(The remote controllers are set as "Header remote controller" as factory default.)
- 2** When the dual remote controller system is installed by using this remote controller (RBC-AMS54E-ES, RBC-AMS54E-EN) with the other type of remote controller, set this remote controller as the Header remote controller.

Basic wiring diagram

NOTE

Terminals of A and B have no polarity.

To diverge from the indoor unit

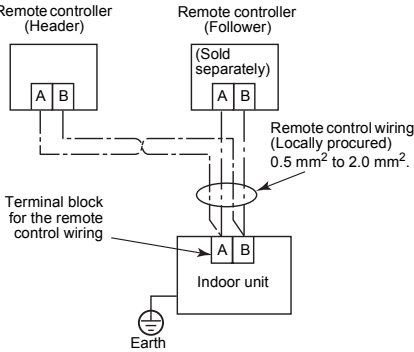

To diverge from the Header remote controller

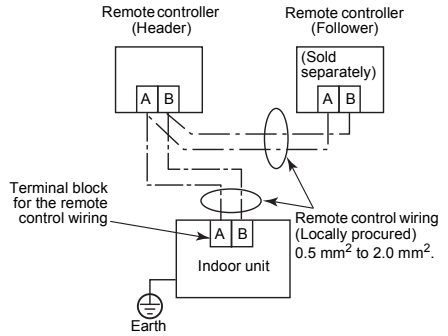

To operate a group control of multiple indoor units by two remote controllers

* The Header or Follower remote controller can be connected to any indoor unit.

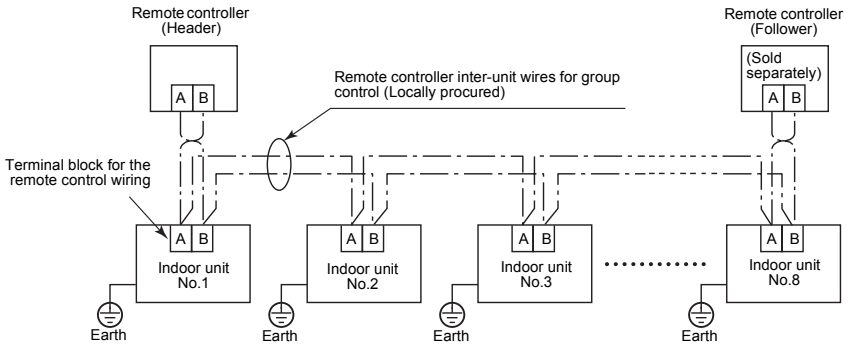

■ For first use

It takes some time before the remote controller becomes operable when the remote controller is used for the first time. This is not a malfunction.

<When the power is turned on for the first time after installation>

It takes about 5 minutes before the remote controller becomes operable.

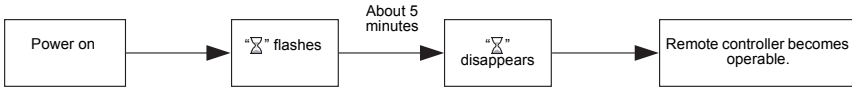

<When the power is turned on from the second time>

It takes about 1 minute before the remote controller becomes operable.

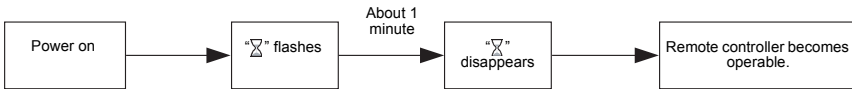

■ Note

For the operation of switching the room temperature sensor or the settings of the test operation, refer to the page 20.

Part Names and Functions

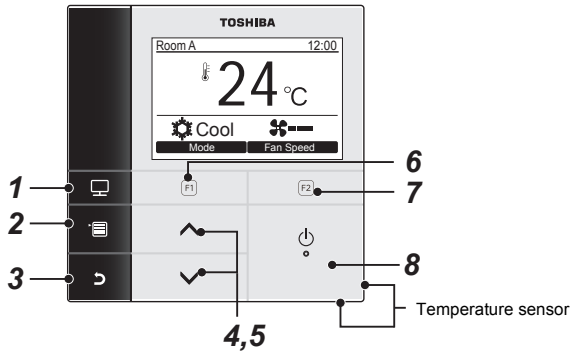

- 1** [] **MONITOR** button
Displays the monitoring screen.
- 2** [] **MENU** button
Displays the menu screen.
- 3** [] **CANCEL** button
Functions as indicated on the screen, such as returning to the previous menu screen.
- 4** [] **button**
During normal operation: adjusts the temperature.
On the menu screen: selects a menu item.
- 5** [] **button**
During normal operation: adjusts the temperature.
On the menu screen: selects a menu item.
- 6** [] **F1** button
Varies its function according to the setting screen.
- 7** [] **F2** button
Varies its function according to the setting screen.
- 8** [] **ON / OFF** button

Switching between the normal display and detailed display

Push and hold the [] **CANCEL** button and [] **MONITOR** button at the same time for more than 4 seconds to switch the display mode.

The normal display mode is selected as factory default setting.

Detailed display mode

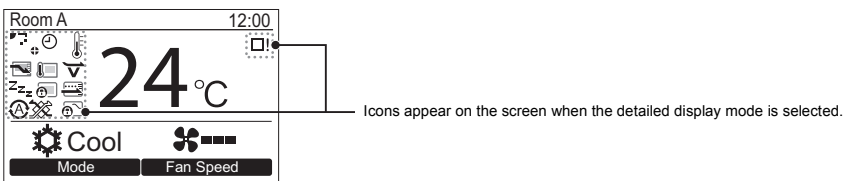

■ Monitor screen

Check the current usage status.

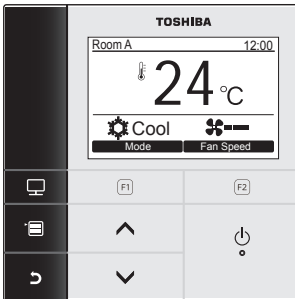

- 1** Push [MONITOR] button.
The monitor screen appears.
- 2** Push [CANCEL] button to return.

Monitor	
(1) Set temp.	24°C
(2) Indoor temp.	24°C
(3) Outdoor temp.	35°C
(4) Filter remaining hour	2500
(5) Total running hour	10480
Return	

- (1) Displays the set temperature.
- (2) Displays the temperature measured by the indoor temperature sensor of the indoor unit.
If the sensor is set to that of the remote controller, the temperature measured by the remote controller sensor is displayed.
- (3) Displays the temperature around the vent of the outdoor unit.
- (4) Displays the remaining time until the filter sign lights up.
- (5) Displays the accumulated operating time.

NOTE

Total running hour

- The Total running hour is recorded on the remote controller.
- The time is not recorded during Self cleaning operation or fan operation.

Outdoor temp.

- Displays the temperature around the vent of the outdoor unit.
- The displayed temperature may differ from the actual outdoor temperature.

Others

- The Header status appears during group connection.
- The screen returns to the previous display if no operation is performed for 60 seconds.

Initial setting

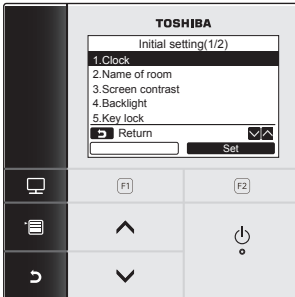

- 1** Push the [MENU] button to display the menu screen.
- 2** Push the [] / [] button to select “1. Initial setting” on the menu screen, then push the “ Set” [F2] button.
- 3** Push the [] / [] button to select an item on the “Initial setting” screen.
- 4** Push the “ Set” [F2] button.
→The selected menu setting screen will be displayed.
- 5** Push the [CANCEL] button to return.
→The screen returns to the “Initial setting” screen.

1. Clock

Set the Year, Month, Day, and time.

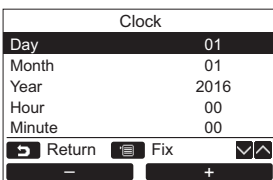
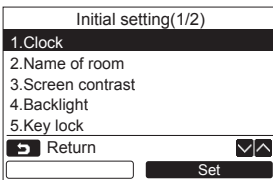

- 1** Push the [] / [] button to select “1. Clock” on the “Initial setting” screen, then push the “ Set” [F2] button.
- 2** Push the [] / [] button to select the Year, Month, Day, and time.
→Push the “ -” [F1] / “ +” [F2] button to set the value.
- 3** Push the [MENU] button.

To adjust the clock

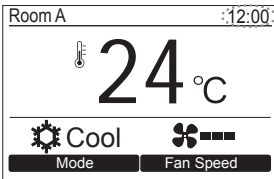
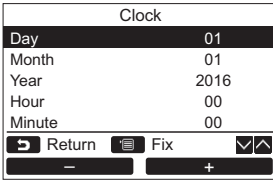

NOTE

The available date range is from January 1st, 2016 to December 31st, 2099.

1 Push the [▲ ▲] / [▼ ▼] button to select "1. Clock" on the "Initial setting" screen, then push the "Set" [F2] button.

2 Push the [▲ ▲] / [▼ ▼] button to select the Year, Month, Day, and time.
→ Push the "–" [F1] / "+" [F2] button to set the value.

3 Push the [MENU] button.
→ The screen returns to the "Initial setting" screen.

The clock display appears on the upper right of the screen.

- The clock display blinks if the clock setting has been reset due to power failure or other cause.

2. Name of room

Set the name of the room or place where the remote controller is installed. (Operations of the air conditioner are possible without this setting.)

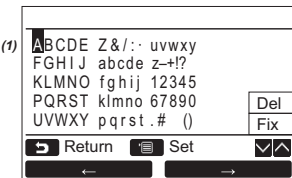
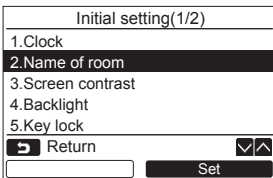

1 Push the [▲ ▲] / [▼ ▼] button to select "2. Name of room" on the "Initial setting" screen, then push the "Set" [F2] button.

2 Set the name of the remote controller.

Enter the characters of the name in the screen (1).

Move the cursor to select the character with the [▲ ▲] / [▼ ▼] button and "←" [F1] / "→" [F2] button (the selected character is highlighted), then push the [MENU] button.
Name of the remote controller appears.

Up to 16 characters can be entered for Name of room.

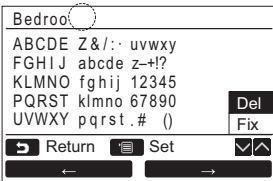

To delete a character, highlight “Del” and push [MENU] button.

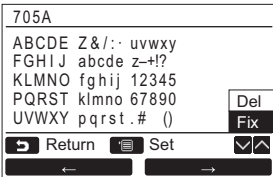

To confirm the name, highlight “Fix” and push [MENU] button.

→The screen returns to the “Initial setting” screen.

3. Screen contrast

Adjust the contrast of the LCD.

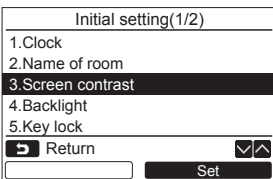

1 Push the [^ ^] / [v v] button to select “3. Screen contrast” on the “Initial setting” screen, then push the “Set Set” [F2] button.

2 Push the “-” [F1] / “+” [F2] button to adjust.

3 Push the [MENU] button.
→The screen returns to the “Initial setting” screen.

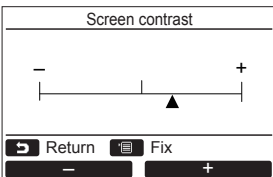

4. Backlight

Turn on or off the back light of the LCD.

Initial setting(1/2)	
1.Clock	
2.Name of room	
3.Screen contrast	
4.Backlight	
5.Key lock	
Return	
<input type="text"/>	<input type="text" value="Set"/>

Backlight	
<input checked="" type="radio"/> ON	
<input type="radio"/> OFF	
Return	Fix
<input type="text"/>	<input type="text"/>

1 Push the [^ ^] / [v v] button to select “4. Backlight” on the “Initial setting” screen, then push the “ Set” [F2] button.

2 Push the [^ ^] / [v v] button to select “ON” or “OFF”.

3 Push the [MENU] button.

→When “ON” is selected, the back light is turned on during operating with the remote controller.

→When “OFF” is selected, the back light is not turned on.

NOTE

- The back light of the LCD is turned on as factory default.
- The back light is on for a predetermined time after button operation.

5. Key lock

Select whether to lock / unlock [ON / OFF], [✔], [MODE](F1) and [FAN SPEED](F2).

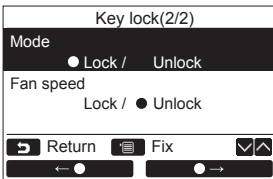
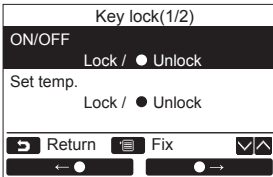
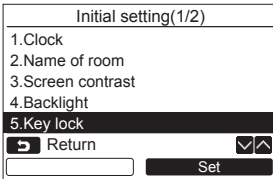

- 1 Push the [] / [] button to select “5. Key lock” on the “Initial setting” screen, then push the “ Set” [F2] button.
- 2 Push the [] / [] button to select a key to lock / unlock.
- 3 Push the “ ● ” [F1] button to select “Lock”, or “ ● ” [F2] button to select “Unlock”.
- 4 Push the [MENU] button.
 - When “Lock” is selected, the key cannot be used during key lock.
 - When “Unlock” is selected, the key can be used even during key lock.
 - All keys are unlocked while “Check” is displayed.
 - For the key lock setting, refer to the owner’s manual.
 - The factory default is “Lock”.

6. Header/Follower

Set the remote controller as “Header remote controller” or “Follower remote controller” when the dual remote controller system is used.

Carry out the setting operation while the indoor unit is stopped. (Turn off the air conditioning unit before starting the setting operation.)

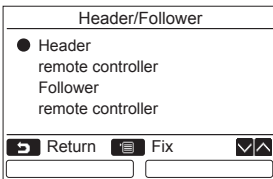
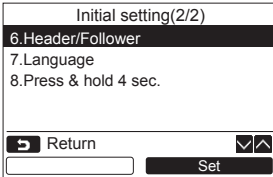

1 Push the [] / [] button to select “6. Header/Follower” on the “Initial setting” screen, then push the “ Set” [F2] button.

2 Push the [] / [] button to select the setting.

3 Push the [MENU] button.

→ “ Setting” appears on the screen, then the screen returns to the “Initial setting” screen.

Note for the Header/Follower setting

- Set the RBC-AMS54E-ES, RBC-AMS54E-EN remote controller as the Header remote controller when the dual remote controller system is used.
- The RBC-AMS54E-ES, RBC-AMS54E-EN remote controller can be used as the Follower remote controller when the dual remote controller system is used that consists of two RBC-AMS54E-ES, RBC-AMS54E-EN remote controllers.
- The following functions are not available when the remote controller is set as the Follower remote controller: Schedule timer / Off reminder timer / Night operation / Energy saving operation / Return back / Saving operation

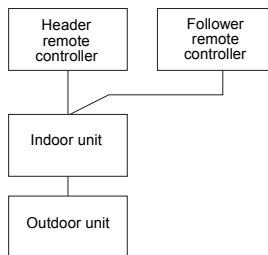

NOTE

- Some functions are not available when the remote controller is set as the Follower remote controller.
- In the dual remote controller system, the latter operation overrides the former.
- The remote controller is set as “Header remote controller” as factory default.
- If the Header/Follower remote controller settings are not set correctly, the “E01,” “E03,” or “E09” check code is displayed.

7. Language

Select a language for the screen text.

Initial setting(2/2)	
6.Header/Follower	
7.Language	
8.Press & hold 4 sec.	
Return	Set

1 Push the [] / [] button to select “7. Language” on the “Initial setting” screen, then push the “ Set” [F2] button.

2 Push the [] / [] button to select a language.

3 Push the [MENU] button.

The screen text changes to the selected language.

→The factory default is English.

These two screens appear for RBC-AMS54E-ES.

Language(1/2)	
● English	
French	Français
German	Deutsch
Spanish	Español
Portuguese	Português
Return	Fix

Language(2/2)	
● Dutch	
Nederlands	
Return	Fix



These two screens appear for RBC-AMS54E-EN.



Language(1/2)	
● English	
Italian	Italiano
Greek	Ελληνικό
Russian	Русский
Turkish	Türk
Return	Fix







Language(2/2)	
● Polish	
Polski	
Return	Fix





8. Press & hold 4sec.

Set the “Press & hold 4 sec.” operation for the [ ON / OFF] button.

Initial setting(2/2)	
6.Header/Follower	
7.Language	
8.Press & hold 4 sec.	
 Return	
<input type="text"/>	<input type="text" value="Set"/>

Press & hold 4sec.	
<input checked="" type="radio"/> ON	
<input type="radio"/> OFF	
 Return	 Fix 
<input type="text"/>	<input type="text"/>

1 Push the [ ] / [ ] button to select “8. Press & hold 4sec.” on the “Initial setting” screen, then push the “ Set” [ F2] button.

2 Push the [ ] / [ ] button to select “ON” or “OFF”.

3 Push the [ MENU] button.

→When “ON” is selected, the air-conditioner starts / stops running when the [ ON / OFF] button is pressed and hold 4 seconds.

→When “OFF” is selected, the air-conditioner starts / stops running when the [ ON / OFF] button is pressed.

Field setting menu

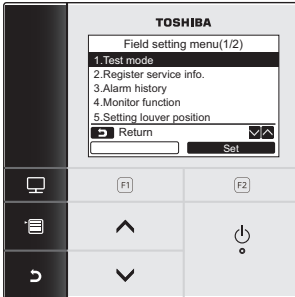

- 1 Push the [MENU] button to display the menu screen.
- 2 Push and hold the [MENU] button and the [↓] [↑] button at the same time to display the “Field setting menu”.
→ Push and hold the buttons for more than 4 seconds.
- 3 Push the [CANCEL] button to return.

Item	Function
1. Test mode	Settings for when performing the test operation after installation
2. Register service info	Registration of information about the contact number for service, model name and serial number of the indoor unit and outdoor unit
3. Alarm history	List of latest 10 alarm data: information of check code, date, time, and unit
4. Monitor function	Monitoring data of sensor temperature, rotating speed of the compressor or other factor.
5. Setting louver position	Change the louver indication setting to match the indoor unit type.
6. Setting timer operation mode	Set whether or not the operation mode can be selected when setting the schedule timer.
7. DN setting	Advanced settings using DN code

1. Test mode

Set for the test operation after installation.

Before the test mode

- Perform the followings before turning on the power:
 - 1) By using 500 V-megger, check that resistance of 1 MΩ or more exists between the terminal block of the power supply and the earth (earthing).
If resistance of less than 1 MΩ is detected, do not run the unit.
 - 2) Check all valve of the outdoor unit is opened fully.
- To protect the compressor at the time of startup, leave the power on for 12 hours or more before operation.
- Do not press the electromagnetic contactor to forcibly perform the test mode. (It is very dangerous because the protective device does not work.)
- Peel off the protective sheet affixed when the remote controller was shipped before performing a test run.

Performing the test mode

For the procedure of the operation, refer to the supplied Owner's Manual. A forced test mode can be performed according to the following procedure when the room temperature rises / falls enough for the thermostat to turn off. In order to prevent a continuous operation, the forced test operation is released after 60 minutes have passed and returns to the normal operation.

CAUTION

Do not perform the forced test mode for purposes other than the test mode because it applies an excessive load to the devices.

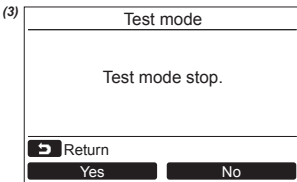
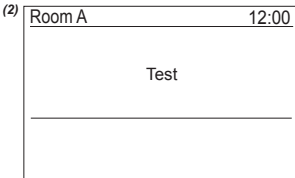
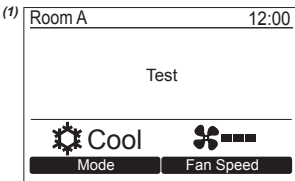
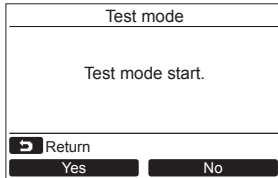
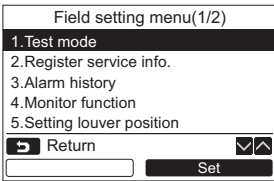

1 Push the [^ ^] / [v v] button to select “1. Test mode” on the “Field setting menu” screen, then push the “Set Set” [F2] button.

→ Pushing the “Yes Yes” [F1] button sets the test mode and the screen returns to the “Field setting menu” screen.
Push [CANCEL] twice, the screen (2) appears.

2 Push the [ON / OFF] button to start the test mode. The screen (1) shown in the left appears. (The screen (2) appears when the operation is stopped.)

→ Perform the test mode in the “Cool” or “Heat” mode.
→ Temperature setting cannot be adjusted during the test mode.
→ Check codes are displayed as usual.

3 When the test mode is finished, push the [^ ^] / [v v] button to select “1. Test mode” on the “Field setting menu” screen, then push the “Set Set” [F2] button.

The screen (3) appears.
→ Pushing the “Yes Yes” [F1] button stops the test mode screen and continues the normal operation.

NOTE

The test mode stops after 60 minutes and the screen returns to the normal / detailed display.

Using the Service monitor with the [MONITOR] button during the test mode

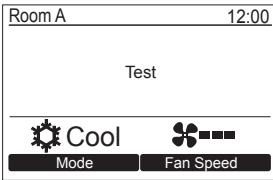

Push the [MONITOR] button

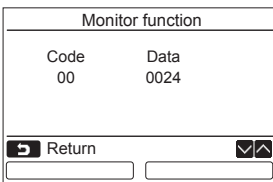

Refer to “4. Monitor function” (page 27) for details.

When the group control is used, select the unit to monitor in the unit selection screen before displaying the monitoring display.

2. Register service info.

Register information about the contact number for service, model name and serial number of the indoor unit and outdoor unit.

- Enter information manually for a Light commercial outdoor unit.
Information data of Light commercial indoor unit, VRF indoor unit, and VRF outdoor unit is loaded automatically. Automatic loading is not available for some models. In this case, enter information manually.
- Enter the contact number for service displayed in “2. Service information” of “14. information” on the menu screen.
- Enter the model name and serial number displayed in “1. Model information” of “14. information” on the menu screen.

Entering information manually

Register service info.	
1. Service contact tel No.	
2. Outdoor model name	
3. Outdoor unit serial No.	
4. Indoor model name	
5. Indoor unit serial No.	
Return	↕
<input type="text"/>	Set

- 1 Push the [] / [] button to select “2. Register service info.” on the Field setting menu screen.
- 2 Push the “ Set” [F2] button.
→ The setting screen for entering information appears.
- 3 Enter the information with the “ ←” [F1] / “ →” [F2] button and [] / [] button.

Item	Function
1. Service contact tel No.	Enter the contact number for service.
2. Outdoor model name	Enter / reset the model name of the outdoor unit.
3. Outdoor unit serial No.	Enter / reset the serial number of the outdoor unit.
4. Indoor model name	Enter / reset the model name of the indoor unit.
5. Indoor unit serial No.	Enter / reset the serial number of the indoor unit.

Entering the contact number for service

Register service info	
1. Service contact tel No.	
2. Outdoor model name	
3. Outdoor unit serial No.	
4. Indoor model name	
5. Indoor unit serial No.	
Return	↕
<input type="text"/>	Set

Service contact tel No.	
Input telephone number	
	- - - - -
Return	Fix
←	→

- 1 Push the [] / [] button to select “1. Service contact tel No.”, then push the “ Set” [F2] button.
- 2 Move the cursor to select the character (selected character is highlighted) with the “ ←” [F1] / “ →” [F2] button, then enter the contact number with the [] / [] button.
- 3 Push the [MENU] button.

Entering the model name and serial number

Enter the model name and serial number manually for a Light commercial outdoor unit. Information data is loaded automatically for Light commercial indoor units, VRF indoor units (excluding large capacity air discharge type and duct type), and VRF outdoor units. Enter the model name and serial number manually after replacing the circuit board to the service circuit board (unless entering information manually before replacement of the circuit board).

Product	Model name and serial number display
Light commercial indoor unit	Information data is loaded automatically from the indoor unit and displayed.
VRF indoor unit	Information data is loaded automatically from the indoor unit and displayed. Enter information manually for the indoor unit of large capacity air discharge type and duct type.
VRF outdoor unit	Information data is loaded automatically from the outdoor unit and displayed.
Light commercial outdoor unit	Enter information manually on the remote controller.
Service circuit board	Enter information manually on the remote controller.

<Flow chart of usual process>

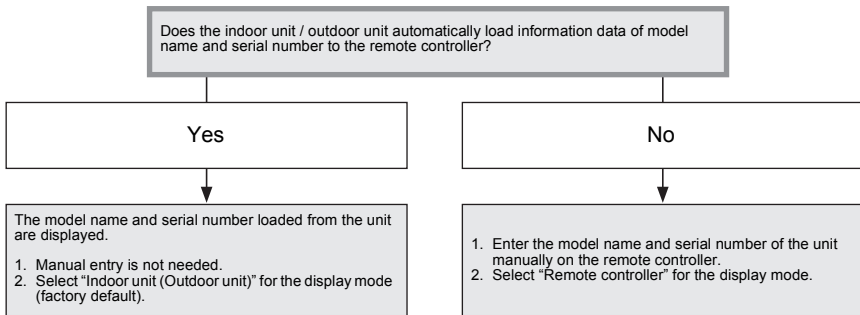

Entering the model name and serial number manually

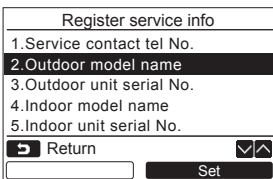

1 Push the [^ ^] / [v v] button to select **"2. Outdoor model name"** on the **"Register service info"** screen, then push the **"Set" [F2]** button.

→ Select "3. Outdoor unit serial No." to enter the serial number of the outdoor unit.

→ Select "4. Indoor model name" to enter the model name of the indoor unit.

→ Select "5. Indoor unit serial No." to enter the serial number of the indoor unit.

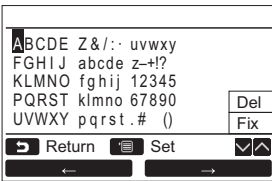
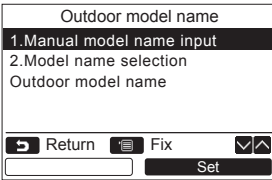

Selecting the model name and serial No.

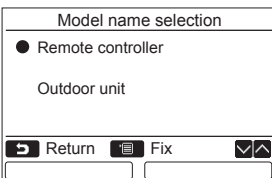
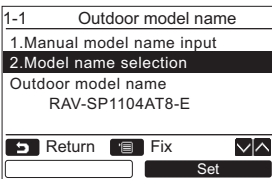

2 Push the [^ ^]/[v v] button to select “1. Manual model name input” on the “Outdoor model name” screen, then push the “ Set ” [F2] button.

- Select “1. Manual serial No. input” of “3. Outdoor unit serial No.” to enter the serial number of the outdoor unit.
- Select “1. Manual model name input” of “4. Indoor unit model name” to enter the model name of the indoor unit.
- Select “1. Manual serial No. input” of “5. Indoor unit serial No.” to enter the serial number of the indoor unit.

3 Enter the model name of the outdoor unit.

- See page 13 about how to enter the model name and serial number.

4 Select “Remote controller” for the display mode of model name or serial number to display the manually entered model name or serial number. (See page 13.)

1 Push the [^ ^]/[v v] button to select “2. Model name selection” on the “Outdoor model name” screen, then push the “ Set ” [F2] button.

- To select the serial number of the outdoor unit, select “2.Serial No. selection” of “3. Outdoor unit serial No.”.
- To select the model name of the indoor unit, select “2. Model name selection” of “4. Indoor unit model name”.
- To select the serial number of the indoor unit, select “2.Serial No. selection” of “5. Indoor unit serial No.”.

2 Push the [^ ^]/[v v] button to select “Remote controller” or “Outdoor unit”.

- When “Outdoor unit” or “Indoor unit” is selected, the model name or serial number received from the outdoor or indoor unit is displayed.
- When “Remote controller” is selected, the manually entered model name or serial number is displayed.
- The factory default is “Outdoor unit” or “Indoor unit”.

3 Push the [MENU] button.

- The screen returns to the “Outdoor model name” screen.

Checking the model name or serial number

The model name or serial number to be displayed on the Outdoor (Indoor) model name or Outdoor (Indoor) unit serial No. screen is displayed.

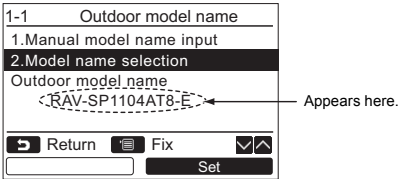

3. Alarm history

List of latest 10 alarm data: information of check code, date, time, and unit, is displayed.

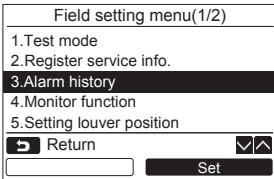

Alarm history				
	Unit	Code	Date	Time
1.	1-2	E04	31/12/2016	12:25
2.	-	-	-	-
3.	-	-	-	-
4.	-	-	-	-

At the bottom of the table, there are buttons for 'Return' and 'Reset'.

- 1 Push the [^ ^] / [v v] button to select “3. Alarm history” on the “Field setting menu” screen, then push the “Set” button.

List of latest 10 alarm data is displayed.

- * The oldest data are deleted in order to record the new ones.
- The date and time when the check code occurred for the first time is displayed for the repeated alarm.

Deleting the alarm history

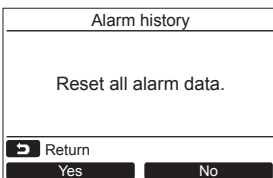

- 1 Push the “Reset” button while the list of Alarm history is displayed.

- 2 Push the “Yes” button after the confirmation screen is displayed.

→ Delete the Alarm history in each remote controller when the dual remote controller system is used.

4. Monitor function

The sensor temperature or operational status of indoor unit, outdoor unit, or remote controller can be monitored.

Monitor function	
Code	Data
00	0024
<input type="button" value="Return"/> <input type="button" value="Set"/>	
<input type="text"/>	<input type="text"/>

- 1 Push the [] / [] button to select “4. Monitor function” on the “Field setting menu” screen, then push the “ Set” [F2] button.

→ Push the [] / [] button to select the code to check data.

- 2 Refer to the Installation Manual supplied with the indoor unit or outdoor unit or service manual for details about the check code and data.

- 3 Push the [CANCEL] button to return to the “Field setting menu” screen.

5. Setting louver position

The louver indication setting can be changed.

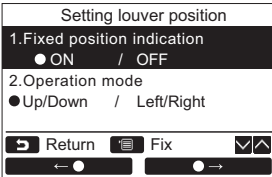

1 Push the [] / [] button to select “5. Setting louver position”, then push the “ Set” [F2] button.

→ “Impossible” is displayed in the case of a model for which the wind direction cannot be set.

→ ● is displayed for the selected item.

2 Push the [] / [] button to select an item on the “Field position indication” screen.

The highlighted item can be set.

→ Move ○ with the “ ●” [F1] / “ ●” [F2] button to set the setting.

3 After setting each item, push the “MENU” [MENU] button to confirm the changes to the settings.

Change the flap position indication for when swinging is cancelled in [Fixed position indicator].

→When “ON” is selected, the louver stops and the indication becomes as shown on the right when swinging is cancelled.
(Factory default)

→When “OFF” is selected, the stop position and indication becomes as shown on the right after swinging is cancelled.



Change the louver operation direction indication in [Operation mode].

→When “Up/Down” is selected, the louver operation direction indication becomes as shown on the right.
(Factory default)

→When “Left/Right” is selected, the louver operation direction indication becomes as shown on the right.

This can be used with a model whose louver moves left and right.

6. Setting timer operation mode

Set the operation mode setting in the setting timer operation mode.

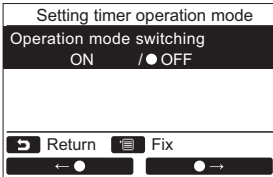

- 1 Push the [] / [] button to select “6. Setting timer operation mode”, then push the “ Set” [F2] button.
→ Move ● with the “ ● ” [F1] / “ ● ” [F2] button to set the setting.
● is displayed for the selected item.
- 2 Push the “MENU” button to confirm the change and return to the “Field setting menu” screen.
Push the “CANCEL” button to return to the “Field setting menu” screen without confirming the change.

7. DN setting

Perform the advanced settings for the air conditioner.

Carry out the setting operation while the indoor unit is stopped. (Turn off the air conditioning unit before starting the setting operation.)

- 1 Push the [] / [] button to select “7. DN setting” on the “Field setting menu” screen, then push the “ Set” [F2] button.

→The fan and louver of the indoor unit operate. When the group control is used, the fan and louver of the selected indoor unit operate.

→Move the cursor to select “Code(DN)” with the “ <” [F1] button, then set “Code(DN)” with the [] / [] button.

→Move the cursor to select “Data” with the “ >” [F2] button, then set “Data” with the [] / [] button.

- 2 Refer to the Installation Manual supplied with the indoor unit or service manual for details about the Code(DN) and Data.
- 3 Push the [MENU] button to set the other Code(DN) and Data. After “Continue?” is displayed on the screen, push the “ Yes” [F1] button.

- 4 Push the “ No” [F2] button to finish the setting operation. “ Setting” appears on the screen for a while, then the screen returns to the “Field setting menu” screen.

→Pushing the “ No” [F2] button displays the unit selection screen when the group control is used. Push the [CANCEL] button on the unit selection screen to finish the setting operation. “ Setting” appears on the screen for a while, then the screen returns to the “Field setting menu” screen.

NOTE

- The following changes are settings to be configured by installation and service personnel. If they are set incorrectly, trouble such as the product becoming inoperable may occur.
- For indoor units which do not support the functions below, the following DN code settings may not be possible.
- Do not perform header/follower connection for a remote controller which does not support the functions below.
- For operation when connected to an air conditioning control system which does not support the functions below, refer to “Changing the temperature” in the Owner’s Manual.

DN	Item	Description	Factory default
77	Dual set point setting	0000: Normal automatic 0002: Dual automatic	0000

TOSHIBA CARRIER CORPORATION