

TOSHIBA INSTALLATION MANUAL

Digital Inverter Air Conditioner “1 : 1 Model” Connection Interface

Use for Indoor Unit Only
MODEL : TCB-PCNT30TLE2

[For Installation Professionals]

- Before installation work, please read this manual thoroughly and install the products correctly.

Precaution for safety

WARNING

- **Ask an authorized dealer or qualified installation professional to install/maintain the air conditioner.**
Inappropriate installation may result in water leakage, electric shock or fire.
- **Perform installation work surely based on this Installation Manual.**
Incomplete installation causes an electric shock or a fire.
- **Ask an authorized dealer or qualified installation professional to reinstall 1 : 1 Model Connection Interface.**
Incomplete installation causes an electric shock or a fire.
- **For an electric work, this Installation Manual shall be referred and exclusive circuit shall be necessarily used. The used voltage shall be also match with the rated voltage of the product.**
If there is capacity shortage of electric circuit or installation work is poor, an electric shock or a fire may be caused.

CAUTION

- Using the specified wires, surely connect wires so that external force of wire is not applied to connecting part of the terminals; otherwise disconnection, heating or fire will generate.
- For wiring work, use wires with correct current capacity; otherwise leakage, heating or fire will generate.
- Do not apply an excessive force on the board body, otherwise bending, separation, or disconnection generates resulted in heating or fire.

- After installation work, execute a test run to confirm there is no trouble.
And also ask the customers to keep this Manual by themselves.

■ Components

- * When you will purchase the 4-way cassette type (RAV-SM**4UT*) or you will also purchase the compact 4-way cassette type (RAV-SM***MUT*), be sure to purchase “TCB-PX30MUE” sold separately, together with it. For installation, 1:1 Model Connection Interface board box of “TCB-PX30MUE” is necessary.

Name	Q'ty	Application
① P.C. board	1	1 : 1 model connection interface board
② U3, U4 terminal block	1	2P terminal block for relay (U3, U4)
③ Relay wire (A)	1	For connection of “1 : 1 Model” Connection Interface board with U3, U4 relay terminal block (Blue connector)
④ Relay wire (B)	1	For connection of “1 : 1 Model” Connection Interface board with indoor control board (Red connector)
⑤ Installation Manual	1	This manual
⑥ Spacer (A)	3	For fixing “1 : 1 Model” Connection Interface board (Used when installing P.C. board on sheet metal of the electric parts box of indoor unit)
⑦ Spacer (B)	1	For fixing “1 : 1 Model” Connection Interface board (Required according to shape of indoor unit)
⑧ Screws to fix terminal block	2	For fixing relay terminal block (M4 × 14L)
⑨ Bandling band	3	Used to process wires
⑩ Terminal nameplate	1	To be adhered near the relay terminal block

Before Installation

This interface corresponds to the digital inverter air conditioner.

Do not use or connect this interface for other type of air conditioner than the above because the indoor P.C. boards of other air conditioners differ from one of the digital inverter air conditioner.

Wiring Connection

1. Wiring connection

Remarks

- Point 1)** When controlling the digital inverter air conditioner collectively, "1 : 1 Model" Connection Interface (This option) is required.
- Point 2)** In group control or twin, triple, double twin system, this interface must be connected to Header unit of the indoor unit. (Connection to follower unit is unavailable.)
- Point 3)** Connect the central control devices to wires of the central control system.
- Point 4)** When controlling the digital inverter air conditioner collectively, turn on Bit 1 of SW01 in the line with the least line address No. (OFF has been set up at shipment from the factory.)

For the digital inverter air conditioner, re-setup of the address from the wired remote controller is required after automatic addressing.

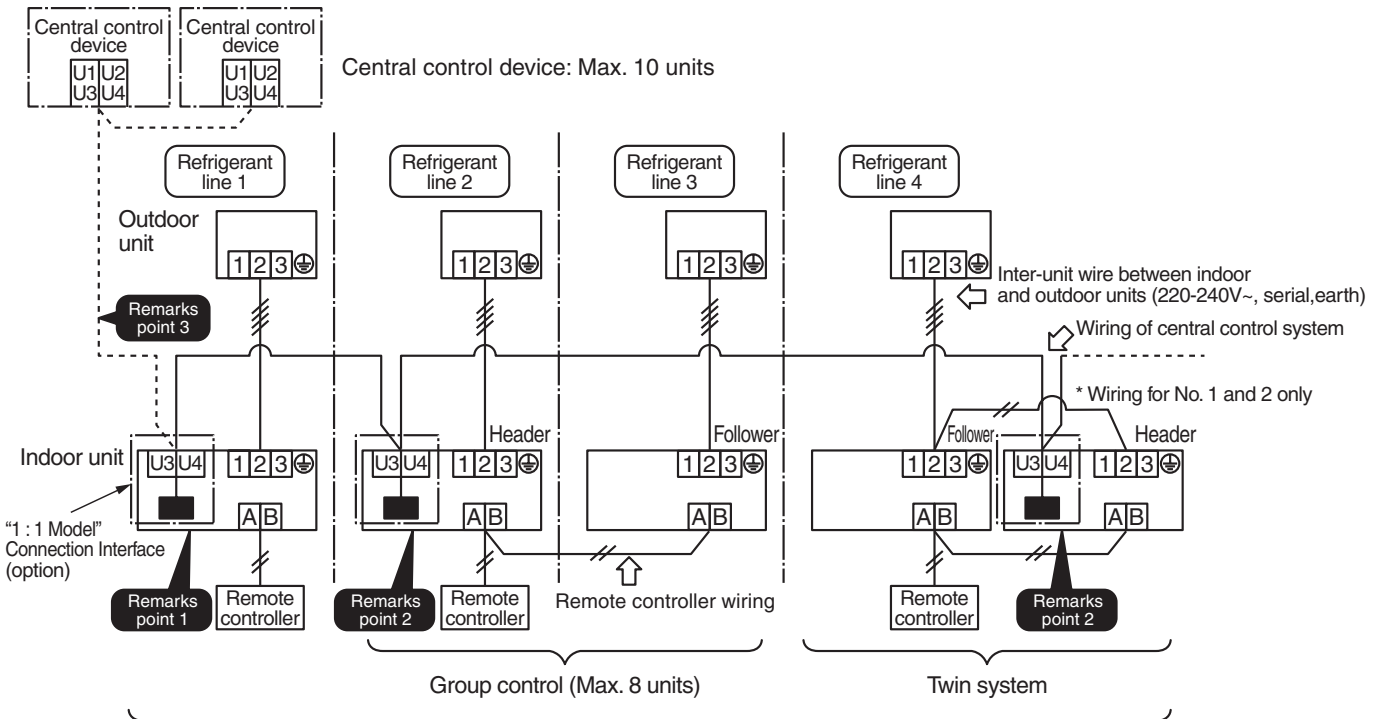

Max. 64 indoor units of all the refrigerant lines can be connected.
 [When mixed with VRF type (Link wiring), No. of indoor units of VRF type is also included.]
 * However, group, twin follower units of the digital inverter air conditioner are not included in No. of units.

VRF : Variable Refrigerant Flow

2. Wire Specifications

No. of wires	Size	Specifications
2	Up to 1000m, braided wire 1.25mm ²	2-core shield wire
	Up to 2000m, braided wire 2.0mm ²	

- Wire is 2-core and non-polarity.
- The length is same to wire length of the central control system.
In case of system mixed with VRF type, the length includes all length of control wiring between indoor unit and outdoor units at VRFside.
- To prevent noise defect, use 2-core shield wire.
- Connect shield wires with closed-terminal connection and apply open process (insulation process) to the last termination. For grounding (earth), perform grounding with one point at indoor unit side. (During central control for digital inverter air conditioner only)

Remarks

- Point 1)** Closed terminal connection of shield wire (Connection of connecting parts of each indoor unit)
- Point 2)** Apply open process (insulation process) to the last termination.
- Point 3)** For grounding (earth), perform grounding with one point at indoor unit side.

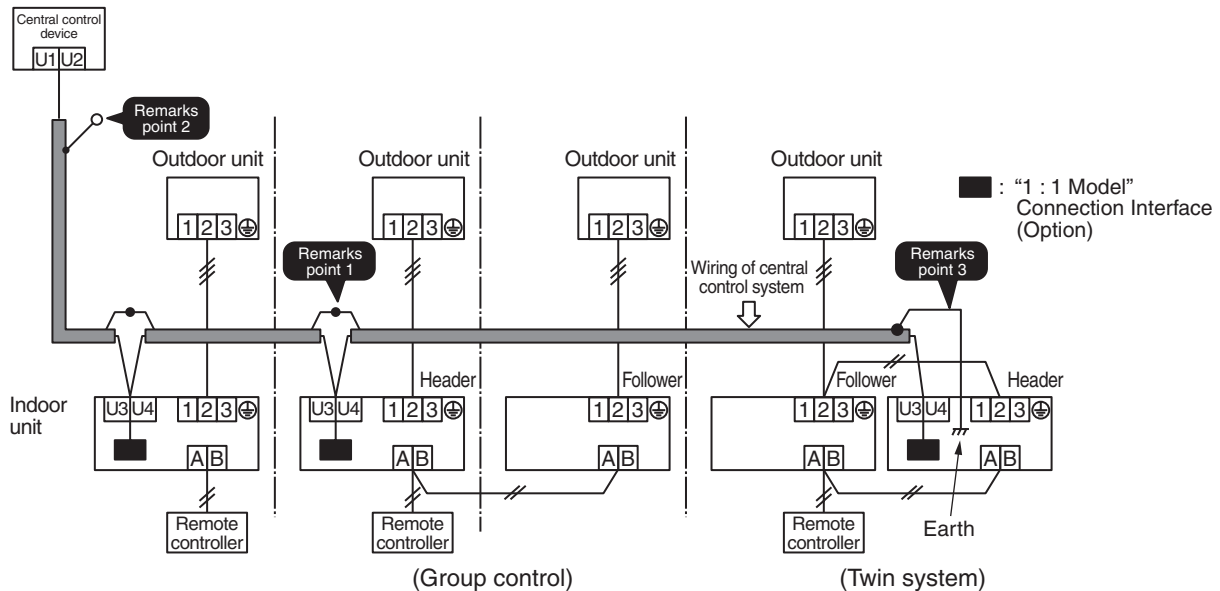

3. Wiring Diagram with Indoor Control P.C. Board

For details, refer to installation procedure for each model.

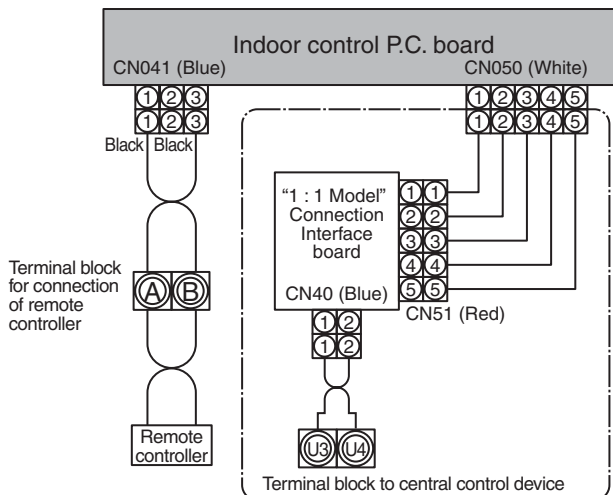

- Parts encircled with chain line are accessories attached to this product.
- indicates control P.C. board, and indicates terminal block (Characters inside of mark indicate terminal number.)
- There is no polarity for wire connection to terminal blocks U3 and U4.

(NOTE)

Do not apply voltage to terminals U3 and U4.

If applying voltage to U3 or U4 terminal by mistake, fusing occurs to protect terminals.

After checking wires, exchange connection of connecting connector on "1 : 1 Model" Connection Interface board from CN40 (Blue) to the spare CN44 (Brown).

Setup of P.C. Board Switch

When the units controlled collectively are all digital inverter air conditioners, it is required to set up the terminator resistor. (Collective control for units without VRF type air conditioner)

- Using SW01, set up the terminator resistor.
- **Set up the terminator resistor to only interface connected to the indoor unit in the line with the least line address No.**

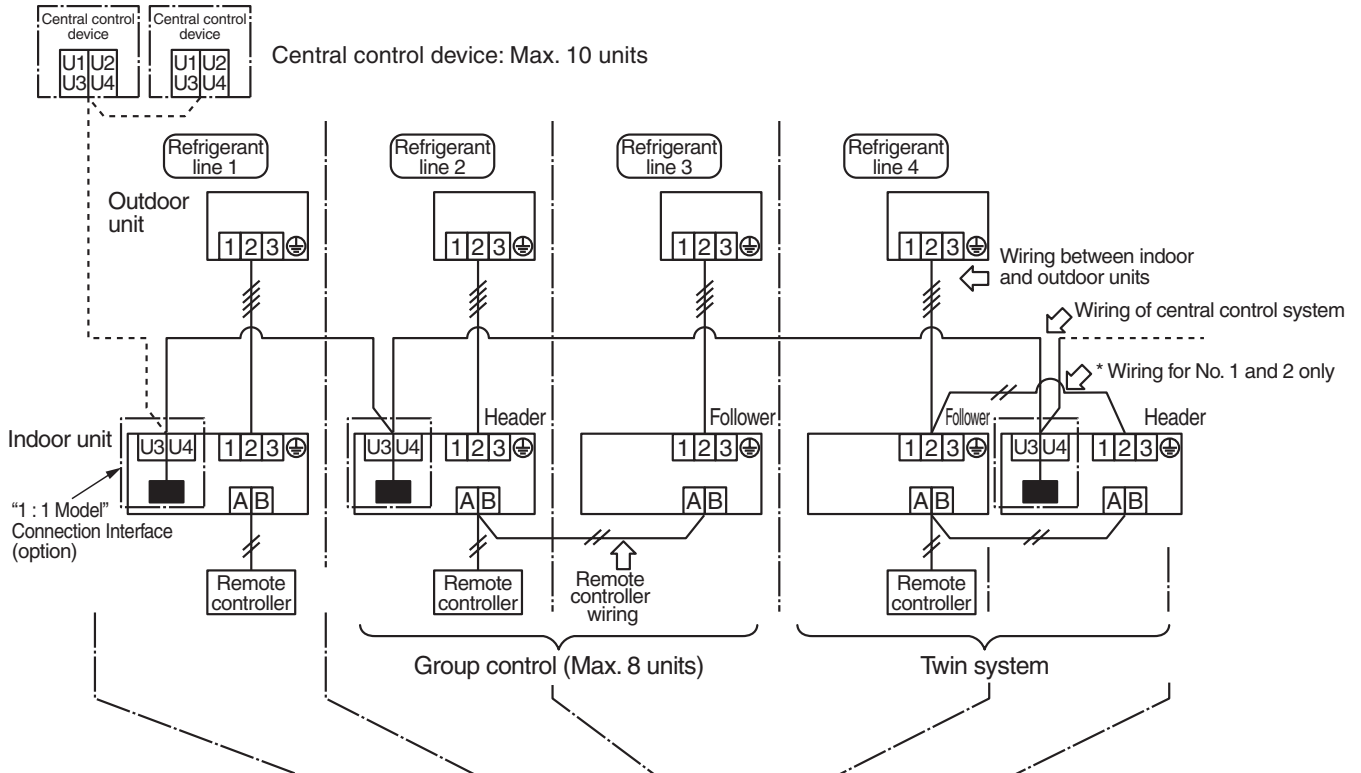

Line address	1	2	4	
SW01 bit 1	ON	OFF	OFF	(OFF when shipped from factory)
SW01 bit 2	OFF	OFF	OFF	(OFF when shipped from factory)
Remarks	Turn on SW01 bit 1.	As status at shipment from factory	As status at shipment from factory	

(Reference) Contents of switch setup

SW01		Terminator resistor	Remarks
Bit 1	Bit 2		
OFF	OFF	None	Mixed with VRF at shipment from factory (Link wiring)
ON	OFF	100Ω	Central control by digital inverter air conditioners
OFF	ON	75Ω	Spare
ON	ON	43Ω	Spare

Installation Procedure

- For installation of “1 : 1 Model” Connection Interface board and removal of relay wire, be sure to wait for a while (approx. 1 minute) after turning off the power supplies of the air conditioner and the collective control devices. If not doing so, “1 : 1 Model” Connection Interface board may be damaged.

■ 4-Way Cassette Type

⚠ CAUTION

In case to install 1:1 Model Connection Interface, be sure to purchase also “TCB-PX30MUE” sold separately. For installation, 1:1 Model Connection Interface board box of “TCB-PX30MUE” is necessary.

RAV-SM ** 4UT*

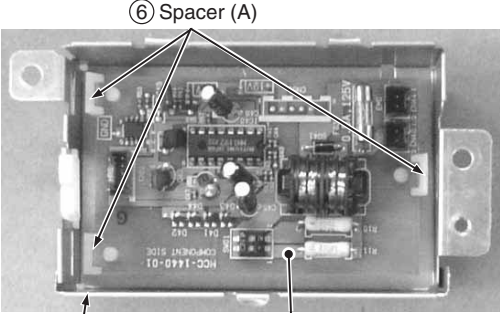
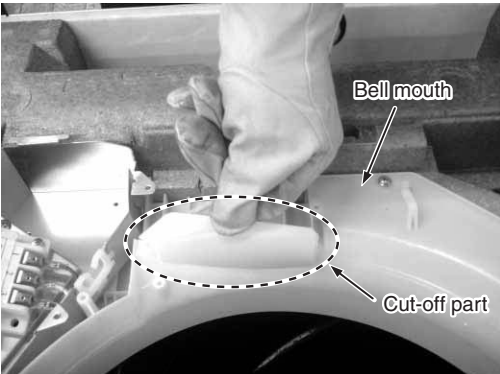
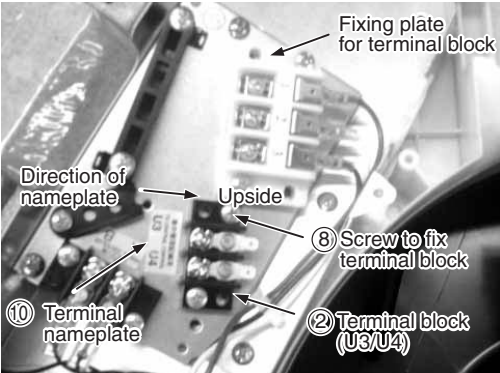
No.	Procedure	Details
1	Attach spacer (A) ⑥ to 1:1 Model Connection Interface board box of the “TCB-PX30MUE” sold separately, and then install P.C. board ①.	 <p style="text-align: center;">⑥ Spacer (A)</p> <p style="text-align: center;">① P.C. board</p> <p style="text-align: center;">1:1 Model Connection Interface board box (Attached to the TCB - PX30MUE)</p>
2	Cut off a part of the bell mouth, which is enclosed with dotted line shown in the right figure.	 <p style="text-align: center;">Bell mouth</p> <p style="text-align: center;">Cut-off part</p>
3	Mount terminal block (U3, U4) ② at the fixing plate position for terminal block as shown in the right figure of the electric parts box, with terminal block fixing screws (M4 × 14 l) ⑧. Stick the attached terminal nameplate ⑩ at near the terminal block along direction shown in the right figure.	 <p style="text-align: center;">Fixing plate for terminal block</p> <p style="text-align: center;">Direction of nameplate</p> <p style="text-align: center;">Upside</p> <p style="text-align: center;">⑧ Screw to fix terminal block</p> <p style="text-align: center;">⑩ Terminal nameplate</p> <p style="text-align: center;">② Terminal block (U3/U4)</p>

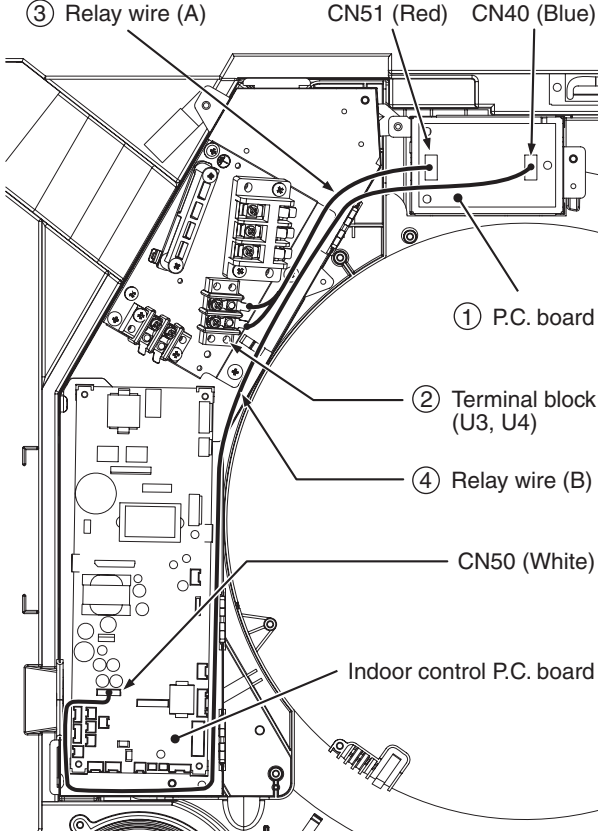
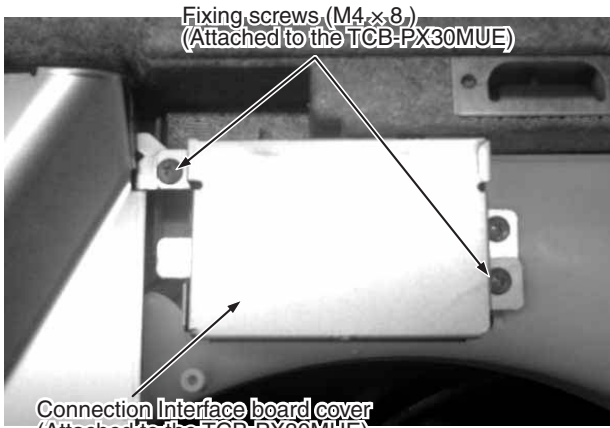
No	Procedure	Details
4	<p>Using a screw (M4 × 14) of “TCB-PX30MUE” sold separately, install 1:1 Model Connection Interface board box which was prepared in item No.1 at the position where the bell-mouth was cut off.</p>	 <p>Screw (M4 × 14) (Attached to the TCB-PX30MUE)</p>
5	<p>Mount the relay wire (A) ③ to Faston terminal on the relay terminal (U3, U4) ② and then connect the connector to CN40 (Blue) of the P.C. board ① .</p> <p>* For wiring connection of the relay wire (A) ③ , there is no plarity.</p> <p>Connect connector of the relay wire (B) ④ from CN50 (White) on the indoor P.C. board to CN51 (Red) on the P.C. board ① .</p>	 <p>③ Relay wire (A) CN51 (Red) CN40 (Blue)</p> <p>① P.C. board</p> <p>② Terminal block (U3, U4)</p> <p>④ Relay wire (B)</p> <p>CN50 (White)</p> <p>Indoor control P.C. board</p> <p>* ③ , ④ After wiring connection of the relay wires (A) and (B), fix wirings along the near wirings with banding band so that there is no catching of wires, and etc.</p>
6	<p>Install the Connection Interface board cover of the “TCB-PX30MUE” sold separately with the fixing screws (M4 × 8).</p>	 <p>Fixing screws (M4 × 8) (Attached to the TCB-PX30MUE)</p> <p>Connection Interface board cover (Attached to the TCB-PX30MUE)</p>

■ **4-way Cassette type**
(RAV-SM3UT-E, RAV-SM***UT-K, RAV-SM***UT-4C)**

No.	Procedure
1	Using board installing spacer (A), install "1 : 1 Model" Connection Interface board to the position of electric parts box of the indoor unit. (See the figure below.)
2	Using terminal block fixing screws, install U3, U4 terminal block to the position of electric parts box of the indoor unit. (See the figure below.) <ul style="list-style-type: none"> • When tightening the screws, be sure not to damage wires. • Adhere the attached nameplate near the relay terminal block.
3	Connect the relay wire (A) from U3, U4 terminal block to CN40 (Blue) of "1 : 1 Model" Connection Interface board. Connect the relay wire (B) from CN50 (White) on the indoor P.C. board to CN51 (Red) on "1 : 1 Model" Connection Interface board.

Details

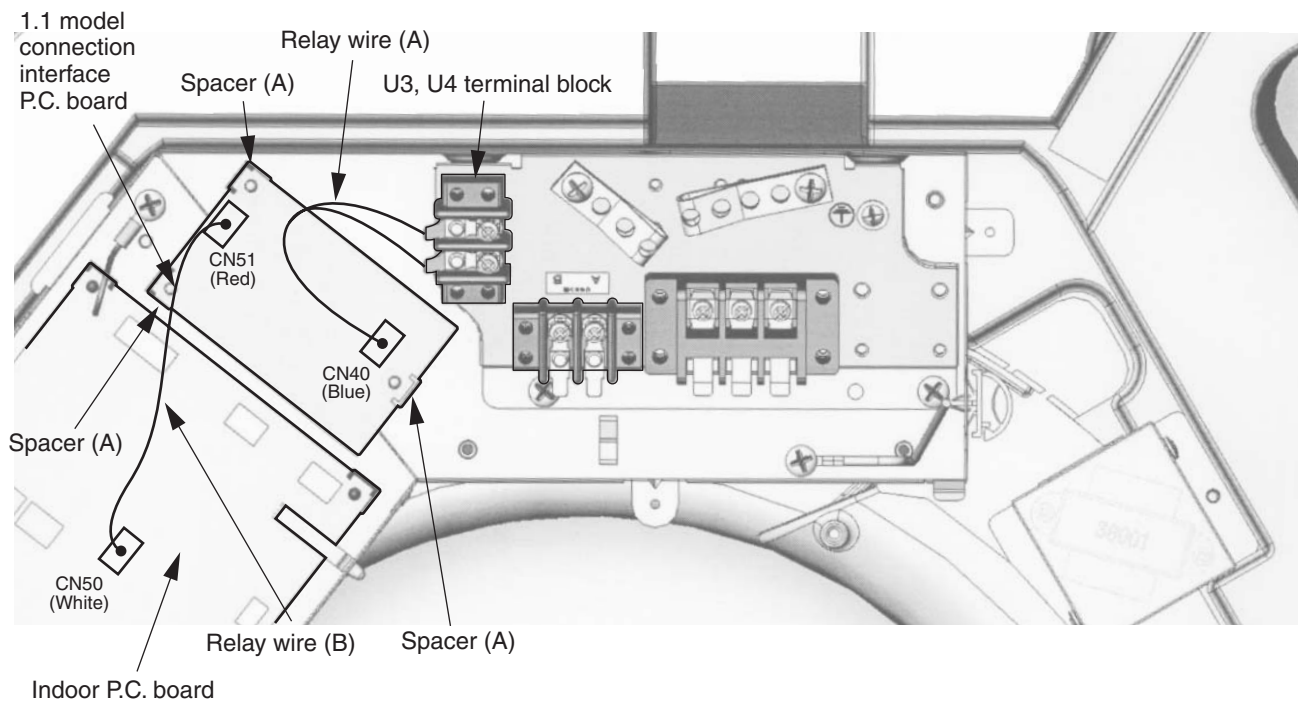

* Relay wire (A)

Connect U3, U4 terminal block with "1 : 1 Model" Connection Interface CN40 (Blue). There is no polarity for wire connection.

• Relay wire (B)

Connect CN50 (White) on indoor control P.C. board with CN51 (Red) on "1 : 1 Model" Connection Interface board.

- When installing "1 : 1 Model" Connection Interface board to electric parts box, insert three board installing spacers (A) into holes of P.C. board.

⚠ CAUTION

After connection of the relay wires (A) and (B), bind them with banding band so that wires are not caught in. In this time, be sure not to bind the relay wires (A) and (B) together with the power supply lines such as power cable, earth wire, etc.; otherwise a trouble may be caused.

■ Compact 4-way Cassette type

RAV-SM *** MUT*

⚠ CAUTION

In case to install 1:1 Model Connection Interface, be sure to purchase also "TCB-PX30MUE" sold separately. For installation, 1:1 Model Connection Interface board box of "TCB-PX30MUE" is necessary.

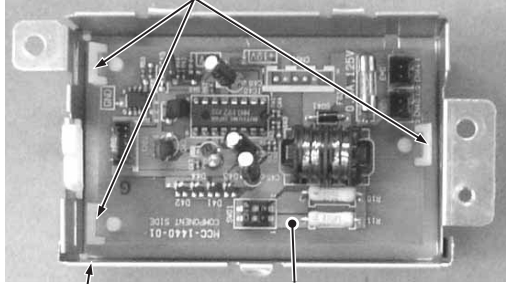
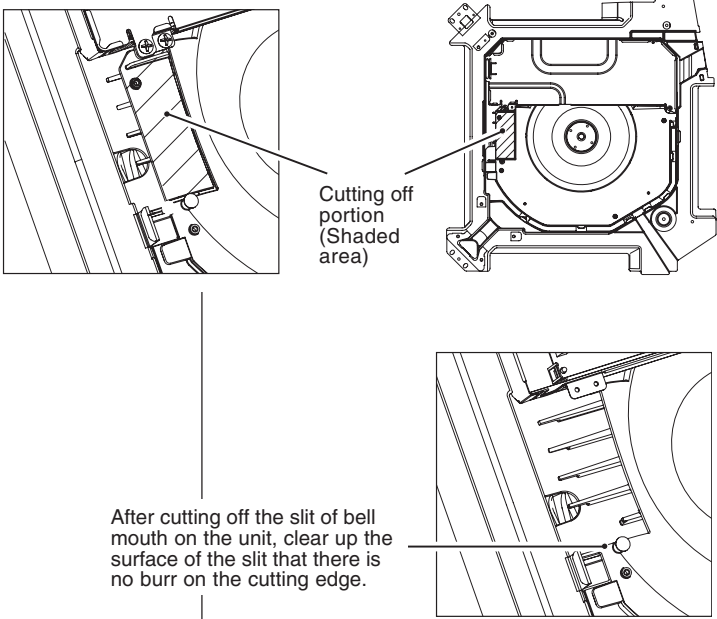
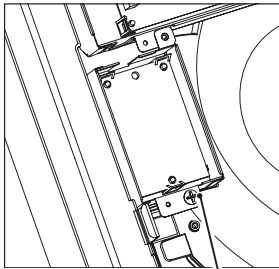
No.	Procedure	Details
1	Attach spacer (A) ⑥ to 1:1 Model Connection Interface board box of the "TCB-PX30MUE" sold separately, and then install P.C. board ①.	 <p>⑥ Spacer (A)</p> <p>① P.C. board</p> <p>1:1 Model Connection Interface board box (Attached to the TCB - PX30MUE)</p>
2	Cut off a part of the bell mouth, which is enclosed with dotted line shown in the right figure.	 <p>Cutting off portion (Shaded area)</p> <p>After cutting off the slit of bell mouth on the unit, clear up the surface of the slit that there is no burr on the cutting edge.</p>
3	Using a screw (M4 × 14) of "TCB-PX30MUE" sold separately, install 1:1 Model Connection Interface board box which was prepared in item No.1 at the position where the bell-mouth was cut off.	 <p>Screw (M4 × 14) (Attached to the TCB-PX30MUE)</p>

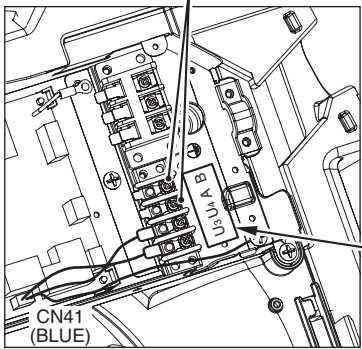
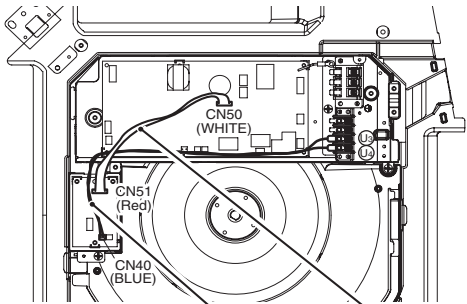
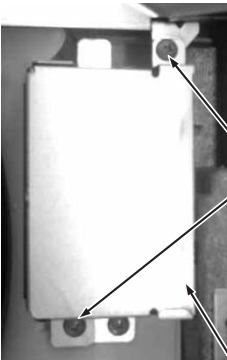
No.	Procedure	Details
4	<p>Remove the 2P terminal block for the communication wire of the electric parts box on the unit, and then replace with the 4P terminal block of the "TCB-PX30MUE" sold separately for the communication wire.</p> <ol style="list-style-type: none"> 1) Disconnect the lead wires on the 2P terminal block of the electric parts box . 2) Replace the 2P connector with 4P connector on the terminal block. 3) Connect the communication wire that are disconnected as shown above steps 1), to the 4P terminal block. 4) Stick the terminal nameplate of the "TCB-PX30MUE" (sold separately) at near the 4P terminal block along direction shown in the right figure. 	<p>(A), (B) terminals (Connecting for the Remote Controller)</p>  <p>Terminal nameplate</p> <p>(Attached to the TCB-PX30MUE)</p>
5	<p>Mount the relay wire (A) ③ to Faston terminal on the 4P terminal block (U3, U4) and then connect the connector to CN40 (Blue) of the P.C. board ① .</p> <p>*For wiring connection of the relay wire (A) ③ there is no plarity.</p> <p>Connect connector of the relay wire (B) ④ from CN50 (White) on the indoor P.C. board to CN51 (Red) on the P.C. board ① .</p>	 <p>④ Relay wire (B) ③ Relay wire (A)</p>
6	<p>Using the fixing screws (M4 x 8), attach the Connection Interface board cover of the "TCB-PX30MUE" sold separately.</p>	 <p>Fixing screws (M4 x 8) (Attached to the TCB-PX30MUE)</p> <p>Connection Interface board cover (Attached to the TCB-PX30MUE)</p>

■ **Concealed Duct Standard type**
(RAV-SM4BT-E, RAV-SM**1BT-4C)**

No.	Procedure
1	Using board installing spacer (A), install "1 : 1 Model" Connection Interface board to the position of electric parts box of the indoor unit. (See the figure below.)
2	Using terminal block fixing screws, install U3, U4 terminal block to the position of electric parts box of the indoor unit. (See the figure below.) <ul style="list-style-type: none"> • When tightening the screws, be sure not to damage wires. • Adhere the attached nameplate near the relay terminal block.
3	Connect the relay wire (A) from U3, U4 terminal block to CN40 (Blue) of "1 : 1 Model" Connection Interface board. Connect the relay wire (B) from CN50 (White) on the indoor P.C. board to CN51 (Red) on "1 : 1 Model" Connection Interface board.

Details

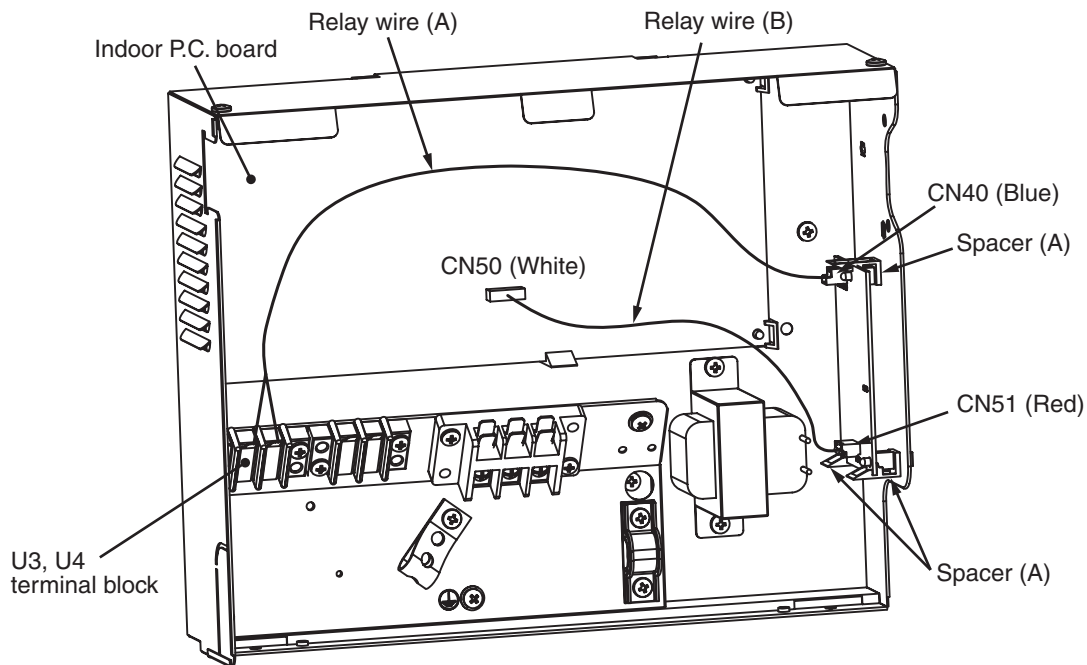

* Relay wire (A)

Connect U3, U4 terminal block with "1 : 1 Model" Connection Interface CN40 (Blue). There is no polarity for wire connection.

• Relay wire (B)

Connect CN50 (White) on indoor control P.C. board with CN51 (Red) on "1 : 1 Model" Connection Interface board.

- When installing "1 : 1 Model" Connection Interface board to electric parts box, insert three board installing spacers (A) into holes of P.C. board.

CAUTION

After connection of the relay wires (A) and (B), bind them with banding band so that wires are not caught in. In this time, be sure not to bind the relay wires (A) and (B) together with the power supply lines such as power cable, earth wire, etc.; otherwise a trouble may be caused.

■ Concealed Duct type (RAV-SM**6BT*)

No.	Procedure
1	Take off screws ① and ② and then remove the terminal block assembly while sliding
2	Using board installing spacer (A) 3 pcs install "1 : 1 Model" Connection Interface board to the position of electric parts box of the indoor unit. (See the figure below.)
3	Using terminal block fixing screws, install U3, U4 terminal block to the position of electric parts box of the indoor unit. (See the figure below.) <ul style="list-style-type: none"> • When tightening the screws, be sure not to damage wires. • Adhere the attached nameplate near the relay terminal block.
4	Connect the relay wire (A) from U3, U4 relay terminal block to CN40 (Blue) of "1 : 1 Model" Connection Interface board. Connect the relay wire (B) from CN050 (White) on the indoor P.C. board to CN51 (Red) on "1 : 1 Model" Connection Interface board.
5	Return terminal block assembly to the original position and then fix it with screws ① and ②.

Details

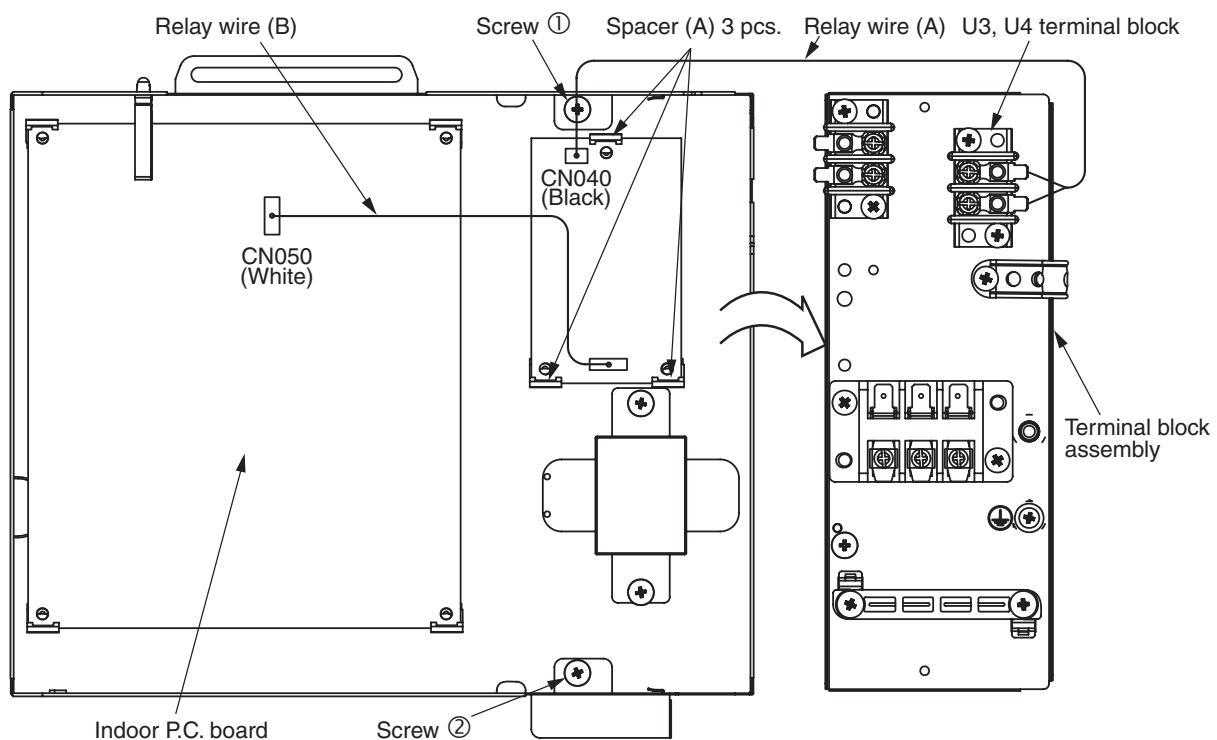

* Relay wire (A)

Connect U3, U4 terminal block with "1 : 1 Model" Connection Interface CN40 (Blue). There is no polarity for wire connection.

• Relay wire (B)

Connect CN050 (White) on indoor control P.C. board with CN51 (Red) on "1 : 1 Model" Connection Interface board.

* When installing "1 : 1 Model" Connection Interface board to electric parts box of Concealed type air conditioner, insert two board installing spacers (A) into holes of P.C. board (at upper side and lower right of P.C. board) and install one of them to the electric parts box (at lower left of P.C. board) using the board installing spacer (B) of a type which pinches the P.C. board.

⚠ CAUTION

After connection of the relay wires (A) and (B), bind them with banding band so that wires are not caught in. In this time, be sure not to bind the relay wires (A) and (B) together with the power supply lines such as power cable, earth wire, etc.; otherwise a trouble may be caused.

■ Slim Duct type (RAV-SM**4SDT*)

No.	Procedure
1	Using board installing spacer (A) 3 pcs install "1 : 1 Model" Connection Interface board to the position of electric parts box of the indoor unit. (See the figure below.)
2	Using terminal block fixing screws, install U3, U4 terminal block to the position of electric parts box of the indoor unit. (See the figure below.) <ul style="list-style-type: none"> • When tightening the screws, be sure not to damage wires. • Adhere the attached nameplate near the relay terminal block.
3	Connect the relay wire (A) from U3, U4 relay terminal block to CN40 (Blue) of "1 : 1 Model" Connection Interface board. Connect the relay wire (B) from CN050 (White) on the indoor P.C. board to CN51 (Red) on "1 : 1 Model" Connection Interface board.

Details

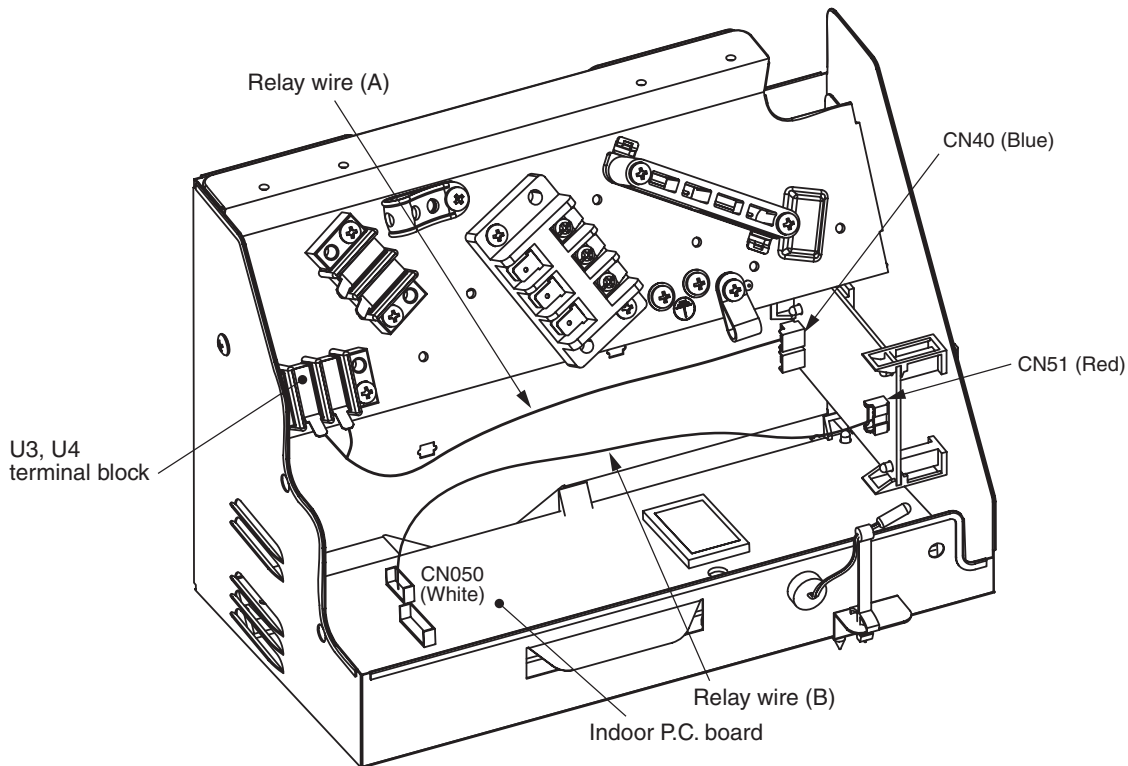

* Relay wire (A)

Connect U3, U4 terminal block with "1 : 1 Model" Connection Interface CN40 (Blue). There is no polarity for wire connection.

• Relay wire (B)

Connect CN050 (White) on indoor control P.C. board with CN51 (Red) on "1 : 1 Model" Connection Interface board.

* When installing "1 : 1 Model" Connection Interface board to electric parts box of Concealed type air conditioner, insert two board installing spacers (A) into holes of P.C. board (at upper side and lower right of P.C. board) and install one of them to the electric parts box (at lower left of P.C. board) using the board installing spacer (B) of a type which pinches the P.C. board.

CAUTION

After connection of the relay wires (A) and (B), bind them with banding band so that wires are not caught in. In this time, be sure not to bind the relay wires (A) and (B) together with the power supply lines such as power cable, earth wire, etc.; otherwise a trouble may be caused.

■ Ceiling type (RAV-SM**4CT*, RAV-SM**1CT-4C)

No.	Procedure
1	Using board installing spacer (A), install "1 : 1 Model" Connection Interface board to the position of electric parts box of the indoor unit. (See the figure below.)
2	Using terminal block fixing screws, install U3, U4 terminal block to the position of electric parts box of the indoor unit. (See the figure below.) <ul style="list-style-type: none"> • When tightening the screws, be sure not to damage wires. • Adhere the attached nameplate near the relay terminal block.
3	Connect the relay wire (A) from U3, U4 terminal block to CN40 (Blue) of "1 : 1 Model" Connection Interface board. Connect the relay wire (B) from CN50 (White) on the indoor P.C. board to CN51 (Red) on "1 : 1 Model" Connection Interface board.

Details

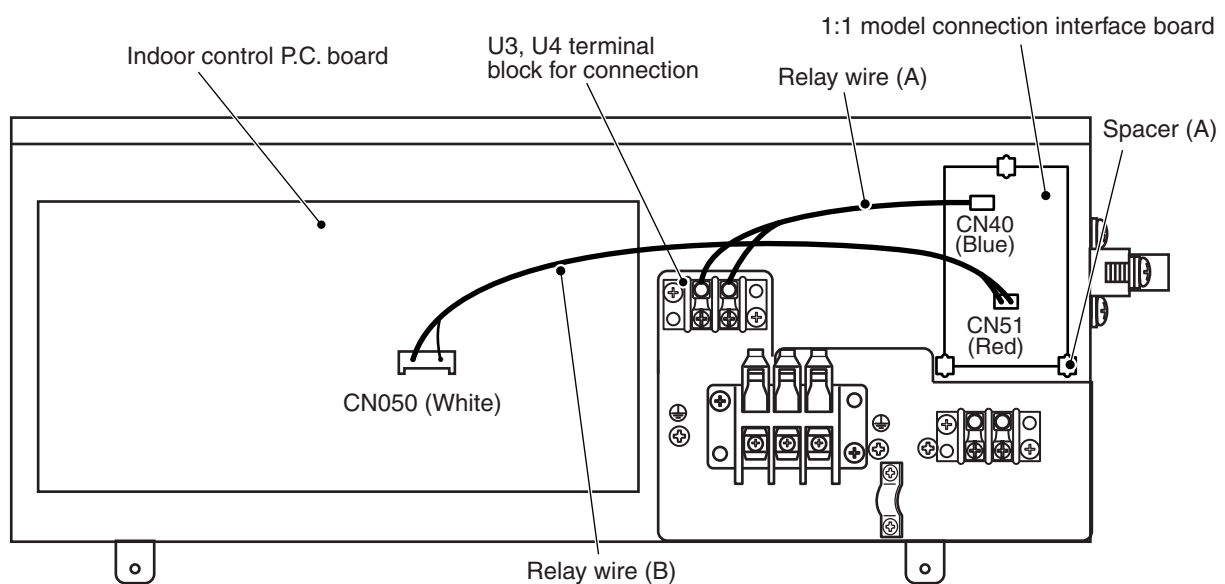

- Relay wire (A)
Connect U3, U4 terminal block with "1 : 1 Model" Connection Interface CN40 (Blue). There is no polarity for wire connection.
- Relay wire (B)
Connect CN50 (White) on indoor control P.C. board with CN51 (Red) on "1 : 1 Model" Connection Interface board.
- When installing "1 : 1 Model" Connection Interface board to electric parts box, insert three board installing spacers (A) into holes of P.C. board.

⚠ CAUTION

After connection of the relay wires (A) and (B), bind them with banding band so that wires are not caught in. In this time, be sure not to bind the relay wires (A) and (B) together with the power supply lines such as power cable, earth wire, etc.; otherwise a trouble may be caused.

■ Concealed Duct High Static Pressure Type (RAV-SM***4DTP*)

No.	Procedure
1	Take off the screws A and B then remove the terminal block assembly.
2	Using board installing spacer (A), install "1 : 1 Model" Connection Interface board to the position of electric parts box of the indoor unit. (See the figure below.)
3	Using terminal block fixing screws, install U3, U4 terminal block to the position of electric parts box of the indoor unit. (See the figure below.) <ul style="list-style-type: none"> • When tightening the screws, be sure not to damage wires. • Adhere the attached nameplate near the U3, U4 terminal block.
4	Connect the relay wire (A) from U3, U4 terminal block to CN40 (Blue) of "1 : 1 Model" Connection Interface board. There is no polarity for wire connection. Connect the relay wire (B) from CN50 (White) on the indoor P.C. board to CN51 (Red) on "1 : 1 Model" Connection Interface board. (See the figure below.)
5	Return terminal block assembly to the original position without pinching wires. Confirm to hook the claw of terminal block assembly on the right side. Then screw A and B.

Details

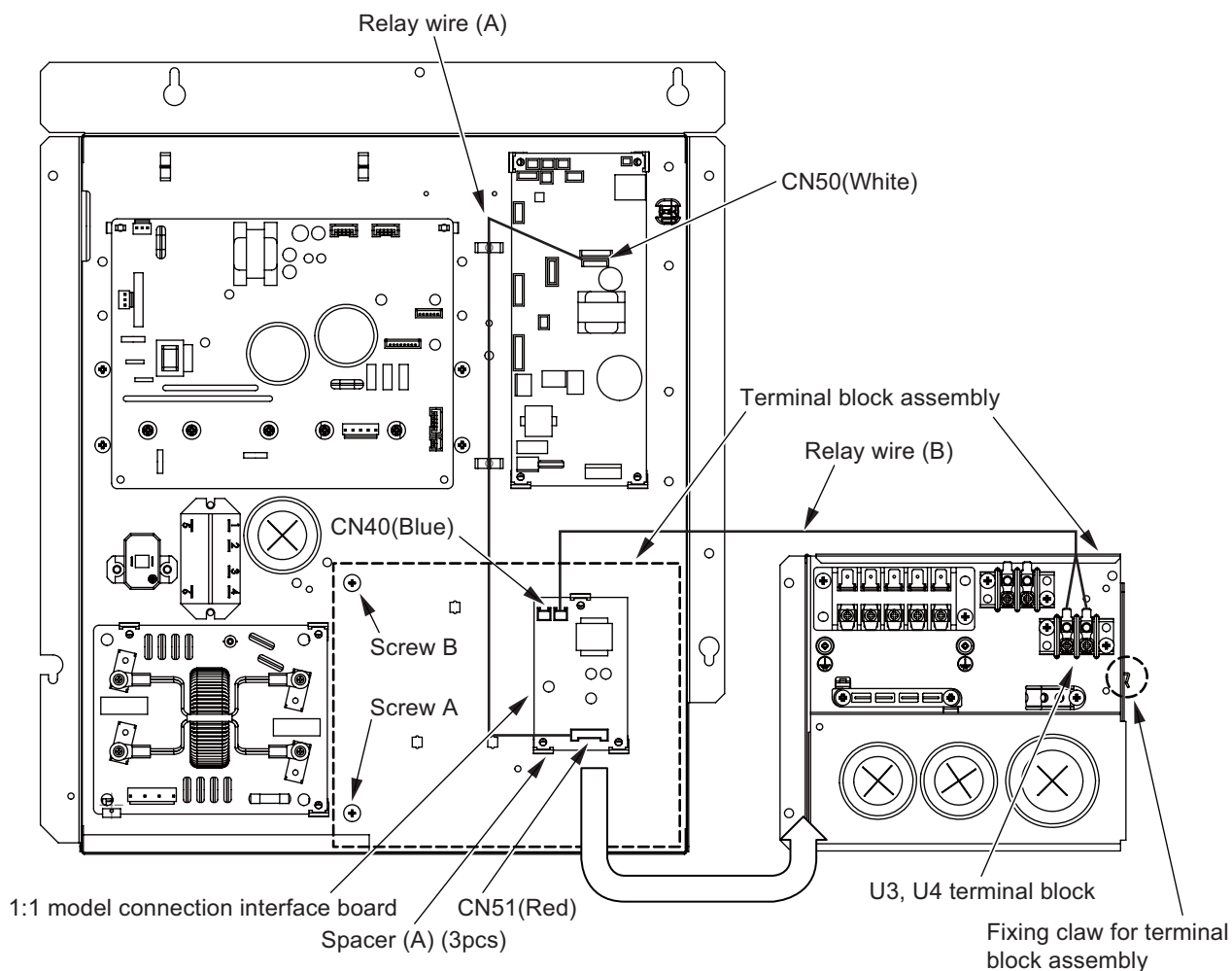

⚠ CAUTION

After connection of the relay wires (A) and (B), bind them with banding band so that wires are not caught in. In this time, be sure not to bind the relay wires (A) and (B) together with the power supply lines such as power cable, earth wire, etc.; otherwise a trouble may be caused.

■ Ceiling type (RAV-SM**7CT*)

No.	Procedure
1	Using board installing spacer (A), install "1 : 1 Model" Connection Interface board to the position of electric parts box of the indoor unit. (See the figure below.)
2	Using terminal block fixing screws, install U3, U4 terminal block to the position of electric parts box of the indoor unit. (See the figure below.) <ul style="list-style-type: none"> • When tightening the screws, be sure not to damage wires. • Adhere the attached nameplate near the relay terminal block.
3	Connect the relay wire (A) from U3, U4 terminal block to CN40 (Blue) of "1 : 1 Model" Connection Interface board. Connect the relay wire (B) from CN50 (White) on the indoor P.C. board to CN51 (Red) on "1 : 1 Model" Connection Interface board.

Details



CAUTION

After connection of the relay wires (A) and (B), bind them with banding band so that wires are not caught in.

Usage

- Refer to Owner's Manual for the central control devices (TCB-SC642TLE2, TCB-CC163TLE2 etc.)

Other Cautions

- In a group operation, be sure to turn on power supplies of all the indoor units in group control. (Within 3 minutes)

When power supply of the Header unit is not turned on, there is a possibility that the Header unit exchanges with Follower unit. (If Header unit is exchanged, the central control is unavailable.)

Address No. Setup

■ Outline

To connect the digital inverter air conditioner to TCC-LINK central control system using this interface, it is required to set up address of each connected indoor unit for central control in the following procedure.

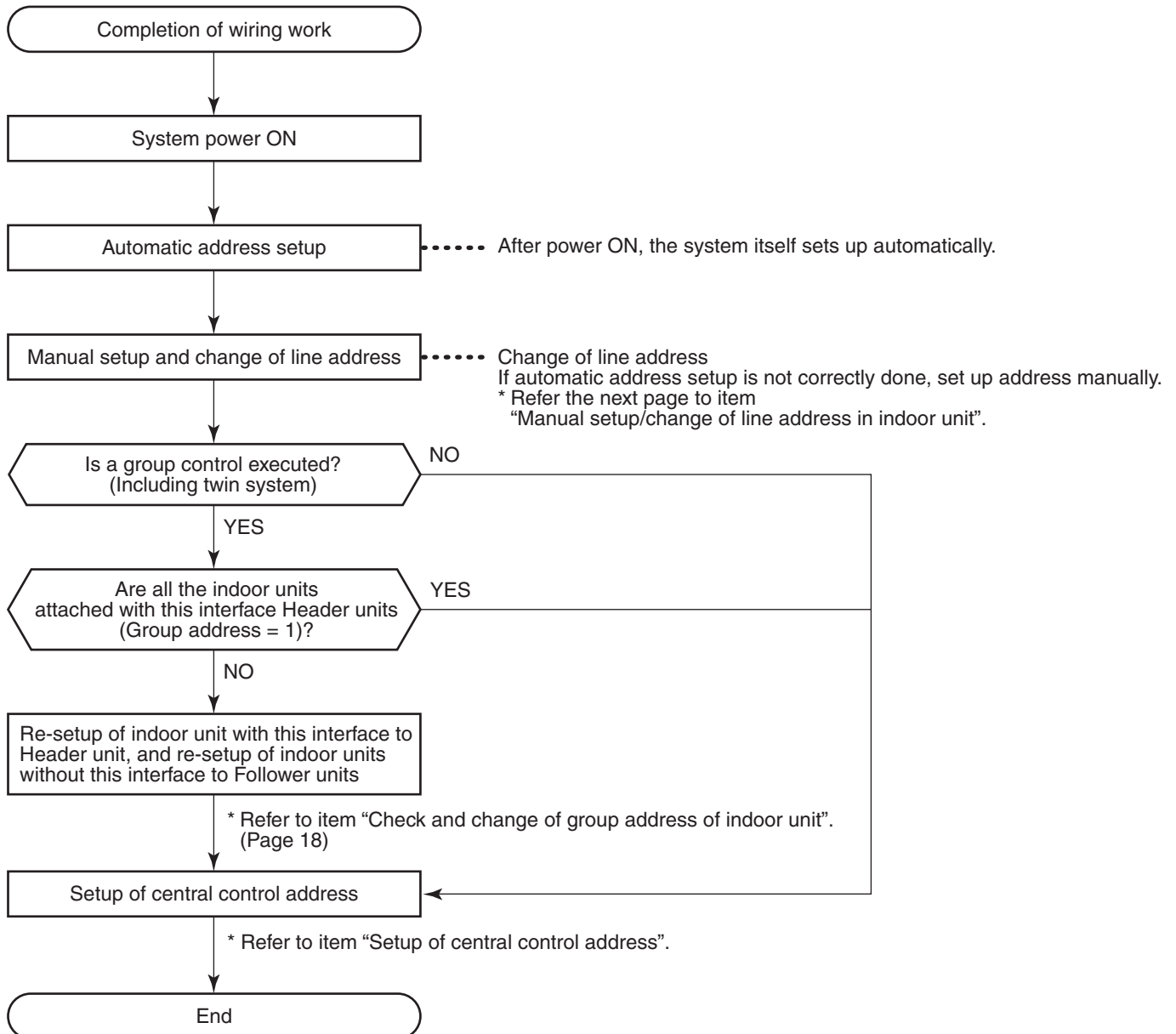

Manual Setup/Change of Line Address in Indoor Unit

[In case of 29 refrigerant lines or less (Includes No. of refrigerant lines at Multi side if mixed)]

After the system power supply has been turned on, all the line addresses are allocated to “1” by automatic address setup except group control. Therefore change setup of the line address using the wired remote controller for each refrigerant line.

Change line address for each refrigerant line.

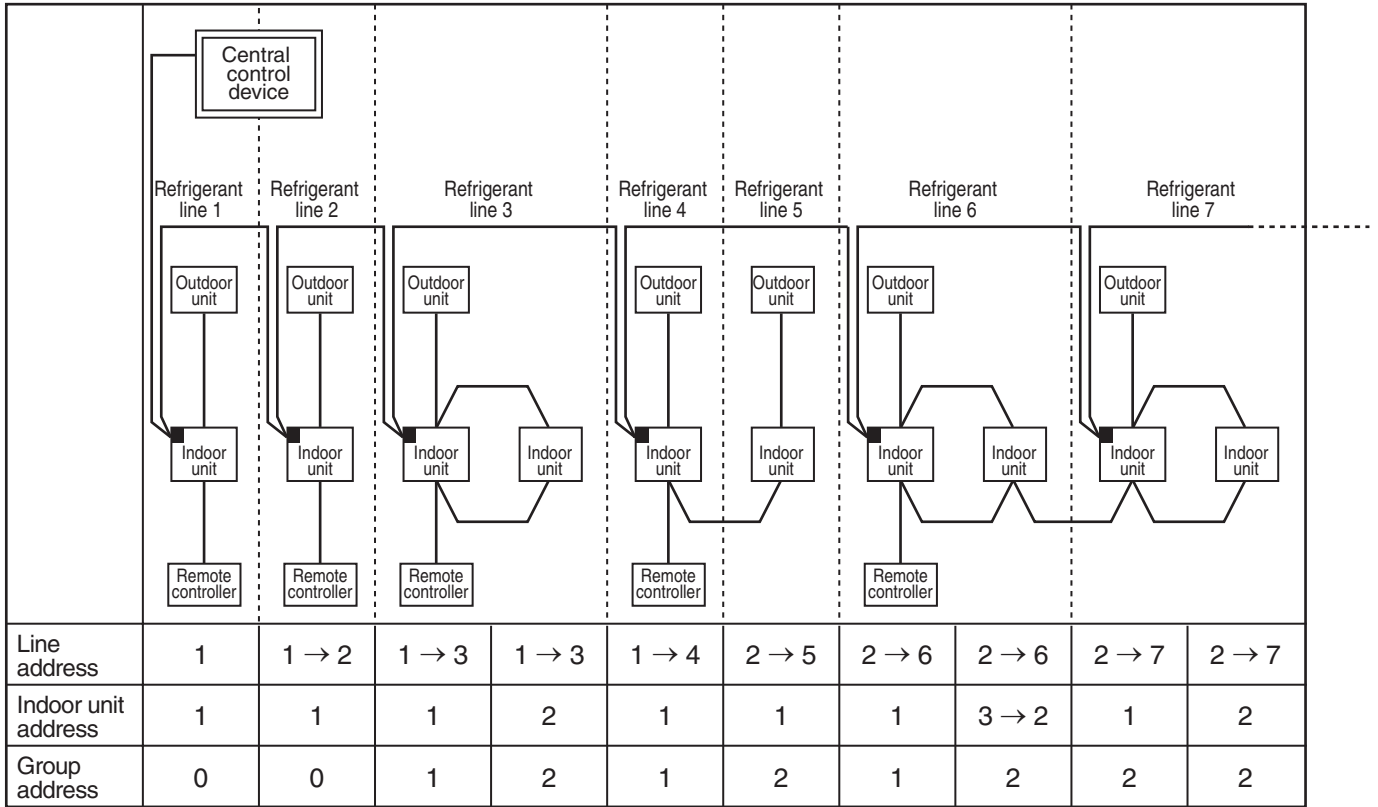

In case of group control including twin, triple, double twin system, the automatic address does not normally work. Set the automatic address again from the wireless remote controller manually.

Line address (1)	1	2	3	3	4	5	6	6	7	7
Indoor unit address	1	1	1	2	1	1	1	2	1	2
Group address	0	0	1	2	1	2	1	2	2	2

[■ → “1 : 1 Model” connection interface]

- * For change/setup method by wired remote controller, refer to “Address Setup/Change Method”. (Page 21)
- * Allocating different numeral value for each refrigerant line, set up the line address so that it does not overlap with other address No. (When controlling collectively VRF type units mixed with digital inverter air conditioner unit, set up numeral value which also differs from line address at VRF type air conditioner side.)

Manual Setup/Change of Line Address in Indoor Unit

[In case of 30 refrigerant lines or more (Includes No. of refrigerant lines at Multi side if mixed)]

After the system power supply has been turned on, all the line addresses are allocated to “1” by automatic address setup except group control. Therefore change setup of the line address using the wired remote controller for each refrigerant line.

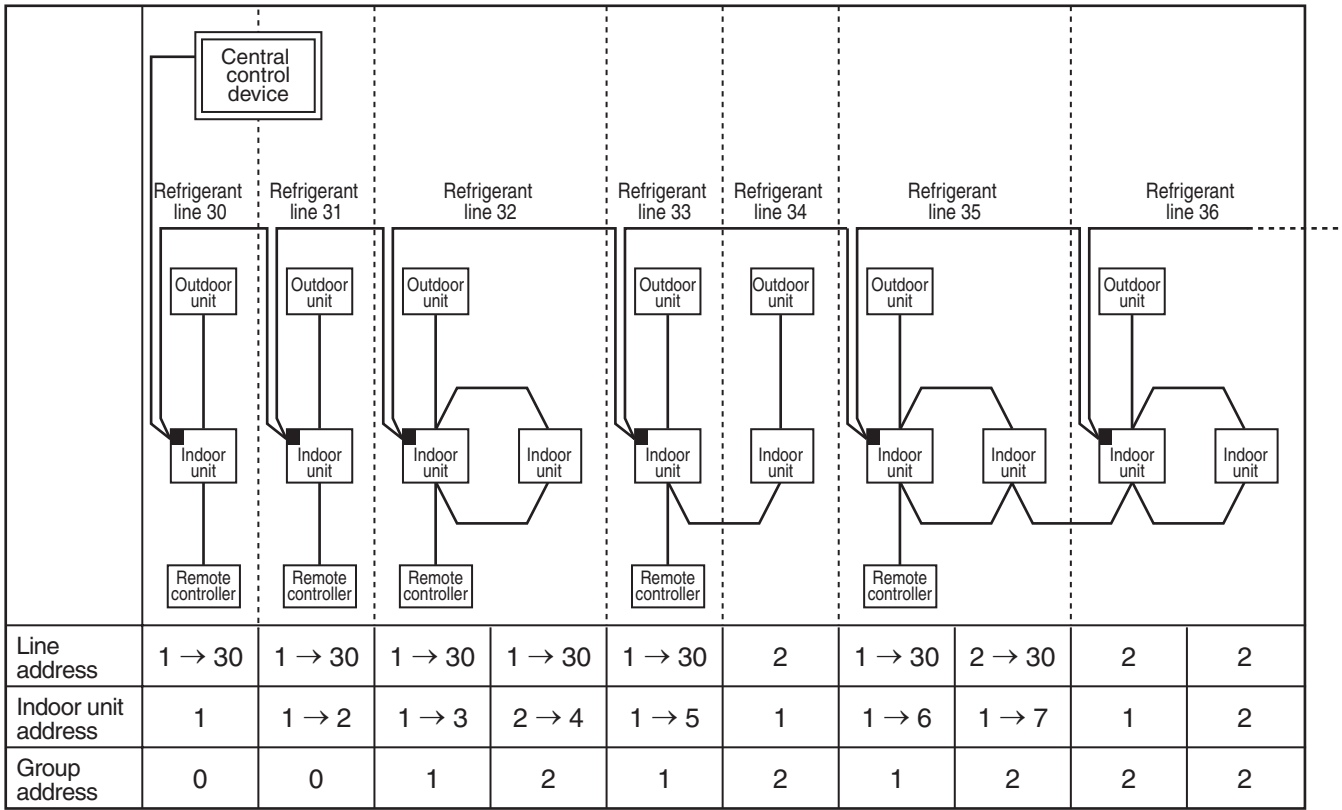

Point (1) Set “30” to all the line addresses of indoor units attached with these interface

Point (2) Change the indoor address so that the indoor unit numbers do not overlap.

Point (3) When the indoor unit attached with this interface is controlled with twin or system, change also line address of the follower unit to “30”.

In case of group control including twin, triple, double twin system, the automatic address does not normally work. Set the automatic address again from the wireless remote controller manually.

Line address (1)	30	30	30	30	30	2	30	30	2	2
Indoor unit address	1	2	3	4	5	1	6	7	1	2
Group address	0	0	1	2	1	2	1	2	2	2

[■ → “1 : 1 Model” connection interface]

- * For change/setup method by wired remote controller, refer to “Address Setup/Change Method”. (Page 21)
- * Allocating different numeral value for each refrigerant line, set up the line address so that it does not overlap with other address No. (When controlling collectively VRF type units mixed with digital inverter air conditioner unit, set up numeral value which also differs from line address at VRF type air conditioner side.)

■ Check and Change of Group Address of Indoor Unit

In group control or twin, triple, double twin operation, the group address is allocated to indoor unit by automatic address setup after the system power supply has been turned on. From these addresses, "Header unit": "1" and "Follower unit": "2" can be recognized. As the central control device (remote controller) communicates with "Header unit" only, set up the group address from wired remote controller so that the indoor unit attached with the interface becomes "Header unit".

• Check method for Header unit

Beforehand check the indoor unit attached with this interface.

During stop of the Set.

<Procedure>

- 1 Push **SET**, **CL** and **TEST** buttons simultaneously for 4 seconds or more.

(The firstly displayed unit No. is the header indoor unit No. in the group control.)

- 2 The indoor unit of which fan was turned on is the header indoor unit.

If the header unit is not one with this interface, change it according to "How to set up Header unit".

- 3 Pushing **TEST** button returns the mode to normal mode.

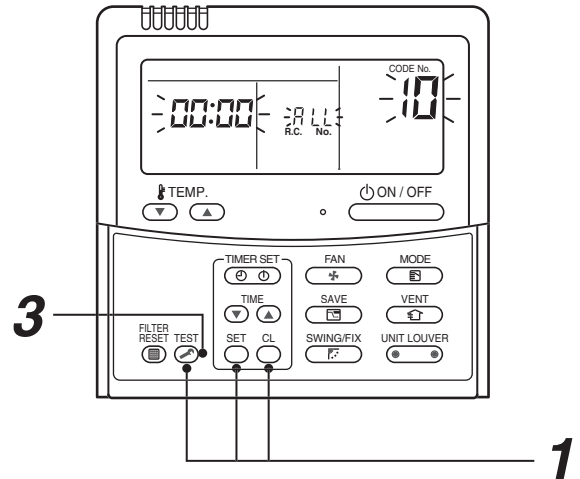

• How to set up Header unit

(In case when the indoor unit of which fan was turned on is not one attached with interface)

Change address in the following procedure.

<Procedure>

- 1 Push **SET**, **CL** and **TEST** buttons simultaneously for 4 seconds or more.

(The firstly displayed unit No. is the header indoor unit No. in the group control.)

- 2 The indoor unit of which fan was turned on is the header indoor unit.

- 3 Using the setup temperature **▼** and **▲** buttons, select CODE No. "14".

- 4 Check that the setup data is 0001, and then change the setup data to 0002 using the timer time **▼** and **▲** buttons.

- 5 Push **SET** button. In this time, the setup ends if display changes from flashing to lighting.



(To be continued)

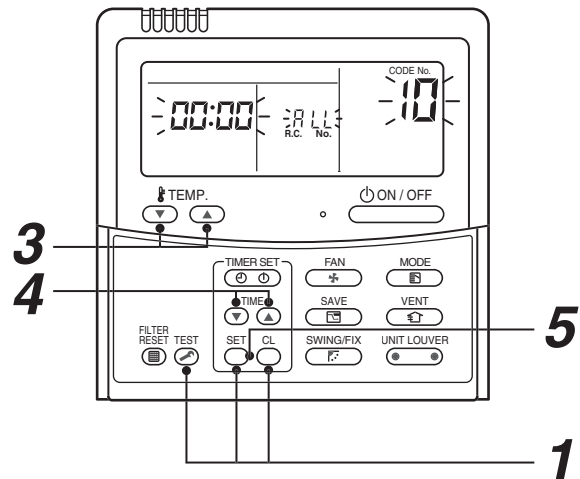



- 6** Push button (left side of the button), and then turn on fan of the indoor unit which is attached with interface.
- 7** Leave the CODE No. as it is. (Select CODE No. 14.)
- 8** Check that the setup data is 0002, and then change the setup data to 0001 using the timer time and buttons.
- 9** Push button. In this time, the setup ends if display changes from flashing to lighting.
- 10** When the above setup completed, push button (left side of the button) to select indoor unit of which setup was changed and then check the changed contents. (CODE No. 14 as it is)
* When pushing button, the setup contents can be cleared.
(In this case, repeat procedure from **1** .)

Note) Cancellation is unavailable if the CODE No. is changed.

11 Push button. (Setup is determined.)

When pushing button, the display disappears and the status becomes the normal stop status.
(The remote controller operation is not accepted for approx. 1 minute after pushing button.)

* If the remote controller operation is not accepted for 1 minute or more after pushing button, it is considered that the address setup is incorrect and the automatic address setup is being performed again. Change setup again after approx. 5 minutes.

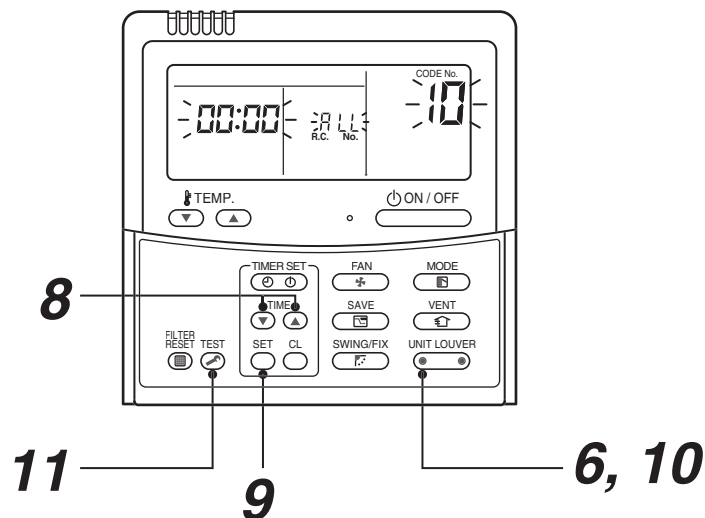

■ Setup of Central Control Address

* For details, refer to Installation Manual for central remote controller.

1. Address setup method is classified into the following three methods.
 - 1) Manual setup from wired remote controller
 - 2) Manual setup from central remote controller
 - 3) Automatic setup from central remote controller
2. In group control, set up the central control address to the Header unit of the group.

Determination of indoor address

Is automatic address set up?

Automatic setup

Manual setup

Setup from wired remote controller

Setup from central remote controller

Manual address setup from wired remote controller

- 1 Push **TEST** and **VENT** buttons simultaneously for 4 seconds or more. Do not push **UNIT** button.
- 2 Set "03" to CODE No. with temperature setup **▼** and **▲** buttons.
- 3 Using timer setup/time **▼** and **▲** buttons, set up the central control address.
- 4 Registration completes with **SET** button. (**SETTING** changes from flashing to lighting.)
- 5 Push **TEST** button.
- 6 Initial setup starts. (For approx. 1 minute)
- 7 End

Manual address setup with CODE No. "C1" of central remote controller

- 1 Push **TEST** and **ZONE** buttons simultaneously for 4 seconds or more.
- 2 Set "C1" to CODE No. with temperature setup **▲** and **▼** buttons.
- 3 Push **SET** button.
- 4 Select **ZONE** or **◀ ▶** buttons to select zone and group to be registered.
- 5 Using **TEST** and **SET**, perform registration. (Select the indoor unit.)
- 6 Registration completes with **SET** button.
- 7 Repeat procedure 4 to 6.
- 8 Push **TEST** button.
- 9 **SETTING** flashes and the initial setup starts.
- 10 End

Automatic address setup with CODE No. "C2" of central remote controller

- 1 Push **TEST** and **ZONE** buttons simultaneously for 4 seconds or more.
- 2 Set "C2" to CODE No. with temperature setup **▲** and **▼** buttons.
- 3 Push **SET** button and the address setup starts. "C2" goes on and **SETTING** flashes.
- 4 When **SETTING** goes off and "C2" flashes, setup ends.
- 5 Push **TEST** button.
- 6 **SETTING** flashes and the initial setup starts. (For approx. 1 minute)
- 7 End

Check method

Check overlap of central control addresses
 Make operation status by pushing **TEST** buttons of central remote controller three times each.
 When there is overlapped units
 An alarm code "L20" is displayed on the remote controller and alarm code "L20" or "P30" on central remote controller, respectively.

Wired remote controller:
 Displayed immediately
 central remote controller:
 After 4 minutes at maximum

Overlapped YES

Overlapped?

No overlap

End

(Example)

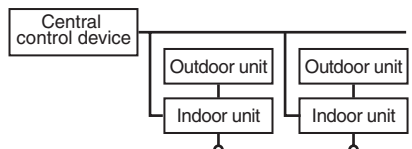

(Line - Indoor - Group)

*1 In case of digital inverter air conditioner, if the same line address is set up to the multiple indoor units which are controlled collectively, the central control address setup is impossible by this method.

<Central control address/zone/group correspondence table>

Central control Address	Zone	Group	Central control Address	Zone	Group	Central control Address	Zone	Group	Central control Address	Zone	Group
1	1	1	17	2	1	33	3	1	49	4	1
2	1	2	18	2	2	34	3	2	50	4	2
3	1	3	19	2	3	35	3	3	51	4	3
4	1	4	20	2	4	36	3	4	52	4	4
5	1	5	21	2	5	37	3	5	53	4	5
6	1	6	22	2	6	38	3	6	54	4	6
7	1	7	23	2	7	39	3	7	55	4	7
8	1	8	24	2	8	40	3	8	56	4	8
9	1	9	25	2	9	41	3	9	57	4	9
10	1	10	26	2	10	42	3	10	58	4	10
11	1	11	27	2	11	43	3	11	59	4	11
12	1	12	28	2	12	44	3	12	60	4	12
13	1	13	29	2	13	45	3	13	61	4	13
14	1	14	30	2	14	46	3	14	62	4	14
15	1	15	31	2	15	47	3	15	63	4	15
16	1	16	32	2	16	48	3	16	64	4	16
									99	Not set up	

■ Address Setup/Change Method

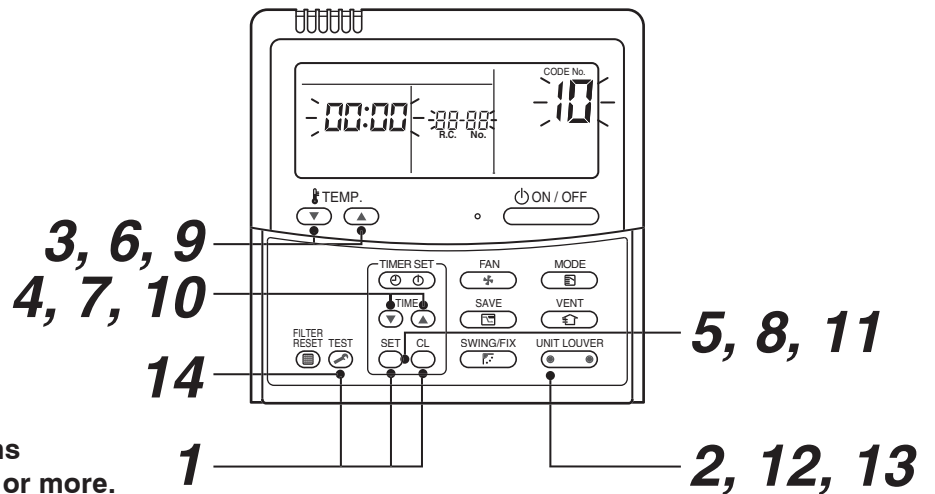

<Procedure>

- 1** Push **SET**, **CL** and **TEST** buttons simultaneously for 4 seconds or more.

LCD changes to flashing.

(The firstly displayed unit No. is the header indoor unit No. in the group control.)

- 2** In group control, use **UNIT LOUVER** button (left side of the button) for change. Select the indoor unit No. (The fan of the selected indoor unit is turned on.)

<Line address>

- 3** Using the setup temperature **▼** and **▲** buttons, select CODE No. "12".
- 4** Using timer time **▼** and **▲** buttons, set up the line address.
- 5** Push **SET** button. (OK when display goes on.)

<Indoor unit address>

- 6** Using the setup temperature **▼** and **▲** buttons, select CODE No. "13".
- 7** Using timer time **▼** and **▲** buttons, set up the indoor unit address.
- 8** Push **SET** button. (OK when display goes on.)

<Group address>

- 9** Using the setup temperature **▼** and **▲** buttons, select CODE No. "14".
- 10** Using timer time **▼** and **▲** buttons, set up Individual = 0000, Header unit = 0001, and Follower unit = 0002.
- 11** Push **SET** button. (OK when display goes on.)
- 12** Using **UNIT LOUVER** button (left side of the button), select an indoor unit No. to be changed at the next time. Repeat procedure from **3** to **12** and change setup so that addresses are not overlapped.
- 13** After the above change, push **UNIT LOUVER** button (left side of the button) to check the changed contents.
- 14** If all is right, push **TEST** button. Setup ends.

<Wiring example of 2 lines>

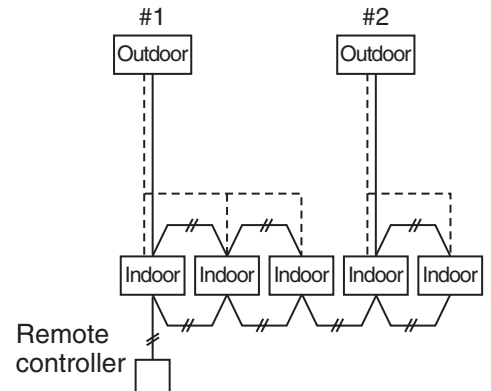

Line address	→ 1	1	1	2	2
Indoor unit address	→ 1	2	3	1	2
Group address	→ 1	2	2	2	2
		Header unit		Follower unit	

Group address

Individual : 0000
 Header unit : 0001
 Follower unit : 0002 } In case of group control

Alarm code when addresses are overlapped

	Procedure	Alarm code
Case 1	<p>When line addresses are overlapped</p>	<p>Wired remote controller side Line 1: E08 Line 2: E08</p> <p>Central remote controller side E08 to Line 1 or Line 2</p>
Case 2	<p>When line addresses are overlapped (Both Line 1 and 2 operate)</p>	<p>Wired remote controller side Line 1: L20 Line 2: L20</p> <p>Central remote controller side L20 to Line 1 or Line 2</p>
Case 3	<p>When only one-side Line 2 operates from remote controller, and overlap of the central control address is detected in Case 2</p> <ul style="list-style-type: none"> • Line 1: During stop • Line 2: Under operation (Overlap of central control address is detected.) <div style="border: 1px solid black; padding: 5px; margin-top: 10px; width: fit-content;"> <p>Line 1: Alarm code is output even if it stops. Line 2: Alarm code is not output to the central side. (Alarm is displayed on the wired remote controller.)</p> </div>	<p>Wired remote controller side Line 1: No alarm Line 2: L20</p> <p>Central remote controller side Line 1: No alarm Line 2: L20</p> <p style="text-align: center;">or</p> <div style="border: 1px solid black; padding: 5px; margin-top: 5px; width: fit-content;"> <p>Line 1: P30 Line 2: No alarm</p> </div>

TOSHIBA CARRIER CORPORATION

336 TADEHARA, FUJI-SH, SHIZUOKA-KEN 416-8521 JAPAN