

Air conditioner

Installation manual

AC***MN4PKH

- Thank you for purchasing this Samsung air conditioner.
- Before operating this unit, please read this manual carefully and retain it for future reference.

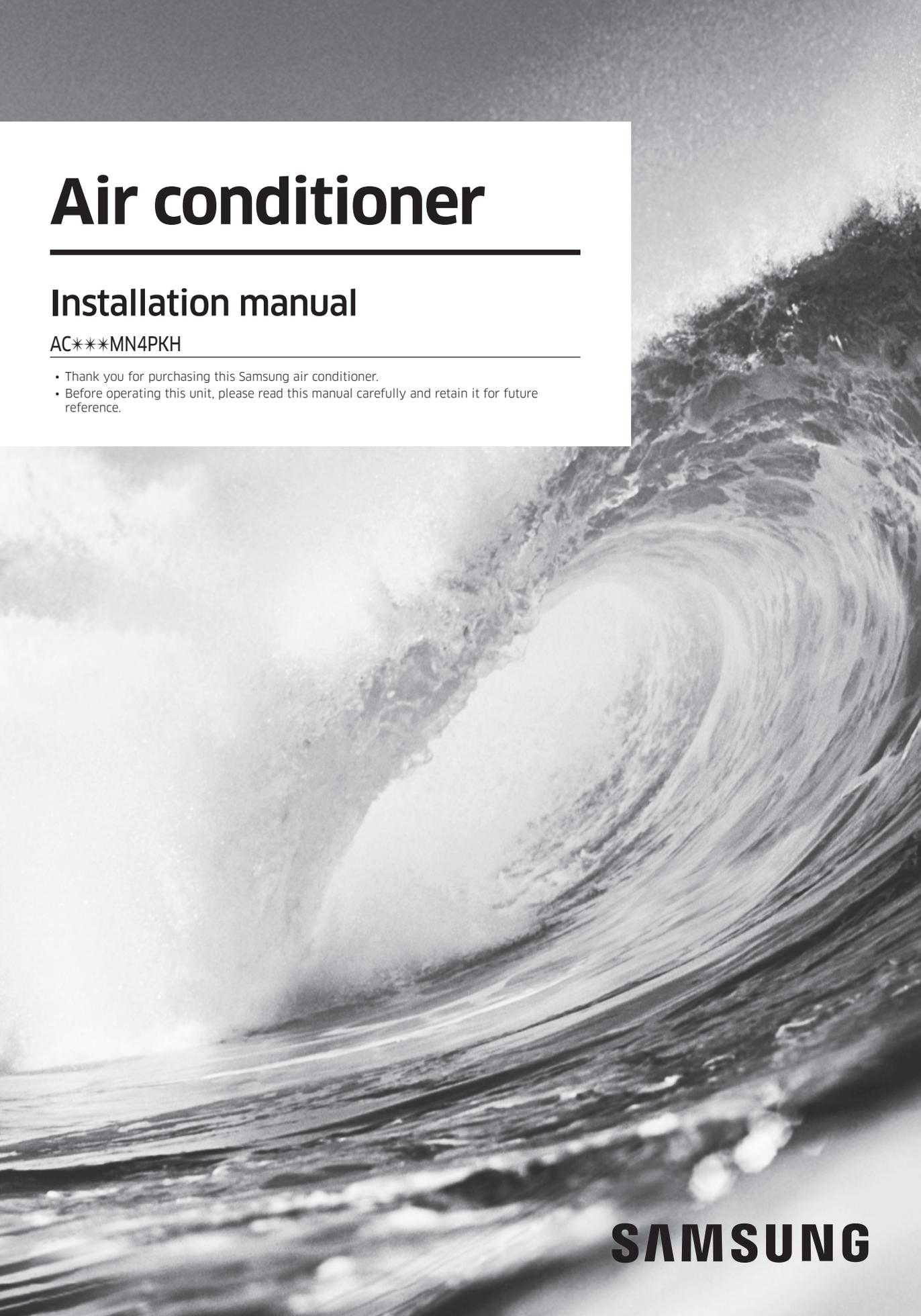

SAMSUNG

Contents

Safety Information **3**

Installation Procedure **5**

- Step 1 Checking and preparing accessories
- Step 2 Choosing the installation location
- Step 3 Optional: Insulating the body of the indoor unit
- Step 4 Installing the indoor unit
- Step 5 Purging inert gas from the indoor unit
- Step 6 Cutting and flaring the pipes
- Step 7 Connecting the assembly pipes to the refrigerant pipes
- Step 8 Performing the gas leak test
- Step 9 Insulating the refrigerant pipes
- Step 10 Installing the drain hose and drain pipe
- Step 11 Performing the drainage test
- Step 12 Connecting the power and communication cables
- Step 13 Optional: Extending the power cable
- Step 14 Setting the indoor unit addresses and the installation options
- Optional: For the installation of the circular panel
- Optional: Installing DPM (Digital Packaged Multi)

Appendix **35**

Troubleshooting

Safety Information

WARNING

- Hazards or unsafe practices that may result in severe personal injury or death.

CAUTION

- Hazards or unsafe practices that may result in minor personal injury or property damage.
- Carefully follow the precautions listed below because they are essential to guarantee the safety of the equipment.

WARNING

- Always disconnect the air conditioner from the power supply before servicing it or accessing its internal components.
- Verify that installation and testing operations are performed by qualified personnel.
- Verify that the air conditioner is not installed in an easily accessible area.

General information

WARNING

- Carefully read the content of this manual before installing the air conditioner and store the manual in a safe place in order to be able to use it as reference after installation.
- For maximum safety, installers should always carefully read the following warnings.
- Store the operation and installation manual in a safe location and remember to hand it over to the new owner if the air conditioner is sold or transferred.
- This manual explains how to install an indoor unit with a split system with two SAMSUNG units. The use of other types of units with different control systems may damage the units and invalidate the warranty. The manufacturer shall not be responsible for damages arising from the use of non compliant units.
- The manufacturer shall not be responsible for damage originating from unauthorized changes or the improper connection of electric and requirements set forth in the "Operating limits" table, included in the manual, shall immediately invalidate the warranty.
- The air conditioner should be used only for the applications for which it has been designed: the indoor unit is not suitable to be installed in areas used for laundry.

- Do not use the units if damaged. If problems occur, switch the unit off and disconnect it from the power supply.
- In order to prevent electric shocks, fires or injuries, always stop the unit, disable the protection switch and contact SAMSUNG's technical support if the unit produces smoke, if the power cable is hot or damaged or if the unit is very noisy.
- Always remember to inspect the unit, electric connections, refrigerant tubes and protections regularly. These operations should be performed by qualified personnel only.
- The unit contains moving parts, which should always be kept out of the reach of children.
- Do not attempt to repair, move, alter or reinstall the unit. If performed by unauthorized personnel, these operations may cause electric shocks or fires.
- Do not place containers with liquids or other objects on the unit.
- All the materials used for the manufacture and packaging of the air conditioner are recyclable.
- The packing material and exhaust batteries of the remote controller(optional) must be disposed of in accordance with current laws.
- The air conditioner contains a refrigerant that has to be disposed of as special waste. At the end of its life cycle, the air conditioner must be disposed of in authorised centres or returned to the retailer so that it can be disposed of correctly and safely.

Installing the unit

WARNING

IMPORTANT: When installing the unit, always remember to connect first the refrigerant tubes, then the electrical lines.

- Always disassemble the electric lines before the refrigerant tubes.
- Upon receipt, inspect the product to verify that it has not been damaged during transport. If the product appears damaged, DO NOT INSTALL it and immediately report the damage to the carrier or retailer (if the installer or the authorized technician has collected the material from the retailer.)
- After completing the installation, always carry out a functional test and provide the instructions on how to operate the air conditioner to the user.

Safety Information

- Do not use the air conditioner in environments with hazardous substances or close to equipment that release free flames to avoid the occurrence of fires, explosions or injuries.
- Our units should be installed in compliance with the spaces shown in the installation manual, to ensure accessibility from both sides and allow repairs or maintenance operations to be carried out. The unit's components should be accessible and easy to disassemble without endangering people and objects. For this reason, when provisions of the installation manual are not complied with, the cost required to access and repair the units (in SAFETY CONDITIONS, as set out in prevailing regulations) with harnesses, ladders, scaffolding or any other elevation system will NOT be considered part of the warranty and will be charged to the end customer.
- Be sure not to perform power cable modification, extension wiring, and multiple wire connection.
 - It may cause electric shock or fire due to poor connection, poor insulation, or current limit override.
 - When extension wiring is required due to power line damage, refer to "Step 13 Optional: Extending the power cable" in the installation manual.

CAUTION

Make sure that you earth the cables.

- Do not connect the earth wire to the gas pipe, water pipe, lighting rod or telephone wire. If earthing is not complete, electric shock or fire may occur.

Install the circuit breaker.

- If the circuit breaker is not installed, electric shock or fire may occur.

Make sure that the condensed water dripping from the drain hose runs out properly and safely.

Install the power cable and communication cable of the indoor and outdoor unit at least 1m away from the electric appliance.

Install the indoor unit away from lighting apparatus using the ballast.

- If you use the wireless remote control, reception error may occur due to the ballast of the lighting apparatus.

Do not install the air conditioner in following places.

- Place where there is mineral oil or arsenic acid. Resin parts flame and the accessories may drop or water may leak. The capacity of the heat exchanger may reduce or the air conditioner may be out of order.
- The place where corrosive gas such as sulphuric acid gas generates from the vent pipe or air outlet.
- The copper pipe or connection pipe may corrode and refrigerant may leak.
- The place where there is a machine that generates electromagnetic waves. The air conditioner may not operate normally due to control system.
- The place where there is a danger of existing combustible gas, carbon fibre or flammable dust.
- The place where thinner or gasoline is handled. Gas may leak and it may cause fire.

Power supply line, fuse or circuit breaker

WARNING

- Always make sure that the power supply is compliant with current safety standards. Always install the air conditioner in compliance with current local safety standards.
- Always verify that a suitable grounding connection is available.
- Verify that the voltage and frequency of the power supply comply with the specifications and that the installed power is sufficient to ensure the operation of any other domestic appliance connected to the same electric lines.
- Always verify that the cut-off and protection switches are suitably dimensioned.
- Verify that the air conditioner is connected to the power supply in accordance with the instructions provided in the wiring diagram included in the manual.
- Always verify that electric connections (cable entry, section of leads, protections...) are compliant with the electric specifications and with the instructions provided in the wiring scheme. Always verify that all connections comply with the standards applicable to the installation of air conditioners.
- Devices disconnected from the power supply should be completely disconnected in the condition of overvoltage category.

Installation Procedure

Step 1 Checking and preparing accessories

The following accessories are supplied with the indoor unit. The type and quantity may differ, depending on the specifications.

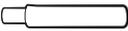
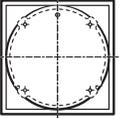
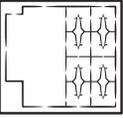
Insulation pipe	Cable-tie
	
Drain hose	Installation manual
	
Clamp	User manual
	
Installation template	Dimension gauge
	

Step 2 Choosing the installation location

Installation location requirements

- There must be no obstacles near the air inlet and outlet.
- Install the indoor unit on a ceiling that can support its weight.
- Maintain sufficient clearance around the indoor unit.
- Before installing the indoor unit, be sure to check whether the chosen location is well-drained.
- The indoor unit must be installed such that it is beyond public access and is not touchable by users.

Installation Procedure

Indoor unit dimensions

(Unit: mm)

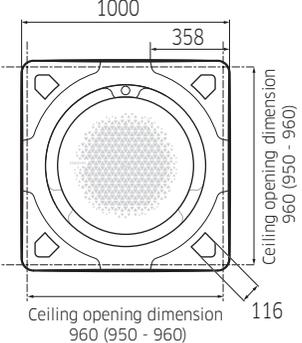
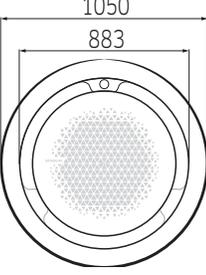
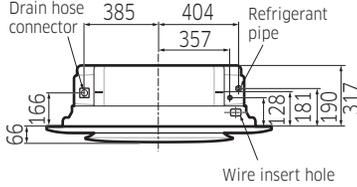
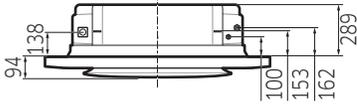
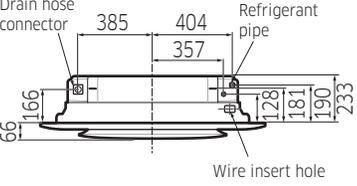
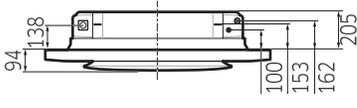
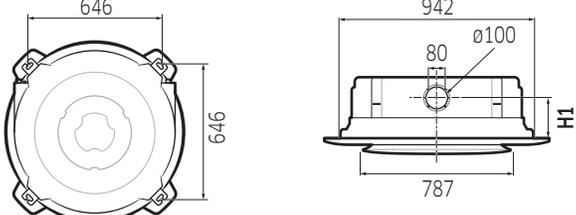
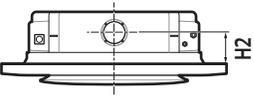
Category	Square panel	Circular panel
Front	 <p>1000 358 Ceiling opening dimension 960 (950 - 960) 116 Ceiling opening dimension 960 (950 - 960)</p>	 <p>1050 883</p>
Large+, Large	 <p>Drain hose connector 385 404 Refrigerant pipe 357 166 66 128 181 190 317 Wire insert hole</p>	 <p>94 138 100 153 162 289</p>
Small	 <p>Drain hose connector 385 404 Refrigerant pipe 357 166 66 128 181 190 233 Wire insert hole</p>	 <p>94 138 100 153 162 205</p>
Common	 <p>646 646 942 80 $\phi 100$ 787 H1</p> <p>Square panel</p>	 <p>H2</p> <p>Circular panel</p>

H1 → Large+, Large: 180, Small: 150
H2 → Large+, Large: 152, Small: 122

Installation Procedure

Model		AC071MN4PKH	AC090MN4PKH	AC100MN4PKH	AC120MN4PKH	AC140MN4PKH
Chassis		Small	Large			Large+
Net dimension (W × D × H)	mm	947 X 947 X 281	947 X 947 X 365	947 X 947 X 365	947 X 947 X 365	947 X 947 X 365
Net weight	kg	20.2	23.5	23.5	23.5	25.5
Liquid pipe connection		6.35	9.52	9.52	9.52	9.52
Gas pipe connection		15.88	15.88	15.88	15.88	15.88
Drain hose connection	mm	Outer diameter: Ø32, Inner diameter: Ø26.5				

- The circular panel is by default available in exposed installation.
- Make inspection holes on the ceiling for easier installation and maintenance, as shown in the following table. (The size of an inspection hole must be at least 450 mm x 450 mm.)
- A suspended ceiling structure can substitute for the inspection holes.

- For the recessed installation of the circular panel

Category	Inspection hole		
	Recessed installation		Exposed installation
	Integrated	suspended	
Square panel	1 ea	-	
Circular panel	2 ea		

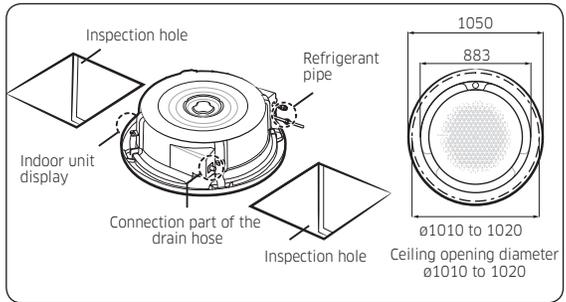

NOTE

The clearance between the panel and the inspection hole is 15 to 20 mm on a side.

Spacing requirements

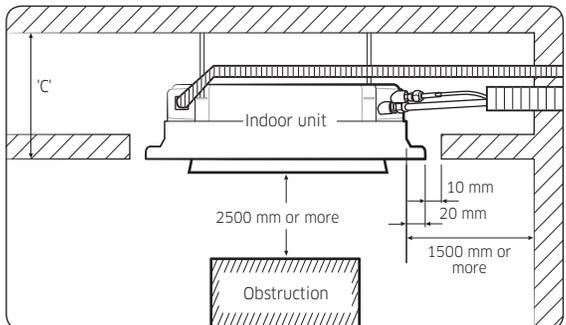
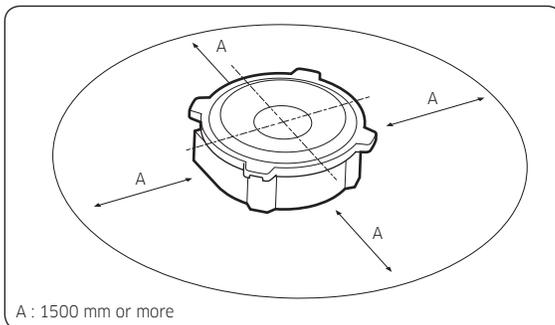

(Unit: mm)

Model	AC071MN4PKH	AC090MN4PKH	AC100MN4PKH	AC120MN4PKH	AC140MN4PKH
C	261	345	345	345	345

Installation Procedure

⚠ CAUTION

- The indoor unit must be installed according to the specified distances in order to permit accessibility from each side, to guarantee correct operation, maintenance, and repair of the unit. The components of the indoor unit must be reachable and removable under safe conditions for people and the unit.
- Do not hold the discharge while carrying the indoor unit to avoid the possibility of breakage.
- You must hold the hanger plate on the corner and carry the indoor unit.

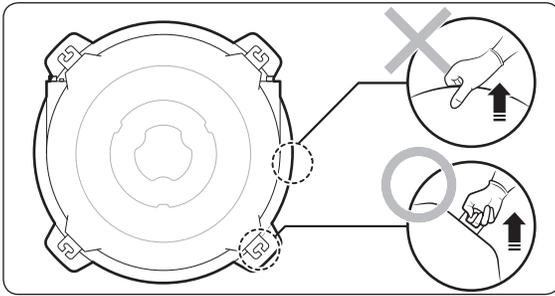

Step 3 Optional: Insulating the body of the indoor unit

If you install a cassette type indoor unit on the ceiling when temperature is over 27°C and humidity is over 80%, you must apply an extra 10 mm thick polyethylene insulation or a similar type of insulation to the body of the indoor unit.

Cut away the part where pipes are pulled out for the insulating work.

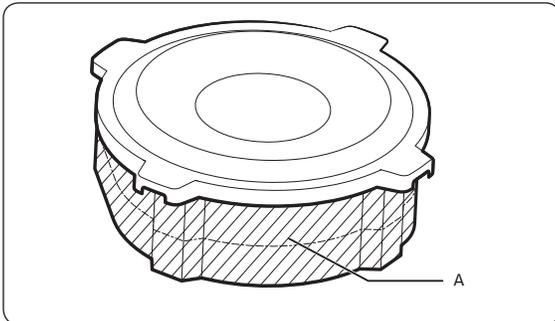

Insulate the end of the pipe and some curved area by using separate insulator.

📄 NOTE

- A: Reference for the outer circumference of the unit (When insulating the body of the indoor unit, use A as the reference for its outer circumference.)

Indoor unit type and models		Dimensions
360 cassette type <S> (947 x 947 x 281)	AC071MN4PKH	2610 x 130
360 cassette type <L> (947 x 947 x 365)	AC090MN4PKH	2610 x 215
	AC100MN4PKH	
	AC120MN4PKH	
360 cassette type <L+> (947 x 947 x 365)	AC140MN4PKH	2610 X 215

Step 4 Installing the indoor unit

When deciding on the location of the air conditioner the following restrictions must be taken into account.

- Determine the positions of the pipe and the drain hose hole as shown in the pattern sheet, and drill the hole with an inner diameter of 14 mm.

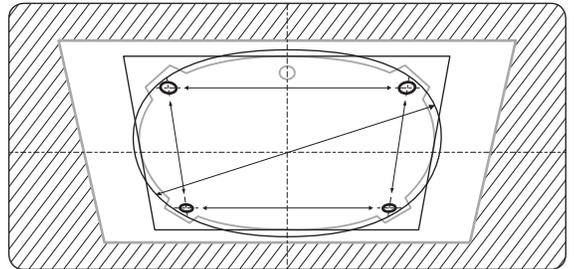

📄 NOTE

- Since the diagram is made of paper, it may shrink or stretch slightly due to temperature or humidity. For this reason, before drilling the holes, be sure to maintain the correct dimensions between the markings.

2 Perform the following steps to install inspection holes in accordance with the panel type.

- a For the recessed installation of the square panel.
- Install an inspection hole to the direction of connection parts of the refrigerant pipe and the drain hose. (1 point)

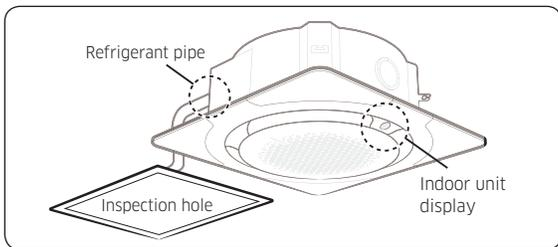

- b For recessed installation of the circular panel
- Install inspection holes to both directions of the connection part of the refrigerant pipe and the drain hose and of the indoor unit display. (2 points)

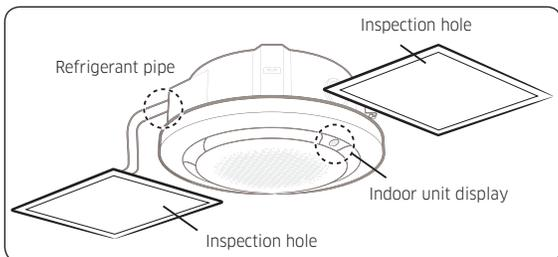

3 Insert bolt anchors, use existing ceiling supports or construct a suitable support as shown in figure.

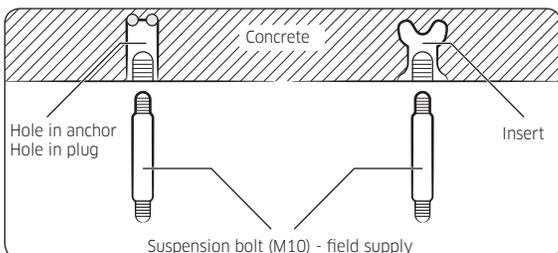

4 Install the suspension bolts, depending on the ceiling type.

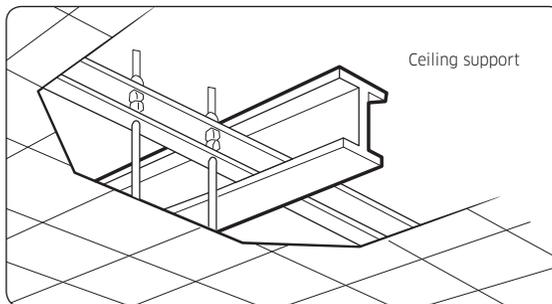

CAUTION

- Make sure that the ceiling is strong enough to support the weight of the indoor unit. Before hanging the unit, test the strength of each attached suspension bolt.
 - If the length of the suspension bolt is more than 1.5 m, you are required to prevent vibration.
- 5 Screw eight pairs of nuts and washers to the suspension bolts, making space for hanging the indoor unit.

CAUTION

- You must install all of the suspension rods.
- It is important to leave sufficient space in the false ceiling to allow access for maintenance or repairs to the drainage pipe connection, the refrigerant pipe connection, or to remove the unit if necessary.

6 Hang the indoor unit to the suspension bolts between two nuts. Cut a pad stopper and place it on the suspension bolts to hold the washers. Remove the stopper and screw the nuts to fix the unit.

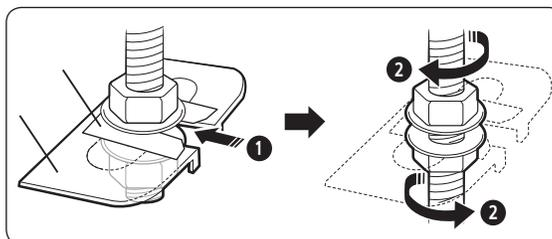

Installation Procedure

7 Adjust the unit to the appropriate position, taking into account the installation area for the front panel.

- Place the pattern sheet on the indoor unit.
- Adjust the space between the ceiling and the indoor unit by using a dimension gauge.
- Fix the indoor unit securely after adjusting the level of the unit by using a leveller.
- Remove the pattern sheet, connect the other cables, and install the front panel.

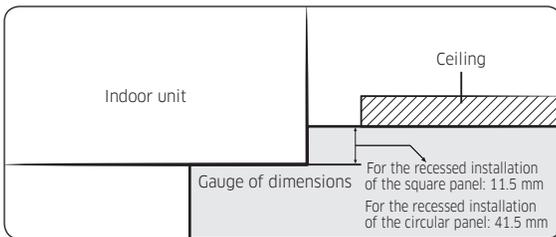

Step 5 Purging inert gas from the indoor unit

The indoor unit comes with nitrogen gas (inert gas) charged at the factory. Therefore, all inert gas must be purged before connecting the assembly piping.

Unscrew the pinch pipe at the end of each refrigerant pipe.

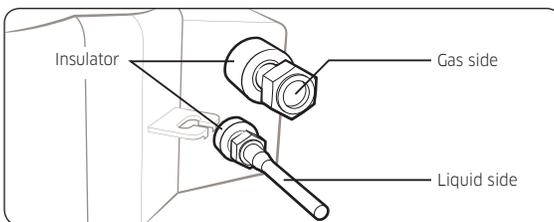

NOTE

- To prevent dirt or foreign objects from getting into the pipes during installation, do not remove the pinch pipe completely until you are ready to connect the piping.

Step 6 Cutting and flaring the pipes

- 1 Make sure that you have the required tools available: pipe cutter, reamer, flaring tool, and pipe holder.
- 2 If you wish to shorten the pipes, cut them with a pipe cutter, ensuring that the cut edge remains at a 90° angle to the side of the pipe. Refer to the illustrations below for examples of edges cut correctly and incorrectly.

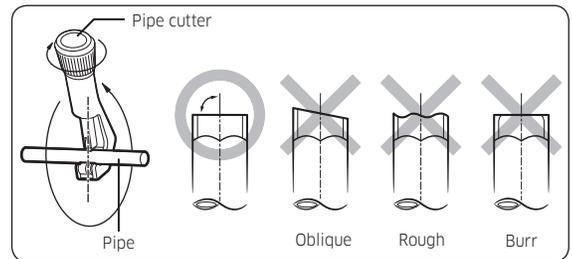

- 3 To prevent any gas from leaking out, remove all burrs at the cut edge of the pipe, using a reamer.
- 4 Slide a flare nut on to the pipe and modify the flare.

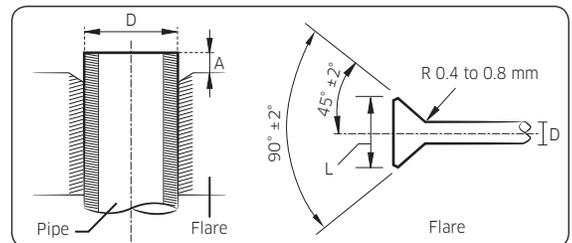

Outer Diameter (D)	Depth (A)	Flare dimension (L)
Ø6.35 mm	1.3 mm	8.7 to 9.1 mm
Ø9.52 mm	1.8 mm	12.8 to 13.2 mm
Ø12.70 mm	2.0 mm	16.2 to 16.6 mm
Ø15.88 mm	2.2 mm	19.3 to 19.7 mm
Ø19.05 mm	2.2 mm	23.6 to 24.0 mm

5 Check that the flaring is correct, referring to the illustrations below for examples of incorrect flaring.

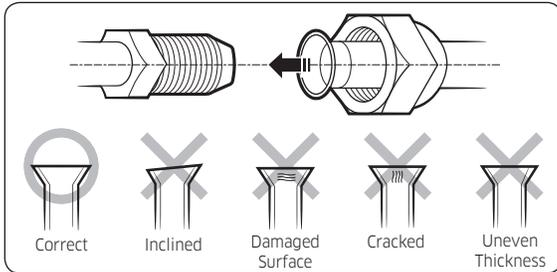

Step 7 Connecting the assembly pipes to the refrigerant pipes

There are two refrigerant pipes of different diameters :

- A smaller one for the liquid refrigerant.
 - A larger one for the gas refrigerant. The inside of copper pipe must be clean and has no dust.
- 1 Remove the pinch pipe on the pipes and connect the assembly pipes to each pipe, tightening the nuts, first manually and then with a torque wrench, a spanner applying the following torque.

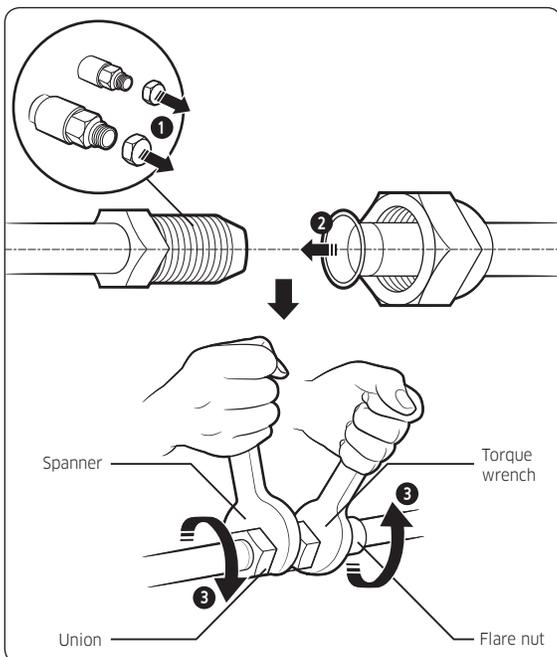

Outer Diameter (mm)	Torque (N•m)
Ø6.35	14 to 18
Ø9.52	34 to 42
Ø12.70	49 to 61
Ø15.88	68 to 82
Ø19.05	100 to 120

(1 N•m=10 kgf•cm)

NOTE

- If the pipes must be shortened, see **Step 6 Cutting and flaring the pipes** on page 10.
- 2 Be sure to use an insulator thick enough to cover the refrigerant tube to protect the condensate water on the outside of the pipe falling onto the floor and to improve the efficiency of the unit.
- 3 Cut off any excess foam insulation.
- 4 Make sure that there are no cracks or waves on the bent area.
- 5 It would be necessary to double the insulation thickness (10 mm or more) to prevent condensation even on the insulator when if the installed area is warm and humid.

CAUTION

- Connect the indoor and outdoor units using pipes with flared connections (not supplied). For the lines, use insulated, unwelded, degreased and deoxidized copper pipe (Cu DHP type to ISO 1337 or UNI EN 12735-1), suitable for operating pressures of at least 4.2 MPa and for a burst pressure of at least 20.7 MPa. Copper pipe for hydro-sanitary applications is completely unsuitable.
- For sizing and limits (height difference, line length, max. bends, refrigerant charge, etc.) see the outdoor unit installation manual.
- All refrigerant connection must be accessible, in order to permit either unit maintenance or removing it completely.
- If the pipes require brazing, make sure that oxygen free nitrogen (OFN) is flowing through the system.
- Nitrogen blowing pressure range is 0.02 to 0.05 MPa.

Installation Procedure

Step 8 Performing the gas leak test

To identify potential gas leaks on the indoor unit, inspect the connection area of each refrigerant pipe using a leak detector for R-410A.

Before recreating the vacuum and recirculating the refrigerant gas, pressurize the whole system with nitrogen (using a cylinder with a pressure reducer) at a pressure above 4 MPa in order to immediately detect leaks on the refrigerant fittings.

Made vacuum for 15 minutes and pressurizing system with nitrogen.

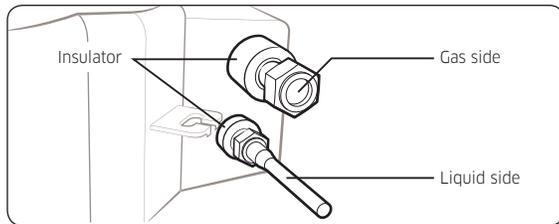

Step 9 Insulating the refrigerant pipes

Once you have checked that there are no leaks in the system, you can insulate the piping and hose.

- 1 To avoid condensation problems, place Acrylonitrile Butadiene Rubber separately around each refrigerant pipe.

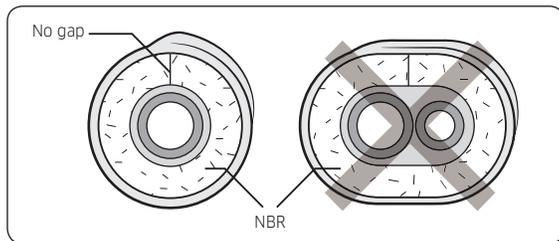

NOTE

- Always make the seam of pipes face upwards.
- 2 Wind insulating tape around the pipes and drain hose avoiding compressing the insulation too much.

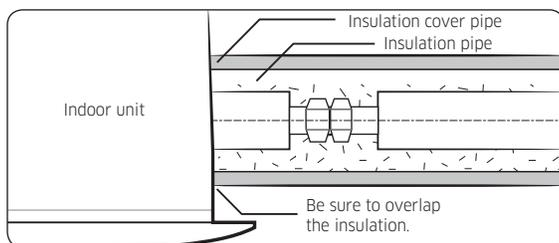

CAUTION

- Be sure to wrap insulation tightly without any gaps.
- 3 Finish wrapping insulating tape around the rest of the pipes leading to the outdoor unit.
 - 4 The pipes and electrical cables connecting the indoor unit with the outdoor unit must be fixed to the wall with suitable ducts.

CAUTION

- Make sure that all refrigerant connection must be accessible for easy maintenance and detachment.
- Install the insulation not to get wider and use the adhesives on the connection part of it to prevent moisture from entering.
- Wind the refrigerant pipe with insulation tape if it is exposed to outside sunlight.
- Install the refrigerant pipe respecting that the insulation does not get thinner on the bent part or hanger of pipe.
- Add the additional insulation if the insulation plate gets thinner.

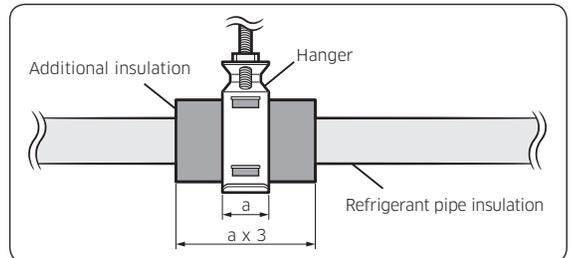

- 5 Select the insulation of the refrigerant pipe.
 - Insulate the gas side and liquid side pipe, noting the insulation thickness that must differ according to the pipe size.
 - Standard: Less than an indoor temperature of 30°C, with humidity at 85%. If installing in a high humidity environment, use one grade thicker insulator by referring to the table below. If installing in an unfavourable environment, use thicker one.
 - The heat-resistance temperature of the insulator must be more than 120°C.

Pipe	Pipe size	Insulation type (heating/cooling)		Remarks
		Standard (Less than 30°C, 85%)	High humidity (Over 30°C, 85%)	
		EPDM, NBR		
Liquid pipe	Ø6.35 to Ø9.52	9t	9t	The internal temperature is higher than 120°C.
	Ø12.7 to Ø19.05	13t	13t	
Gas pipe	Ø6.35	13t	19t	
	Ø9.52	19t	25t	
	Ø12.70			
	Ø15.88			
	Ø19.05			

- When installing insulation in the places and conditions below, use the same insulation that is used for high humidity conditions.

<Geological condition>
High humidity locations such as shorelines, hot springs, lake or riversides, and ridges (when part of the building is covered by earth and sand)
<Operation purpose condition>
Restaurant ceiling, sauna, swimming pool etc.
<Building construction condition>
Ceilings frequently exposed to moisture and cooling are not covered. For example, pipes installed at a corridor of a dormitory and studio or near an exit that opens and closes frequently. Places (where the pipes are installed) that are highly humid due to a lack of ventilation.

Step 10 Installing the drain hose and drain pipe

- 1 Push the supplied drain hose as far as possible over the drain socket.
- 2 Tighten the metal clamp as shown in the picture.

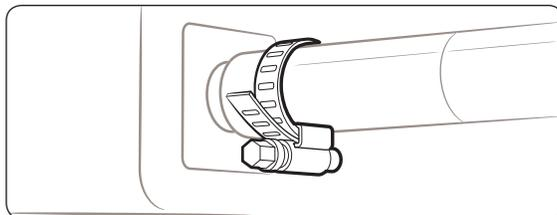

- 3 Wrap the supplied large sealing pad over the metal clamp and drain hose to insulate and fix it with clamps.
- 4 Insulate the complete drain piping inside the building (field supply).
If the drain hose cannot be sufficiently set on a slope, fit the hose with drain raising piping (field supply).

Installation Procedure

- 5 Push the drain hose up to insulation when connecting the drain hose to drain socket.

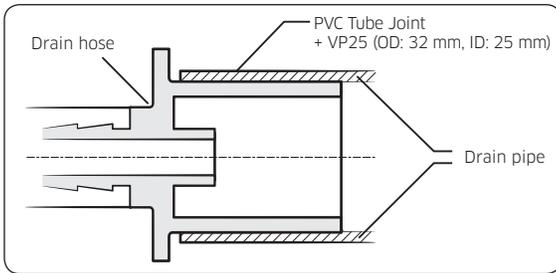
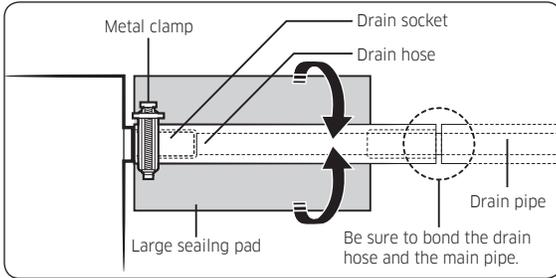

CAUTION

Check that the indoor unit is level with the ceiling by using the leveller.

- Install air ventilation to drain condensation smoothly.

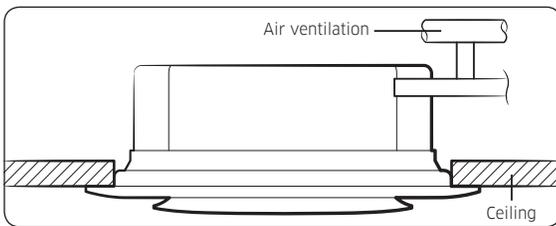

- If it is necessary to increase the height of the drain pipe, install the drain pipe straight within 300 mm from the drain hose port. If it is raised higher than 550 mm, there may be water leaks.

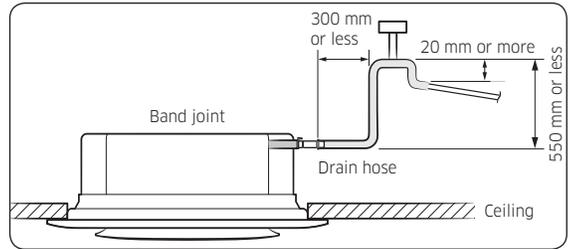

- Do not give the hose an upward gradient beyond the connection port. This will cause water to flow backwards when the unit is stopped, resulting in water leaks.

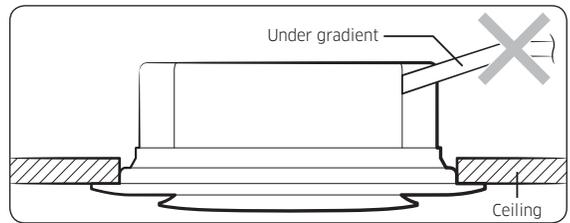

- Do not apply force to the piping on the unit side when connecting the drain hose. The hose should not be allowed to hang loose from its connection to the unit. Fasten the hose to a wall, frame or other support as close to the unit as possible.

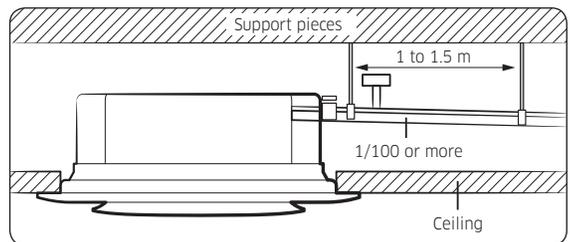

- Install horizontally.

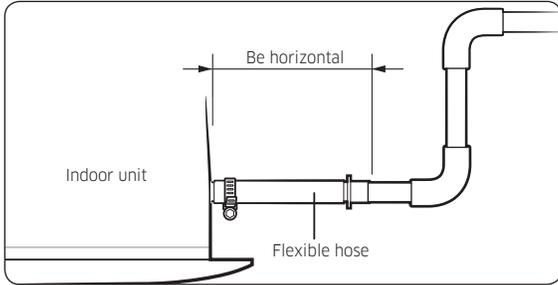

- Max. allowable axis gap.

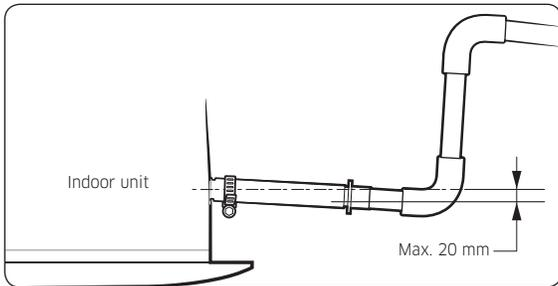

- Max. allowable bending angle.

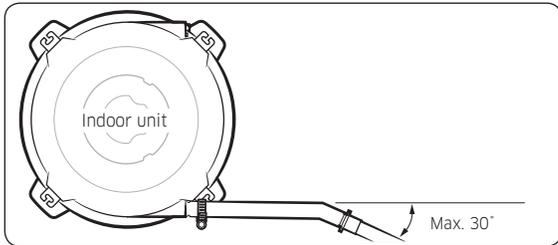

NOTE

- If a concentrated drain pipe is installed, refer to the figure below.

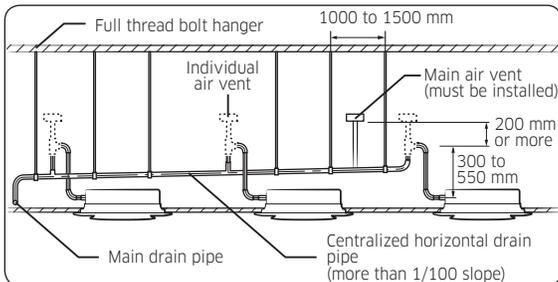

Step 11 Performing the drainage test

1 Do a leak test at the connection part of the flexible hose and the drain pipe:

- Connect a general hose to the connection part of the flexible hose of the indoor unit, and pour in some water.

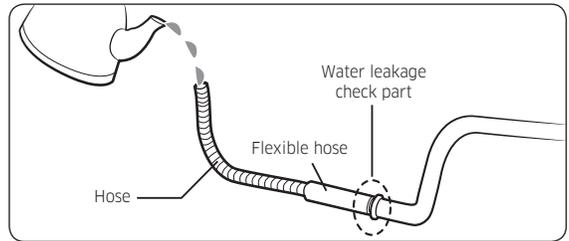

- After pouring some water, reassemble the rubber cap on the connection part of a flexible hose of the indoor unit and firmly tighten it with a band to prevent leakage.
- Check the leak test at the part where the adhesive for the flexible hose and the drain pipe is used.

CAUTION

- The leak test must be performed for at least 24 hours.
- 2** Check the condensed water drainage:
- Pour about 2 liters of water into the indoor unit drain pan as shown in the picture.

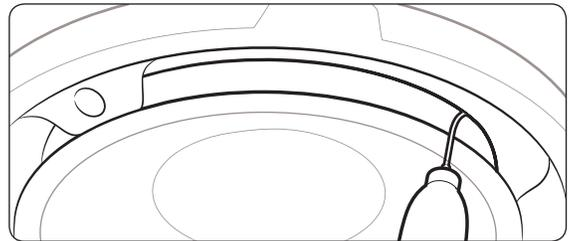

- When the electric cable connection is completed
 - Turn on the indoor unit and outdoor unit.
 - Operate in the Cool mode.

Installation Procedure

⚠ CAUTION

- Only in the Cool mode, you can check the correct operation of the drain pump.

When the electric cable connection has not been completed

- Remove the control box cover of the indoor unit.
- Connect the power supply (220~240V, 50 Hz) to the L and N terminals.
- Reassemble the control box cover and turn on the indoor unit.

⚠ CAUTION

- When the float switch is not detected due to insufficient water on the drain pan, the drain pump will not work.
- If the power supply is directly connected to the L and N terminals, communication error message might appear.
- After completing the drainage check, turn the unit off and disconnect the power supply.
- Reassemble the control box cover.

c Check whether the drain pump works correctly.

d Check whether the drainage is performing correctly at the end of the drain pipe.

e Check for leakage at the drain pipe and drain pipe connection part.

f When leakage occurs, check whether the indoor unit is level and check the drain hose connection part, drainpipe connection part and drain pump connection.

g When the drainage check is completed and the condensed water remains on the drain pan, remove the water.

⚠ CAUTION

- Always remember to connect the air conditioner to the grounding system before performing the electric connections. Use a crimp ring terminal at the end of each wire.

The indoor unit is powered through the outdoor unit by means of a H07 RN-F connection cable (or a more power model), with insulation in synthetic rubber and a jacket in polychloroprene (neoprene), in accordance with the requirements specified in the standard EN 60335-2-40.

- 1 Remove the screw on the electrical component box and remove the cover plate.
- 2 Route the connection cord through the side of the indoor unit and connect the cable to the terminals refer to the figure below.
- 3 Route the other end of the cable to the outdoor unit through the ceiling & the hole on the wall.
- 4 Reassemble the electrical component box cover, carefully tightening the screw.

Wiring terminals) 1 phase

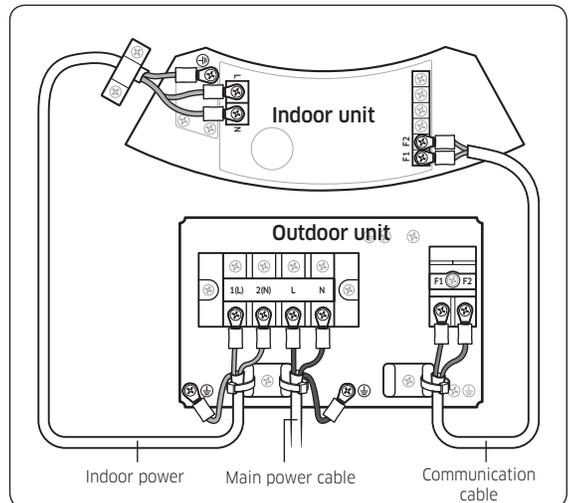

Step 12 Connecting the power and communication cables

⚠ CAUTION

- Always remember to connect the refrigerant pipes before performing the electric connections. When disconnecting the system, always disconnect the electric cables before disconnecting the refrigerant pipes.

Wiring terminals) 3 phase

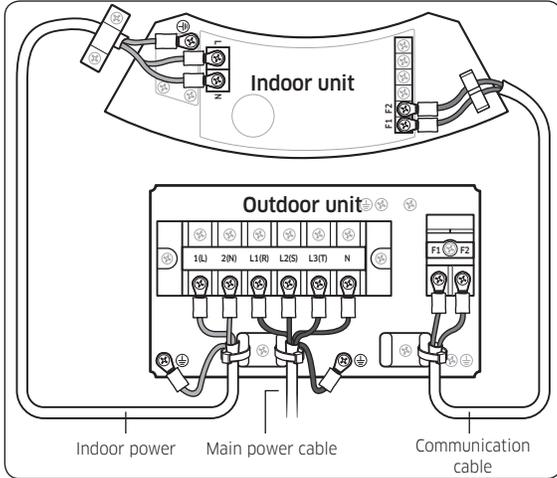

Indoor power supply		
Power supply	Max/Min(V)	Indoor power cable
220 to 240V, 50 Hz	±10%	0.75 to 1.5 mm ² , 3 wires
Communication cable		
0.75 to 1.5 mm ² , 2 wires		

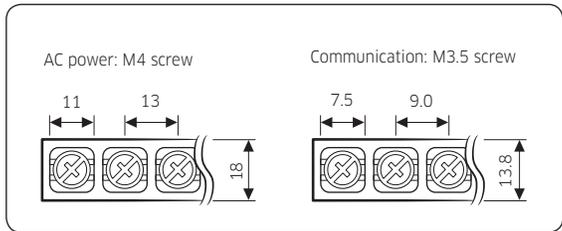

Tightening torque (kgf • cm)	
M3.5	8.0 to 12.0
M4	12.0 to 18.0

NOTE

- Insert the power and the communication cables to the cable insert hole, then arrange and connect the cables, as shown in the figure:

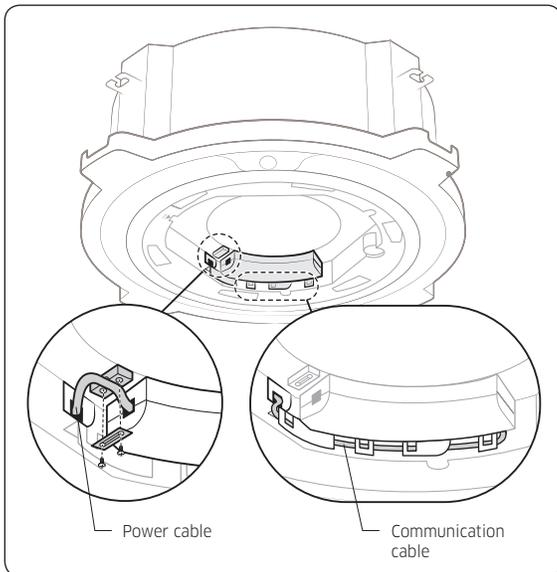
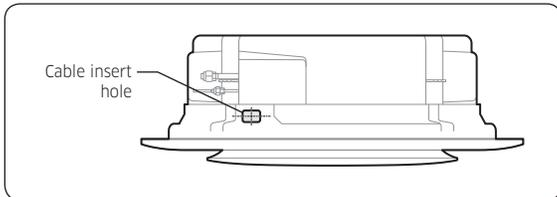

- 1 N·m = 10 kgf·cm
- Power supply cords of parts of appliances for outdoor use shall not be lighter than polychloroprene sheathed flexible cord. (Code designation IEC:60245 IEC 57 / CENELEC: H05RN-F or IEC:60245 IEC 66 / CENELEC: H07RN-F)
- Since it has the external power supply, refer to the outdoor unit installation manual for MAIN POWER.

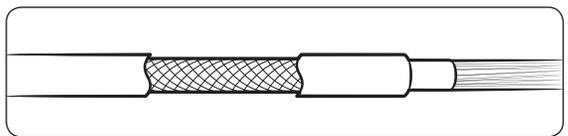

CAUTION

- When installing the indoor unit in a computer room or network room, use the double shielded communication cable (tape aluminum / polyester braid + copper) of FROHH2R type.

Installation Procedure

Step 13 Optional: Extending the power cable

1 Prepare the following tools.

Tools	Spec	Shape
Crimping pliers	MH-14	
Connection sleeve (mm)	20xØ6.5 (HxOD)	
Insulation tape	Width 19 mm	
Contraction tube (mm)	70xØ8.0 (LxOD)	

2 As shown in the figure, peel off the shields from the rubber and wire of the power cable.

- Peel off 20 mm of cable shields from the pre-installed tube.

CAUTION

- For information about the power cable specifications for indoor and outdoor units, refer to the installation manual.
- After peeling off cable wires from the pre-installed tube, insert a contraction tube.

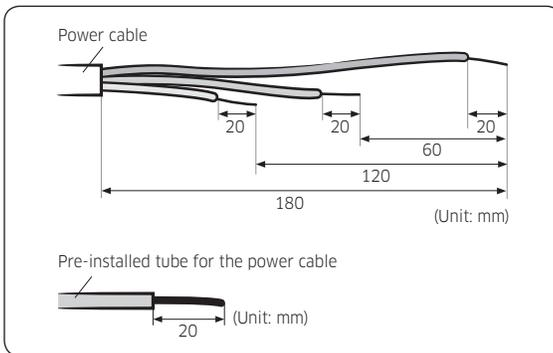

3 Insert both sides of core wire of the power cable into the connection sleeve.

- **Method 1:** Push the core wire into the sleeve from both sides.
- **Method 2:** Twist the wire cores together and push it into the sleeve.

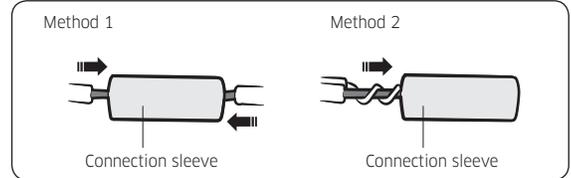

4 Using a crimping tool, compress the two points and flip it over and compress another two points in the same location.

- The compression dimension should be 8.0.

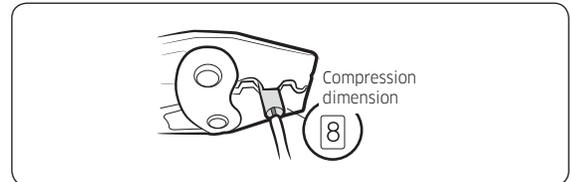

- After compressing it, pull both sides of the wire to make sure it is firmly pressed.

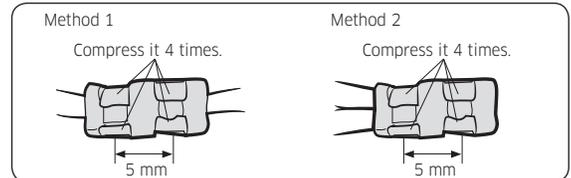

5 Wrap it with the insulation tape twice or more and position your contraction tube in the middle of the insulation tape.

Three or more layers of insulation are required.

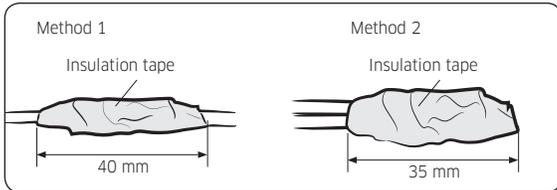

6 Apply heat to the contraction tube to contract it.

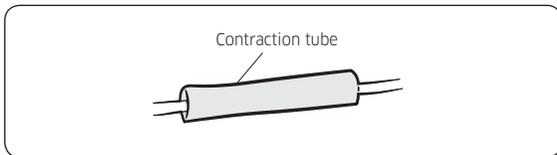

7 After tube contraction work is completed, wrap it with the insulation tape to finish.

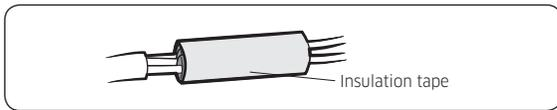

CAUTION

- Make sure that the connection parts are not exposed to outside.
- Be sure to use insulation tape and a contraction tube made of approved reinforced insulating materials that have the same level of withstand voltage with the power cable. (Comply with the local regulations on extensions.)

WARNING

- In case of extending the electric wire, please DO NOT use a round-shaped Pressing socket.
 - Incomplete wire connections can cause electric shock or a fire.

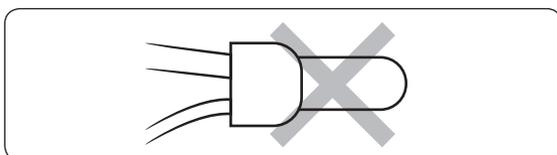

Step 14 Setting the indoor unit addresses and the installation options

You cannot set both of the indoor unit addresses and the installation options in a batch: set both of them respectively.

Common steps for setting the addresses and options

AR-KH00E remote control (for 360 cassette only)

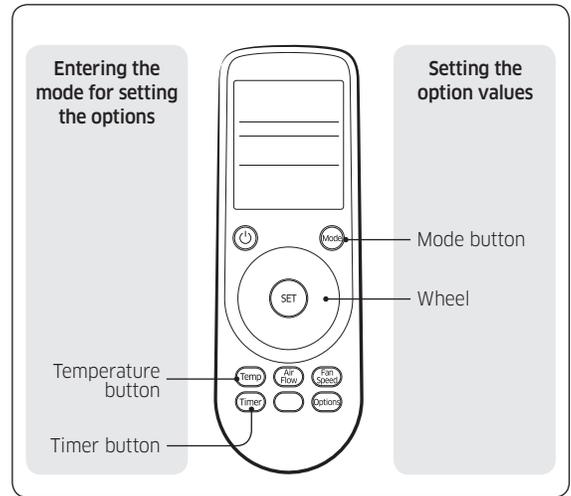

NOTE

- The remote control display may vary depending on the model.

1 Enter the mode for setting the options:

- Remove the batteries from the remote control.
- While holding down the **Temp** (Temp) and **Timer** (Timer) buttons simultaneously, insert the batteries into the remote control.
- Make sure that you are entered to the mode for setting the options:

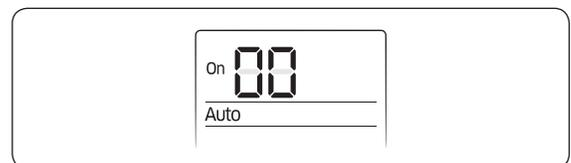

Installation Procedure

2 Set the option values.

CAUTION

- The total number of available options are 24: SEG1 to SEG24.
- Because SEG1, SEG7, SEG13, and SEG19 are the page options used by the previous remote control models, the modes to set values for these options are skipped automatically.
- Set a 2-digit value for each option pair in the following order: SEG2 and SEG3 → SEG4 and SEG5 → SEG6 and SEG8 → SEG9 and SEG10 → SEG11 and SEG12 → SEG14 and SEG15 → SEG16 and SEG17 → SEG18 and SEG20 → SEG21 and SEG22 → SEG23 and SEG24

SEG1	SEG2	SEG3	SEG4	SEG5	SEG6
0	X	X	X	X	X
SEG7	SEG8	SEG9	SEG10	SEG11	SEG12
1	X	X	X	X	X
SEG13	SEG14	SEG15	SEG16	SEG17	SEG18
2	X	X	X	X	X
SEG19	SEG20	SEG21	SEG22	SEG23	SEG24
3	X	X	X	X	X

On (SEG1 to SEG12)	Off (SEG13 to SEG24)
	

Take the steps presented in the following table:

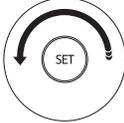
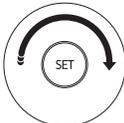
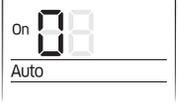
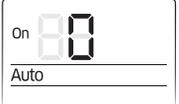
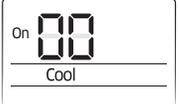
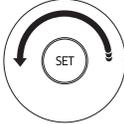
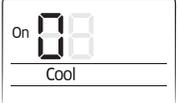
Steps	Remote control display
<p>1 Set the SEG2 and SEG3 values:</p> <p>a Set the SEG2 value by rotating the Wheel counterclockwise until the value you want to set appears on the remote control display.</p>  <p>b Set the SEG3 value by rotating the Wheel clockwise until the value you want to set appears on the remote control display.</p>  <p>When you rotate the Wheel, values appear in the following order: 0 → 1 → ... → E → F</p>	 <p>SEG2</p>  <p>SEG3</p>
<p>2 Press the  (Mode) button. Cool and On appear on the remote control display.</p>	
<p>3 Set the SEG4 and SEG5 values:</p> <p>a Set the SEG4 value by rotating the Wheel counterclockwise until the value you want to set appears on the remote control display.</p> 	 <p>SEG4</p>

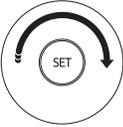
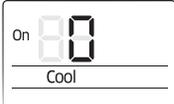
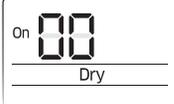
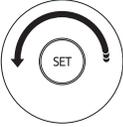
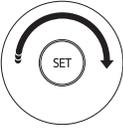
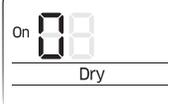
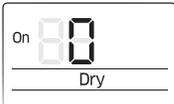
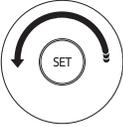
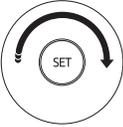
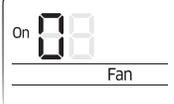
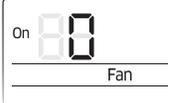
Steps		Remote control display
<p>b Set the SEG5 value by rotating the Wheel clockwise until the value you want to set appears on the remote control display.</p>		 <p style="text-align: center;">SEG5</p>
<p>When you rotate the Wheel, values appear in the following order: 0 → 1 → ... → E → F</p>		
<p>4 Press the  (Mode) button. Dry and On appear on the remote control display.</p>		
<p>5 Set the SEG6 and SEG8 values:</p> <p>a Set the SEG6 value by rotating the Wheel counterclockwise until the value you want to set appears on the remote control display.</p> <p>b Set the SEG8 value by rotating the Wheel clockwise until the value you want to set appears on the remote control display.</p>	 	  <p style="text-align: center;">SEG8</p>
<p>When you rotate the Wheel, values appear in the following order: 0 → 1 → ... → E → F</p>		
<p>6 Press the  (Mode) button. Fan and On appear on the remote control display.</p>		
<p>7 Set the SEG9 and SEG10 values:</p> <p>a Set the SEG9 value by rotating the Wheel counterclockwise until the value you want to set appears on the remote control display.</p> <p>b Set the SEG10 value by rotating the Wheel clockwise until the value you want to set appears on the remote control display.</p>	 	  <p style="text-align: center;">SEG10</p>
<p>When you rotate the Wheel, values appear in the following order: 0 → 1 → ... → E → F</p>		
<p>8 Press the  (Mode) button. Heat and On appear on the remote control display.</p>		

Installation Procedure

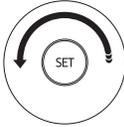
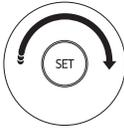
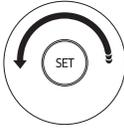
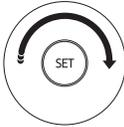
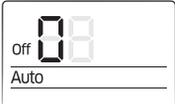
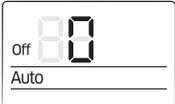
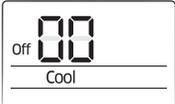
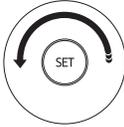
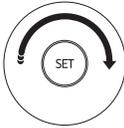
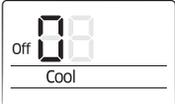
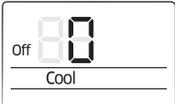
Steps	Remote control display
<p>9 Set the SEG11 and SEG12 values:</p> <p>a Set the SEG11 value by rotating the Wheel counterclockwise until the value you want to set appears on the remote control display.</p>  <p>b Set the SEG12 value by rotating the Wheel clockwise until the value you want to set appears on the remote control display.</p>  <p>When you rotate the Wheel, values appear in the following order: 0 → 1 → ... → E → F</p>	 <p>SEG11</p>  <p>SEG12</p>
<p>10 Press the  (Mode) button. Auto and Off appear on the remote control display.</p>	
<p>11 Set the SEG14 and SEG15 values:</p> <p>a Set the SEG14 value by rotating the Wheel counterclockwise until the value you want to set appears on the remote control display.</p>  <p>b Set the SEG15 value by rotating the Wheel clockwise until the value you want to set appears on the remote control display.</p>  <p>When you rotate the Wheel, values appear in the following order: 0 → 1 → ... → E → F</p>	 <p>SEG14</p>  <p>SEG15</p>
<p>12 Press the  (Mode) button. Cool and Off appear on the remote control display.</p>	
<p>13 Set the SEG16 and SEG17 values:</p> <p>a Set the SEG16 value by rotating the Wheel counterclockwise until the value you want to set appears on the remote control display.</p>  <p>b Set the SEG17 value by rotating the Wheel clockwise until the value you want to set appears on the remote control display.</p>  <p>When you rotate the Wheel, values appear in the following order: 0 → 1 → ... → E → F</p>	 <p>SEG16</p>  <p>SEG17</p>

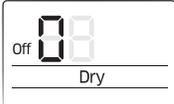
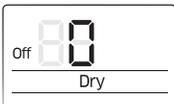
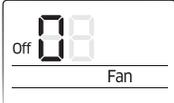
Steps	Remote control display
14 Press the  (Mode) button. Dry and Off appear on the remote control display.	
15 Set the SEG18 and SEG20 values: <ul style="list-style-type: none"> <li data-bbox="148 544 651 629">a Set the SEG18 value by rotating the Wheel counterclockwise until the value you want to set appears on the remote control display. <li data-bbox="148 668 702 752">b Set the SEG20 value by rotating the Wheel clockwise until the value you want to set appears on the remote control display. <p data-bbox="141 838 927 864">When you rotate the Wheel, values appear in the following order: 0 → 1 → ... → E → F</p>	 
16 Press the  (Mode) button. Fan and Off appear on the remote control display.	
17 Set the SEG21 and SEG22 values: <ul style="list-style-type: none"> <li data-bbox="148 1068 651 1152">a Set the SEG21 value by rotating the Wheel counterclockwise until the value you want to set appears on the remote control display. <li data-bbox="148 1191 702 1275">b Set the SEG22 value by rotating the Wheel clockwise until the value you want to set appears on the remote control display. <p data-bbox="141 1362 927 1387">When you rotate the Wheel, values appear in the following order: 0 → 1 → ... → E → F</p>	 
18 Press the  (Mode) button. Heat and Off appear on the remote control display.	
19 Set the SEG23 and SEG24 values: <ul style="list-style-type: none"> <li data-bbox="148 1591 651 1675">a Set the SEG23 value by rotating the Wheel counterclockwise until the value you want to set appears on the remote control display. 	

Installation Procedure

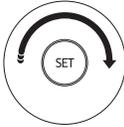
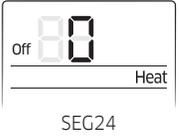
Steps	Remote control display
<p>b Set the SEG24 value by rotating the Wheel clockwise until the value you want to set appears on the remote control display.</p>  <p>When you rotate the Wheel, values appear in the following order: 0 → 1 → ... E → F</p>	

- 3** Check whether the option values that you have set are correct by pressing the  (Mode) button repeatedly

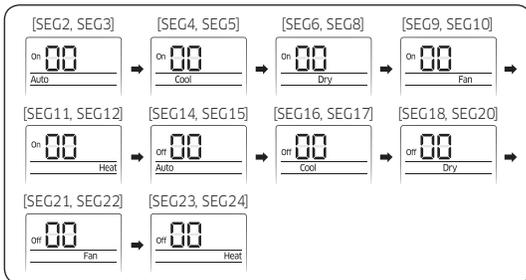

- 4** Save the option values into the indoor unit:

Point the remote control to the remote control sensor on the indoor unit and then press the  (Power) button on the remote control twice. Make sure that this command is received by the indoor unit. When it is successfully received, you can hear a short sound from the indoor unit. If the command is not received, press the  (Power) button again.

- 5** Check whether the air conditioner operates in accordance with the option values you have set:

- a** Reset the indoor or outdoor unit.
- Indoor unit : Press the  (Set) and  (Option) buttons on the remote control simultaneously for 4 seconds.
 - Outdoor unit : Press the K3 button.
- b** Remove the batteries from the remote control, insert them again, and then press the  (Power) button on the remote control.

MR-EC00 and MR-EH00 remote controls

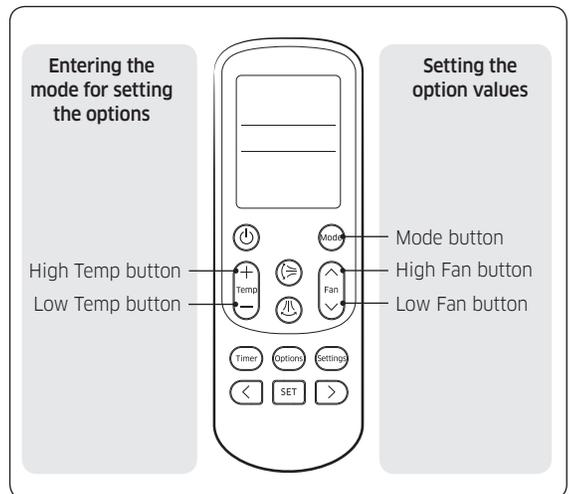

NOTE

- The remote control display and buttons may vary depending on the model.
- 1** Enter the mode for setting the options:
- Remove the batteries from the remote control, and then insert them again.
 - While holding down the  (High Temp) and  (Low Temp) buttons simultaneously, insert the batteries into the remote control.
 - Make sure that you are entered to the mode for setting the options:

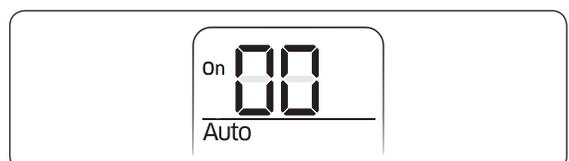

2 Set the option values.

CAUTION

- The total number of available options are 24: SEG1 to SEG24.
- Because SEG1, SEG7, SEG13, and SEG19 are the page options used by the previous remote control models, the modes to set values for these options are skipped automatically.
- Set a 2-digit value for each option pair in the following order: SEG2 and SEG3 → SEG4 and SEG5 → SEG6 and SEG8 → SEG9 and SEG10 → SEG11 and SEG12 → SEG14 and SEG15 → SEG16 and SEG17 → SEG18 and SEG20 → SEG21 and SEG22 → SEG23 and SEG24

SEG1	SEG2	SEG3	SEG4	SEG5	SEG6
0	X	X	X	X	X
SEG7	SEG8	SEG9	SEG10	SEG11	SEG12
1	X	X	X	X	X
SEG13	SEG14	SEG15	SEG16	SEG17	SEG18
2	X	X	X	X	X
SEG19	SEG20	SEG21	SEG22	SEG23	SEG24
3	X	X	X	X	X

On (SEG1 to SEG12)	Off (SEG13 to SEG24)
	

Take the steps presented in the following table:

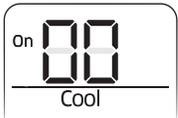
Steps	Remote control display
<p>1 Set the SEG2 and SEG3 values:</p> <p>a Set the SEG2 value by pressing the  (Low Fan) button repeatedly until the value you want to set appears on the remote control display.</p> <p>b Set the SEG3 value by pressing the  (High Fan) button repeatedly until the value you want to set appears on the remote control display.</p> <p>When you press the  (Low Fan) or  (High Fan) button, values appear in the following order: 0 → 1 → ... E → F</p>	 <p>SEG2</p>  <p>SEG3</p>
<p>2 Press the  (Mode) button. Cool and On appear on the remote control display.</p>	

Installation Procedure

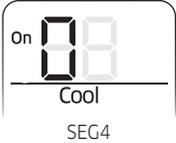
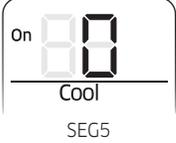
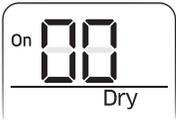
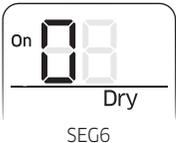
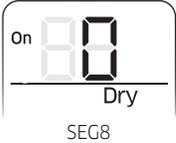
Steps	Remote control display
<p>3 Set the SEG4 and SEG5 values:</p> <p>a Set the SEG4 value by pressing the  (Low Fan) button repeatedly until the value you want to set appears on the remote control display.</p> <p>b Set the SEG5 value by pressing the  (High Fan) button repeatedly until the value you want to set appears on the remote control display.</p> <p>When you press the  (Low Fan) or  (High Fan) button, values appear in the following order:  →  → ... →  → </p>	 
<p>4 Press the  (Mode) button. Dry and On appear on the remote control display.</p>	
<p>5 Set the SEG6 and SEG8 values:</p> <p>a Set the SEG6 value by pressing the  (Low Fan) button repeatedly until the value you want to set appears on the remote control display.</p> <p>b Set the SEG8 value by pressing the  (High Fan) button repeatedly until the value you want to set appears on the remote control display.</p> <p>When you press the  (Low Fan) or  (High Fan) button, values appear in the following order:  →  → ... →  → </p>	 
<p>6 Press the  (Mode) button. Fan and On appear on the remote control display.</p>	
<p>7 Set the SEG9 and SEG10 values:</p> <p>a Set the SEG9 value by pressing the  (Low Fan) button repeatedly until the value you want to set appears on the remote control display.</p>	

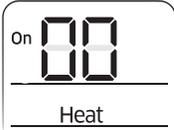
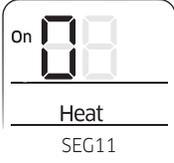
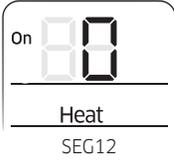
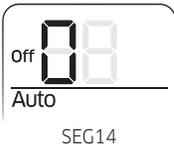
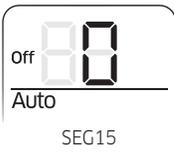
Steps	Remote control display
<p>b Set the SEG10 value by pressing the  (High Fan) button repeatedly until the value you want to set appears on the remote control display.</p> <p>When you press the  (Low Fan) or  (High Fan) button, values appear in the following order: $\square \rightarrow \blacksquare \rightarrow \dots \rightarrow \text{E} \rightarrow \text{F}$</p>	
<p>8 Press the  (Mode) button. Heat and On appear on the remote control display.</p>	
<p>9 Set the SEG11 and SEG12 values:</p> <p>a Set the SEG11 value by pressing the  (Low Fan) button repeatedly until the value you want to set appears on the remote control display.</p> <p>b Set the SEG12 value by pressing the  (High Fan) button repeatedly until the value you want to set appears on the remote control display.</p> <p>When you press the  (Low Fan) or  (High Fan) button, values appear in the following order: $\square \rightarrow \blacksquare \rightarrow \dots \rightarrow \text{E} \rightarrow \text{F}$</p>	 
<p>10 Press the  (Mode) button. Auto and Off appear on the remote control display.</p>	
<p>11 Set the SEG14 and SEG15 values:</p> <p>a Set the SEG14 value by pressing the  (Low Fan) button repeatedly until the value you want to set appears on the remote control display.</p> <p>b Set the SEG15 value by pressing the  (High Fan) button repeatedly until the value you want to set appears on the remote control display.</p> <p>When you press the  (Low Fan) or  (High Fan) button, values appear in the following order: $\square \rightarrow \blacksquare \rightarrow \dots \rightarrow \text{E} \rightarrow \text{F}$</p>	 

Installation Procedure

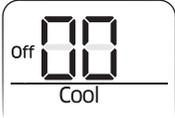
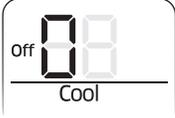
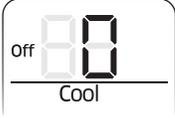
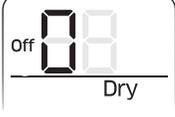
Steps	Remote control display
<p>12 Press the  (Mode) button. Cool and Off appear on the remote control display.</p>	
<p>13 Set the SEG16 and SEG17 values:</p> <p>a Set the SEG16 value by pressing the  (Low Fan) button repeatedly until the value you want to set appears on the remote control display.</p> <p>b Set the SEG17 value by pressing the  (High Fan) button repeatedly until the value you want to set appears on the remote control display.</p> <p>When you press the  (Low Fan) or  (High Fan) button, values appear in the following order: 0 → 1 → ... E → F</p>	 
<p>14 Press the  (Mode) button. Dry and Off appear on the remote control display.</p>	
<p>15 Set the SEG18 and SEG20 values:</p> <p>a Set the SEG18 value by pressing the  (Low Fan) button repeatedly until the value you want to set appears on the remote control display.</p> <p>b Set the SEG20 value by pressing the  (High Fan) button repeatedly until the value you want to set appears on the remote control display.</p> <p>When you press the  (Low Fan) or  (High Fan) button, values appear in the following order: 0 → 1 → ... E → F</p>	 
<p>16 Press the  (Mode) button. Fan and Off appear on the remote control display.</p>	
<p>17 Set the SEG21 and SEG22 values:</p> <p>a Set the SEG21 value by pressing the  (Low Fan) button repeatedly until the value you want to set appears on the remote control display.</p>	

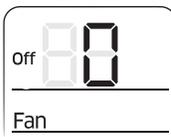
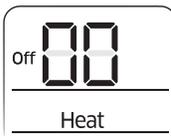
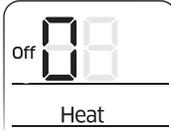
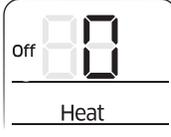
Steps	Remote control display
<p>b Set the SEG22 value by pressing the  (High Fan) button repeatedly until the value you want to set appears on the remote control display.</p> <p>When you press the  (Low Fan) or  (High Fan) button, values appear in the following order: 0 → 1 → ... → E → F</p>	 SEG22
<p>18 Press the  (Mode) button. Heat and Off appear on the remote control display.</p>	 Heat
<p>19 Set the SEG23 and SEG24 values:</p> <p>a Set the SEG23 value by pressing the  (Low Fan) button repeatedly until the value you want to set appears on the remote control display.</p> <p>b Set the SEG24 value by pressing the  (High Fan) button repeatedly until the value you want to set appears on the remote control display.</p> <p>When you press the  (Low Fan) or  (High Fan) button, values appear in the following order: 0 → 1 → ... → E → F</p>	 SEG23  SEG24

3 Check whether the option values that you have set are correct by pressing the  (Mode) button repeatedly

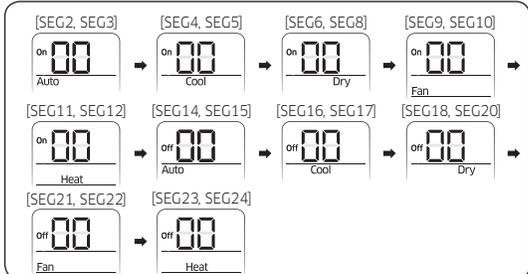

4 Save the option values into the indoor unit:

Point the remote control to the remote control sensor on the indoor unit and then press the  (Power) button on the remote control twice. Make sure that this command is received by the indoor unit. When it is successfully received, you can hear a short sound from the indoor unit. If the command is not received, press the  (Power) button again.

5 Check whether the air conditioner operates in accordance with the option values you have set:

- a** Reset the indoor or outdoor unit.
 - Indoor unit : Press the  (Set) and  (Low Fan) buttons on the remote control simultaneously for 4 seconds.
 - Outdoor unit : Press the K3 button.
- b** Remove the batteries from the remote control, insert them again, and then press the  (Power) button on the remote control.

Installation Procedure

Setting the indoor unit addresses

Option No. for an indoor unit address:
0AXXXX-1XXXXX-2XXXXX-3XXXXX

Before installing an indoor unit, be sure to set an address for the indoor unit by taking the following steps:

- 1 Make sure that the power is supplied to the indoor unit. If the indoor unit is not plugged in, it must include a power supply.

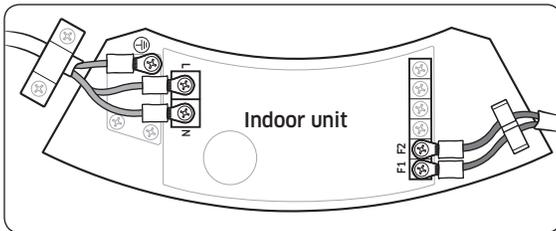

- 2 Set an address for each indoor unit using the remote control, according to your air conditioning system plan, by referring to the following table and by following the steps in **Common steps for setting the addresses and options** on page 19.

- The indoor unit addresses (main and RMC addresses) are set to 0A0000-100000-200000-300000 by default.
- If indoor units and outdoor units match 1:1, you don't need to set the main address because it is automatically set by the outdoor unit.
- If you are using on or off controller, set RMC address.

Option	SEG1		SEG2		SEG3		SEG4	SEG5		SEG6			
Function	Page		Mode		Setting main address		Reserved	Indoor unit number		Indoor unit number			
Indication and details	Indication	Details	Indication	Details	Indication	Details		Indication	Details	Indication	Details		
	0		A		0	No main address		0 to 1	Tens digit	0 to 9	Units digit		
				1	Main address setting mode								
Option	SEG7		SEG8		SEG9		SEG10	SEG11		SEG12			
Function	Page		Reserved		Setting RMC address		Reserved	Group channel (x16)		Group address			
Indication and details	Indication	Details			Indication	Details		Indication	Details	Indication	Details	Indication	Details
	1				0	No RMC address		RMC1	0 to 2	RMC2	0 to F		
				1	RMC address setting mode								

⚠ CAUTION

- The main address must be set to a value in the range 0 to 14. If you set other values, communication error will occur.
- If any of SEG5 and SEG6 is set to a value in the range A to F, the main address of the indoor unit does not change.
- If SEG3 is set to 0, the indoor unit maintains the existing main address even if SEG6 is set to a new value.
- If SEG9 is set 0, the indoor unit maintains the existing RMC address even if SEG11 and SET12 are set to new values.

Setting the installation options in a batch

Option No. for an indoor unit address:
02XXXX-1XXXXX-2XXXXX-3XXXXX

- 1 Make sure that the power is supplied to the indoor unit. If the indoor unit is not plugged in, it must include a power supply.

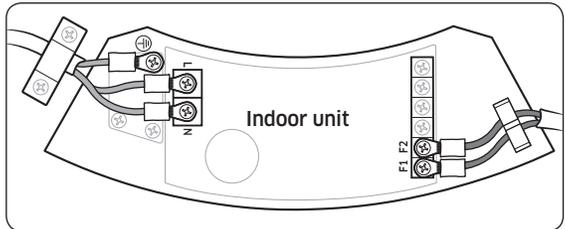

- 2 Set the installation options of indoor units, by referring to the following table and by following the steps in **Common steps for setting the addresses and options** on page 19.

- The installation options of indoor units are set to 020000-100000-200000-300000 by default.
- The SEG20 option, Individual control with remote control, allows you to control multiple indoor units individually by using the remote control.

Option	SEG1		SEG2		SEG3	SEG4		SEG5		SEG6	
Function	Page		Mode		Reserved	Use of external temperature sensor		Use of central control		Compensation of the fan RPM	
Indication and details	Indication	Details	Indication	Details		Indication	Details	Indication	Details	Indication	Details
	0			2			0	Disuse	0	Disuse	0
										1	High-ceiling mode (recessed installation)
						1	Use	1	Use	4	Disuse (exposed installation)
										5	High-ceiling mode (exposed installation)

Installation Procedure

Option	SEG7		SEG8		SEG9		SEG10		SEG11		SEG12	
Function	Page		Use of drain pump									
Indication and details	Indication	Details	0	Disuse	Reserved	Reserved	Reserved	Reserved	Reserved	Reserved	Reserved	Reserved
			1	Use								
			2	Use with 3 minute delay								
Option	SEG13		SEG14		SEG15		SEG16		SEG17		SEG18	
Function	Page		Use of external control		Setting the output of external control		S-Plasma ion		Buzzer control		Maximum filter usage time	
Indication and details	Indication	Details	0	Disuse	0	Thermo on	0	Disuse	0	Use of buzzer	2	1000 hours
			1	On/Off control								
			2	Off control								
			3	Window on/off control								
			4	Disuse	1	Operation on	1	Use	1	Disuse of buzzer	6	2000 hours
			5	On/Off control								
			6	Off control								
			7	Window on/off control								
Option	SEG19		SEG20		SEG21		SEG22		SEG23		SEG24	
Function	Page		Individual control with remote control		Heating setting compensation						Cycle time of Swing	
Indication and details	Indication	Details	0 or 1	Indoor 1	0	Default	Reserved	Reserved	Reserved	Reserved	0	34 seconds (default)
			2	Indoor 2	1	2°C					1	30 seconds
			3	Indoor 3	2	5°C					2	38 seconds
			4	Indoor 4								

Installation Procedure

- Even if you set the Use of drain pump (SEG8) option to 0, it is automatically set to 2 (the drain pump is used with 3 minute delay).
 - If you set the Maximum filter usage time (SEG18) option to a value other than 2 and 6, it is automatically set to 2 (1000 hours).
 - If you set the Individual control with remote control (SEG20) option to a value other than 0 to 4, it is automatically set to 0 (Indoor 1).
 - Default value of Heating setting compensation (SEG21) is 5°C for 360 cassette model.
- * Level control: The centralized controller can limit the functions and inputs of connected products with this function enabled. (Example: Operation mode limit (Cooling only/Heating only/No limitation), Heating temperature upper limit, Cooling temperature lower limit)
To enable 'Level control' when applying the DPM with the centralized controller, appoint the master (Set 'Use of external control [SEG14] option to 4 or higher).

Example: When installing DPM (1 Outdoor unit with 4 indoor units)

Condition		SEG14 Setting				Result
External control	Level control	Indoor 1	Indoor 2	Indoor 3	Indoor 4	
Default		Not set (0)				Slave (All)
Disuse	Use	4	Not set (0)	Not set (0)	Not set (0)	Master (Indoor 1), Slave (Indoor 2,3,4)
Use (Indoor 3)	Disuse	Not set (0)	Not set (0)	1~3	Not set (0)	Slave (All)
Use (Indoor 4)	Use	Not set (0)	Not set (0)	Not set (0)	5~7	Master (Indoor 4), Slave (Indoor 1,2,3)

Changing the addresses and options individually

When you want to change the value of a specific option, refer to the following table and follow the steps in **Common steps for setting the addresses and options** on page 19.

Option	SEG1		SEG2		SEG3		SEG4		SEG5		SEG6	
Function	Page		Mode		Option mode to change		Tens position of the option number		Units position of the option number		New value	
Indication and details	Indication	Details	Indication	Details	Indication	Details	Indication	Details	Indication	Details	Indication	Details
		0		D		Option type	0 to F	Tens position value	0 to 9	Units position value	0 to 9	New value

Example: Changing the Buzzer control (SEG17) option of the installation options to 1 disuse.

Option	SEG1	SEG2	SEG3	SEG4	SEG5	SEG6
Function	Page	Mode	Option mode to change	Tens position of the option number	Units position of the option number	New value
Indication	0	D	2	1	7	1

Installation Procedure

Optional: For the installation of the circular panel

Making a circular opening on the ceiling

Use a paper compass printed on the indoor unit package (attached inside to the upper part)

- 1 Use a bolt or a pin to fix pivot point of the paper compass on center of the ceiling. (in the middle of location for installation)

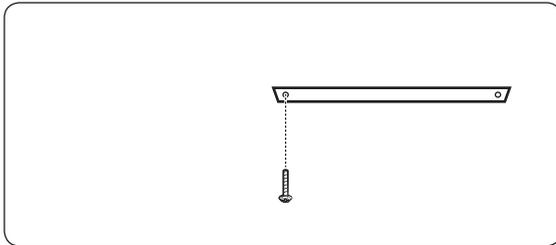

- 2 Put a pencil at the opposite side of the pivot point fixed in place.

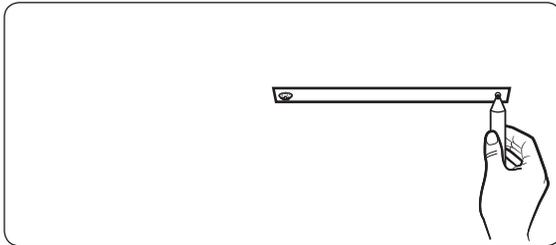

- 3 Rotate the paper compass on its pivot point to draw a line on the ceiling.

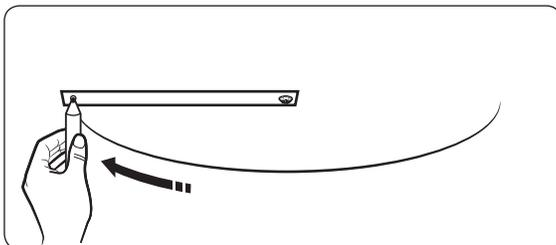

- 4 Rotate the paper compass diametrically to draw a circle on the ceiling.

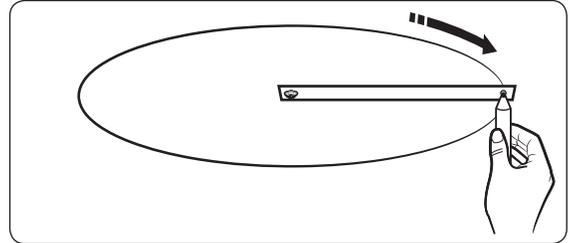

For the painting of the panel

- Make sure to only apply paints and varnishes for resins (ABS, HIPS) or paint thinners.
- If you apply lacquers for general use on the panel, it may lead to discoloration or erosion on the surface of the panel.

Optional: Installing DPM (Digital Packaged Multi)

NOTE

Only AC071MN4PKH, AC100MN4PKH and AC120MN4PKH models are available to install DPM.

- When installing DPM, you should set "DPM setting" to the outdoor unit.
- You do not need to set the address manually for the indoor unit.
- If DPM model is not set, communication error may occur.
- While the outdoor unit is tracking the indoor unit for one minute after the power supply is turned on, the operation may stop if the remote control reception signal of the installed indoor unit is different.
- To enable Level control with the centralized controller, refer to page 32, 33.

CAUTION

- When installing DPM, only one external controller can be connected.

Troubleshooting

Condition	Indoor unit display indications			
	Ice blue	Yellow green	Blue	Red
Power reset (blinking once every 2 seconds)	●	X	X	X
In the defrost operation (blinking once every 10 seconds)	●	X	X	X
Open or short circuit error of the indoor-temperature sensor	X	X	X	●
Error of the outdoor unit	X	X	●	X
Communication error between the indoor and outdoor units	X	●	X	X
Open or short circuit error of a sensor (evaporator-in, evaporator-out, or discharge sensor) in the indoor unit	X	●	X	●
Error of the fan in the indoor unit	X	X	●	●
Error of the second detection of the float switch	X	●	●	X
Open circuit error of the thermal fuse	●	X	●	X
EEPROM error	●	●	X	●

● : On, ◐ : Blinking, X : Off

