

	INDOOR UNIT	OUTDOOR UNIT
Model :	AC026MNNDKH	AC026MXADKH
	AC035MNNDKH	AC035MXADKH
	AC052MNNDKH	AC052MXADKH
	AC060MNNDKH	AC060MXADKH
	AC071MNNDKH	AC071MXADKH

SERVICE *Manual*

AIR CONDITIONER



AC026MNNDKH
AC035MNNDKH
AC052MNNDKH
AC060MNNDKH
AC071MNNDKH



AC026MXADKH
AC035MXADKH



AC052MXADKH
AC060MXADKH



AC071MXADKH

CONTENTS

1. Precautions
2. Product Specifications
3. Disassembly and Reassembly
4. Troubleshooting
5. PCB Diagram
6. Wiring Diagram
7. Reference Sheet

Contents

1. Precautions	1-1
1-1 Precautions for the Service	1-1
1-2 Precautions related to static electricity and PL	1-1
1-3 Precautions related to product safety	1-2
1-4 Other precautions	1-2
2. Product Specifications	2-1
2-1 The Feature of Product	2-1
2-2 Product Specifications	2-2
2-3 Accessories	2-5
3. Disassembly and Reassembly	3-1
3-1 Indoor Unit	3-2
3-2 Outdoor Unit	3-8
4. Troubleshooting	4-1
4-1 Setting an indoor unit address and installation option	4-1
4-1-1 Common steps for setting the addresses and options	4-1
4-1-2 Setting the indoor unit addresses	4-6
4-1-3 Setting the installation options in a batch	4-7
4-1-4 Changing the addresses and options individually	4-9
4-2 Items to check before diagnostics	4-10
4-2-1 Four directions cassette type	4-10
4-2-2 Test run mode and View mode	4-12
4-2-3 Troubleshooting for outdoor unit	4-13
4-2-4 Wired remote controller	4-15
4-3 Troubleshooting by symptoms	4-17
4-3-1 Indoor temperature sensor (open/short)	4-17
4-3-2 Indoor heat exchanger temperature sensor (open/short)	4-18
4-3-3 Indoor FAN error	4-19
4-3-4 Communication error after finishing Tracking	4-20
4-3-5 Indoor unit float sensor error	4-21
4-3-6 EEPROM circuit failure	4-22
4-3-7 Outdoor unit is not powered on	4-23
4-4 Troubleshooting by symptoms	4-25

4-4-1	Communication error	4-25
4-4-2	Outdoor temperature sensor error	4-26
4-4-3	Outdoor Coil temperature sensor error	4-28
4-4-4	Outdoor Discharge temperature sensor error	4-30
4-4-5	Outdoor Discharge over temperature error	4-32
4-4-6	Outdoor Fan motor error	4-33
4-4-7	Compressor starting error	4-34
4-4-8	Compressor wire missing error/rotation error	4-35
4-4-9	O.C(Over Current) error	4-36
4-4-10	DC_link voltage sensor error	4-37
4-4-11	DC_link voltage under/over error, Over voltage protection error/PFC over load	4-38
4-4-12	DC_link voltage sensor error	4-39
4-4-13	Current sensor error/Input current sensor error	4-40
4-4-14	Heatsink sensor error/Heatsink over heat	4-41
4-4-15	Comp Vlimit error/Comp current limit error	4-42
4-4-16	EEPROM error/OTP error	4-43
4-4-17	AC zero cross signal error	4-44
4-4-18	Operation condition secession error.....	4-45
4-4-19	Capacity miss match error	4-46
4-4-20	Gas leak error	4-47
4-4-21	MDS Error Flow chart	4-48
5.	PCB Diagram	5-1
5-1	Indoor Unit	5-1
5-2	Outdoor unit	5-3
6.	Wiring Diagram	6-1
6-1	Indoor Unit	6-1
6-2	Outdoor Unit	6-2
7.	Reference Sheet	7-1
7-1	Index for Model Name	7-1
7-2	Refrigerating Cycle Diagram.....	7-3
7-3	Pressure Graph.....	7-4

1. Precautions

1-1 Precautions for the Service

- **Use the standard parts when replacing the electric parts.**
 - Confirm the model name, rated voltage, rated current of the electric parts.

- **When repairing the equipment, connection of the harness parts must be firm and solid.**
 - A loose connection may cause noise or other malfunction.

- **When assembling and disassembling the equipment while it is laid down, lay it on soft cloth.**
 - Otherwise it may scratch the back of the exterior of the product.

- **Remove dust or dirt completely from the housing block, wiring block and service parts during repair.**
 - This helps prevent the danger of fire caused by tracking or short circuit.

- **Fasten the valve caps of service valves and charging valves of outdoor unit as much as possible using adjustable wrenches.**

- **Check the status of the components' assembly after repair service.**
 - The status must be the same as before the repair service.

1-2 Precautions related to static electricity and PL

- **The PCB power supply block is susceptible to static electricity. Therefore, care must be taken during repair or measuring while the power is on.**
 - Wear insulation gloves for PCB repair or measuring.

- **Check whether the installation location is at least two meters away from other electronic products such as TV, video, or audio.**
 - Otherwise, the video quality might be degraded or noise might be generated.

- **Do not let end users repair the products themselves.**
 - Unauthorized disassembly might cause electric shock or fire.

1-3 Precautions related to product safety

- **Do not pull the power cord and do not touch the power plug or aux power switch with wet hands.**
 - It might cause electric shock or fire.
- **A damaged power line or power plug must be replaced to prevent danger.**
- **Do not bend the power cable with excessive force, and do not place a heavy weight on the case as it might damage the cable.**
 - It might cause electric shock or fire.
- **Do not use multiple electric outlets.**
 - This might cause electric shock or fire.
- **Connect the ground terminal when necessary.**
 - You must connect the ground terminal if you determine that there is a danger of electric leakage due to moisture or water.
- **Unplug the power cable or turn off the auxiliary power switch for electric part replacement and repair service.**
 - Otherwise it might cause electric shock.
- **Instruct end users to separate the batteries from the remote controllers and store them separately when the product is not used for long time.**
 - Otherwise leakage from the dry cell may cause problems with the remote controller.

1-4 Other precautions

- **The pipes should have no leaks during installation, and the compressor must be stopped before removing connecting pipes for pump down work. Operating the compressor while the service valve is open and coolant pipe is not properly connected may cause explosion or injury due to abnormal high pressure created inside the coolant cycle as the air can be absorbed through the pipe.**
- **Pump Down work procedure (When uninstalling the product)**
 - Turn on the air conditioner, select cooling operation, and run the compressor for more than three minutes.
 - Release the high pressure and low pressure valve caps.
 - Close the high pressure valve completely using an L-wrench
 - After about two minutes, close the low pressure valve completely.
 - Stop running the air conditioner.
 - Separate the connecting pipe.

2. Product Specifications

2-1 The Feature of Product

■ **Built-in Cassette Type**

After installed, the air conditioner can be harmonized with a room interior.

■ **High Performance & Energy Saving**

With the advanced BLDC inverter technology, it makes a room cool with highly energy saving and arises the efficiency of air conditioner.



■ **Long Ambient Operation(In Low Temperature)**



It can arise the reliability and the capacity of the air conditioner, especially operated in low temperature.

■ **Eco-friendly Product(Lead-Free, RoHS, WEEE)**



■ **Easy installation of ultra-lightweight indoor unit**

2-2 Product Specifications (cont.)

ITEM		Development Model	
		AC026MNNDKH AC026MXADKH	AC035MNNDKH AC035MXADKH
IMAGE	INDOOR UNIT		
	OUTDOOR UNIT		
	REMOTE CONTROLLER		
Performance	Cooling [W]	2,600	3,500
	Heating [W]	3,400	4,000
Power Consumption	Cooling [W]	680	1,090
	Heating [W]	900	1,200
Voltage / Frequency		1Φ, 220~240V, 50Hz	1Φ, 220~240V, 50Hz
Operating Current	Cooling [A]	3.8	5.6
	Heating [A]	4.8	5.8
Noise	Indoor Unit [dBA] (C/H)	38/39	41/42
	Outdoor Unit [dBA] (C/H)	51/51	53/53
Size	Net Dimension (WxDxH)	Indoor Unit [mm]	575*575*250
		Outdoor Unit [mm]	790*285*548
	Shipping Dimension (WxDxH)	Indoor Unit [mm]	623*653*298
		Outdoor Unit [mm]	926*384*640
Weight	Net Weight	Indoor Unit [kg]	11.5
		Outdoor Unit [kg]	36.2
	Shipping Weight	Indoor Unit [kg]	13.4
		Outdoor Unit [kg]	38.8
Harness Specifications	Indoor Fan Motor		DB31-00578C
	Compressor		UG9AJ3090FER
	Outdoor Fan Motor		DB31-00642B
Piping	High Pressure		4.1
	Low Pressure		1.4
PANEL		PC4NUSKFN	PC4NUSKFN
Refrigerant Type		R-410A	R-410A
Factory Charging [g]		1,050	1,050
Additional Refrigerant (for every 1m) [g]		Chargeless	Chargeless
Basic Piping Length [m]		5	5
Max. Piping Length [m]		20	20
Max. Level Difference [m]		15	15
Option Code		01507F-1910C8-271A22-370000 020000-100000-200000-300000 030000-100000-200000-300000	01507F-1910F9-272328-370000 020000-100000-200000-300000 030000-100000-200000-300000

ITEM		Development Model		
		AC052MNNDKH AC052MXADKH	AC060MNNDKH AC060MXADKH	
IMAGE	INDOOR UNIT			
	OUTDOOR UNIT			
	REMOTE CONTROLLER			
Performance	Cooling [W]	5,000	5,800	
	Heating [W]	5,500	7,000	
Power Consumption	Cooling [W]	1,530	2,150	
	Heating [W]	1,520	2,320	
Voltage / Frequency		1Φ, 220~240V, 50Hz	1Φ, 220~240V, 50Hz	
Operating Current	Cooling [A]	6.9	9.3	
	Heating [A]	6.9	10	
Noise	Indoor Unit [dBA] (C/H)	43/44	45/46	
	Outdoor Unit [dBA] (C/H)	58/58	58/58	
Size	Net Dimension (WxHxD)	Indoor Unit [mm]	575*575*250	575*575*250
		Outdoor Unit [mm]	880*310*638	880*310*638
	Shipping Dimension (WxHxD)	Indoor Unit [mm]	623*653*298	623*653*298
		Outdoor Unit [mm]	1024*413*730	1024*413*730
Weight	Net Weight	Indoor Unit [kg]	11.7	11.7
		Outdoor Unit [kg]	44.5	44.5
	Shipping Weight	Indoor Unit [kg]	14	14
		Outdoor Unit [kg]	48	48
Harness Specifications	Indoor Fan Motor	DB31-00578C	DB31-00578C	
	Compressor	UG9TK3150FE4	UG9TK3150FE4	
	Outdoor Fan Motor	DB31-00658D	DB31-00658D	
Piping	High Pressure	4.1	4.1	
	Low Pressure	1.4	1.4	
PANEL		PC4NUSKFN	PC4NUSKFN	
Refrigerant Type		R-410A	R-410A	
Factory Charging [g]		1,300	1,300	
Additional Refrigerant (for every 1m) [g]		10	10	
Basic Piping Length [m]		5	5	
Max. Piping Length [m]		30	30	
Max. Level Difference [m]		20	20	
Option Code		015077-19345D-27343C-370040 020000-100000-200000-300000 030000-100000-200000-300000	015077-19446E-273C46-370040 020000-100000-200000-300000 030000-100000-200000-300000	

2-2 Product Specifications (cont.)



ITEM		Development Model	
		AC071MNNDKH AC071MXADKH	
IMAGE	INDOOR UNIT		
	OUTDOOR UNIT		
	REMOTE CONTROLLER		
Performance	Cooling [Btu/h]	6,800	
	Heating [Btu/h]	7,500	
Power Consumption	Cooling [W]	2,720	
	Heating [W]	2,800	
Voltage / Frequency		1Φ, 220~240V, 50Hz	
Operating Current	Cooling [A]	11.8	
	Heating [A]	12.3	
Noise	Indoor Unit [dBA] (C/H)	46/46	
	Outdoor Unit [dBA] (C/H)	60/60	
Size	Net Dimension (WxHxD)	Indoor Unit [mm]	575*575*250
		Outdoor Unit [mm]	880*310*798
	Shipping Dimension (WxHxD)	Indoor Unit [mm]	623*653*298
		Outdoor Unit [mm]	1023*413*911
Weight	Net Weight	Indoor Unit [kg]	11.7
		Outdoor Unit [kg]	55
	Shipping Weight	Indoor Unit [kg]	14
		Outdoor Unit [kg]	59
Harness Specifications	Indoor Fan Motor	DB31-00578C	
	Compressor	UG4T200FUAЕ4	
	Outdoor Fan Motor	DB31-00658D	
Piping	High Pressure	4.1	
	Low Pressure	1.4	
PANEL		PC4NUSKFN	
Refrigerant Type		R-410A	
Factory Charging [g]		1,500	
Additional Refrigerant (for every 1m) [g]		20	
Basic Piping Length [m]		5	
Max. Piping Length [m]		50	
Max. Level Difference [m]		30	
Option Code		015077-194581-274750-370040 020000-100000-200000-300000 030000-100000-200000-300000	

2-3 Accessories

Item	Description	Code No.	Q'ty	Remark
	Ass'y drain hose	DB94-03287A	1	Essential Offer (Indoor Unit)
	Cable-tie	DB65-10088C	6	
	Seal-drain ass'y	DB62-11028A	1	
	Seal-drain ass'y	DB62-11028H	1	
	Seal-drain ass'y	DB62-11028J	1	
	USER MANUAL INSTALLATION MANUAL	DB68-06489A DB68-06490A	1	
	CARD WARRNATY	DB68-02596B	1	
	INSTALLATION MANUAL	DB68-05688A	1	Essential Offer (Outdoor Unit)
	Drain Plug	DB67-00477A	1	
	Rubber Leg	DB73-20134A	4	
	BOLT	6011-003975	4	Essential Offer (Panel)
	INSTALLATION MANUAL	DB68-03837A	1	





3. Disassembly and Reassembly

■ Necessary Tools

Item	Remarks
+SCREW DRIVER	
Adjustable Wrench (8mm, 10mm, 13mm)	
M6, M8 Hex Wrench	

3-1 Indoor unit

■ AC026MNNDKH / AC035MNNDKH / AC052MNNDKH / AC060MNNDKH / AC071MNNDKH

No	Parts	Procedure	Remark
1	Panel	<p>1) Pull both hooks and take the grille downward. Two safety clips are mounted to the front grille to prevent it from dropping.</p> <p>2) Detach the safety clip and take up the grille.</p> <p>3) Remove the 2 fixed screws to remove the Control-Box Cover. (Use +Screw Driver)</p> <p>4) Remove the Remocon-Receiver and Blade Connector Wire from the PBA. (3EA)</p> <p>5) Push the 4 panel corners and cover downwards to remove it.</p>	    

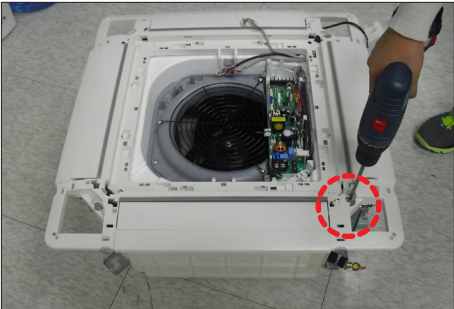
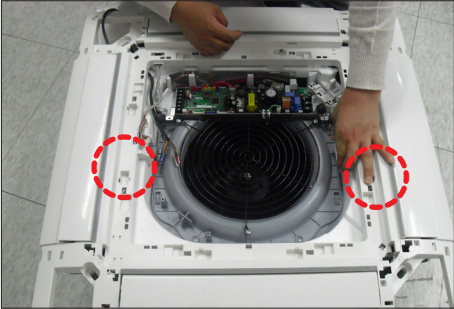
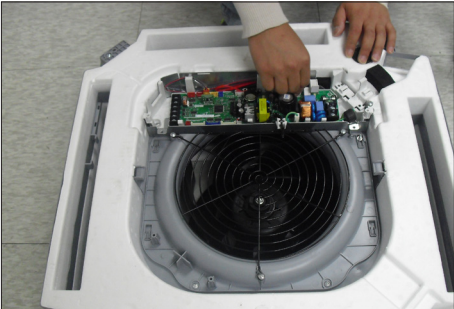
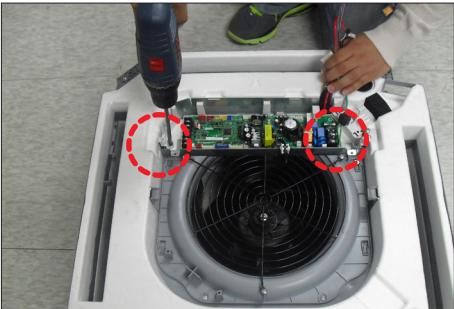
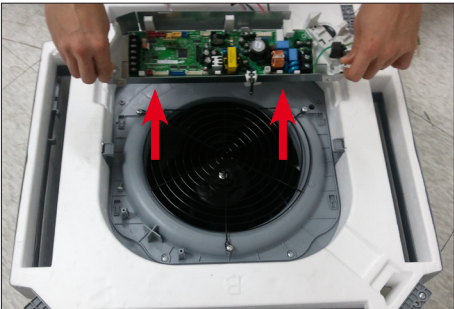
No	Parts	Procedure	Remark
		<p>6) Disassemble the bolts that are assembled with the indoor unit at the 4 panel corners.</p> <p>7) Press the Hangers at both sides of the panel inwards, to remove it from the indoor unit's hook. Remove the panel from the indoor unit.</p>	 
2	Control-Box	<p>1) Disconnect the Connector Wire that is connected to the indoor unit's PBA</p> <p>2) Unscrew the 2 fixed screws on both sides of the Control Box, and disassemble the Control Box from the indoor unit.(Use +Screw Driver)</p>	  

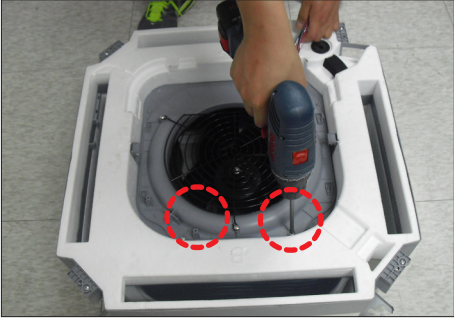
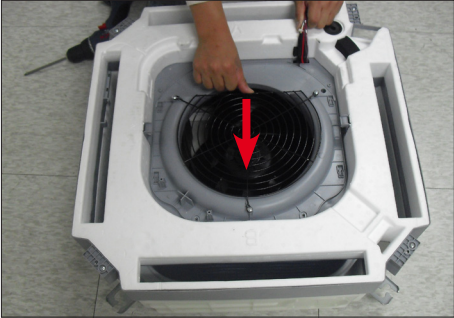
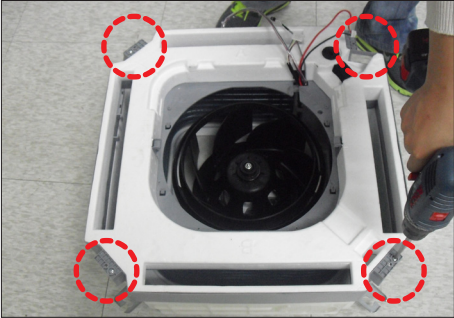
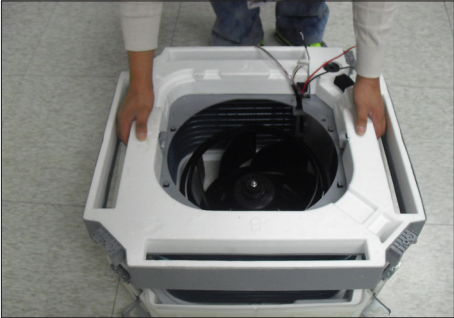
No	Parts	Procedure	Remark
3	Bell-Mouth	<p>1) Unscrew the screw fixed on the Bell-Mouth. (Use +Screw Driver)</p> <p>2) Push the Bell-Mouth in the direction opposite to where it's installed on the Control-Box to remove it.</p>	 
4	Drain Pan	<p>1) Unscrew the screws on the 4 corners of the indoor unit. (Use +Screw Driver)</p> <p>2) Remove the Drain Pan from the indoor unit.</p>	 

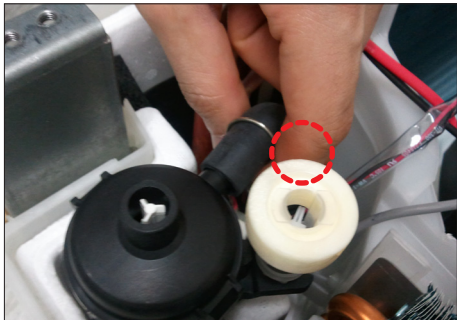
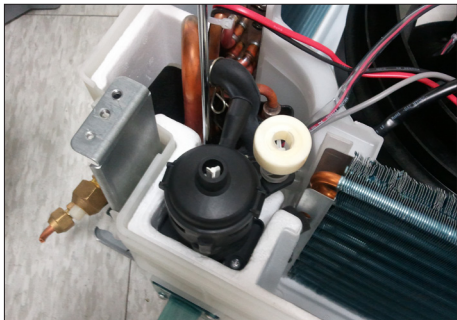
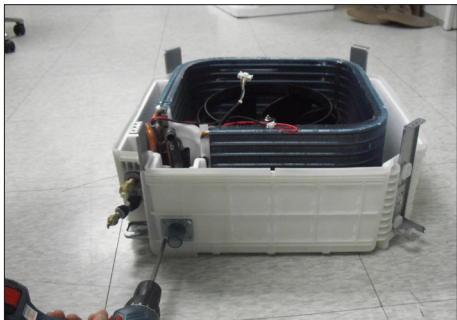
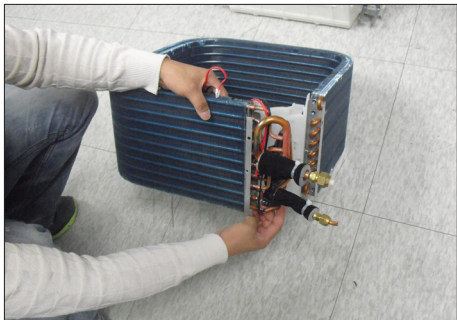

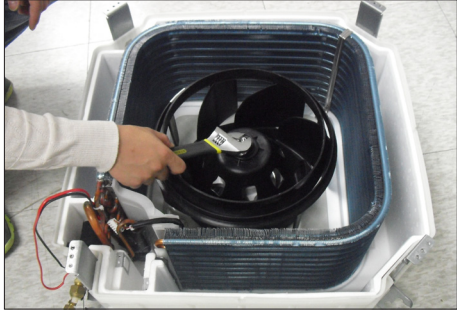
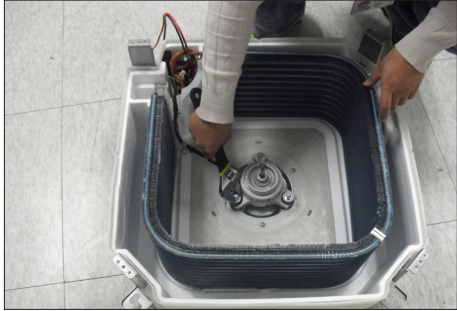
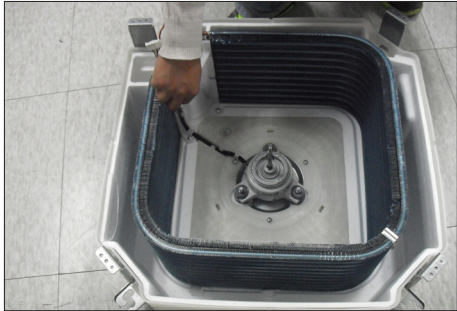
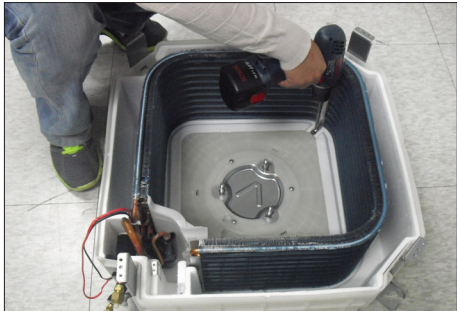
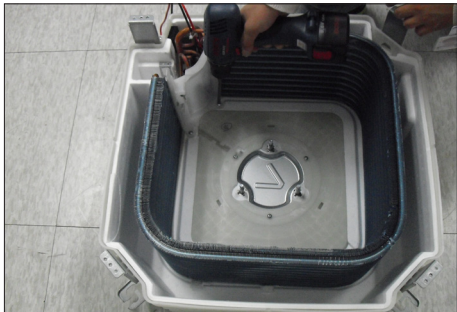

No	Parts	Procedure	Remark
5	Drain Pump & Hose	<p>1) Remove the 2 fixed screws and disconnect the white drainage hose from the Drain Pump. (Use +Screw Driver)</p> <p>2) Remove the 2 screws and take the Drain-Hose out from the indoor unit to disassemble the transparent Drain-Hose fixed on the side of the indoor unit. (Use +Screw Driver)</p>	  
6	Evap. Temperature Sensor	<p>1) Use your hand to remove the temperature sensor attached to the Evap Pipe along with the fixing clip.</p>	



No	Parts	Procedure	Remark
7	Fan & Motor	<p>1) Turn the hexagonal nut attached to the top of the Fan counterclockwise to remove it. Take the Fan out of the Motor.</p> <p>2) Turn the three hexagonal nuts on the Motor counterclockwise to remove the nuts. Take the Motor Wires attached to these three locations out with your hands prior to removing the Motor.</p>	  
8	Evaporator	<p>1) Remove the screws of the Steel Holder Evaps that are used to fix the Heat Exchanger, and then remove it. (Use +Screw Driver)</p> <p>2) Remove the 2 fixing screws of the Partition Evap at the Heat Exchanger's In/Out Pipe. (Use +Screw Driver)</p>	 

No	Parts	Procedure	Remark
		<p>3) Remove the screw of the Cover Pipe that is used to fix the In/Out Pipe. Remove the In/Out Pipe. (Use +Screw Driver)</p> <p>4) Remove the Heat Exchanger from the indoor unit's cabinet.</p>	  

3-2 Outdoor unit

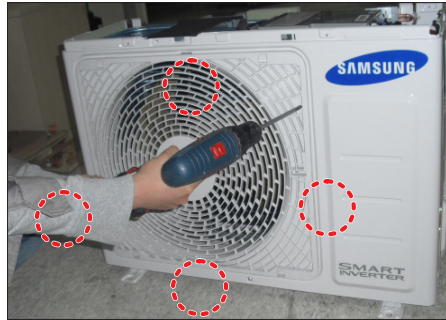

■ AC026MXADKH / AC035MXADKH

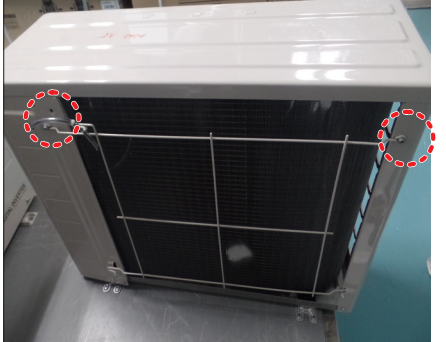
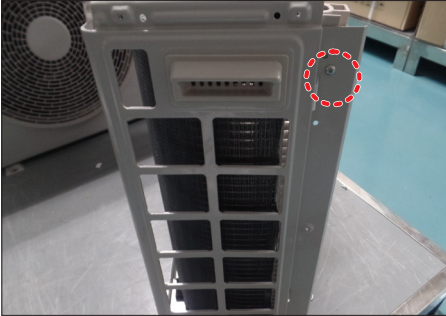
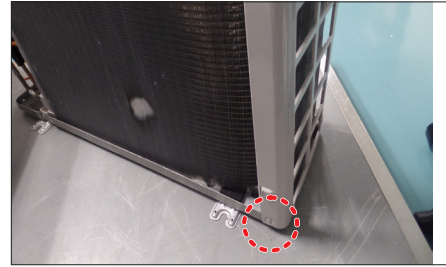
No	Parts	Procedure	Remark
1	common work	<p> You must turn off the Power before disassembly.</p> <p>1) loosen 1 pcs screw of cover control, and detach it.</p> <p>2) loosen 5 pcs screws on both right and left cabinet side edges and to detach the cover-top</p> <p>3) Loosen 7 screws fixed to disassemble cabinet-front, and detach it.</p>	   

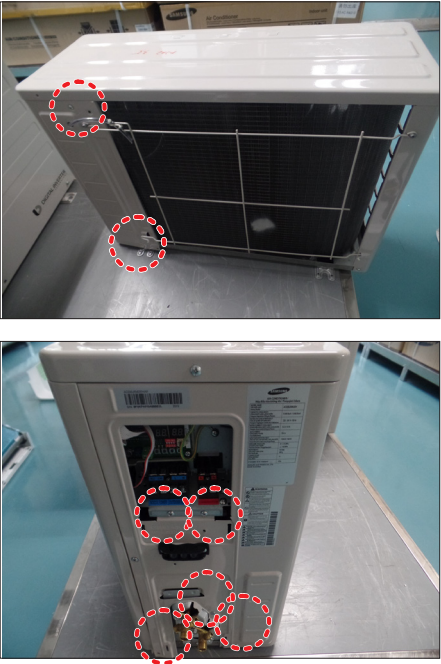
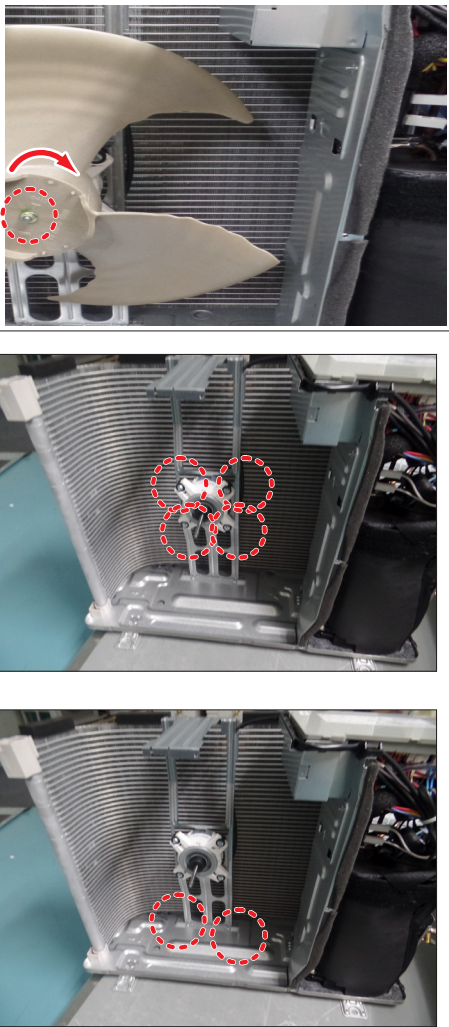
No	Parts	Procedure	Remark
	common work	<p data-bbox="485 1088 898 1115">4) loosen 2 screws to disassemble steel-bar.</p> <p data-bbox="485 1413 887 1464">5) Loosen 2 screws to disassemble the cabi left and detach it.</p>	    

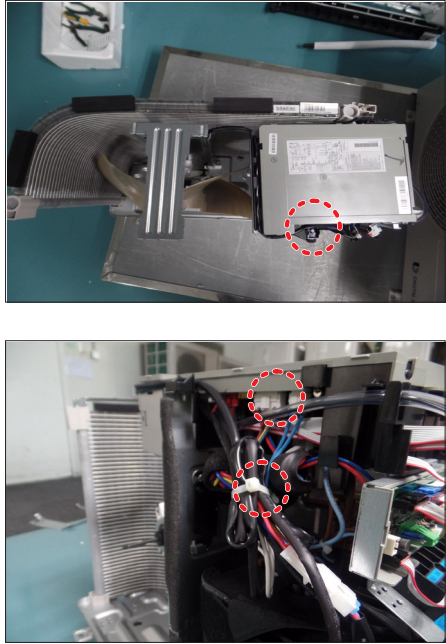
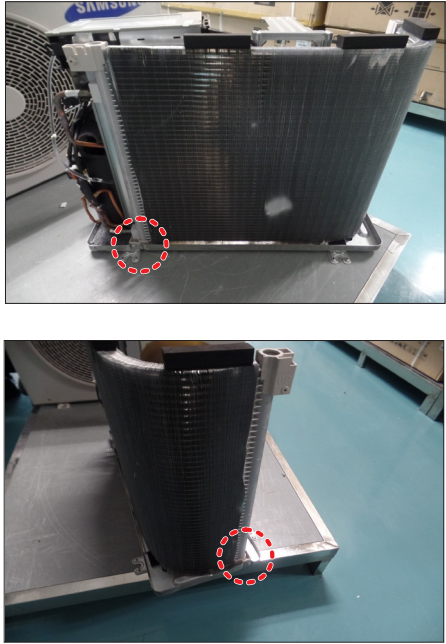
No	Parts	Procedure	Remark
	common work	6) Loosen 7 screws to disassemble the cabi right and detach it.	
2	fan&motor	<p>1) loosen 1 screw as indication and detached the fan.</p> <p>2) loosen 4 pcs motor screws and disconnect the wire between assy control out and motor.</p> <p>3) loosen 2 pcs bracket-motor screw and detach it.</p>	

No	Parts	Procedure	Remark
3	assy control out	<ol style="list-style-type: none"> 1) loosen fixing 1 screw from cover -control 2) detach several connections from assy control out, take out assy control out. 	
4	Heat exchanger	<ol style="list-style-type: none"> 1) Release the refrigerant at first 2) Loosen fixing screw on both side. 3) disassembly the pipes in both inlet and outlet with welding torch. 4) detach the heat exchanger. 	



No	Parts	Procedure	Remark
5	compressor	<p>1) disconnect the compressor lead wire .</p> <p>2)disassembly the felt comp sound. loosen the 3 bolts at the bottom .</p> <p>CAUTION When removing the compressor, Heat Exchanger, and Pipe, purge the Coolant inside the Compressor completely and remove the pipe with a welding flame.</p>	 

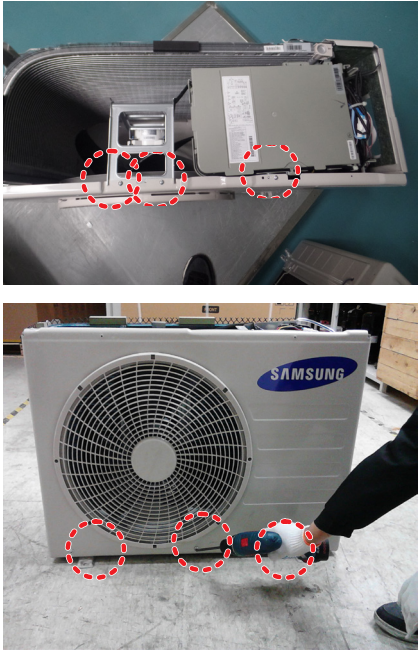
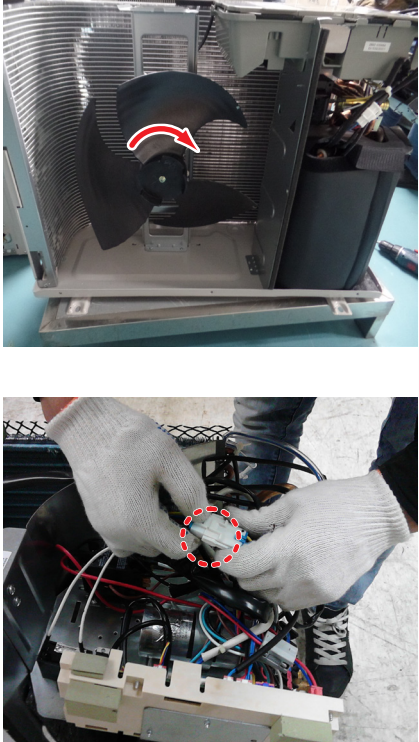

■ AC052MXADKH / AC060MXADKH

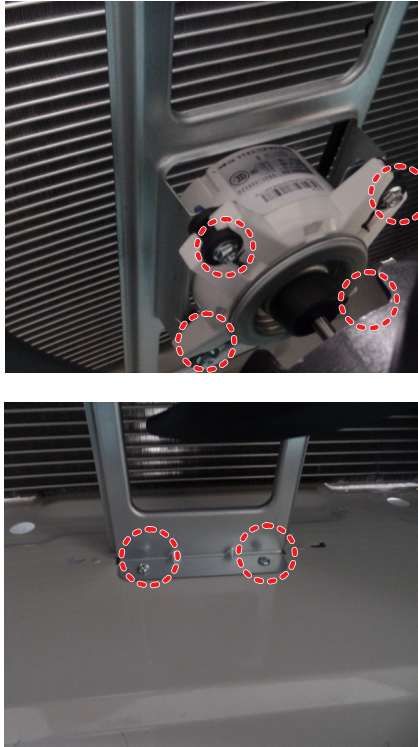
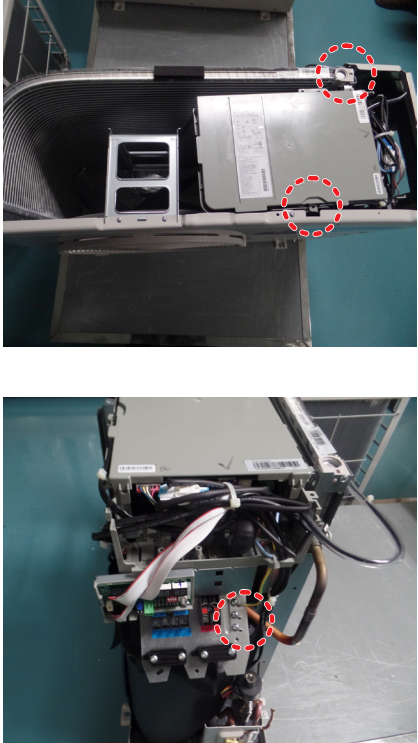
No	Parts	Procedure	Remark
1	common work	<p> You must turn off the Power before disassembly.</p> <p>1) Loosen 1 pcs screw of cover control</p> <p>2) Loosen 8 pcs screw of the cabi top cover.</p> <p>3) Loosen 4 pcs screw of the bar steel.</p> <p>4) Loosen 10 pcs screw of the cabi side front.</p>	   

No	Parts	Procedure	Remark
1	common work		
2	Fan& motor	<p>1) Loosen the fan screw according the indication and detach the fan propeller</p> <p>2) Disconnect the wire between assy control out and motor.</p>	

No	Parts	Procedure	Remark
2		<p data-bbox="485 320 783 349">3) Loosen 4 pcs motor screw.</p> <p data-bbox="485 696 890 725">4) Loosen 2 pcs screw of bracket motor.</p>	 <p>The top photograph shows a motor assembly with four screws circled in red. The bottom photograph shows a metal bracket with two screws circled in red.</p>
3	Assy control out	<p data-bbox="485 1084 903 1144">1) Loosen the screws that connected partition and case control then get the control out.</p> <p data-bbox="485 1503 871 1532">2) Loosen the screw of the cover terminal</p>	 <p>The top photograph shows a control board being removed from a partition, with two screws circled in red. The bottom photograph shows a terminal cover being loosened, with one screw circled in red.</p>

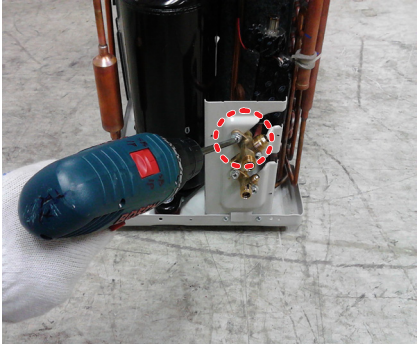
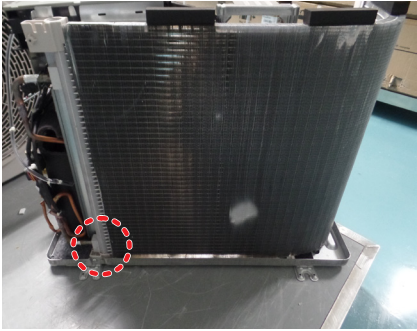
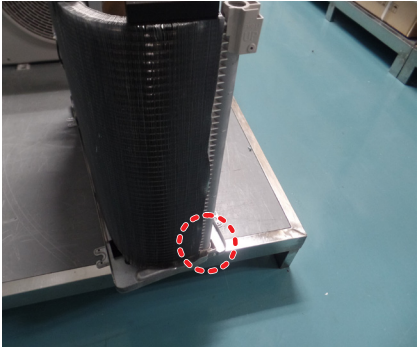

No	Parts	Procedure	Remark
3		<p data-bbox="483 322 903 383">3) Loosen 2 screws , disassemble the Coil Harmonic.</p> <p data-bbox="483 730 911 763">4) Loosen the screw of the cover terminal.</p>	 

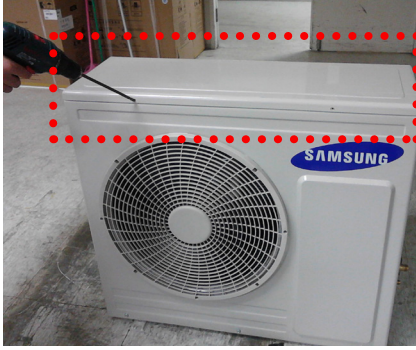
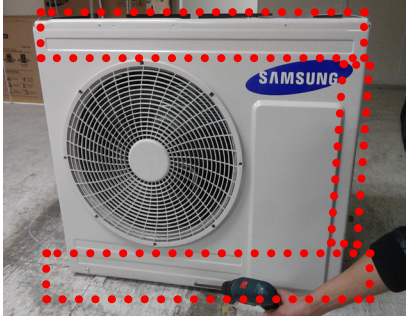
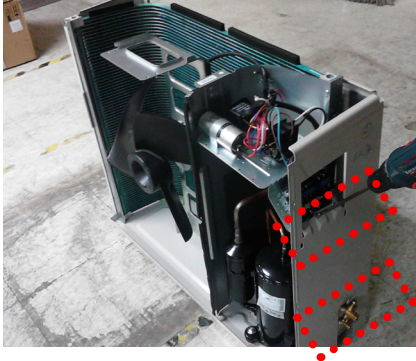

No	Parts	Procedure	Remark
4	Heat exchanger	<p>1) Release the refrigerant at first 2) Loosen fixing screw on both side.. 3) Disassemble the pipes in both inlet and outlet with welding torch. 4) Detach the heat exchanger.</p> <p> When removing the compressor, Heat Exchanger, and Pipe, purge the Coolant inside the Compressor completely and remove the pipe with a welding flame.</p>	  
5	Compressor	<p>1)Loosen the 3 bolts at the bottom of compressor.</p>	

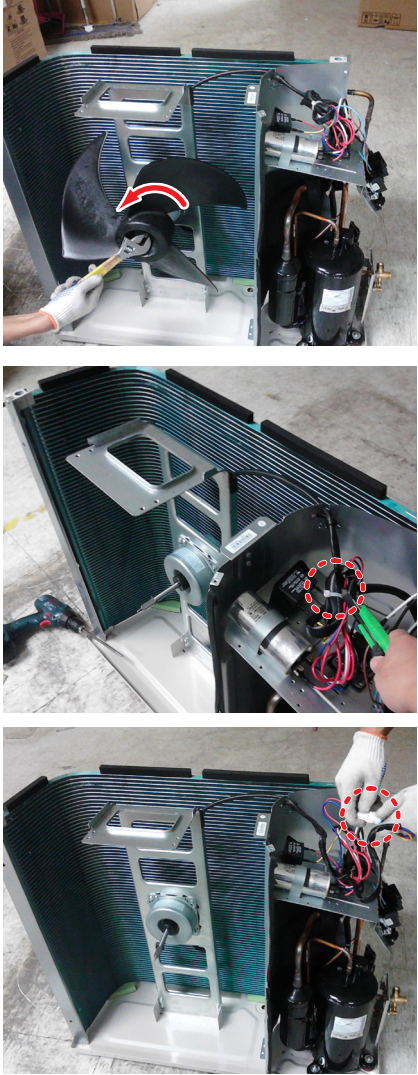
■ AC071MXADKH

No	Parts	Procedure	Remark
1	common work	<p>1) loosen 1 pcs screw of cover control</p> <p>2) loosen 8 pcs screw of the cabi top cover.</p> <p>3) loosen 12 pcs screw of the cabi front</p> <p>4) loosen 7 pcs screw of the cabi side right.</p>	   

No	Parts	Procedure	Remark
		<p>5)loosen 3pcs screw of the cabi side left.</p>	
2	Fan & Motor	<p>1) loosen the fan screw according the indication and detach the fab propeller</p> <p>2)Cut the cable-tie</p> <p>3)disconnect the wire between assy control out and motor.</p>	

No	Parts	Procedure	Remark
		<p>4) loosen 4 pcs motor screw.</p> <p>5) loosen 4 pcs screw of bracket motor</p>	
3	assy control out	<p>1) loosen the screw of the cover terminal</p> <p>2) loosen the screws that connected partition and case control then pull up the control out.</p>	

No	Parts	Procedure	Remark
4	Heat exchanger	1) Release the refrigerant at first 2) Looosen fixing screw on both side. 3) disassembly the pipes in both inlet and outlet with welding torch. 4) detach the heat exchanger.	
5	Compressor	1)loosen the 3 bolts at the bottom of compressor.	

4. Troubleshooting

You cannot set both of the indoor unit addresses and the installation options in a batch: set both of them respectively.

4-1-1 Common steps for setting the addresses and options

MR-EC00 and MR-EH00 remote controls

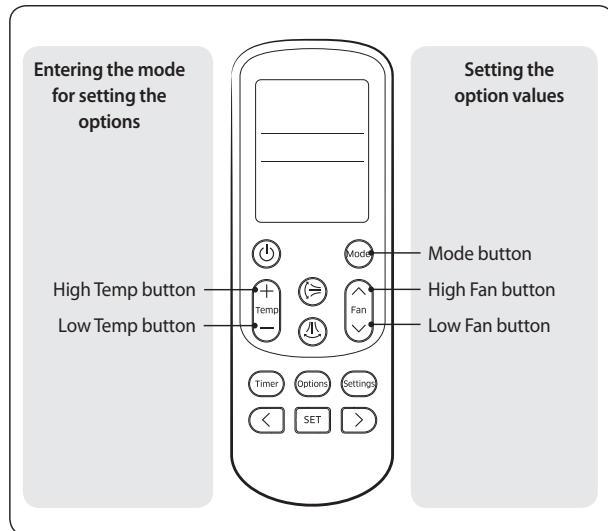

NOTE

- The remote control display and buttons may vary depending on the model.
- Enter the mode for setting the options:
 - Remove the batteries from the remote control, and then insert them again.
 - While holding down the (High Temp) and (Low Temp) buttons simultaneously, insert the batteries into the remote control.
 - Make sure that you are entered to the mode for setting the options:

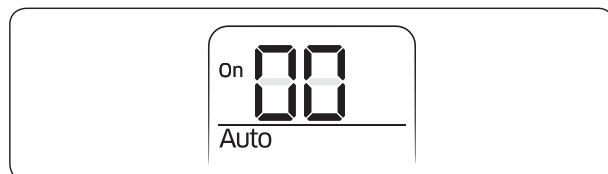

- Set the option values.















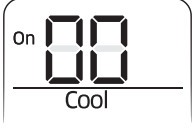

CAUTION



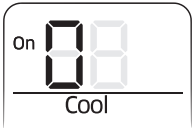
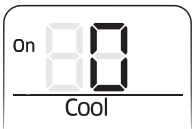

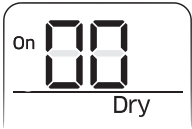



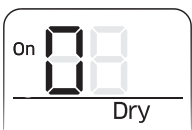
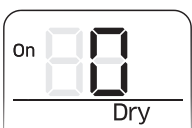





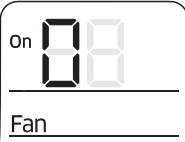
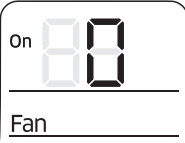

- The total number of available options are 24: SEG1 to SEG24.
- Because SEG1, SEG7, SEG13, and SEG19 are the page options used by the previous remote control models, the modes to set values for these options are skipped automatically.
- Set a 2-digit value for each option pair in the following order: SEG2 and SEG3 → SEG4 and SEG5 → SEG6 and SEG8 → SEG9 and SEG10 → SEG11 and SEG12 → SEG14 and SEG15 → SEG16 and SEG17 → SEG18 and SEG20 → SEG21 and SEG22 → SEG23 and SEG24

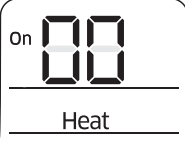



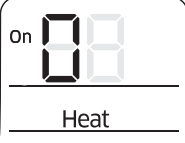
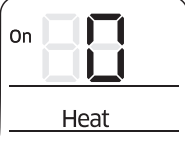

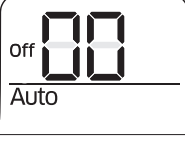

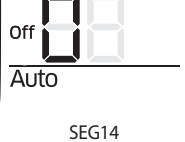





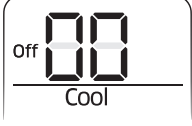

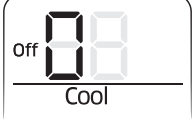
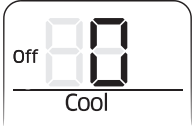

SEG1	SEG2	SEG3	SEG4	SEG5	SEG6
0	X	X	X	X	X
SEG7	SEG8	SEG9	SEG10	SEG11	SEG12
1	X	X	X	X	X
SEG13	SEG14	SEG15	SEG16	SEG17	SEG18
2	X	X	X	X	X
SEG19	SEG20	SEG21	SEG22	SEG23	SEG24
3	X	X	X	X	X





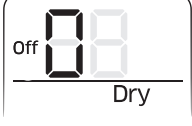





On (SEG1 to SEG12)	Off (SEG13 to SEG24)

Take the steps presented in the following table:

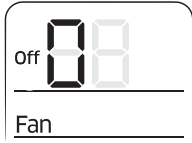
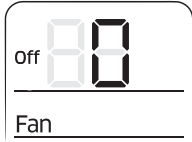
Steps	Remote control display
<p>1 Set the SEG2 and SEG3 values:</p> <p>a Set the SEG2 value by pressing the  (Low Fan) button repeatedly until the value you want to set appears on the remote control display.</p> <p>b Set the SEG3 value by pressing the  (High Fan) button repeatedly until the value you want to set appears on the remote control display.</p> <p>When you press the  (Low Fan) or  (High Fan) button, values appear in the following order: 0 → 1 → ... E → F</p>	 <p style="text-align: center;">SEG2</p>  <p style="text-align: center;">SEG3</p>
<p>2 Press the  (Mode) button. Cool and On appear on the remote control display.</p>	
<p>3 Set the SEG4 and SEG5 values:</p> <p>a Set the SEG4 value by pressing the  (Low Fan) button repeatedly until the value you want to set appears on the remote control display.</p> <p>b Set the SEG5 value by pressing the  (High Fan) button repeatedly until the value you want to set appears on the remote control display.</p> <p>When you press the  (Low Fan) or  (High Fan) button, values appear in the following order: 0 → 1 → ... E → F</p>	 <p style="text-align: center;">SEG4</p>  <p style="text-align: center;">SEG5</p>
<p>4 Press the  (Mode) button. Dry and On appear on the remote control display.</p>	
<p>5 Set the SEG6 and SEG8 values:</p> <p>a Set the SEG6 value by pressing the  (Low Fan) button repeatedly until the value you want to set appears on the remote control display.</p> <p>b Set the SEG8 value by pressing the  (High Fan) button repeatedly until the value you want to set appears on the remote control display.</p> <p>When you press the  (Low Fan) or  (High Fan) button, values appear in the following order: 0 → 1 → ... E → F</p>	 <p style="text-align: center;">SEG6</p>  <p style="text-align: center;">SEG8</p>

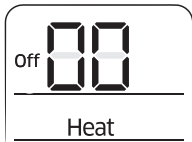
Steps	Remote control display
6 Press the  (Mode) button. Fan and On appear on the remote control display.	
7 Set the SEG9 and SEG10 values: a Set the SEG9 value by pressing the  (Low Fan) button repeatedly until the value you want to set appears on the remote control display. b Set the SEG10 value by pressing the  (High Fan) button repeatedly until the value you want to set appears on the remote control display. When you press the  (Low Fan) or  (High Fan) button, values appear in the following order: 0 → 1 → ... E → F	 <p style="text-align: center;">SEG9</p>  <p style="text-align: center;">SEG10</p>
8 Press the  (Mode) button. Heat and On appear on the remote control display.	
9 Set the SEG11 and SEG12 values: a Set the SEG11 value by pressing the  (Low Fan) button repeatedly until the value you want to set appears on the remote control display. b Set the SEG12 value by pressing the  (High Fan) button repeatedly until the value you want to set appears on the remote control display. When you press the  (Low Fan) or  (High Fan) button, values appear in the following order: 0 → 1 → ... E → F	 <p style="text-align: center;">SEG11</p>  <p style="text-align: center;">SEG12</p>
10 Press the  (Mode) button. Auto and Off appear on the remote control display.	
11 Set the SEG14 and SEG15 values: a Set the SEG14 value by pressing the  (Low Fan) button repeatedly until the value you want to set appears on the remote control display.	 <p style="text-align: center;">SEG14</p>

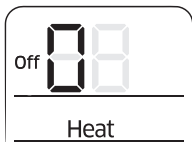
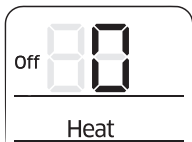

Steps	Remote control display
<p>b Set the SEG15 value by pressing the  (High Fan) button repeatedly until the value you want to set appears on the remote control display.</p> <p>When you press the  (Low Fan) or  (High Fan) button, values appear in the following order: 0 → 1 → ... E → F</p>	 <p style="text-align: center;">SEG15</p>
<p>1 Press the  (Mode) button. Cool and Off appear on the remote control display.</p>	
<p>2 Set the SEG16 and SEG17 values:</p> <p>a Set the SEG16 value by pressing the  (Low Fan) button repeatedly until the value you want to set appears on the remote control display.</p> <p>b Set the SEG17 value by pressing the  (High Fan) button repeatedly until the value you want to set appears on the remote control display.</p> <p>When you press the  (Low Fan) or  (High Fan) button, values appear in the following order: 0 → 1 → ... E → F</p>	 <p style="text-align: center;">SEG16</p>  <p style="text-align: center;">SEG17</p>
<p>3 Press the  (Mode) button. Dry and Off appear on the remote control display.</p>	
<p>4 Set the SEG18 and SEG20 values:</p> <p>a Set the SEG18 value by pressing the  (Low Fan) button repeatedly until the value you want to set appears on the remote control display.</p> <p>b Set the SEG20 value by pressing the  (High Fan) button repeatedly until the value you want to set appears on the remote control display.</p> <p>When you press the  (Low Fan) or  (High Fan) button, values appear in the following order: 0 → 1 → ... E → F</p>	 <p style="text-align: center;">SEG18</p>  <p style="text-align: center;">SEG20</p>
<p>5 Press the  (Mode) button. Fan and Off appear on the remote control display.</p>	

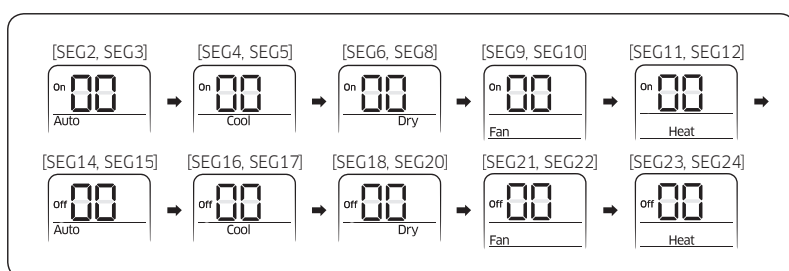

Steps	Remote control display
<p>6 Set the SEG21 and SEG22 values:</p> <p>a Set the SEG21 value by pressing the  (Low Fan) button repeatedly until the value you want to set appears on the remote control display.</p> <p>b Set the SEG22 value by pressing the  (High Fan) button repeatedly until the value you want to set appears on the remote control display.</p> <p>When you press the  (Low Fan) or  (High Fan) button, values appear in the following order: 0 → 1 → ... E → F</p>	 <p style="text-align: center;">SEG21</p>  <p style="text-align: center;">SEG22</p>
<p>7 Press the  (Mode) button. Heat and Off appear on the remote control display.</p>	 <p style="text-align: center;">SEG23</p>
<p>8 Set the SEG23 and SEG24 values:</p> <p>a Set the SEG23 value by pressing the  (Low Fan) button repeatedly until the value you want to set appears on the remote control display.</p> <p>b Set the SEG24 value by pressing the  (High Fan) button repeatedly until the value you want to set appears on the remote control display.</p> <p>When you press the  (Low Fan) or  (High Fan) button, values appear in the following order: 0 → 1 → ... E → F</p>	 <p style="text-align: center;">SEG23</p>  <p style="text-align: center;">SEG24</p>

3 Check whether the option values that you have set are correct by pressing the  (Mode) button repeatedly



4 Save the option values into the indoor unit:

Point the remote control to the remote control sensor on the indoor unit and then press the  (Power) button on the remote control twice. Make sure that this command is received by the indoor unit. When it is successfully received, you can hear a short sound from the indoor unit. If the command is not received, press the  (Power) button again.

- 1 Check whether the air conditioner operates in accordance with the option values you have set:
 - a Reset the indoor or outdoor unit.
 - Indoor unit : Press the  (Set) and  (Low Fan) buttons on the remote control simultaneously for 4 seconds.
 - Outdoor unit : Press the K3 button.
 - b Remove the batteries from the remote control, insert them again, and then press the  (Power) button on the remote control.

4-1-2 Setting the indoor unit addresses

Option No. for an indoor unit address: 0AXXXX-1XXXXX-2XXXXX-3XXXXX

Before installing an indoor unit, be sure to set an address for the indoor unit by taking the following steps:

- 1 Make sure that the power is supplied to the indoor unit. If the indoor unit is not plugged in, it must include a power supply.

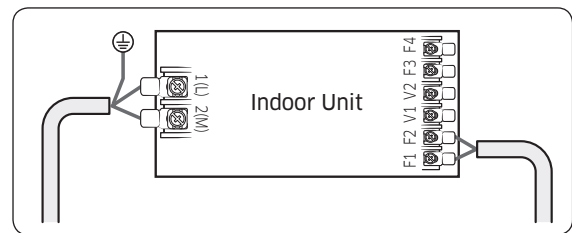

- 2 Set an address for each indoor unit using the remote control, according to your air conditioning system plan, by referring to the following table and by following the steps in **Common steps for setting the addresses and options** on page 17.
 - The indoor unit addresses (main and RMC addresses) are set to 0A0000-100000-200000-300000 by default.
 - If indoor units and outdoor units match 1:1, you don't need to set the main address because it is automatically set by the outdoor unit.
 - If you are using on or off controller, set RMC address.

Option	SEG1		SEG2		SEG3		SEG4	SEG5		SEG6	
Function	Page		Mode		Setting main address		Reserved	Reserved		Indoor unit number	
Indication and details	Indication	Details	Indication	Details	Indication	Details				Indication	Details
	0		A		0	No main address				0 to 9	Units digit
					1	Main address setting mode					
Option	SEG7		SEG8		SEG9		SEG10	SEG11		SEG12	
Function	Page		Reserved		Setting RMC address		Reserved	Group channel (x16)		Group address	
Indication and details	Indication	Details			Indication	Details		Indication	Details	Indication	Details
	1				0	No RMC address		RMC1	0 to 2	RMC2	0 to F
			1	RMC address setting mode							

CAUTION

- The main address must be set to a value in the range 0 to 14. If you set other values, communication error will occur.
- If any of SEG5 and SEG6 is set to a value in the range A to F, the main address of the indoor unit does not change.
- If SEG3 is set to 0, the indoor unit maintains the existing main address even if SEG6 is set to a new value.
- If SEG9 is set 0, the indoor unit maintains the existing RMC address even if SEG11 and SET12 are set to new values.

4-1-3 Setting the installation options in a batch

Option No. for an indoor unit address: 02XXXX-1XXXXX-2XXXXX-3XXXXX

- 1 Make sure that the power is supplied to the indoor unit. If the indoor unit is not plugged in, it must include a power supply.

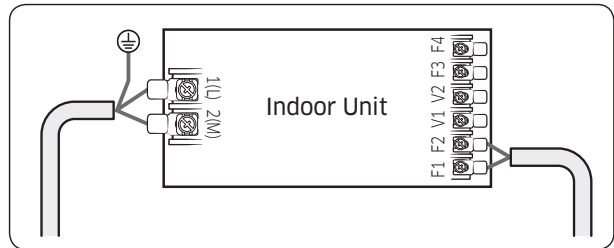

- 2 Set the installation options of indoor units, by referring to the following table and by following the steps in **Common steps for setting the addresses and options** on page 17.
 - The installation options of indoor units are set to 020000-100000-200000-300000 by default.
 - The SEG20 option, Individual control with remote control, allows you to control multiple indoor units individually by using the remote control.

Option	SEG1		SEG2		SEG3	SEG4		SEG5		SEG6	
Function	Page		Mode		Reserved	Use of external temperature sensor		Use of central control		Compensation of the fan RPM	
Indication and details	Indication	Details	Indication	Details		Indication	Details	Indication	Details	Indication	Details
	0	0	2	0		Disuse	0	Disuse	0	Disuse	0
										1	High-ceiling mode (recessed installation)
										4	Disuse (exposed installation)
										5	High-ceiling mode (exposed installation)

Option	SEG7		SEG8		SEG9		SEG10		SEG11		SEG12	
Function	Page		Use of drain pump									
Indication and details	Indication	Details	Indication	Details	Reserved		Reserved		Reserved		Reserved	
	1		0	Disuse								
			1	Use								
			2	Use with 3 minute delay								
Option	SEG13		SEG14		SEG15		SEG16		SEG17		SEG18	
Function	Page		Use of external control		Setting the output of external control		S-Plasma ion		Buzzer control		Maximum filter usage time	
Indication and details	Indication	Details	Indication	Details	Indication	Details	Indication	Details	Indication	Details	Indication	Details
	2		0	Disuse	0	Thermo on	0	Disuse	0	Use of buzzer	2	1000 hours
			1	On/Off control								
			2	Off control								
			3	Window on/off control								
	2		4	Disuse	1	Operation on	1	Use	1	Disuse of buzzer	6	2000 hours
			5	On/Off control								
			6	Off control								
			7	Window on/off control								
	Option	SEG19		SEG20		SEG21		SEG22		SEG23		SEG24
Function	Page		Individual control with remote control		Heating setting compensation						Cycle time of Swing	
Indication and details	Indication	Details	Indication	Details	Indication	Details	Reserved		Reserved		Indication	Details
	3		0 or 1	Indoor 1	0	Default					0	34 seconds (default)
			2	Indoor 2	1	2°C					1	30 seconds
			3	Indoor 3	2	5°C					2	38 seconds
			4	Indoor 4								

- Even if you set the Use of drain pump (SEG8) option to 0, it is automatically set to 2 (the drain pump is used with 3 minute delay).
- If you set the Maximum filter usage time (SEG18) option to a value other than 2 and 6, it is automatically set to 2 (1000 hours).
- If you set the Individual control with remote control (SEG20) option to a value other than 0 to 4, it is automatically set to 0 (Indoor 1).
- Default value of Heating setting compensation (SEG21) is 5°C for 360 cassette model.

* Level control: The centralized controller can limit the functions and inputs of connected products with this function enabled. (Example: Operation mode limit (Cooling only/Heating only/No limitation), Heating temperature upper limit, Cooling temperature lower limit)
To enable 'Level control' when applying the DPM with the centralized controller, appoint the master (Set 'Use of external control [SEG14] option to 4 or higher).

Example: When installing DPM (1 Outdoor unit with 4 indoor units)

Condition		SEG14 Setting				Result
External control	Level control	Indoor 1	Indoor 2	Indoor 3	Indoor 4	
Default		Not set (0)				Slave (All)
Disuse	Use	4	Not set (0)	Not set (0)	Not set (0)	Master (Indoor 1), Slave (Indoor 2,3,4)
Use (Indoor 3)	Disuse	Not set (0)	Not set (0)	1~3	Not set (0)	Slave (All)
Use (Indoor 4)	Use	Not set (0)	Not set (0)	Not set (0)	5~7	Master (Indoor 4), Slave (Indoor 1,2,3)

4-1-4 Changing the addresses and options individually

When you want to change the value of a specific option, refer to the following table and follow the steps in **Common steps for setting the addresses and options** on page 17.

Option	SEG1		SEG2		SEG3		SEG4		SEG5		SEG6	
Function	Page		Mode		Option mode to change		Tens position of the option number		Units position of the option number		New value	
Indication and details	Indication	Details	Indication	Details	Indication	Details	Indication	Details	Indication	Details	Indication	Details
		0		D		Option type	0 to F	Tens position value	0 to 9	Units position value	0 to 9	New value

Example: Changing the Buzzer control (SEG17) option of the installation options to 1 disuse.

Option	SEG1	SEG2	SEG3	SEG4	SEG5	SEG6
Function	Page	Mode	Option mode to change	Tens position of the option number	Units position of the option number	New value
Indication	0	D	2	1	7	1

4-2 Items to check before diagnostics

4-2-1 Four directions cassette type

Error Mode				Cause	Measures	Product operation with error			Diagnosis method
Operation	Defrost	Timer	Filter			Outdoor Unit compressor	Outdoor Unit fan	indoor Unit heat fan	
●	X	X	X	Power reset	-	operation-off	operation-off	operation-off	-
X	●	X	X	Error of room temperature sensor in the indoor unit (Open/Short)	<ul style="list-style-type: none"> • Check indoor temperature sensor connection. • Check indoor temperature sensor's resistance value to see if it's short/open. 	operation-off	operation-off	operation-off	page 4-17
●	●	X	X	Error of heat exchanger IN/OUT sensor in the indoor unit (Open/Short)	<ul style="list-style-type: none"> • Check EVA IN/OUT sensor connection. • Check EVA IN/OUT sensor's resistance value to see if it's short/open. 	operation-off	operation-off	operation-off	page 4-18
X	X	●	X	Error of fan motor in the indoor unit	<ul style="list-style-type: none"> • Check the connection of motor connector • Check the speed of the motor fan 	operation-off	operation-off	operation-off	page 4-19
●	X	●	X	Error of the outdoor temperature sensor Error of the condensor temperature sensor Error of the discharge temperature sensor	<ul style="list-style-type: none"> • Check outdoor temperature sensor connection. • Check outdoor temperature sensor's resistance value to see if it's short/open. 	operation-off	operation-off	operation-off	-
X	●	●	X	No communication for 2 minutes between indoor and outdoor unit (communication error for more than 2 minutes)	<ul style="list-style-type: none"> • Check connection between indoor and outdoor unit communication cables 	operation-off	operation-off	operation-off	page 4-20
X	●	●	●	Error of outdoor unit	<ul style="list-style-type: none"> • Check error occurred with outdoor unit. 	operation-off	operation-off	operation-off	-
X	X	●	●	Detection of the float switch	<ul style="list-style-type: none"> • Check float switch connection. • Check whether the drain has been filled with water. 	operation-off	operation-off	operation-off	page 4-21
●	●	●	X	EEPROM error	<ul style="list-style-type: none"> • Check if there is damage with EEPROM component. 	operation-off	operation-off	operation-off	page 4-22
●	●	●	●	EEPROM option error	<ul style="list-style-type: none"> • Check the indoor model to set the options. • Inspection for match between indoor and outdoor machine models 	operation-off	operation-off	operation-off	-
●	X	X	●	MDS-kit error	<ul style="list-style-type: none"> - Check the wire connection - Check the MDS-KIT - Check the indoor PBA 	operation-on	operation-on	operation-on	page 4-49

○ : On ● : Blink X : Off

4-2-2 Test run mode and View mode

■ Display Option Key

KEY	KEY operation	7-segment display
K1	Press once : Heating test run	"H" "1" "BLANK" "BLANK"
	Press twice : Defrost test run	"H" "3" "BLANK" "BLANK"
K2	Press once : Cooling test run	"H" "2" "BLANK" "BLANK"
K3	Reset	
K4	View mode	Refer to View mode display

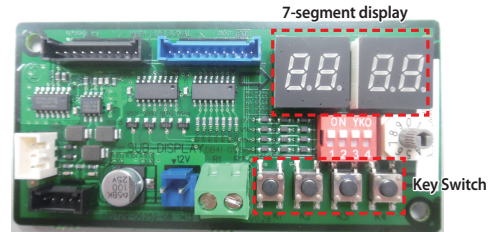

■ VIEW mode display

Number of press	Display contents	Display				Units
		Segment 1	Segment 2	Segment 3	Segment 4	
1	Order frequency	1	Three digits	Two digits	One digit	Hz
2	Current frequency	2	Three digits	Two digits	One digit	Hz
3	Number of indoor heat exchangers	3	Three digits	Two digits	One digit	Hz
4	Out sensor	4	Two digits	One digit	First decimal	°C
5	Discharge sensor	5	Two digits	One digit	First decimal	°C
6	OLP sensor	6	Two digits	One digit	First decimal	°C
7	Cond sensor	7	Two digits	One digit	First decimal	°C
8	Current	8	Two digits	One digit	First decimal	C
9	Fan RPM	9	Three digits	Two digits	One digit	rpm
10	Target discharge temperature	A	Three digits	Two digits	One digit	°C
11	EEV	B	Three digits	Two digits	One digit	step
12	Total indoor heat exchanger capacity	C	Two digits	One digit	First decimal	kW
13	Protection control	D	0 : air conditioning 1 : heating	Protection control 0 : no protection control 1 : freezing 2 : non-stop defrosting 3 : over-load 4 : discharge	Frequency state 0 : Normal 1 : Hold 2 : Down 3 : Up_limit 4 : Sown_limit	-
14	Group address of indoor heat exchanger	E	Three digits	Two digits	One digit	-
15	S/W check	F	-	-	-	-

4-2-3 Troubleshooting for outdoor unit

The table below list the self-diagnostic routines. For some of error codes, you must contact an authorized service centre. If an error occurs during the operation, it is displayed on the outdoor unit PCB LED, both MAIN PCB and INVERTER PCB.

No.	Error Code	Meaning	Remarks
1	E108	Error due to duplicated communication address	Check on repeated indoor unit main address
2	E121	Error on room temperature sensor of indoor unit (Short or Open)	Indoor unit Room Thermistor Open/Short
3	E122	Error on EVA IN sensor of indoor unit (Short or Open)	Indoor unit EVA_IN Thermistor Open/Short
4	E123	Error on EVA OUT sensor of indoor unit (Short or Open)	Indoor unit EVA_OUT Thermistor Open/Short
5	E153	Error on float switch (2nd detection)	Indoor unit Float Switch Open/Short Drain Pump operation Check
6	E154	Indoor fan error	Check on indoor unit indoor Fan operation
7	E198	Error on thermal fuse of indoor unit (Open)	Thermal Fuse Open Check of indoor unit Terminal Block
8	E201	Communication error between the indoor unit and outdoor unit (Pre-tracking failure or when the actual number of indoor units are different from the indoor unit quantity setting on the outdoor unit) Error due to communication tracking failure after initial power is supplied (The error occurs regardless of the number of units.)	Check indoor quantity setting in outdoor
9	E202	Communication error between indoor unit and outdoor unit (When there is no response from indoor units after tracking is completed)	Check electrical connection and setting between indoor unit and outdoor unit
10	E203	Communication error between the outdoor unit and main micom (For PF #4 to #6 controllers, error will be determined from the time when the compressor is turned on.)	Check electrical connection and setting between indoor unit MAIN PBA - INVERTER PBA
11	E221	Error on outdoor temperature sensor (Short or Open)	Check Outdoor sensor Open / Short
12	E231	Error on outdoor COND OUT sensor (Short or Open)	Check Cond-Out sensor Open / Short
13	E251	Error on discharge temperature sensor of compressor 1 (Short or Open)	Check Discharge sensor Open / Short
14	E320	Error on OLP sensor (Short or Open)	Check OLP sensor Open / Short
15	E403	Compressor down due to freeze protection control	Check Outdoor Cond.
16	E404	System stop due to overload protection control	Check Comp. when it starts
17	E416	System stop due to discharge temperature	-
18	E422	Blockage detected on high pressure pipe	1. Check if the service valve is open 2. Check for refrigerant leakage (pipe connections, heat exchanger) and charge refrigerant if necessary 3. Check if there's any blockage on the refrigerant cycle (indoor unit/outdoor unit) 4. Check if additional refrigerant has been added after pipe extension
19	E425	Reverse phase or open phase	Check whether 3 phase is reversed or opened.
20	E440	Heating operation restricted at outdoor temperature over Theat_high value	HEATING
21	E441	Cooling operation restricted at outdoor temperature below Tcool_low value	COOLING
22	E458	Fan speed error	FAN1 ERROR

No.	Error Code	Meaning	Remarks
23	E461	Error due to operation failure of inverter compressor	-
24	E462	System stop due to full current control	-
25	E463	Over current trip / PFC over current error	Check OLP sensor
26	E464	IPM Over Current(O.C)	IPM
27	E465	Comp. Over load error	-
28	E466	DC-Link voltage under/over error	Check AC Power and DC Link Voltage
29	E467	Error due to abnormal rotation of the compressor or unconnected wire of compressor	Check Comp wire
30	E468	Error on current sensor (Short or Open)	Check Outdoor Inverter PBA.
31	E469	Error on DC-Link voltage sensor (Short or Open)	-
32	E470	Outdoor unit EEPROM Read/Write error (Option)	Check Outdoor EEPROM Data
33	E471	Outdoor unit EEPROM Read/Write error (H/W)	Check Outdoor EEPROM PBA
34	E472	AC Line Zero Cross Signal out	-
35	E473	Comp Lock error	-
36	E474	Error on IPM Heat Sink sensor of inverter 1 (Short or Open)	Check Outdoor Inverter PBA.
37	E475	Error on inverter fan 2	FAN2 ERROR
38	E484	PFC Overload (Over current) Error	Check Outdoor Inverter PBA.
39	E485	Error on input current sensor of inverter 1 (Short or Open)	Check Outdoor EEPROM PBA
40	E500	IPM over heat error on inverter 1	Check Outdoor Inverter PBA.
41	E508	Smart install is not installed	-
42	E554	Gas leak detected	Check the refrigerant
43	E556	Error due to mismatching capacity of indoor and outdoor unit	Check the indoor and outdoor unit capacity
45	E590	Inverter EEPROM Checksum error	-
46	E660	Inverter Boot Code error	-

4-2-4 Wired remote controller

- If an error occurs, () icon will be displayed on the wired remote controller.
- Press the Test button to see the error code.

Error mode	Contents	Measure	Product operation in error condition	Error type
			Outdoor unit/Compressor/Indoor unit	
101	Indoor unit communication error	Check the communication cable of indoor unit. Check the DC output voltage at the communication terminal	Operation Off	Communication error
102	Indoor unit/outdoor unit communication time-out error: errors in more than 6 packets	Check the outdoor communication cable connection. Check DC output voltage and the communication terminal	Operation Off	Communication error
121	Indoor temperature sensor (open/short error)	Check indoor unit room temperature sensor. Check indoor unit PCB connector CN41 (White)	Operation Off	Indoor sensor error
122	Indoor unit Eva In sensor (Open/Short)	Check indoor unit pipe sensor. Check indoor PCB connector CN41 (White)	Operation Off	Indoor sensor error
128	Indoor unit Eva In sensor disconnection	Check the disconnection of indoor unit pipe sensor	Operation Off	Indoor sensor error
143	Remocon Option for MDS is set for ON, but MDS kit is disconnected or the signals for sensors are abnormal.	Check the wire connection Check the MDS kit Check the main PBA	Normal operation (without MDS kit)	MDS kit Error
153	Indoor floating switch secondary detection	Check indoor unit float sensor. Check indoor PCB connector CN5 (black)	Operation Off	Self diagnostic error
202	Indoor/outdoor communication error (1 min)	Check the communication connection between indoor and outdoor units. Check the power line and communication cable connection status	Operation Off	Communication error
203	Communication error between indoor/outdoor INV↔MAIN MICOM (1 min)	Check MAIN MICOM Check INVERTER MICOM	-	Communication error
221	Outdoor temperature sensor error	Check sensor connection status Check sensor location Check sensor resistance	Operation Off	Outdoor sensor error
237	COND temperature sensor error	Check sensor connection status Check sensor location Check sensor resistance	Operation Off	Outdoor sensor error
251	[Inverter] Emission temperature sensor error	Check sensor connection status Check sensor location Check sensor resistance	Operation Off	Outdoor sensor error
416	Emission temperature excessively high	No error (DISCHARGE temperature control)	-	Outdoor unit protection control error
440	Heating operation blocked	Check the operation setting state Check temperature sensor	Operation Off	Self diagnostic error
441	Cooling operation blocked	Check the operation setting state Check temperature sensor	Operation Off	Self diagnostic error
458	Outdoor fan 1 error	Check input power connection status Check the connection status between the motor and outdoor unit PCB Check indoor/outdoor fuse	Operation Off	Self diagnostic error
461	[Inverter] Compressor startup error	Check the compressor connection status Check the resistance between difference phases of the compressor	Operation Off	Outdoor unit protection control error
462	[Inverter] Total current error/PFC over current error	Check the input power Check the coolant charging status Check the normal operation of outdoor fan	Operation Off	Outdoor unit protection control error

Error mode	Contents	Measure	Product operation in error condition	Error type
			Outdoor unit/ Compressor/Indoor unit	
464	[Inverter] IPM over current error	Check coolant charging Check the compressor connection status and normal operation Check the obstacles around the indoor and outdoor units Check whether the outdoor unit service valve is open Check whether the indoor/outdoor installation pipe/wiring are correct	Operation Off	Outdoor unit protection control error
465	Compressor V limit error	Check the compressor connection status Check the resistance between difference phases of the compressor	Operation Off	Outdoor unit protection control error
466	DC LINK over/low voltage error	Check input power Check AC power connection	Restart in 3 minutes	Outdoor unit protection control error
467	[Inverter] Compressor rotation error	Check the compressor connection status Check the resistance between difference phases of the compressor	Operation Off	Outdoor unit protection control error
468	[Inverter] Current sensor error	Check EEPROM DATA Check the normal operation of PCB	Operation Off	Outdoor unit protection control error
469	[Inverter] DC LINK voltage sensor error	Check the input power connection Check the status of RY21 and R200 in the INVERTER PCB	Operation Off	Outdoor unit protection control error
471	[Inverter] OTP error	Check EEPROM DATA Check the normal operation of PCB	Operation Off	Outdoor unit protection control error
472	AC ZERO CROSSING SIGNAL OUT error	Check the input power status	Operation Off	Outdoor unit protection control error
473	Compressor LOCK error	Check the compressor connection status Check the resistance between difference phases of the compressor	Operation Off	Outdoor unit protection control error
475	Outdoor fan 2 error	Check the input power connection status Check the connection status of the motor and the outdoor unit PCB Check the indoor/outdoor unit fuse	Operation Off	Self diagnostic error
554	Gas leak error	Check the coolant charging status Check the indoor EVA sensor Check if the outdoor unit service value is open Check that the indoor/outdoor installation pipe/wiring are correct	Operation Off	Self diagnostic error
556	Capacities not matched	Check the option code of the indoor unit	Operation Off	Outdoor unit protection control error
601	Communication error between the indoor unit and wired remote controller	Check the connection wire between the indoor unit and the wired remote controller	Normal operation	Wired remote controller error
602	Communication error between the Master and Slave wired remote controllers	Check the option switch for defining the Master and Slave (only one Master and one Slave can exist)	Normal operation	Wired remote controller error
606	COM1/COM2 cross installation error	Check that wired remote controller is connected to the COM2 terminal of the indoor unit	Normal operation	Wired remote controller error
8ER	Wired remote controller COM2 option setting error	Check that Com1, Com2 setting DIP switch is set to Com2	Normal operation	Wired remote controller error

4-3 Troubleshooting by symptoms

4-3-1 Indoor temperature sensor (open/short)

Indoor unit display	X (Operation) ● (Defrost) X (Timer) X (Filter)
Symptom	In case of open or short circuit of indoor temperature sensor
Failure	Short or leakage of the corresponding sensor

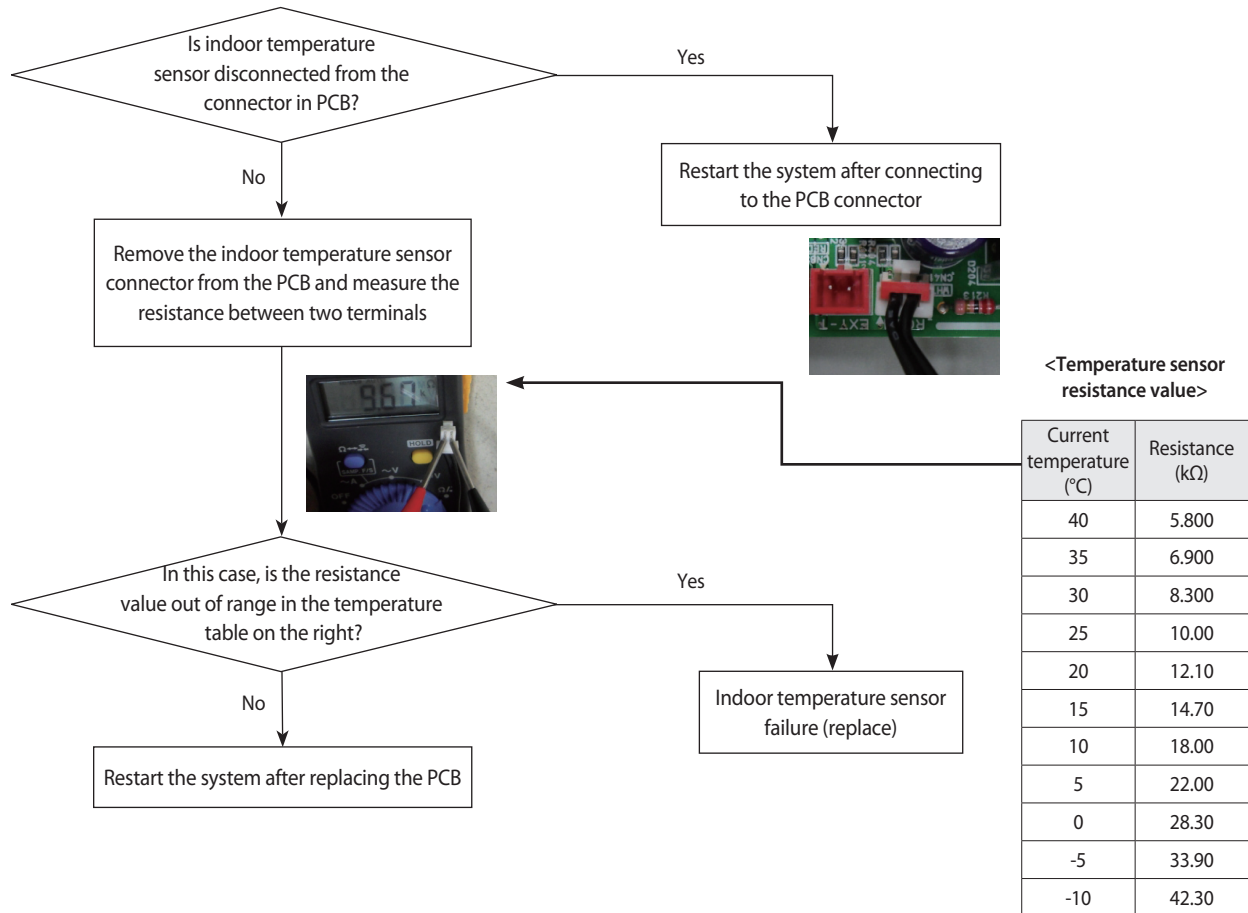

4-3-2 Indoor heat exchanger temperature sensor (open/short)

Indoor unit display	● (Operation) ● (Defrost) X (Timer) X (Filter)
Symptom	Short or open circuit of indoor heat exchanger temperature sensor
Failure	Short or open circuit in the corresponding sensor

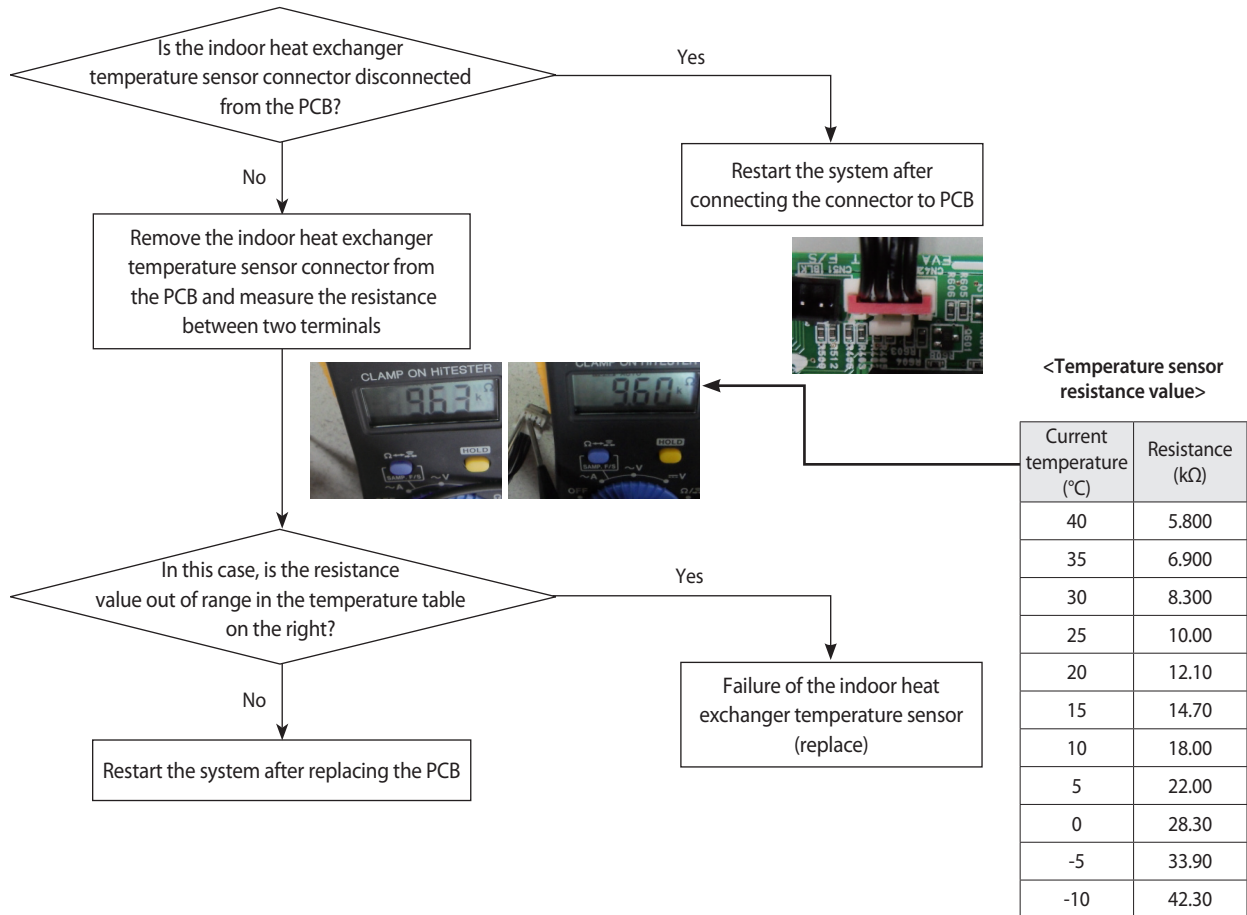

4-3-3 Indoor FAN error

Indoor unit display	X (Operation) X (Defrost) ● (Timer) X (Filter)
Symptom	Indoor unit fan does not run /Runs at excessive high speed and stops
Failure	Check if the motor connector is disconnected/ check the motor fan assembly status

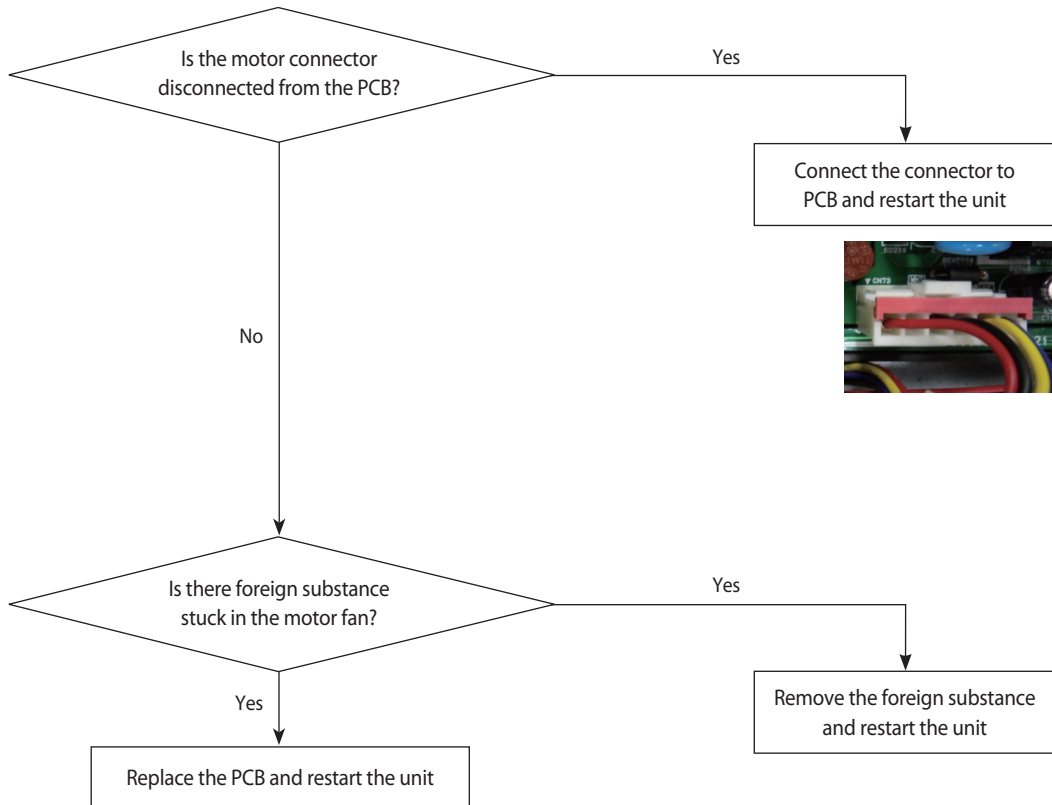

4-3-4 Communication error after finishing Tracking

Indoor unit display	X (Operation) ● (Defrost) ● (Timer) X (Filter)
Symptom	Communication error between the indoor and outdoor unit for two minutes
Failure	Communication error between the indoor unit and outdoor unit

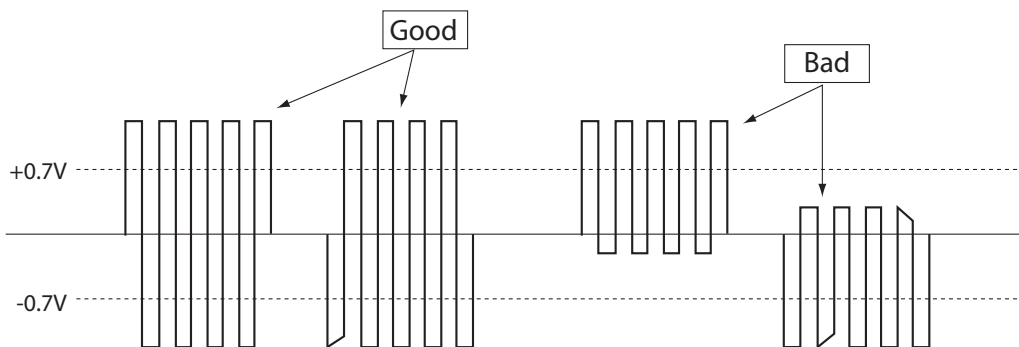
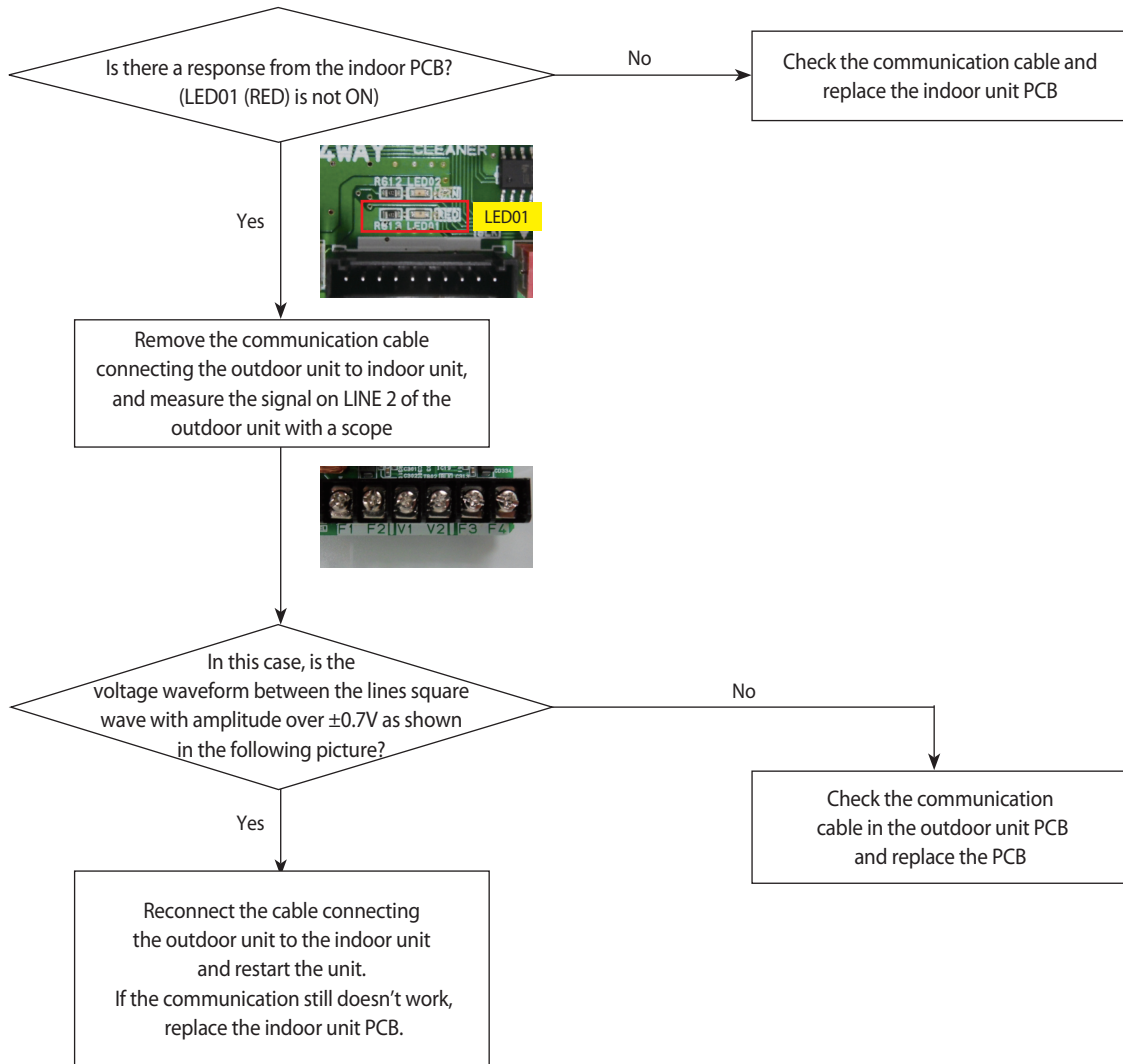

4-3-5 Indoor unit float sensor error

Indoor unit display	X (Operation) X (Defrost) ● (Timer) ● (Filter)
Symptom	The indoor unit floating sensor is open and that state is maintained for more than one minute
Failure	Increase in the drain pan water level due to failure of the indoor unit drain pump, or float sensor failure

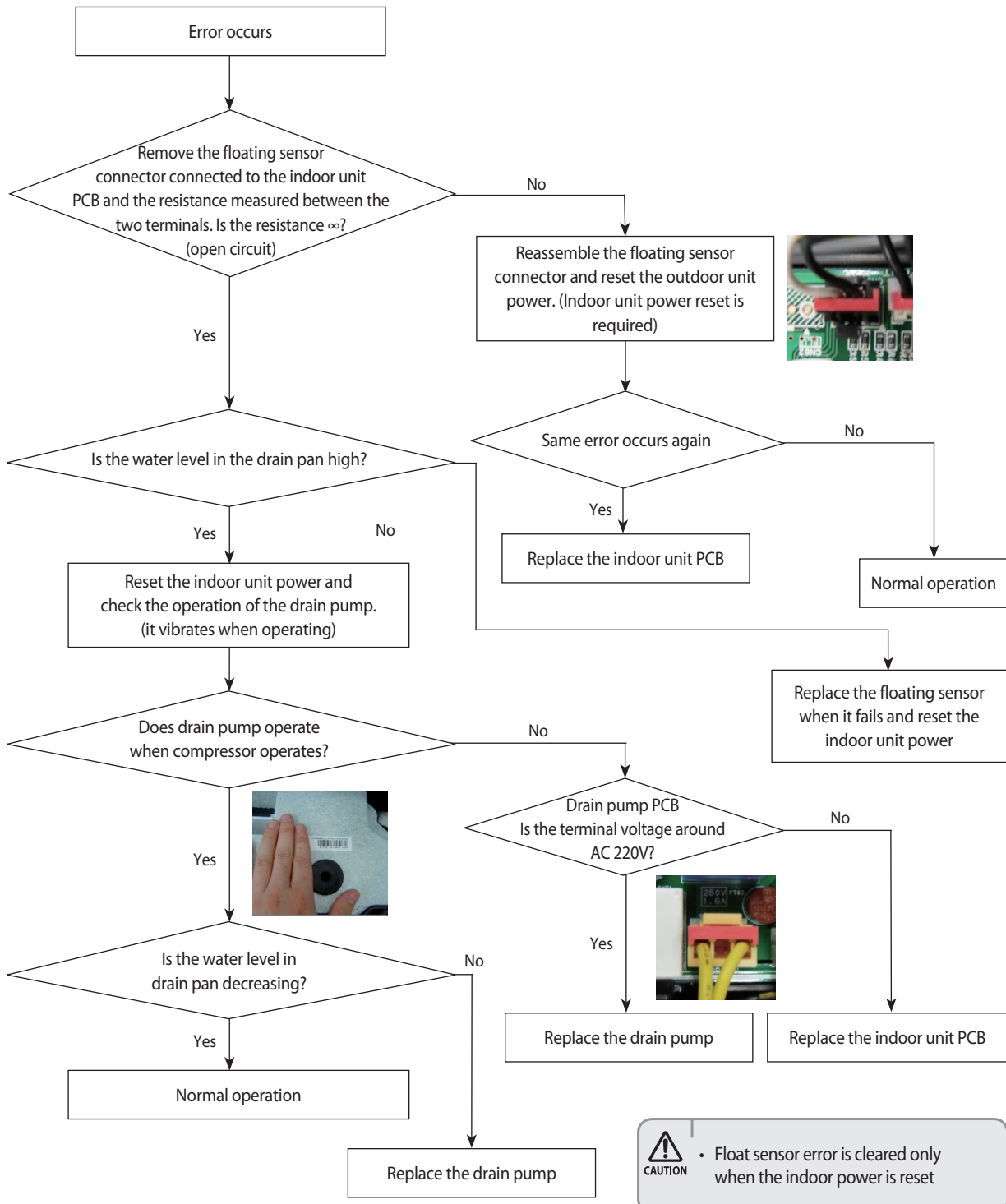

4-3-6 EEPROM circuit failure

Indoor unit display	● (Operation) ● (Defrost) ● (Timer) X (Filter)
Symptom	EEPROM circuit failure
Failure	EEPROM component failure, EEPROM circuit parts missing/damaged/soldering failure

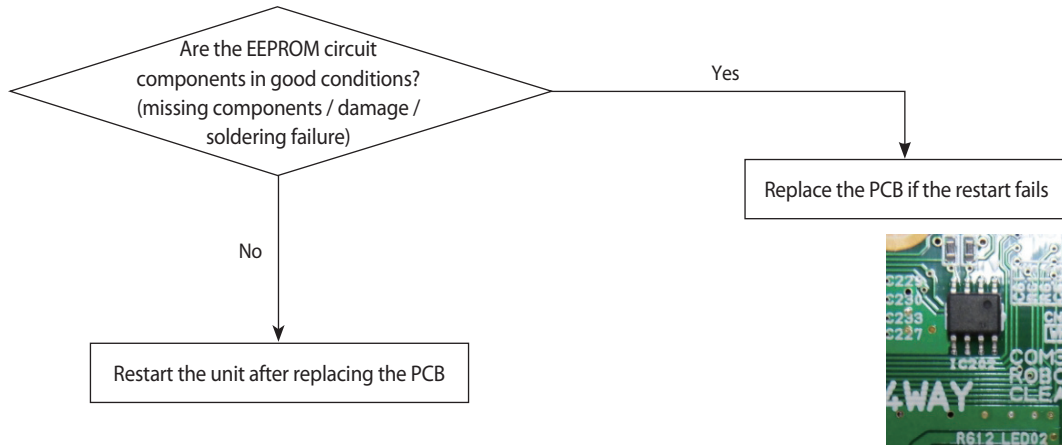

4-3-7 Outdoor unit is not powered on – Initial diagnosis

1. Check items

- 1) Is the power supply voltage 220V?
- 2) Is the AC power connected correctly?
- 3) Are the LEDs in the main PCB and inverter PCB of the outdoor unit ON?
- 4) Is the input power voltage of the indoor unit 220V?
- 5) Is the wired remote controller connected correctly?

2. Check procedure

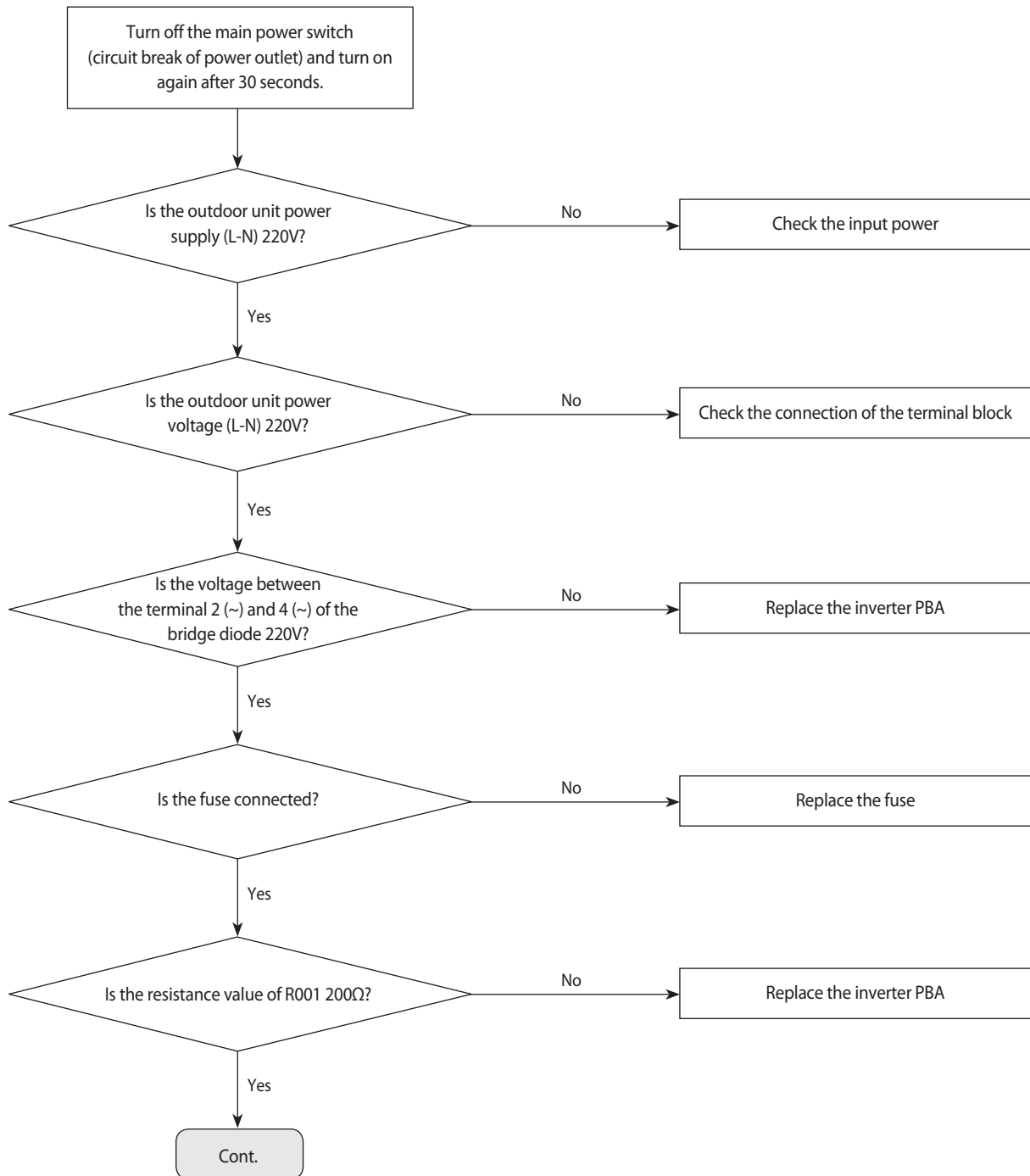

Outdoor unit is not powered on – Initial diagnosis (cont.)

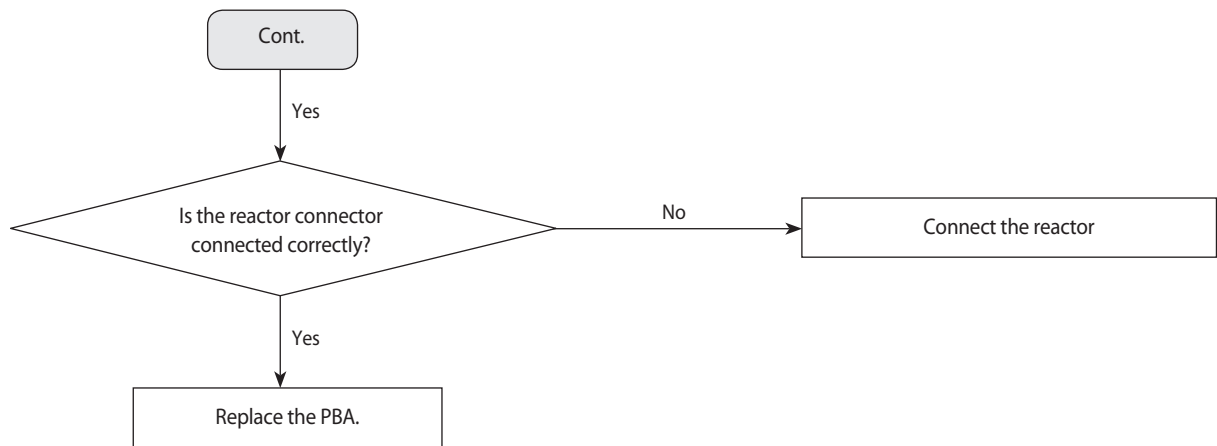

4-4 Troubleshooting by symptoms

4-4-1 Communication error

1. Checklist :

- 1) Is the cable between the indoor unit and outdoor unit connected correctly?
- 2) Isn't the power cable and communication cable cross?

2. Troubleshooting procedure

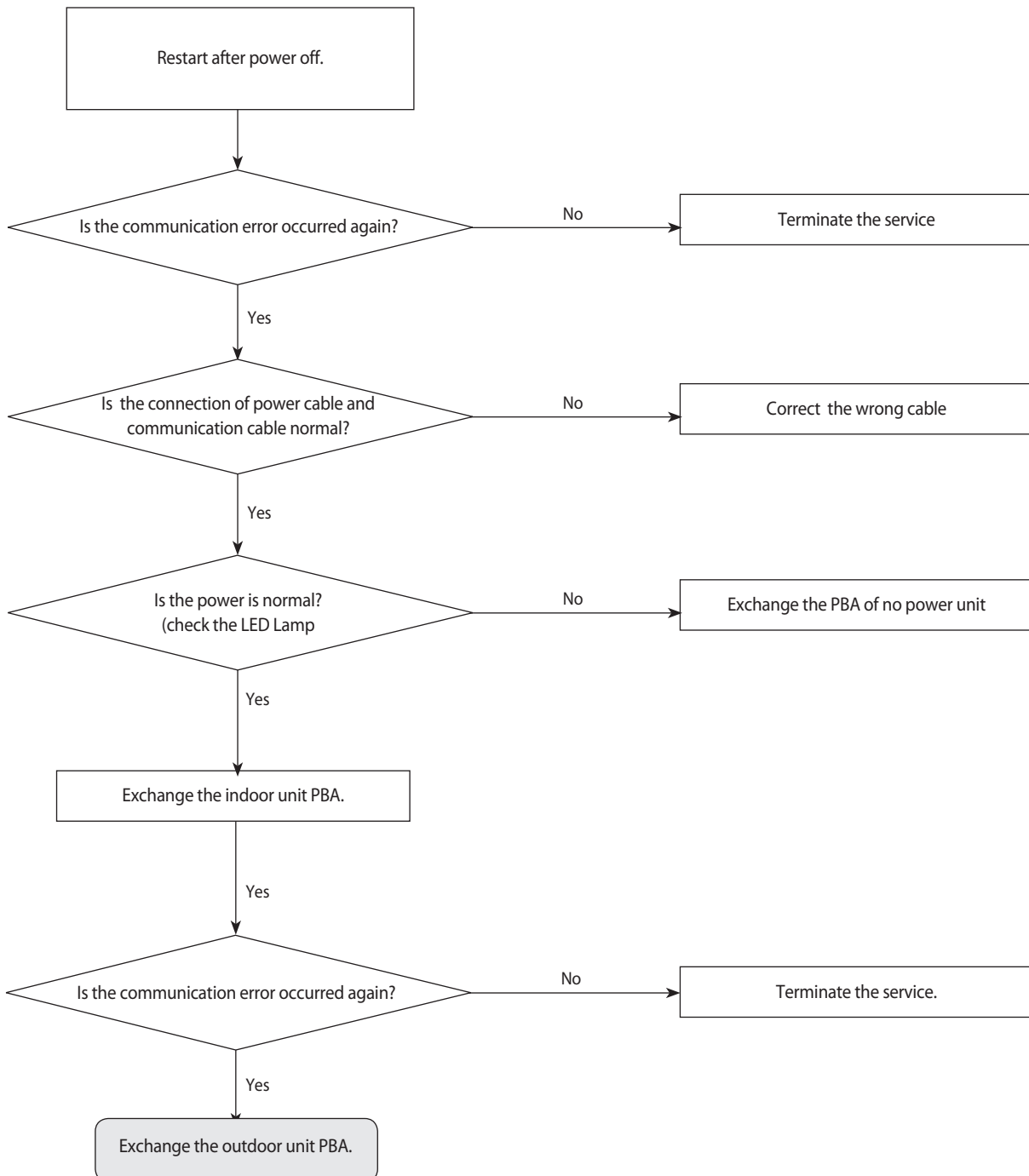

4-4-2 Outdoor temperature sensor error

1. 1. Checklist :

- 1) Is the cable between the indoor unit and outdoor unit connected correctly?
- 2) Is the sensor placed correctly?
- 3) Does the both terminal of sensor satisfy the resistance value in accordance with temperature?
- 4) Is the resistance value of sensor connection pull-up correct?

4-4-2-1. Troubleshooting procedure (PF2)

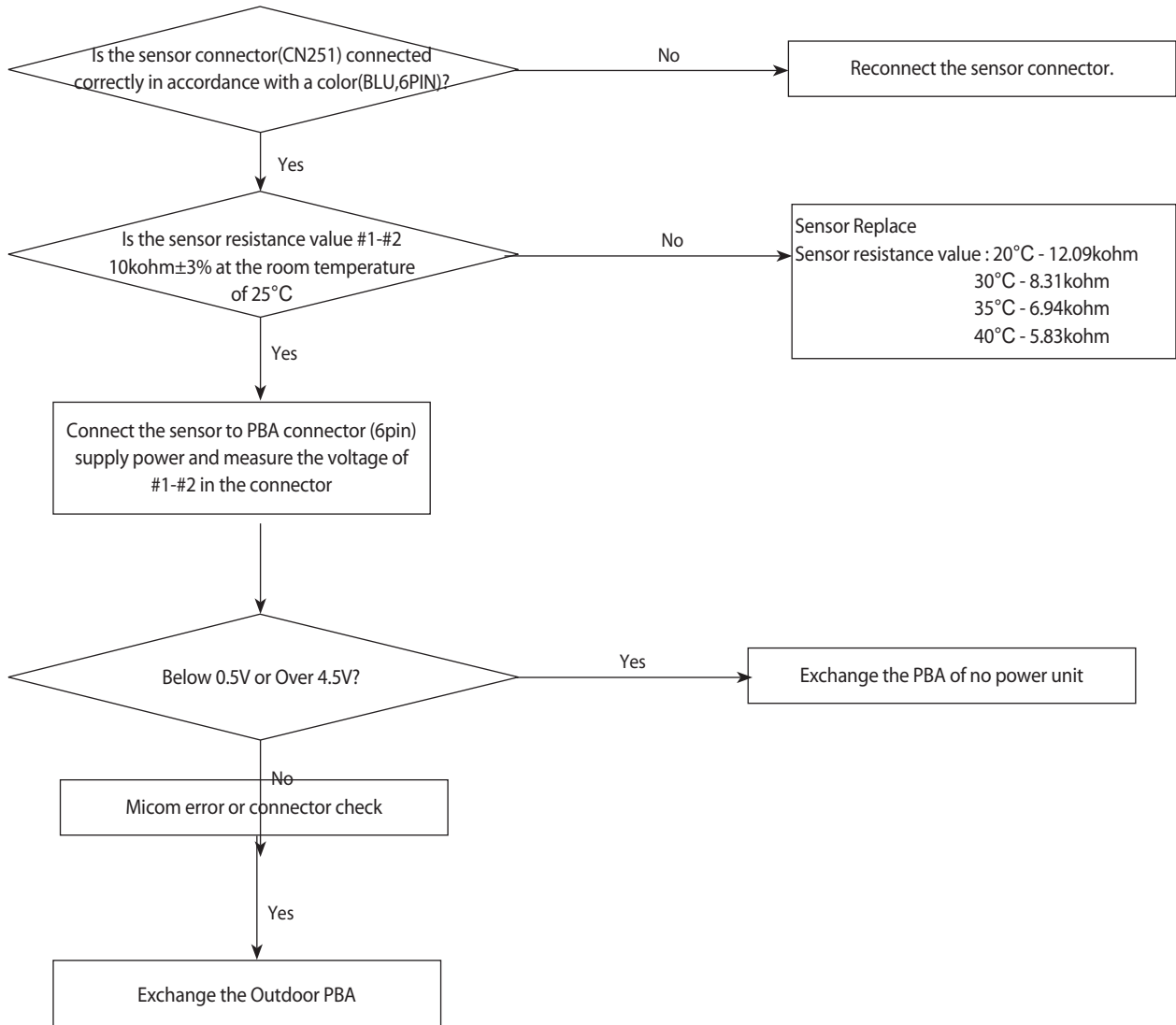

4-4-2-2. Troubleshooting procedure (PF3)

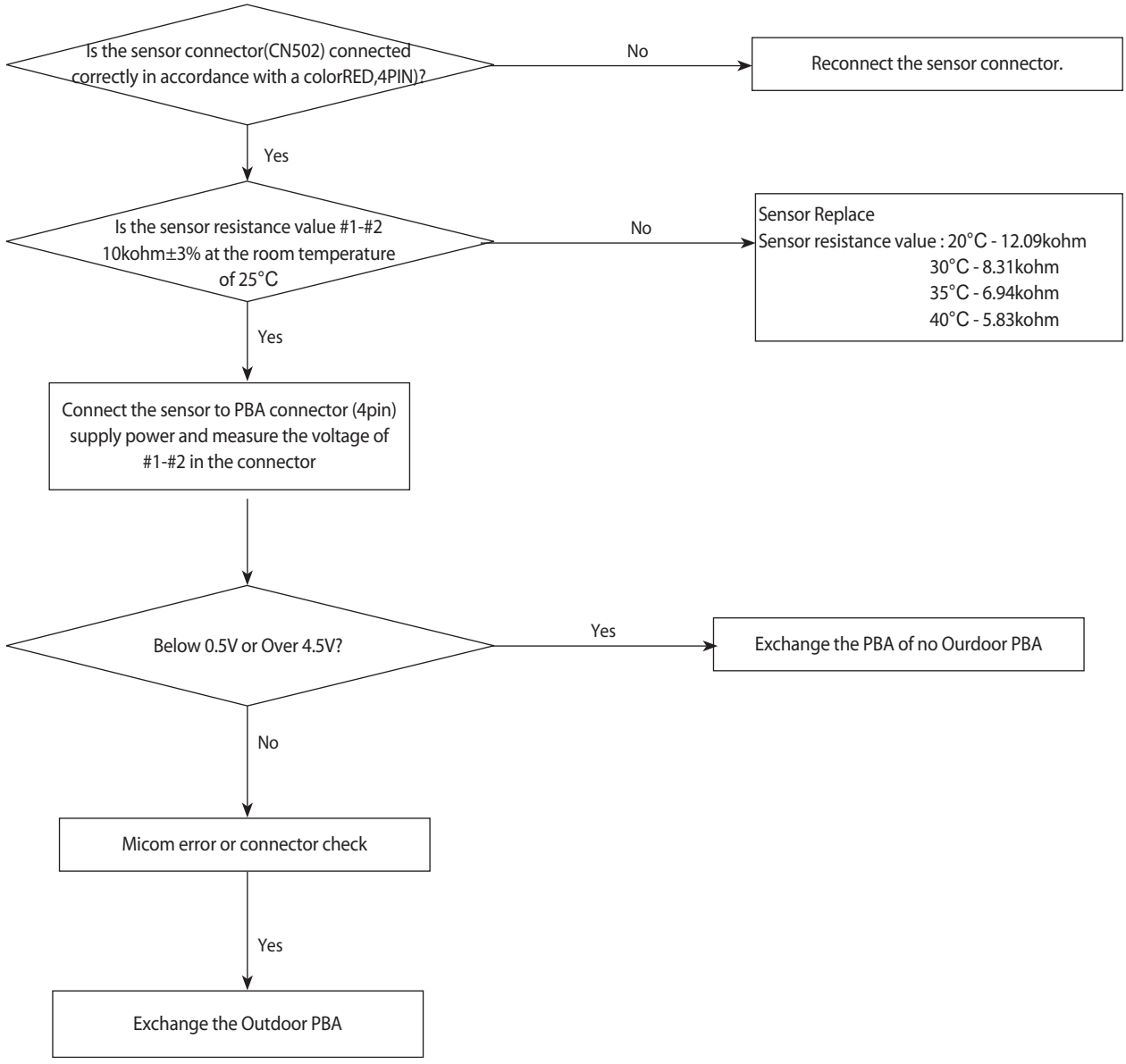

4-4-3 Outdoor Coil temperature sensor error

1. Checklist :

- 1) Is the sensor connected correctly?
- 2) Is the sensor placed correctly?
- 3) Does the both terminal of sensor satisfy the resistance value in accordance with temperature?
- 4) Is the resistance value of sensor connection pull-up correct?

4-4-3-1. Troubleshooting procedure (PF2)

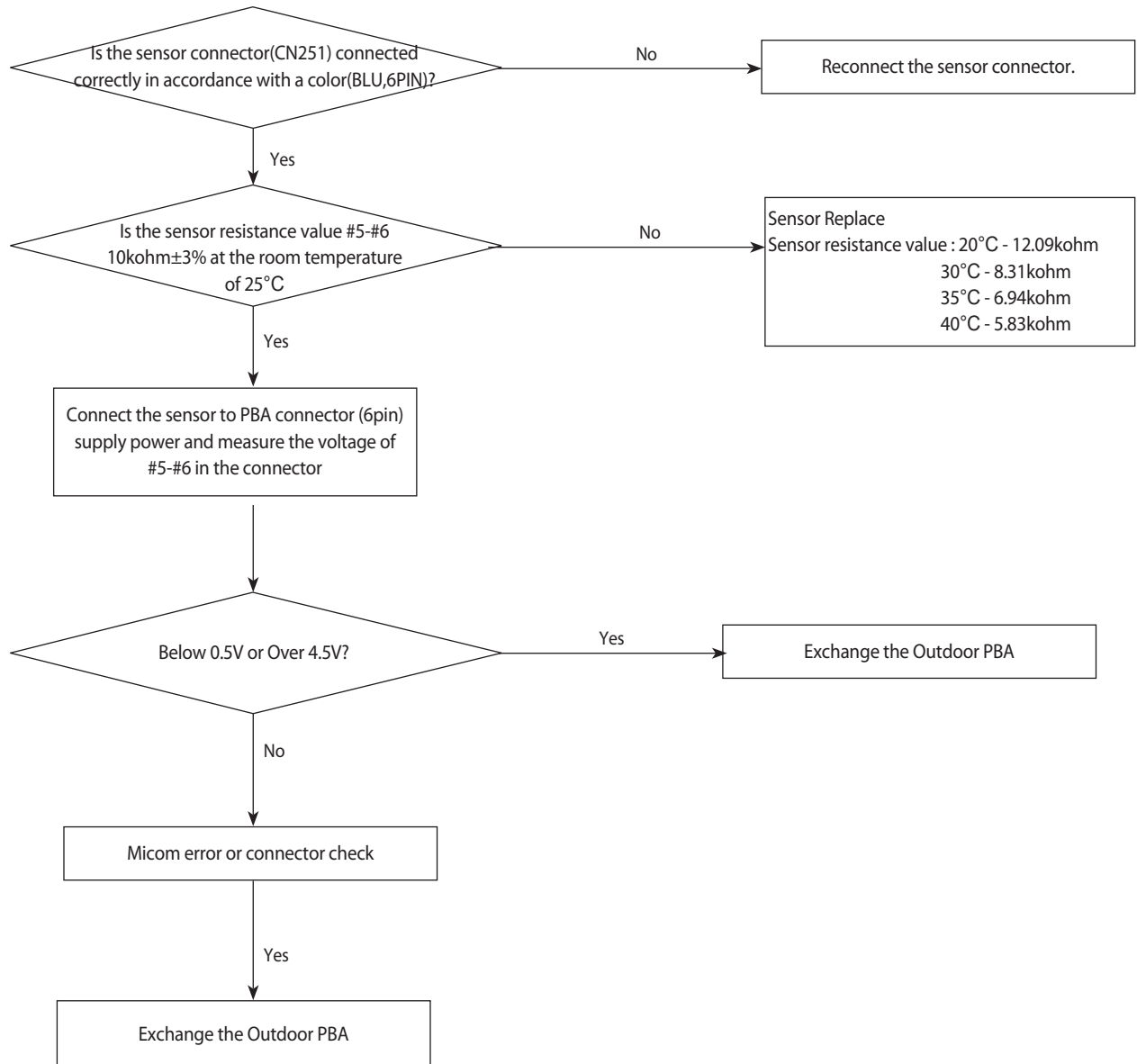

4-4-3-2. Troubleshooting procedure (PF3)

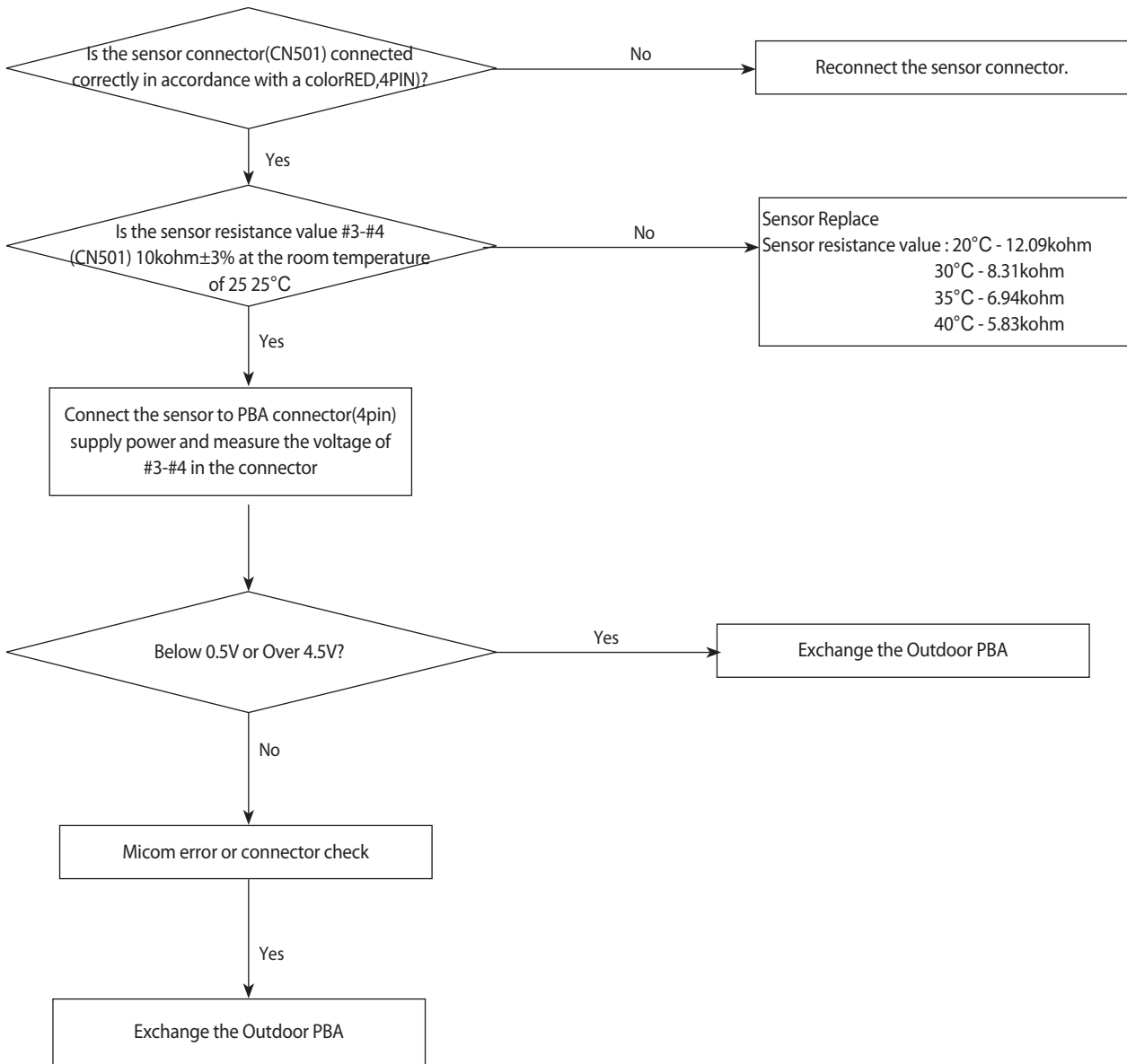

4-4-4 Outdoor Discharge temperature sensor error

1. Checklist :

- 1) Is the sensor connected correctly?
- 2) Is the sensor placed correctly?
- 3) Does the both terminal of sensor satisfy the resistance value in accordance with temperature?
- 4) Is the resistance value of sensor connection pull-up correct?

4-4-4-1. Troubleshooting procedure (PF2)

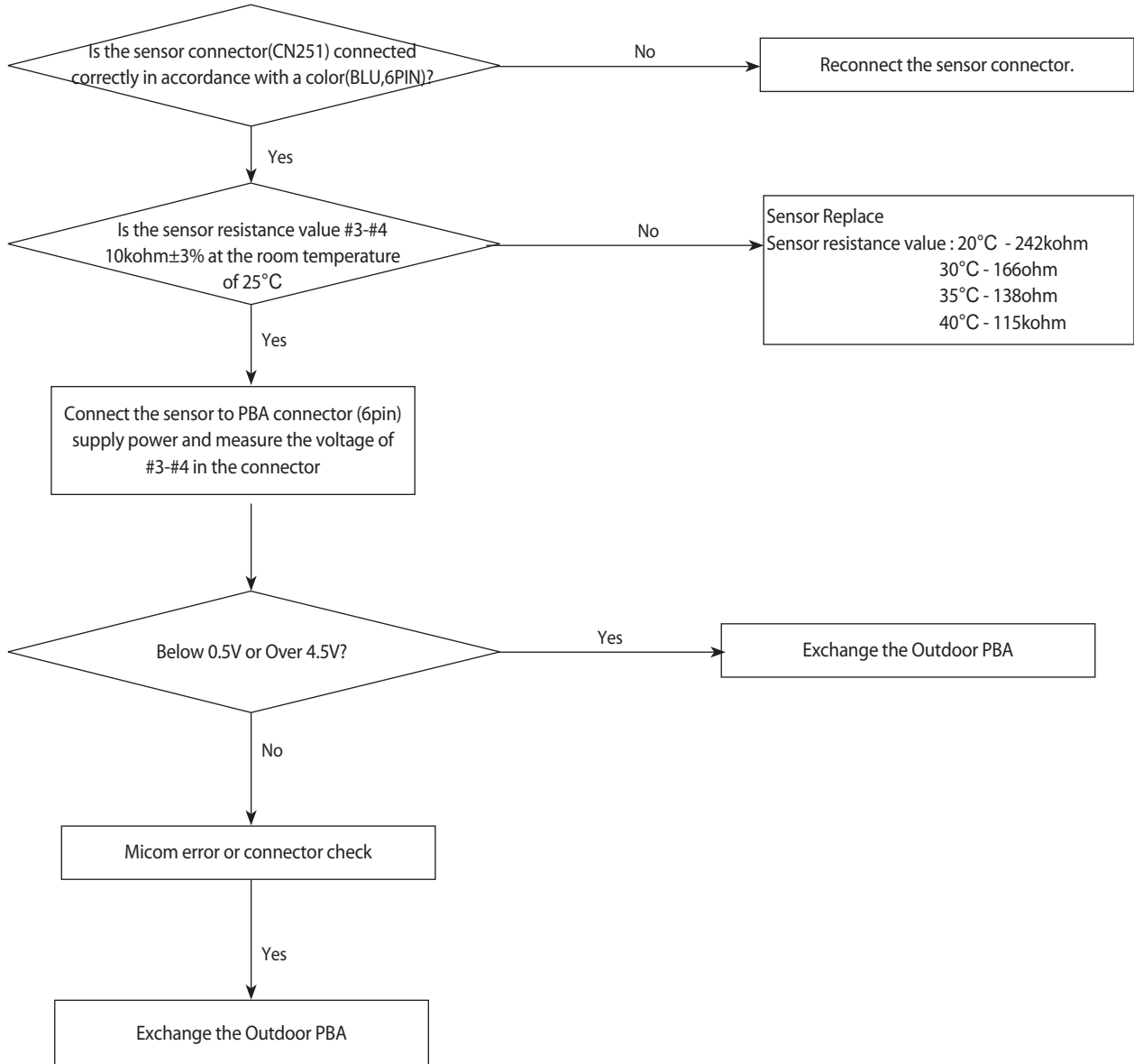

4-4-4-2. Troubleshooting procedure (PF3)

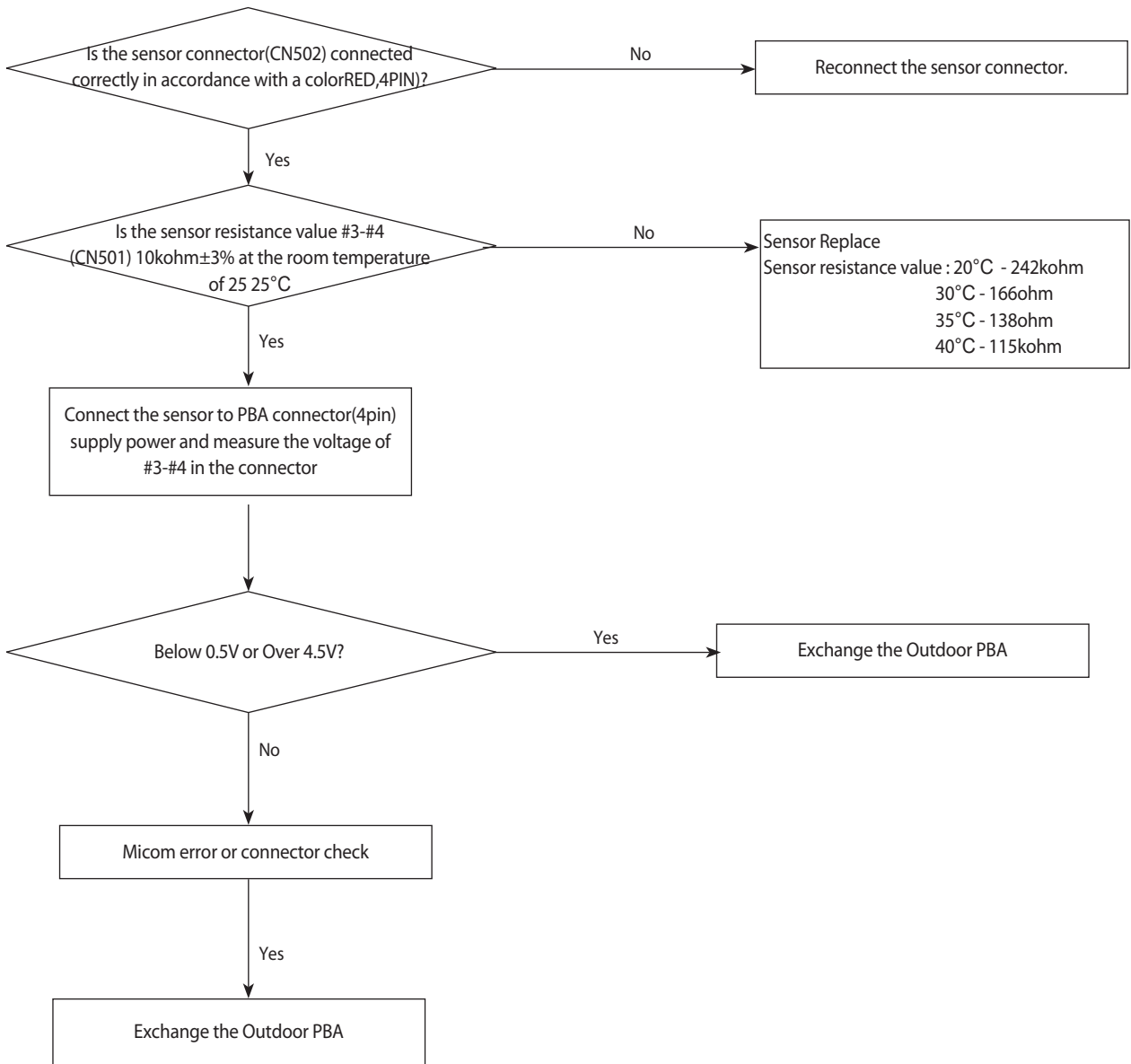

4-4-5 Outdoor Discharge over temperature error

1. Checklist :

- 1) Check the discharge temperature in the outdoor unit
- 2) Check the compressor locking or gas leak
- 3) 3) Download the EEPROM data

2. Troubleshooting procedure

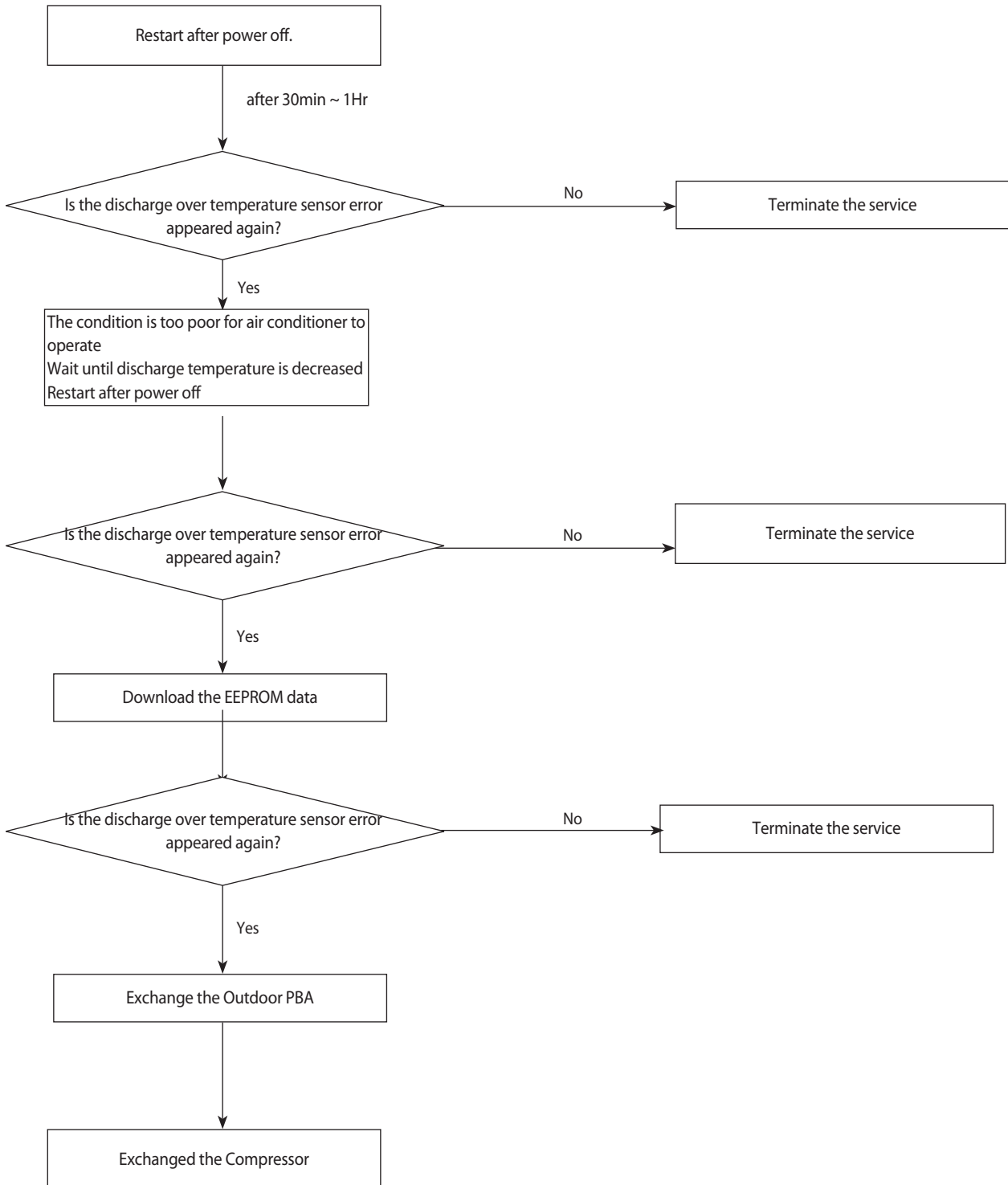

4-4-6 Outdoor Fan motor error

1. Checklist :

- 1) Are the input power voltage and the power connection correct?
- 2) Is the motor wire connected to the outdoor PBA correctly?
- 3) Is there no assembly error or none-assembly in the terminal of motor wire connector?
- 4) Is there no obstacle at the surrounding of motor and propeller?

2. Troubleshooting procedure

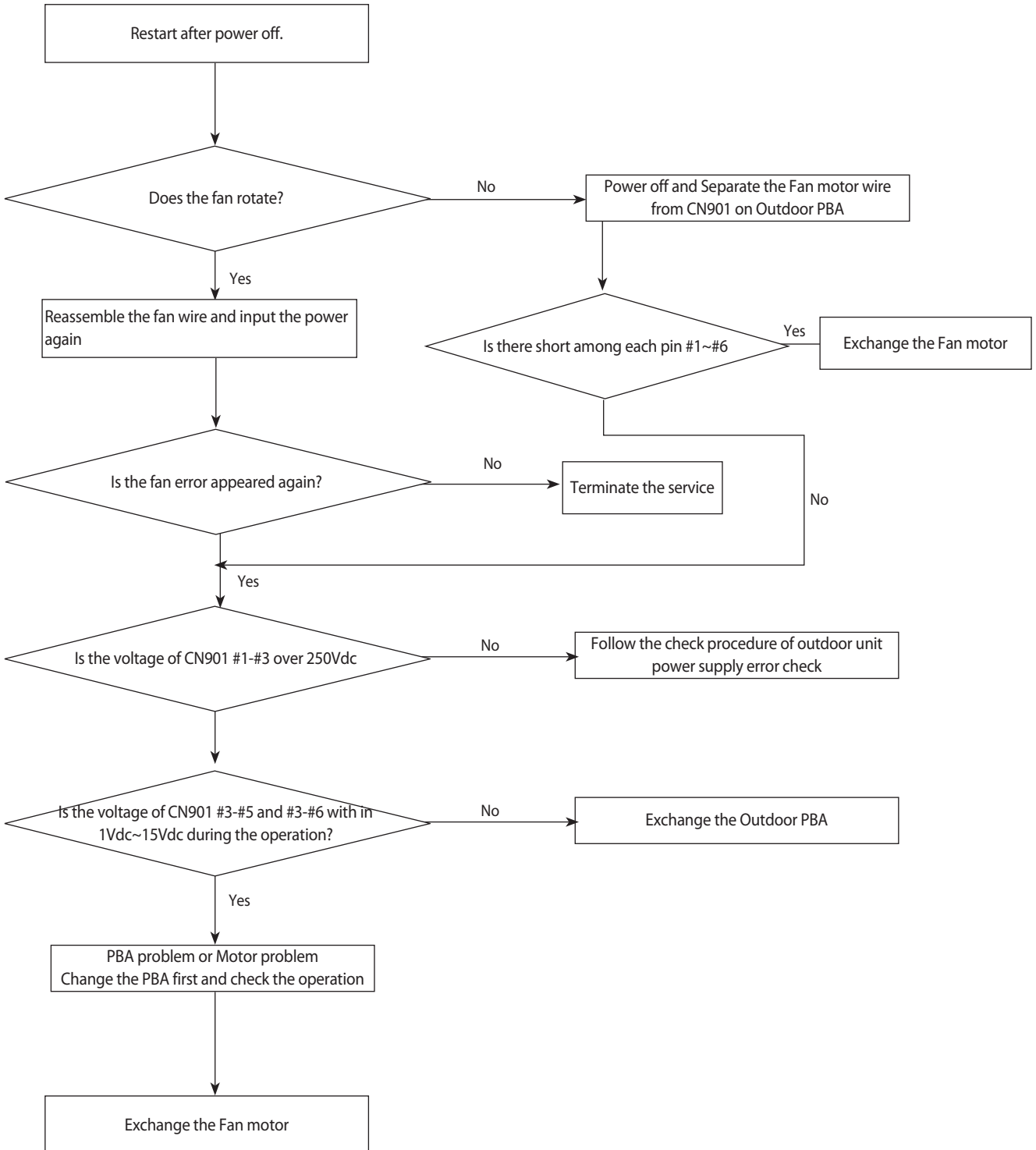

4-4-7 Compressor starting error

1. Checklist :

- 1) Is the connection of cable for the compressor?
- 2) Is the compressor wire is connected clockwise? U(RED)-V(BLU)-W(YEL)
- 3) Is the interphase resistance of compressor normal?

2. Troubleshooting procedure

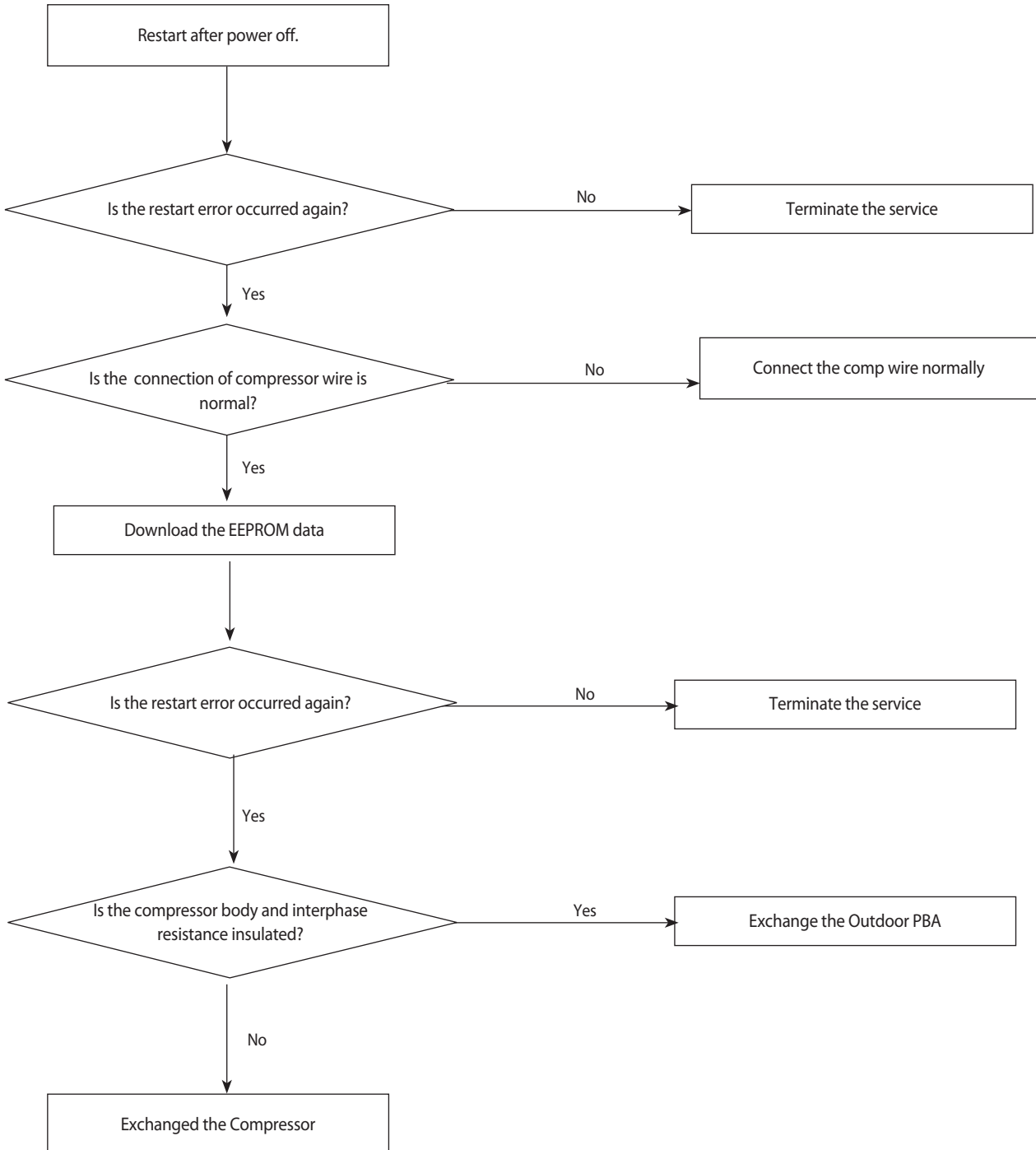

4-4-8 Compressor wire missing error/rotation error

1. Checklist :

- 1) Is the connection of cable for the compressor?
- 2) Is the compressor wire is connected clockwise? U(RED)-V(BLU)-W(YEL)
- 3) Is the interphase resistance of compressor normal?

2. Troubleshooting procedure

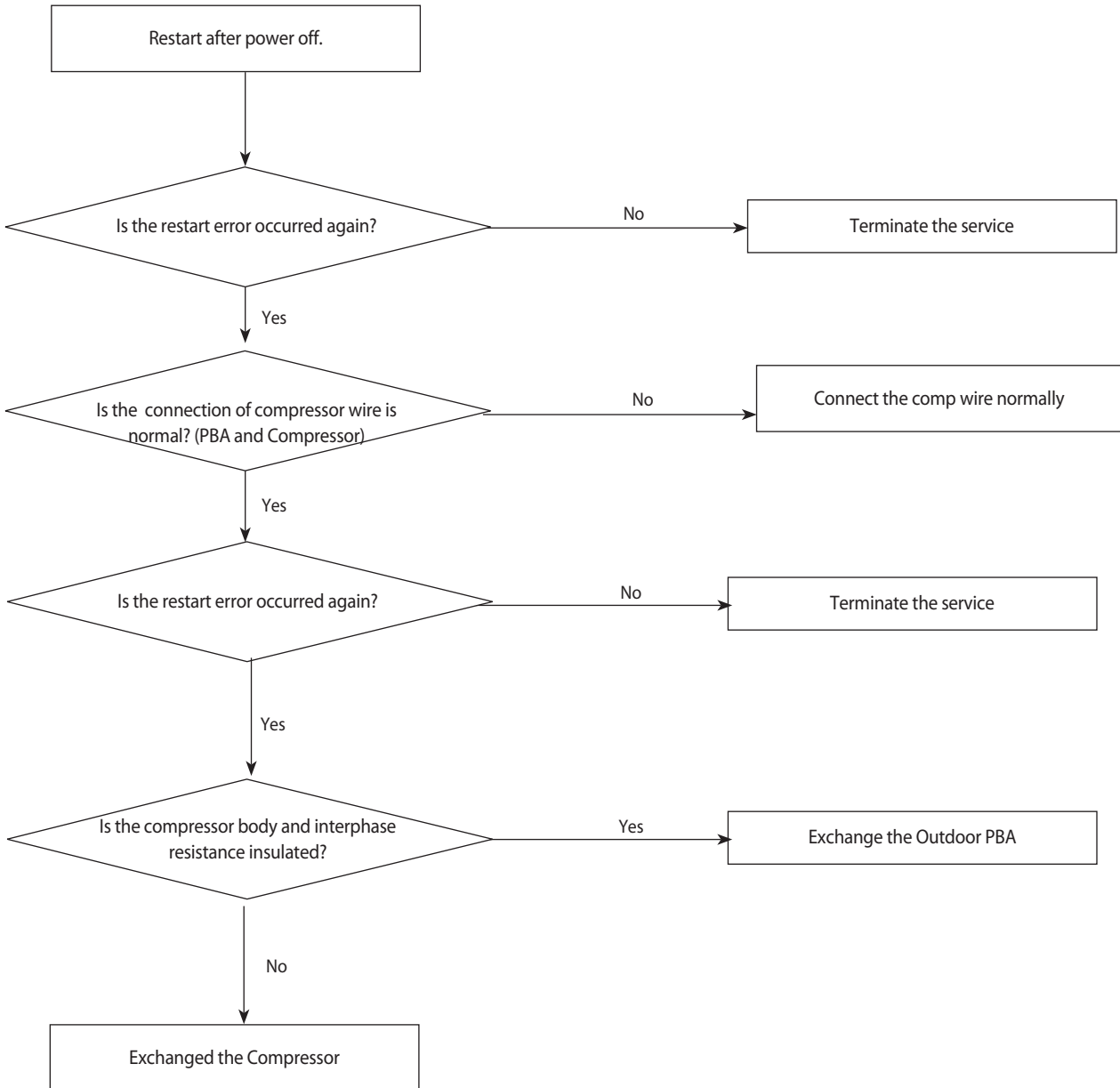

4-4-9 O.C(Over Current) error

1. Checklist :

- 1) Is the IPM Shunt(PF2:R451,R452,R453,PF3:R413,R414,R415) resistance value correct? Check the resistor is opened
- 2) Is the condition of surrounding temperature abnormal overload?
- 3) Is there any problem as like the temperature sensor separation or measurement value error?
- 4) Is the interphase resistance of compressor normal?

2. Troubleshooting procedure

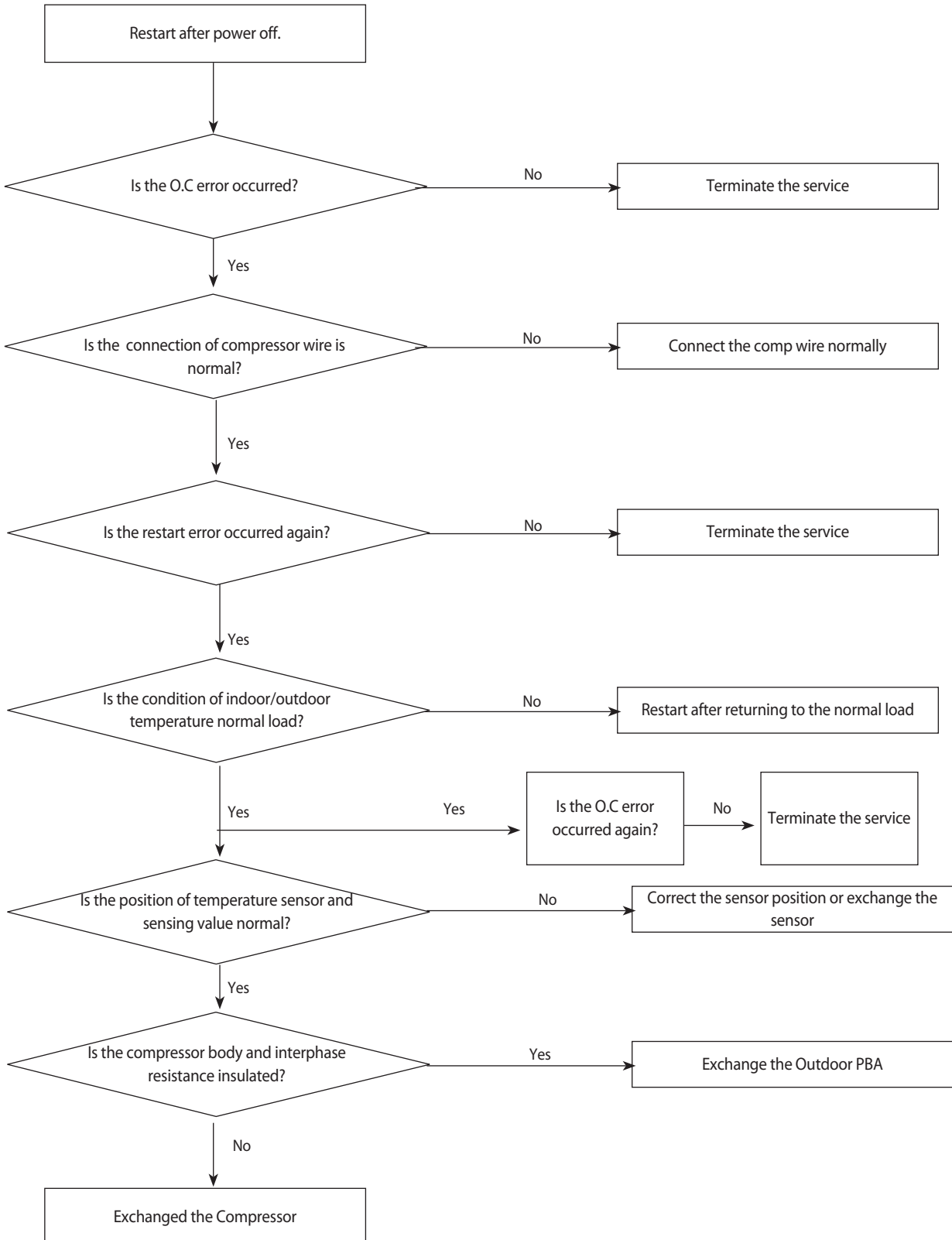

4-4-10 DC_link voltage sensor error

1. Checklist :

- 1) Is the input voltage of outdoor terminal block is normal?
- 2) Is the reactor wire connected?
- 3) Is the DC_link capacitor(PF2:CE101,CE102,CE103,PF3:CE001,CE002,CE003,CE004) assembled in accordance the specification?

(Outdoor PBA)

- 4) Is the DC_link resistor(PF2:R104,R106,R107,R108,PF3:R004,R005,R006,R007) value is normal? (Outdoor PBA)

2. Troubleshooting procedure

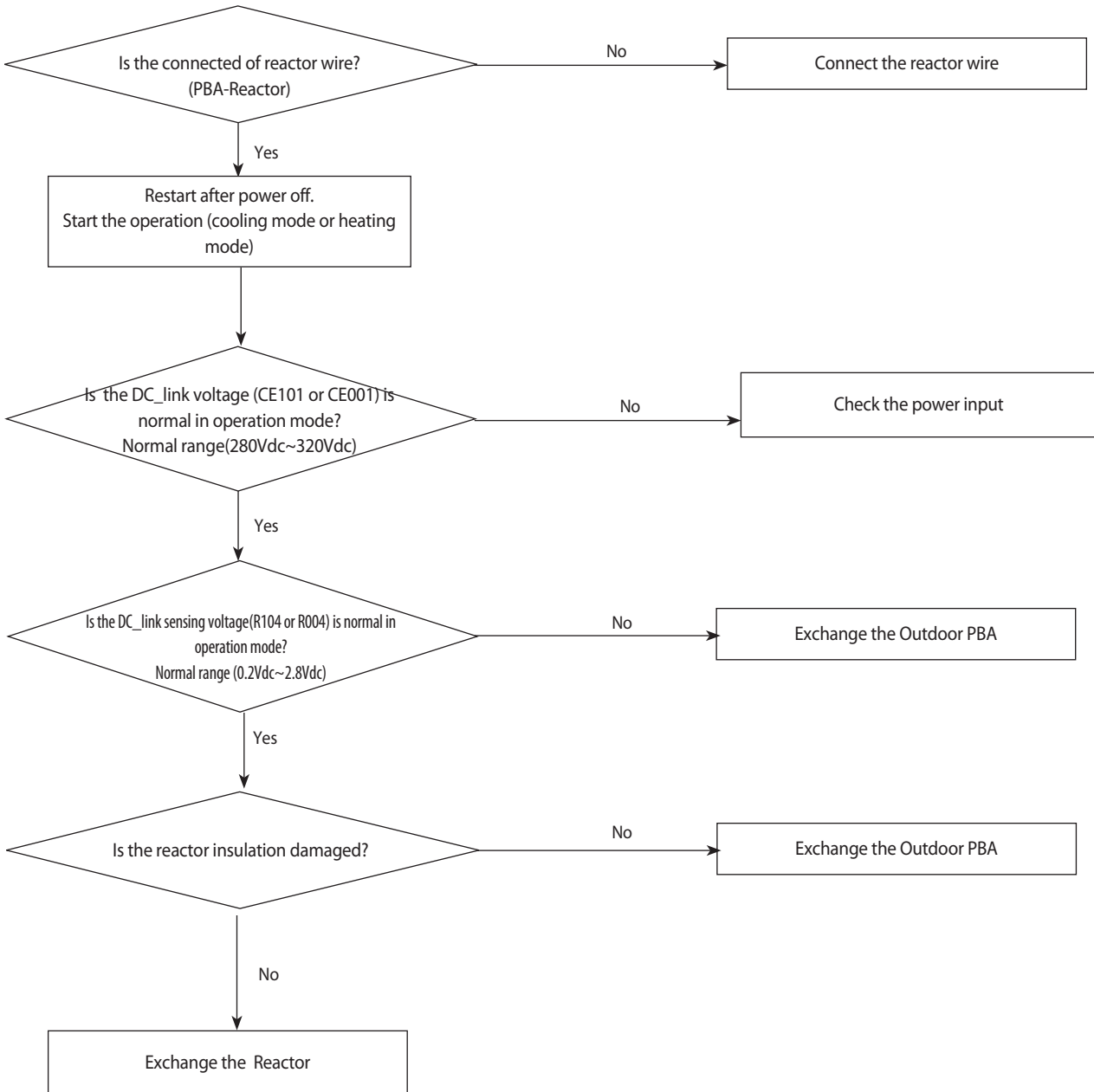

4-4-11 DC_link voltage under/over error, Over voltage protection error/PFC over load

1. Checklist :

- 1) Is the input voltage of outdoor terminal block is normal?
- 2) Is the reactor wire connected?
- 3) Is the reactor wire connected?
- 4) **Is the DC_link capacitor(PF2:CE101,CE102,CE103,PF3:CE001,CE002,CE003,CE004) assembled in accordance the specification? (Outdoor PBA)**
- 5) Is the DC_link resistor(PF2:R104,R106,R107,R108,PF3:R004,R005,R006,R007) value is normal? (Outdoor PBA)

2. Troubleshooting procedure

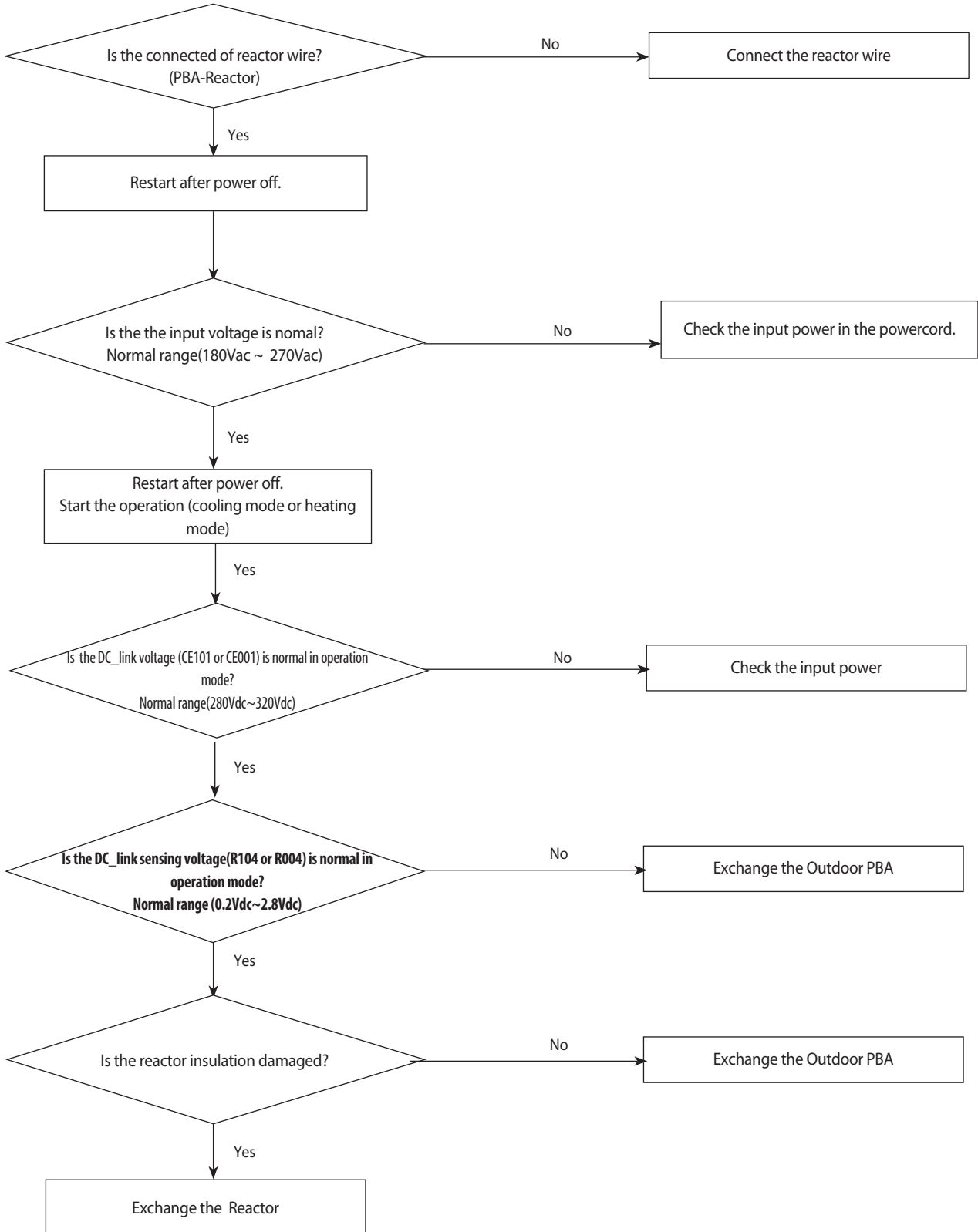

4-4-12 DC_link voltage sensor error

1. Checklist :

- 1) Is the PFC Shunt(PF2:R062,R063,PF3:R807,R808,R809) resistance value correct? Check the resistor is opened
- 2) Is the condition of surrounding temperature abnormal overload?
- 3) Is there any problem as like the temperature sensor separation or measurement value error?
- 4) Is the interphase resistance of compressor normal?

2. Troubleshooting procedure

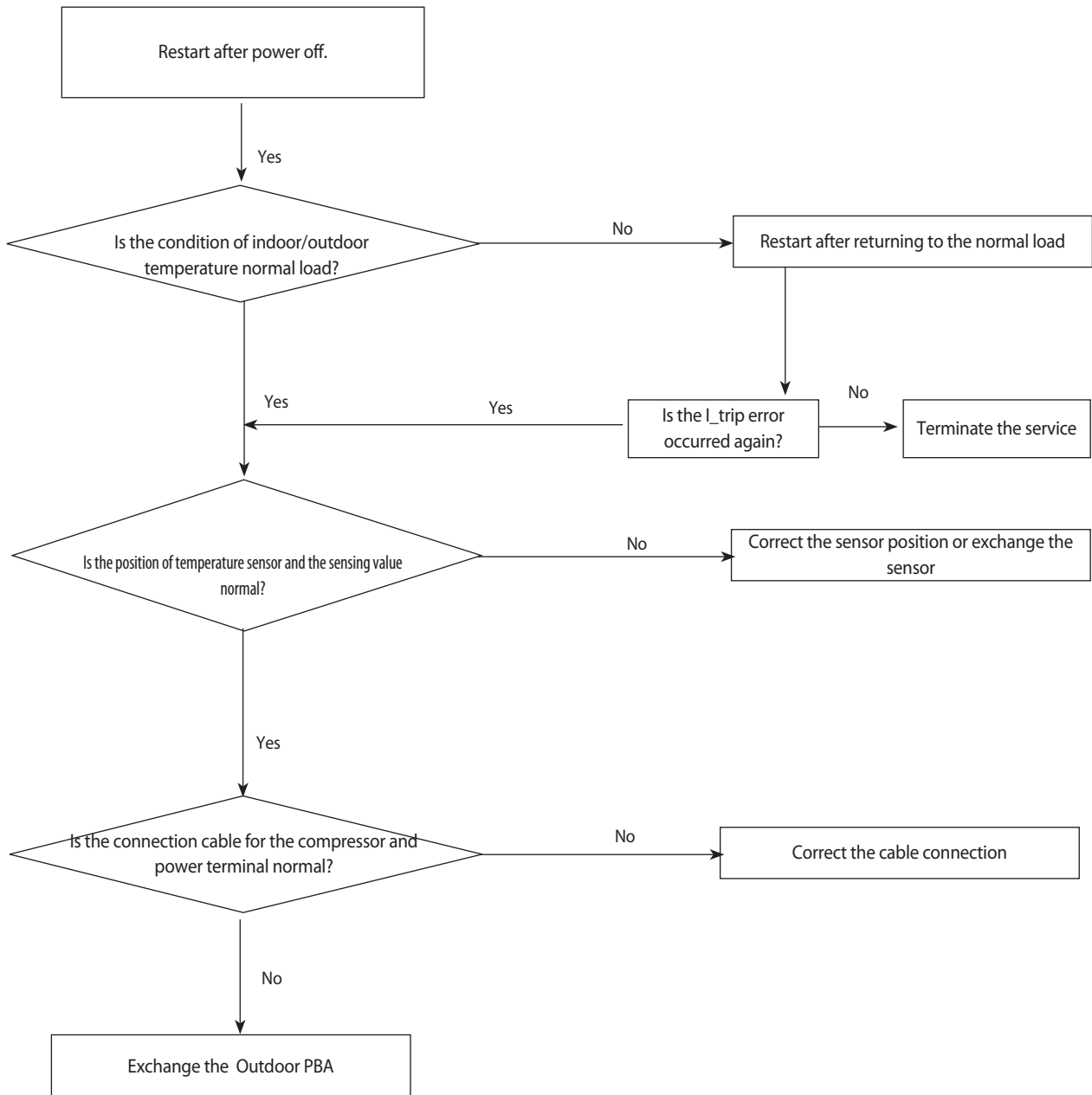

4-4-13 Current sensor error/Input current sensor error

1. Checklist :

- 1) Is the PFC Shunt(PF2:R062,R063,PF3:R807,R808,R809) resistance value correct? Check the resistor is opened
- 2) Is the IPM Shunt(PF2:R451,R452,R453,PF23:R413,R414,R415) resistance value correct? Check the resistor is opened
- 3) Is there no short or open around IC451(PF2) or IC451,IC452(PF3)?

2. Troubleshooting procedure

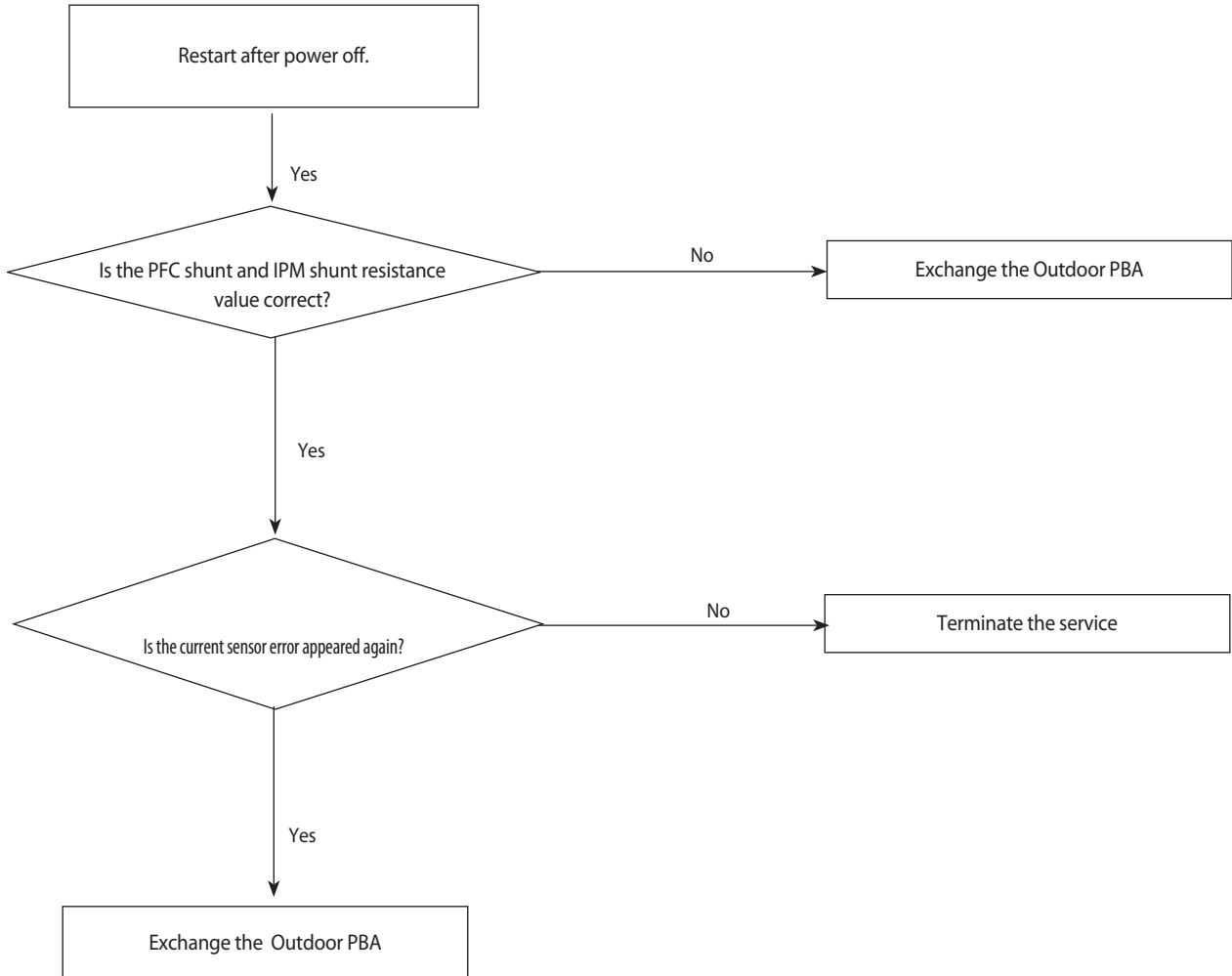

4-4-14 Heatsink sensor error/Heatsink over heat

1. Checklist :

- 1) Are there screws assembly in PBA-heatsink?
- 2) Is the gap PBA-heatsink
- 3) Is the fan operation normal?
- 4) Is the cover assembly in control-box normal?

2. Troubleshooting procedure

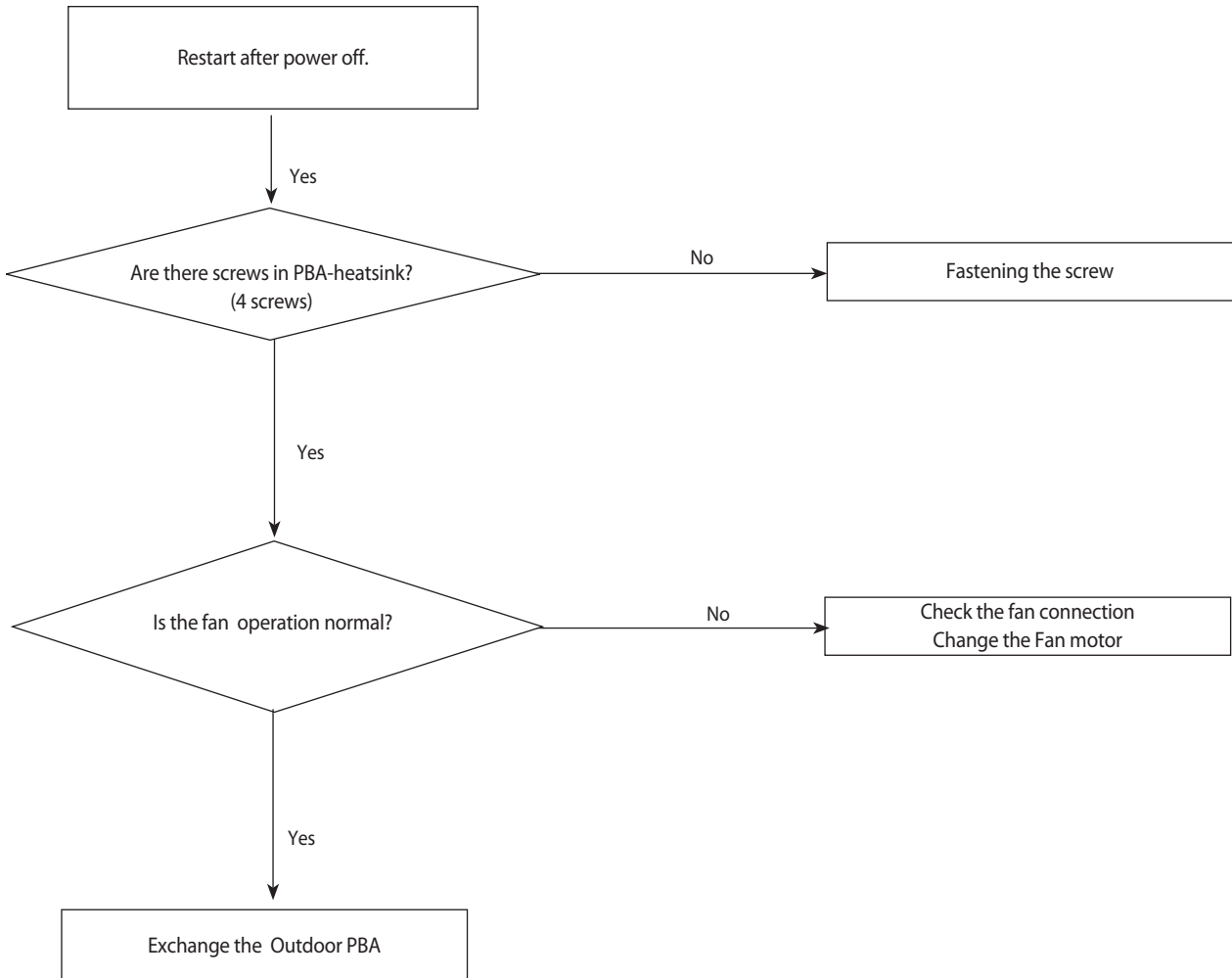

4-4-15 Comp Vlimit error/Comp current limit error

1. Checklist :

- 1) Is the PFC Shunt(PF2:R062,R063,PF3:R807,R808,R809) resistance value correct? Check the resistor is opened
- 2) Is the condition of surrounding temperature abnormal overload?
- 3) Is there any problem as like the temperature sensor separation or measurement value error?
- 4) Is the interphase resistance of compressor normal?

2. Troubleshooting procedure

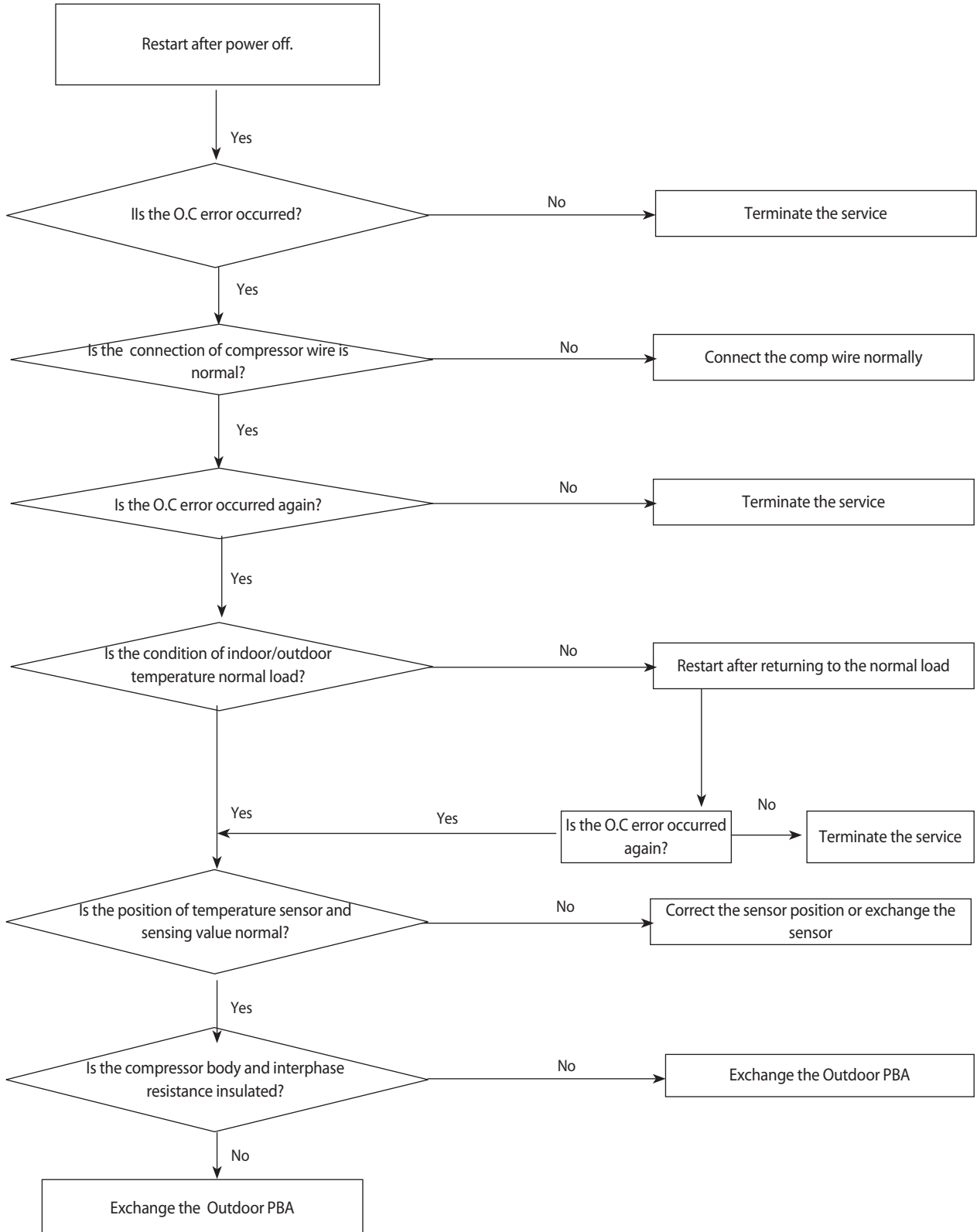

4-4-16 EEPROM error/OTP error

1. Checklist :

- 1) Is there a short around micom?
- 2) Is there a short around IC202(PF2) or IC701(PF3)?
- 3) Did you download or insert EEPROM IC, after changing outdoor PBA?

2. Troubleshooting procedure

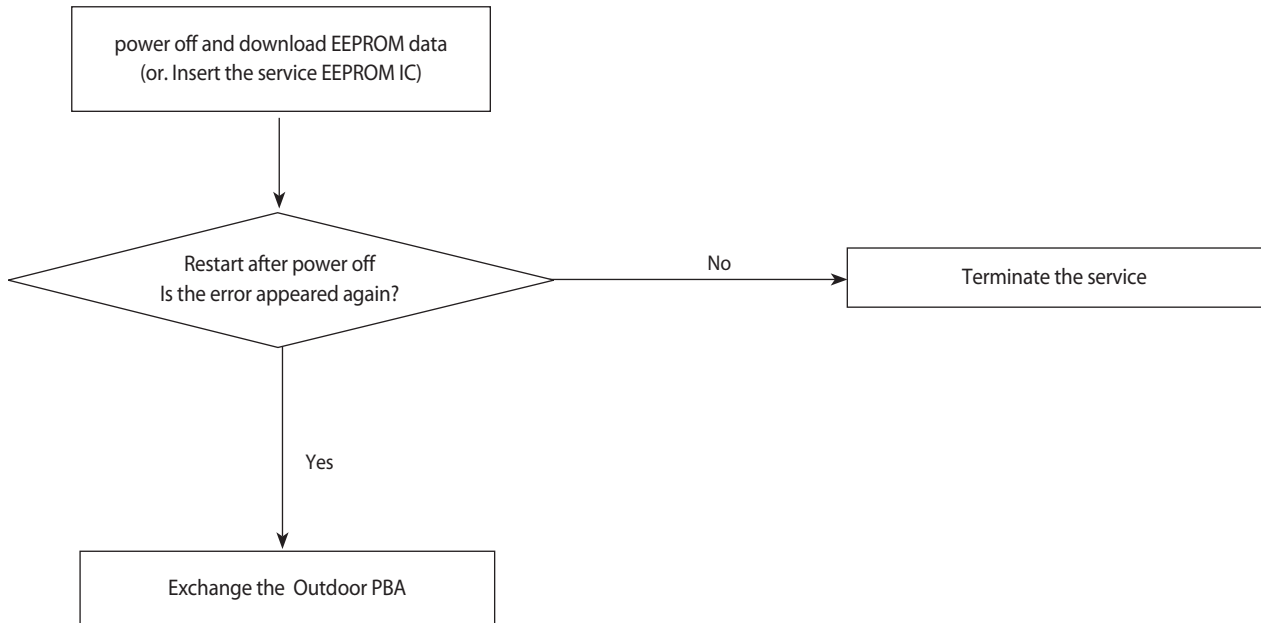

4-4-17 AC zero cross signal error

1. Checklist :

- 1) Check the power condition at customer's house (Is there any power noise?)
- 2) Have been there power failure?

2. Troubleshooting procedure

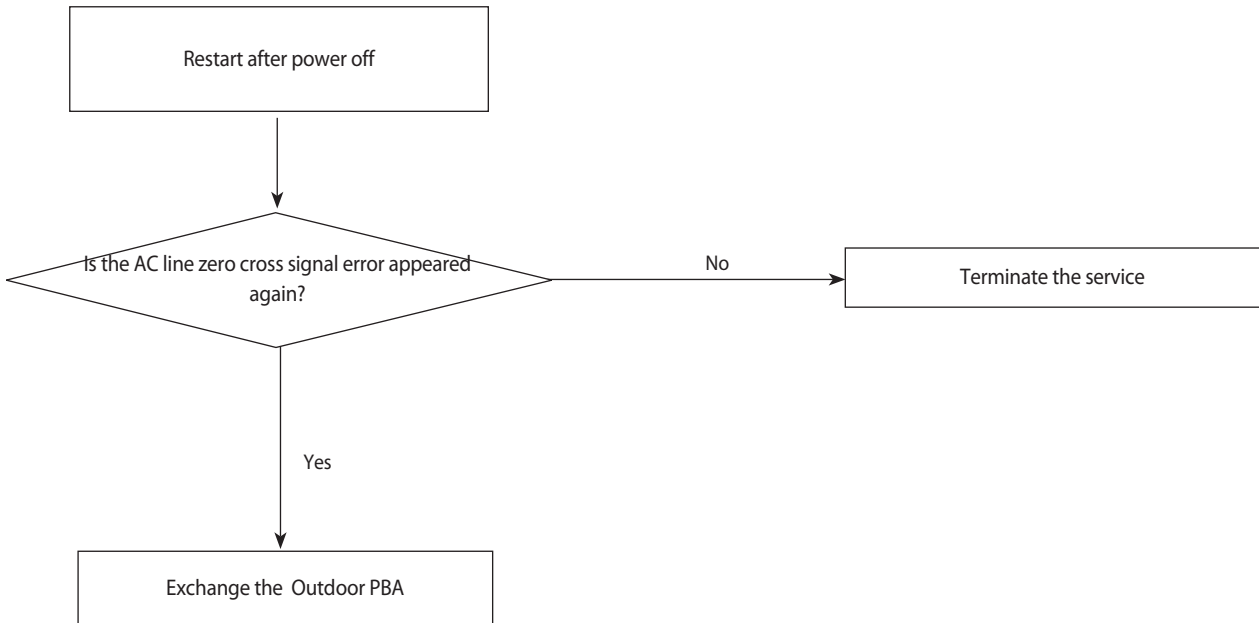

4-4-18 Operation condition secession error

1. Checklist :

- 1) Check the temperature around the outdoor unit.

2. Troubleshooting procedure

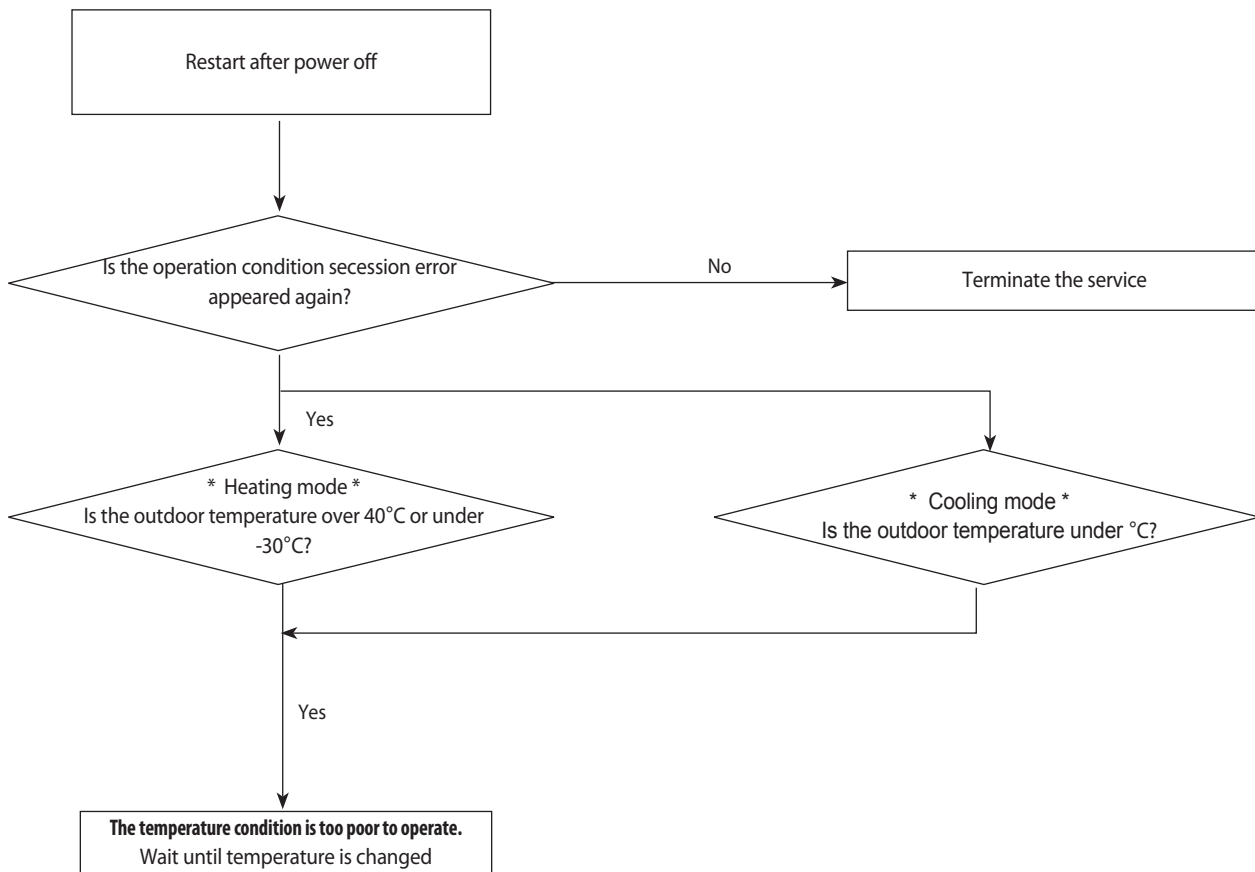

4-4-19 Capacity miss match error

1. Checklist :

- 1) Check the Btu between indoor and outdoor unit
- 2) Check the indoor unit option and outdoor unit EEPROM data

2. Troubleshooting procedure

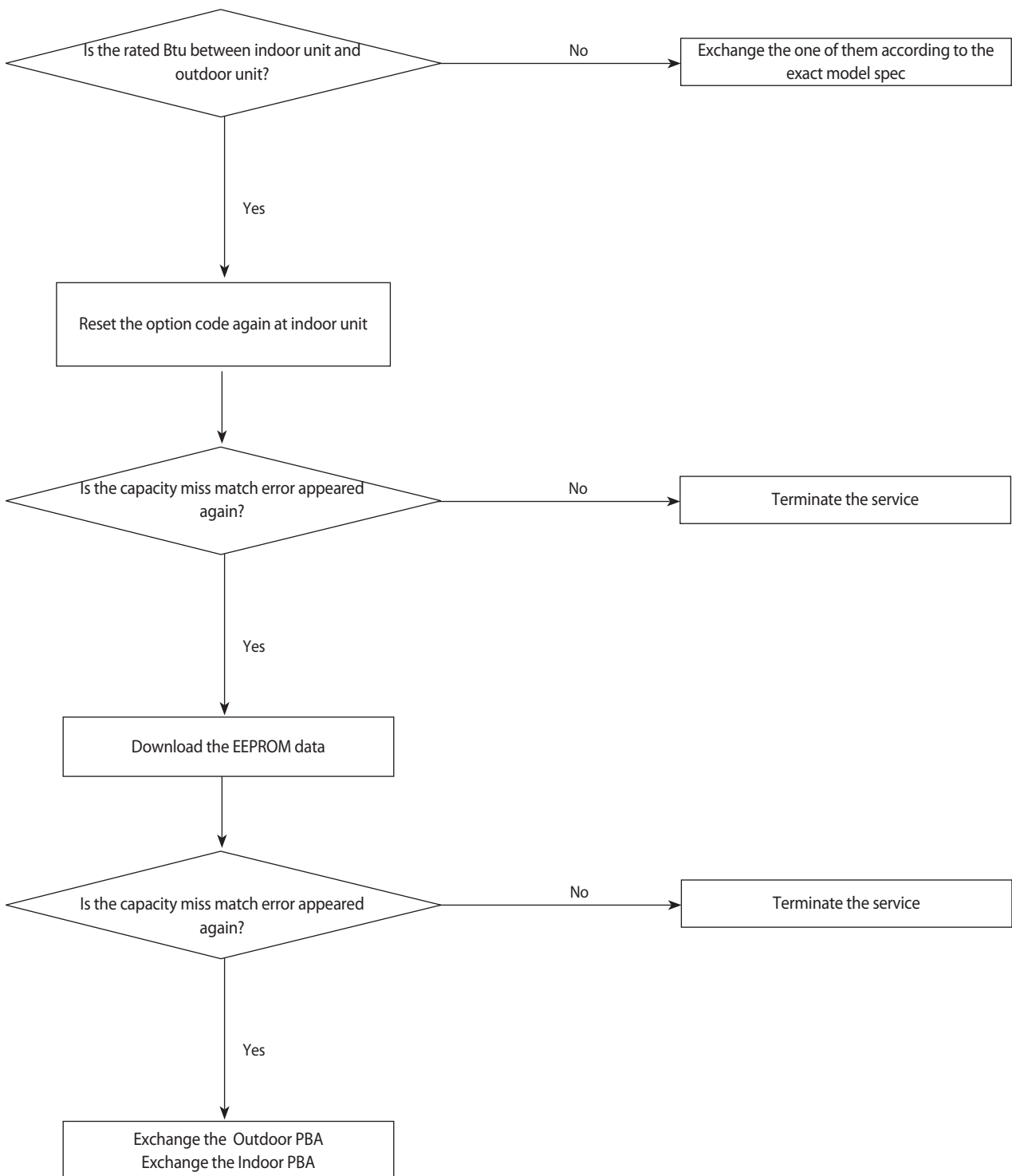

4-4-20 Gas leak error

1. Checklist :

- 1) Is the position of indoor Eva_in sensor normal?
- 2) Check the pipe crack
- 3) Check the EEV valve connection in Outdoor unit
- 4) Check the refrigerant was charged

2. Troubleshooting procedure

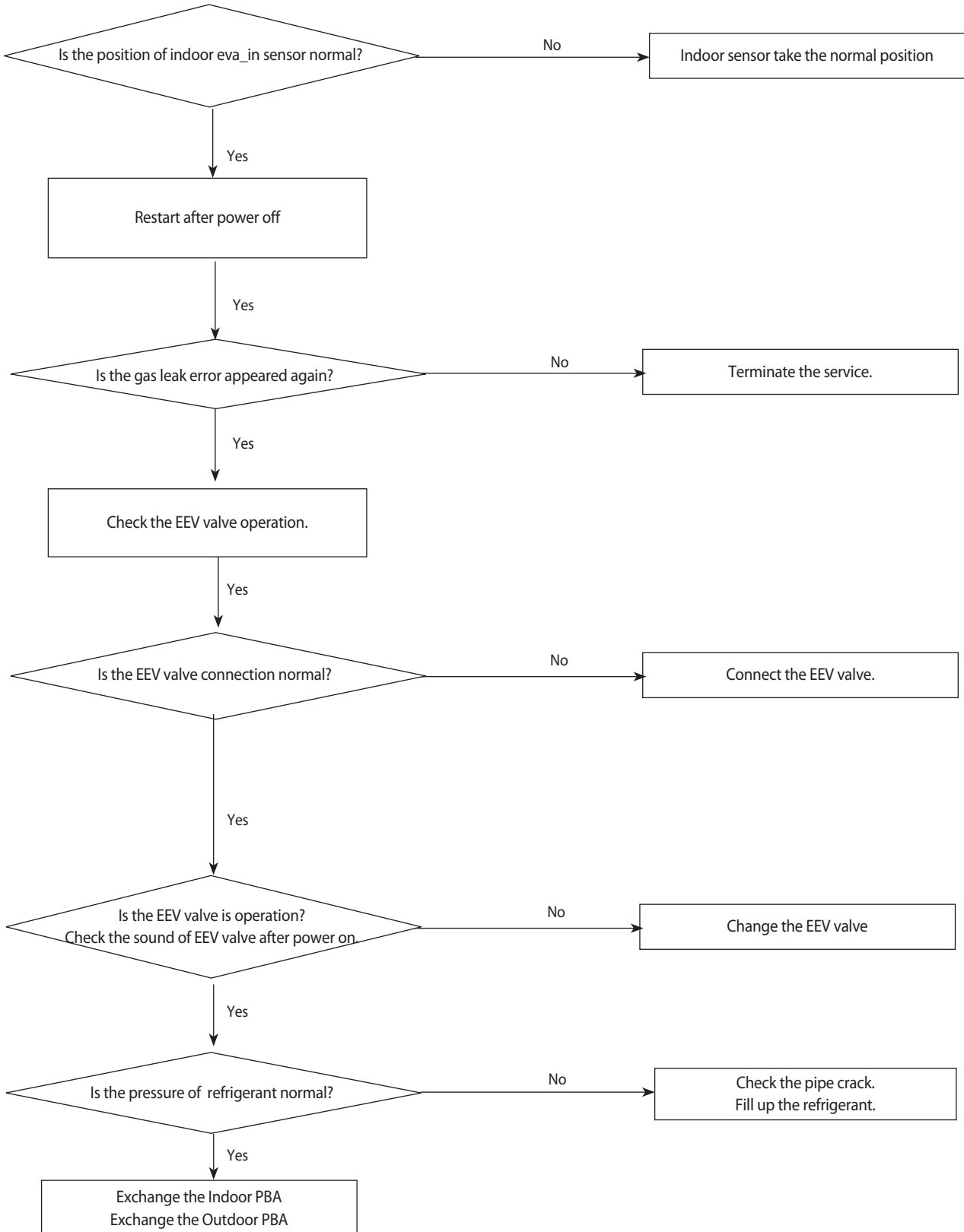

4-4-21 MDS Error Flow chart

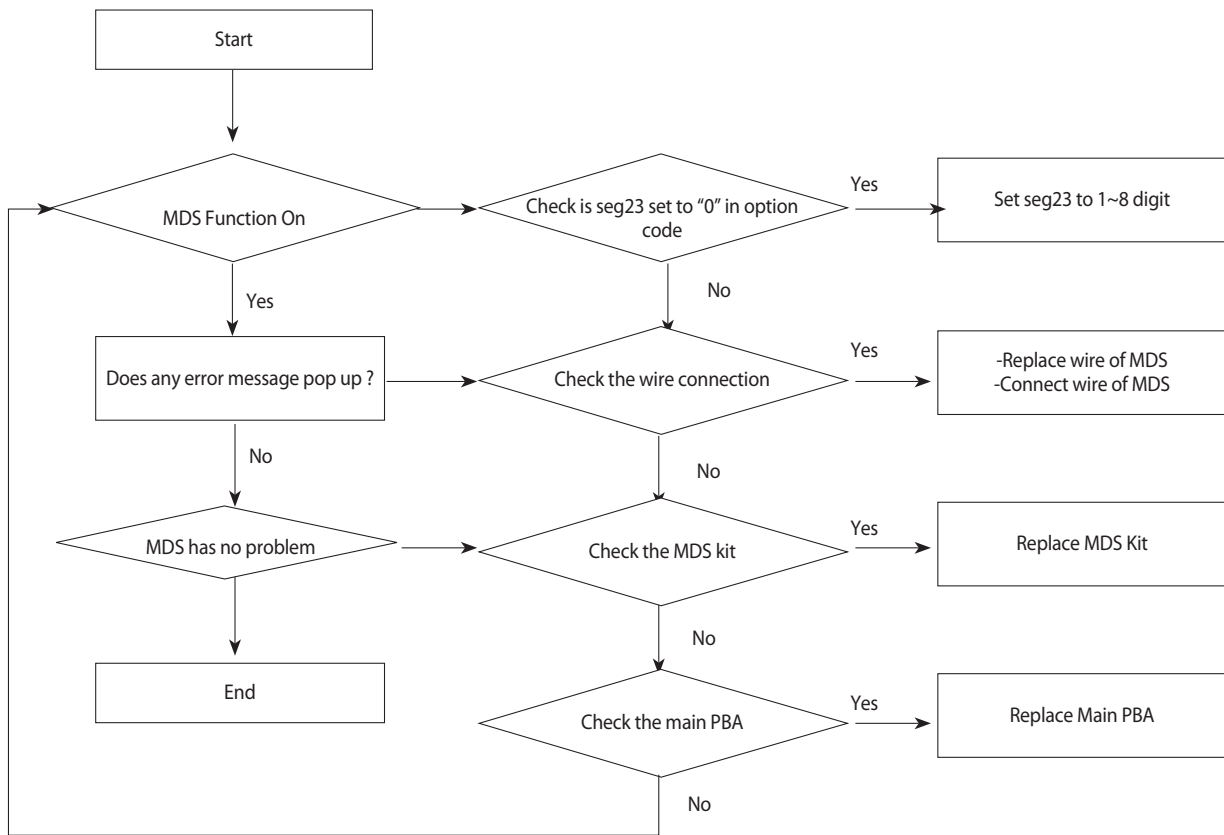

■MDS Function only can be set in wired remote controller or central controller.

■Error Message(Error message will be appeared after 3minutes)

-Wired remote controller: "E143" message is pop up.

-Display Panel: Operation & filter LED is blinking at the same time,after indoor unit is power off.

5. PCB Diagram

5-1 Indoor Unit

5-1-1 MAIN PBA

■ AC026MNNDKH / AC035MNNDKH / AC052MNNDKH / AC060MNNDKH / AC071MNNDKH

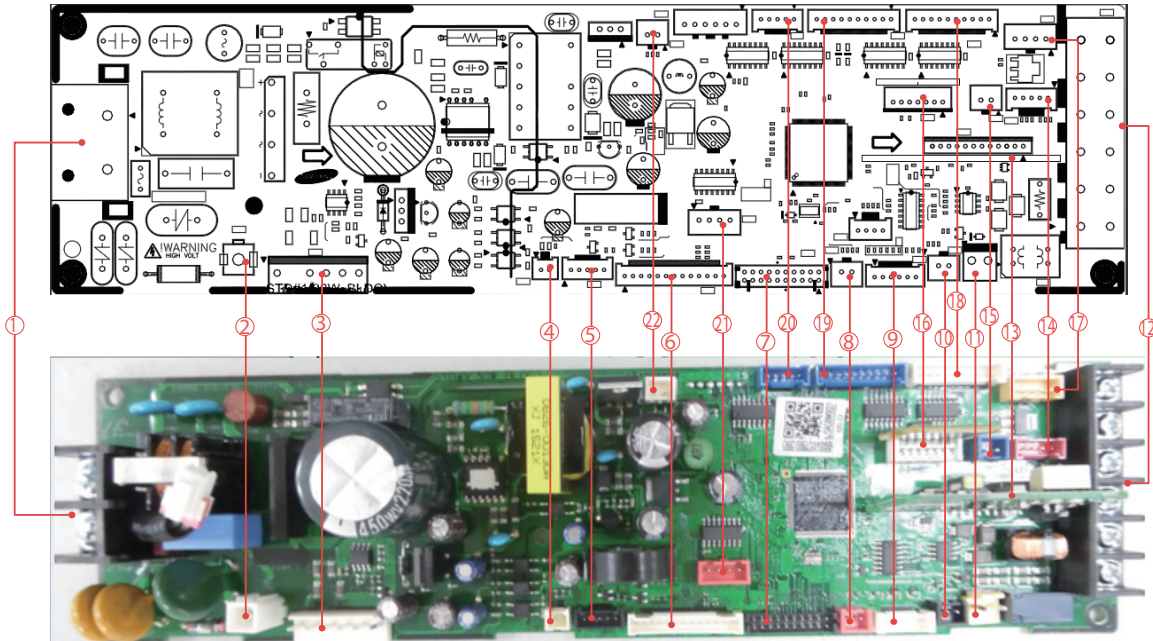

1	TB101	INPUT POWER	
2	CN101	GVD	YDW236-01(WHT)
3	CN701	BLDC FAN MOTOR	YW396-06V(WHT)
4	CN140	FUSE CHECK	SMW200-02(WHT)
5	CN809	AUTO GRILLE	SMW200-05(BLK)
6	CN501	DISPLAY	SMY200-13(WHT)
7	CN301	DOWNLOAD	YDW200-20(BLK)
8	CN83	EXTERNAL SIGNAL	SMW250-02(RED)
9	CN413	EVEA IN/OUT/DIS	SMW200-06(NTR)
10	CN411	FL-SW	SME250-02(BLK)
11	CN103	DRAIN PUMP	YW396-02V(YEL)
12	TE04	COM1 12V COM2	DAPC-2009-6P
13	CN311	2WIRE OPTION	BMW200-12(wht)
14	CN401	HUMAN SENSOR	SMW200-05(RED)
15	CN804	VENTILATOR	SMW250-02(BLU)
16	CN201	EEPROM PBA CONNECTOR	B7P-MQ(WHT)
17	CN801	SPI MODULE	SMW250-04(YEL)
18	CN805	LOUVER 1/2	SMW200-10(NTR)
19	CN806	LOUVER 3/4	SMW200-10P(BLU)
20	CN807	LOUVER 5	SMW200-05(BLU)
21	CN81	EXT_CTRL	SMW250-04(RED)
22	CN412	ROOM SENSOR	SMW250-02(WHT)

5-1-2 Display PBA

■ AC026MNNDKH / AC035MNNDKH / AC052MNNDKH / AC060MNNDKH / AC071MNNDKH

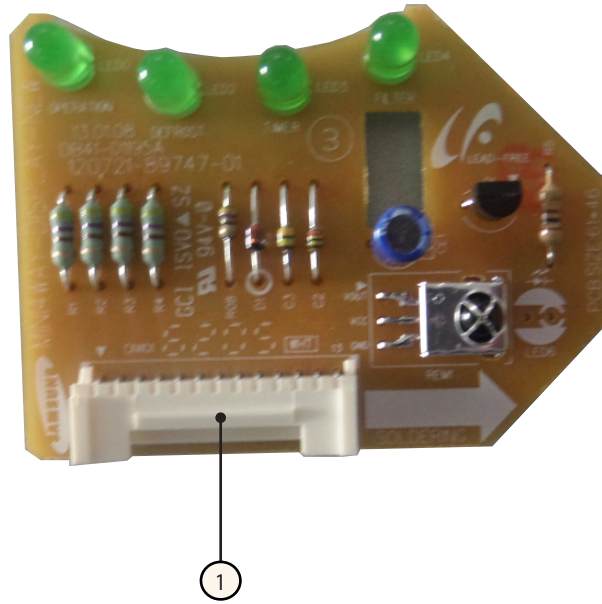

No.	Function
1	MAIN PBA connection (LED, Remote control signal, DC5V,12V)

5-2 Outdoor Unit

5-2-1 MAIN PBA

■ AC026MXADKH / AC035MXADKH

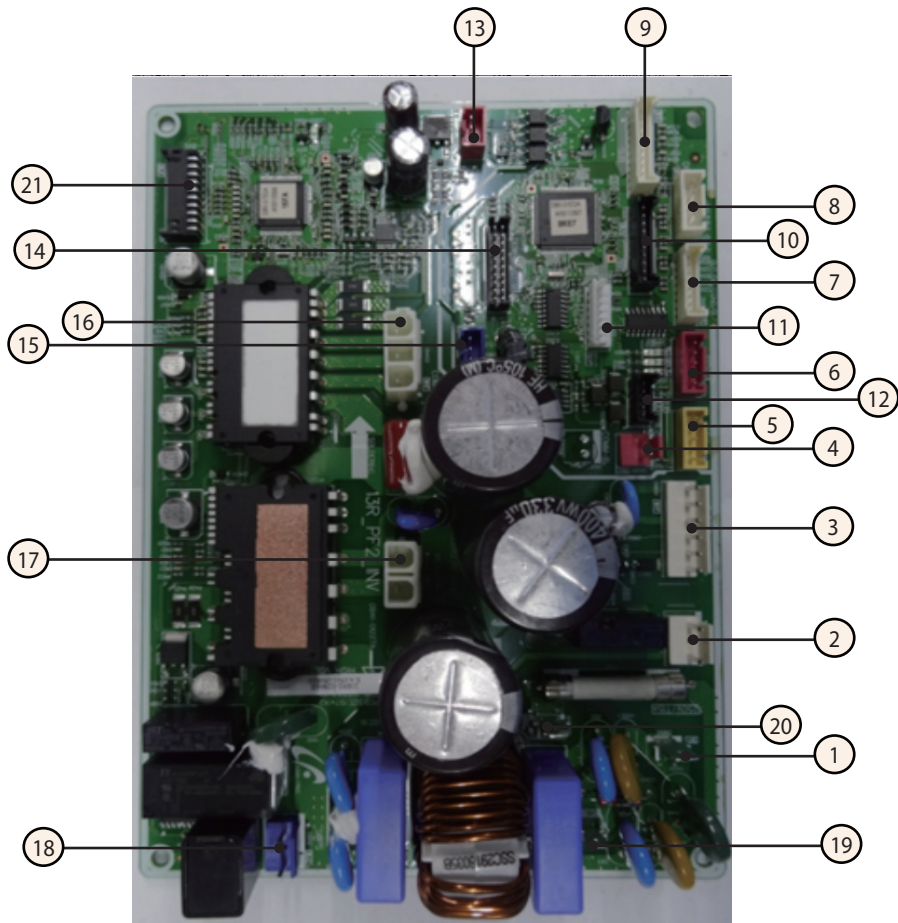

No.	Function	No.	Function
1	MAIN POWER (N)	12	Sub display PCB connection (DC5V,12V,com1,com2)
2	4Way Valve	13	SMPS PCB connection (DC15V)
3	FAN MOTOR connection	14	Download Main
4	Indoor communication connection	15	SMPS PCB connection (DC5V,12V)
5	EEV-B	16	Compressor connection (U,V,W)
6	EEV-A	17	Reactor
7	Out/Discharge/Cond./OLP temp. sensor	18	SMPS PCB connection (AC220V)
8	DRED PBA connection (* DRED : Demand Response Enabling Device)	19	EARTH
9	Sub display PCB connection (Key, 7-segment signal)	20	MAIN POWER (L)
10	Sub display PCB connection (Key, solution communication signal)	21	Download INV
11	EEPROM connection		

■ AC052MXADKH / AC060MXADKH / AC071MXADKH

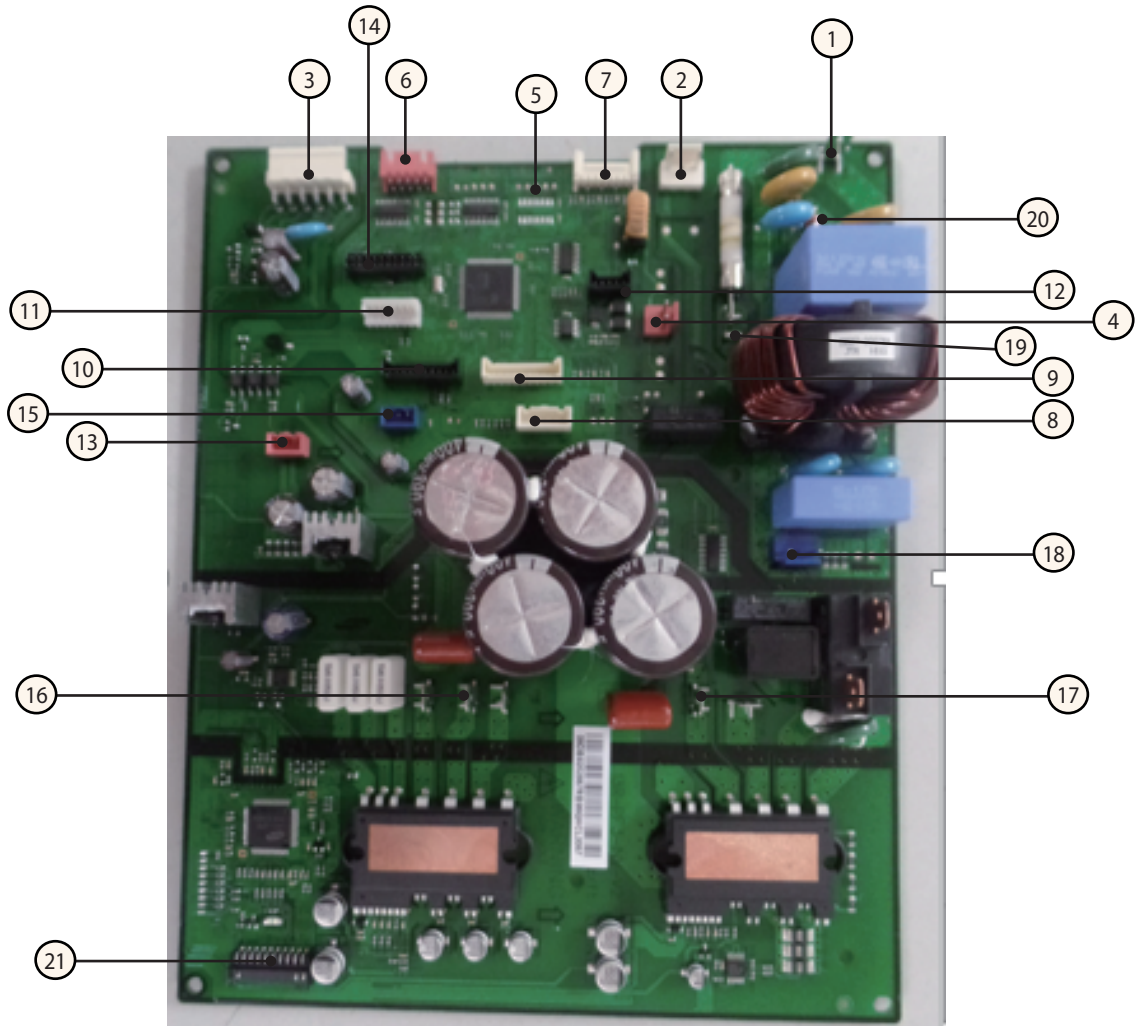

No.	Function	No.	Function
1	MAIN POWER (N)	12	Sub display PCB connection (DC5V,12V,com1,com2)
2	4Way Valve	13	SMPS PCB connection (DC15V)
3	FAN MOTOR connection	14	Download Main
4	Indoor communication connection	15	SMPS PCB connection (DC5V,12V)
5	N/A	16	Compressor connection (U,V,W)
6	EEV control	17	Reactor
7	Out/Discharge/Cond./OLP temp. sensor	18	SMPS PCB connection (AC220V)
8	DRED PBA connection (* DRED : Demand Response Enabling Device)	19	MAIN POWER (L)
9	Sub display PCB connection (Key, 7-segment signal)	20	EARTH
10	Sub display PCB connection (Key, solution communication signal)	21	Download INV
11	EEPROM connection		

5-2-2 Display PBA

■ AC026MXADKH / AC035MXADKH / AC052MXADKH / AC060MXADKH / AC071MXADKH

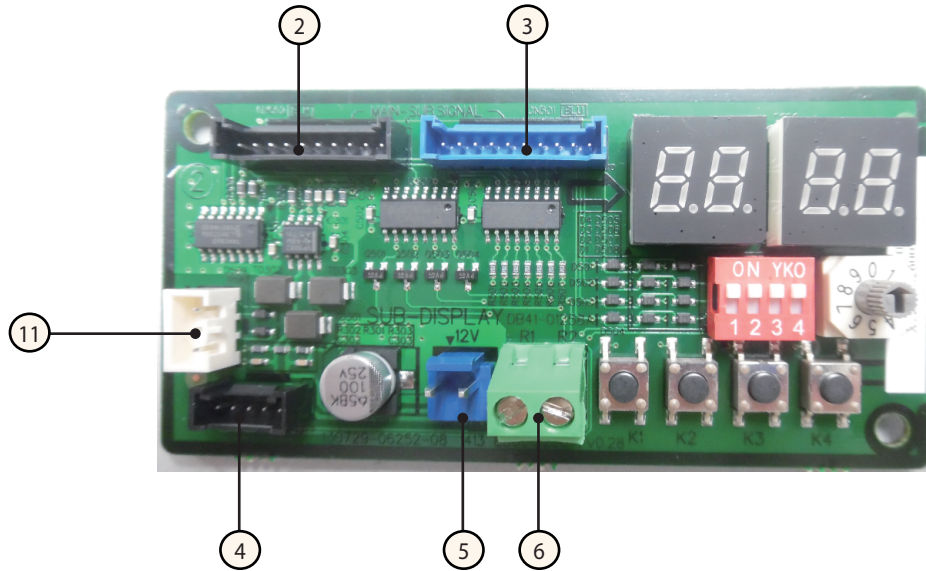

No.	Function
1	MODE SELECTOR
2	MAIN PCB connection (Key, Switch signal)
3	MAIN PCB connection (Key, 7-segment signal)
4	MAIN PCB connection (DC 5V,12V)
5	DC 12V
6	Solution communication

6. Wiring Diagram

6-1 Indoor Unit

■ AC026MNNDKH / AC035MNNDKH / AC052MNNDKH / AC060MNNDKH / AC071MNNDKH

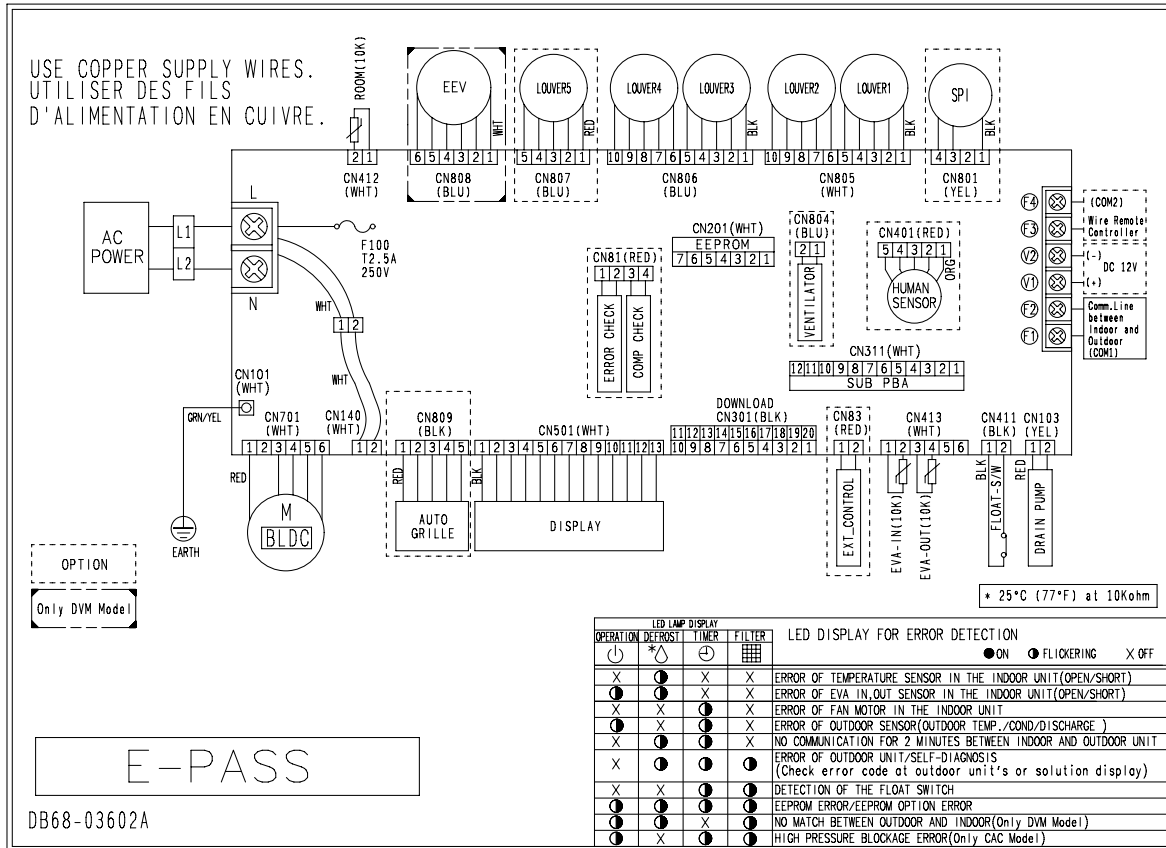

This Document can not be used without Samsung's authorization.

6-2 Outdoor Unit

■ AC026MXADKH / AC035MXADKH

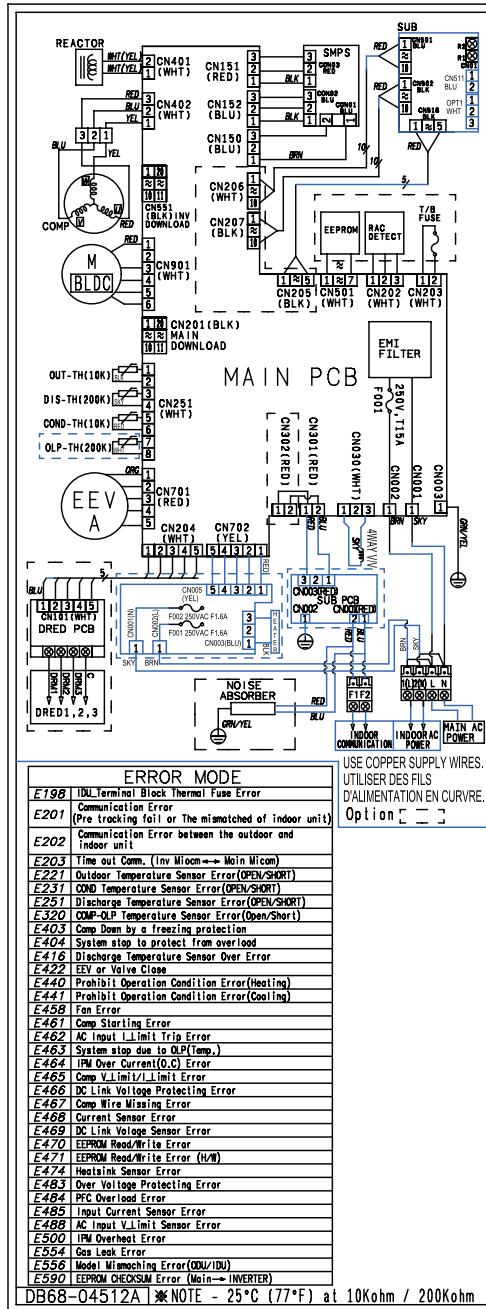

This Document can not be used without Samsung's authorization.

■ AC052MXADKH / AC060MXADKH / AC071MXADKH

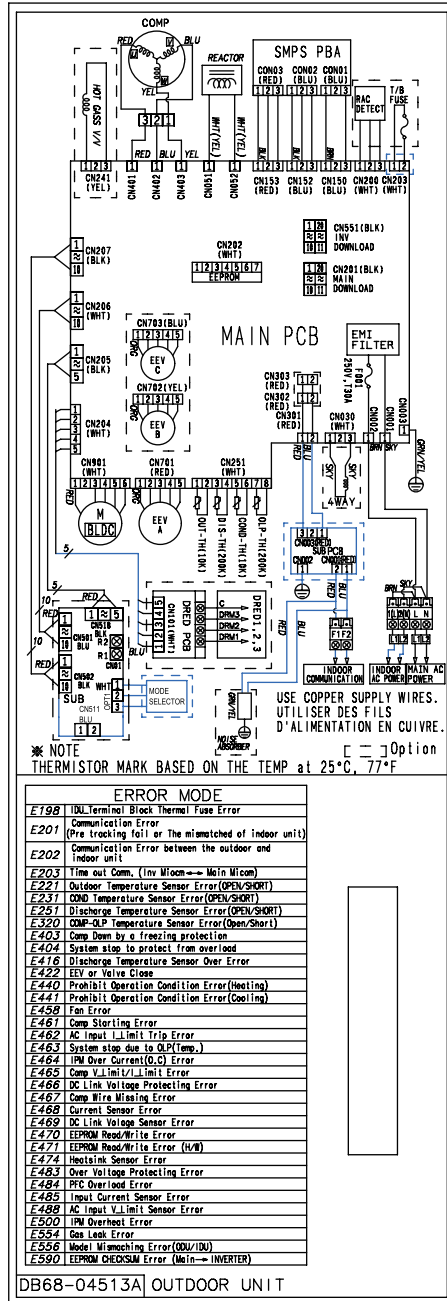

This Document can not be used without Samsung's authorization.

7. Preference Sheet

7-1 Index of Model Name

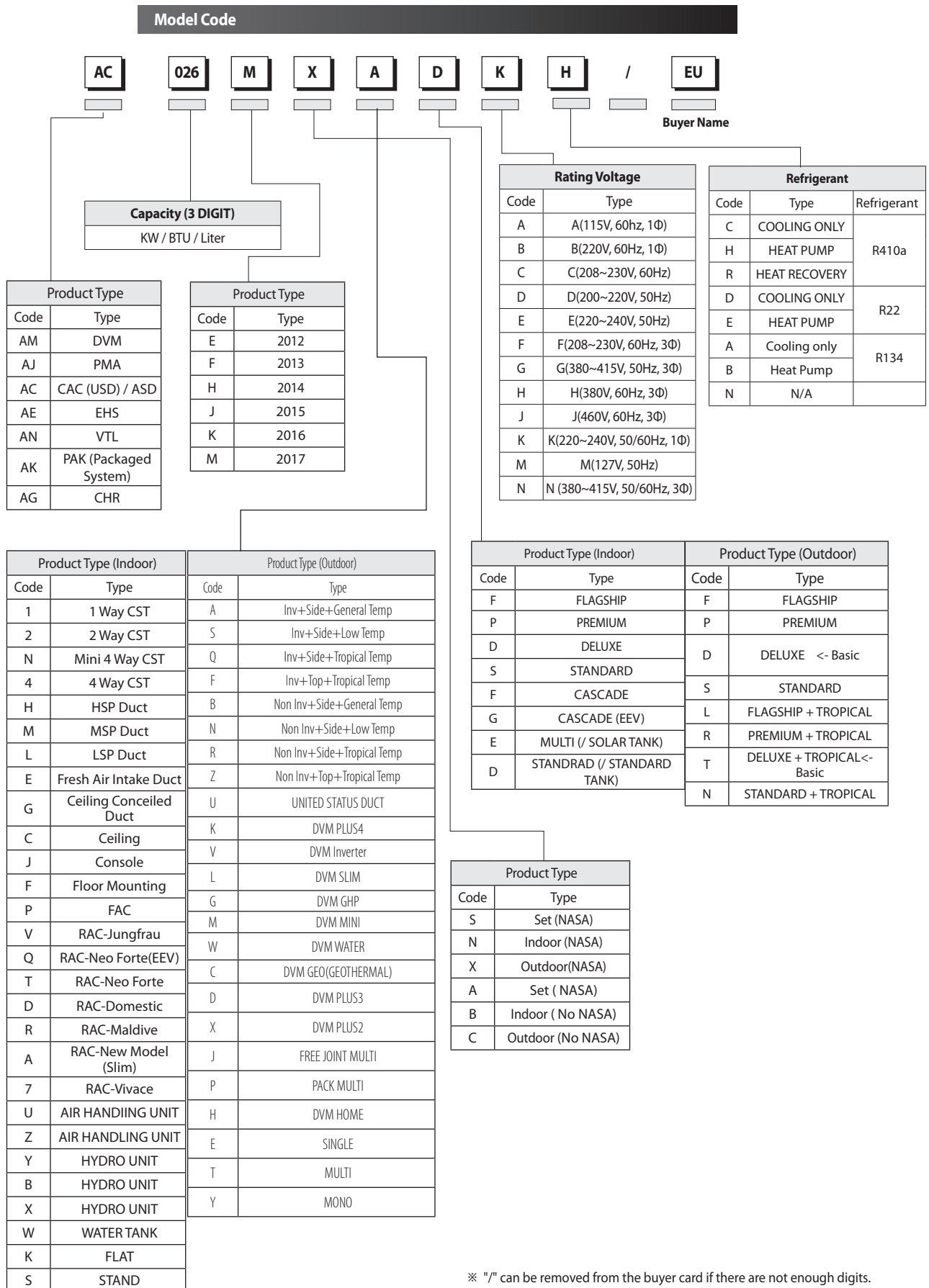

Index for Model Name (cont.)

Panel

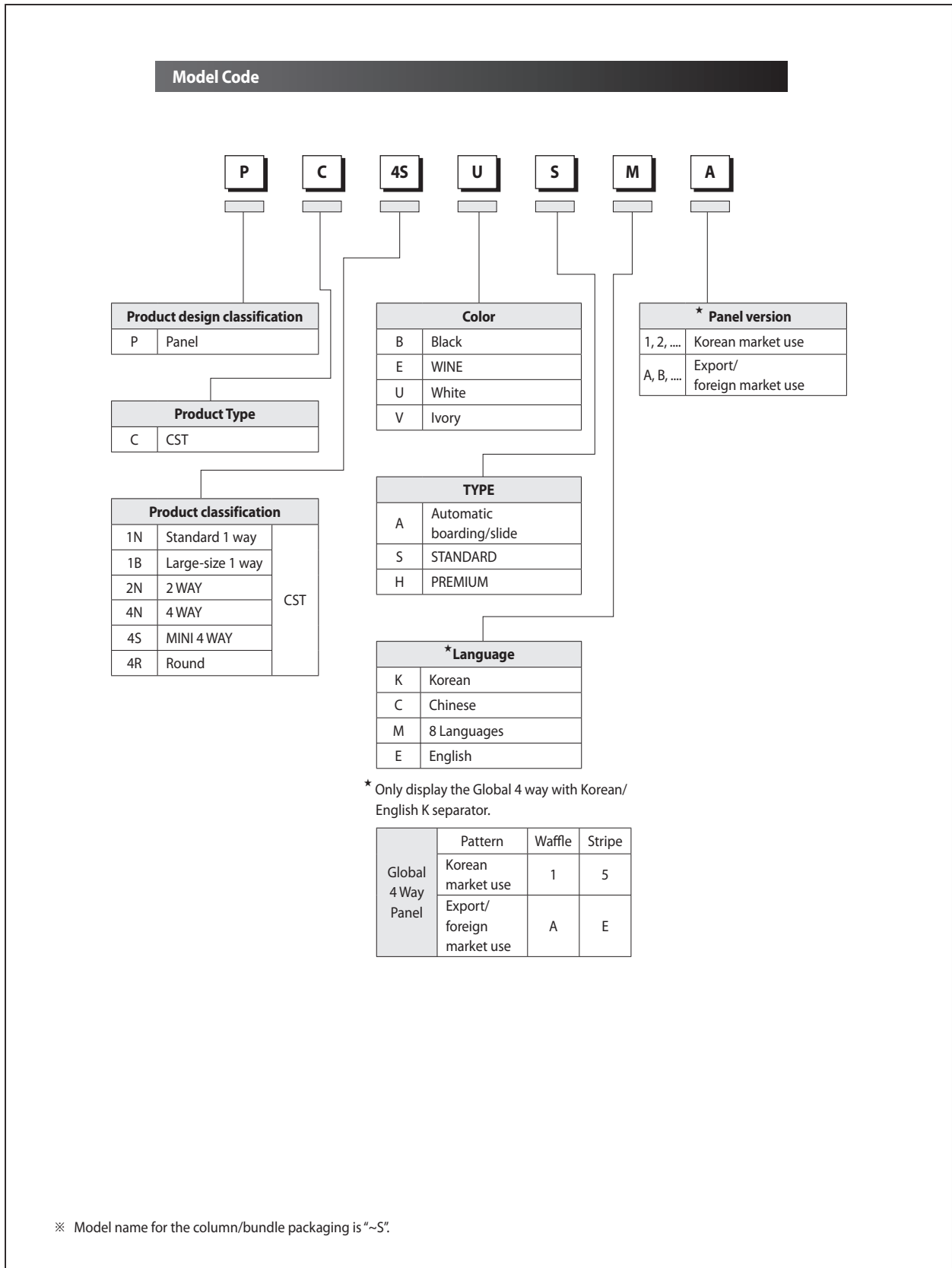

7-2 Refrigerating Cycle Diagram

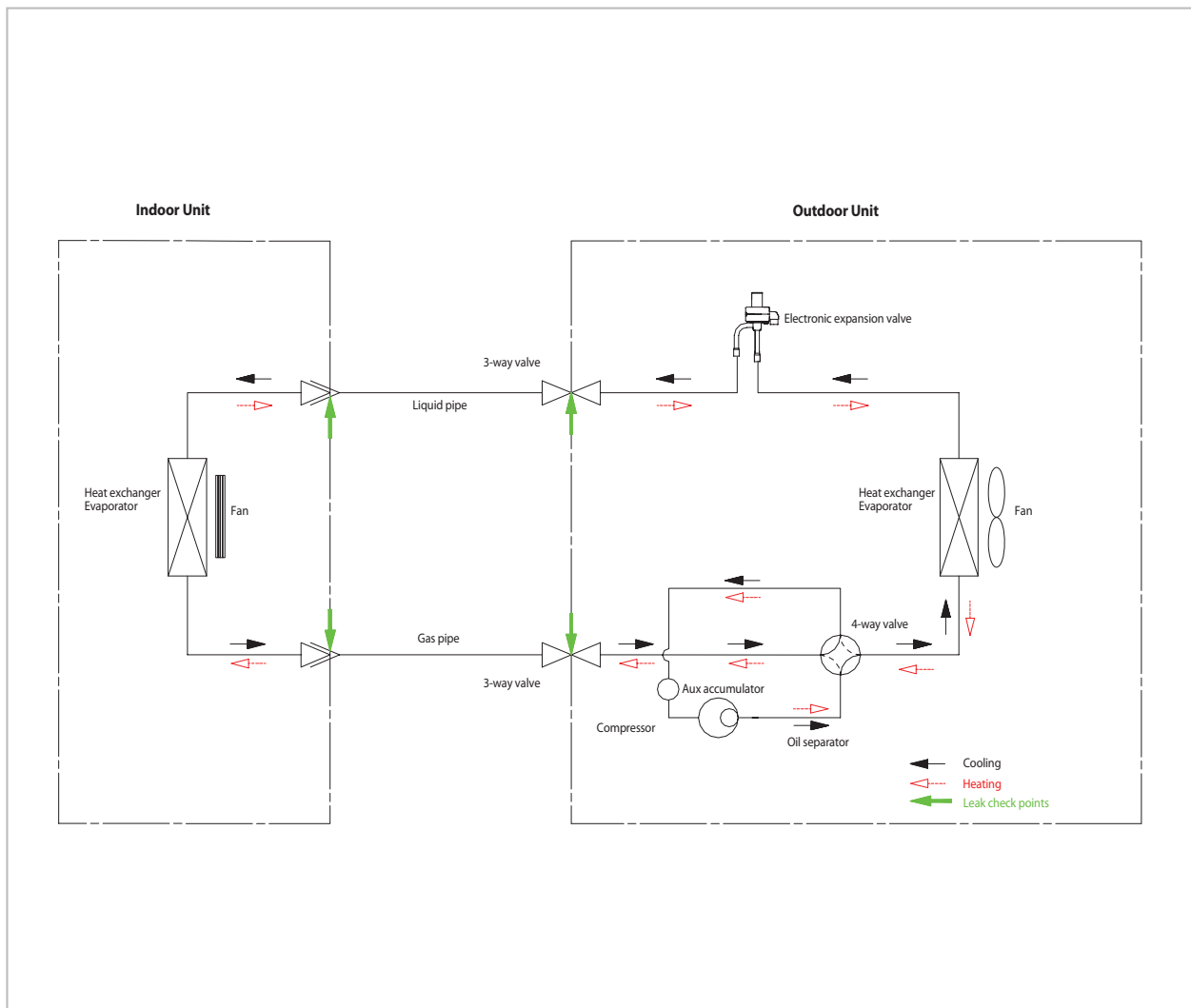

■ CONDENSER

High temperature and high pressure gas state coolant discharged from the compressor is converted to a liquid state as it is cooled down by the heat emission in the outdoor condenser unit, and sent to the evaporator.

■ COMPRESSOR

Low temperature and low pressure coolant is compressed and sent to the cycling system

■ EVAPORATOR

Liquid coolant sucked in through the capillary tubes cools down the room by absorbing the surrounding heat as it evaporates (converting from liquid to gas). (Absorbing heat required for evaporation)

■ SERVICE VALVE

You can open the valve by turning the need valve counterclockwise using hex wrench, and it is used for vacuum, gas purging, coolant injection, coolant purging, and indoor-outdoor unit connection.

■ ACCUMULATOR

Accumulator prevents the flow of liquid-state coolant into the compressor. (Liquid-state coolant flowing into the compressor will overload the compressor.)

7-3 Pressure Graph

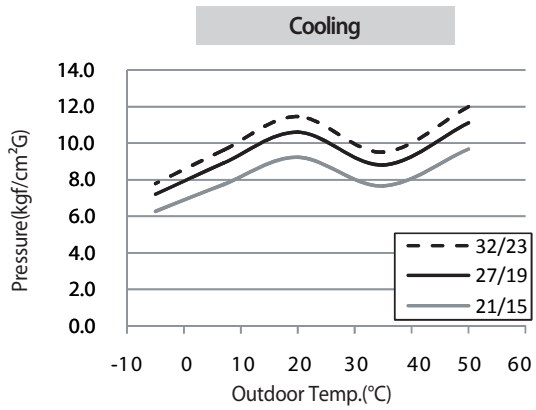

* Cooling

Outdoor(°C)	Indoor (°C)		
	32/23	27/19	21/15
50	12.0	11.1	9.7
35	9.5	8.8	7.7
20	11.4	10.6	9.2
7	9.6	8.9	7.7
-5	7.8	7.2	6.3

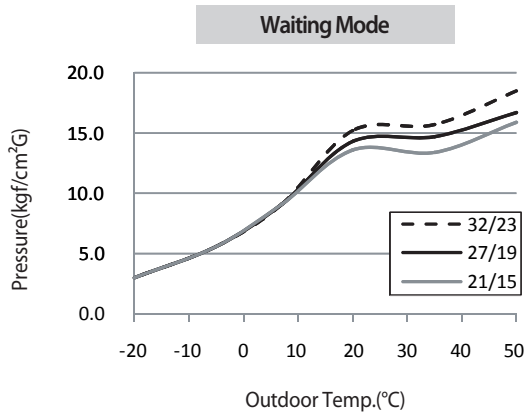

* Waiting Mode

Outdoor(°C)	Indoor (°C)		
	32/23	27/19	21/15
50	18.5	16.7	15.9
35	15.7	14.7	13.4
20	15.2	14.3	13.6
7	9.1	9.1	9.1
-5	5.6	5.6	5.6
-20	3.0	3.0	3.0

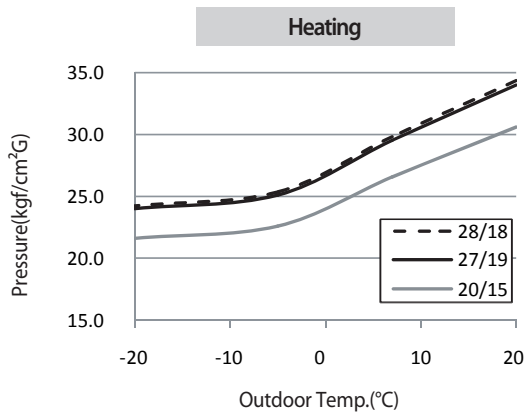

* Heating

Outdoor(°C)	Indoor (°C)		
	28/18	27/19	20/15
20	34.3	34.0	30.6
7	29.8	29.5	26.6
-5	25.4	25.1	22.6
-20	24.2	24.0	21.6

SAMSUNG

This Service Manual is a property of Samsung Electronics Co., Ltd.
Any unauthorized use of Manual can be punished under applicable
International and/or domestic law.

© Samsung Electronics Co., Ltd. Oct. 2016.
Printed in China.