

SAMSUNG

SYSTEM AIR CONDITIONER

CIRCULAR CASSETTE SERIES

INDOOR UNIT

AC071MN4PKH
AC090MN4PKH
AC100MN4PKH
AC120MN4PKH
AC140MN4PKH

OUTDOOR UNIT

AC090MXADKH
AC100MXAD*H
AC120MXAD*H
AC140MXAD*H

SERVICE *Manual*

SYSTEM AIR CONDITIONER



CONTENTS

1. Precautions
2. Product Specifications
3. Disassembly and Reassembly
4. Troubleshooting
5. PCB Diagram
6. Wiring Diagram
7. Reference Sheet

Contents

1. Precautions	1-1
1-1. Precautions for the Service	1-1
1-2. Precautions related to static electricity and PL	1-1
1-3. Precautions related to product safety	1-2
1-4. Other precautions	1-2
2. Product Specifications	2-1
2-1. The Feature of Product	2-1
2-2. Product Specifications	2-2
2-3. Specifications of optional items	2-8
2-3-1. Accessories	2-8
2-3-2. Wireless remote controller (AR-KH00)	2-9
2-3-3. Wired remote controller (AWR-WE10N)	2-10
2-3-4. Filter specifications	2-11
3. Disassembly and Reassembly	3-1
3-1. Necessary Tools	3-1
3-2. Indoor Unit	3-2
3-3. Outdoor Unit	3-11
4. Troubleshooting	4-1
4-1. Setting an indoor unit address and installation option	4-1
4-1-1. The procedure of setting option	4-1
4-1-2. The procedure of setting option	4-2
4-1-3. Order for Setting Options (Wired Remote Controller)	4-12
4-1-4. Indoor address(MAIN/RMC)setting	4-13
4-1-5. Set the indoor installation options(Option to set for the installation site conditions)	4-14
4-1-6. Changing the addresses and options individually	4-15
4-2. Model-specific option code	4-16
4-3. Diagnostic Checklist ago	4-17
4-3-1. Test operation mode and check mode	4-17
4-3-2. Eco Mode [Power Save Mode]	4-18
4-3-3. Error code [indoor]	4-19
4-3-4. Error code [outdoor]	4-20
4-3-5. Wired remote controller	4-33
4-4. Troubleshooting by symptoms	4-25
4-1-1. When the outdoor unit power is not ON – Initial Diagnosis : 1-phase products	4-25
4-4-2. Indoor temperature sensor error (E121)	4-26
4-4-3. Indoor heat exchanger temperature sensor error (E122)	4-27
4-4-4. Indoor Fan error (E154)	4-28
4-4-5. Communication error after finishing Tracking (E202)	4-29
4-4-6. Indoor unit float sensor error	4-30
4-4-7. EEPROM circuit failure (E162)	4-31
4-4-8. The whistling noise from the indoor unit in low wind mode	4-32
4-4-9. When the outdoor unit power is not ON - Initial Diagnosis : 3-phase products	4-33
4-4-10. Indoor/outdoor communication error (1min.) (Error Code : E202)	4-37

Contents

4-4-11. Communication error between outdoor unit INV ↔ MAIN MICOM (1 min.)(Error Code: E203)...	4-39
4-4-12. Outdoor sensor error(Error Code : E221, E231, E251, E320).....	4-40
4-4-13.Reverse phase / Loss phase detection (3-phase outdoor unit) (Error Code : E425).....	4-41
4-4-14. Compressor down due to freezing control (Error Code : E403).....	4-42
4-4-15. Outdoor unit Fan error (Error Code : E458, E475)	4-43
4-4-16. Compressor starting error / rotation error (Error Code : E461, E467).....	4-44
4-4-17. Full current error / PFC over-current error (Error Code : E462, E484).....	4-46
4-4-18. IPM IPM (Over Current) error (Error Code : E464).....	4-47
4-4-19. DC LINK over-current / low-voltage error (Error Code : E466) H/W DC_Link Over Voltage Error (Error Code : E483) AC Input Voltage Sensor Error (Error Code : E488).....	4-50
4-4-20. Gas leakage error(Error Code : E554).....	4-51
4-4-21. Pipe blockage error(Error Code : E422).....	4-53
4-4-22. Smart install mode was not carried out (Error Code : E508).....	4-54
4-4-23. Others.....	4-56
5. PCB Diagram and Parts List	5-1
5-1. PCB Diagram	5-1
5-1-1. Indoor Unit Main PBA	5-1
5-1-2 Display PCB	5-3
5-1-3. Outdoor PCB.....	5-4
6. Wiring Diagram	6-1
6-1. Indoor Unit	6-1
6-2. Outdoor Unit	6-2
7. SW update	7-1
7-1. S-net pro Download	7-1
7-2. RS485 VS RS232(UART)	7-1
7-3. How to update the Micom(RS485)	7-2
7-4. How to update the Micom(UART)	7-7
7-5. How to write the EEPROM	7-9
8. Reference Sheet	8-1
8-1. Index for model name	8-1
8-1-1. Indoor Unit	8-1
8-1-2. Outdoor Unit	8-3
8-1-3. Panel	8-3
8-2. Refrigerating Cycle Diagram	8-4

1. Precautions

1-1 Precautions for the Service

- **Use the standard parts when replacing the electric parts.**
 - Confirm the model name, rated voltage, rated current of the electric parts.
- **When repairing the equipment, connection of the harness parts must be firm and solid.**
 - A loose connection may cause noise or other malfunction.
- **When assembling and disassembling the equipment while it is laid down, lay it on soft cloth.**
 - Otherwise it may scratch the back of the exterior of the product.
- **Remove dust or dirt completely from the housing block, wiring block and service parts during repair.**
 - This helps prevent the danger of fire caused by tracking or short circuit.
- **Fasten the valve caps of service valves and charging valves of outdoor unit as much as possible using adjustable wrenches.**
- **Check the status of the components' assembly after repair service.**
 - The status must be the same as before the repair service.

1-2 Precautions related to static electricity and PL

- **The PCB power supply block is susceptible to static electricity. Therefore, care must be taken during repair or measuring while the power is on.**
 - Wear insulation gloves for PCB repair or measuring.
- **Check whether the installation location is at least two meters away from other electronic products such as TV, video, or audio.**
 - Otherwise, the video quality might be degraded or noise might be generated.
- **Do not let end users repair the products themselves.**
 - Unauthorized disassembly might cause electric shock or fire.

1-3 Precautions related to product safety

- **Do not pull the power cord and do not touch the power plug or aux power switch with wet hands.**

– It might cause electric shock or fire.



- **A damaged power line or power plug must be replaced to prevent danger.**

- **Do not bend the power cable with excessive force, and do not place a heavy weight on the case as it might damage the cable.**

– It might cause electric shock or fire.

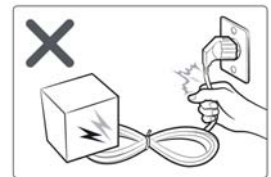

- **Do not use multiple electric outlets.**

– This might cause electric shock or fire.

- **Connect the ground terminal when necessary.**

– You must connect the ground terminal if you determine that there is a danger of electric leakage due to moisture or water.

- **Unplug the power cable or turn off the auxiliary power switch for electric part replacement and repair service.**

– Otherwise it might cause electric shock.

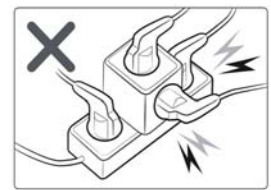

- **Instruct end users to separate the batteries from the remote controllers and store them separately when the product is not used for long time.**

– Otherwise leakage from the dry cell may cause problems with the remote controller.

1-4 Other precautions

- **The pipes should have no leaks during installation, and the compressor must be stopped before removing connecting pipes for pump down work. Operating the compressor while the service valve is open and coolant pipe is not properly connected may cause explosion or injury due to abnormal high pressure created inside the coolant cycle as the air can be absorbed through the pipe.**

- **Pump Down work procedure (When uninstalling the product)**

– Turn on the air conditioner, select cooling operation, and run the compressor for more than three minutes.

– Release the high pressure and low pressure valve caps.

– Close the high pressure valve completely using an L-wrench

– After about two minutes, close the low pressure valve completely.

– Stop running the air conditioner.

– Separate the connecting pipe.

2. Product Specifications

2-1 The Feature of Product

■ 360 Cassette

■ Differentiated innovation air cooling

It delivers a cool air evenly with the circular air current and provides a wide and agreeable cooling area than general ceiling air conditioners.

■ Refreshing and soft wind

It provides a horizontal air current that form natural convection instead of unpleasant direct wind. It is consumer-friendly product that prevents the sudden effective temperature tumble.

■ High quality circular design

It applied the wind direction control technology (Coanda effect) which uses the booster fan. Epoch-making circular design that eliminates the blade.

■ Eco-friendly air conditioner

It is eco-friendly air conditioner that is certified a RoHS technology as well as realize high effectiveness, low noise, super power saving.

























■ Electricity savings through S- Inverter System

Apply S-inverter system that change capacity to 10~160% according to circumstance by one compressor and reduce optimum cooling effect and unnecessary electricity consumption.

■ Cleanness function of four seasons high efficiency

Energy consumption and driving noise decrease more because can operate cleanness function separately. Make healthy and clean environment by bacillus exclusion function and active oxygen neutralization function that virus doctor at air conditioner driving removes air various hazardous substances operating always..













2-2 Product Specifications

ITEM		Development Model							
		AC090MN4PKH AC090MXADKH	AC100MN4PKH AC100MXADKH	AC100MN4PKH AC100MXADKH	AC120MN4PKH AC120MXADKH	AC120MN4PKH AC120MXADKH	AC120MN4PKH AC120MXADNH	AC071MN4PKH AC140MN4PKH AC140MXADKH	AC140MN4PKH AC140MXADNH
Design	Indoor Unit								
	Outdoor Unit								
	Remote Controller								
Capacity	Cooling[w]	9	10	10	12	12	12	13.4	13.4
	Heating [W]	10	11.2	11.2	13	13	13	15.5	15.5
Power input	Cooling[w]	2820	3400	3400	4700	4700	4700	4450	4450
	Heating [W]	2650	3150	3150	4000	4000	4000	4540	4540
EER/COP	Cooling[w]	6.8	6.8	6.8	5.7	5.7	5.7	3.01	3.01
	Heating [W]	4.3	4.3	4.3	4.1	4.1	4.1	3.41	3.41
Voltage / Frequency		1Φ, 220-240V~/50Hz	1Φ, 220-240V~/50Hz	1Φ, 220-240V~/50Hz	1Φ, 220-240V~/50Hz	1Φ, 220-240V~/50Hz	3Φ, 380-415V 3N~/50Hz	1Φ, 220-240V~/50Hz	3Φ, 380-415V 3N~/50Hz
Running Current	Cooling[w]	12.7	15.1	15.1	20.5	20.5	7.1	20	7
	Heating [W]	12.5	14.6	14.6	17.5	17.5	6.3	19.5	7
Noise	Indoor Unit [dBA] (C/H)	48/48	50/50	50/50	50/50	50/50	50/50	51/51	51/51
	Outdoor Unit [dBA] (C/H)	57/59	58/60	58/60	59/61	59/61	59/61	60/62	60/62
Size (W*H*D)	Net Dimension (WxHxD)	Indoor Unit [mm]	947*947*365	947*947*365	947*947*365	947*947*365	947*947*365	947*947*365	947*947*365
		Outdoor Unit [mm]	990*990*414	990*990*414	990*990*414	990*990*414	990*990*414	990*990*414	990*990*414
	Shipping Dimension (WxHxD)	Indoor Unit [mm]	940*330*998	940*330*998	940*330*998	940*330*998	940*330*998	940*330*1210	940*330*1210
		Outdoor Unit [mm]	995*426*1096	995*426*1096	995*426*1096	995*426*1096	995*426*1096	995*426*1388	995*426*1388
Weight (kg)	Net	Indoor Unit [kg]	24	24	24	24	24	26	26
		Outdoor Unit [kg]	28.5	28.5	28.5	28.5	28.5	30.5	30.5
	Shipping	Indoor Unit [kg]	72	72	72	80	80	85	85
		Outdoor Unit [kg]	77	77	77	85	85	94	94

ITEM		Development Model							
		AC090MN4PKH AC090MXADKH	AC100MN4PKH AC100MXADKH	AC100MN4PKH AC100MXADKH	AC120MN4PKH AC120MXADKH	AC120MN4PKH AC120MXADKH	AC120MN4PKH AC120MXADNH	AC071MN4PKH AC140MN4PKH AC140MXADKH	AC140MN4PKH AC140MXADNH
Harness spec	Indoor fan motor	DB31-00577D	DB31-00577D	DB31-00577D	DB31-00577D	DB31-00577D	DB31-00577D	DB31-00577D	DB31-00577D
	Compressor	UG8T300FUBJUSG	UG8T300FUBJUSG	UG8T300FUBJUSG	UG5TK1450FJX	UG5TK1450FJX	UG5TK1450FJX	UG5TK1450FJX	UG5TK1450FJX
	Outdoor fan motor	DB31-00579B	DB31-00579B	DB31-00579B	DB31-00579B	DB31-00579B	DB31-00579B	DB31-00658A	DB31-00658A
Designed pressure	High pressure	4.1 Mpa	4.1 Mpa	4.1 Mpa	4.1 Mpa	4.1 Mpa	4.1 Mpa	4.1 Mpa	4.1 Mpa
	Low pressure	1.4 Mpa	1.4 Mpa	1.4 Mpa	1.4 Mpa	1.4 Mpa	1.4 Mpa	1.4 Mpa	1.4 Mpa
Refrigerant / Factory charging		3000	3000	3000	3000	3000	3000	3400	3400
Additional refrigerant		50g/m	50g/m	50g/m	50g/m	50g/m	50g/m	50g/m	50g/m
Basic piping length		5	5	5	5	5	5	5	5
Max. piping length		50	50	50	50	50	50	75	75
Max. level different		30	30	30	30	30	30	30	30
Option code		01007F-19547C-275A64-370040	01007F-19548C-276470-370040	01007F-19548C-276470-370040	01007F-19549D-277882-370040	01007F-19549D-277882-370040	01007F-19549D-277882-370040	01107F-1954AF-278CA0-370040	01107F-1954AF-278CA0-370040
		020000-100000-200000-300000	020000-100000-200000-300000	020000-100000-200000-300000	020000-100000-200000-300000	020000-100000-200000-300000	020000-100000-200000-300000	020000-100000-200000-300000	020000-100000-200000-300000
		030000-100000-200000-300000	030000-100000-200000-300000	030000-100000-200000-300000	030000-100000-200000-300000	030000-100000-200000-300000	030000-100000-200000-300000	030000-100000-200000-300000	030000-100000-200000-300000

2-3 Specifications of optional items







2-3-1 Accessories

Item	Description	Code No.	Q'ty	Remark
	ASSY DRAIN- HOSE	DB94-02719B	1	Standard / Indoor unit
	Cable tie	DB65-00191A	6	
	Seal-drain ass'y	DB62-05810A	1	
	Seal-drain ass'y	DB94-05810F	1	
	Seal-drain ass'y	DB94-05810G	1	
	Indoor unit installation manual	DB68-05899A	1	
	USER MANUAL	DB68-05918A	1	Standard / Outdoor unit
	Drain cap	DB63-10355C	3 (AC071KX4DKH:4)	
	Pipe plug	DB67-00806A	1	
	Rubber Leg	DB73-20134A (AC071KX4DKH : DB73-00179A)	4	
	Outdoor unit installation manual	DB68-05565A	1	
	Bolt-flange	6009-001435	4	
	INSTALL MANUAL	DB68-05903A	1	

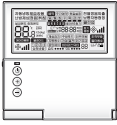
2-3-2 Wireless remote controller (AR-KH00E)

Item	Description	Code No.	Q'ty	Remark
	Wireless remote controller	DB93-15771C	1	Optional
	Batteries for remote controller (specification: "AAA" type)	4301-000121	2	
	Remote controller holder	DB61-06607A	1	
	M4x16 Screw	6002-000581	2	
	User's manual	DB68-05911A	1	

2-3-3 Wired remote controller (MWR-WE10N)



Item	Description	Code No.	Q'ty	Remark
	Wired remote controller	DB93-11251F	1	Optional
	Cable tie	DB65-10088B	2	
	Cable clamp	DB65-10074E	3	
	M4x16 Screw	6002-000474	5	
	User's manual	DB68-03732A	1	
	Installation manual	DB68-03716A	1	

2-3-4 Filter specifications

Item	Description	Code No.	Remark
	FILTER-AIR	DB63-03764A	



3. Disassembly and Reassembly

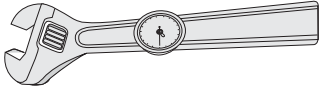

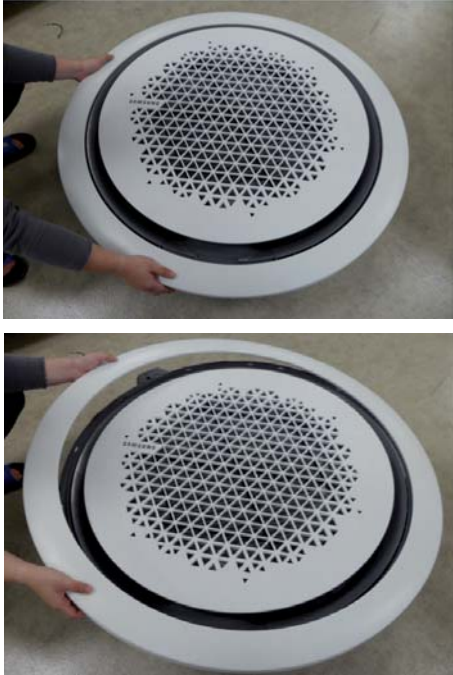

3-1 Necessary Tools

Item	Remark
+ Screw Driver	
Monkey Spanner (8mm, 10mm, 13mm)	
M6, M8 Hex Wrench	
Spanner Torque Wrench	

3-2 Indoor Unit





No.	Parts	Procedure	Remark
1	Panel	<p>► Ceiling type Panel</p> <p>1) Pull up the corner 4 places of Panel and separate it.</p> <p>2) Remove the 4 screws from the corner of Panel. (Use +Screw Driver)</p> <p>3) Pull the hook of Panel and then separate the Panel from the Indoor Unit.</p>	
1	Panel	<p>► Open type Panel</p> <p>1) Rotate the outside Panel to counterclockwise direction and then separate it.</p>	

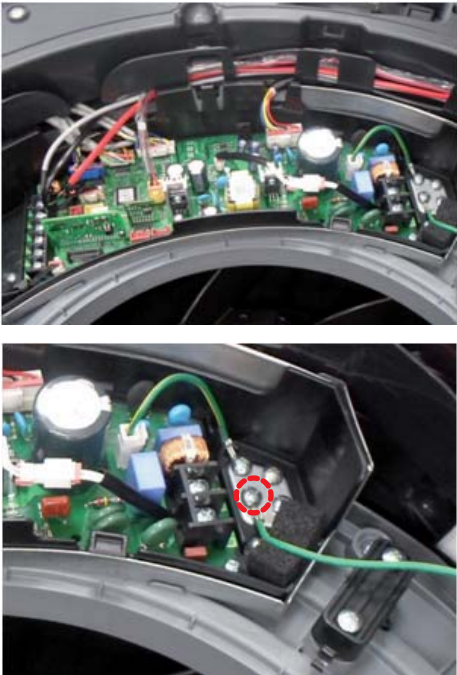
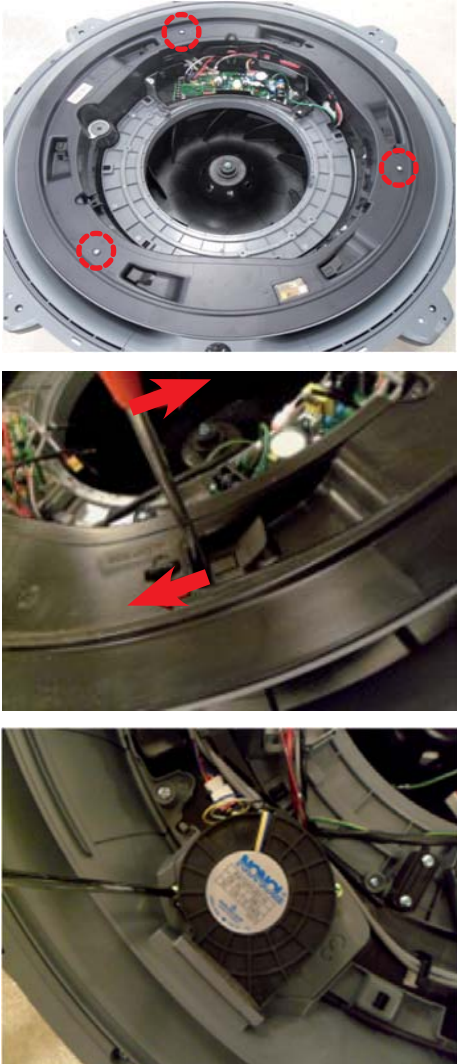

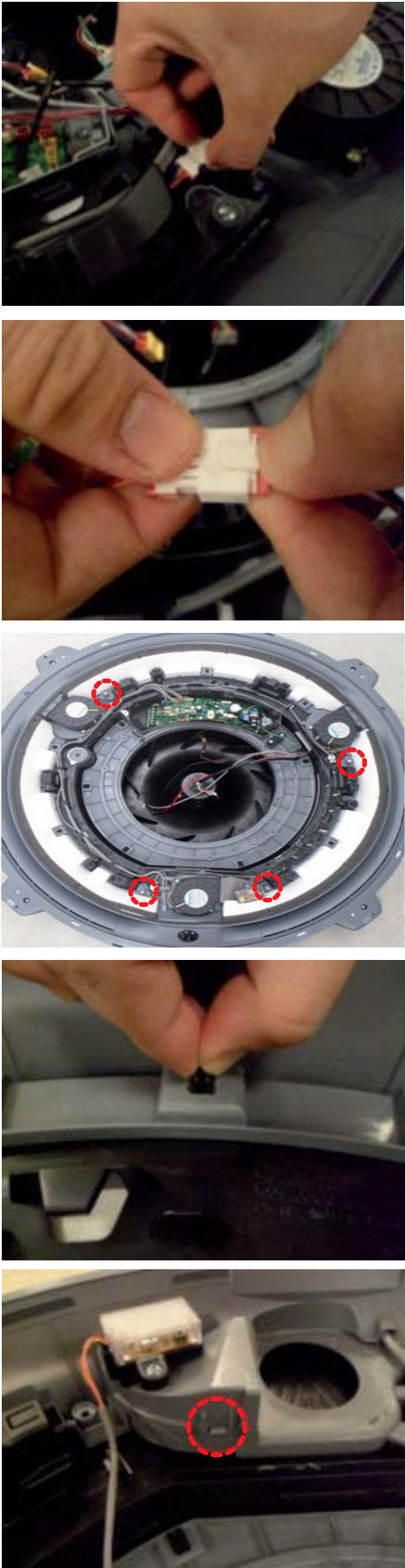
No.	Parts	Procedure	Remark
1	Panel	<p>2) Rotate the Grille to counterclockwise direction.</p> <p>3) Remove the safety clip of Grill inside and then separate the Panel from the Indoor Unit.</p> <p>4) Pull up the Filter from the Grill and separate it.</p>	  
2	Control Box	<p>1) Remove the 2 screws which are fixed to the Indoor Unit upper part.(Use +Screw Driver)</p> <p>2) Rotate the Guard Fan to counterclockwise direction and separate it</p>	 

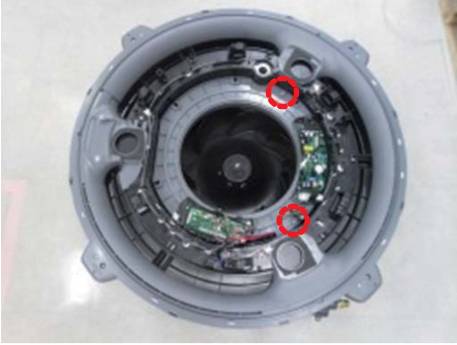



No.	Parts	Procedure	Remark
2	Control Box	<p>3) Reomove the 1 screw which is fixed to the Indoor Unit upper part.(Use +Screw Driver)</p> <p>4) Put finger in the "PULL" marked groove and then pull up the Cover</p> <p>5) Put finger in the "PULL" marked groove and then avoids the hook and it opens the Control Box Cover</p>	    





No.	Parts	Procedure	Remark
2	Control Box	<p>6) Separate the connectors from the Control Box.</p> <p>7) Remove the ground screw. (Use +Screw Driver)</p>	
3	Top Cover & Drain Pan	<p>1) Remove the 3 screws. (Use +Screw Driver)</p> <p>2) Push the hook and separate the Cover.</p> <p>⚠ Damage can occur to product in case of use a sharp tool.</p> <p>3) Remove the screw which is fixed to Booster Fan. (Use +Screw Driver)</p>	

No.	Parts	Procedure	Remark
3	Top Cover & Drain Pan	<p>4) Pull the Booster Fan connector and separate the connector.</p> <p>5) Remove the 4 screws. (Use +Screw Driver)</p> <p>6) Push the hook and separate the Cover.</p>	

No.	Parts	Procedure	Remark
3	Top Cover & Drain Pan	<p>7) Remove the screw and separate the Display Cover. (Use +Screw Driver)</p> <p>8)) Remove the 2 screws. (Use +Screw Driver)</p> <p>9) Push the hook and separate the Cover.</p> <p>10) Remove the 8 screws. (Use +Screw Driver)</p> <p>11) Separate the Indoor Unit upper part from the Body</p>	    



No.	Parts	Procedure	Remark
3	Top Cover & Drain Pan	<p>12) Remove the 3 screws. (Use +Screw Driver)</p> <p>13) Pull the hook that is on the side and separate the Cover.</p>	
4	Drain Pump & Hose	1) Separate the Drain Hose from the Drain Pump.	

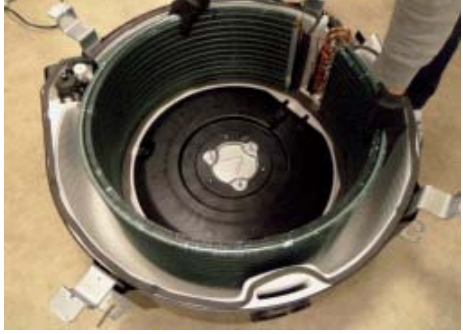

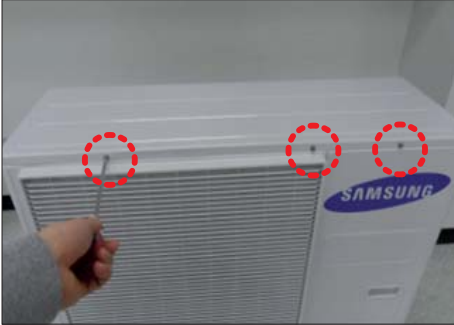

No.	Parts	Procedure	Remark
4	Drain Pump & Hose	2) Remove the 2 screws and separate the Drain Hose that is on the side lower part of Indoor Unit (Use +Screw Driver)	
5	Fan & Motor	<p>1) Remove the hex nut which is fixed to top of Fan and separate the Fan from the Motor. (Use Monkey Spanner)</p> <p>2) Remove the 3 hex nuts which is fixed to Motor and separate the Motor from the Indoor Unit. (Use Monkey Spanner)</p>	 
6	Temperature Sensor	<p>1) Remove the 6 screws which is fixed to Evaporator and separate the Partition.</p> <p>2) Separates the Temperature Sensor which is fixed to Evaporator Pipe with the fixing clip together by the hand.</p>	 

No.	Parts	Procedure	Remark
4	Evaporator	<p>1) Remove the screws which is fixed to Indoor Unit and separate the Evaporator fixing bracket. (Use +Screw Driver)</p> <p>2) Remove screws which is fixed to Indoor Unit and pull the hook and then separate the Drain Cover. (Use +Screw Driver)</p> <p>⚠ When assemble, be careful with the interference structure of piping projecting part.</p> <p>3) Separate the Evaporator from the Indoor Unit.</p> <p>⚠ If you remove the Evaporator with bare hands, it may injure your hands, gloves must be worn.</p>	    



3-3. Outdoor Unit

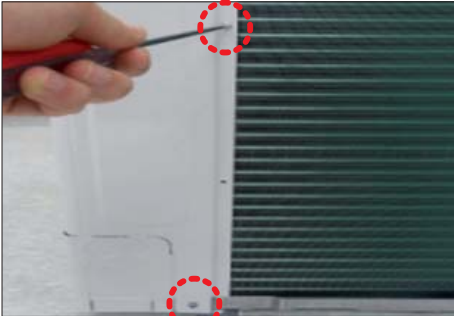

■ AC090/100/120MXAD*H

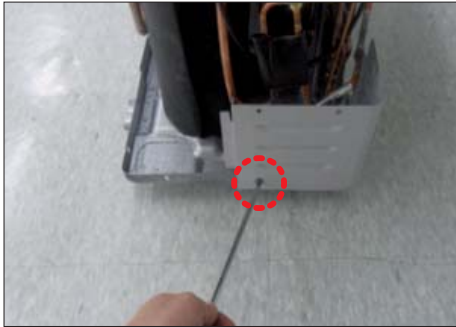
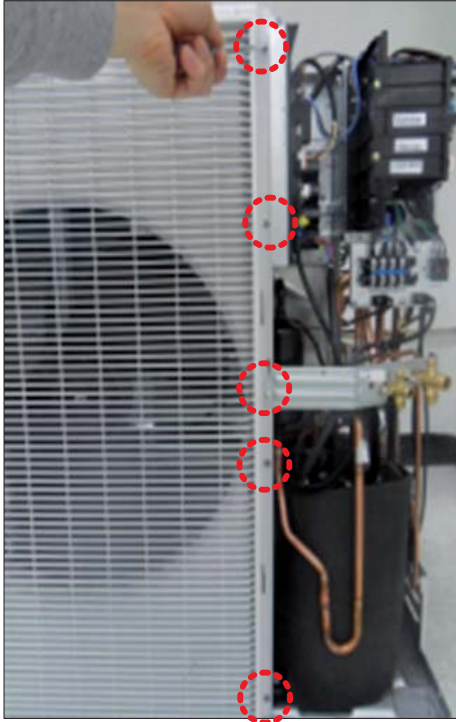
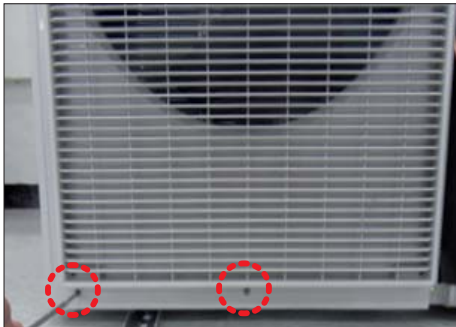

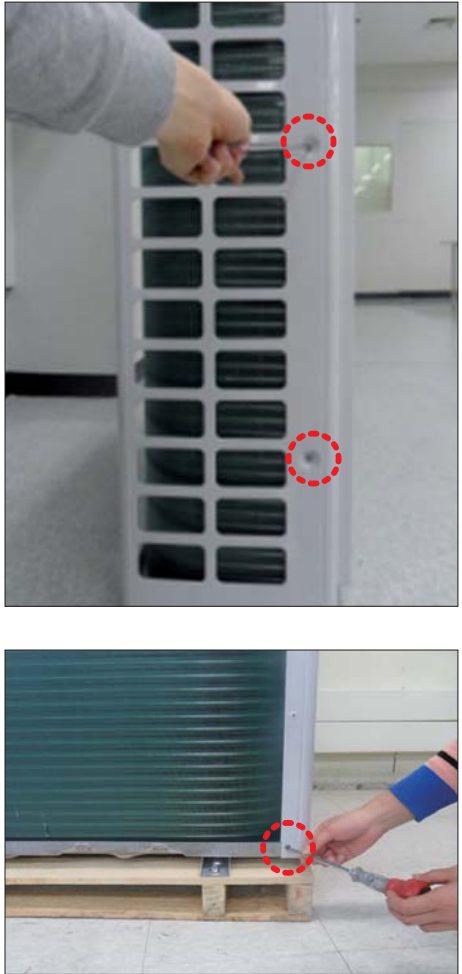
No.	Parts	Procedure	Remark
1	Cabinet Front RH	<p>⚠ Turn off the power before disassembly necessarily.</p> <p>1) Remove the 2 screws from the Cabinet Front RH and separate it. (Use +Screw Driver)</p>	
2	Cabinet Upper	<p>1) Remove the 9 screws which is fixed to each side of Cabinet Upper and separate it. (Use +Screw Driver)</p>	
3	Cabinet-Installation Front Part	<p>1) Remove the 1 screw which is fixed to Cabinet-Installation Front Part and separate it. (Use +Screw Driver)</p>	

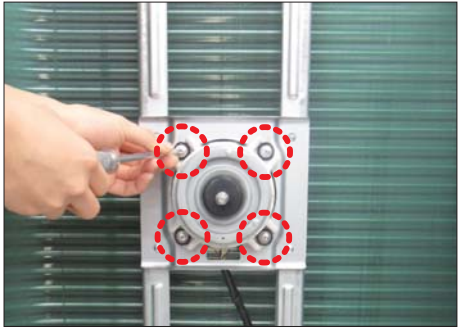
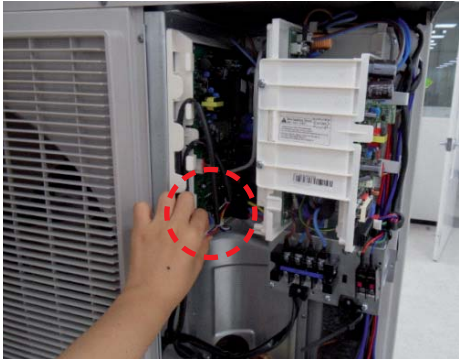

No.	Parts	Procedure	Remark
4	Outdoor Unit Guard	<p>1) Pull out the sensor from the Outdoor Unit Guard and separate it.</p> <p>2) Remove the 4 screws which is fixed to Outdoor Unit Guard and separate it. (Use + Screw Driver)</p>	 
5	Cabinet Rear RH	<p>1) Pull out the sensor from the Cabinet Rear RH and separate it.</p> <p>2) Remove the 4 screws which is fixed to each side of Cabinet Rear RH and separate it. (Use + Screw Driver)</p>	  

No.	Parts	Procedure	Remark
6	Cabinet-Installation Rear Part	1) Remove the 1 screw from the Cabinet-Installation Rear Part and separate it.(Use +Screw Driver)	
7	Cabinet Front LF	1) Remove the 10 screws from the Cabinet Front LF and separate it. (Use +Screw Driver)	 

No.	Parts	Procedure	Remark
7	Cabinet Front LF		
8	Fan	<p>1) Remove the 2 fixing nuts like the picture on the right side. (Use Hexagon Wrench, Monkey Spanner, Hexagon Socket)</p>	

No.	Parts	Procedure	Remark
9	Motor	<ol style="list-style-type: none"> 1) Separate the Fan Propeller. 2) Remove the 8 screws which is fixed to Motor. (Use +Screw Driver) 3) Separate the Motor Wire connector from the Outdoor Unit Control Part. 	 
10	Bracket Motor	<ol style="list-style-type: none"> 1) Remove the 2 screws from the Bracket Motor and separate it. (Use +Screw Driver) 	

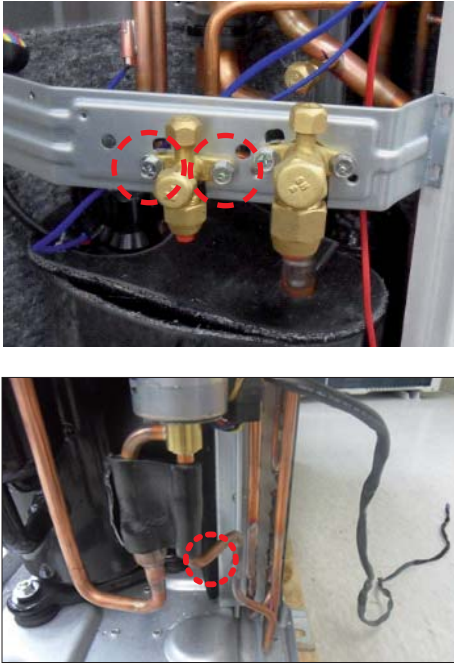

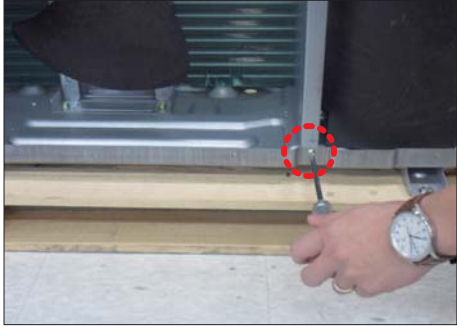
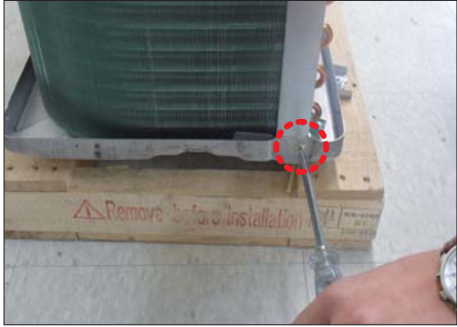
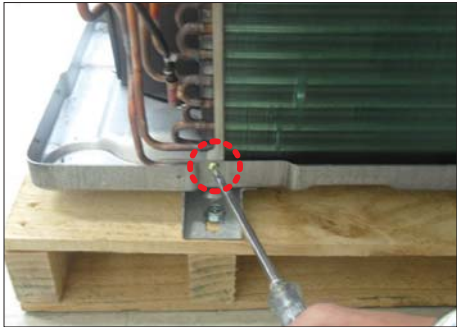

No.	Parts	Procedure	Remark
12	4 Way Valve	<p>1) First, discharge the refrigerant.</p> <p>2) Remove the 2 screws which is fixed to Service Valve and separate it. (Use +Screw Driver)</p> <p>3) Separate the inlet and outlet pipes by welding torch.</p> <p>⚠ If you separate the Compressor, Heat Exchanger or Pipe, please fully discharge refrigerant in the Compressor and then separate the Pipe by welding torch.</p>	  

No.	Parts	Procedure	Remark
13	EEV Valve	<p>1) Remove the 2 screws which is fixed to Service Valve and separate it. (Use +Screw Driver)</p> <p>2) Separate the inlet and outlet pipes by welding torch.</p>	
14	Compressor	<p>1) Remove the 1 fixing nut from the end of Cover and separate it. (Use Hexagon Wrench, Monkey Spanner, Hexagon Socket)</p> <p>2) Separate the Felt Compressor.</p>	

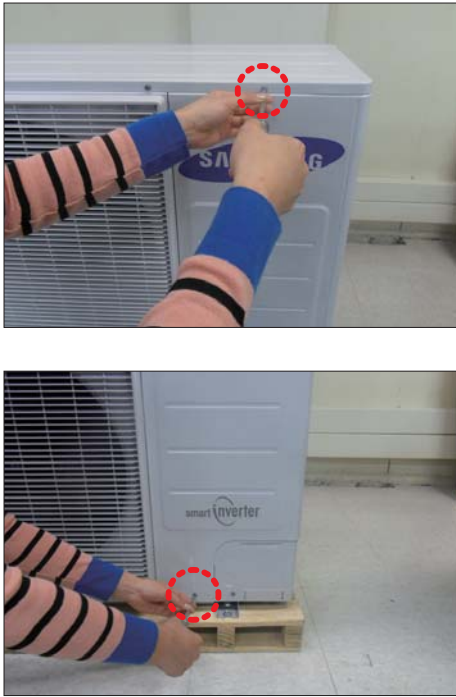
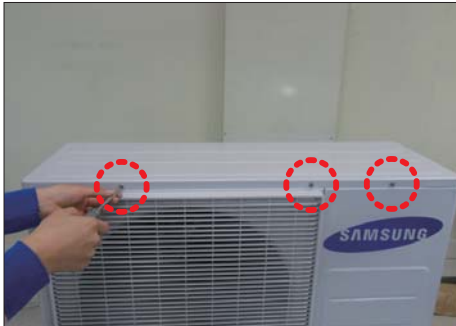
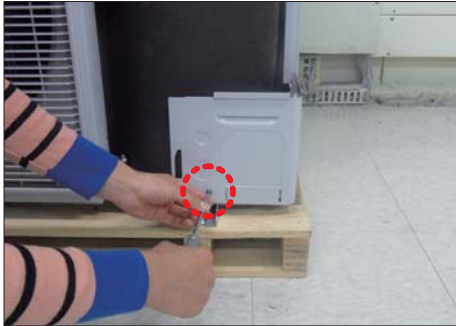

No.	Parts	Procedure	Remark
14	Compressor	3) Remove the 3 bolts from the bottom of Compressor like the picture on the right side. (Use Hexagon Wrench, Monkey Spanner, Hexagon Socket)	
15	Condenser Connection Part	1) Remove the 3 screws which is fixed to each side of Condenser Connection Part and separate it. (Use + Screw Driver)	  



■ AC140MXAD*H

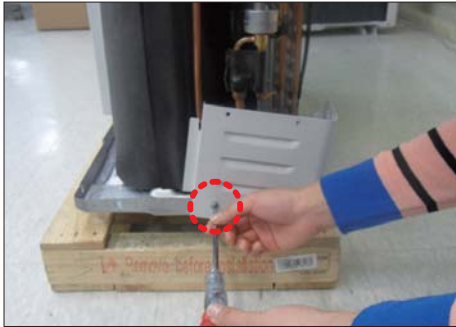
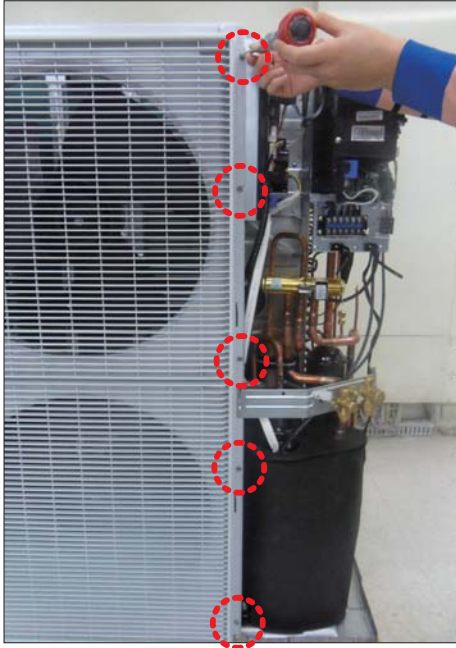
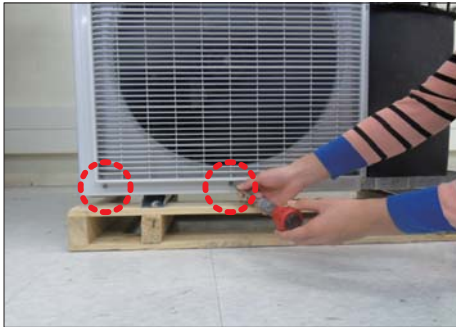



No.	Parts	Procedure	Remark
1	Cabinet Front RH	<p>⚠ Turn off the power before disassembly necessarily.</p> <p>1) Remove the 2 screws from the Cabinet Front RH and separate it. (Use + Screw Driver)</p>	
2	Cabinet Upper	<p>1) Remove the 9 screws which is fixed to each side of Cabinet Upper and separate it.(Use + Screw Driver)</p>	
3	Cabinet-Installation Front Part	<p>1) Remove the 1 screw which is fixed to Cabinet-Installation Front Part and separate it.(Use + Screw Driver)</p>	

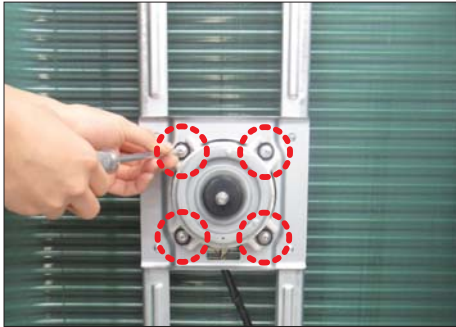
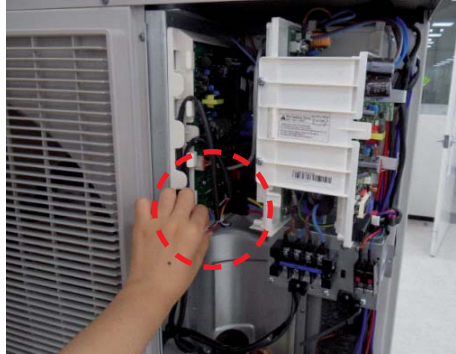



No.	Parts	Procedure	Remark
4	Outdoor Unit Guard	<p>1) Pull out the sensor from the Outdoor Unit Guard and separate it.</p> <p>2) Remove the 4 screws which is fixed to Outdoor Unit Guard and separate it. (Use + Screw Driver)</p>	 
5	Cabinet Rear RH	<p>1) Pull out the sensor from the Cabinet Rear RH and separate it.</p> <p>2) Remove the 4 screws which is fixed to each side of Cabinet Rear RH and separate it.(Use + Screw Driver)</p>	 

No.	Parts	Procedure	Remark
6	Cabinet-Installation Rear Part	1) Remove the 1 screw from the Cabinet-Installation Rear Part and separate it.(Use +Screw Driver)	
7	Cabinet Front LF	1) Remove the 10 screws from the Cabinet Front LF and separate it. (Use +Screw Driver)	 

No.	Parts	Procedure	Remark
7	Cabinet Front LF		
8	Fan	<p>1) Remove the 2 fixing nuts like the picture on the right side. (Use Hexagon Wrench, Monkey Spanner, Hexagon Socket)</p>	

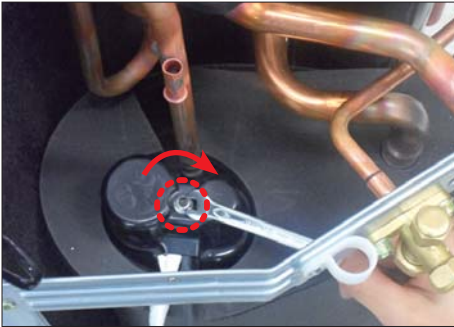
No.	Parts	Procedure	Remark
9	Motor	<ol style="list-style-type: none"> 1) Separate the Fan Propeller. 2) Remove the 8 screws which is fixed to Motor. (Use +Screw Driver) 3) Separate the Motor Wire connector from the Outdoor Unit Control Part. 	 
10	Bracket Motor	<ol style="list-style-type: none"> 1) Remove the 2 screws from the Bracket Motor and separate it. (Use +Screw Driver) 	

No.	Parts	Procedure	Remark
12	4 Way Valve	<p>1) First, discharge the refrigerant.</p> <p>2) Remove the 2 screw which is fixed to Service Valve. (Use +Screw Driver)</p> <p>3) Separate the inlet and outlet pipes by welding torch.</p> <p>⚠ If you separate the Compressor, Heat Exchanger or Pipe, please fully discharge refrigerant in the Compressor and then separate the Pipe by welding torch.</p>	  
13	EEV Valve	<p>1) Remove the 2 screws which is fixed to Service Valve and separate it. (Use +Screw Driver)</p> <p>2) Separate the inlet and outlet pipes by welding torch</p>	 

No.	Parts	Procedure	Remark
14	Compressor	<p>1) Remove the 1 fixing nut from the end of Cover and separate it. (Use Hexagon Wrench, Monkey Spanner, Hexagon Socket)</p> <p>2) Separate the Felt Compressor.</p> <p>3) Remove the 3 bolts from the bottom of Compressor like the picture on the right side. (Use Hexagon Wrench, Monkey Spanner, Hexagon Socket)</p>	   

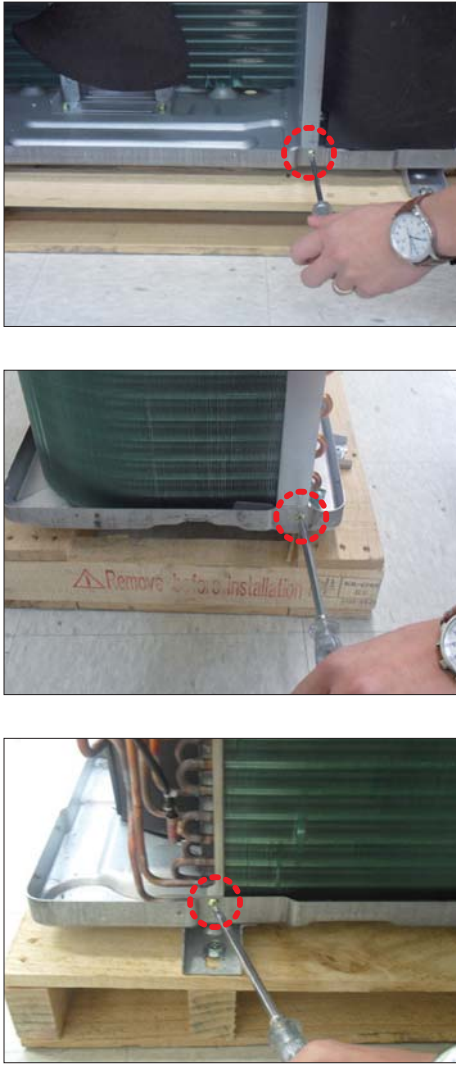
No.	Parts	Procedure	Remark
15	Condenser Connection Part	1) Remove the 3 screws which is fixed to each side of Condenser Connection Part and separate it. (Use + Screw Driver)	

4. Troubleshooting

4-1 Setting an indoor unit address and installation option

- ▶ Indoor address set-up and installation options, set the remote control option..
ADDRESS setting and indoor settings option haohni setting is not possible at the same time, set each of the options.
If necessary, set up the indoor address setting installation options, you must enter twice.

4-1-1. The procedure of setting option

- ▶ MR-EC00 and MR-EH00 remote controls

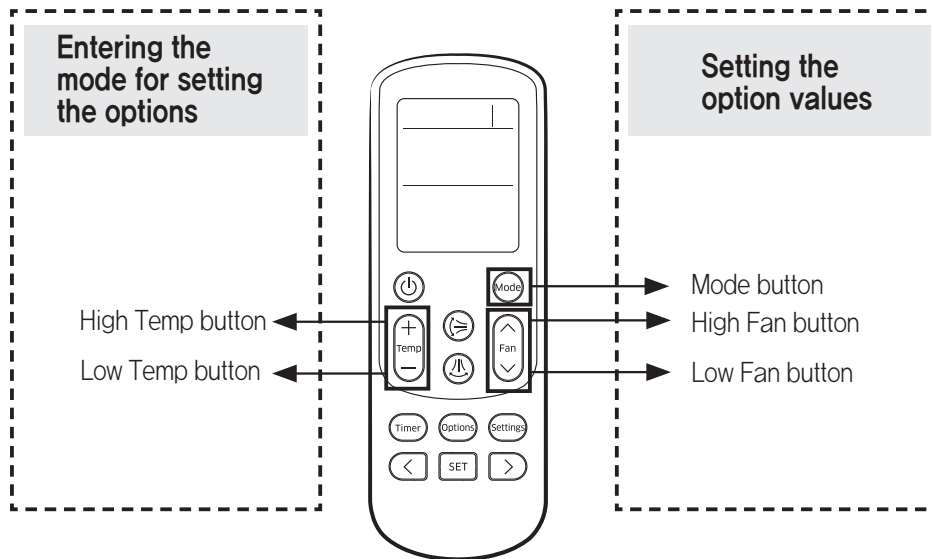

Step 1 Enter the mode for setting the options

1. Enter the mode for setting the options :

- Remove the batteries from the remote control, and then insert them again.
- While holding down the \oplus_{Temp} (High Temp) and \ominus_{Temp} (Low Temp) buttons simultaneously, insert the batteries into the remote control.
- Make sure that you are entered to the mode for setting the options: batteries into the remote control.



2. Set the option values.







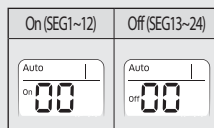







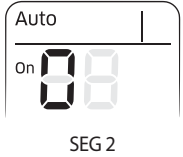
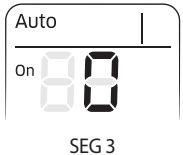

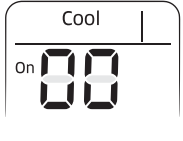

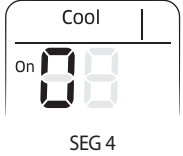
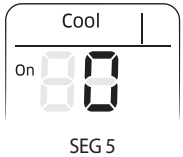

- The total number of available options are 24: SEG1 to SEG24.
- Because SEG1, SEG7, SEG13, and SEG19 are the page options used by the previous remote control models, the modes to set values for these options are skipped automatically.
- Set a 2-digit value for each option pair in the following order: SEG2 and SEG3 → SEG4 and SEG5 → SEG6 and SEG8 → SEG9 and SEG10 → SEG11 and SEG12 → SEG14 and SEG15 → SEG16 and SEG17 → SEG18 and SEG20 → SEG21 and SEG22 → SEG23 and SEG24

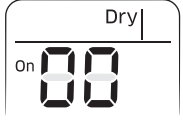



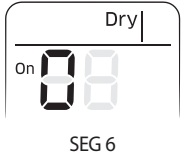
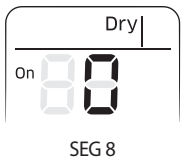

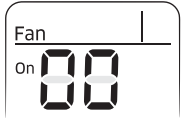







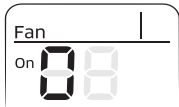
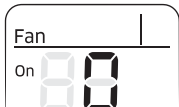

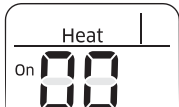

SEG1	SEG2	SEG3	SEG4	SEG5	SEG6	SEG7	SEG8	SEG9	SEG10	SEG11	SEG12
0	X	X	X	X	X	1	X	X	X	X	X
SEG13	SEG14	SEG15	SEG16	SEG17	SEG18	SEG19	SEG20	SEG21	SEG22	SEG23	SEG24
2	X	X	X	X	X	3	X	X	X	X	X

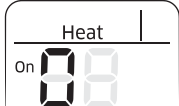
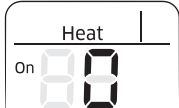











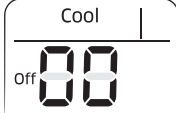



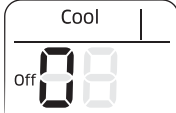
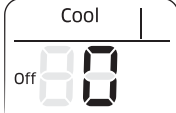

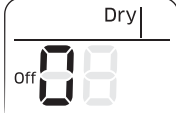
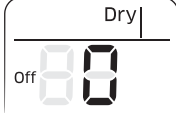

4-1-2. The procedure of setting option

Steps	Remote control display
<p>1 Set the SEG2 and SEG3 values:</p> <p>a Set the SEG2 value by pressing the  (Low Fan) button repeatedly until the value you want to set appears on the remote control display.</p> <p>b Set the SEG3 value by pressing the  (High Fan) button repeatedly until the value you want to set appears on the remote control display.</p> <p>When you press the  (Low Fan) or  (High Fan) button, values appear in the following order: 0 → 1 → ... E → F</p>	 <p style="text-align: center;">SEG 2</p>  <p style="text-align: center;">SEG 3</p>
<p>2 Press the  (Mode) button. Cool and On appear on the remote control display.</p>	
<p>3 Set the SEG4 and SEG5 values:</p> <p>a Set the SEG4 value by pressing the  (Low Fan) button repeatedly until the value you want to set appears on the remote control display.</p> <p>b Set the SEG5 value by pressing the  (High Fan) button repeatedly until the value you want to set appears on the remote control display.</p> <p>When you press the  (Low Fan) or  (High Fan) button, values appear in the following order: 0 → 1 → ... E → F</p>	 <p style="text-align: center;">SEG 4</p>  <p style="text-align: center;">SEG 5</p>
<p>4 Press the  (Mode) button. Dry and On appear on the remote control display.</p>	
<p>5 Set the SEG6 and SEG8 values:</p> <p>a Set the SEG6 value by pressing the  (Low Fan) button repeatedly until the value you want to set appears on the remote control display.</p> <p>b Set the SEG8 value by pressing the  (High Fan) button repeatedly until the value you want to set appears on the remote control display.</p> <p>When you press the  (Low Fan) or  (High Fan) button, values appear in the following order: 0 → 1 → ... E → F</p>	 <p style="text-align: center;">SEG 6</p>  <p style="text-align: center;">SEG 8</p>
<p>6 Press the  (Mode) button. Fan and On appear on the remote control display.</p>	



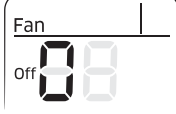

The procedure of setting option(Cont.)

Steps	Remote control display
<p>7 Set the SEG9 and SEG10 values:</p> <p>a Set the SEG9 value by pressing the  (Low Fan) button repeatedly until the value you want to set appears on the remote control display.</p> <p>b Set the SEG10 value by pressing the  (High Fan) button repeatedly until the value you want to set appears on the remote control display.</p> <p>When you press the  (Low Fan) or  (High Fan) button, values appear in the following order: □ → → ... E → F</p>	 <p style="text-align: center;">SEG 9</p>  <p style="text-align: center;">SEG 10</p>
<p>8 Press the  (Mode) button. Heat and On appear on the remote control display.</p>	
<p>9 Set the SEG11 and SEG12 values:</p> <p>a Set the SEG11 value by pressing the  (Low Fan) button repeatedly until the value you want to set appears on the remote control display.</p> <p>b Set the SEG12 value by pressing the  (High Fan) button repeatedly until the value you want to set appears on the remote control display.</p> <p>When you press the  (Low Fan) or  (High Fan) button, values appear in the following order: □ → → ... E → F</p>	 <p style="text-align: center;">SEG 11</p>  <p style="text-align: center;">SEG 12</p>
<p>10 Press the  (Mode) button. Auto and Off appear on the remote control display.</p>	
<p>11 Set the SEG14 and SEG15 values:</p> <p>a Set the SEG14 value by pressing the  (Low Fan) button repeatedly until the value you want to set appears on the remote control display.</p> <p>b Set the SEG15 value by pressing the  (High Fan) button repeatedly until the value you want to set appears on the remote control display.</p> <p>When you press the  (Low Fan) or  (High Fan) button, values appear in the following order: □ → → ... E → F</p>	 <p style="text-align: center;">SEG 14</p>  <p style="text-align: center;">SEG 15</p>

The procedure of setting option(Cont.)

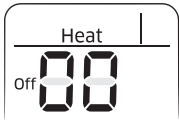
Steps	Remote control display
<p>12 Press the  (Mode) button. Cool and Off appear on the remote control display.</p>	
<p>13 Set the SEG16 and SEG17 values:</p> <p>a Set the SEG16 value by pressing the  (Low Fan) button repeatedly until the value you want to set appears on the remote control display.</p> <p>b Set the SEG17 value by pressing the  (High Fan) button repeatedly until the value you want to set appears on the remote control display.</p> <p>When you press the  (Low Fan) or  (High Fan) button, values appear in the following order: $\square \rightarrow \updownarrow \rightarrow \dots \rightarrow E \rightarrow F$</p>	 <p style="text-align: center;">SEG 16</p>  <p style="text-align: center;">SEG 17</p>
<p>14 Press the  (Mode) button. Dry and Off appear on the remote control display.</p>	
<p>15 Set the SEG18 and SEG20 values:</p> <p>a Set the SEG18 value by pressing the  (Low Fan) button repeatedly until the value you want to set appears on the remote control display.</p> <p>b Set the SEG20 value by pressing the  (High Fan) button repeatedly until the value you want to set appears on the remote control display.</p> <p>When you press the  (Low Fan) or  (High Fan) button, values appear in the following order: $\square \rightarrow \updownarrow \rightarrow \dots \rightarrow E \rightarrow F$</p>	 <p style="text-align: center;">SEG 18</p>  <p style="text-align: center;">SEG 20</p>
<p>16 Press the  (Mode) button. Fan and Off appear on the remote control display.</p>	
<p>17 Set the SEG21 and SEG22 values:</p> <p>a Set the SEG21 value by pressing the  (Low Fan) button repeatedly until the value you want to set appears on the remote control display.</p> <p>b Set the SEG22 value by pressing the  (High Fan) button repeatedly until the value you want to set appears on the remote control display.</p> <p>When you press the  (Low Fan) or  (High Fan) button, values appear in the following order: $\square \rightarrow \updownarrow \rightarrow \dots \rightarrow E \rightarrow F$</p>	 <p style="text-align: center;">SEG 21</p>  <p style="text-align: center;">SEG 22</p>

The procedure of setting option(Cont.)

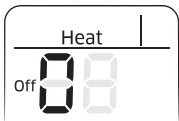
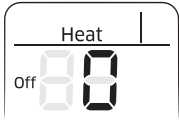
Steps	Remote control display
<p>18 Press the  (Mode) button. Heat and Off appear on the remote control display.</p>	
<p>19 Set the SEG23 and SEG24 values:</p> <p>a Set the SEG23 value by pressing the  (Low Fan) button repeatedly until the value you want to set appears on the remote control display.</p> <p>b Set the SEG24 value by pressing the  (High Fan) button repeatedly until the value you want to set appears on the remote control display.</p> <p>When you press the  (Low Fan) or  (High Fan) button, values appear in the following order: 0 → 1 → ... E → F</p>	 <p style="text-align: center;">SEG 23</p>  <p style="text-align: center;">SEG 24</p>



The procedure of setting option(Cont.)

Step 3 Check the option you have set

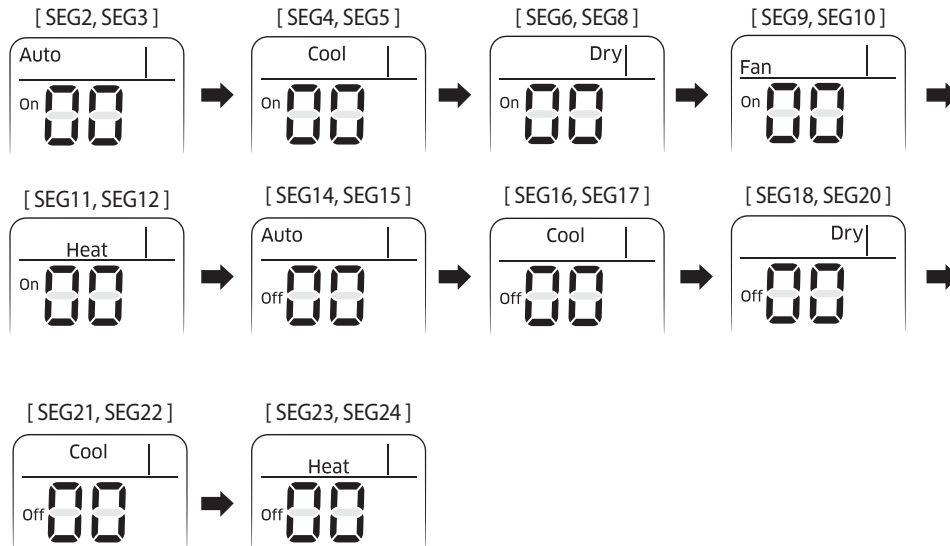
Check whether the option values that you have set are correct by pressing the  (Mode) button repeatedly



Step 4 Save the option values into the indoor unit

Point the remote control to the remote control sensor on the indoor unit and then press the  (Power) button on the remote control. Make sure that this command is received by the indoor unit; if it is not received, press the  (Power) button again.

Step 5 Check whether the air conditioner operates in accordance with the option values you have set

1. Reset the indoor unit by disconnecting and then reconnecting the power cable of the indoor unit or by pressing the RESET button on the outdoor unit.
2. Remove the batteries from the remote control, insert them again, and then press the  (Power) button on the remote control.

► **AR-KH00E remote control (for 360 cassette only)**

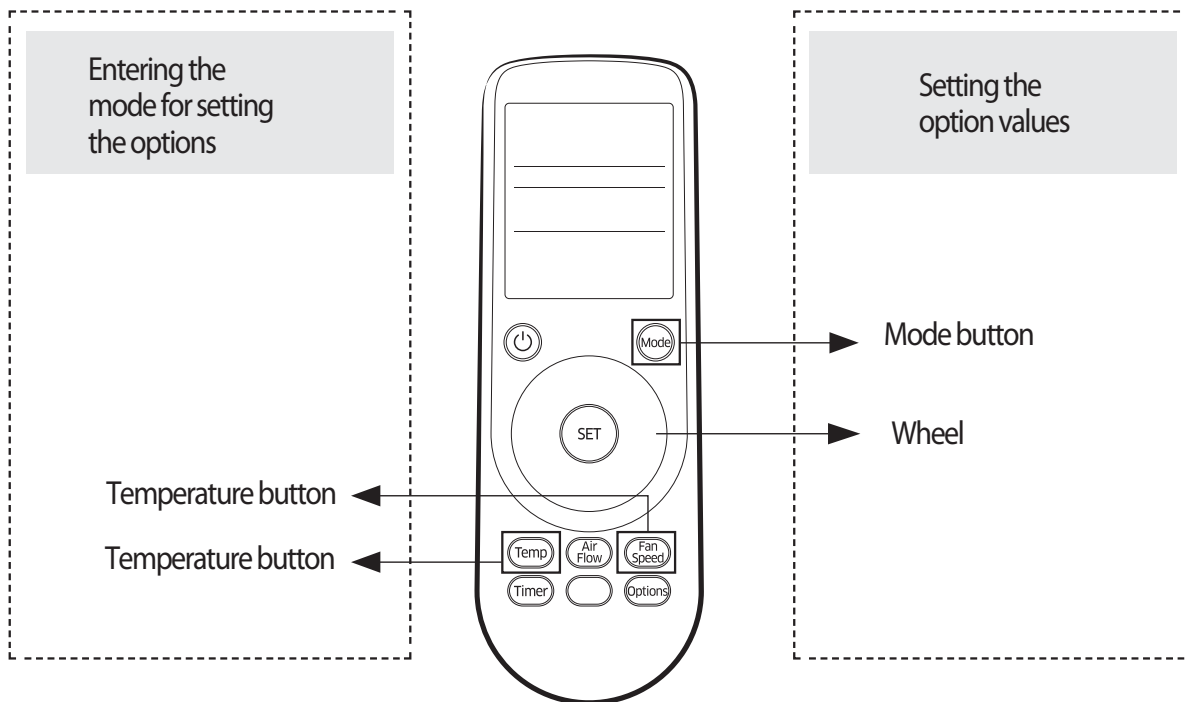

NOTE

The remote control display may vary depending on the model.

1 Enter the mode for setting the options:

- a Remove the batteries from the remote control.
- b While holding down the **Temp** (Temp) and **Timer** (Timer) buttons simultaneously, insert the batteries into the remote control.
- c Make sure that you are entered to the mode for setting the options:

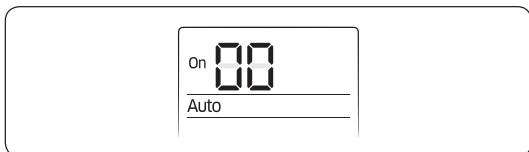









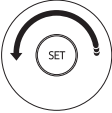

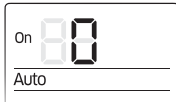

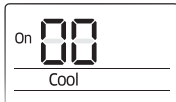
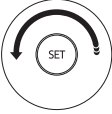
CAUTION

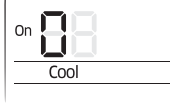
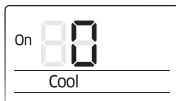



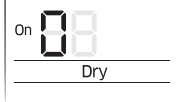
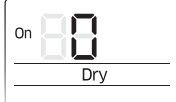





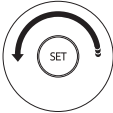

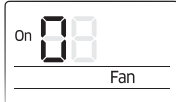

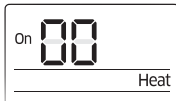

- The total number of available options are 24: SEG1 to SEG24.
- Because SEG1, SEG7, SEG13, and SEG19 are the page options used by the previous remote control models, the modes to set values for these options are skipped automatically.
- Set a 2-digit value for each option pair in the following order: SEG2 and SEG3 → SEG4 and SEG5 → SEG6 and SEG8 → SEG9 and SEG10 → SEG11 and SEG12 → SEG14 and SEG15 → SEG16 and SEG17 → SEG18 and SEG20 → SEG21 and SEG22 → SEG23 and SEG24

SEG1	SEG2	SEG3	SEG4	SEG5	SEG6	SEG7	SEG8	SEG9	SEG10	SEG11	SEG12	On (SEG1 to SEG12)	Off (SEG13 to SEG24)
0	X	X	X	X	X	1	X	X	X	X	X		
SEG13	SEG14	SEG15	SEG16	SEG17	SEG18	SEG19	SEG20	SEG21	SEG22	SEG23	SEG24		
2	X	X	X	X	X	3	X	X	X	X	X		

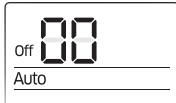



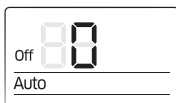

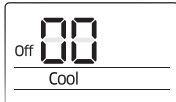

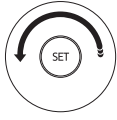
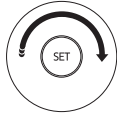
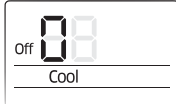
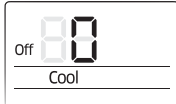

The procedure of setting option

Steps	Remote control display
<p>1 Set the SEG2 and SEG3 values:</p> <p>a Set the SEG2 value by rotating the Wheel counterclockwise until the value you want to set appears on the remote control display.</p>  <p>b Set the SEG3 value by rotating the Wheel clockwise until the value you want to set appears on the remote control display.</p>  <p>When you rotate the Wheel, values appear in the following order: 0 → 1 → ... E → F</p>	 <p>SEG 2</p>  <p>SEG 3</p>
<p>2 Press the  (Mode) button. Cool and On appear on the remote control display.</p>	
<p>3 Set the SEG4 and SEG5 values:</p> <p>a Set the SEG4 value by rotating the Wheel counterclockwise until the value you want to set appears on the remote control display.</p>  <p>b Set the SEG5 value by rotating the Wheel clockwise until the value you want to set appears on the remote control display.</p>  <p>When you rotate the Wheel, values appear in the following order: 0 → 1 → ... E → F</p>	 <p>SEG 4</p>  <p>SEG 5</p>
<p>4 Press the  (Mode) button. Dry and On appear on the remote control display.</p>	
<p>5 Set the SEG6 and SEG8 values:</p> <p>a Set the SEG6 value by rotating the Wheel counterclockwise until the value you want to set appears on the remote control display.</p>  <p>b Set the SEG8 value by rotating the Wheel clockwise until the value you want to set appears on the remote control display.</p>  <p>When you rotate the Wheel, values appear in the following order: 0 → 1 → ... E → F</p>	 <p>SEG 6</p>  <p>SEG 8</p>
<p>6 Press the  (Mode) button. Fan and On appear on the remote control display.</p>	

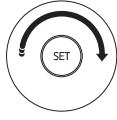
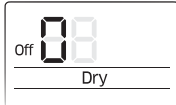
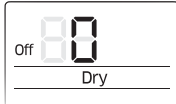

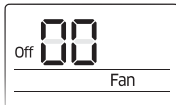

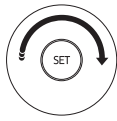
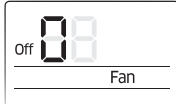
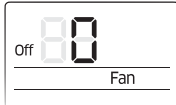
The procedure of setting option(Cont.)

Steps	Remote control display
<p>7 Set the SEG9 and SEG10 values:</p> <p>a Set the SEG9 value by rotating the Wheel counterclockwise until the value you want to set appears on the remote control display.</p>  <p>b Set the SEG10 value by rotating the Wheel clockwise until the value you want to set appears on the remote control display.</p>  <p>When you rotate the Wheel, values appear in the following order: 0 → 1 → ... E → F</p>	 <p>SEG 9</p>  <p>SEG 10</p>
<p>8 Press the  (Mode) button. Heat and On appear on the remote control display.</p>	
<p>9 Set the SEG11 and SEG12 values:</p> <p>a Set the SEG11 value by rotating the Wheel counterclockwise until the value you want to set appears on the remote control display.</p>  <p>b Set the SEG12 value by rotating the Wheel clockwise until the value you want to set appears on the remote control display.</p>  <p>When you rotate the Wheel, values appear in the following order: 0 → 1 → ... E → F</p>	 <p>SEG 11</p>  <p>SEG 12</p>
<p>10 Press the  (Mode) button. Auto and Off appear on the remote control display.</p>	
<p>11 Set the SEG14 and SEG15 values:</p> <p>a Set the SEG14 value by rotating the Wheel counterclockwise until the value you want to set appears on the remote control display.</p>  <p>b Set the SEG15 value by rotating the Wheel clockwise until the value you want to set appears on the remote control display.</p>  <p>When you rotate the Wheel, values appear in the following order: 0 → 1 → ... E → F</p>	 <p>SEG 14</p>  <p>SEG 15</p>
<p>12 Press the  (Mode) button. Cool and Off appear on the remote control display.</p>	

The procedure of setting option(Cont.)

Steps	Remote control display
<p>13 Set the SEG16 and SEG17 values:</p> <p>a Set the SEG16 value by rotating the Wheel counterclockwise until the value you want to set appears on the remote control display.</p>  <p>b Set the SEG17 value by rotating the Wheel clockwise until the value you want to set appears on the remote control display.</p>  <p>When you rotate the Wheel, values appear in the following order: 0 → 1 → ... E → F</p>	 <p>SEG 16</p>  <p>SEG 17</p>
<p>14 Press the  (Mode) button. Dry and Off appear on the remote control display.</p>	
<p>15 Set the SEG18 and SEG20 values:</p> <p>a Set the SEG18 value by rotating the Wheel counterclockwise until the value you want to set appears on the remote control display.</p>  <p>b Set the SEG20 value by rotating the Wheel clockwise until the value you want to set appears on the remote control display.</p>  <p>When you rotate the Wheel, values appear in the following order: 0 → 1 → ... E → F</p>	 <p>SEG 18</p>  <p>SEG 20</p>
<p>16 Press the  (Mode) button. Fan and Off appear on the remote control display.</p>	
<p>17 Set the SEG21 and SEG22 values:</p> <p>a Set the SEG21 value by rotating the Wheel counterclockwise until the value you want to set appears on the remote control display.</p>  <p>b Set the SEG22 value by rotating the Wheel clockwise until the value you want to set appears on the remote control display.</p>  <p>When you rotate the Wheel, values appear in the following order: 0 → 1 → ... E → F</p>	 <p>SEG 21</p>  <p>SEG 22</p>
<p>18 Press the  (Mode) button. Heat and Off appear on the remote control display.</p>	

The procedure of setting option(Cont.)

Steps	Remote control display
<p>19 Set the SEG23 and SEG24 values:</p> <p>a Set the SEG23 value by rotating the Wheel counterclockwise until the value you want to set appears on the remote control display.</p>  <p>b Set the SEG24 value by rotating the Wheel clockwise until the value you want to set appears on the remote control display.</p>  <p>When you rotate the Wheel, values appear in the following order: 0 → 1 → ... E → F</p>	 <p>SEG 23</p>  <p>SEG 24</p>

4-1-3. Order for Setting Options (Wired Remote Controller)

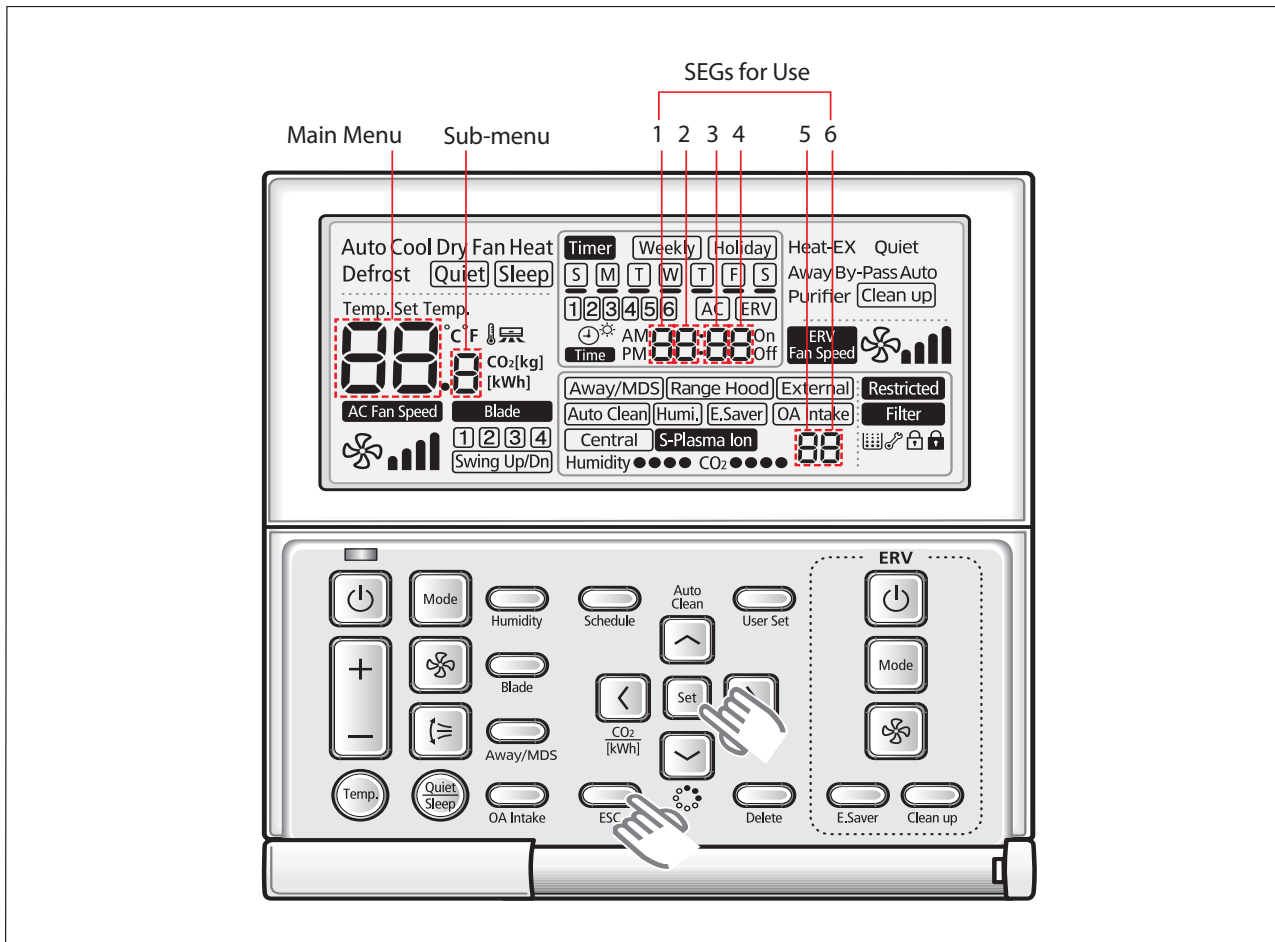

1. If you want to use the various additional functions for your Wired Remote Controller, press the **Set** and **Esc** buttons at the same time for more than three seconds.
 - ▶ You will enter the additional function settings, and the [main menu] will be displayed.
2. Refer to the list of additional functions for your Wired Remote Controller on the next page, and select the desired menu.
 - ▶ Using the [^]/[v] buttons, select a main menu number and press the [>] button to enter the sub-menu setting screen.
 - ▶ Using the [^]/[v] buttons, select a sub-menu number and press the [>] button to enter data setting screen.
 - ▶ When you enter the setting stage, the current setting will be displayed.
 - ▶ Refer to the chart for data settings.
 - ▶ Using the [^]/[v] buttons, select the settings. Press the [>] button to move to the next setting.
 - ▶ Press the **Set** button to save the settings and exit to the sub-menu setting screen.
 - ▶ Press the **Esc** button to exit to normal mode.

NOTE

- While setting the data, you can use the [<]/[>] buttons to set the range of Data bit.
- While configuring the setting, press the **Esc** button to exit to the setting sub-menu without saving your changes.

4-1-4. Indoor address(MAIN/RMC)setting

Before installing an indoor unit, be sure to set an address for the indoor unit by taking the following steps:

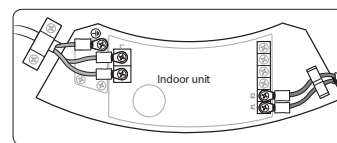

1. Make sure that the power is supplied to the indoor unit. If the indoor unit is not plugged in, it must include a power supply.
 2. Make sure that the panel is connected to the indoor unit so that it can receive options
 3. Set an address for each indoor unit using the remote control, according to your air conditioning system plan, by referring to the following table and by following the steps in Common steps for setting the addresses and options on page 16.
- The indoor unit addresses (main and RMC addresses) are set to 0A0000-100000-200000-300000 by default.
 - If indoor units and outdoor units match 1:1, you don't need to set the addresses.
 - The main address of each indoor unit is set automatically. However, you can set the main address manually if the relevant outdoor option is set to MANUAL ADDRESS.

Option No. for an indoor unit address: 0AXXXX-1XXXX-2XXXX-3XXXX

Option	SEG1		SEG2		SEG3		SEG4	SEG5		SEG6	
Function	Page		Mode		Setting main address		Reserved	Reserved		Indoor unit number	
Indication and details	Indication	Details	Indication	Details	Indication	Details				Indication	Details
	0		A		0	No main address				1	Main address setting mode
Option	SEG7		SEG8		SEG9		SEG10	SEG11		SEG12	
Function	Page		Reserved		Setting RMC address		Reserved	Group channel (x16)		Group address	
Indication and details	Indication	Details			Indication	Details		Indication	Details	Indication	Details
	1				0	No RMC address		1	RMC address setting mode	RMC1	0 to 2

- The main address must be set to a value in the range 0 to 3. If you set other values, communication error will occur.
- If any of SEG5 and SEG6 is set to a value in the range A to F, the main address of the indoor unit does not change.
- If SEG3 is set to 0, the indoor unit maintains the existing main address even if SEG6 is set to a new value.
- If SEG9 is set 0, the indoor unit maintains the existing RMC address even if SEG11 and SET12 are set to new values.

4-1-5. Set the indoor installation options(Option to set for the installation site conditions)

1. Make sure that the power is supplied to the indoor unit.
If the indoor unit is not plugged in, it must include a power supply.
2. Make sure that the panel is connected to the indoor unit so that it can receive options

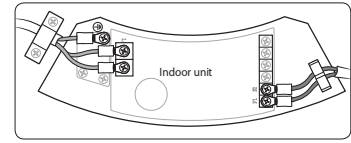

3. Set the functional options of indoor units, by referring to the following table and by following the steps in

Common steps for setting the addresses and options on page 16.

- The functional options of indoor units are set to 020000-100000-200000-300000 by default.
- The SEG20 option, Individual control with remote control, allows you to control multiple indoor units individually by using the remote control.

Option No. for an indoor unit address:02XXXX-1XXXXX-2XXXXX-3XXXXX

Option	SEG1		SEG2		SEG3		SEG4		SEG5		SEG6	
Function	Page		Mode		Reserved		Use of external temperature sensor		Use of central control		Compensation of the fan RPM	
Indication and details	Indication	Details	Indication	Details			Indication	Details	Indication	Details	Indication	Details
		0		2				0	Disuse	0	Disuse	0
							1	Use	1	Use	4	Disuse (exposed installation)
											5	High-ceiling mode (exposed installation)
Option	SEG7		SEG8		SEG9		SEG10		SEG11		SEG12	
Function	Page		Use of drain pump		Reserved		Reserved		Reserved		Reserved	
Indication and details	Indication	Details	Indication	Details								
	1		0	Disuse								
			1	Use								
			2	Use with 3 minute delay								
Option	SEG13		SEG14		SEG15		SEG16		SEG17		SEG18	
Function	Page		Use of external control		Setting the output of external control		S-Plasma ion		Buzzer control		Maximum filter usage time	
Indication and details	Indication	Details	Indication	Details	Indication	Details	Indication	Details	Indication	Details	Indication	Details
	2		0	Disuse	0	thermo on	0	Disuse	0	Use of buzzer	2	1000 hours
			1	On/Off control	1	Operation on	1	Use	1	Disuse of buzzer	6	2000 hours
			2	Off control								
Option	SEG19		SEG20		SEG21		SEG22		SEG23		SEG24	
Function	Page		control with remote control		Heating setting compensation		No function assigned		No function assigned		Cycle time of Swing	
Indication and details	Indication	Details	Indication	Details	Indication	Details						
	3		0 or 1	Indoor 1	0	Disuse						
			2	Indoor 2	1	2°C						
			3	Indoor 3	2	5°C						
			4	Indoor 4						0	34 seconds (default)	
										1	30 seconds	
										2	38 seconds	

- Even if you set the Use of drain pump (SEG8) option to 0, it is automatically set to 2 (the drain pump is used with 3 minute delay).
- If you set the Maximum filter usage time (SEG18) option to a value other than 2 and 6, it is automatically set to 2 (1000 hours).
- If you set the Individual control with remote control (SEG20) option to a value other than 0 to 4, it is automatically set to 0 (Indoor 1).
- Even if you set the Heating setting compensation (SEG21) option to 0, it is automatically set to 2 (the setting is compensated by 5°C).

4-1-6. Changing the addresses and options individually

When you want to change the value of a specific option, refer to the following table and follow the steps in Common steps for setting the addresses and options

Option	SEG1		SEG2		SEG3		SEG4		SEG5		SEG6	
Function	Page		Mode		Type of the option to change		Tens position of the option number		Units position of the option number		New value	
Indication and details	Indication	Details	Indication	Details	Indication	Details	Indication	Details	Indication	Details	Indication	Details
		0		D		Option type	0 to F	Tens position value	0 to 9	Units position value	0 to 9e	New value

Example: Changing the Buzzer control (SEG17) option of the functional options to 1 disuse.

Option	SEG1		SEG2		SEG3		SEG4		SEG5		SEG6	
Function	Page		Mode		Type of the option to change		Tens position of the option number		Units position of the option number		New value	
Indication	0		D		2		1		7		1	

4-2. Model-specific option code

Model	SEG1	SEG2	SEG3	SEG4	SEG5	SEG6	SEG7	SEG8	SEG9	SEG10	SEG11	SEG12
AC071MN4PKH	0	1	1	0	7	F	1	9	5	4	A	F
AC090MN4PKH	0	1	0	0	7	F	1	9	5	4	7	C
AC100MN4PKH	0	1	0	0	7	F	1	9	5	4	8	C
AC120MN4PKH	0	1	0	0	7	F	1	9	5	4	9	D
AC140MN4PKH	0	1	1	0	7	F	1	9	5	4	A	F
Model	SEG13	SEG14	SEG15	SEG16	SEG17	SEG18	SEG19	SEG20	SEG21	SEG22	SEG23	SEG24
AC071MN4PKH	2	7	8	C	A	0	3	7	0	0	4	0
AC090MN4PKH	2	7	5	A	6	4	3	7	0	0	4	0
AC100MN4PKH	2	7	6	4	7	0	3	7	0	0	4	0
AC120MN4PKH	2	7	7	8	8	2	3	7	0	0	4	0
AC140MN4PKH	2	7	8	C	A	0	3	7	0	0	4	0

4-3. Diagnostic Checklist ago

4-3-1. Test operation mode and check mode

■ Display Options key

KEY	Push type		Mode	Display			
				SEG1	SEG2	SEG3	SEG4
K1	Short	1st	Heating test mode	H	1	8	8
		2nd	Defrost test mode※	H	3	8	8
		3rd	Stop	8	8	8	8
K2	Short	1st	Cooling test	H	2	8	8
		2nd	Inverter check	H	4	8	8
		3rd	Pump down	H	6	8	8
K3	Short	1st	Reset Release Eco mode	8	8	8	8



< AC090/100/120/140MXAD*H >

※ Defrost test mode

Condition 1: The outdoor temperature is below 10°C.

Condition 2: All the temperature conditions should meet the defrost conditions.

■ Verify mode display

※ Pressing the K4 switch, you can view the following information about the system status

Short push	Screen content	SEG1	SEG2	SEG3	SEG4	Unit
1	Oder Frequency	1	Hundreds digit	Tens digit	Units digit	Hz
2	Current Frequency	2	Hundreds digit	Tens digit	Units digit	Hz
3	The number of current indoor units	3	Hundreds digit	Tens digit	Units digit	Unit
4	The sensor for outdoor air intake	4	+/-	Tens digit	Units digit	°C
5	Discharge sensor	5	Hundreds digit	Tens digit	Units digit	°C
6	Eva-Mid sensor	6	+/-	Tens digit	Units digit	°C
7	Cond sensor	7	+/-	Tens digit	Units digit	°C
8	Current	8	Tens digit	Units digit	The first place of decimals	A
9	Fan RPM	9	Thousands digit	Hundreds digit	Tens digit	rpm
10	Target discharge temperature	A	Hundreds digit	Tens digit	Units digit	°C
11	EEV	B	Hundreds digit	Tens digit	Units digit	step
12	The capacity sum of indoor units	C	Tens digit	Unit digit	The first place of decimals	kW
13	Protective control	D	0: Cooling 1: Heating	Protective control 0: No Protective control 1: Freezing 2: Non-stop defrosting 3: Over-load 4: Discharge 5: Total electric current	Frequency status 0: Normal 1: Hold 2: Down 3: Up_limit 4: Down_limit	-
14	The temperature of heat radiating plate	E	Hundreds digit	Tens digit	Units digit	-
15	S/W check	F	-	-	-	-

Long push 1	Main micom version	Year (Hex)	month (Hex)	Date (Tens digit)	Date (Units digit)
After short push 1	Inverter micom version	Year (Hex)	month (Hex)	Date (Tens digit)	Date (Units digit)
After short push 1	E2P version	Year (Hex)	month (Hex)	Date (Tens digit)	Date (Units digit)

※ Press and hold the K4 button(The main micom version) → Press once more shortly → Press once more shortly(E2P version)

■ K3 switch

standby mode(Eco Mode) release

■ DIP switch options

	Off (default)	Off
switch 1	Auto address	Manual address
switch 2	-	-
switch 3	Disable snow prevention control	Enable snow prevention control
switch 4	-	-

※ • Snow-proof control when using eco mode (standby mode) is not working.

4-3-2. Eco Mode [Power Save Mode]



< AC090/100/120/140MXAD*H >

Models series	AC090/100/120/140MXAD*H				Eco-mode lamp
mode	Display				Red color
	SEG 1	SEG 2	SEG 3	SEG 4	
Eco Mode	"BLANK"	"BLANK"	"BLANK"	"BLANK"	On
Eco Mode Exit	Press K3 to go out from the eco mode. At the driving signal or test run (cooling/heating) of the user, the mode is released.				Off

4-3-3. Error code [indoor]



Ice blue	Yellow green
Blue	Red

Condition	Indoor unit display indications			
	Ice blue	Yellow green	Blue	Red
Power reset (blinking once every 2 seconds)	●	x	x	x
In the defrost operation (blinking once every 10 seconds)	●	x	x	x
Open or short circuit error of the indoor -taturempere sensor	x	x	x	●
Error of the out door unit	x	x	●	x
Communication error between the indoor and out door units	x	●	x	x
Open or short circuit error of a sensor (evaporator-in, evaporator-out, or discharge sensor) in the indoor unit	x	●	x	●
Error of the fan in the indoor unit	x	x	●	●
Error of the second detection of the float switch	x	●	●	x
Open circuit error of the thermal fuse	●	x	●	x
EEPROM error	●	●	x	●

● : On, ● : Blinking, X : Off

4-3-4. Error code [outdoor]

NO	Error code	Remarks	Remarks
1	E108	Error due to repeated communication address	Check on repeated indoor unit main address
2	E121	Error on room temperature sensor of indoor unit (Short or Open)	Indoor unit Room Thermistor Open/Short
3	E122	Error on EVA IN sensor of indoor unit (Short or Open)	Indoor unit EVA_IN Thermistor Open/Short
4	E123	Error on EVA OUT sensor of indoor unit (Short or Open)	Indoor unit EVA_OUT Thermistor Open/Short
5	E143	Motion detection sensor error	Check motion detection sensor
6	E153	Error on float switch (2nd detection)	Indoor unit Float Switch Open/Short Drain Pump operation Check
7	E154	Indoor fan error	Check on indoor unit indoor Fan operation
8	E162	EEPROM error (Hardware)	Check the EEPROM PBA
9	E163	EEPROM option error	Set the option setting
10	E198	Error on thermal fuse of indoor unit (Open)	Thermal Fuse Open Check of indoor unit Terminal Block
11	E201	Communication error between indoor unit and outdoor unit (Pre tracking failure or when actual number of indoor units are different from the indoor unit quantity setting on the outdoor unit) Error due to communication tracking failure after initial power is supplied. (The error occurs regardless of the number of units.)	Check indoor quantity setting in outdoor
12	E202	Communication error between indoor unit and outdoor unit (When there is no response from indoor units after tracking is completed)	Check electrical connection and setting between indoor unit and outdoor unit
13	E203	Communication error between outdoor unit inv - main micom(For PF #4~#6 controller, error will be determined from the time when compressor is turned on)	Check electrical connection and setting between indoor unit MAIN PBA - INVERTER PBA
14	E221	Error on outdoor temperature sensor (Short or Open)	Check Outdoor sensor Open / Short
15	E231	Error on outdoor COND OUT sensor (Short or Open)	Check Cond-Out sensor Open / Short
16	E251	Error on discharge temperature sensor of compressor 1 (Short or Open)	Check Discharge sensor Open / Short
17	E320	Error on OLP sensor (Short or Open)	Check OLP sensor Open / Short
18	E403	Compressor down due to freeze protection control	Check Outdoor Cond.
19	E404	System stop due to overload protection control	Check Comp. when it start
20	E416	System stop due to discharge temperature	1. Check the refrigerant leakage 2. Relocate the outdoor unit
21	E422	Blockage detected on high pressure pipe	1. Check if the service valve is open 2. Check for refrigerant leakage (pipe connections, heat exchanger) and charge refrigerant if necessary 3. Check if there's any blockage on refrigerant cycle(indoor unit/outdoor unit) 4. Check if additional refrigerant has been added after pipe extension
22	E425	Reverse phase or open phase	Check whether 3 phase is reversed or opened.

Error code [outdoor] (cont.)

NO	Error code	Remarks	Remarks
23	E440	Heating operation restricted at outdoor temperature over Theat_high value	1. Check the range of temperature limited for heating operation 2. Check the outdoor temperature sensor
24	E441	Cooling operation restricted at outdoor temperature below Tcool_low value	1. Check the range of temperature limited for cooling operation 2. Check the outdoor temperature sensor
25	E458	Fan speed error	Check the fan1 and outdoor inverter PBA
26	E461	Error due to operation failure of inverter compressor	1. Check the outdoor Inverter PBA 2. Check the compressor
27	E462	System stop due to full current control	Relocate the outdoor unit
28	E463	Over current trip / PFC over current error	Check the OLP sensor
29	E464	IPM Over Current	1. Check the state of refrigerant 2. Check the compressor 3. Check if the service valve is open
30	E465	Comp. Over load error	1. Check if the service valve is open 2. Check the pressure of refrigerant 3. Check if the Fan Motor is running 4. Check the outdoor inverter PBA and the compressor
31	E466	DC-Link voltage under/over error	Check AC Power and DC Link Voltage
32	E467	Error due to abnormal rotation of the compressor or unconnected wire of compressor	Check the compressor wire
33	E468	Error on current sensor (Short or Open)	Check the outdoor inverter PBA
34	E469	Error on DC-Link voltage sensor (Short or Open)	1. Check AC Power and DC Link Voltage 2. Check the outdoor inverter PBA
35	E470	Outdoor unit EEPROM Read/Write error (Option)	Check the outdoor EEPROM data
36	E471	Outdoor unit EEPROM Read/Write error (H/W)	Check the outdoor EEPROM PBA
37	E474	Error on IPM Heat Sink sensor of inverter 1 (Short or Open)	Check the outdoor inverter PBA
38	E475	Error on inverter fan 2	Check the fan2 and outdoor inverter PBA
39	E483	H/W DC_Link Over Voltage Error	Check AC Power and DC Link Voltage
40	E484	PFC Overload (Over current) Error	Check the outdoor inverter PBA
41	E485	Error on input current sensor of inverter 1 (Short or Open)	Check the outdoor inverter PBA
42	E488	AC Input Voltage Sensor Error	Check AC Power and DC Link Voltage
43	E500	IPM over heat error on inverter 1	Check Outdoor Inverter PBA.
44	E554	Gas leak detected	Check the refrigerant leakage
45	E556	Error due to mismatching capacity of indoor and outdoor unit	Check the indoor and Outdoor unit Capacity
46	E590	Inverter EEPROM CheckSum error	1. Reboot the EEPROM 2. Check the outdoor inverter PBA and the main PBA

4-3-5 Wired remote controller

- If an error occurs, () icon will be displayed on the wired remote controller.
- Press the Test button to see the error code.

Error mode	Contents	Measure	Product operation in error condition	Error type
			Outdoor unit/Compressor/Indoor unit	
101	Indoor unit communication error	Check the communication cable of indoor unit. Check the DC output voltage at the communication terminal.	Operation Off	Communication error
108	Duplicated address setting error	Check address setting of Indoor units.	Operation Off	Communication error
109	No response error address from indoor unit	Check indoor unit's quantity setting in outdoor unit. Check electrical connection and setting.	Operation Off	Communication error
121	Indoor temperature sensor (open/short error)	Check indoor unit room temperature sensor. Check indoor unit PCB connector CN41. (White)	Operation Off	Indoor sensor error
122	Indoor unit Eva In sensor (Open/Short)	Check indoor unit pipe sensor. Check indoor PCB connector CN41.(White)	Operation Off	Indoor sensor error
153	Indoor floating switch secondary detection	Check indoor unit float sensor. Check indoor PCB connector CN5. (black)	Operation Off	Self diagnostic error
202	Indoor/outdoor communication error (1 min)	Check the communication connection between indoor and outdoor units. Check the power line and communication cable connection status	Operation Off	Communication error
203	Communication error between indoor/outdoor INV↔MAIN MICOM (1 min)	Check MAIN MICOM . Check INVERTER MICOM.	-	Communication error
221	Outdoor temperature sensor error	Check sensor connection status. Check sensor location. Check sensor resistance.	Operation Off	Outdoor sensor error
231	COND temperature sensor error	Check sensor connection status. Check sensor location. Check sensor resistance.	Operation Off	Outdoor sensor error
251	[Inverter] Emission temperature sensor error	Check sensor connection status. Check sensor location. Check sensor resistance.	Operation Off	Outdoor sensor error
403	Detection of Indoor Freezing (when Comp. Stops)	Check whether the indoor unit air intake is blocked. Check the operation of the indoor fan.	Operation Off	Outdoor unit protection control error
404	Protection of Outdoor Overload (when Comp. Stops)	Check sensor connection status. Check sensor location. Check sensor resistance.	Operation Off	Outdoor unit protection control error
416	Emission temperature excessively high	No error. (DISCHARGE temperature control)	-	Outdoor unit protection control error
422	High pressure blockage error (Refrigerant completely Leakage error)	Check whether the outdoor unit service valve is open. Check the connection of the pipes. Check the operation of the EEV. Check for refrigerant leakage. (Completely leakage).	Operation Off	Self diagnostic error
440	Heating operation blocked	Check the operation setting state. Check temperature sensor.	Operation Off	Self diagnostic error
441	Cooling operation blocked	Check the operation setting state . Check temperature senso.	Operation Off	Self diagnostic error
458	Outdoor fan 1 error	Check input power connection status. Check the connection status between the motor and outdoor unit PCB. Check indoor/outdoor fuse.	Operation Off	Self diagnostic error

Wired remote controller (cont.)

Error mode	Contents	Measure	Product operation in error condition	Error type
			Outdoor unit/ Compressor/ Indoor unit	
461	[Inverter] Compressor startup error	Check the compressor connection status. Check the resistance between difference phases of the compressor.	Operation Off	Outdoor unit protection control error
462	[Inverter] Total current error/ PFC over current error	Check the input power Check the coolant charging status Check the normal operation of outdoor fan	Operation Off	Outdoor unit protection control error
463	OLP Overheat and Comp. Stop	Reconfirm the opening of the service valve. Check for leaks from the connection part of the pipe and product or from the pipe joint. Change the outdoor unit location and direction. Refill the coolant after checking the leaking part. Reinstall the outdoor unit set.	Operation Off	Outdoor unit protection control error
464	[Inverter] IPM over current error	Check coolant charging Check the compressor connection status and normal operation Check the obstacles around the indoor and outdoor units Check whether the outdoor unit service valve is open Check whether the indoor/outdoor installation pipe/wiring are correct	Operation Off	Outdoor unit protection control error
465	Compressor V limit error	Check the compressor connection status Check the resistance between difference phases of the compressor	Operation Off	Outdoor unit protection control error
466	DC LINK over/low voltage error	Check input power Check AC power connection	Restart in 3 minutes	Outdoor unit protection control error
467	[Inverter] Compressor rotation error	Check the compressor connection status Check the resistance between difference phases of the compressor	Operation Off	Outdoor unit protection control error
468	[Inverter] Current sensor error	Check EEPROM DATA Check the normal operation of PCB	Operation Off	Outdoor unit protection control error
469	[Inverter] DC LINK voltage sensor error	Check the input power connection Check the status of RY21 and R200 in the INVERTER PCB	Operation Off	Outdoor unit protection control error
470	EEPROM Read/Write error	-	Operation Off	Outdoor unit protection control error
471	[Inverter] OTP error	Check EEPROM DATA Check the normal operation of PCB	Operation Off	Outdoor unit protection control error
472	AC ZERO CROSSING SIGNAL OUT error	Check the input power status	Operation Off	Outdoor unit protection control error
473	Compressor LOCK error	Check the compressor connection status Check the resistance between difference phases of the compressor	Operation Off	Outdoor unit protection control error

Wired remote controller (cont.)

Error mode	Contents	Measure	Product operation in error condition	Error type
			Outdoor unit/ Compressor/ Indoor unit	
475	Outdoor fan 2 error	Check the input power connection status Check the connection status of the motor and the outdoor unit PCB Check the indoor/outdoor unit fuse	Operation Off	Self diagnostic error
500	IPM Overheat Error for Outdoor Unit Inverter Comp.	Change the location of the outdoor unit if the temperature is abnormally high when the heatproof plate is checked. Reconnect the screws. Replace the outdoor unit fan. Replace the PBA of the outdoor unit.	Operation Off	Outdoor unit protection control error
554	Gas leak error	Check the coolant charging status Check the indoor EVA sensor Check if the outdoor unit service valve is open Check that the indoor/outdoor installation pipe/wiring are correct	Operation Off	Self diagnostic error
556	Capacities not matched	Check the option code of the indoor unit	Operation Off	Outdoor unit protection control error
601	Communication error between the indoor unit and wired remote controller	Check the connection wire between the indoor unit and the wired remote controller	Normal operation	Wired remote controller error
602	Communication error between the Master and Slave wired remote controllers	Check the option switch for defining the Master and Slave (only one Master and one Slave can exist)	Normal operation	Wired remote controller error
606	COM1/COM2 cross installation error	Check that wired remote controller is connected to the COM2 terminal of the indoor unit	Normal operation	Wired remote controller error
8ER	Wired remote controller COM2 option setting error	Check that Com1, Com2 setting DIP switch is set to Com2	Normal operation	Wired remote controller error

4-4. Troubleshooting by symptoms

4-4-1. When the indoor unit power is not ON – Initial Diagnosis : 1-phase products

1. Test items

- 1) Check the power connection of indoor/outdoor unit and check the power wire of Terminal Block.
- 2) Check the connection of the power wire between the Power PCB ↔ Main PCB DC of indoor unit. (Check after turning off the power of the Terminal Box!)
- 3) Check the power supply parts. (Check after turning off the power of the Terminal Box!)
- 4) Check everything is normal after separating the fan motor connector and resetting the power. (Separate the connector after turning off the power of the Terminal Box! When detaching and attaching the connector during power supply, the motor can be damaged.)

2. Check procedure

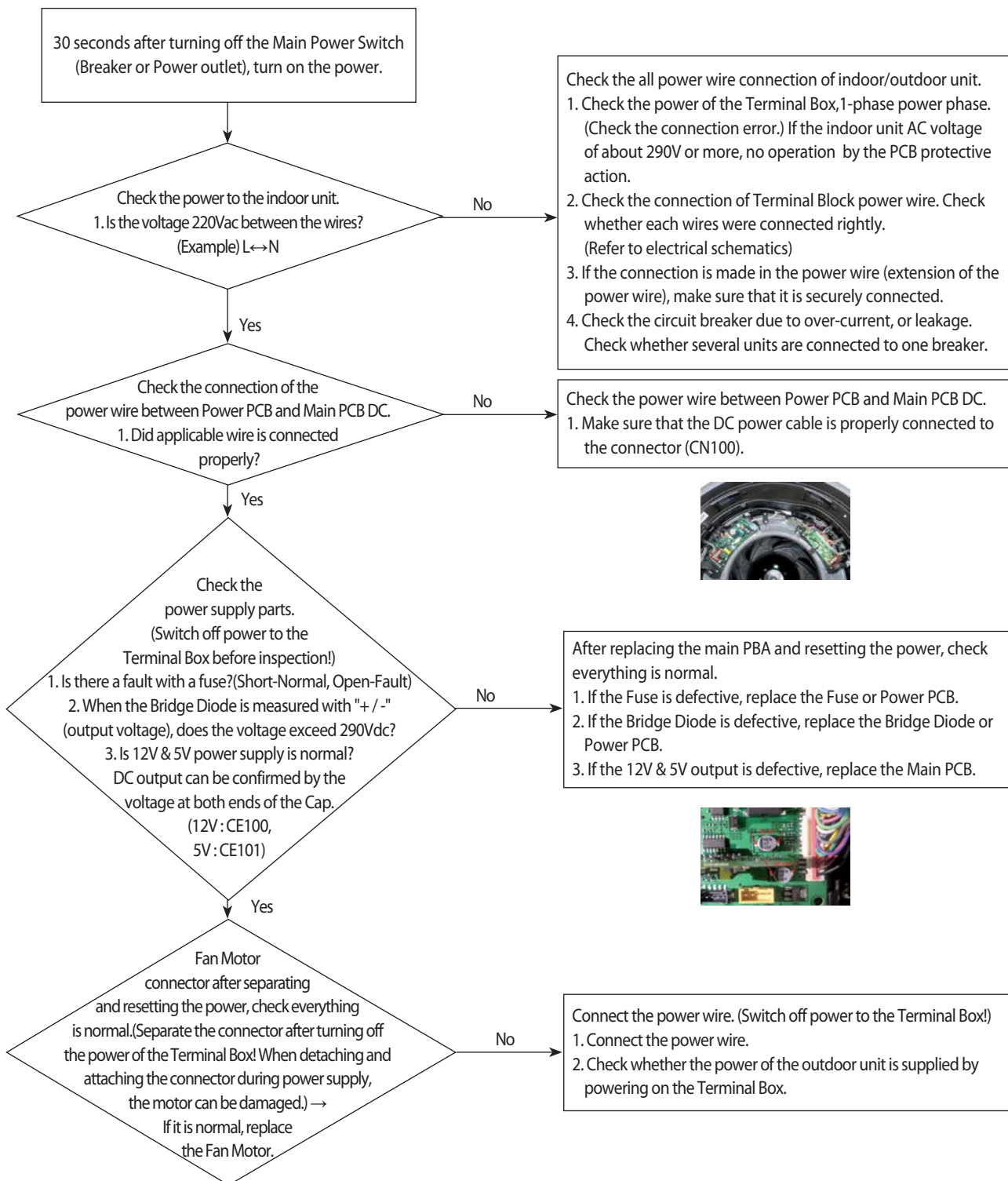

4-4-2. Indoor temperature sensor error (E121)

Indoor unit display	360 Cassette	x(Ice blue) x(Yellow green) x(Blue) ●(Red)
Judgment method	Refer to checking method, as shown below.	
Symptom	If the indoor temperature sensor is open or short circuit.	

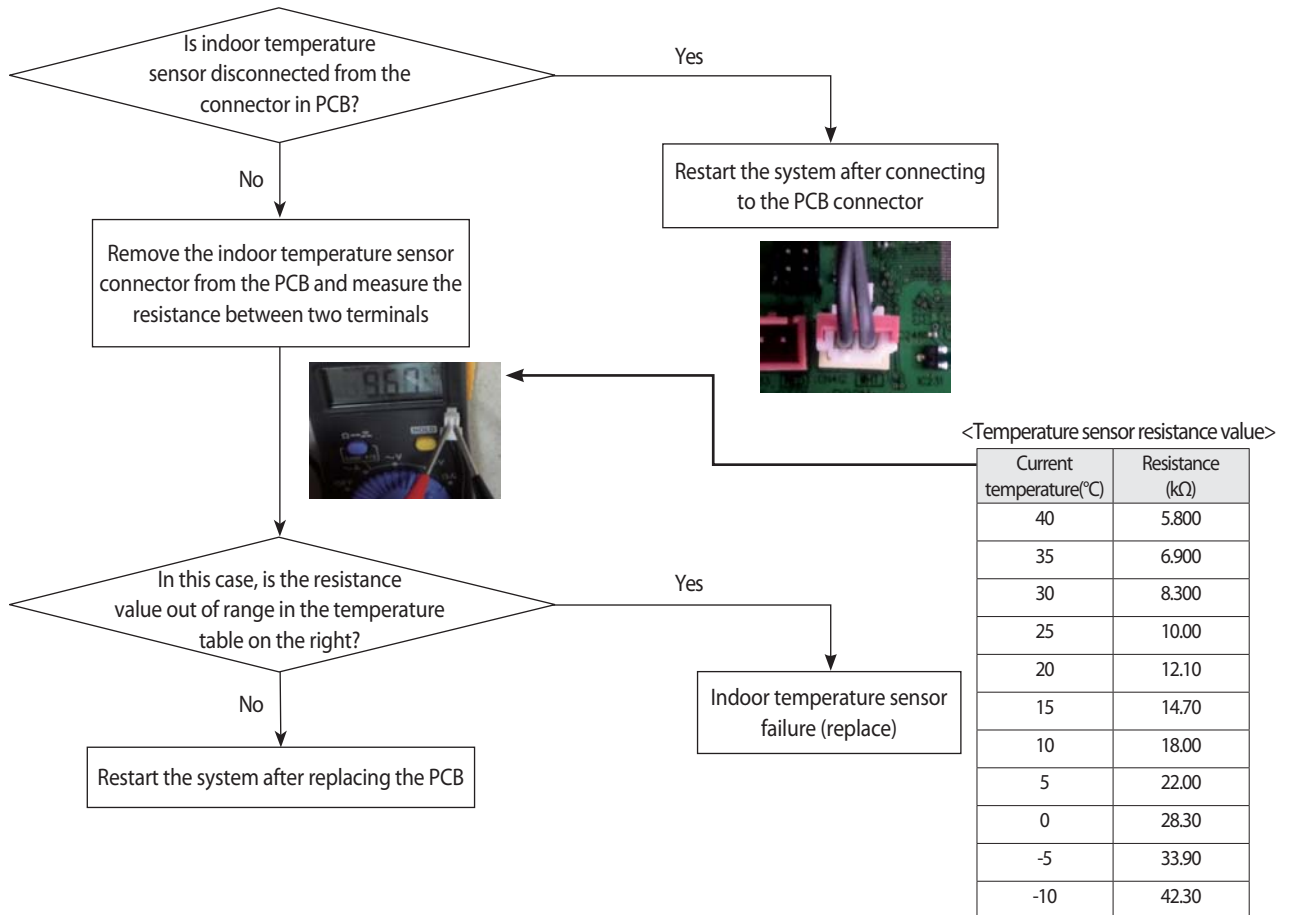

4-4-3. Indoor heat exchanger temperature sensor error (E122)

Indoor unit display	360 Cassette	x(Ice blue) ●(Yellow green) x(Blue) ●(Red)
Judgment method	Refer to checking method, as shown below	
Symptom	If the short or open circuit of indoor heat exchanger temperature sensor.	

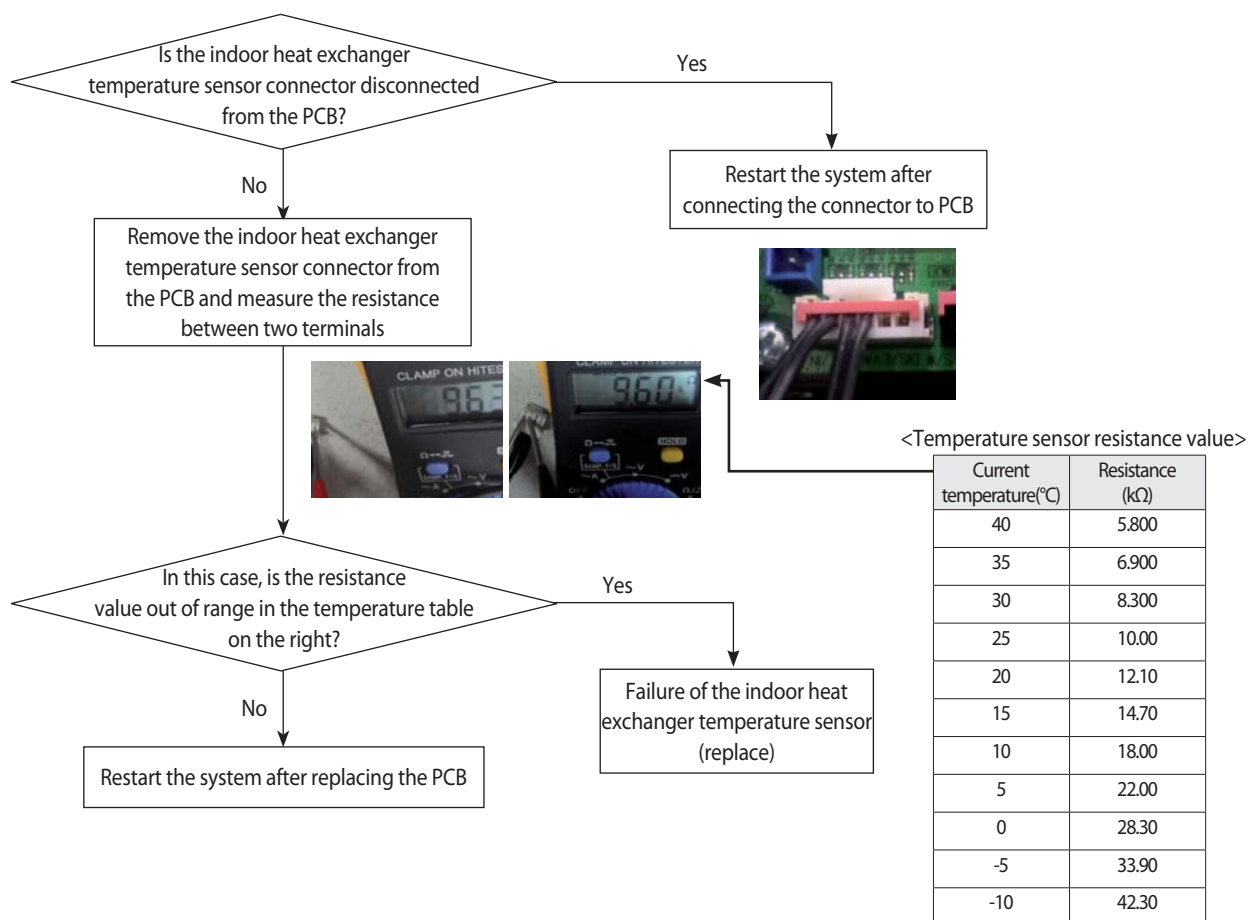

4-4-4. Indoor Fan error (E154)

Indoor unit display	360 Cassette	x(Ice blue) x(Yellow green) ●(Blue) ●(Red)
Judgment method	Refer to checking method, as shown below	
Symptom	If the motor connector break away / Indoor unit Fan does not operate by motor or PBA defectiveness.	

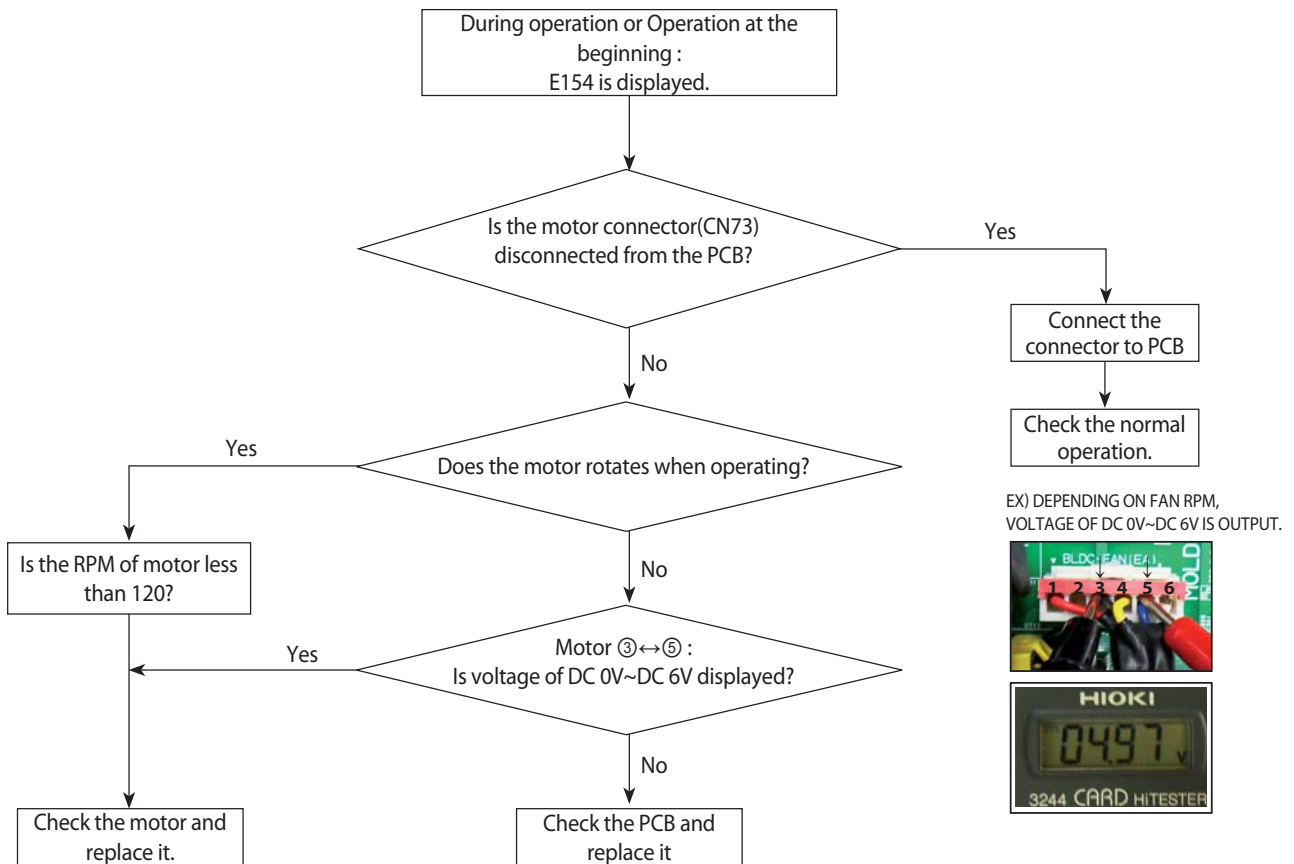

[1-way cassette model]

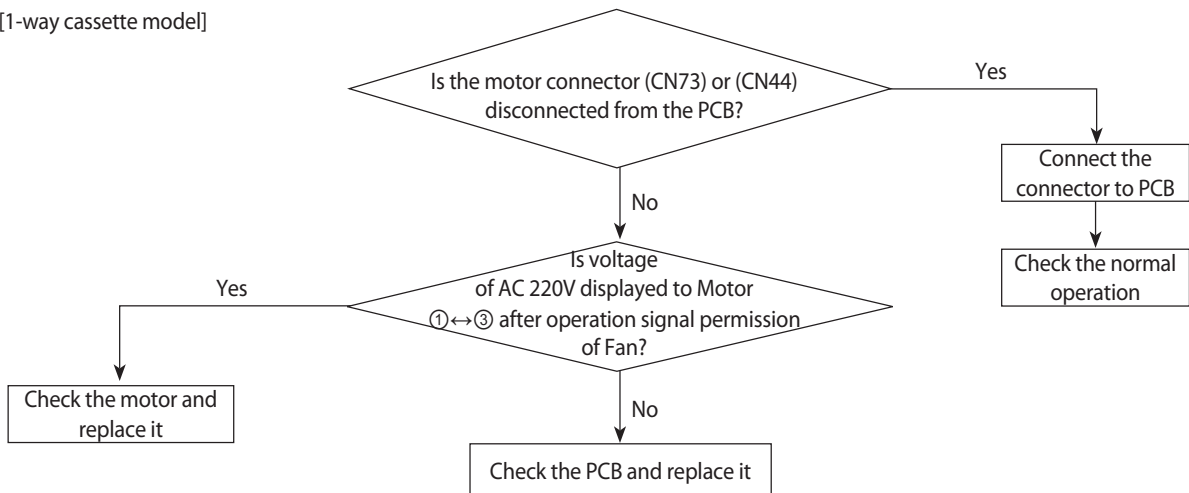

4-4-5. Communication error after finishing Tracking (E202)

Indoor unit display	360 Cassette	x(Ice blue) ●(Yellow green) x(Blue) x(Red)
Judgment method	Refer to checking method, as shown below	
Symptom	If the communication error between the indoor and outdoor unit for two minutes.	

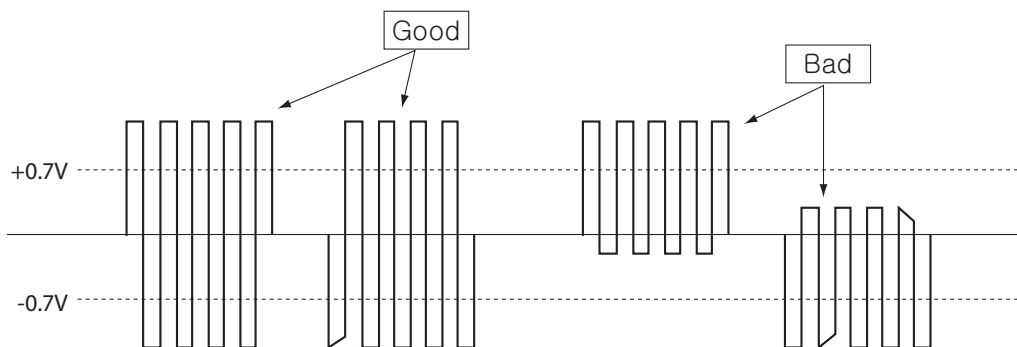
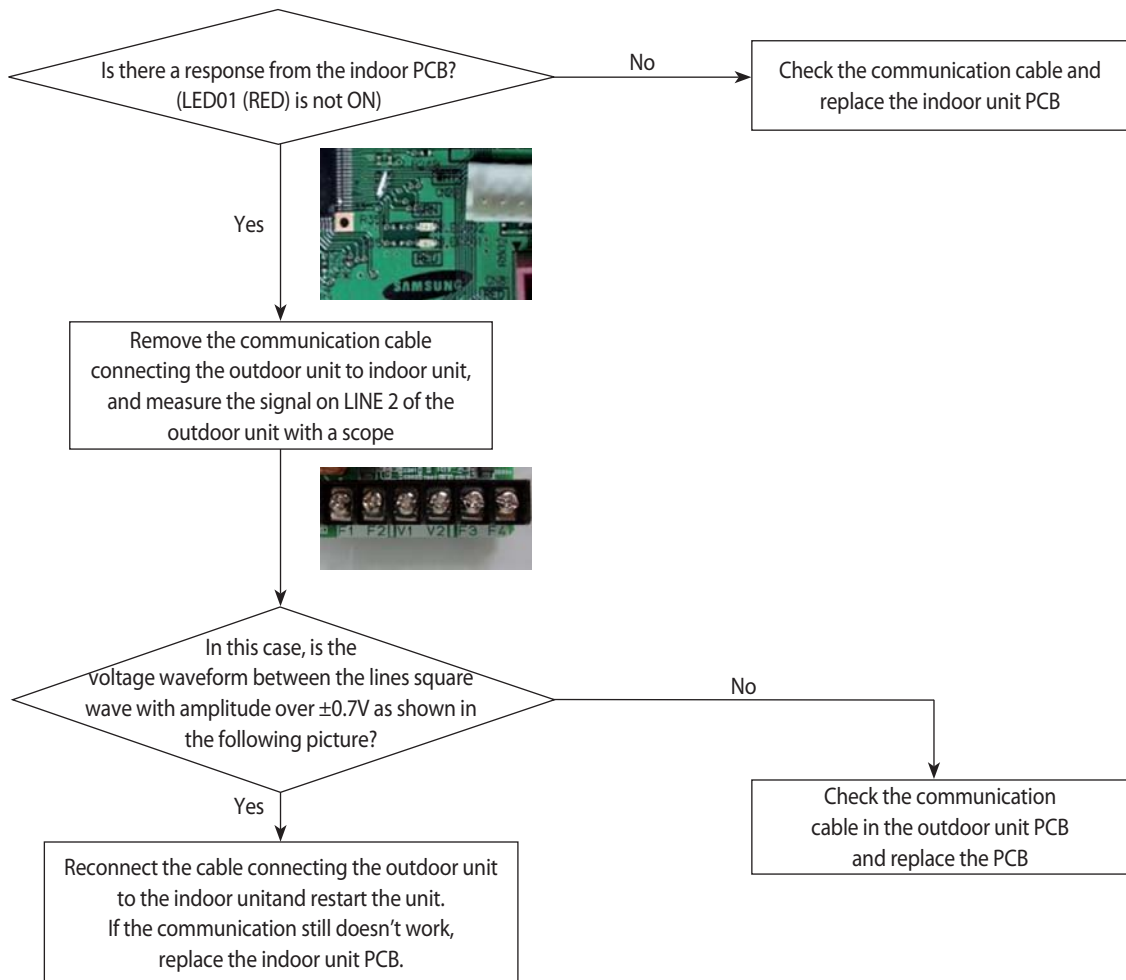

4-4-6. Indoor unit float sensor error

Indoor unit display	360 Cassette	x(Ice blue) ●(Yellow green) ●(Blue) x(Red)
Judgment method	Refer to checking method, as shown below	
Symptom	If the increase in the drain pan water level due to failure of the indoor unit drain pump or indoor unit float switch is open and that state is maintained for more than one minute.	

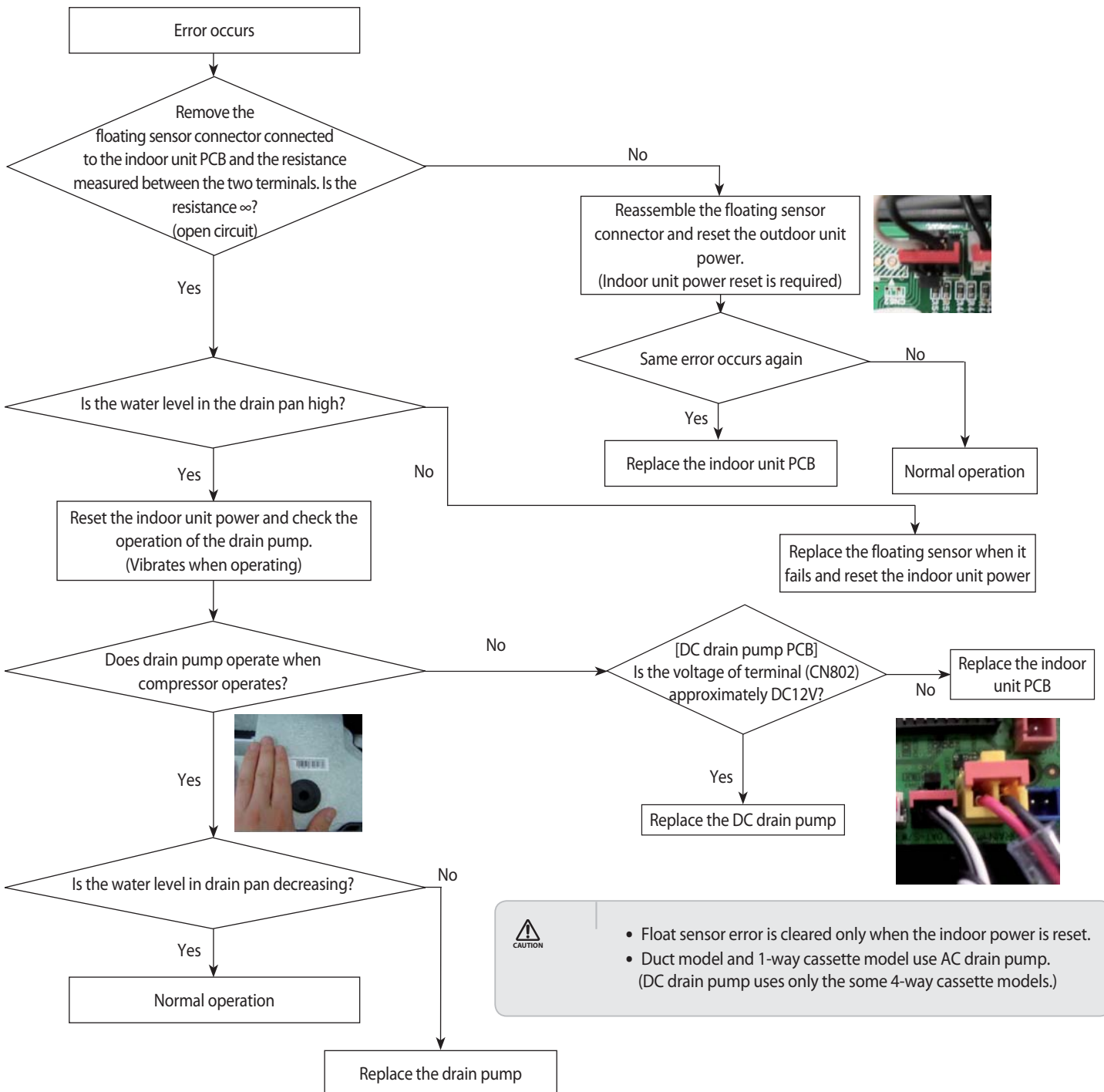

4-4-7. EEPROM circuit failure (E162)

Indoor unit display	360 Cassette	●(Ice blue) x(Yellow green) x(Blue) ●(Red)
Judgment method	Refer to checking method, as shown below	
Symptom	If the EEPROM component defective. (EEPROM circuit parts missing / damaged / soldering failure)	

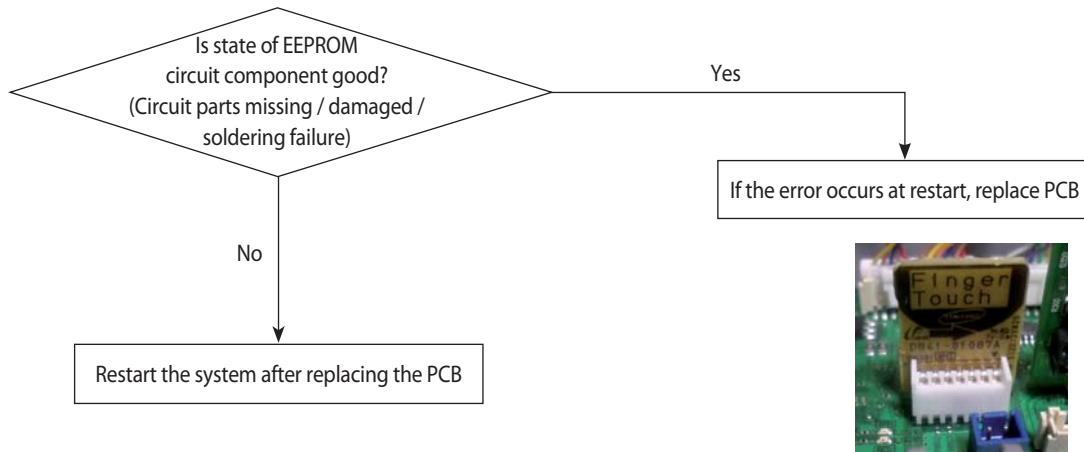

4-4-8. The whistling noise from the indoor unit in low wind mode

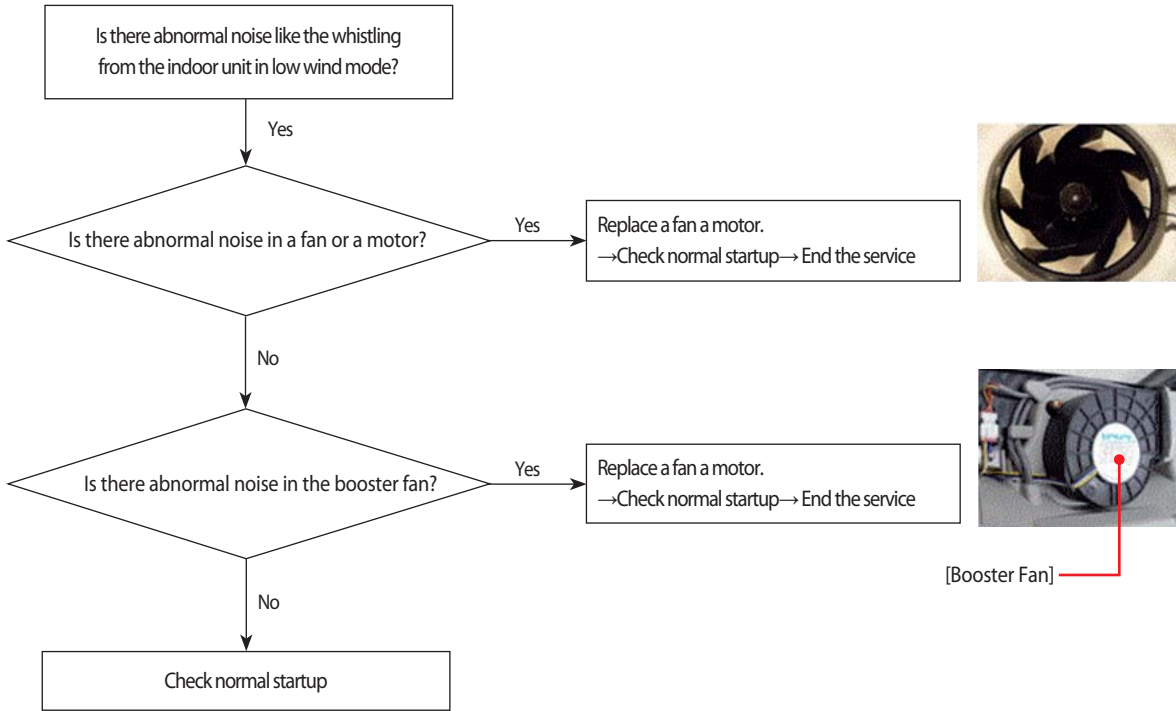

4-4-9. When the outdoor unit power is not ON - Initial Diagnosis : 3-phase products

1. Test items

- 1) Check the power connection of outdoor unit.
- 2) Check the whole connection part of the power wire.
- 3) Check the power on the indoor unit.
- 4) Check the connection of the power wire of the Terminal Block.
- 5) Check the connection of the power wire between the Main↔EMI PBA of the outdoor unit.
- 6) Connect the power wire. (Never forget to turn off the power of the Terminal Box).
- 7) Check the power supply parts. (Check after turning off the power of the Terminal Box!)
- 8) Check everything is normal after separating the fan motor connector and resetting the power. (Separate the connector after turning off the power of the Terminal Box! When detaching and attaching the connector during power supply, the motor can be damaged.)

- 7-segment off.
- Conduct the following test if the mode is not Eco-mode (power saving mode).

2. Check procedure

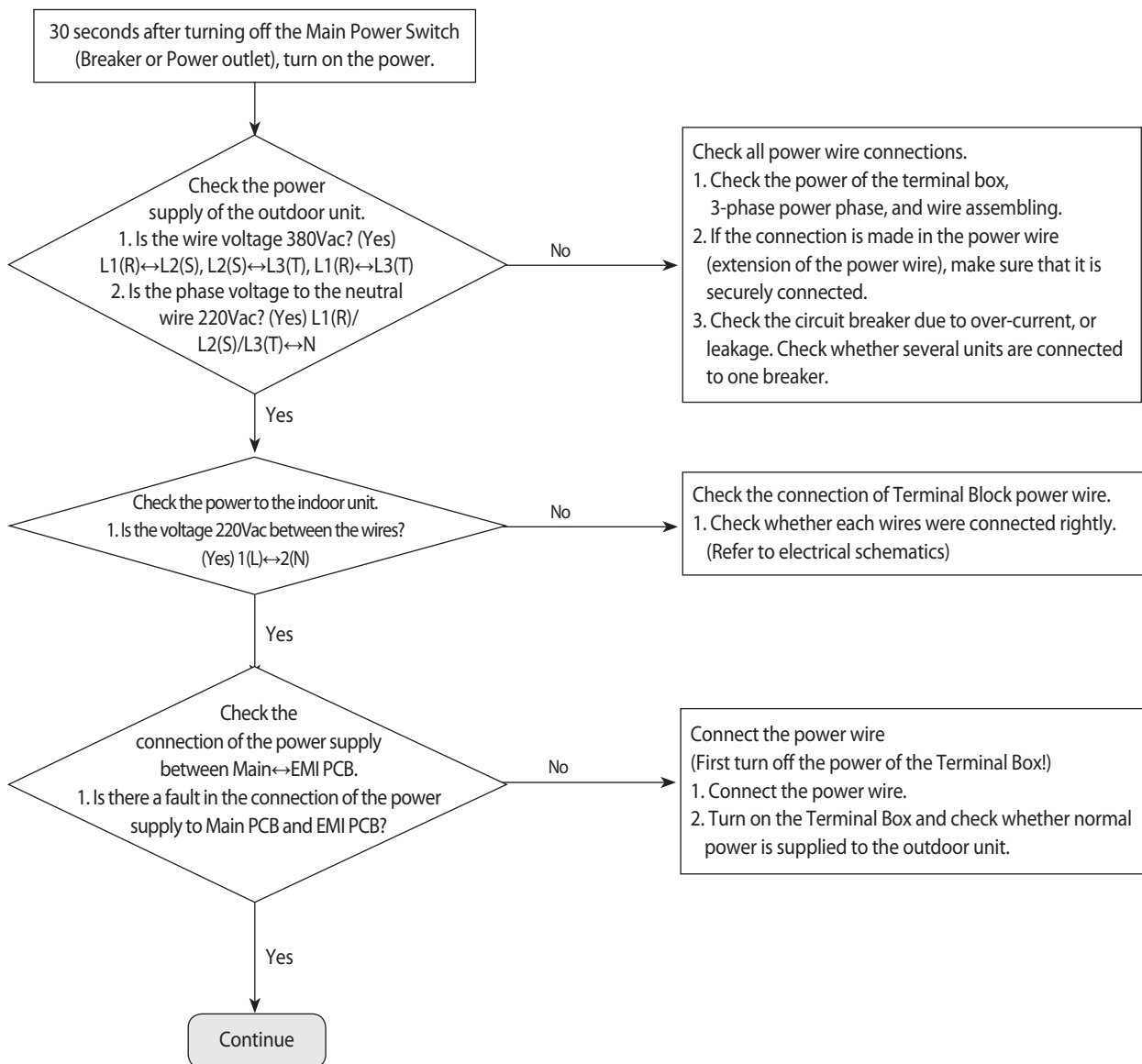

When the outdoor unit power is not ON - Initial Diagnosis : 3-phase products (cont.)

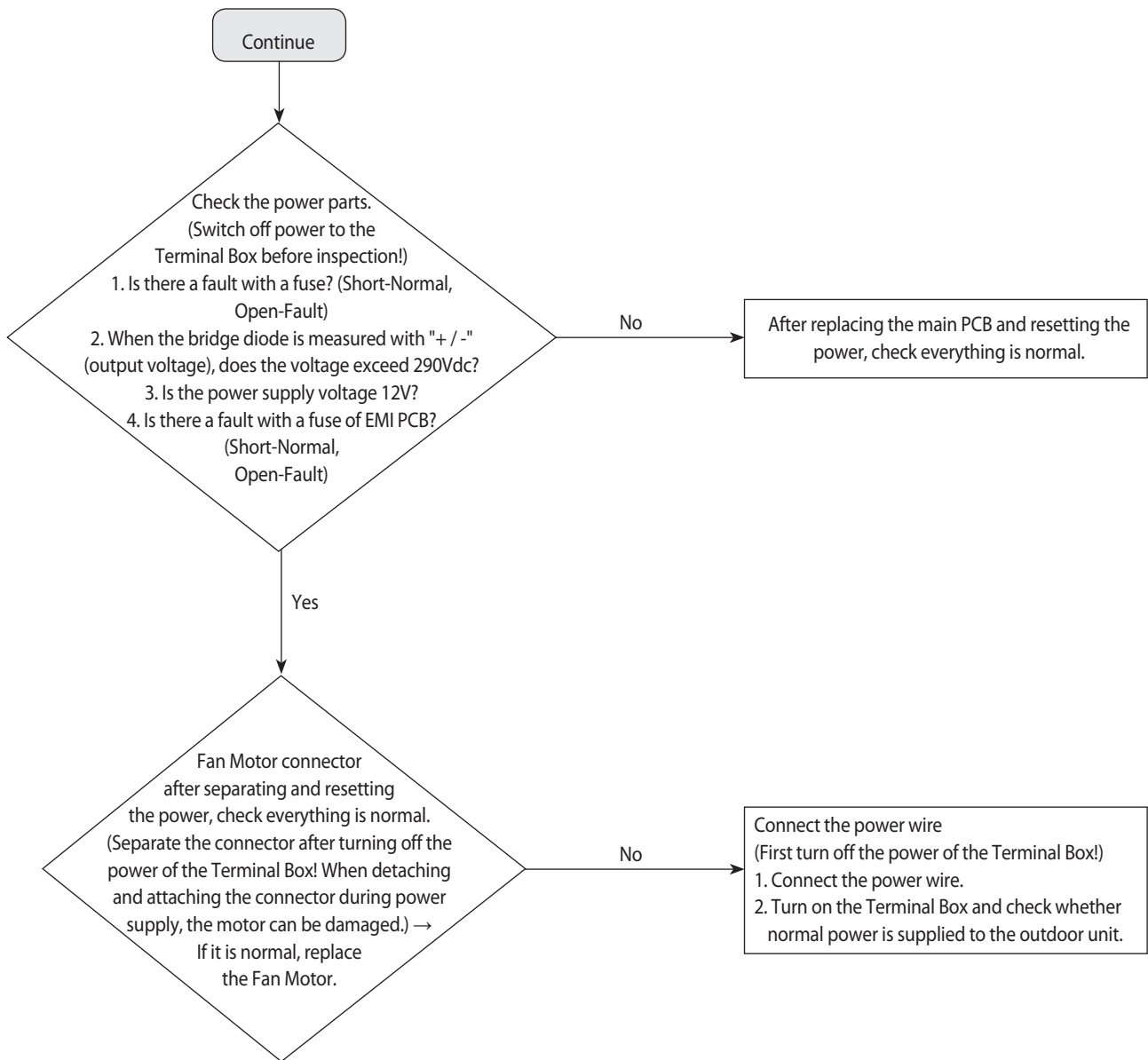

When the outdoor unit power is not ON - Initial Diagnosis : 1-phase products

1. Test items

- 1) Check the power connection of outdoor unit.
- 2) Check the whole connection part of the power wire.
- 3) Check the power on the indoor unit.
- 4) Check the connection of the power wire of the Terminal Block.
- 5) Check the connection of the power wire between the Main↔EMI PBA of the outdoor unit.
- 6) Connect the power wire. (Never forget to turn off the power of the Terminal Box).
- 7) Check the power supply parts. (Check after turning off the power of the Terminal Box!)
- 8) Check everything is normal after separating the fan motor connector and resetting the power.

- 7-segment off.
- Conduct the following test if the mode is not Eco-mode (power saving mode).

(Separate the connector after turning off the power of the Terminal Box! When detaching and attaching the connector during power supply, the motor can be damaged.)

2. Check procedure

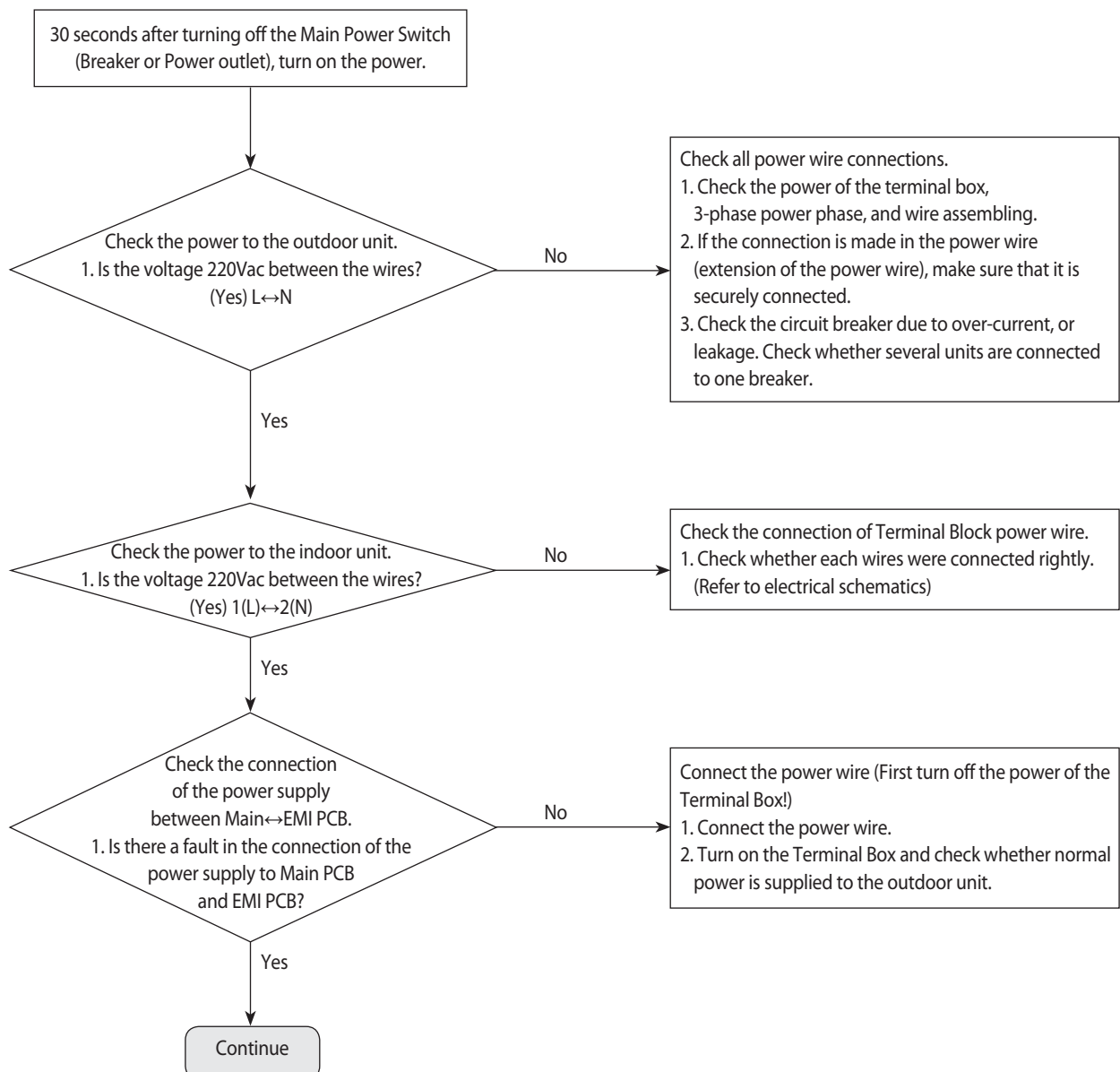

When the outdoor unit power is not ON - Initial Diagnosis : 1-phase products (cont.)

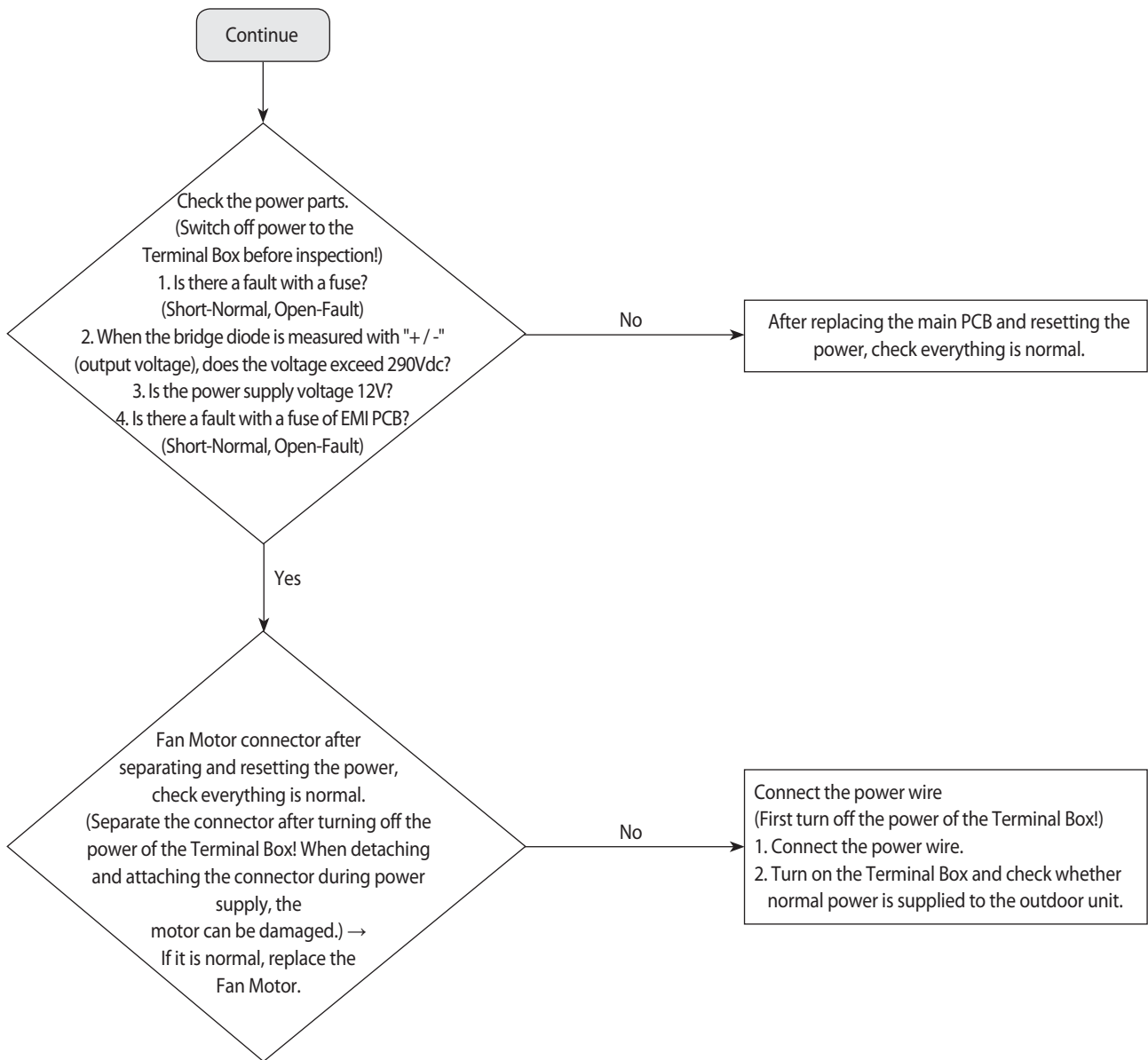

4-4-10. Indoor/outdoor communication error (1min.) (Error Code : E202)

1. Test items
 - 1) Check the communication wire and power wire connection.
 - 2) Check the communication connector connection.
 - CN31 of outdoor unit Main PCB
 - 3) Check the communication circuit on the PCB.

2. Check procedure

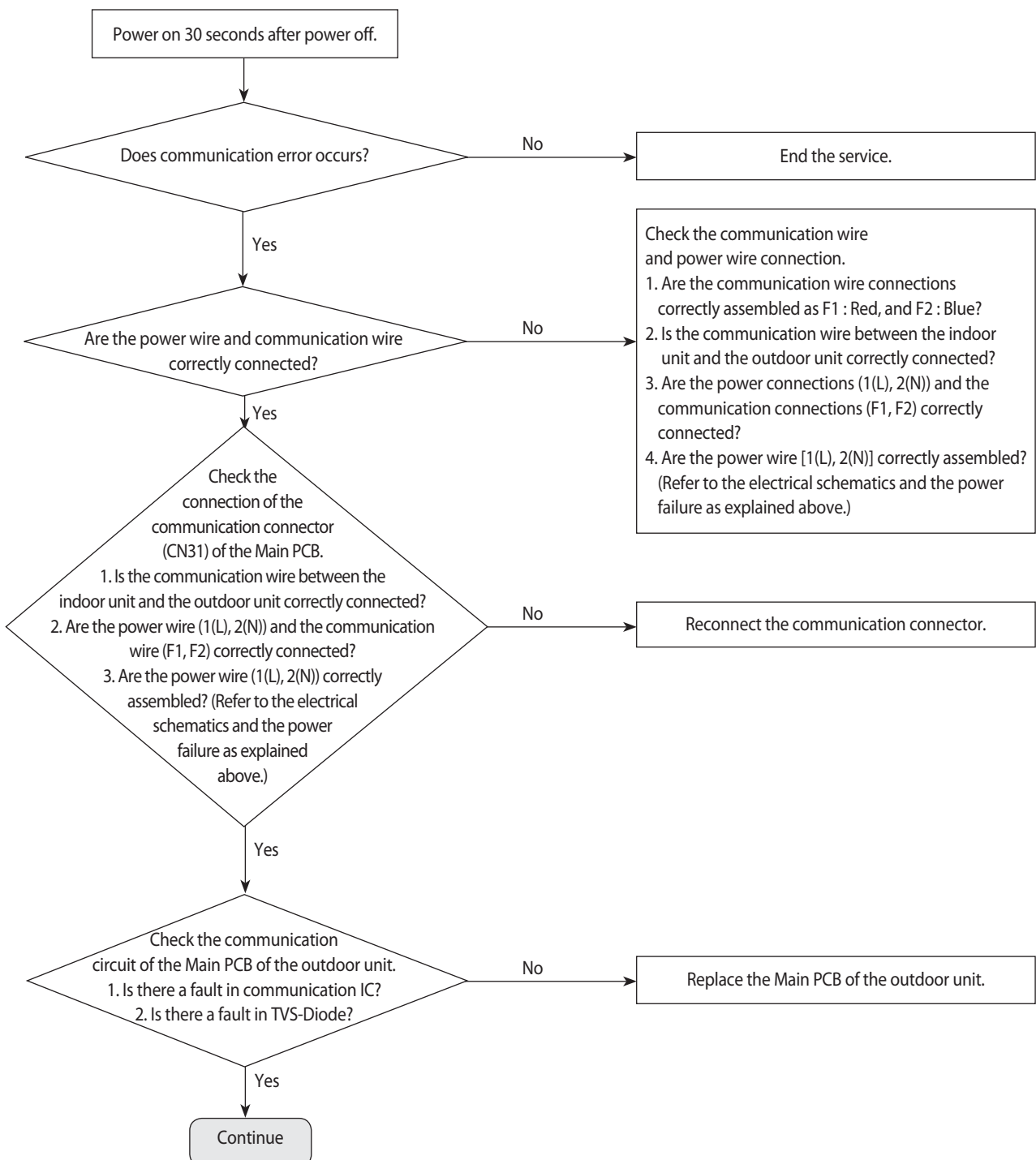

Indoor/outdoor communication error (1 min.) (Error Code: E202) (cont.)

Continue

Yes

Check the communication circuit of the Main PCB of the outdoor unit.
 1. Is there a fault in communication IC?
 2. Is there a fault in TVS-Diode?

Measuring Part	Communication IC Measuring Part (Circuit Diagram)	Example of Measuring Communication IC	Example of Measuring TVS-Diode
Location			
Measuring Point	#5-GND, #6- Communication A, #7- Communication B, #8-Vcc		

Communication IC Measuring (Port)	Steady-state Measuring Value	Remark
	COM 1 (RED)	
#6 - #5	0.9kΩ ~ 1.2kΩ	Measuring after separating the communication connection
#7 - #5	0.9kΩ ~ 1.2kΩ	
#8 - #5	4.7Vdc ~ 5.3Vdc	

TVS-Diode Measuring	Steady-state Measuring Value
Both ends of diode	1kΩ or above

4-4-11. Communication error between outdoor unit INV ↔ MAIN MICOM (1 min.)(Error Code: E203)

1. Test items
 - 1) Is power supplied to outdoor unit Inverter PCB?
 - 2) Check the power wire connection and fuse.
 - 3) Is there a problem in the communication wire connections between the outdoor unit Inverter (CN31) ↔ Main PCB (CN39)?
 - 4) Check the communication wire connections.
2. Check procedure

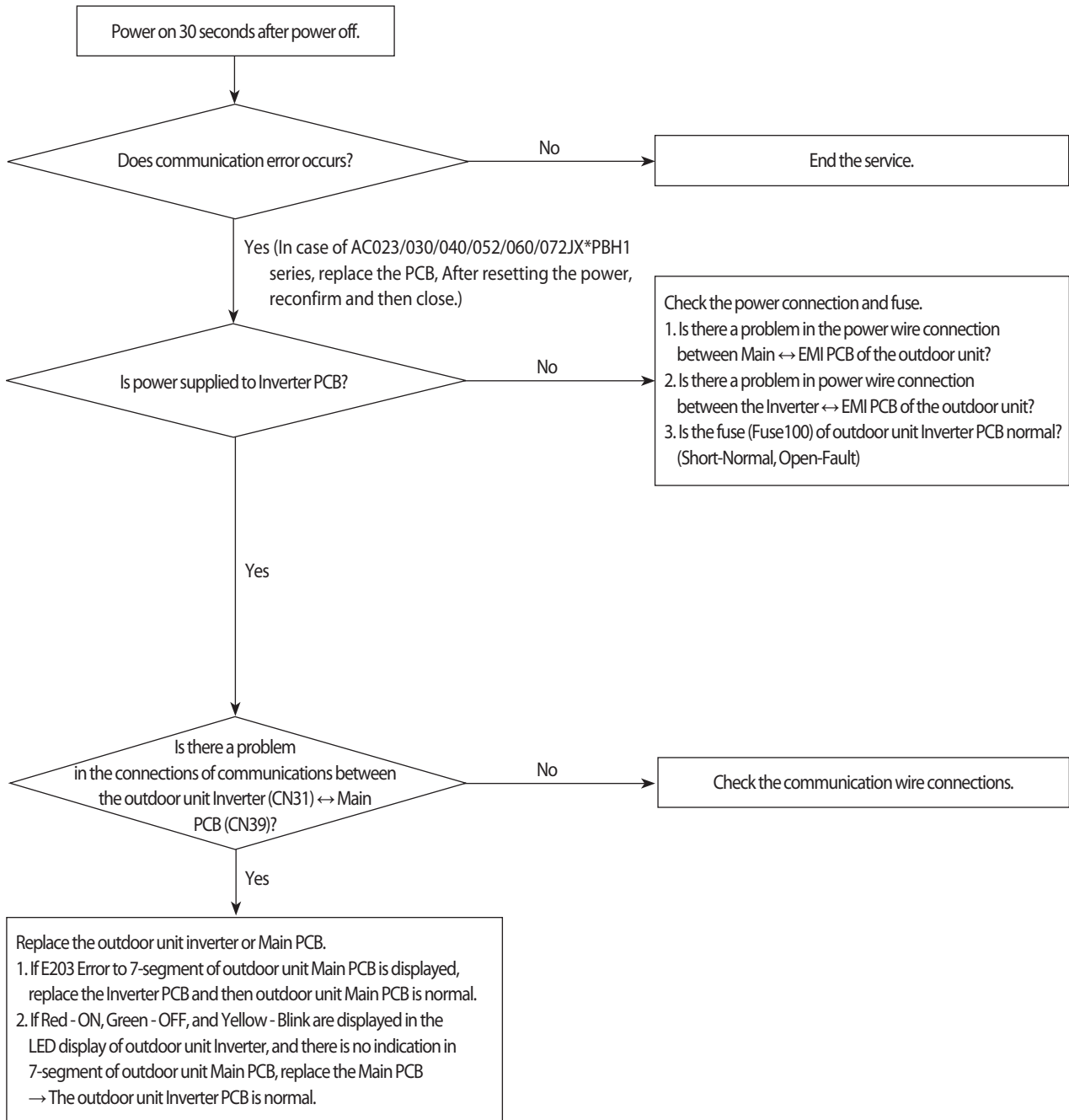

4-4-12. Outdoor sensor error(Error Code : E221, E231, E251, E320)

1. Test items

- 1) Check the connection of the temperature sensor connector.
- 2) Check the resistance value of the temperature sensor.

Error CODE	Description
E221	Outdoor temperature sensor error
E231	Outdoor temperature sensor error
E251	Outdoor temperature sensor error
E320	Outdoor OLP sensor error

2. Check procedure

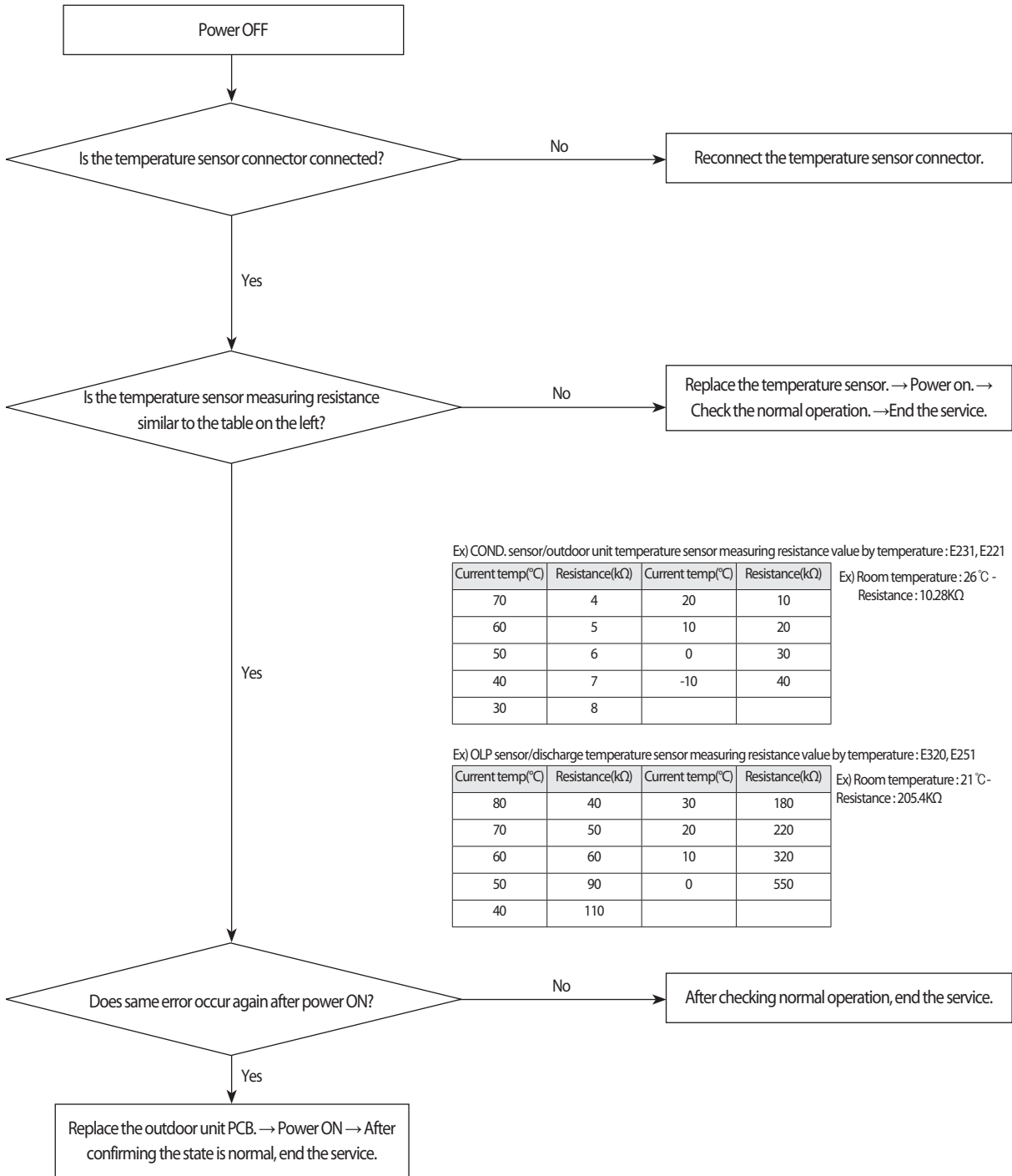

4-4-13. Reverse phase / Loss phase detection (3-phase outdoor unit) (Error Code : E425)

1. When power is on, it checks the power status used for 3-phase power compressor.

When the order of 3-phase L1(R) – L2(S) – L3(T) is changed (Reverse phase) or there is a phase that does not supply power (Loss phase), it will display **E425** and the air conditioner will stop operating. **E425**

1) Check the voltage on L1(R) – L2(S) phase/ L1(R) – L3(T) phase/ L2(S) – L3(T) phase.

2) When there is any terminal that does not have normal voltage, check the external power of the air conditioner and take appropriate measures.

3) If 3-phase power is normal check the phase of the power wire using 3-phase tester.

If it shows reverse phase, change the current power wire connection.

4) After completing above, press reset key (K3) then check the power again.

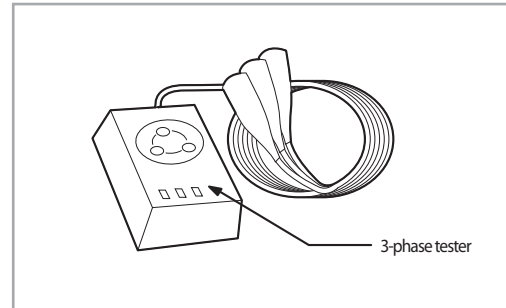

4-4-14. Compressor down due to freezing control (Error Code : E403)

1. Test items

- 1) Check the normal operation of indoor Fan/Motor.
- 2) Check the normal operation of indoor EEV.
- 3) Check the IN/OUT sensor of indoor heat exchanger.
- 3) Check the clogging of indoor air inlet part.

2. Check procedure

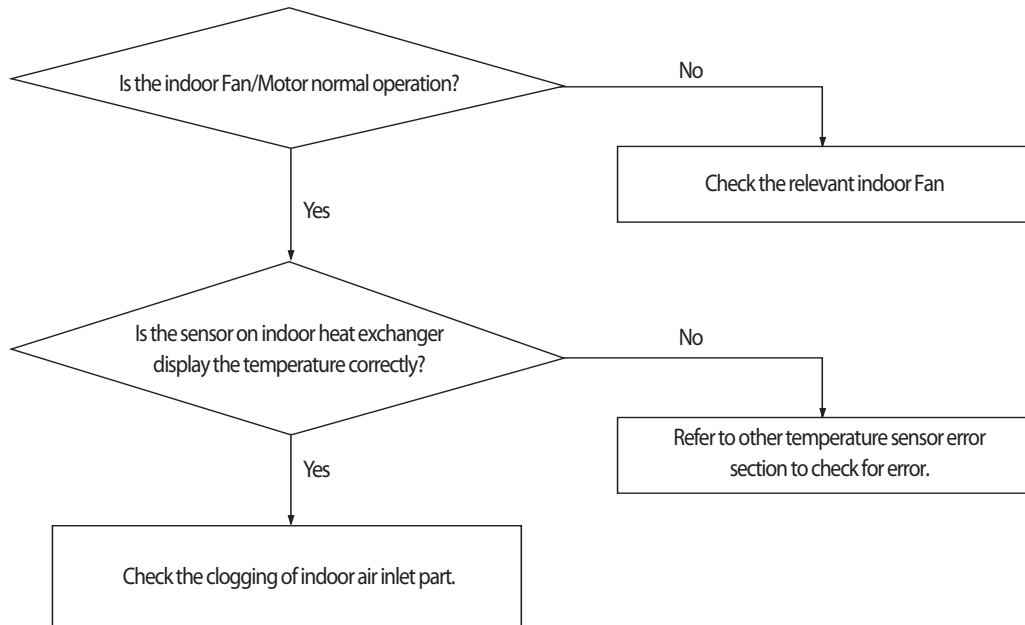

4-4-15. Outdoor unit Fan error (Error Code : E458, E475)

1. Test items
 - 1) Check the connection of Fan connectors (CN90, CN91)
 - 2) Check the voltage of the fan motor connector in the inverter PBA of the outdoor unit.
 - 3) Check the power connection of the outdoor unit Inverter PCB.
 - 4) Check the Fan Motor single parts. (Be sure to turn off the power and separate the motor connector after 30 seconds!)

2. Check procedure

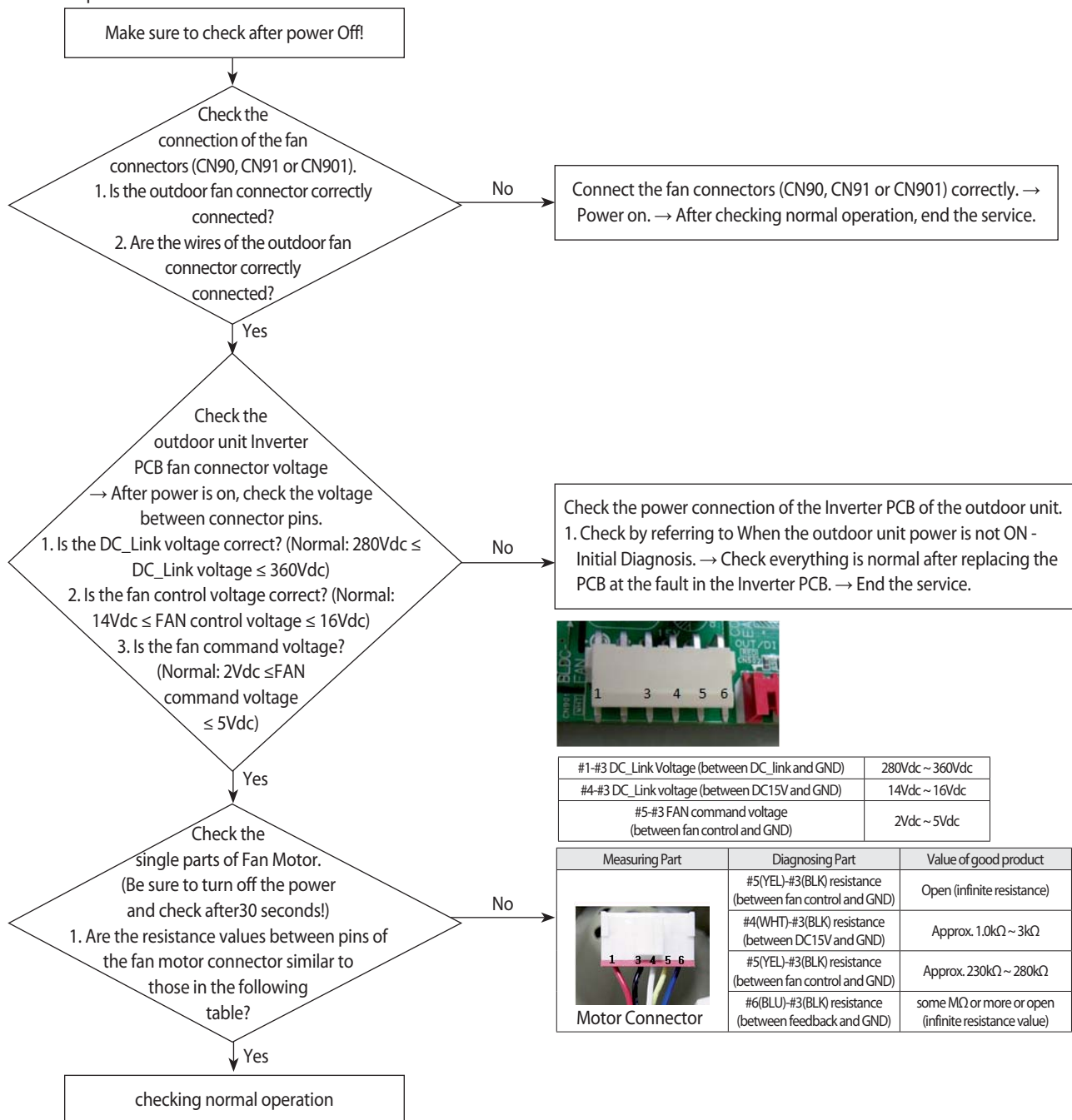

- ※ At least 30 seconds after power is OFF, attach/detach the fan motor connector! → Threatened to cause secondary damage to the motor and the PCB.
- ※ Check the Inverter PCB or Fan Motor single parts and only if there is a fault, replace!
- ※ Do not replace the Main PCB of the outdoor unit relating to the fault in the Fan Motor!
 - If the error is indicated on 7-segment of the Main PCB of the outdoor unit, the Main PCB of the outdoor unit has no fault.
 - In case of a control problem, it is possible to solve with S/W update.

4-4-16. Compressor starting error / rotation error (Error Code : E461, E467)

1. Test items
 - 1) Check the power connection. / Check the restart after power reset.
 - 2) Check the compressor and the state of the compressor wire assembling.
 - 3) Check the defective for compressor wire single parts.
2. Check procedure

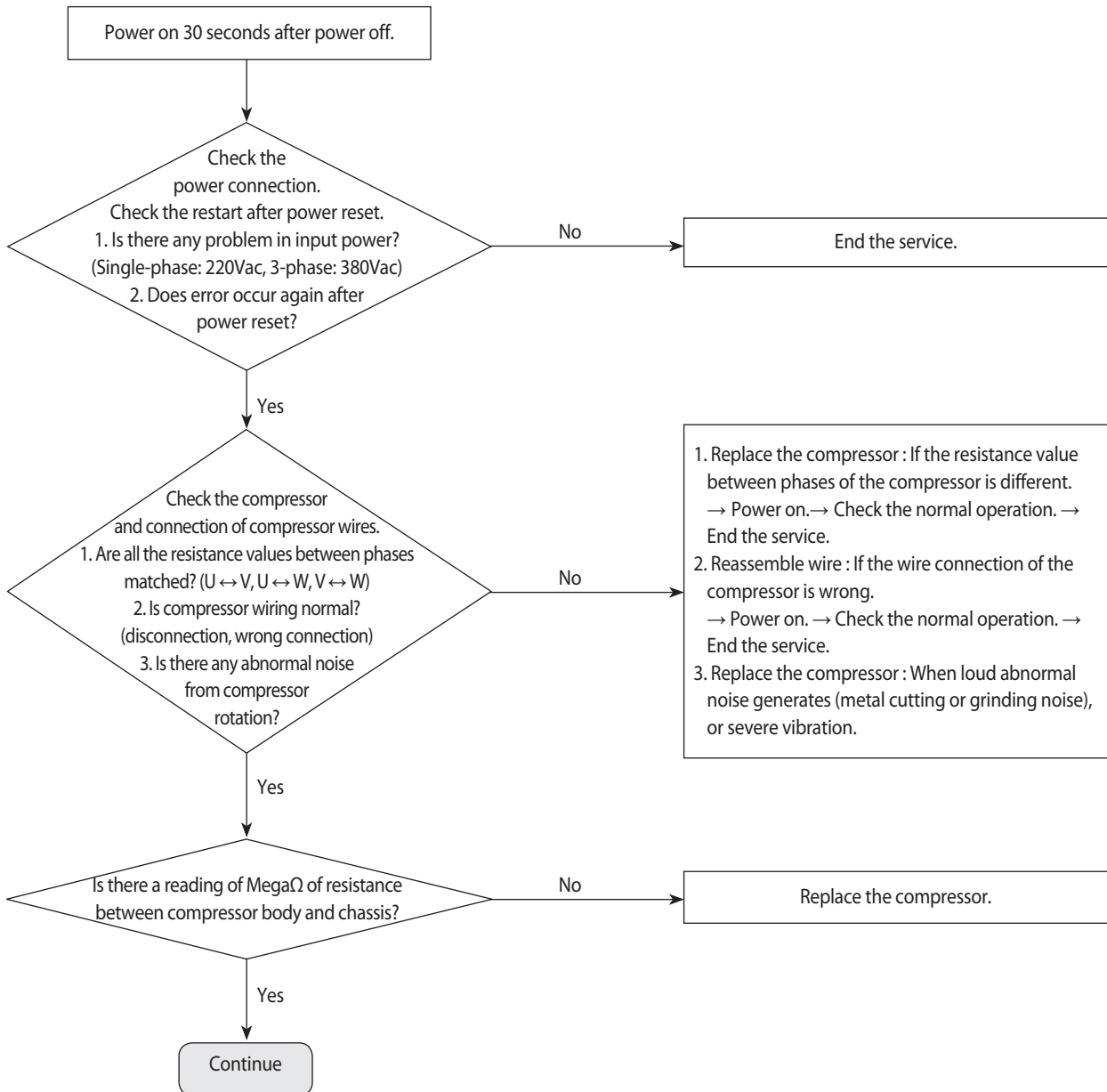

Compressor starting error / rotation error (Error Code : E461, E467) (cont.)

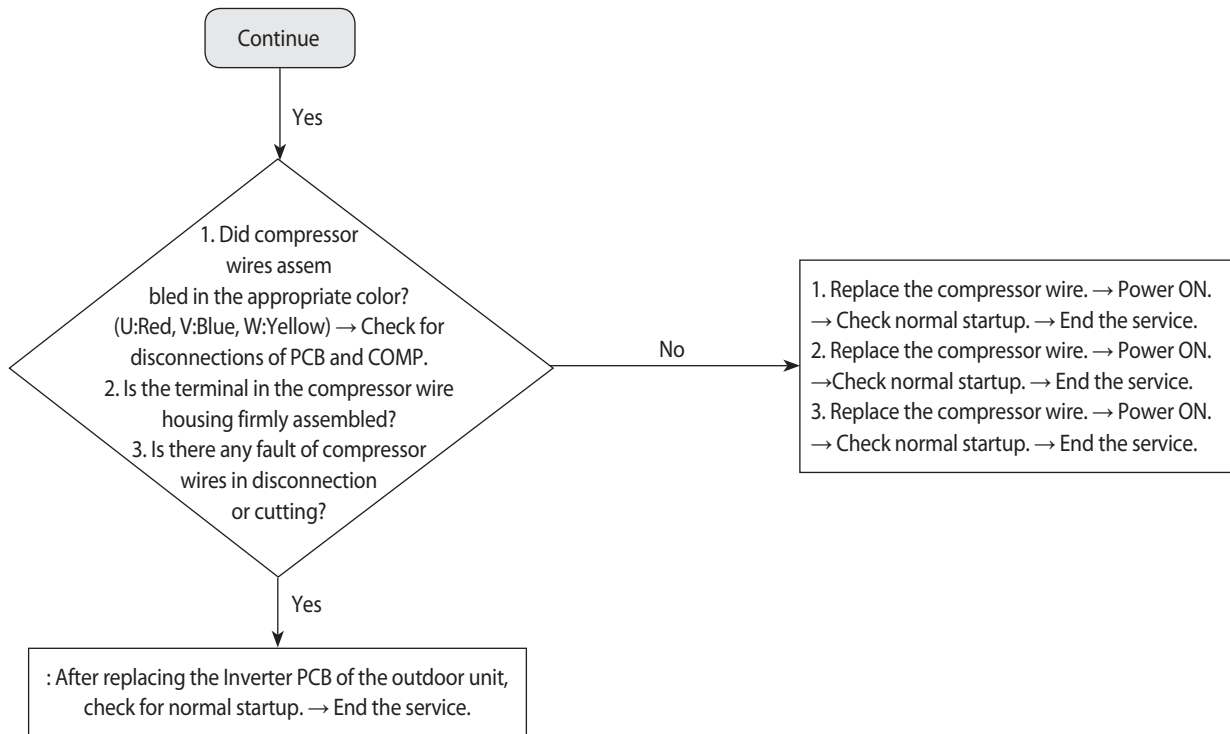

- ※ E461, E467 Error-related, EMI / outdoor unit Main / Indoor unit Main PCB do not replace!
→ This error is related to the compressor and Inverter PCB. (Not related to the above PCB)
- ※ Ensure that the service valve is open!
→ When the service valve is closed, the defects may be caused by differential pressure when starting the compressor.

4-4-17. Full current error / PFC over-current error (Error Code : E462, E484)

1. Test items

- 1) Check the power connection. / Check the restart after power reset.
- 2) Install outdoor unit and check environment.
→ Check for wire disconnection related to outdoor unit Inverter PCB and check the installation environment.
- 3) Check the indoor unit installation environment.
- 4) Check the opening of service valve.

2. Check procedure

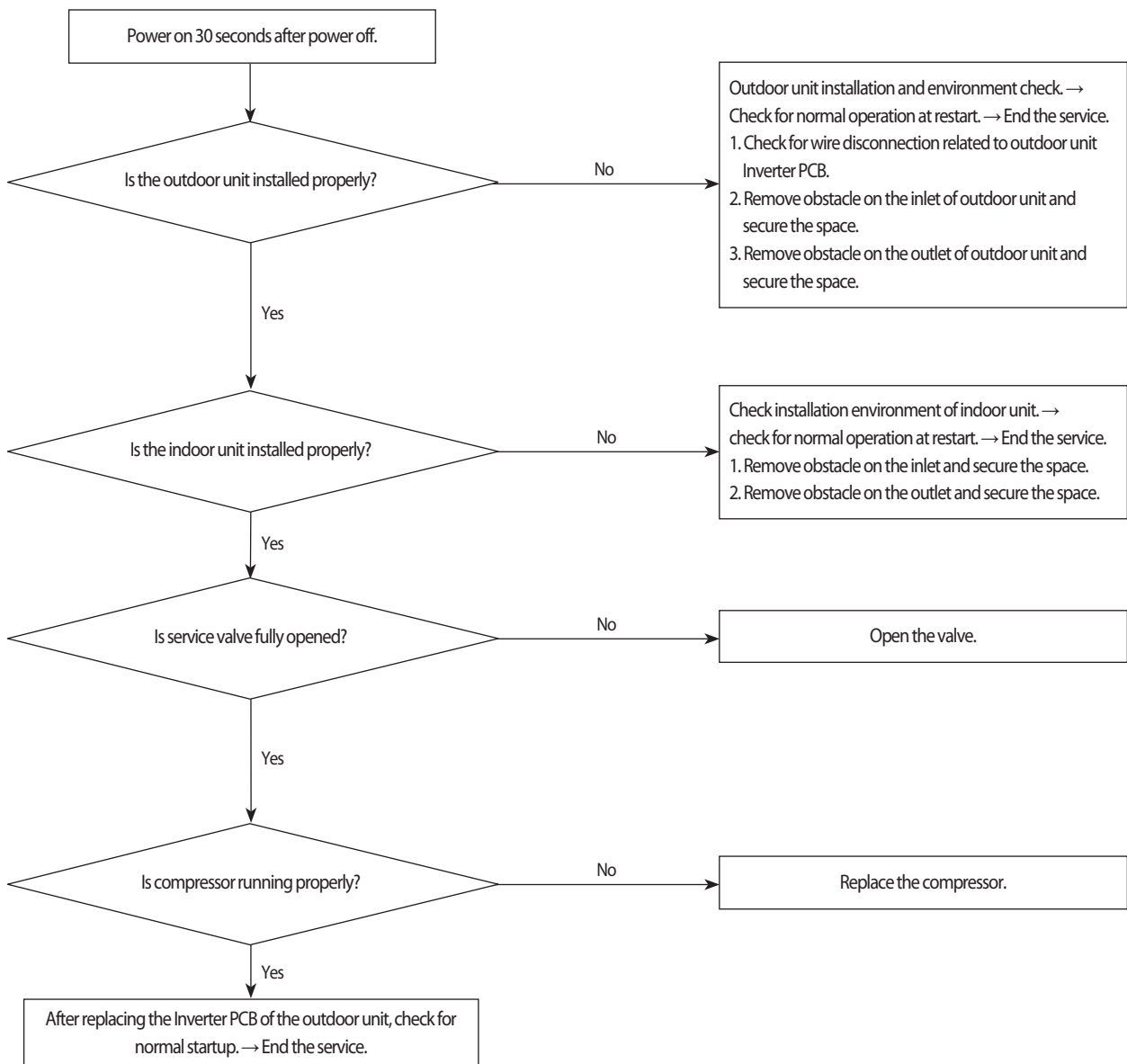

4-4-18. IPM IPM (Over Current) error (Error Code : E464)

1. Test items

- 11) Check the power connection. / Check the restart after power reset.
- 2) Install outdoor unit and check environment.
 - Check for wire disconnection related to outdoor unit Inverter PCB and check the installation environment.
 - After having installed several units, please check that communication wires are not interchanged with piping.
- 3) Check the indoor unit installation environment.
- 4) Check the opening of service valve.
- 5) Check the status of compressor assembly and wiring.
- 6) Check the defective for compressor wire single parts.

2. Check procedure

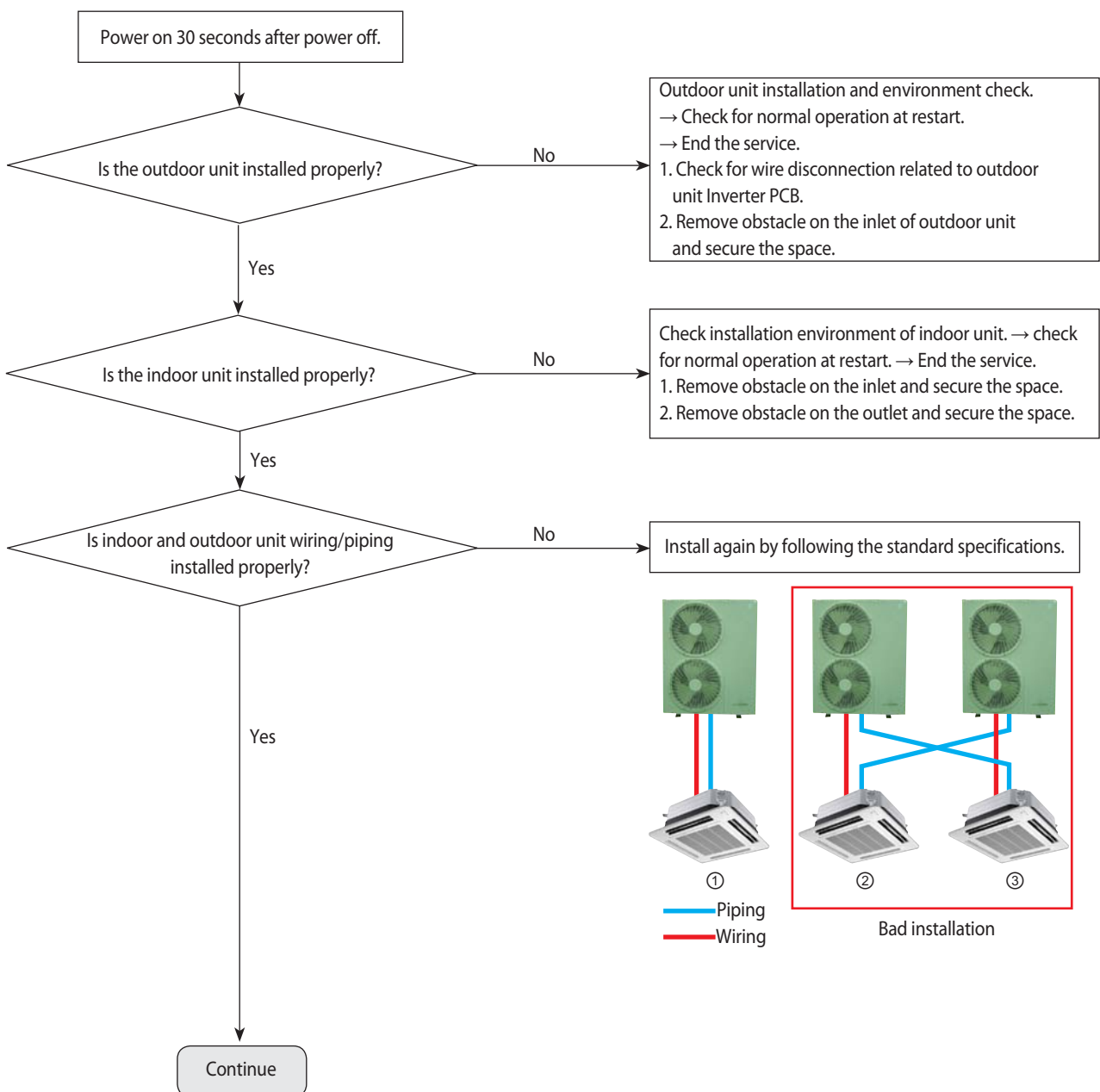

IPM over(Over Current) error (Error Code : E464)(cont.)

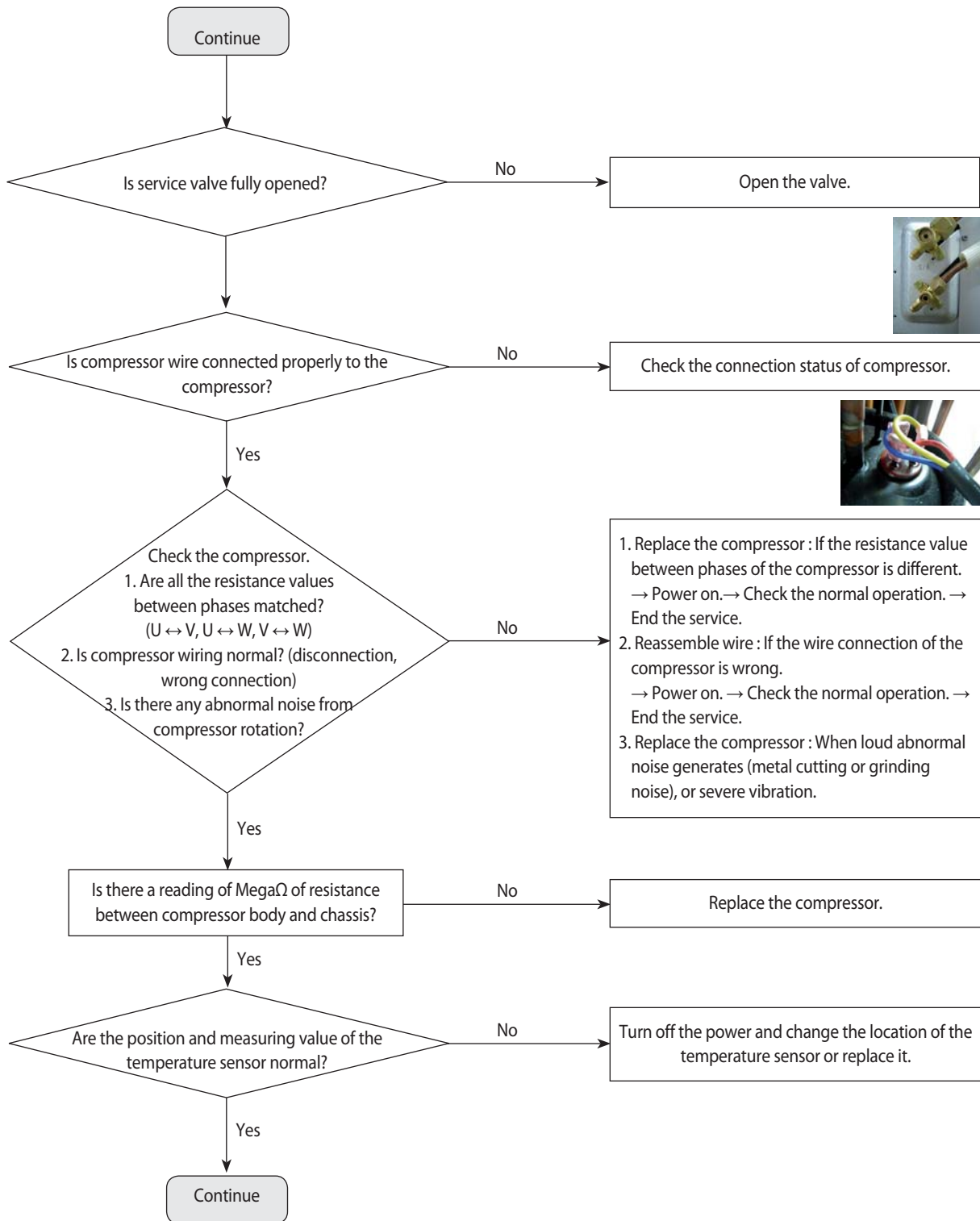

IPM over(Over Current) error (Error Code : E464)(cont.)

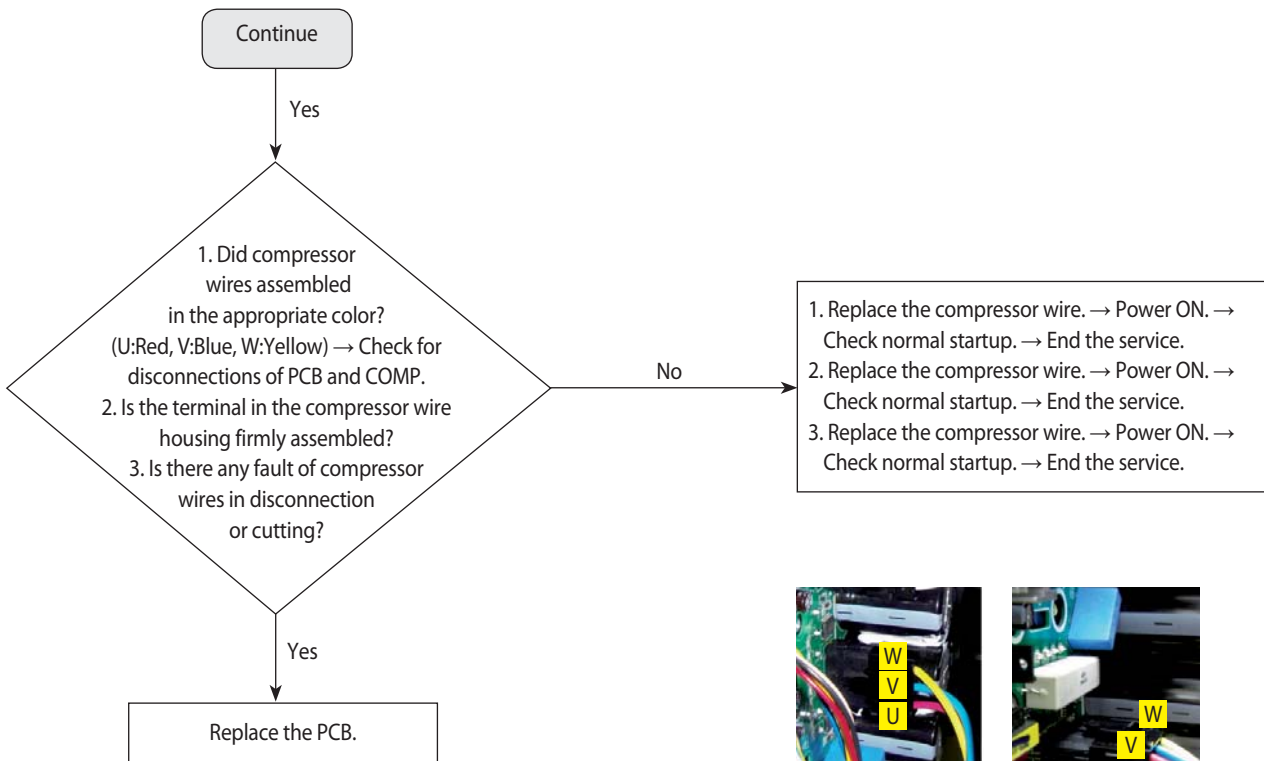

[RC***HXH series]

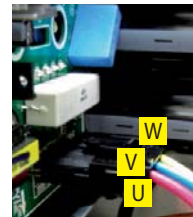

[RC090****/RC100****/
RC110****/ RC130****/
RC145****/RC160**** series]



PCB connecting connector

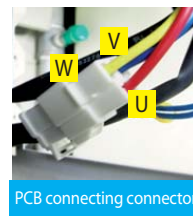

PCB connecting connector

[RC060****/RC072**** series]

- ※ E46 Error-related, EMI / outdoor unit Main / Indoor unit Main PCB do not replace!
→ This error is related to the Inverter PCB. (Not related to the above PCB)
- ※ Ensure that the service valve is open!
→ When the service valve is closed, the defects may be caused by differential pressure when starting the compressor.

**4-4-19. DC LINK over-current / low-voltage error (Error Code : E466)
H/W DC_Link Over Voltage Error (Error Code : E483)
AC Input Voltage Sensor Error (Error Code : E488**

1. Test items
 - 1) Check the power connection. / Check the restart after power reset.
 - Is there a fault in input power? (Single-phase : 220Vac, 3-phase : 380Vac)
 - Does error occur again at operation after power is reset?
 - 2) Check the connection of the power, and check whether the jointed power connection exists.
 - After having installed several units, please check that communication wires are not interchanged with piping.
 - 3) Check the reactor and its connecting wires.
 - 4) Check the fuses of EMI PBA.
 - 5) Check the Terminal Block and Power Terminal Box and the wire assembly.

2. Check procedure

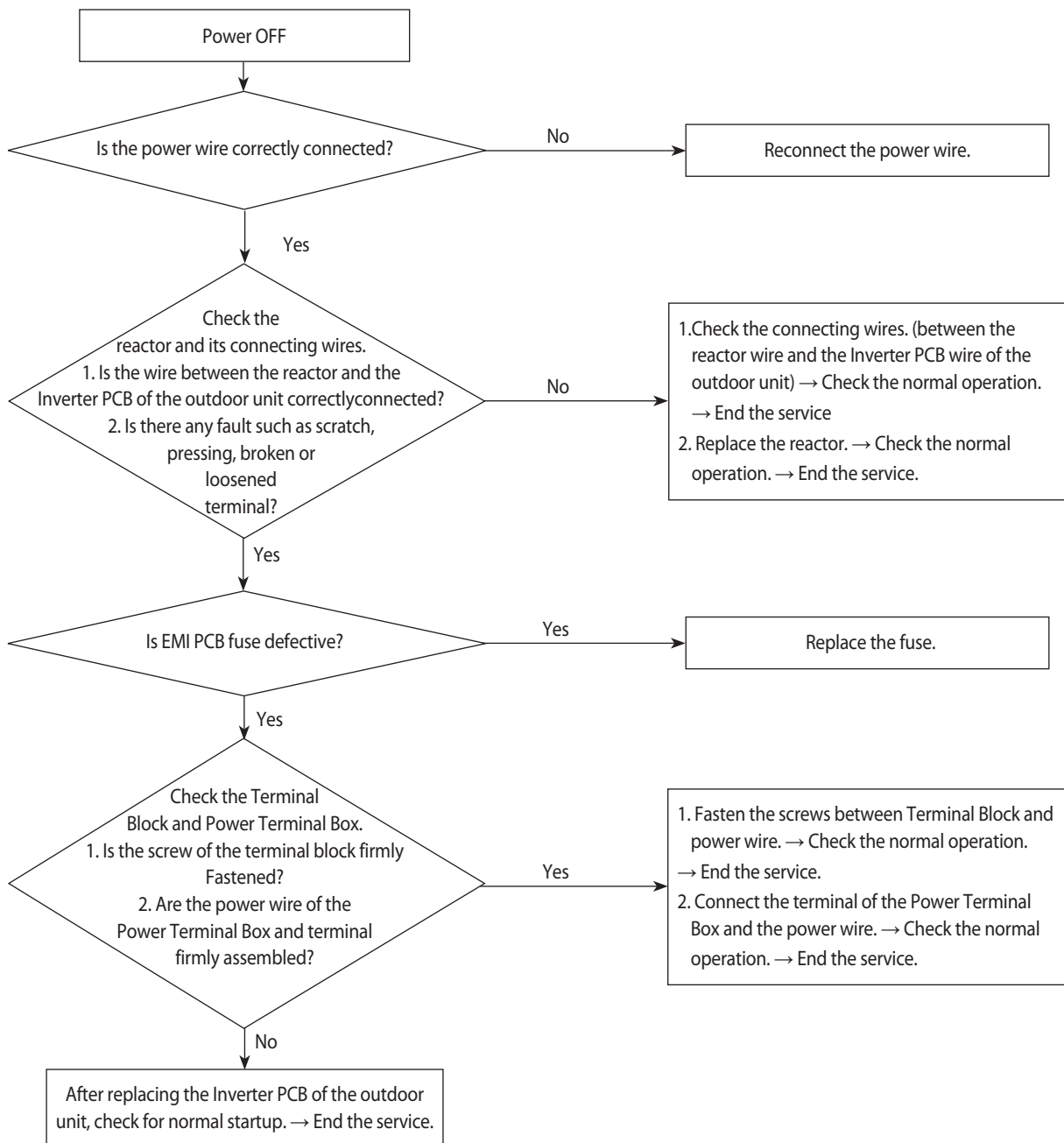

4-4-20. Gas leakage error(Error Code : E554)

1. Test items

- 1) Check the power connection. / Check the restart after power reset.
 - Is there a fault in input power? (Single-phase : 220Vac, 3-phase : 380Vac)
 - Does error occur again at operation after power is reset?
- 2) Check the compressor and the state of compressor wire assembling.
- 3) Check the outdoor unit installation environment.
 - Check for disconnection of the wires regarding the Inverter PCB of the outdoor unit and check the installation environment.
 - At the site where several units were installed at the same time, check whether communication wire and pipes have been wrongly connected!

2. Check procedure

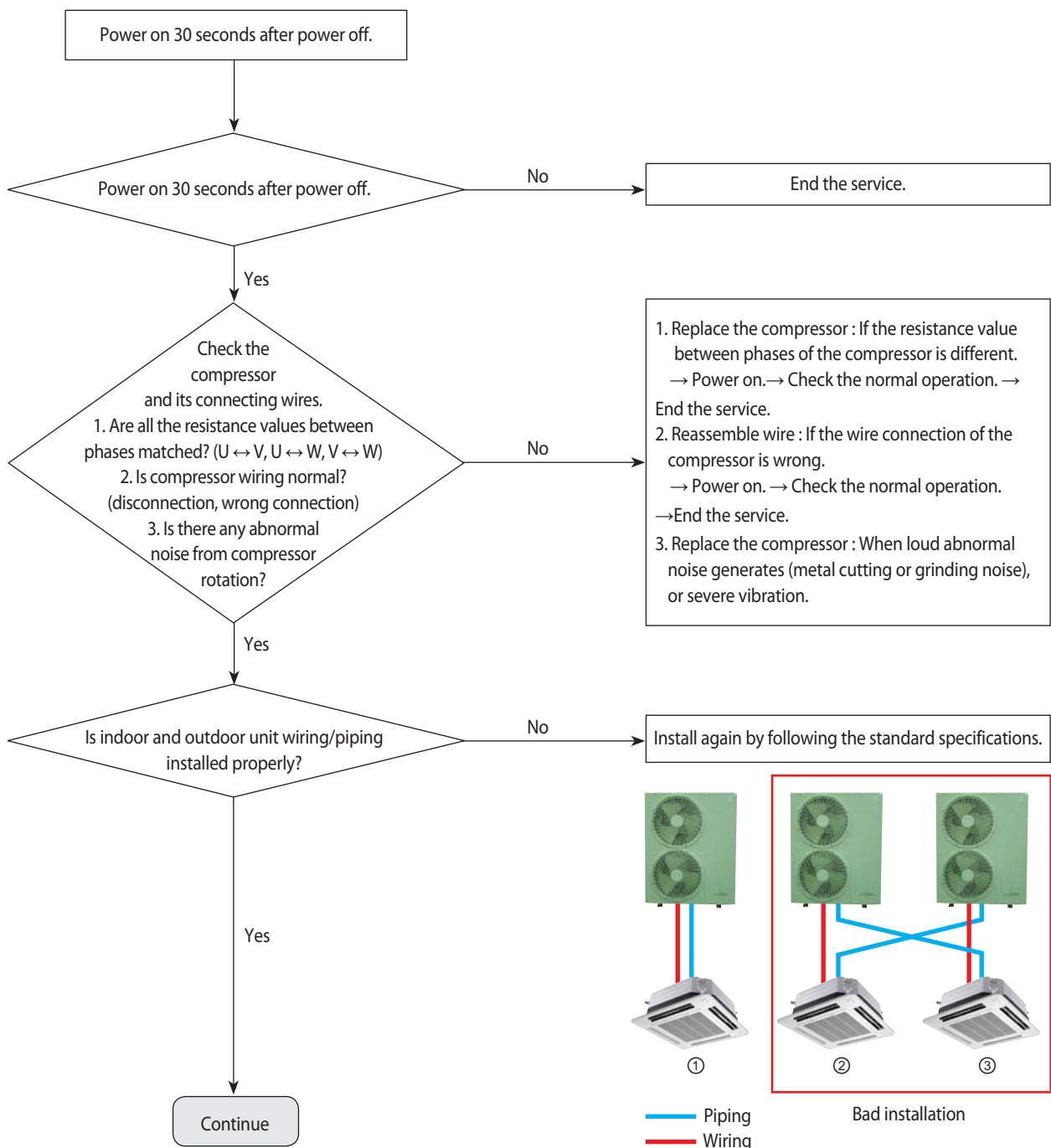

Gas leakage error(Error Code : E554) (Cont.)

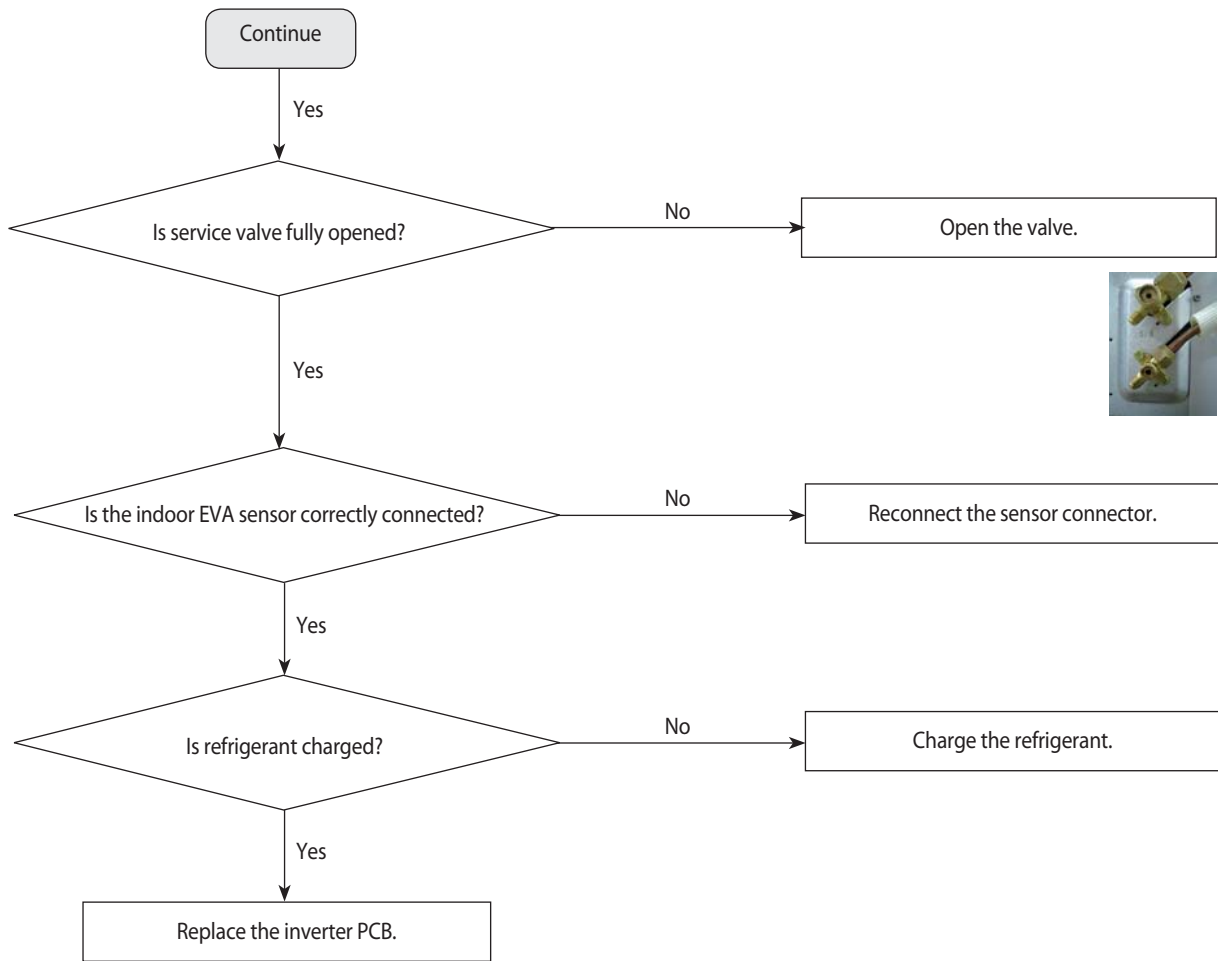

4-4-21. Pipe blockage error(Error Code : E422)

1. Test items
 - 1) Check the open state of the outdoor unit service valve.
 - 2) Check the connection of the pipe.
 - 3) Check the operation of the EEV.
 - 4) Check the refrigerant leakage.
 - 5) Check the connection of the indoor unit PBA EVA sensor.
 - 6) Check the fault in the indoor unit EVA sensor.
2. Check procedure

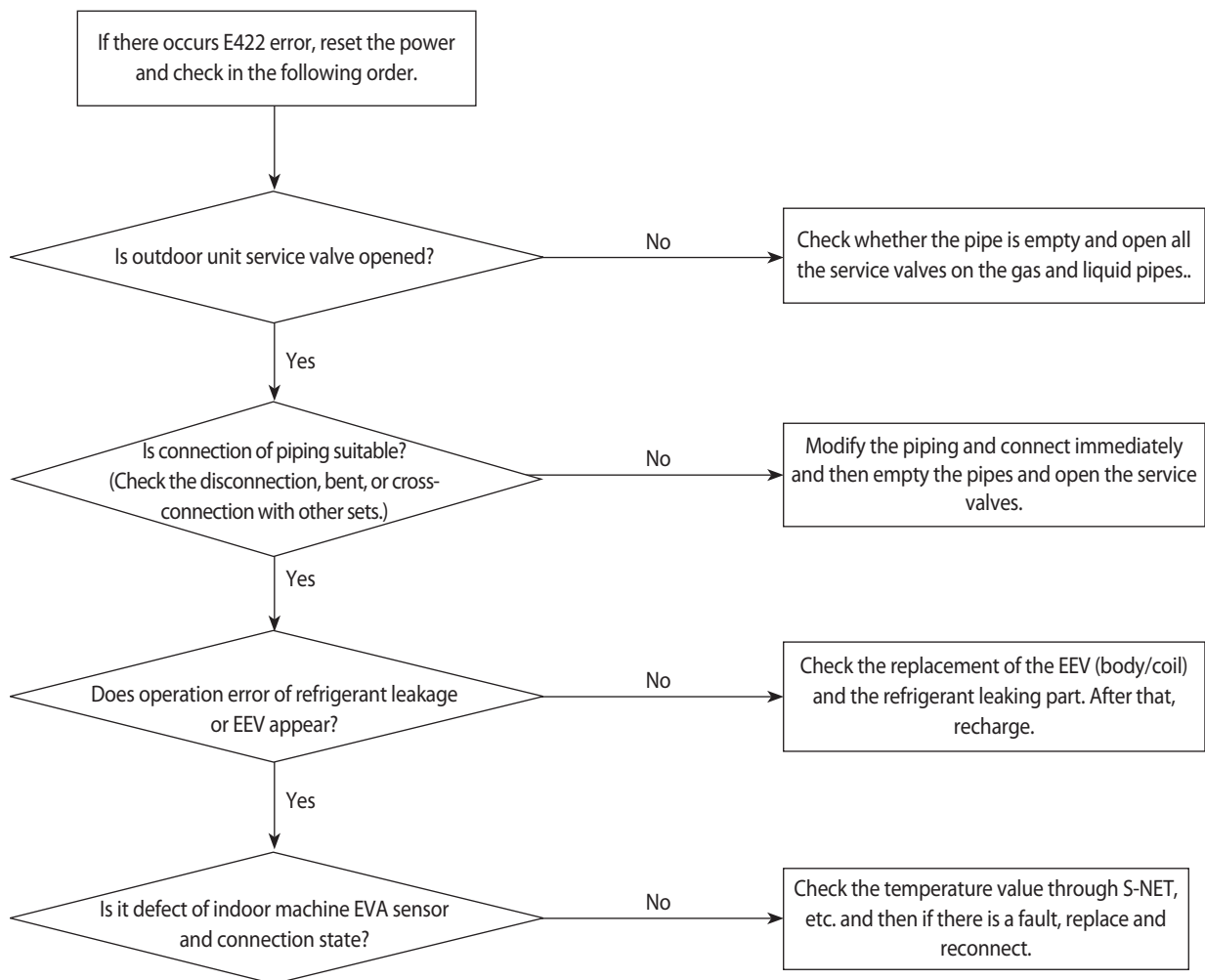

4-4-22. Smart install mode was not carried out (Error Code : E508)

Smart install mode?

When installing the air conditioner the first time, the installation status and fault status and performance of the product is a self-diagnostic function to determine comprehensively..

(The corresponding model is necessarily the general operation can be carried out when the smart install mode.)

Installation procedures of smart install mode

(1) Check the installation status of air conditioner.

- ▶ Check the power wire, communication wire, power connection, service valve opening, additional amount of refrigerant.
- ▶ When supplying power upon installation, a warning (error) of not having run in the installation smart install mode is displayed and the product will not run properly.

Model	Indoor unit	Outdoor unit
360 Cassette	Red lights up	E508

(2) Enter the smart install mode.

- ▶ Enter of the outdoor unit : Press for at the same time 5 seconds K 1, K 4 switches.
- ▶ Enter of the remote control : Press for at the same time 4 seconds [Power] + [Set] + [Mode] buttons.
- ▶ The progress status of installation smart install mode is shown in "00~99"(%).
- ▶ The smart install may take about 10 minutes.

Model	Indoor unit	Outdoor unit
360 Cassette	It is blinking in sequence. (Ice blue → Yellow green → Blue → Red → Ice blue)	"F" "F" "r" "d" After lasting for 3 minutes "F" "F" "00~99" display

(3) The installation smart install mode is complete.

- ▶ Success in the installation smart install mode : The unit will enter a general operation standby mode upon blinking to show a success.

Indoor unit	Outdoor unit
Indicator light of main unit switches off.	"F" "F" "r" "F" After blinking for 10 seconds, it will enter the general operation standby mode.

- ▶ Smart Install failure: Error code blink

※ In the event of Error Error code reference, please carry a house from scratch after an action mode for the Smart Install Error.

Precautions

- ▶ When needing to have additional piping before entering the installation smart install mode, charge refrigerant additionally according to the manual. At this time, it is possible to run the cooling test (K2 switch once) and heating test (K1 switch once).
- ▶ When the installation smart Install mode is not run, the remote control and main unit button will not work. [E508 (Smart install mode was not carried out) error displayed.]
- ▶ The installation smart install mode operation may be interrupted by pressing the K3 switch. [Display the E508 (Smart install mode was not carried out) error upon interruption.]
- ▶ While running in the installation smart install mode, the installation smart Install mode operation may not be interrupted even by pressing the K1 or K2 switch.
- ▶ While running in the installation smart install mode, the system status information may be checked by pressing the K4 switch.
- ▶ When pressing the K1 and K4 switches for 5 seconds upon successfully running in the installation smart install mode, the system will run the installation smart install mode again.
- ▶ When having an error in the installation smart install mode, operation in the installation smart install mode may be interrupted.

Please run the installation smart install mode again upon taking appropriate action for the error. (Refer to troubleshooting)

- ▶ When the installation smart install mode is not completed successfully even after resolving all the errors, the unit will not work, displaying an error code of E508 (Smart install mode was not carried out). Upon resolving the problem, try to complete running the installation smart install mode.

※ Displayed E508 is not a malfunction, it is indication that did not carried out the smart Install mode after air conditioner installation.

4-4-22. Others

1. EEPROM option error (E163) : Reset the options.
2. Temperature fuse error : E198
 - If the Terminal Box temperature rise fuse is disconnected, replace the PCB.
 - Check the wiring connector of temperature fuse.
3. Current sensor error : Upload EEPROM to the Main PCB of the outdoor unit.
 - After checking for normal operation of PCB, replace the inverter PCB.
4. Compressor Vlimit error : E465
 - If the compressor is abnormally run, replace the compressor and then ensure that it works normally.
 - If the compressor is normally run, check the assembling between the heatproof plate and the Inverter PCB and then if there is no abnormality, replace the Inverter PCB.
5. DC link voltage sensor error : E469
 - Error occurs when DC LINK value is not normal (DC LINK VOLTAGE: 280~320V)
 - Check the value of DC link when error occurs and check the reactor disconnection
6. EEPROM read/write error : E470
 - Error occurs when there is no EEPROM data in the set.
 - Check the model name and insert EEPROM for corresponding model or load the EEPROM data.
7. Input current sensor error : E485
 - Detect the input sensor while the set is in stop status to check if there's any problem.
 - When error occurs, turn on/off the power for number of time and if same error occurs while the power is off, replace the Inverter PCB.
8. OTP error : E471
 - Upload EEPROM to the Main PCB of the outdoor unit.
9. Capacity inconsistency error : E556
 - Check the model name between the outdoor and indoor unit and re-enter the option code to the indoor unit.
10. 3-phase power wire disconnection : E424
 - Check for disconnection of the 3-phase (open) power wire, and check the disconnected EMI PBA fuse.
11. Outdoor unit freezing detection (at the stop of the compressor) : E403
 Outdoor overload protection control (at the stop of the compressor) : E404
 - Check whether the fan and the motor operate normally.
 - Check the operation of EEV.
 - Check the temperature sensor of the indoor unit heat exchanger.
 - Check the indoor unit inlet blockage.
12. Outdoor unit compressor discharging temperature protection control : E416
 - Check for lack of refrigerant.
 - Check the blockage of the solenoid valve.
 - Check the malfunction of the exhaust temperature sensor.
 - Check the EEV.
13. Error of impossibility to operate heating at outdoor temperature exceeding 30°C : E440
 Error of impossibility to operate cooling at outdoor temperature of -5°C or under : E441
 - It is not the error code in the product and it is a specification to protect the product by limiting the temperature scope of use.
 - Use by referring to the temperature scope of use on the product manual, etc.
14. OLP overheating and compressor stop : E463
 - Check the opening of the sub valve.
 - Check the amount of the cooling water.
 - Check the OLP sensor.

15. Current sensor error : E468
 - Check the EEPROM data.
 - Check the PCB operation.

16. IPM (IGBT Module) or PFCM temperature sensor error : E474
IPM overheat error for outdoor unit inverter compressor : E500
 - Check whether IPM is correctly assembled on the heatproof plate.
 - Check whether the inlet is blockage.
 - If there is a defect, replace the IPM.

17. How to check Booster Fan
 - 1) In case of do not operate 1 Booster Fan
 - Action method : Remove the Booster Fan connector wire and cross-assembling the another Booster Fan wire and then horizontally or intermediate or swing operate.
 - Type ①: When the existing Booster Fan does not operate, replace the Booster Fan.
 - Type ②: If type 1 is not defective, Booster Fan Wire 4 (Red Wire),
3 (Black Wire) pin voltage : When it is more than 2.7V, replace the PCB.
 - 2) In case of do not operate 3 Booster Fan (all Fan)
 - Action method : horizontally or intermediate or swing set up.
 - Type ①: Booster Fan Wire 1 (Orange Wire), 3 (Black Wire) pin voltage : When it is less than DC12V, replace the PCB.
 - Type ②: If type 1 is not defective, Booster Fan Wire 4 (Red Wire),
3 (Black Wire) pin voltage : When it is more than 2.7V, replace the PCB.
 - Type ③: If type 2 is not defective, Booster Fan Wire 2 (White Wire),
3 (Black Wire) pin voltage : When it is approximately 5V, replace the PCB.

<p>① CN101-EARTH GND #1 : EARTH GND</p>	<p>② CN900-BLDC MOTOR #1 : DC 310V #3 : GND #4 : DC 15V #5 : FAN RPM #6 : RPM FEEDBACK</p>	<p>③ CN102-FUSE CHECK #1 : FUSE CHECK SIGNAL #2 : GND</p>	<p>④ CN950-SUCTION FAN #1,#5 #9 : DC12V #2 #6 #10 : FAN FEEDBACK #3 #7 #11 : GND #4 #8 #12 : FAN CTRL</p>
<p>⑤ CN401-HUMAN SENSING SENSOR #1 : DC 12V #2 : HUMAN SENSING SENSOR COMM(TXD) #3 : HUMAN SENSING SENSOR COM(M(RXD)) #4 : GND</p>	<p>⑥ CN802-DRAIN PUMP #1 : D/P POWER(DC 12V) #2 : GND</p>	<p>⑦ CN808-EEV #1~#4 : EEV SIGNAL OUTPUT #5 : DC 12V #6 : DC 12V</p>	<p>⑧ CN201-EEPROM #1 : GND #3 : DC 5V #4 : EEPROM_SHEET #5 : EEPROM_SO #6 : EEPROM_SI #7 : EEPROM_CLK</p>
<p>⑨ CN81-ERROR/COMP CHECK #1 : DC 12V #2 : ERROR SIGNAL OUTPUT(GND) #3 : DC 12V #4 : COMP/OPER. SIGNAL OUTPUT(GND)</p>	<p>⑩ CN501-DISPLAY #1 : BUZZER1 #2 : BUZZER2 #3 : LED1 #4 : LED2 #5 : LED3 #6 : LED4 #7 : LED5 #8 : LED6 #9 : LED7 #10 : LED8</p>	<p>⑪ CN310-2WIRED REMOCON #1 : DC 12V #2 : COM2_PCTRL_MICOM #3 : COM2_VCHECK_A #4 : COM2_VCHECK_B #5 : COM2_MICOM_AD #6 : DC5V #8 : COM2_C #9 : COM2_D #10 : COM2_TXD #11 : COM2_RXD #12 : GND</p>	<p>⑫ CN413-THERNISTOR #1 : EVA-IN THERMISTOR #2 : GND #3 : EVA-OUT THERMISTOR #4 : GND #5 : DISCHARGE THERMISTOR #6 : GND</p>
<p>⑬ CN810-SPI #1 : GND #2 : GND #3 : SPI POWER OUTPUT(DC 12V)</p>	<p>⑭ CN502-DISPLAY #1 : 12V #2 : LED9 #3 : LED10 #4 : LED11 #5 : LED12 #6 : LED13 #7 : REMOCON OUTPUT SIGNAL #8 : REMOCON INPUT SIGNAL #9 : GND #10 : DV5V</p>	<p>⑮ CN83-EXL CTRL #1 : GND #2 : EXT-CTRL SIGNAL</p>	<p>⑯ CN804-VENTILATOR #1 : DC 12V #2 : VENTILATOR SIGNAL OUTPUT(GND)</p>
<p>⑰ CN411-FLOAT S/W #1 : F/S SIGNAL #2 : GND</p>	<p>⑱ CN230-DOWNLOAD</p>	<p>⑲ CN412-ROOM SENSOR #1 : INDOOR THERMISTOR #2 : GND</p>	<p>⑳ CN809-AUTO GRILL #1 : DC 12V #4 : REMOCON SIGNAL #5 : GND</p>

5-1-2. Display PCB

■ 360 Cassette

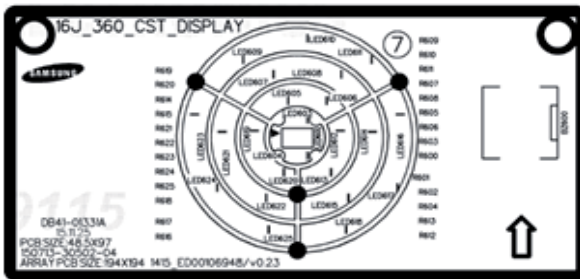

① CN401 – DISPLAY 1

- #1 : 12V
- #2 : VISUALIZATION LED_SECTION2, LAYER2
- #3 : VISUALIZATION LED_SECTION2, LAYER3
- #4 : VISUALIZATION LED_SECTION3, LAYER1
- #5 : VISUALIZATION LED_SECTION3, LAYER2
- #6 : VISUALIZATION LED_SECTION3, LAYER3

② CN501 – DISPLAY 2

- #1 : BUZZER1
- #2 : BUZZER2
- #3 : CENTER 3 COLOR LED - BLUE
- #4 : CENTER 3 COLOR LED - GREEN
- #5 : CENTER 3 COLOR LED - RED
- #6 : CENTER LED – ICE BLUE
- #7 : VISUALIZATION LED_SECTION1, LAYER1
- #8 : VISUALIZATION LED_SECTION1, LAYER2
- #9 : VISUALIZATION LED_SECTION1, LAYER3
- #10 : VISUALIZATION LED_SECTION2, LAYER1

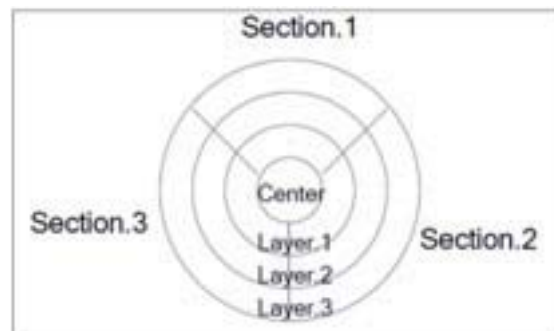

5-1-3. Outdoor PCB

■ Main PCB

- AC090/100/120/140MXAD*H

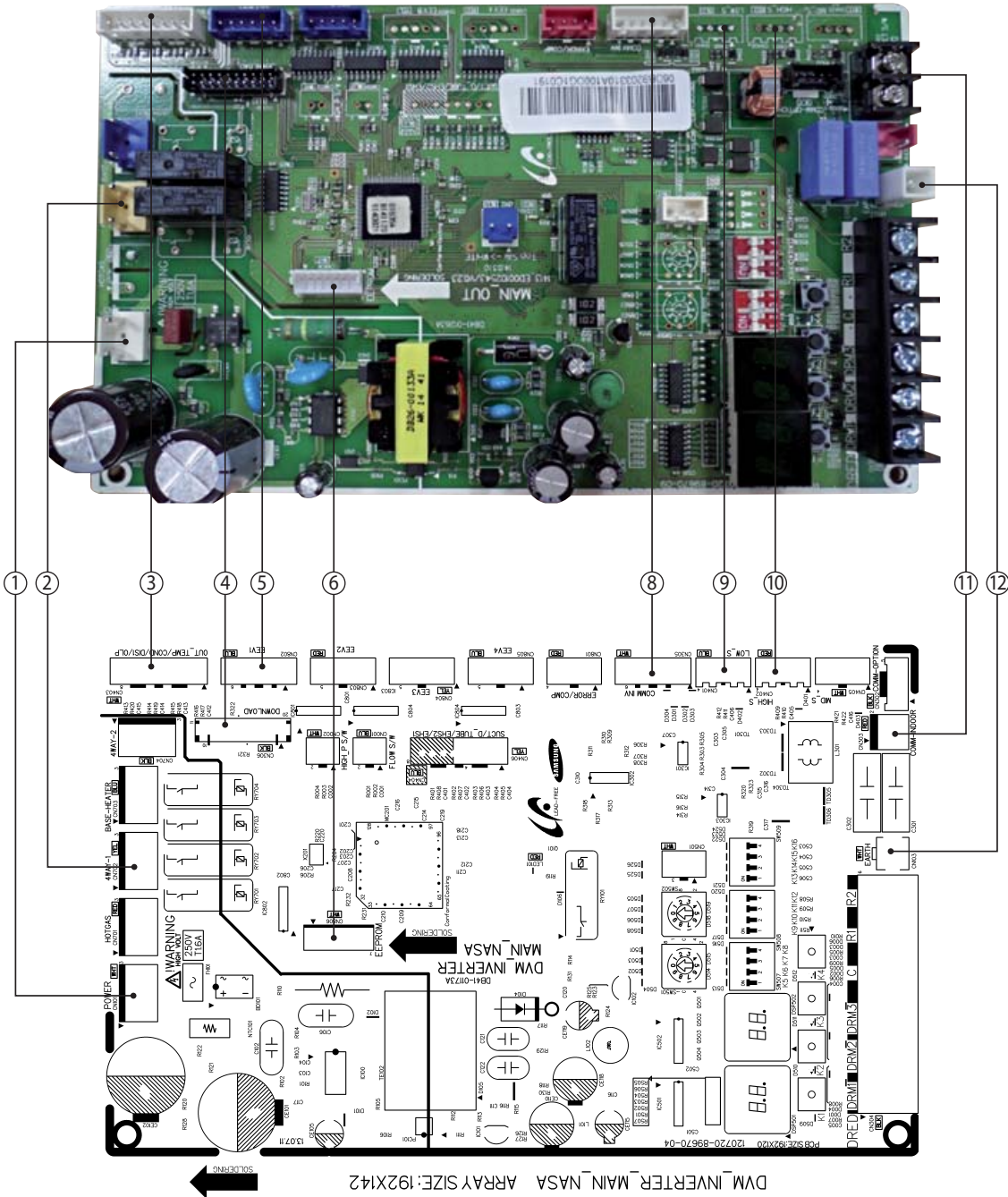

<p>① CN101 - POWER</p> <p>#1 : L #2 : N.C #3 : N</p>	<p>② CN702 - 4WAY</p> <p>#1 : N #2 : N.C #3 : 4WAY V/V SIGNAL</p>	<p>③ CN403 - SENSOR</p> <p>#1 : OUT TEMP #2 : GND #3 : COND TEMP #4 : GND #5 : DISCHARGE TEMP #6 : GND #7 : OLP TEMP #8 : GND</p>	<p>④ CN306 - DOWNLOAD</p> <p>#1 ~ #20 : DOWNLOAD</p>
<p>⑤ CN802 - EEV</p> <p>#1 ~ #4 : EEV SIGNAL #5,#6 : DC 12V</p>	<p>⑥ CN806 - EEPROM</p> <p>#1 ~ #7 : EEPROM</p>	<p>⑦ CN305 - COMM INV</p> <p>#1 : COMM SIGNAL #2 : COMM SIGNAL #3 : GND #4 : DC 5V #5 : DC 12V #6 : COMM SIGNAL</p>	<p>⑧ CN401 - LOW PRESSURE</p> <p>#1 : N.C #2 : SENSOR SIGNAL #3 : GND #4 : DC 5V</p>
<p>⑨ CN402 - HIGH PREWSSURE</p> <p>#1 : SENSOR SIGNAL #2 : N.C #3 : GND #4 : DC 5V</p>	<p>⑩ CN303 - COMM INDOOR</p> <p>#1 ~ # 2: COMM SIGNAL</p>	<p>⑪ CN103 - EARTH</p> <p>#1 : EARTH</p>	

Outdoor Unit PCB (cont.)

■ PF#4 INVERTER PCB : SINGLE-PHASE I

- AC090/100MXADKH

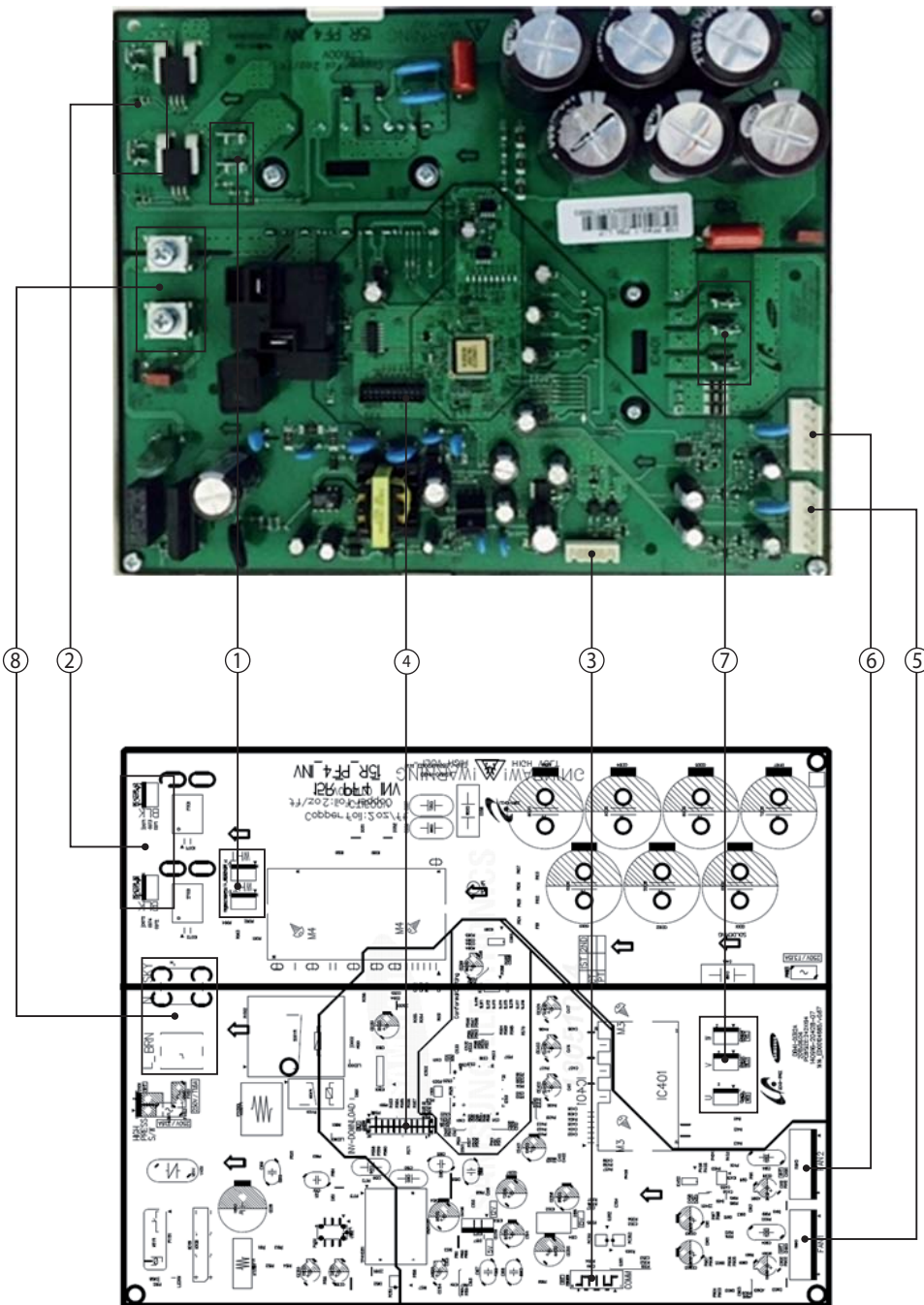

<p>① Reactor - A1/B1 #Reactor-A1 : WHT #Reactor-B1 : WHT</p>	<p>② Reactor - A2/B2 #Reactor-A2 : BLK #Reactor-B2 : BLK</p>	<p>③ Comp. W #1 : RXD #2 : TXD #3 : GND #4 : DV5V #5 : DV12V #6 : INV, SMPS Signal</p>	<p>④ CN551-INV-Download #1 : RXD_INV #2 : TXD_INV #3 : BOOT_INV #4 : TDO_INV #5 : TCK_INV #6 : TDI_INV #7 : TMS_INV #8 : nTRST #9 : GND #10~#11 : 5V #14#18#19 : ENC #17 : GND #20 : SUB</p>
<p>⑤ CN153-SMPS SUB_15V #1 : DC310V #2 : N.C #3 : GND #4 : DV15V #5 : Fan RPM #6 : Fan RPM Feedback</p>	<p>⑥ CN152-SMPS SUB #1 : DC310V #2 : N.C #3 : GND #4 : DV15V #5 : Fan RPM #6 : Fan RPM Feedback</p>	<p>⑦ CN204-DRED CN401 : Comp. U-phase(RED) CN402 : Comp. V-phase(BLU) CN403 : Comp. W-phase(YEL)</p>	<p>⑧ CN207-DISPLAY #1 : L-Phase/BRN #2 : N-Phase/SKY</p>

Outdoor Unit PCB (cont.)

■ PF#6-1 INVERTER PCB : 3-PHASE I
- AC100MXADNH

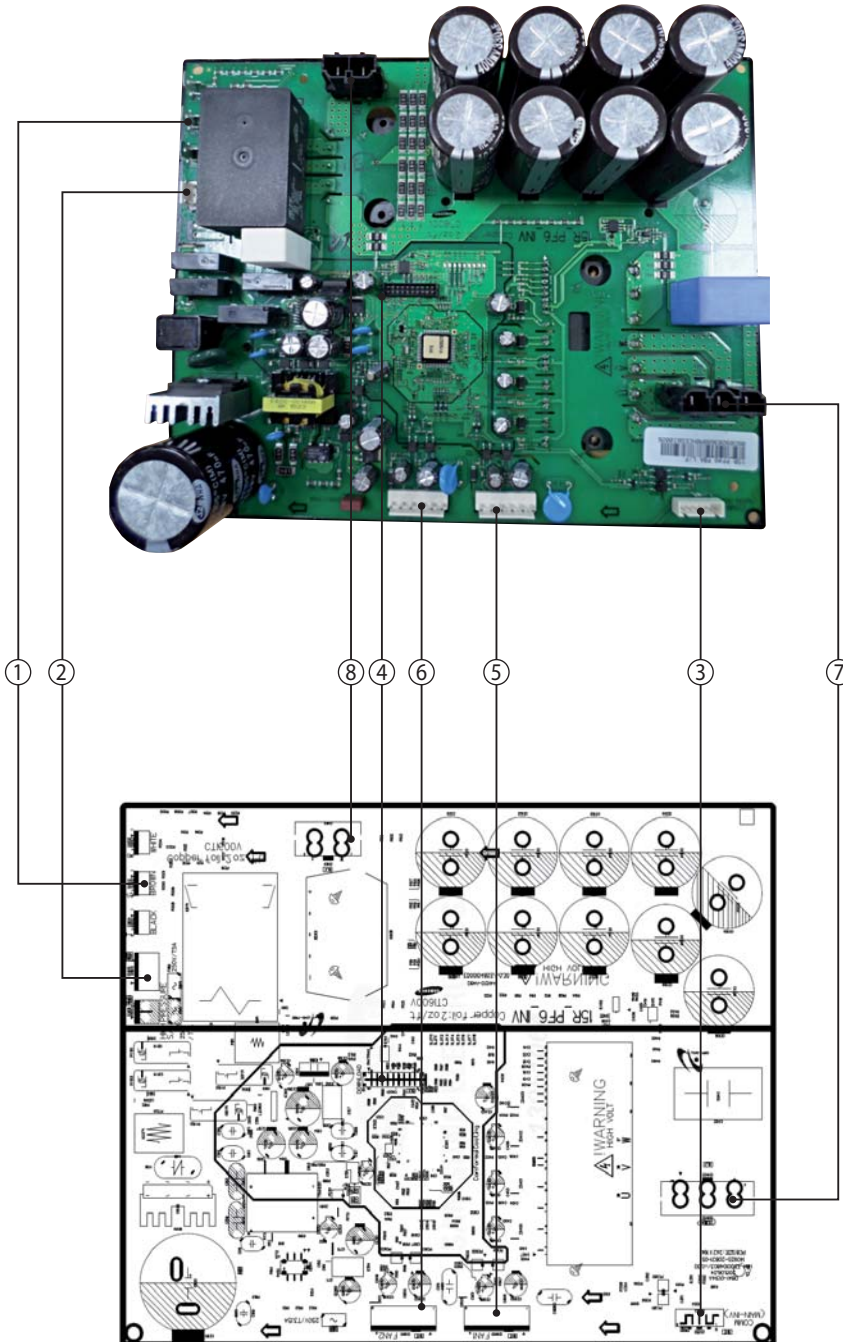

<p>① RST – AC Power 3phase #R : AC 380~400V : WHT #S : AC 380~400V : BRN #T : AC 380~400V : BLK</p>	<p>② CN100 – AC Power #1~#3 : AC 220~240V</p>	<p>③ CN31 – Main Comm #1 : RXD #2 : TXD #3 : GND #4 : DV 5V #5 : DV 12V #6 : INV, SMPS Signal</p>	<p>④ CN22 - Downloader #1 : RXD_INV #2 : TXD_INV #3 : BOOT_INV #4 : TDO_INV #5 : TCK_INV #6 : TDI_INV #7 : TMS_INV #8 : nTRST #9 : GND #10~#11 : 5V #14#18#19 : ENC #17 : GND #20 : SUB</p>
<p>⑤ CN900 – Fan1 #1 : DC310V #2 : N.C #3 : GND #4 : DV15V #5 : Fan RPM #6 : Fan RPM Feedback</p>	<p>⑥ CN901 - Fan2 #1 : DC310V #2 : N.C #3 : GND #4 : DV15V #5 : Fan RPM #6 : Fan RPM Feedback</p>	<p>⑦ CN400 – Comp. #1 : Comp. U-phase(RED) #2 : Comp. V-phase(BLU) #3 : Comp. W-phase(YEL)</p>	<p>⑧ CN101 - Reactor #1~#2 : Reactor</p>

Outdoor Unit PCB (cont.)

■ PF#4 Inverter PCB : Single-phase II

- AC120MXADKH

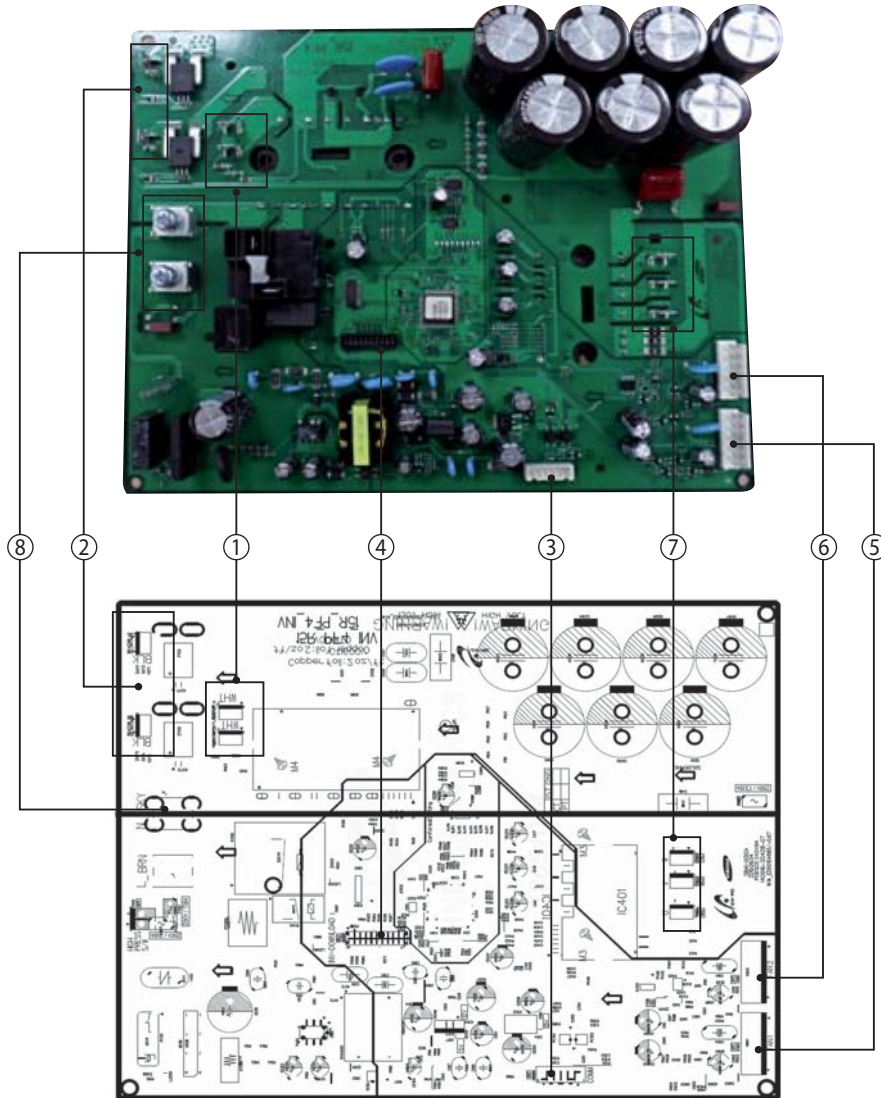

<p>① Reactor-A1/B1 #Reactor-A1 : WHT #Reactor-B1 : WHT</p>	<p>② Reactor-A2/B2 #Reactor-A2 : BLK #Reactor-B2 : BLK</p>	<p>③ CN351 - Main COMM #1 : RXD #2 : TXD #3 : GND #4 : DV5V #5 : DV12V #6 : INV, SMPS SIGNAL</p>	<p>④ CN551 – Downloader #1 : RXD_INV #7 : TMS_INV #2 : TXD_INV #8 : nTRST #3 : BOOT_INV #9 : GND #4 : TDO_INV #10~#11 : 5V #5 : TCK_INV #14 #18 #19 : ENC #6 : TDI_INV #17 : GND #20 : SUB</p>
<p>⑤ CN901 – FAN1 #1 : DC310V #2 : N.C #3 : GND #4 : DV15V #5 : FAN RPM #6 : FAN RPM Feedback</p>	<p>⑥ CN911 – FAN2 #1 : DC310V #2 : N.C #3 : GND #4 : DV15V #5 : FAN RPM #6 : FAN RPM Feedback</p>	<p>⑦ CN401,402,403 – Compressor CN401 : Compressor U-phase(RED) CN402 : Compressor V-phase(BLU) CN403 : Compressor W-phase(YEL)</p>	<p>⑧ L, N- 220V Power 1 : L-Phase/BRN #2 : N-Phase/SKY</p>

Outdoor Unit PCB (cont.)

■ PF#5 Inverter PCB : Single-phase III

- AC140MXADKH

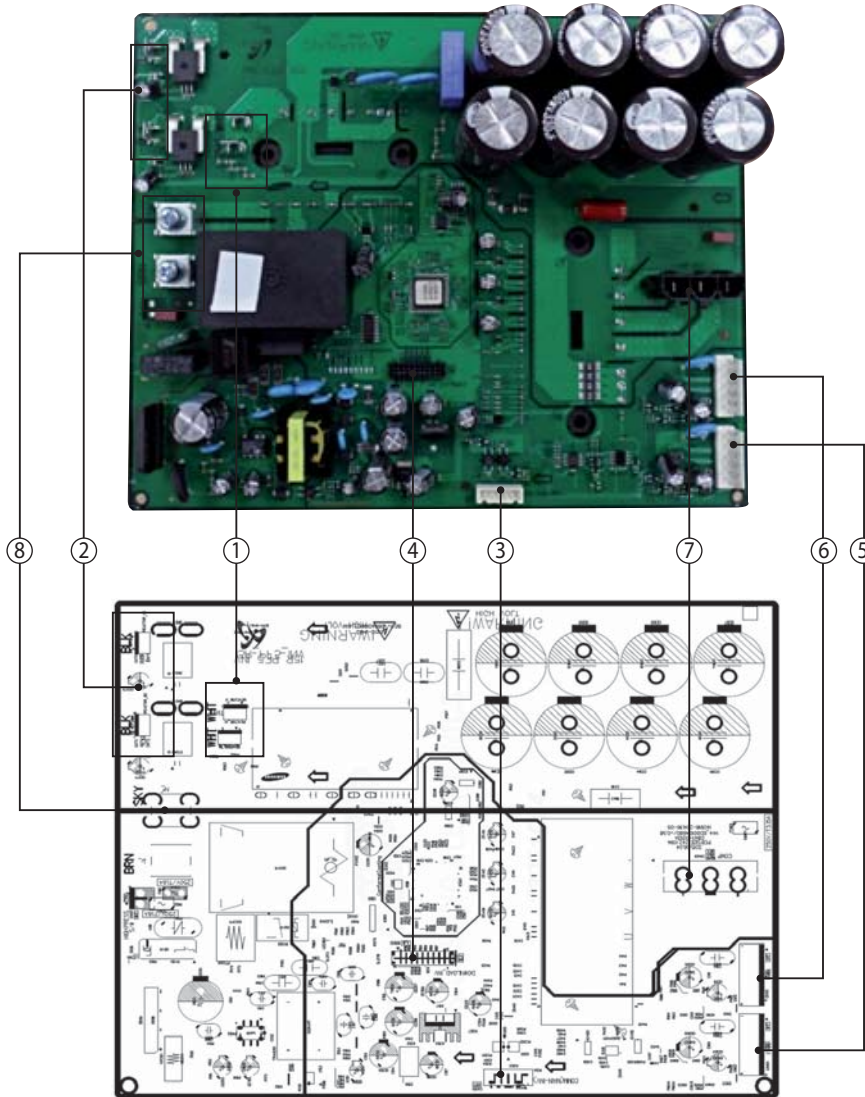

<p>① Reactor-A1/B1 #Reactor-A1 : WHT #Reactor-B1 : WHT</p>	<p>② Reactor-A2/B2 #Reactor-A2 : BLK #Reactor-B2 : BLK</p>	<p>③ CN351 - Main COMM #1 : RXD #2 : TXD #3 : GND #4 : DV5V #5 : DV12V #6 : INV, SMPS SIGNAL</p>	<p>④ CN551 – Downloader #1 : RXD_INV #7 : TMS_INV #2 : TXD_INV #8 : nTRST #3 : BOOT_INV #9 : GND #4 : TDO_INV #10~#11 : 5V #5 : TCK_INV #14 #18 #19 : ENC #6 : TDI_INV #17 : GND #20 : SUB</p>
<p>⑤ CN901 – FAN1 #1 : DC310V #2 : N.C #3 : GND #4 : DV15V #5 : FAN RPM #6 : FAN RPM Feedback</p>	<p>⑥ CN911 – FAN2 #1 : DC310V #2 : N.C #3 : GND #4 : DV15V #5 : FAN RPM #6 : FAN RPM Feedback</p>	<p>⑦ CN401,402,403 – Compressor CN401 : Compressor U-phase(RED) CN402 : Compressor V-phase(BLU) CN403 : Compressor W-phase(YEL)</p>	<p>⑧ L, N- 220V Power 1 : L-Phase/BRN #2 : N-Phase/SKY</p>

Outdoor Unit PCB (cont.)

■ PF#6 Inverter PCB : 3-phase II

- AC120/140MXADNH

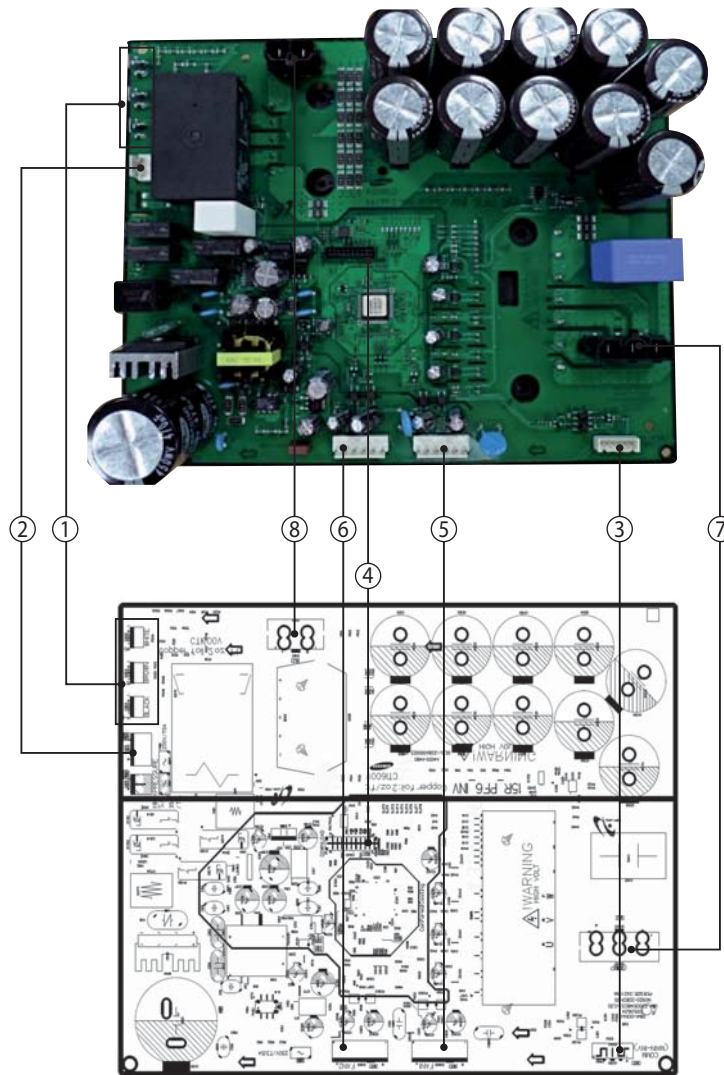

<p>① RST - AC Power 3phase #R : AC 380~400V : WHT #S : AC 380~400V : BRN #T : AC 380~400V : BLK</p>	<p>② CN100-AC Power #1-#3 : AC 220~240V</p>	<p>③ CN351 - Main COMM #1 : RXD #2 : TXD #3 : GND #4 : DV5V #5 : DV12V #6 : INV, SMPS SIGNAL</p>	<p>④ CN22-Downloader #1 : RXD_INV #7 : TMS_INV #2 : TXD_INV #8 : nTRST #3 : BOOT_INV #9 : GND #4 : TDO_INV #10~#11 : 5V #5 : TCK_INV #14 #18 #19 : ENC #6 : TDI_INV #17 : GND #20 : SUB</p>
<p>⑤ CN901 - FAN1 #1 : DC310V #2 : N.C #3 : GND #4 : DV15V #5 : FAN RPM #6 : FAN RPM Feedback</p>	<p>⑥ CN911 - FAN2 #1 : DC310V #2 : N.C #3 : GND #4 : DV15V #5 : FAN RPM #6 : FAN RPM Feedback</p>	<p>⑦ CN400 - Compressor CN401 : Compressor U-phase(RED) CN402 : Compressor V-phase(BLU) CN403 : Compressor W-phase(YEL)</p>	<p>⑧ CN101 - Reactor #1~#2 : Reactor</p>

Outdoor Unit PCB (cont.)

■ EMI PCB : single-phase

- AC090/120/140MXADKH

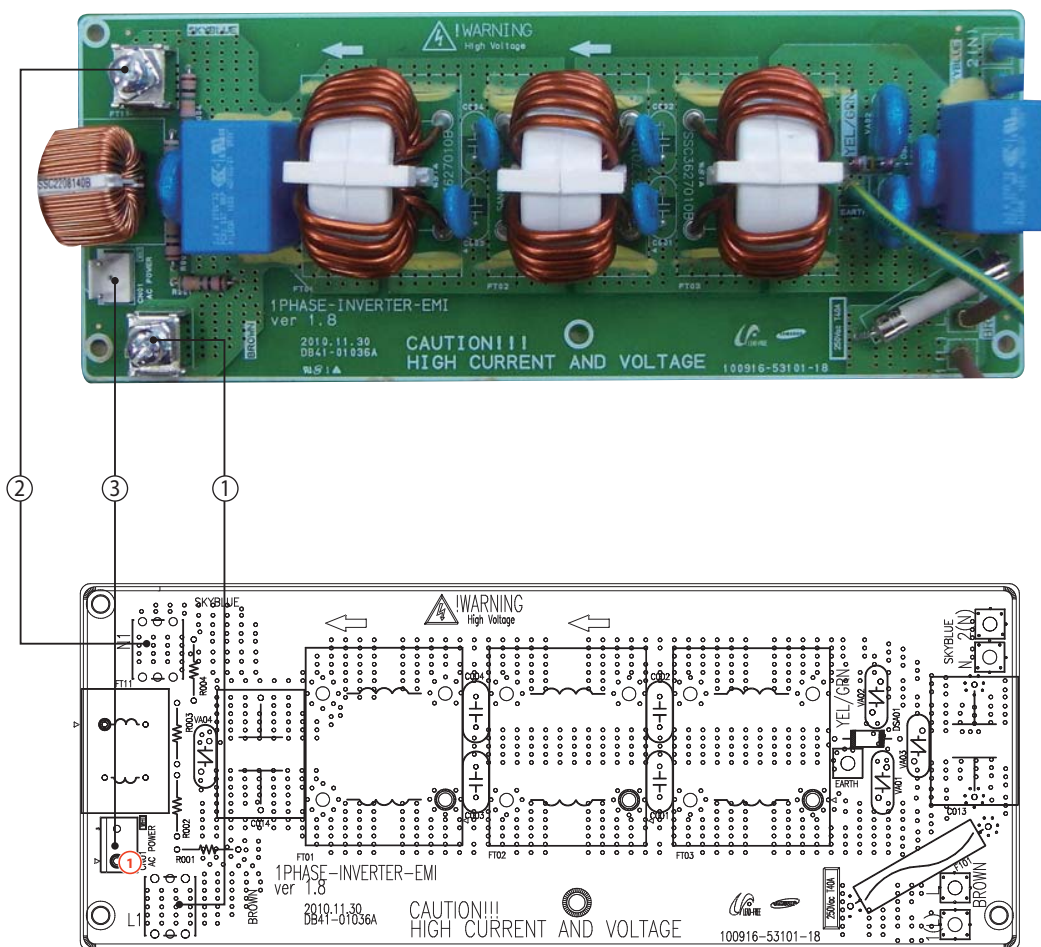

<p>① L1-AC Power L phase L1 : BRN</p>	<p>② N1-AC Power N phase N1 : SKY-BLU</p>	<p>③ CN01-AC Power #1-#3 : AC 220~240V</p>
---	---	--

Outdoor Unit PCB (cont.)

■PF#6 Inverter PCB : 3-phase

- AC100/120/140MXADNH

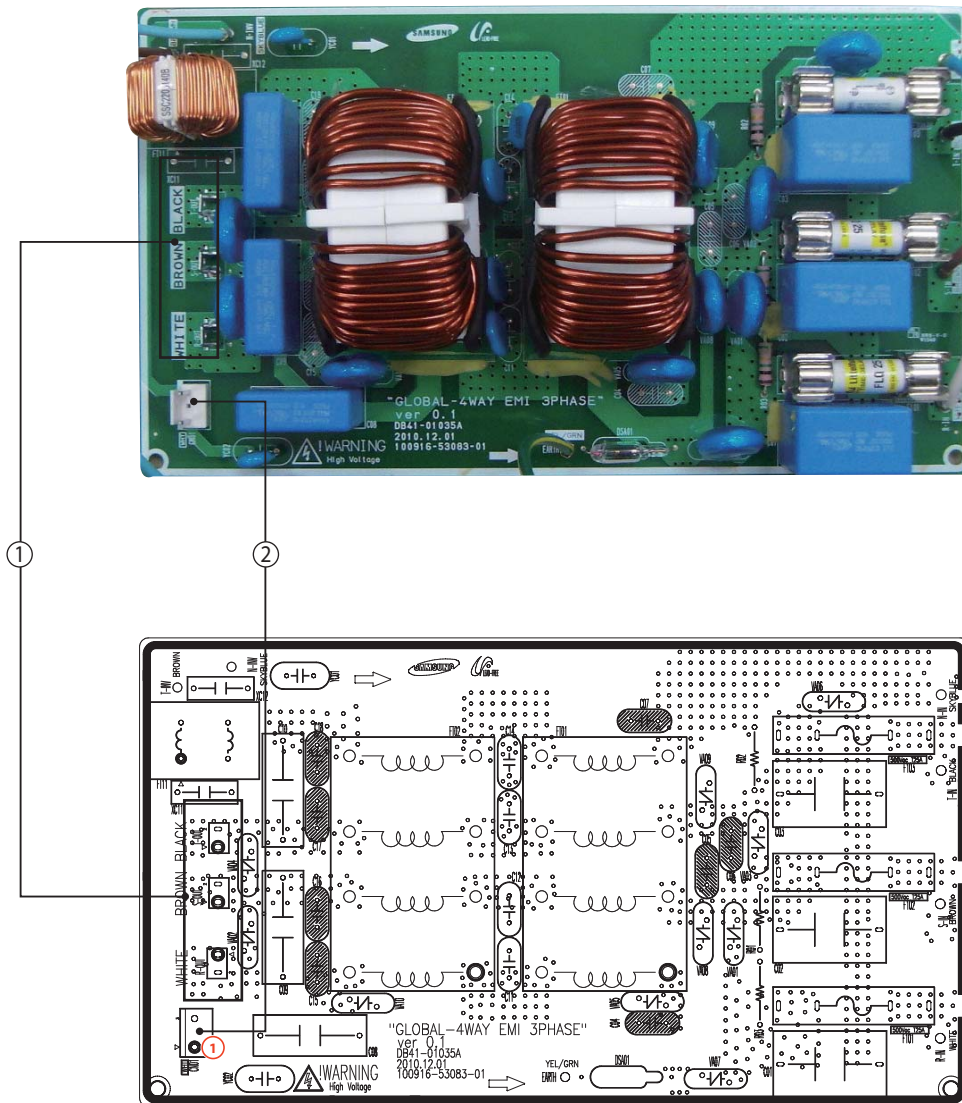

<p>① RST-AC Power 3phase #R : AC 380~400V : WHT #S : AC 380~400V : BRN #T : AC 380~400V : BLK</p>	<p>② CN100- AC Power #1-#3 : AC 220~240V</p>
--	---

6. Wiring Diagram

6-1. Indoor Unit

■ Circular Cassette

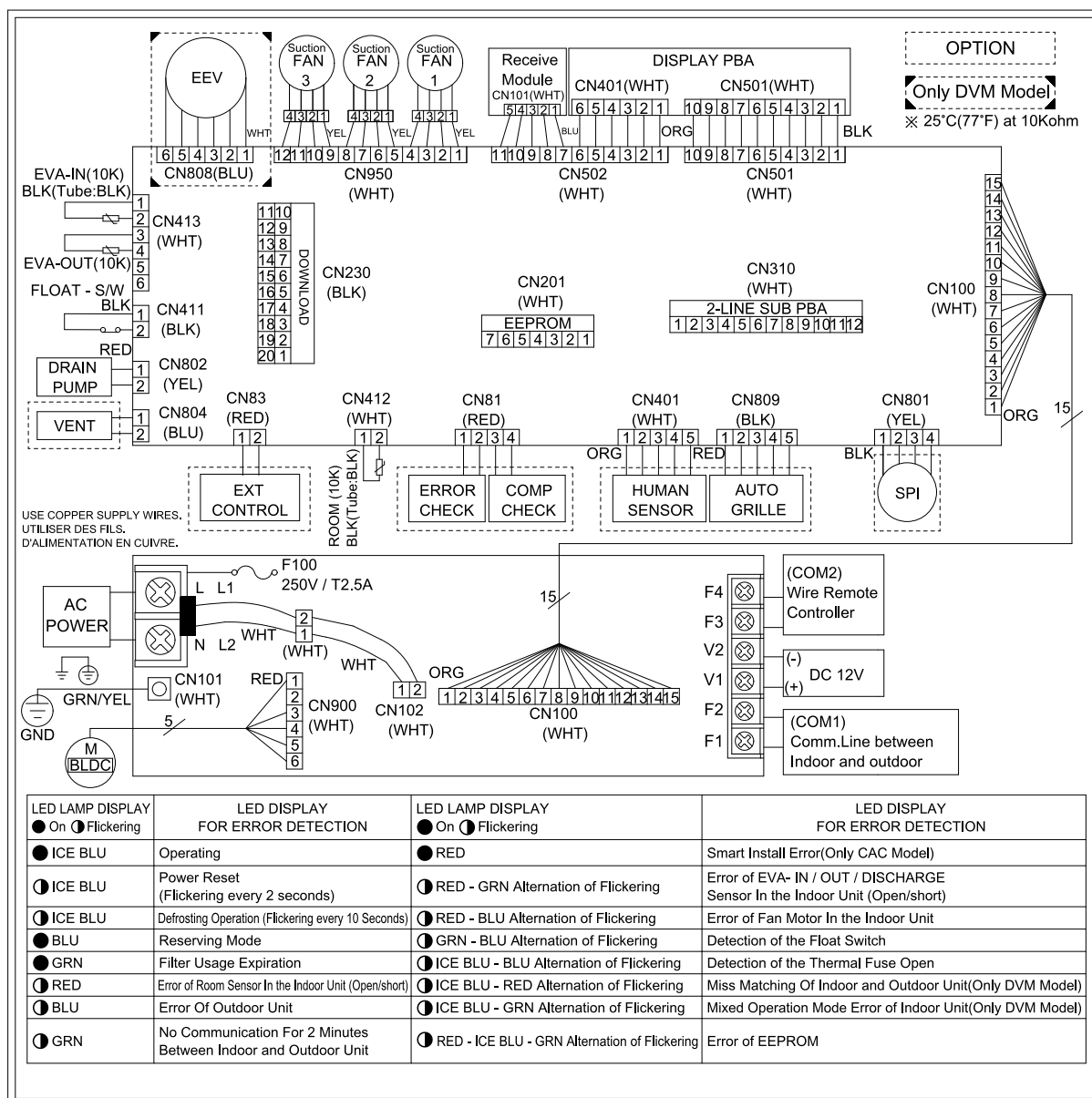

6-2. Outdoor Unit

Single-phase PF#4 / PF#4-1 / PF#5 Schematic Diagram

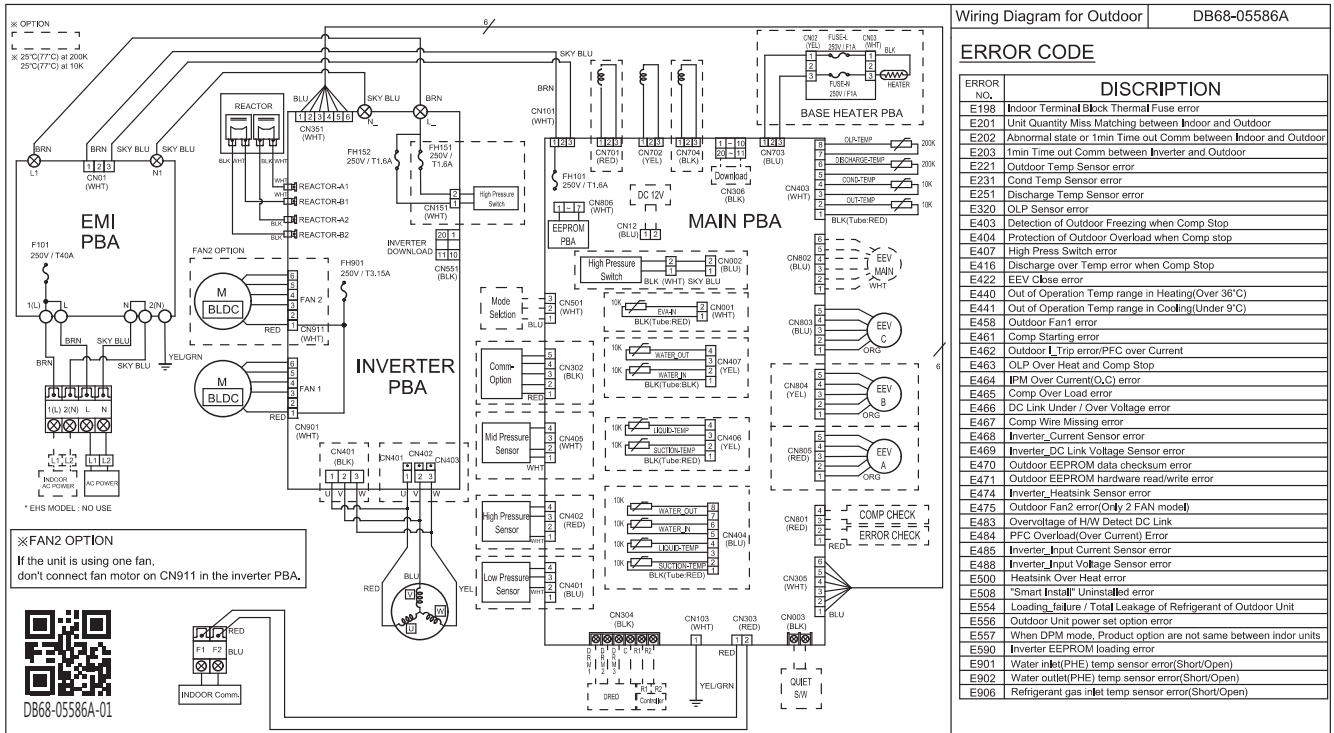

3-phase PF#6 / PF#6-1 Schematic Diagram

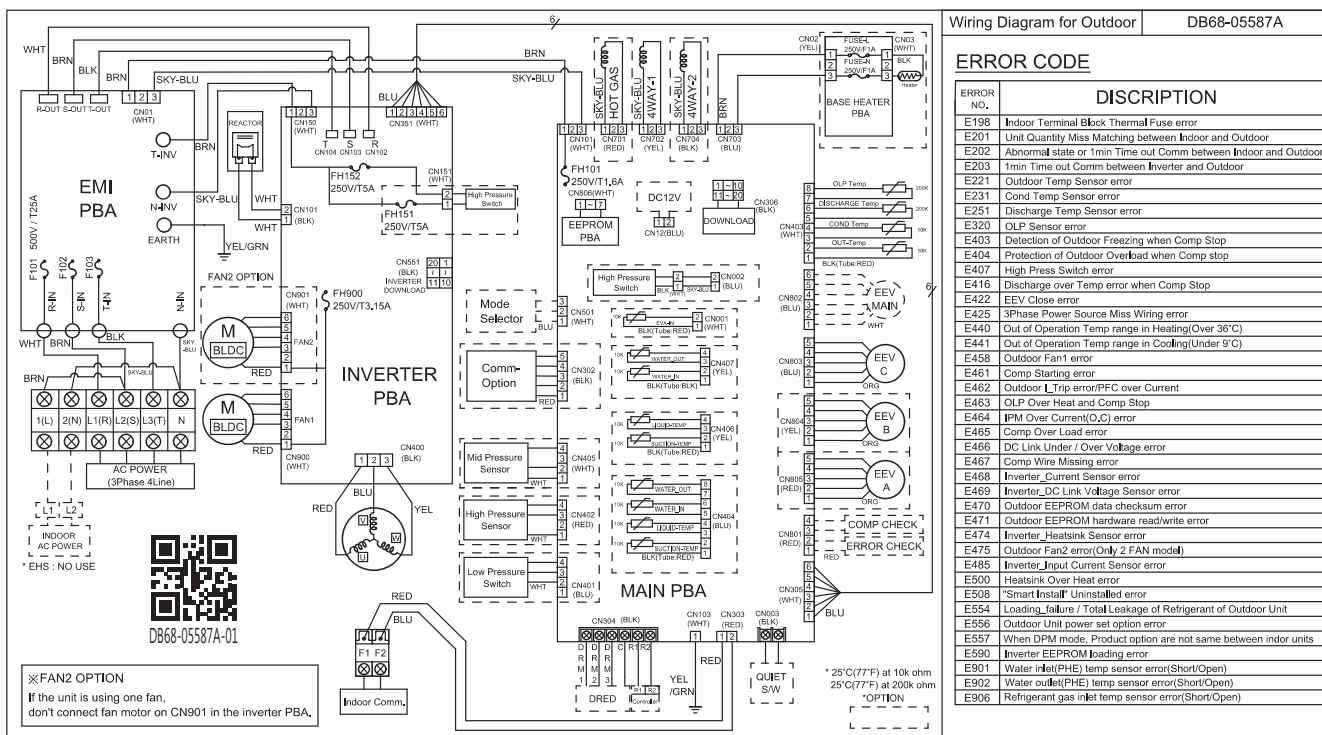

7. SW update

7-1. S-net pro Download

Download link : http://mosaic.sec.samsung.net/club/club.menu.bbs.list.screen?p_club_id=1219&p_menu_id=14

Note : If you do not have an authority to access the intranet, contact to your counter partner !!

S-NET Pro2 배포

전체기간 | 통합검색 | 검색 | 상세검색

번호 | 제목

9 | 2014.07.24 [v1.2.1] 배포

6 | 2014.07.24 [v1.2.1] 배포

5 | 2014.07.24 [v1.2.1] 배포

4 | 2014.07.24 [v1.2.1] 배포

3 | 2014.07.24 [v1.2.1] 배포

2 | [v1.2.1] 배포

S-NET Pro 배포 : for Non Nasa AC Micom & eeprom

S-NET Pro2 배포 : for Nasa AC Micom & eeprom

TU Tool 배포 : for Trane product(Nasa AC micom & eeprom)

gman 배포 : for Non Nasa AC Micom

7-2. RS485 VS RS232(UART)

	RS485(Through communication)	RS232(UART)
Feature	- Multiple IDUs update at once	- Fast update but one by one
Accessibility	- Easy, Connect F1/F2 to any IDUs or OUD	- Difficult, Connect UART cable to pcb directly
Speed	- approx. 10 min	- approx. 1 min
Power/Comm.	- Power supplied, Normal communication	- Power must be off
Application	- S-net pro 2	- S-net pro 2, Gman

7-3. How to update the Micom(RS485)

- Through RS485 communication.

Step 1 Connect S-converter to F1,F2 line

- F1,F2 terminal block on ODU
- F1,F2 connector on ODU's main pcb
- F1,F2 terminal block on IDU

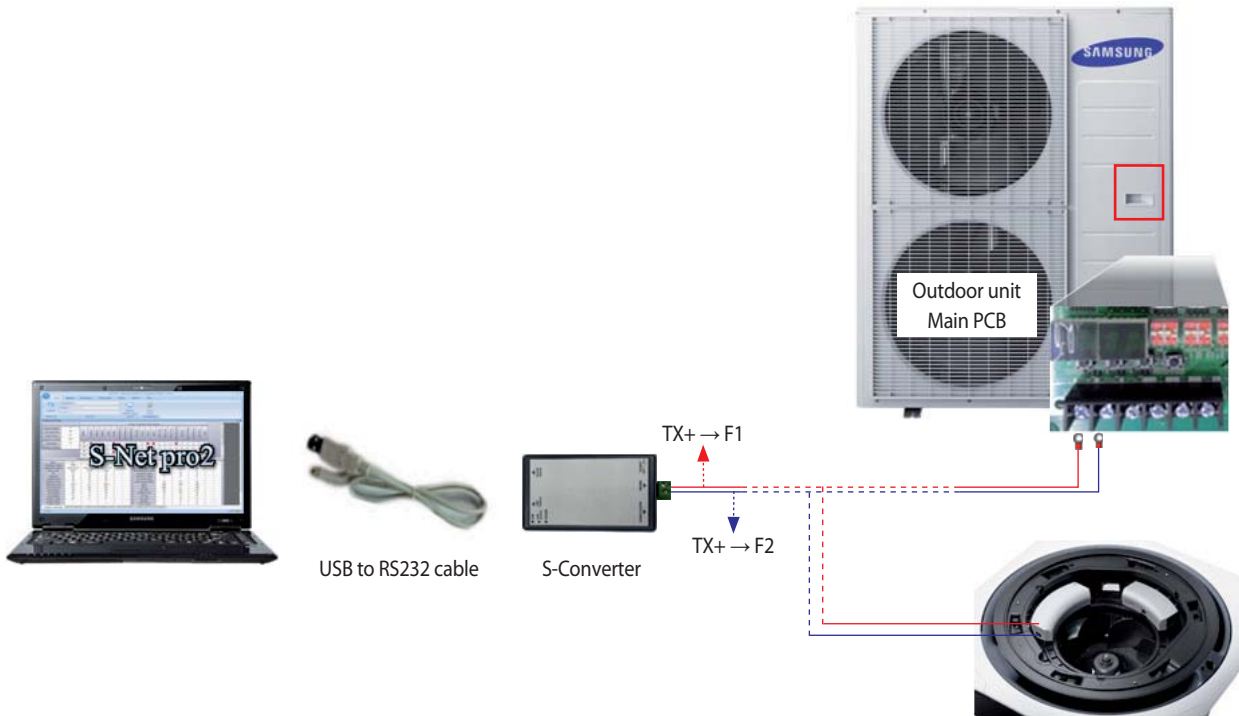

Step 2 Execute S-net pro 2 and set environment then click connect button

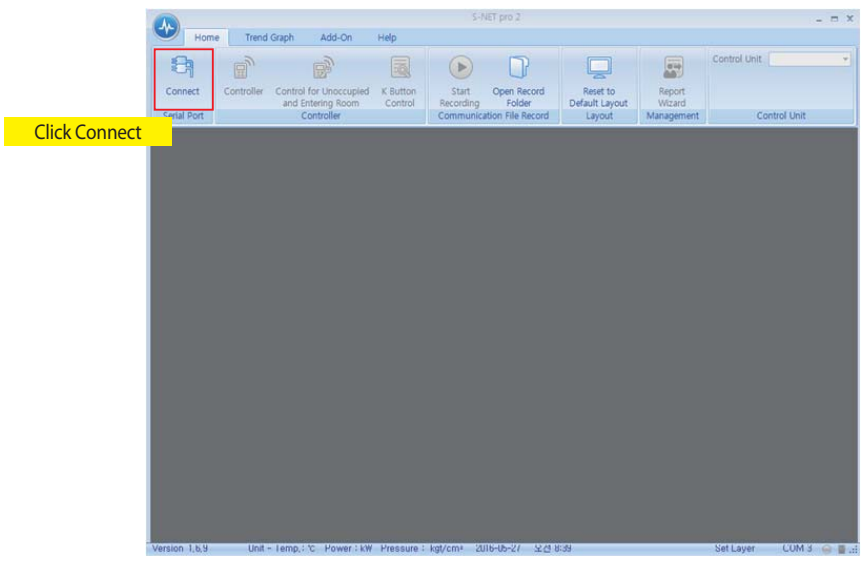

How to update the Micom(RS485) (cont.)

- SW Update of the hardware boards have always been critical operations. In order to reduce the time, increase usability and more on top of reliability of having the SW update successfully.
- A/C SW update enables the engineer to update the SW of indoor, outdoor and MCU boards when the S-Net Pro2 is in normal communication mode.
- This feature is applicable in the Live Mode only.

Step 3 Opening "A/C Unit SW Update" dialog

Click [Add-On] in ribbon toolbar. Select [A/C Unit SW Update] button when S-Net Pro2 is connected to serial port or on replay mode.



► Procedure

1. Select the type of device from the drop down [Indoor/ Outdoor/ MCU/Onoff Controller/PIM/SIM/PEAK/PowerDivider].

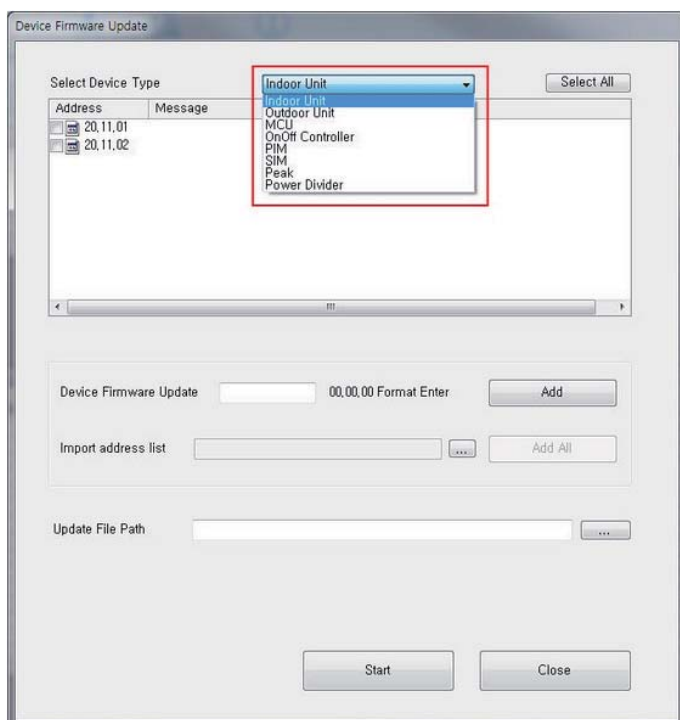

How to update the Micom(RS485) (cont.)

2. Browse and Select the *.hex file.

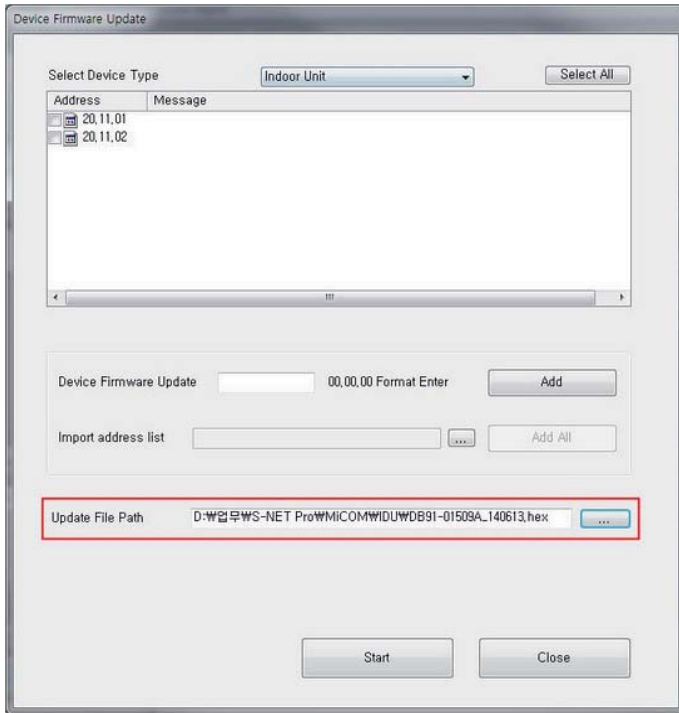

3. Select the device from the list of devices and select the address of the device.

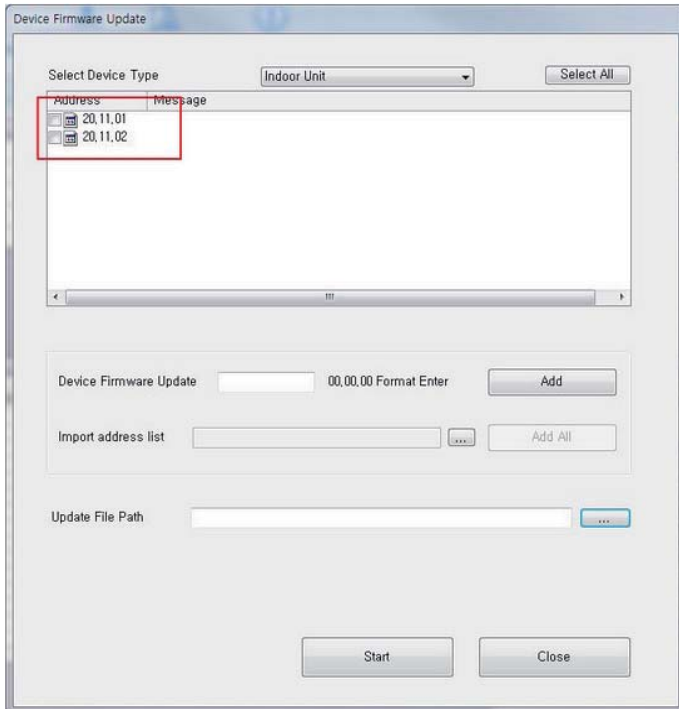

How to update the Micom(RS485) (cont.)

- 3-1 Manually entering the address of the device can leads to Firmware download failure
- To add the address of the device, enter value to Device Firmware Update field.
 - On clicking the Add button will be added to the list.



- 3-2 Importing the address list of the device that is saved previous trial.
- To add the address list of the device, browse address list at \Documents\S-NET pro2\Download
 - On clicking the Add All button will be added to the list.

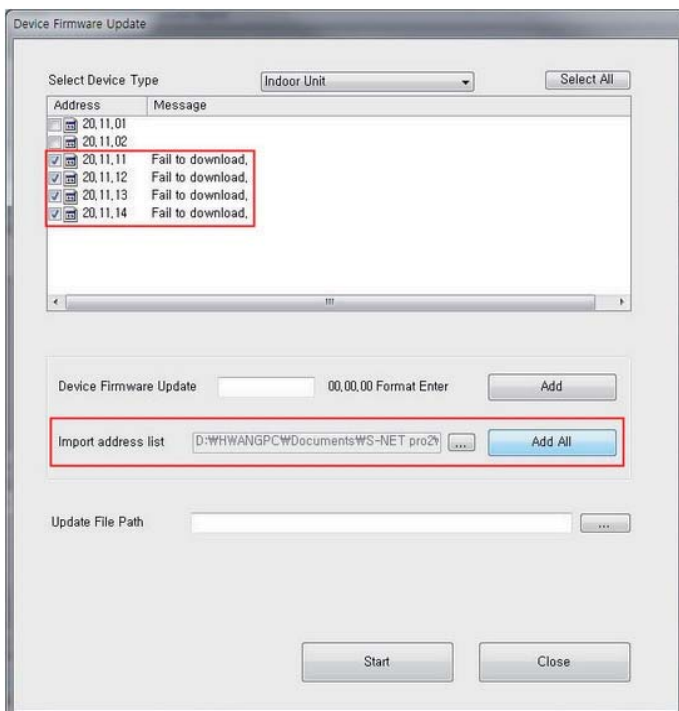

How to update the Micom(RS485) (cont.)

4. Click the Start button for initiating the SW update.
 - a. The firmware update for the device enters download mode will be displayed.
 - b. The progress bar at the bottom of the can check the progress of your downloads.

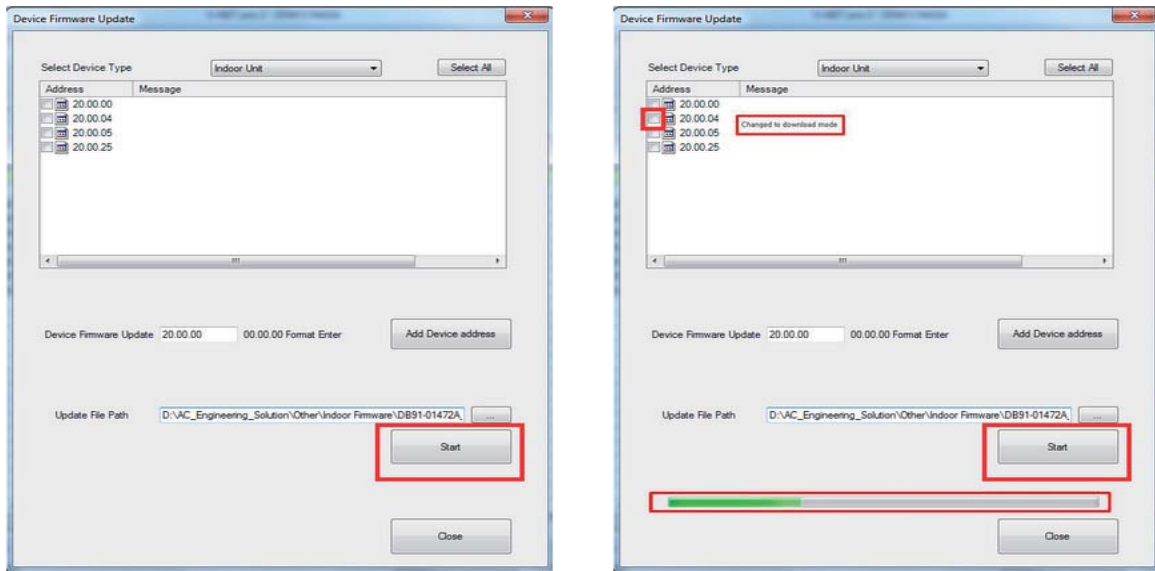

5. Firmware update failure
 - a. Please update manually if "Firmware Update CRC values are different." error message is displayed.
 - b. If the firmware update fails, disconnect the S-Net Pro2 communication and re-connect, and re-add the device manually to proceed.

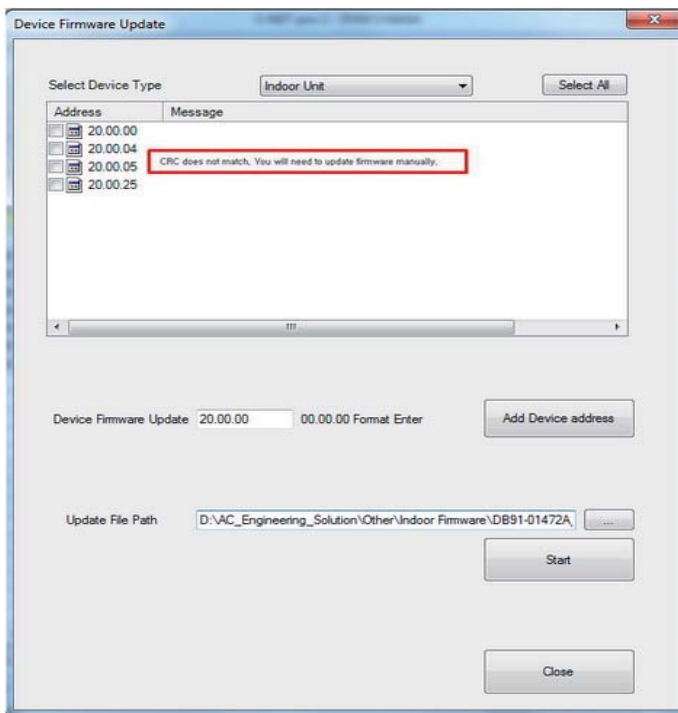

7-4. How to update the Micom(UART)

- Update SW through RS232(UART) communication.

Step 1

Power down the unit and prepare to connect download cable to the PCB
* 20 pin connector in black color(ODU - 10 pin connector)

Step 2

Execute S-net pro 2 and go to Add-On tab and click UART Update button

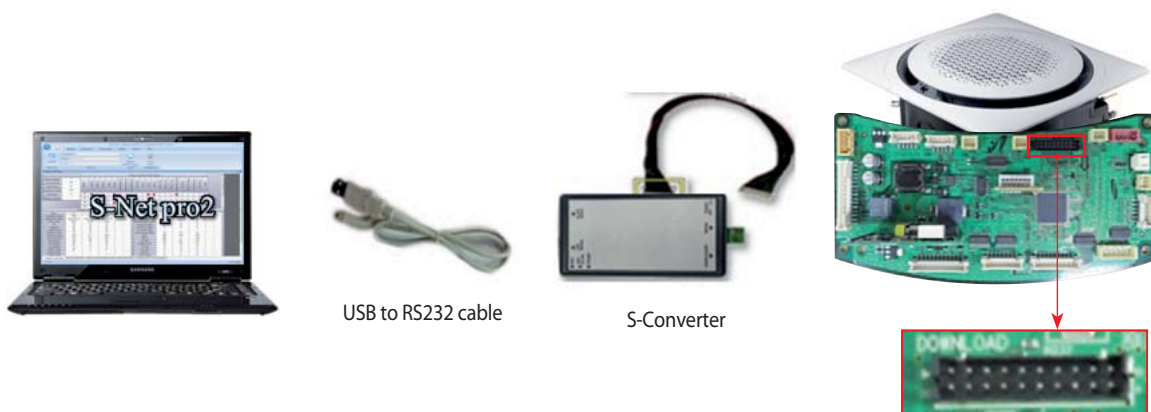

- UART update can be used for direct SW update to the hardware. The UART update can be used for SW update of indoor/outdoor/MCU. We need to connect the S-Net Pro2 to the device board "Download" connector through the download cable.
- S-Net Pro2 serial communication should be disconnected. If it is on connection, please disconnect by "Disconnect" button in "Home" ribbon tool bar. When it is still connected, "UART update" button is disabled.
- This feature is applicable in the Disconnected Mode only.

► Procedure

1. Connect the indoor/outdoor/MCU board through the download connector.
2. Open S-Net Pro2 and do not click "Connect" button
2. Click on the "UART update".
4. The update window pops up.

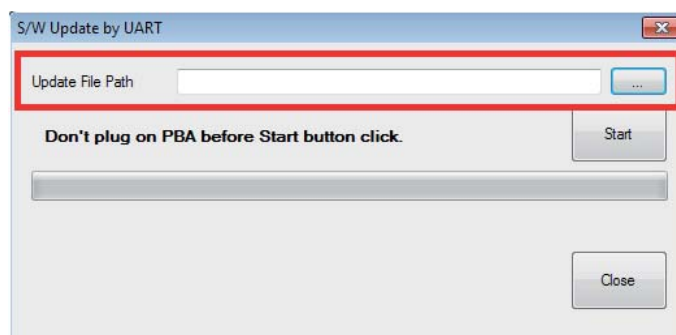

How to update the Micom(UART) (cont.)

5. Select the download file and Click "Start button" and then Turn On the S-Converter

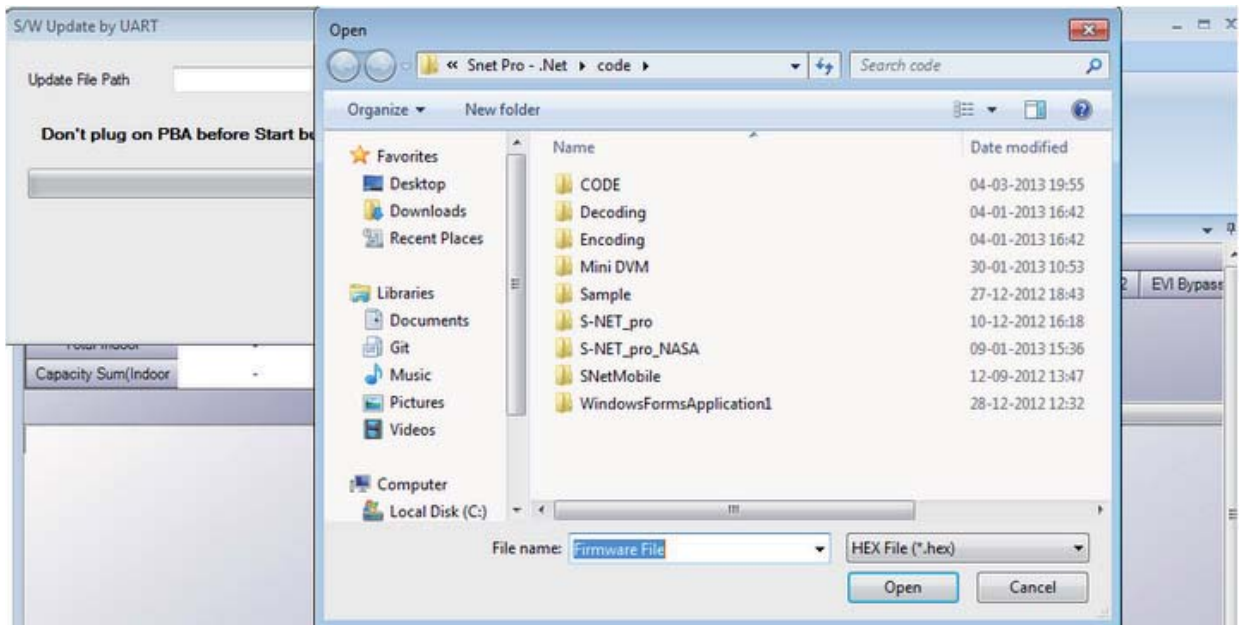

6. PCB will be updating

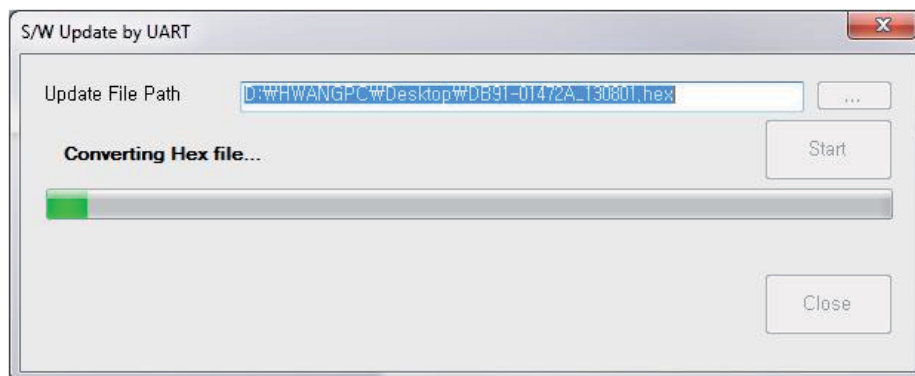

7-5. How to write the EEPROM

- update EEPROM through RS485 communication.

Step 1 Connect S-converter to F1,F2 line

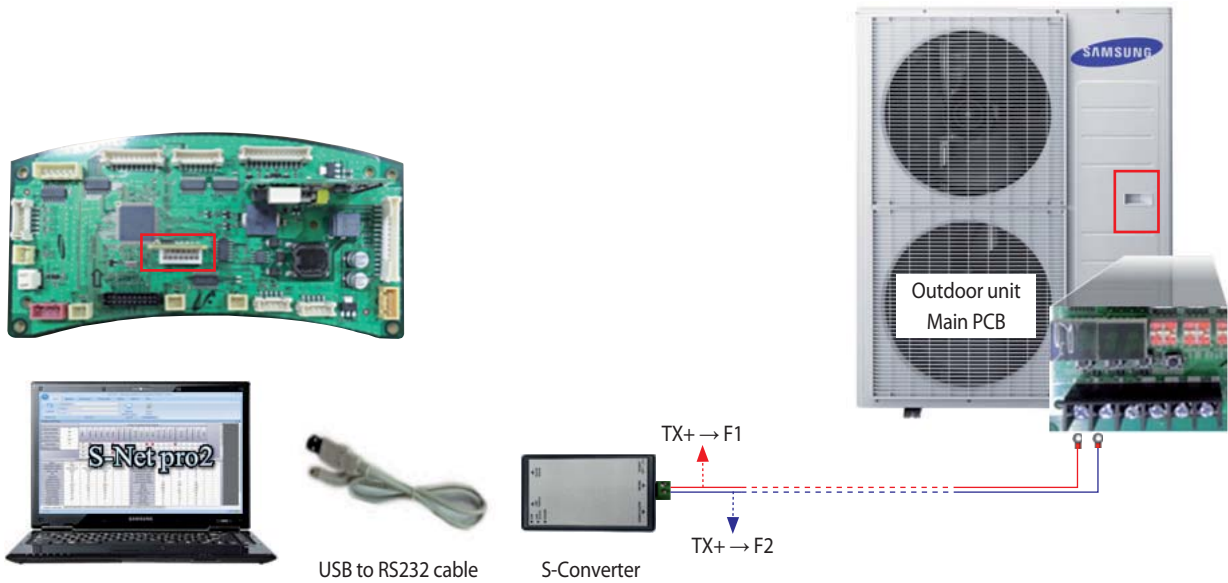

Step 2 Execute S-net pro 2 and set environment then click connect button

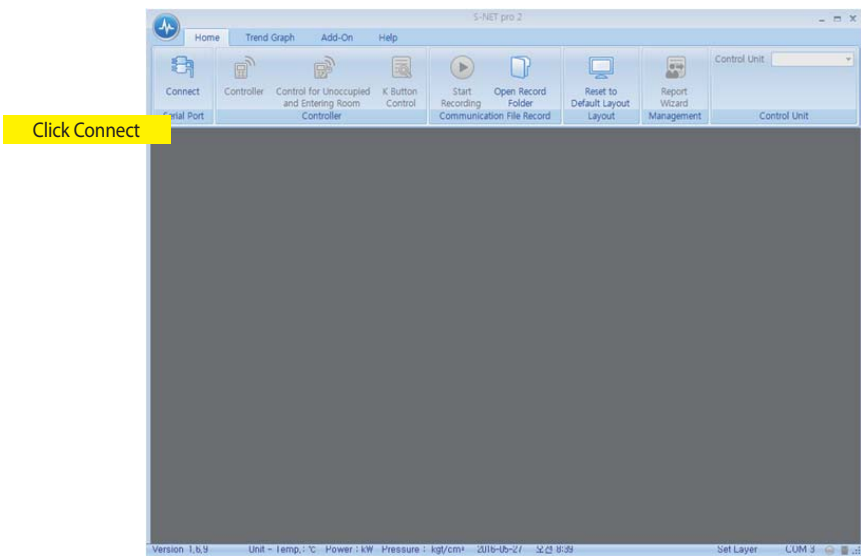

How to write the EEPROM (cont.)

Step 3 Go to Add-On tab and click EEPROM Writer

This feature of the outdoor unit is the ability to write data to the outdoor unit EEPROM settings. (EEPROM firmware, the outdoor unit, FAN version, DBCode to be saved, etc., in fact, write the EEPROM when the outdoor unit are rare.)

► Opening "Outdoor EEPROM Write" dialog

Click [Add-On] in ribbon toolbar. Select [Outdoor EEPROM Write] button.



► Setting configurations

1. To run EEPROM write operation choose address of the outdoor unit
2. Select All: To Select the entire outdoor unit.
3. 1:1 Direct: It writes data to all the currently connected outdoor Unit EEPROM, when you select the 1:1 Direct checkbox field then the address checkbox gets disabled.

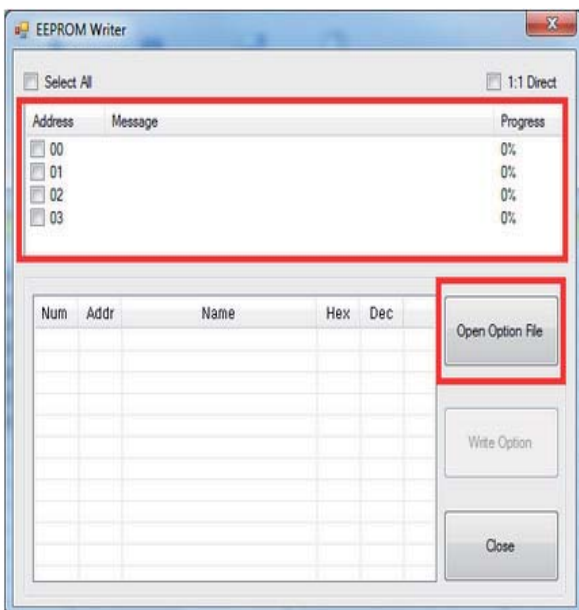

How to write the EEPROM (cont.)

► Loading a data file and Establishing connection

1. Click [Open Option File] button to read the source files (. Src). The contents of the file is displayed on the screen and [Write Option] button is activated

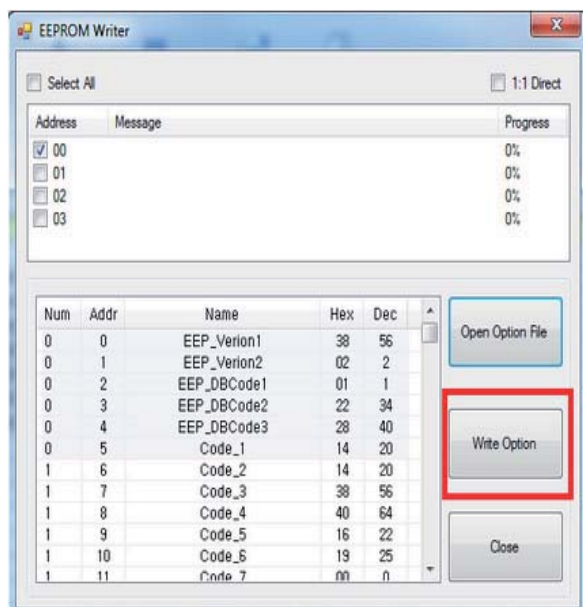

► Write Option

- Click [Write Option] button and the download status message will be displayed. Progress is to check download progress.

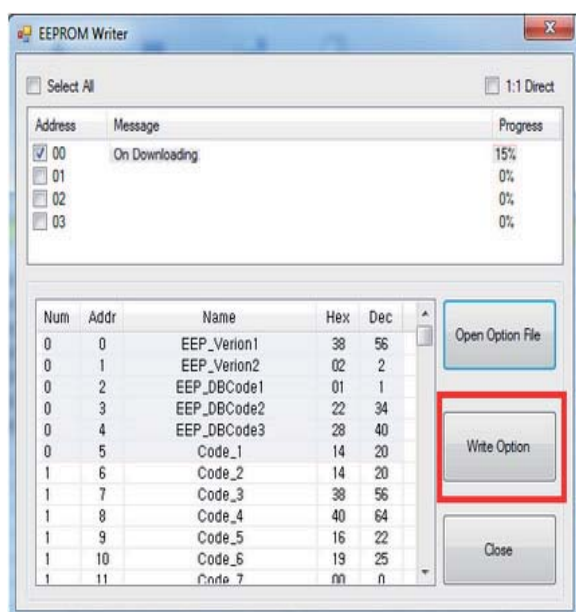

- This is only for Outdoor unit.
- EEPROM writing should be proceeded in case of EEPROM IC replacement by EEPROM IC defect.
Because all the data in the EEPROM IC will be deleted.
- * You need to proceed auto trial operation again.
- So when you replace main PCB, keep EEPROM IC and insert it to new PCB without EEPROM writing.
- * EEPROM data : eeprom file, S/N, Auto trail operation result, Ref amount check result, etc.

8. Reference Sheet

8-1. Index for model name

8-1-1. Indoor Unit

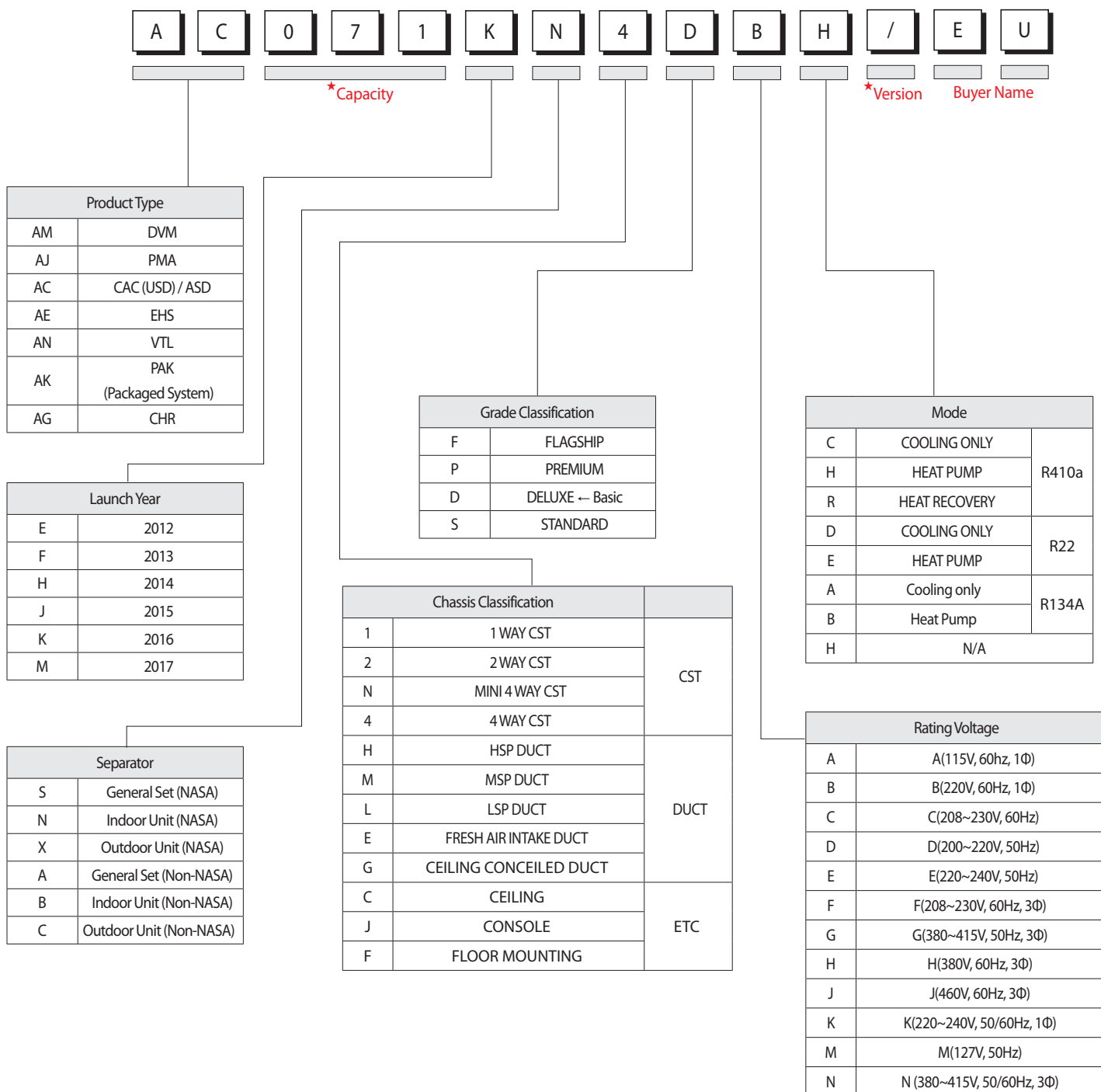

Index for model name (cont.)

8-1-2. Outdoor Unit

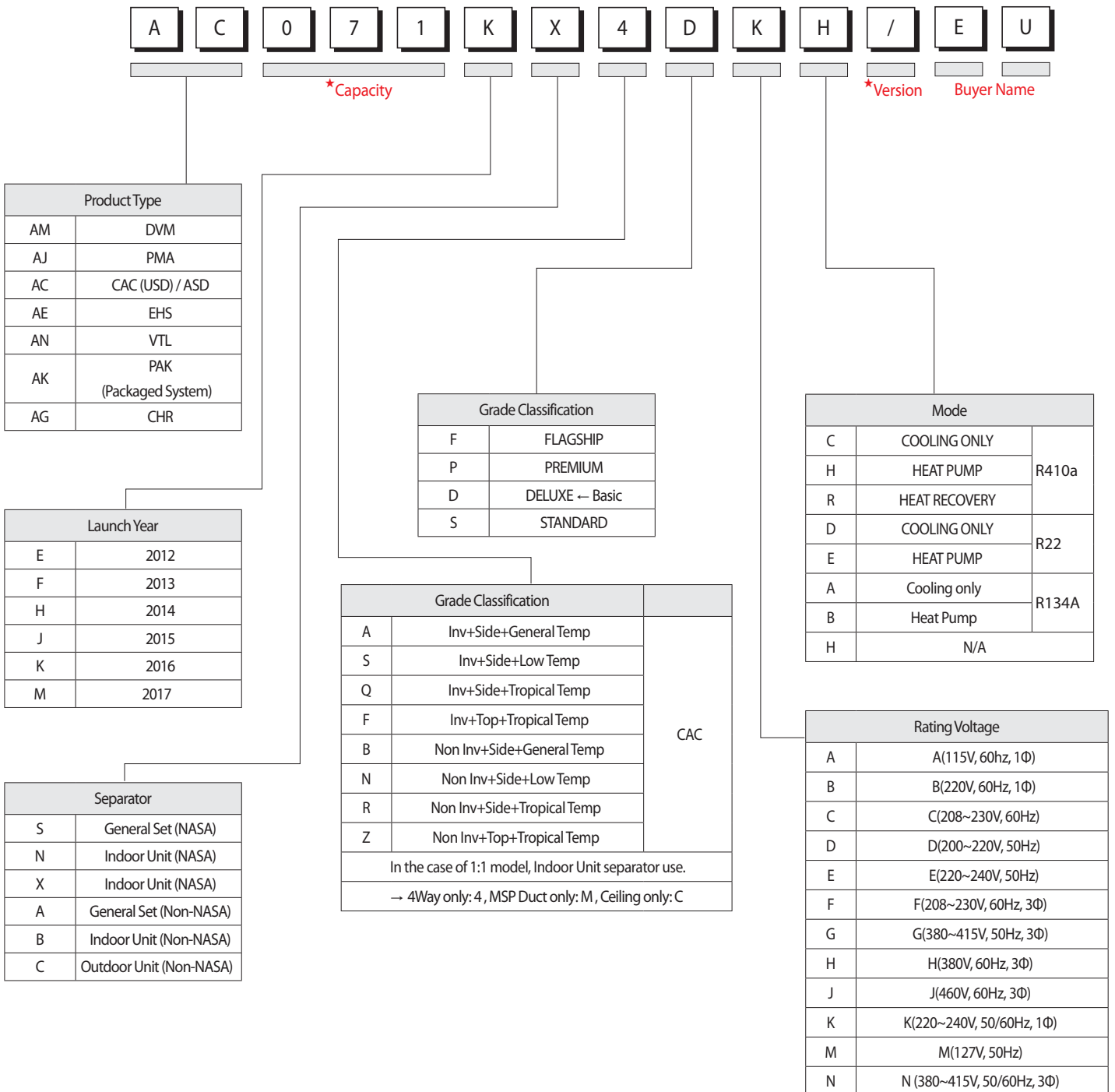

Index for model name (cont.)

8-1-3. Panel

■ PC4N***

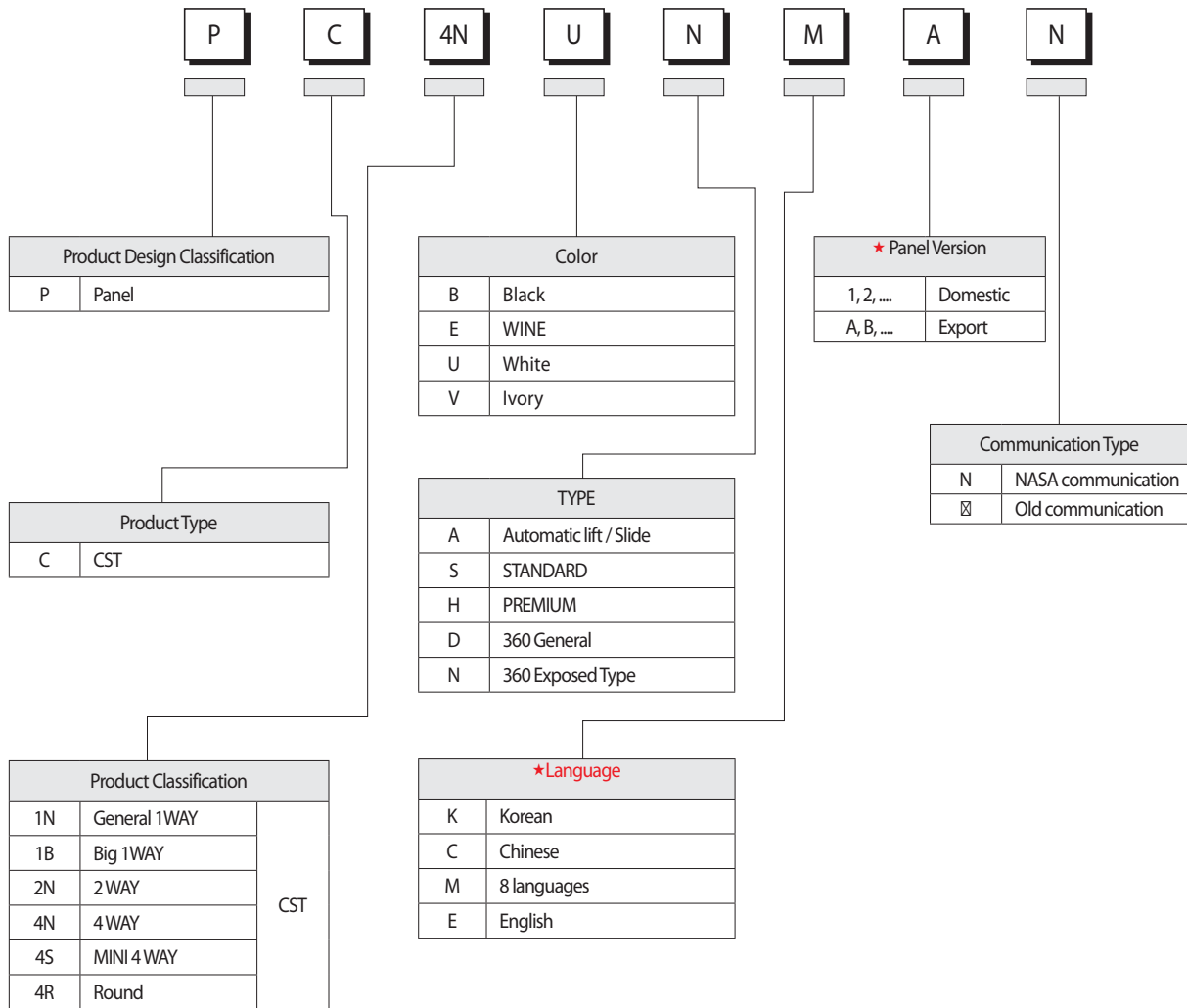

*※ Only, Global 4 Way Panel version.

Global 4Way Panel	Pattern	Waffle	Stripe
	Domestic	1	5
	Export	A	E

※ Only, display the Global 4 Way with Korean/ English K separator.

※ Only, model name for the bundle packaging is “~S”.

8-2 Refrigerating Cycle Diagram

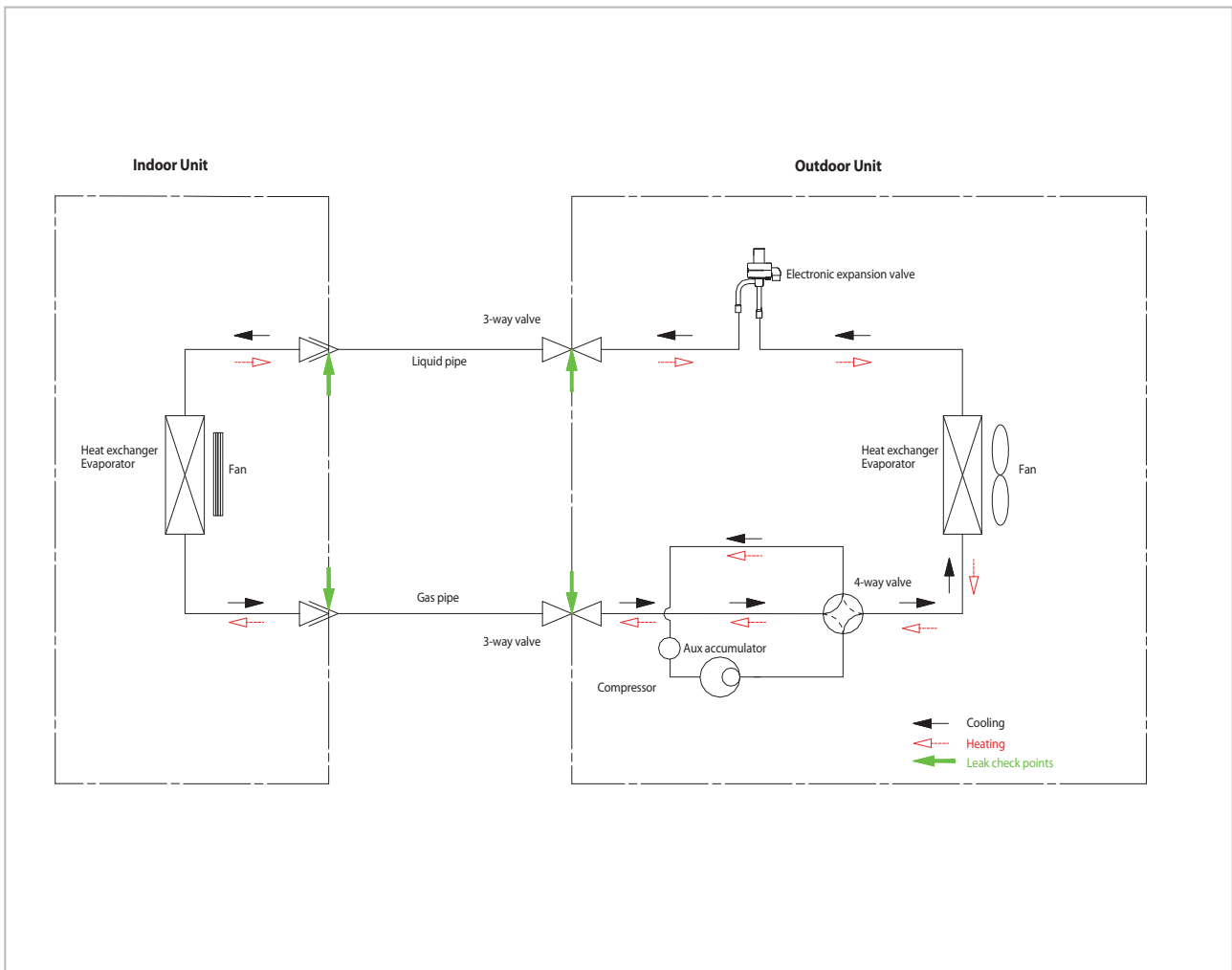

■ CONDENSER

High temperature and high pressure gas state coolant discharged from the compressor is converted to a liquid state as it is cooled down by the heat emission in the outdoor condenser unit, and sent to the evaporator.

■ COMPRESSOR

Low temperature and low pressure coolant is compressed and sent to the cycling system

■ EVAPORATOR

Liquid coolant sucked in through the capillary tubes cools down the room by absorbing the surrounding heat as it evaporates (converting from liquid to gas). (Absorbing heat required for evaporation)

■ SERVICE VALVE

You can open the valve by turning the need valve counterclockwise using hex wrench, and it is used for vacuum, gas purging, coolant injection, coolant purging, and indoor-outdoor unit connection.

■ ACCUMULATOR

Accumulator prevents the flow of liquid-state coolant into the compressor. (Liquid-state coolant flowing into the compressor will overload the compressor.)



GSPN (GLOBAL SERVICE PARTNER NETWORK)

Area	Web Site
Europe, CIS, Mideast & Africa	gspn1.samsungcportal.com
Asia	gspn2.samsungcportal.com
North & Latin America	gspn3.samsungcportal.com
China	china.samsungportal.com

This Service Manual is a property of Samsung Electronics Co., Ltd.
Any unauthorized use of Manual can be punished under applicable
International and/or domestic law.

© Samsung Electronics Co., Ltd. December. 2016.
Printed in Korea.
Code No. AC-00171E_1