



# Contents

---

## **INSTALLATION PARTS**

- Safety precautions ..... 3
- Accessories..... 5
- Selecting the installation location ..... 6
- Indoor unit installation .....19
- Purging the unit .....20
- Connecting the refrigerant pipe .....21
- Cutting/flaring the pipes.....22
- Performing leak test & insulation .....23
- Drain pipe and drain hose installation .....25
- Wiring work .....29
- Setting an indoor unit address and installation option.....32
- Setting temperature control of discharge air .....43
- Final check and trial operation .....43
- Providing information for user .....43
- Troubleshooting.....45
- Option table .....47
- Extending the power cable .....49

# Safety precautions

*(Carefully follow the precautions listed below because they are essential to guarantee the safety of the equipment.)*



## WARNING

- Always disconnect the air conditioner from the power supply before servicing it or accessing its internal components.
- Verify that installation and testing operations are performed by qualified personnel.
- Verify that the air conditioner is not installed in an easily accessible area.

## GENERAL INFORMATION

- ◆ Carefully read the content of this manual before installing the air conditioner and store the manual in a safe place in order to be able to use it as reference after installation.
- ◆ For maximum safety, installers should always carefully read the following warnings.
- ◆ Store the operation and installation manual in a safe location and remember to hand it over to the new owner if the air conditioner is sold or transferred.
- ◆ This manual explains how to install an indoor unit with a split system with two SAMSUNG units. The use of other types of units with different control systems may damage the units and invalidate the warranty. The manufacturer shall not be responsible for damages arising from the use of non compliant units.
- ◆ The manufacturer shall not be responsible for damage originating from unauthorized changes or the improper connection of electric and hydraulic lines. Failure to comply with these instructions or to comply with the requirements set forth in the "Operating limits" table, included in the manual, shall immediately invalidate the warranty.
- ◆ The air conditioner should be used only for the applications for which it has been designed: the indoor unit is not suitable to be installed in areas used for laundry.
- ◆ Do not use the units if damaged. If problems occur, switch the unit off and disconnect it from the power supply.
- ◆ In order to prevent electric shocks, fires or injuries, always stop the unit, disable the protection switch and contact SAMSUNG's technical support if the unit produces smoke, if the power cable is hot or damaged or if the unit is very noisy.
- ◆ Always remember to inspect the unit, electric connections, refrigerant tubes and protections regularly. These operations should be performed by qualified personnel only.
- ◆ The unit contains moving parts, which should always be kept out of the reach of children.
- ◆ Do not attempt to repair, move, alter or reinstall the unit. If performed by unauthorized personnel, these operations may cause electric shocks or fires.
- ◆ Do not place containers with liquids or other objects on the unit.
- ◆ All the materials used for the manufacture and packaging of the air conditioner are recyclable.
- ◆ The packing material and exhaust batteries of the remote control (optional) must be disposed of in accordance with current laws.
- ◆ The air conditioner contains a refrigerant that has to be disposed of as special waste. At the end of its life cycle, the air conditioner must be disposed of in authorized centers or returned to the retailer so that it can be disposed of correctly and safely.

## INSTALLING THE UNIT

**IMPORTANT:** When installing the unit, always remember to connect first the refrigerant tubes, then the electrical lines. Always disassemble the electric lines before the refrigerant tubes.

- ◆ Upon receipt, inspect the product to verify that it has not been damaged during transport. If the product appears damaged, DO NOT INSTALL it and immediately report the damage to the carrier or retailer (if the installer or the authorized technician has collected the material from the retailer.)
- ◆ After completing the installation, always carry out a functional test and provide the instructions on how to operate the air conditioner to the user.
- ◆ Do not use the air conditioner in environments with hazardous substances or close to equipment that release free flames to avoid the occurrence of fires, explosions or injuries.
- ◆ The air conditioner should be used only for the applications for which it has been designed: the indoor unit is not suitable to be installed in areas used for laundry.

# Safety precautions

- ◆ Our units must be installed in compliance with the spaces indicated in the installation manual to ensure either accessibility from both sides or ability to perform routine maintenance and repairs. The units' components must be accessible and that can be disassembled in conditions of complete safety either for people or things.  
For this reason, where it is not observed as indicated into the Installation Manual, the cost necessary to reach and repair the unit (in safety, as required by current regulations in force) with slings, trucks, scaffolding or any other means of elevation won't be considered in-warranty and charged to end user.

## POWER SUPPLY LINE, FUSE OR CIRCUIT BREAKER

- ◆ Always make sure that the power supply is compliant with current safety standards. Always install the air conditioner in compliance with current local safety standards.
- ◆ Always verify that a suitable grounding connection is available.
- ◆ Verify that the voltage and frequency of the power supply comply with the specifications and that the installed power is sufficient to ensure the operation of any other domestic appliance connected to the same electric lines.
- ◆ Always verify that the cut-off and protection switches are suitably dimensioned.
- ◆ Verify that the air conditioner is connected to the power supply in accordance with the instructions provided in the wiring diagram included in the manual.
- ◆ Always verify that electric connections (cable entry, section of leads, protections...) are compliant with the electric specifications and with the instructions provided in the wiring scheme. Always verify that all connections comply with the standards applicable to the installation of air conditioners.
- ◆ Be sure not to perform power cable modification, extension wiring, and multiple wire connection.
  - It may cause electric shock or fire due to poor connection, poor insulation, or current limit override.
  - When extension wiring is required due to power line damage, refer to "Extending the power cable" in the installation manual.









- ◆ **Make sure that you earth the cables.**
  - **Do not connect the earth wire to the gas pipe, water pipe, lighting rod or telephone wire.**  
**If earthing is not complete, electric shock or fire may occur.**
- ◆ **Install the circuit breaker.**
  - **If the circuit breaker is not installed, electric shock or fire may occur.**
- ◆ **Make sure that the condensed water dripping from the drain hose runs out properly and safely.**
- ◆ **Install the power cable and communication cable of the indoor and outdoor unit at least 1m away from the electric appliance.**
- ◆ **Install the indoor unit away from lighting apparatus using the ballast.**
  - **If you use the wireless remote control, reception error may occur due to the ballast of the lighting apparatus.**
- ◆ **Do not install the air conditioner in following places.**
  - **Place where there is mineral oil or arsenic acid.**  
**Resin parts flame and the accessories may drop or water may leak.**  
**The capacity of the heat exchanger may reduce or the air conditioner may be out of order.**
  - **The place where corrosive gas such as sulfurous acid gas generates from the vent pipe or air outlet.**  
**The copper pipe or connection pipe may corrode and refrigerant may leak.**
  - **The place where there is a machine that generates electromagnetic waves.**  
**The air conditioner may not operate normally due to control system.**
  - **The place where there is a danger of existing combustible gas, carbon fiber or flammable dust.**  
**The place where thinner or gasoline is handled.**  
**Gas may leak and it may cause fire.**

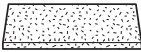
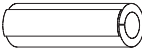
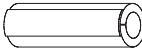
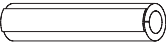

# Accessories

**The following accessories are supplied with the indoor unit.  
The type and quantity may differ depending on the specifications.**

<p>Insulation cover</p> 	<p>Thermal insulation A (use for refrigerant pipe)</p> 	<p>Thermal insulation B (use for refrigerant pipe)</p> 	<p>Thermal insulation (use for drain hose)</p> 
<p>User's manual</p> 	<p>Installation manual</p> 	<p>Flexible hose clamp</p> 	<p>Grommet</p> 
<p>Cable tie</p> 	<p>Flexible hose</p> 		

# Selecting the installation location

## Indoor Unit

- ◆ There must be no obstacles near the air inlet and outlet.
- ◆ Install the indoor unit on a ceiling that can support its weight.
- ◆ Maintain sufficient clearance around the indoor unit.
- ◆ Make sure that the water dripping from the drain hose runs away correctly and safely.
- ◆ The indoor unit must be installed in this way, that they are out of public access. (Not touchable by the users)
- ◆ After connecting a chamber, insulate the connection part between the indoor unit and the chamber with t10 or thicker insulation. Otherwise, there can be air leak or dew from the connection part.
- ◆ Rigid wall without vibration.
- ◆ Where it is not exposed to direct sunshine.
- ◆ Where the air filter can be removed and cleaned easily.

## Space requirements for installation & service

- ◆ Construction Standard for Inspection Hole.
  - 1) In case, the ceiling is textile, Inspection hole dose not need.
  - 2) In case, the ceiling is plaster board, Inspection hole depends on Inside height of the ceiling.
    - a. Height is more than 0.5m : Only "B" [Inspection for PBA] is applied.
    - b. Height is less than 0.5m : Both "A" & "B" are applied.
    - c. "A" & "B" are inspection holes.

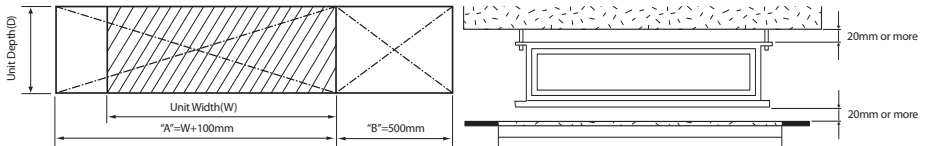

- You must have 20mm or more space between the ceiling and the bottom of indoor unit. Otherwise, the noise from the vibration of indoor unit may bother the user. When the ceiling is under construction, the hole for check-up must be made to take service, clean and repair the unit.
- It is possible to install the unit at an height of between 2.2~2.5m from the ground, if the unit has a duct with a well defined length (300mm or more), to avoid fan motor blower contact.

## Insulation Guide

- ◆ Insulate the end of the pipe and some curved area by using separate insulator.
- ◆ Insulate the discharge and suction part at the same time when you insulate connection duct.
- ◆ If the humidity is over 80%, it is required to add 10mm polyethylene foam or other similar insulation to the indoor unit when installing belt or pipe type indoor unit on the ceiling.

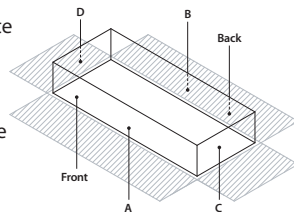

Thickness: more than 10mm

Indoor unit		A	B	C	D	Front	Back
Slim Duct Home	1.7~3.6kW (700x199x440)	700x200	700x200	440x200	440x200	Insulate the front and back side in proper size at the same time when insulating the suction duct and discharge duct.	
Slim Duct	1.7~3.6kW (700x199x600)	700x200	700x200	600x200	600x200		
	4.5~5.6kW (900x199x600)	900x200	900x200	600x200	600x200		
	7.1kW (1100x199x600)	1100x200	1100x200	600x200	600x200		
	9.0~14.0kW (1300x295x690)	1300x300	1300x300	690x300	690x300		
Ma Duct	4.5~7.1kW (900x480x260)	900x260	900x260	480x260	480x260		
	9.0kW (1150x480x260)	1150x260	1150x260	480x260	480x260		
	11.2kW (1150x480x320)	1150x320	1150x320	480x320	480x320		
	12.8~16.0kW (1200x650x360)	1200x360	1200x360	650x360	650x360		
HSP Duct	11.2~14.0kW (1200x650x360)	1200x360	1200x360	650x360	650x360		
Home Duct1	4.5~5.6kW (900x199x440)	900x200	900x200	440x200	440x200		
Home Duct2	7.1kW (1100x199x440)	1100x200	1100x200	440x200	440x200		

# Selecting the installation location

AM017/022/028/036KNLD\*\*\*

Unit : mm

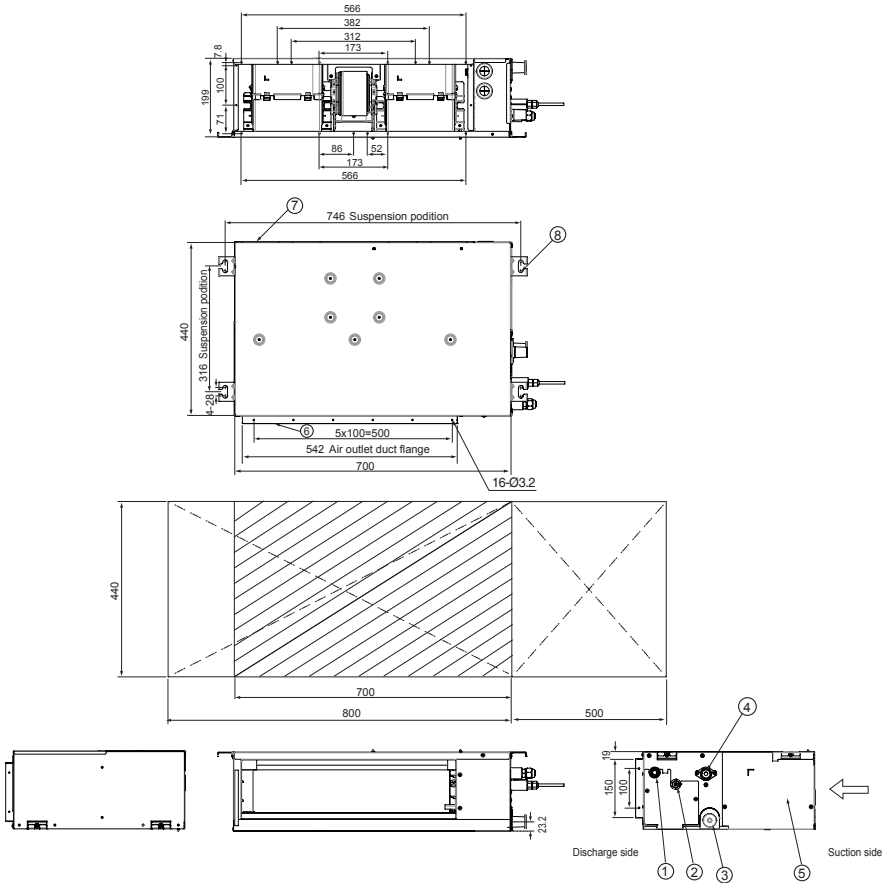

No.	Name	Description
1	Liquid pipe connection	ø6.35
2	Gas pipe connection	ø12.70
3	Drain pipe connection	OD ø25, ID ø20
4	Drain pipe connection (Option drain pump)	OD ø25, ID ø20
5	Power supply/Communication connection	--
6	Power supply connection	--
7	Air discharge grille flange	--
8	Hook	ø9.52 or M10

AM017/022/028/036\*NLD\*\*\*

Unit : mm

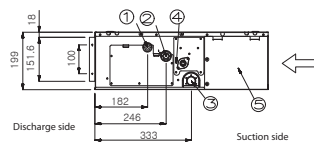
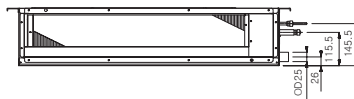
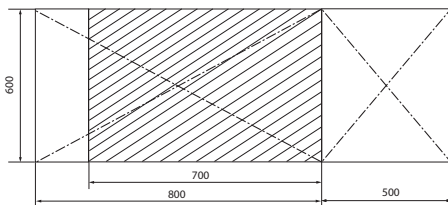
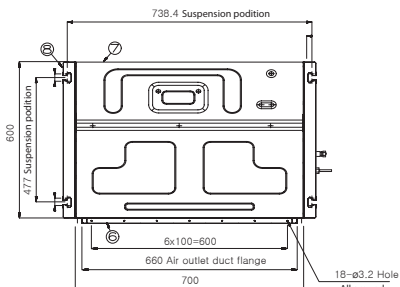
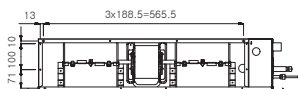

No.	Name	Description
1	Liquid pipe connection	ø6.35
2	Gas pipe connection	ø12.70
3	Drain pipe connection	OD ø25, ID ø20
4	Drain pipe connection (Option drain pump)	OD ø25, ID ø20
5	Power supply/Communication connection	--
6	Power supply connection	--
7	Air discharge grille flange	--
8	Hook	ø9.52 or M10

# Selecting the installation location

**AM045/056\*NLD\*\*\***  
**AM022/028/036\*NMD\*\*\***

Unit : mm

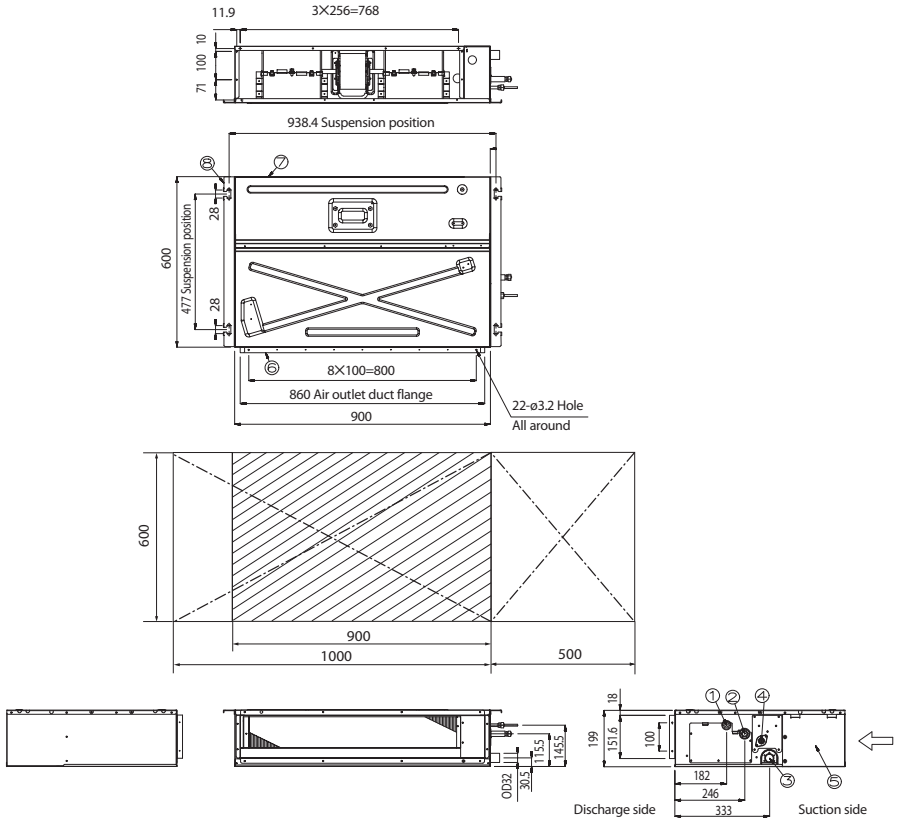

No.	Name	Description
1	Liquid pipe connection	ø6.35
2	Gas pipe connection	ø12.70
3	Drain pipe connection	OD ø25, ID ø20
4	Drain pipe connection (Option drain pump)	OD ø25, ID ø20
5	Power supply/Communication connection	--
6	Power supply connection	--
7	Air discharge grille flange	--
8	Hook	ø9.52 or M10

**AM071\*NLD\*\*\***

Unit : mm

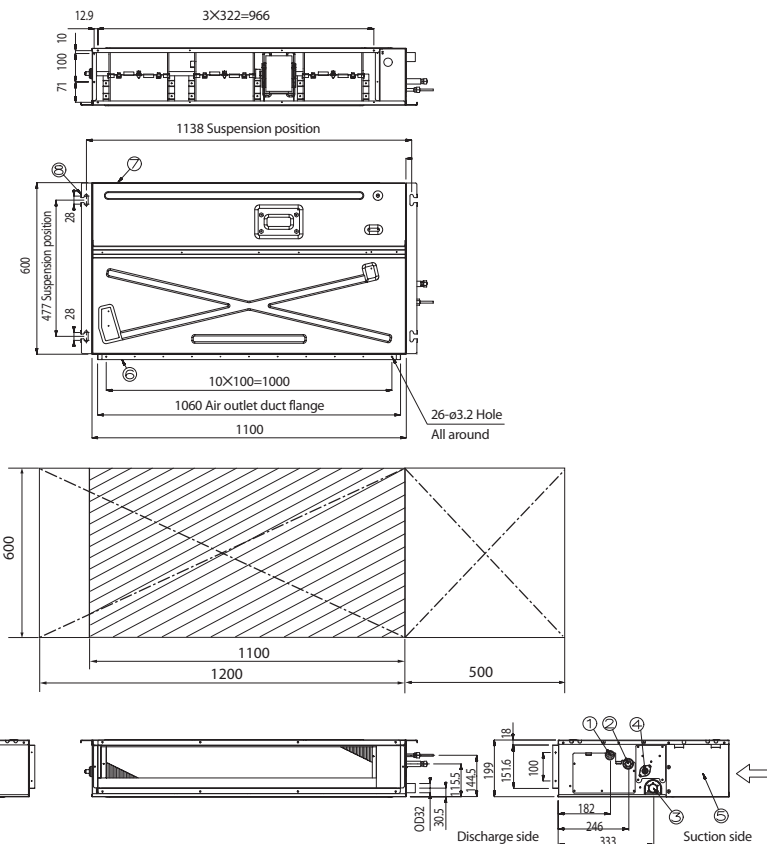

No.	Name	Description
1	Liquid pipe connection	$\phi$ 9.52
2	Gas pipe connection	$\phi$ 15.88
3	Drain pipe connection	OD $\phi$ 25, ID $\phi$ 20
4	Drain pipe connection (Option drain pump)	OD $\phi$ 25, ID $\phi$ 20
5	Power supply/Communication connection	--
6	Power supply connection	--
7	Air discharge grille flange	--
8	Hook	$\phi$ 9.52 or M10

# Selecting the installation location

AM090/112/128/140\*NLD\*\*\*

Unit : mm

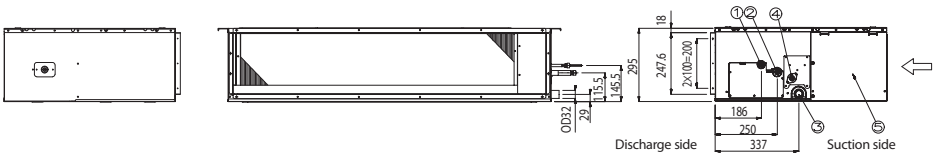
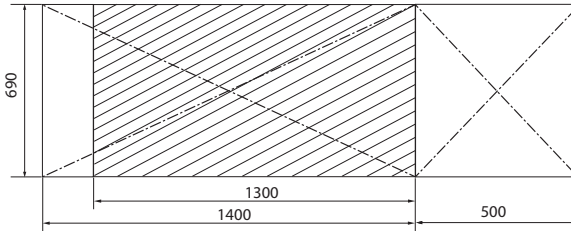
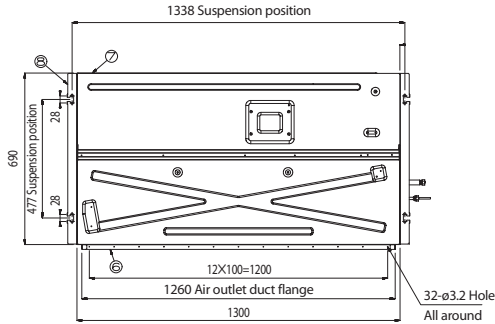
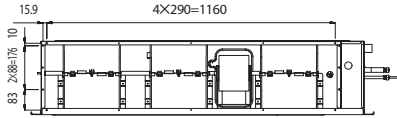

No.	Name	Description
1	Liquid pipe connection	ø9.52
2	Gas pipe connection	ø15.88
3	Drain pipe connection	OD ø25, ID ø20
4	Drain pipe connection (Option drain pump)	OD ø25, ID ø20
5	Power supply/Communication connection	--
6	Power supply connection	--
7	Air discharge grille flange	--
8	Hook	ø9.52 or M10



**AM045/056/071\*NMD\*\*\***

Unit : mm

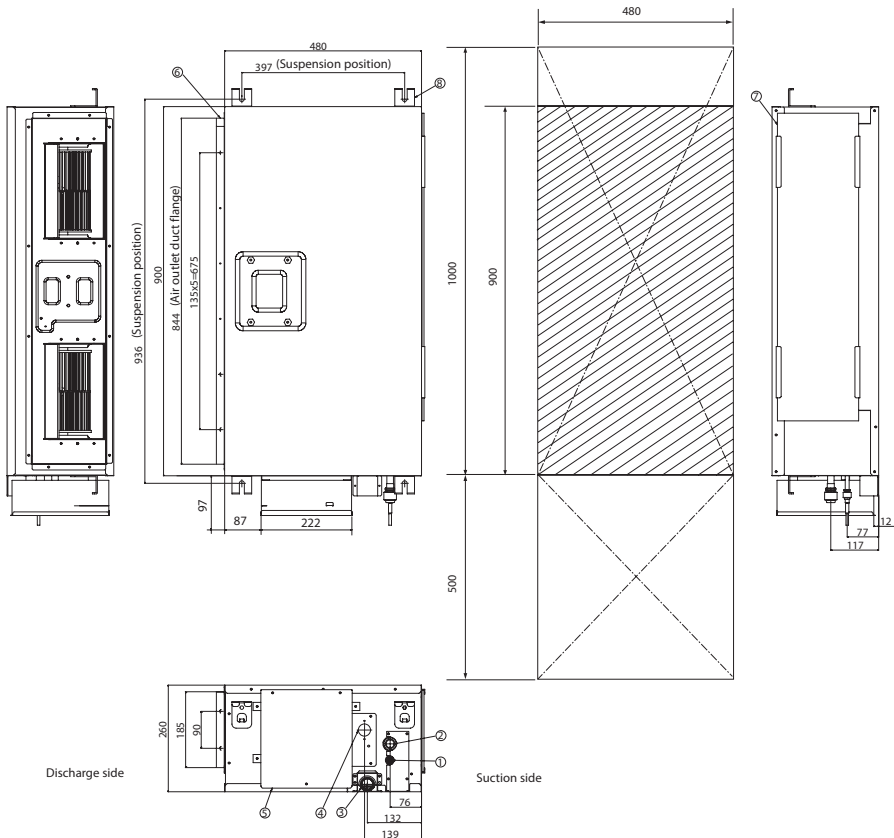

No.	Name	Description
1	Liquid pipe connection	*045/056**:*ø6.35,*071**:*ø9.52
2	Gas pipe connection	*045/056**:*ø12.7,*071**:*ø15.88
3	Drain pipe connection	OD ø25, ID ø20
4	Drain pipe connection (Option drain pump)	OD ø25, ID ø20
5	Power supply/Communication connection	--
6	Air discharge grille flange	--
7	Suction flange	--
8	Hook	ø9.52 or M10

# Selecting the installation location

AM090\*NMD\*\*\*

Unit : mm

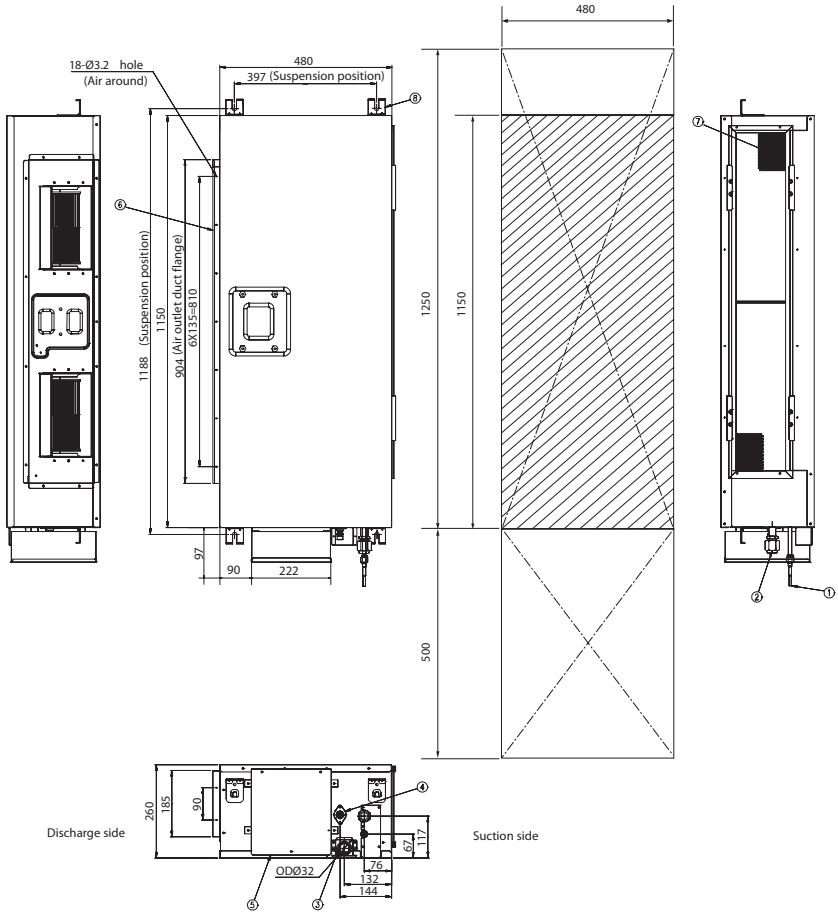

No.	Name	Description
1	Liquid pipe connection	ø9.52
2	Gas pipe connection	ø15.88
3	Drain pipe connection	OD ø25, ID ø20
4	Drain pipe connection (Option drain pump)	OD ø25, ID ø20
5	Power supply/Communication connection	--
6	Air discharge grille flange	--
7	Suction flange	--
8	Hook	ø9.52 or M10

AM112\*NMD\*\*\*

Unit : mm

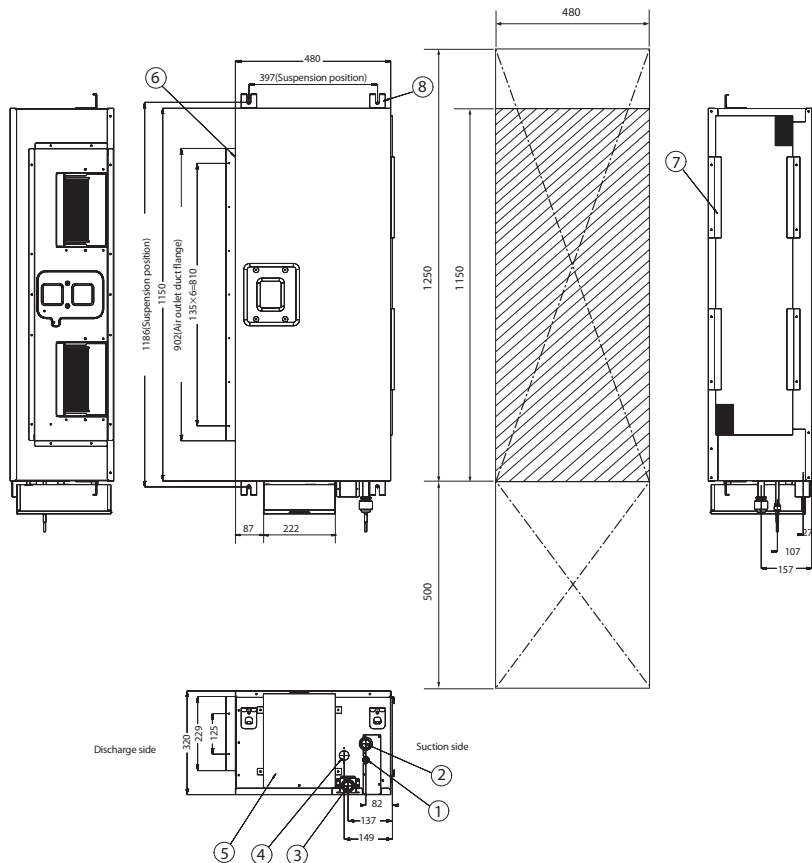

No.	Name	Description
1	Liquid pipe connection	ø9.52
2	Gas pipe connection	ø15.88
3	Drain pipe connection	OD ø25, ID ø20
4	Drain pipe connection (Option drain pump)	OD ø25, ID ø20
5	Power supply/Communication connection	
6	Air discharge grille flange	
7	Suction flange	
8	Hook	ø9.52 or M10

# Selecting the installation location

AM128/140/160\*NMD\*\*\*

AM112/128/140\*NHD\*\*\*

Unit : mm

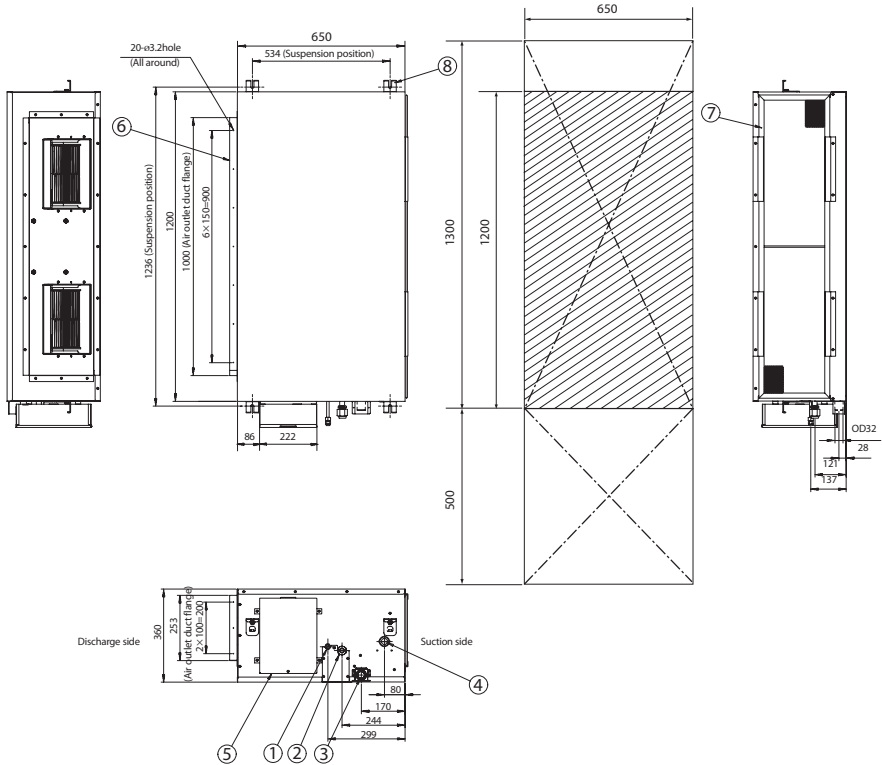

No.	Name	Description
1	Liquid pipe connection	ø9.52
2	Gas pipe connection	ø15.88
3	Drain pipe connection	OD ø25, ID ø20
4	Drain pipe connection (Option drain pump)	OD ø25, ID ø20
5	Power supply/Communication connection	
6	Air discharge grille flange	
7	Suction flange	
8	Hook	ø9.52 or M10

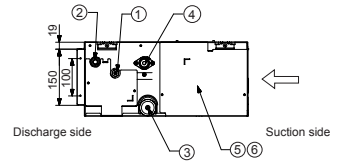
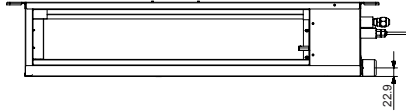
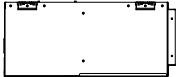
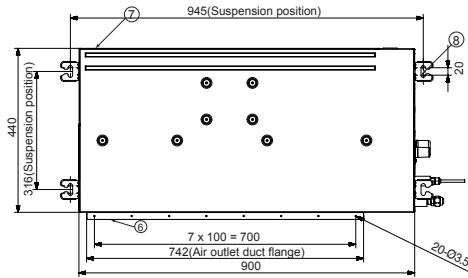
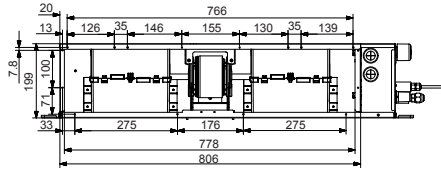

No.	Name	Description
1	Liquid pipe connection	ø6.35
2	Gas pipe connection	ø12.70
3	Drain pipe connection	OD ø25, ID ø20
4	Drain pipe connection (Option drain pump)	OD ø25, ID ø20
5	Power supply/Communication connection	
6	Air discharge grille flange	
7	Suction flange	
8	Hook	ø9.52 or M10

# Selecting the installation location

AM071MNL\*EH\*\*\*

Unit : mm

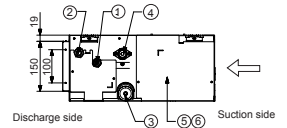
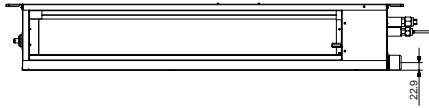
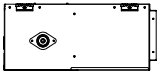
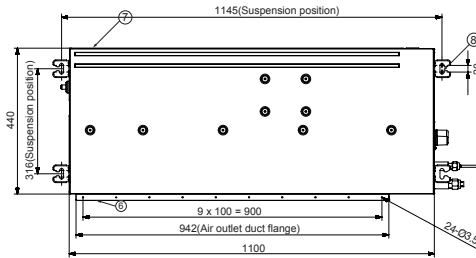
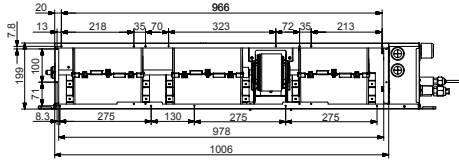

No.	Name	Description
1	Liquid pipe connection	ø9.52
2	Gas pipe connection	ø15.88
3	Drain pipe connection	OD ø25, ID ø20
4	Drain pipe connection (Option drain pump)	OD ø25, ID ø20
5	Power supply/Communication connection	
6	Air discharge grille flange	
7	Suction flange	
8	Hook	ø9.52 or M10

# Indoor unit installation

**It is recommended to install the Y-joint before installing the indoor unit.**

- Place the pattern sheet on the ceiling at the spot where you want to install the indoor unit.

**Note** ◆ Since the diagram is made of paper, it may shrink or stretch slightly due to temperature or humidity. For this reason, before drilling the holes maintain the correct dimensions between the markings.

- ◆ Pattern sheet is supplied depending on the model type.

- Insert bolt anchors, use existing ceiling supports or construct a suitable support as shown in figure.

- Install the suspension bolts depending on the ceiling type.



- ◆ Ensure that the ceiling is strong enough to support the weight of the indoor unit. Before hanging the unit, test the strength of each attached suspension bolt.
- ◆ If the length of suspension bolt is more than 1.5m, it is required to prevent vibration.
- ◆ If this is not possible, create an opening on the false ceiling in order to be able to use it to perform the required operations on the indoor unit.

- Screw eight nuts to the suspension bolts making space for hanging the indoor unit.



- ◆ You must install the suspension bolts more than four when installing the indoor unit.

- Hang the indoor unit to the suspension bolts between two nuts.

**Note** Piping must be laid and connected inside the ceiling when suspending the unit. If the ceiling is already constructed, lay the piping into position for connection to the unit before placing the unit inside the ceiling.

- Screw the nuts to suspend the unit.

- Adjust level of the unit by using measurement plate for all 4 sides.

**Note** For proper drainage of condensate, give a 'A' slant to the left or right side of the unit which will be connected with the drain hose, as shown in the figure. Make a tilt when you wish to install the drain pump, too.

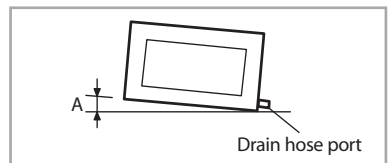
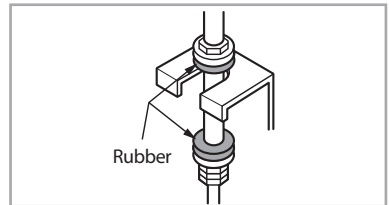
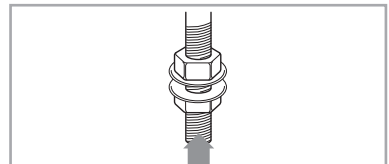
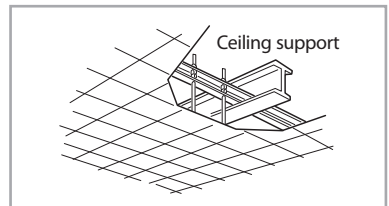
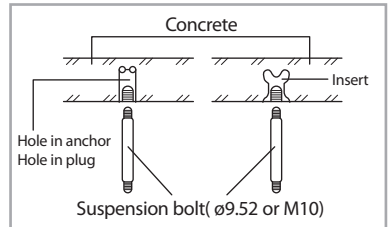
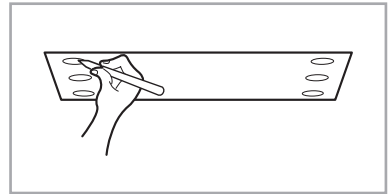

Unit	A
Slim Duct	3mm
Home Duct	
Ma Duct	10mm
HSP Duct	

# Indoor unit installation



◆ Noise will increase 3~6 dB(A) when the air flow enters from the bottom side (Only for Slim Duct/Home Duct Type product).

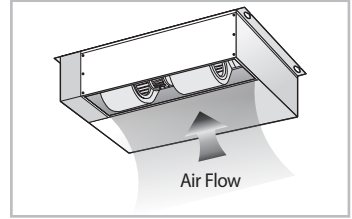

## Purging the unit

**On delivery, the indoor unit is loaded with inert gas. All this gas must therefore be purged before connecting the assembly piping. To purge the inert gas, proceed as follows.**

Unscrew the pinch pipe at the end of each refrigerant pipe.

**Result:** All inert gas escapes from the indoor unit.

**Note** To prevent dirt or foreign objects from getting into the pipes during installation, do NOT remove the pinch pipe completely until you are ready to connect the piping.

**AM\*\*\*\*\*NLD\*\* / AM022/028/036\*NMD\*\***

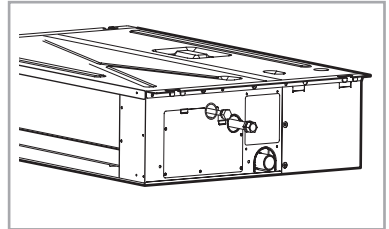

**AM\*\*\*\*\*NMD\*\* / AM\*\*\*\*\*NHD\*\***

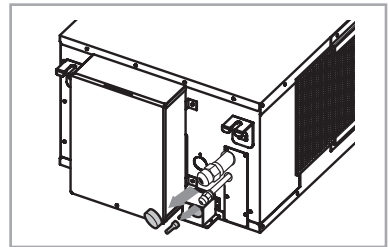

**AM\*\*\*MNL\*EH\*\*\***

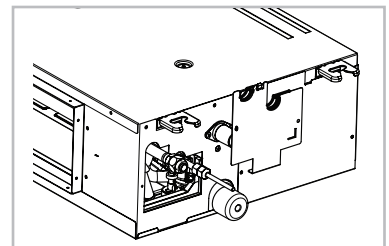

※ The designs and shape are subject to change according to the model.



# Connecting the refrigerant pipe

There are two refrigerant pipes of differing diameters:

- ◆ A smaller one for the liquid refrigerant
- ◆ A larger one for the gas refrigerant
- ◆ The inside of copper pipe must be clean & has no dust.

The connection procedure for the refrigerant pipes varies according to the exit position of the pipes from the indoor unit, as seen when facing the indoor in the "A" side.

- ◆ Liquid refrigerant port
- ◆ Gas refrigerant port
- ◆ Drain hose port

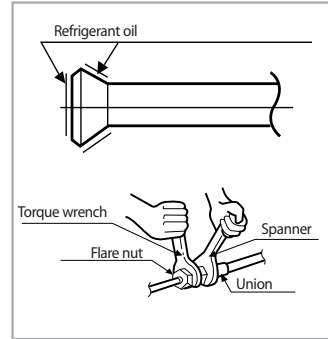

- 1 Remove the pinch pipe on the pipes and connect the assembly pipes to each pipe, tightening the nuts, first manually and then with a torque wrench, a spanner applying the following torque.

Outer Diameter	Torque	
	kgf·cm	N·m
6.35 mm	140~180	14~18
9.52 mm	350~430	34~42
12.70 mm	500~620	49~61
15.88 mm	690~830	68~82

**Note** Must apply refrigerant oil on the flaring area to prevent a leak.

- 2 Be sure that there must be no crack or kink on the bended area.

**AM\*\*\*\*NLD\*\*\* / AM022/028/036\*NMD\*\*\***

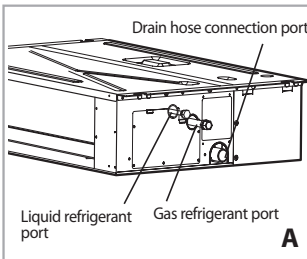

**AM\*\*\*\*NMD\*\*\* AM\*\*\*\*NHD\*\*\***

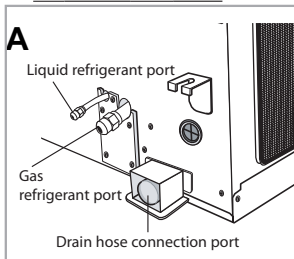

**AM\*\*\*MNL\*EH\*\*\***

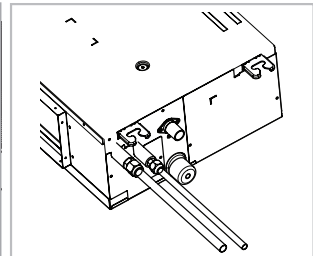
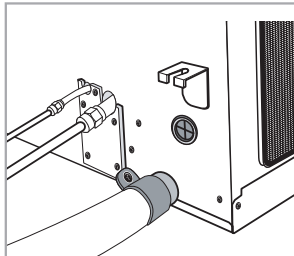
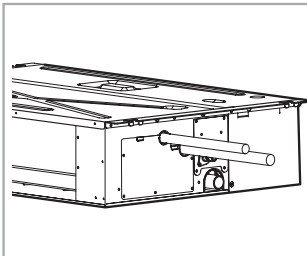
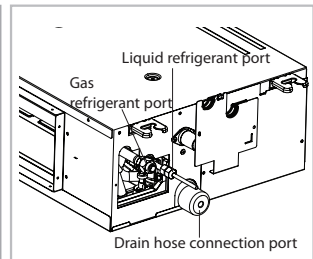

\* The designs and shape are subject to change according to the model.

# Cutting/flaring the pipes

1 Make sure that you prepared the required tools.  
(pipe cutter, reamer, flaring tool and pipe holder)

2 If you want to shorten the pipe, cut it using a pipe cutter ensuring that the cut edge remains at 90° with the side of the pipe. There are some examples of correctly and incorrectly cut edges below.

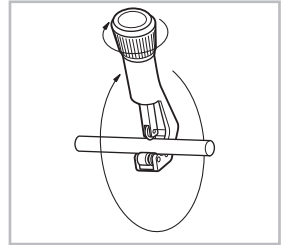
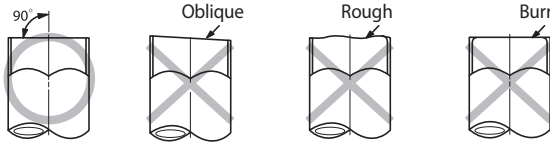

3 To prevent a gas leak, remove all burrs at the cut edge of the pipe using a reamer.

4 Carry out flaring work using flaring tool as shown below.

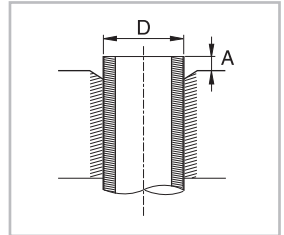
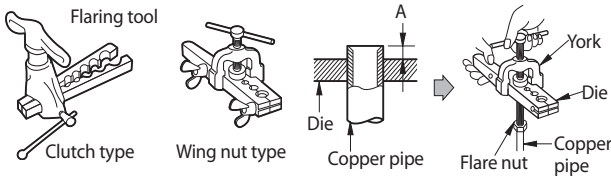

Outer diameter (mm)	A(mm)		
	Flare tool for R410A clutch type	Conventional flare tool	
		Clutch type	Wing nut type
6.35	0~0.5	1.0~1.5	1.5~2.0
9.52	0~0.5	1.0~1.5	1.5~2.0
12.70	0~0.5	1.0~1.5	1.5~2.0
15.88	0~0.5	1.0~1.5	1.5~2.0

5 Check if you flared the pipe correctly. There are some examples of incorrectly flared pipes below.



6 Align the pipes and tighten the flare nuts first manually and then with a torque wrench, applying the following torque.

Outer diameter (mm)	Connection Torque		Flare dimension (mm)	Flare shape (mm)
	kgf·cm	N·m		
6.35	140~180	14~18	8.70~9.10	
9.52	350~430	34~42	12.80~13.20	
12.70	500~620	49~61	16.20~16.60	
15.88	690~830	68~82	19.30~19.70	

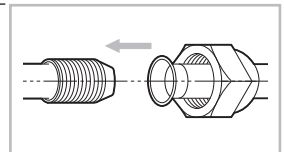

**In case of needing brazing, you must work with Nitrogen gas blowing.**

# Performing leak test & insulation

## Leak test

### LEAK TEST WITH NITROGEN (before opening valves)

In order to detect basic refrigerant leaks, before recreating the vacuum and recirculating the R410A, it's responsible of installer to pressurize the whole system with nitrogen (using a pressure regulator) at a pressure above 4.1MPa (gauge).

### LEAK TEST WITH R410A (after opening valves)

Before opening valves, discharge all the nitrogen into the system and create vacuum. After opening valves check leaks using a leak detector for refrigerant R410A.



**Discharge all the nitrogen to create a vacuum and charge the system.**

AM\*\*\*\*NLD\*\*\* / AM022/028/036\*NMD\*\*\*

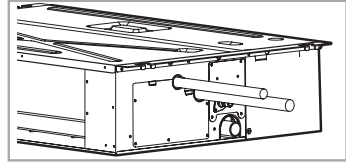

AM\*\*\*\*NMD\*\*\* / AM\*\*\*\*NHD\*\*\*

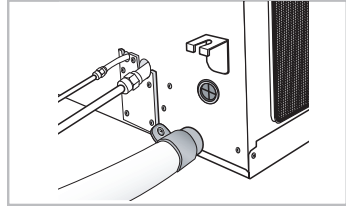

AM\*\*\*MNL\*EH\*\*

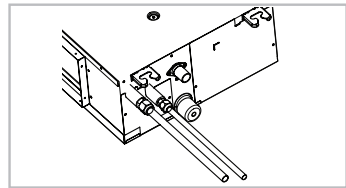

## Insulation

Once you have checked that there are no leaks in the system, you can insulate the piping and hose.

- 1 To avoid condensation problems, place **T13.0 or thicker Acrylonitrile Butadien Rubber** separately around each refrigerant pipe.

*Note* Always make the seam of pipes face upwards.

- 2 Wind insulating tape around the pipes and drain hose avoiding to compress the insulation too much.
- 3 Finish wrapping insulating tape around the rest of the pipes leading to the outdoor unit.
- 4 The pipes and electrical cables connecting the indoor unit with the outdoor unit must be fixed to the wall with suitable ducts.

\* The designs and shape are subject to change according to the model.

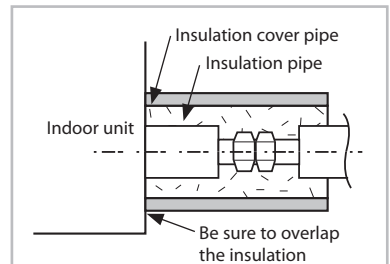
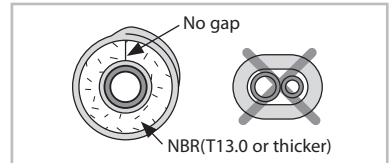

**Must fit tightly against body without any gap.**



**All refrigerant connection must be accessible, in order to permit either unit maintenance or removing it completely.**

# Performing leak test & insulation

- 5 Select the insulator of the refrigerant pipe.
  - ◆ Insulate the gas side and liquid side pipe referring to the thickness according to the pipe size.
  - ◆ Indoor temperature of 30°C and humidity of 85% is the standard condition.  
If install in a high humidity condition, use one grade thicker insulator by referring to the table below.
  - ◆ If installing in an unfavorable conditions, use thicker one.
  - ◆ Insulator's heat-resistance temperature should be more than 120°C.

Pipe	Pipe size	Insulation Type(Heating/Cooling)		Remarks
		Standard [30°C,85%]	High humidity [30°C,over85%]	
		EPDM,NBR		
Liqued pipe	Φ6.35~Φ9.52	9t	9t	Internal temperature is higher than 120°C
	Φ12.7~Φ50.80	13t	13t	
Gas Pipe	Φ6.35	13t	19t	
	Φ9.52~Φ25.40	19t	25t	
	Φ28.58~Φ44.45		32t	
	Φ50.80	25t	38t	

- ◆ When installing insulation in places and conditions below, use the same insulation that is used for high humidity conditions.
  - <Geological condition>
    - High humidity places such as shoreline, hot spring, near lake or river, and ridge (when the part of the building is covered by earth and sand.)
  - <Operation purpose condition>
    - Restaurant ceiling, sauna, swimming pool etc.
  - <Building construction condition>
    - The ceiling frequently exposed to moisture and cooling is not covered.  
e.g. The pipe installed at a corridor of a dormitory and studio or near an exit that opens and closes frequently.
    - The place where the pipe is installed is highly humid due to the lack of ventilation system.

## Refrigerant pipe before EEV kit and MCU or without EEV kit and MCU

- ◆ You can contact the gas side and liquid side pipes but the pipes should not be pressed.
- ◆ When contacting the gas side and liquid side pipe, use 1 grade thicker insulator.

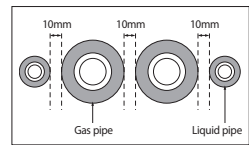
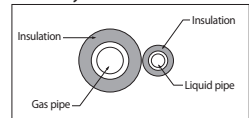

## Refrigerant pipe after EEV kit and MCU

- ◆ Install the gas side and liquid side pipes, leave 10mm of space.
- ◆ When contacting the gas side and liquid side pipe, use 1 grade thicker insulator.



- ◆ **Install the insulation not to get wider and use the adhesives on the connection part of it to prevent moisture from entering.**
- ◆ **Wind the refrigerant pipe with insulation tape if it is exposed to outside sunlight.**
- ◆ **Install the refrigerant pipe respecting that the insulation does not get thinner on the bent part or hanger of pipe.**
- ◆ **Add the additional insulation if the insulation plate gets thinner.**

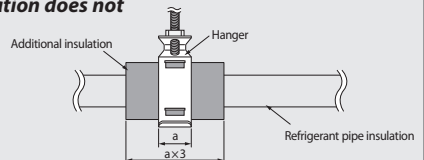

# Drain pipe and drain hose installation

Care must be taken when installing the drain hose for the indoor unit to ensure that any condensate water is correctly drained outside. The drain hose can be installed to the right or left side of the base pan.

## 1 Install the drain hose as short as possible.

- note* ◆ In order to discharge condensation water, the drain hose should keep tilted.
- ◆ Secure the drain hose with the cable-tie not to be separated from the unit.
  - ◆ The drain pump connection port is used when using a drain pump.
  - ◆ Both ends of the drain hose must be fixed by PVC adhesive, to prevent leakage.

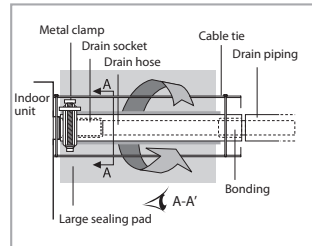

## 2 When there is no draining pump, insulate the drain hose and then fix it as a picture.

- note* ◆ Insert the drain hose to bottom of the outfall of water basin.
- ◆ Lock steel ring of the drain hose according to the figure.
  - ◆ Wind and wrap steel ring and drain hose fully with thermal insulation sponge; fix both ends of external layer with ribbon for thermal insulation.
  - ◆ After being installed, drain hose must be insulated fully by heat insulating material.(To be provided at site.)

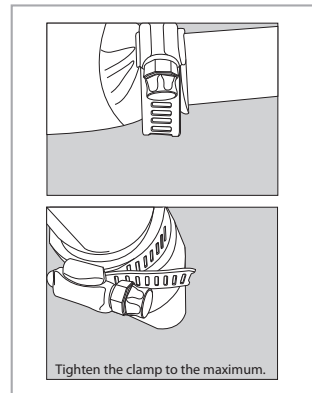

## 3 While using draining pump, insulate the drain hose with heat insulating material according to the figure.

- note* ◆ Check if the rubber ring is installed properly on the draining pump.
- ◆ Check if the drain cap blocks the outfall of drain pan properly.

# Drain pipe and drain hose installation

## Drainpipe Connection

### Without the drain pump

- 1 Install horizontal drainpipe with a slope of 1/100 or more and fix it by hanger space of 1.0~1.5m.
- 2 Install U-trap at the end of the drainpipe to prevent a nasty smell to reach the indoor unit.
- 3 Do not install the drainpipe to upward position. It may cause water flow back to the unit.

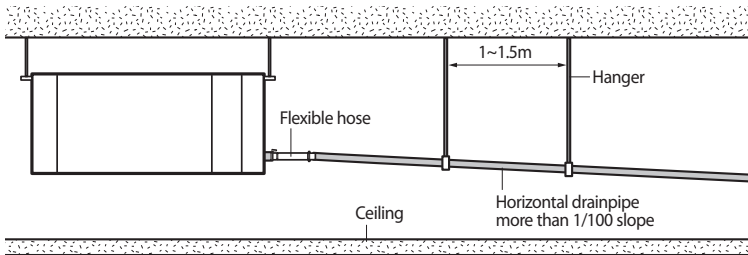

### With the drain pump

- 1 The drain pipe should be installed within 300mm to 550mm from the flexible hose and then lift down 20mm or more.
- 2 Install horizontal drainpipe with a slope of 1/100 or more and fix it by hanger space of 1.0~1.5m.
- 3 Install the air vent in the horizontal drainpipe to prevent water flow back to the indoor unit.

*Note* You may not need to install it if there were proper slope in the horizontal drainpipe.

- 4 The flexible hose should not be installed upward position, it may cause water flow back to the indoor unit.

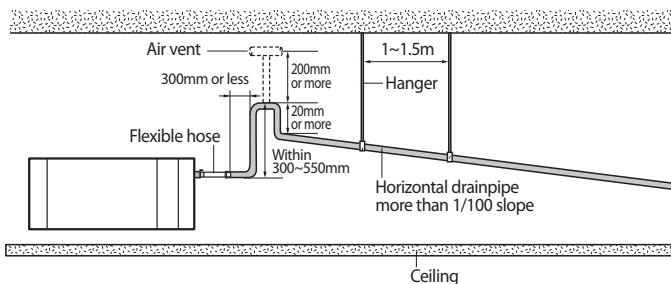

## Centralized Drainage

### ***Without the drain pump***

- 1 Install horizontal drainpipe with a slope of 1/100 or more and fix it by hanger space of 1.0~1.5m.
- 2 Install U-trap at the end of the drainpipe to prevent a nasty smell to reach the indoor unit.

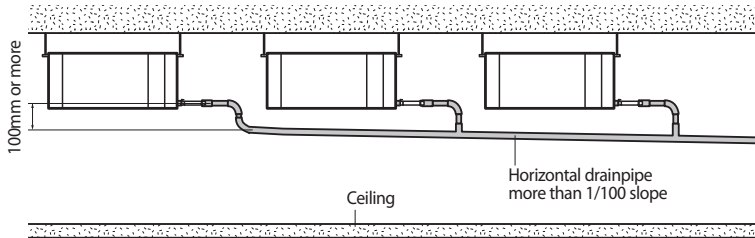

### ***With the drain pump***

- 1 Install main air vent at the front of the farthest indoor unit from the main drain when installed indoor units are more than 3.
- 2 You may need to install individual air vent to prevent water flow back at the top of each indoor unit drainpipe.

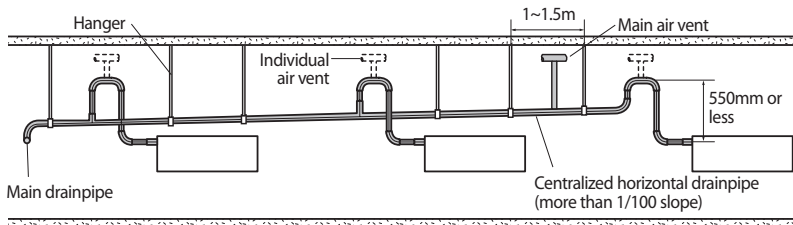

# Drain pipe and drain hose installation

## Testing the drainage

Prepare a little water about 2 liters.

1 Loosen screws and take out the side cover plate.

2 Pour water into the the indoor unit as shown in figure.

*Note* Drainage test should be done after installation has been finished. To avoid water overflow from the indoor unit because the drain tube is blocked.

3 Confirm that the water flows out through the drain hose.

4 When the drain pump is installed, operate the unit as cooling mode and check a drain pump pumping.

5 Check drain water drops at the end of the drain pipe.

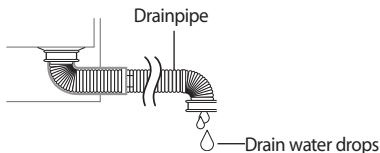

6 Make sure there is no water leak at the drainage.

7 Reinstall the side cover plate.

**AM\*\*\*\*NLD\*\*\* / AM022/028/036\*NMD\*\*\***

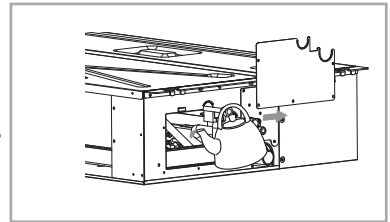
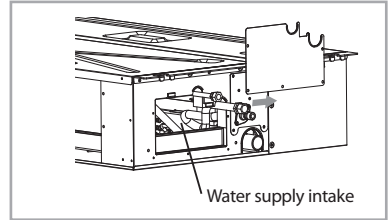

**AM\*\*\*\*NMD\*\*\* / AM\*\*\*\*NHD\*\*\***

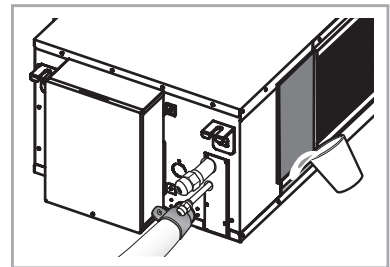

**AM\*\*\*\*MNL\*EH\*\*\***

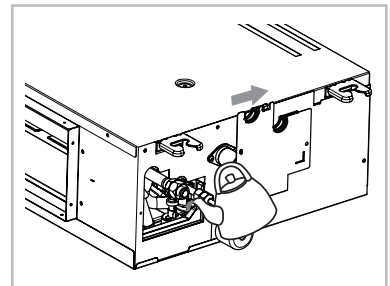



# Wiring work

## Power and communication cable connection

- 1 Before wiring work, you must turn off all power source.
- 2 Indoor unit power should be supplied through the breaker( ELCB or MCCB+ELB ) separated by the outdoor power.  
ELCB:Earth Leakage Circuit Breaker  
MCCB:Molded Case Circuit Breaker  
ELB:Earth Leakage Breaker
- 3 The power cable should be used only copper wires.
- 4 Connect the power cable(1(L), 2(N)) among the units within maximum length and communication cable(F1, F2) each.
- 5 Connect F3, F4(for communication) when installing the wired remote control.

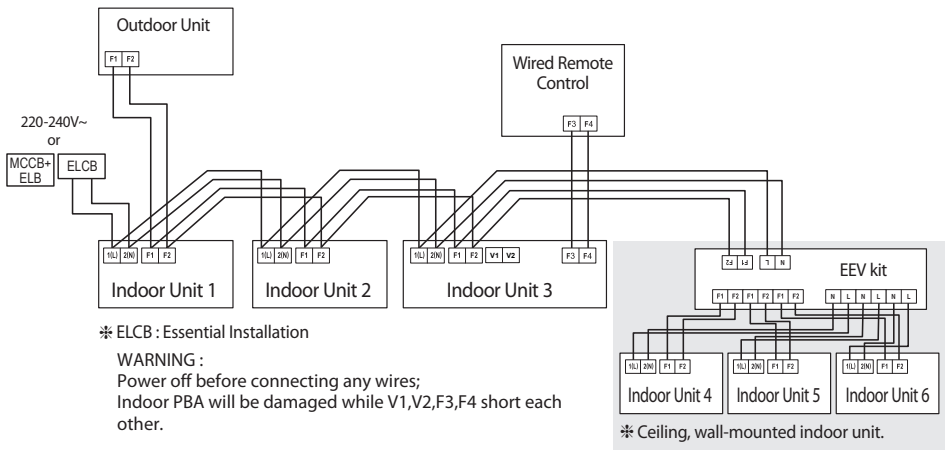

## Selecting compressed ring terminal

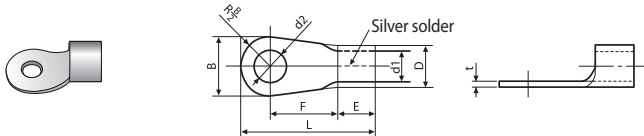

Nominal dimensions for cable (mm <sup>2</sup> )	Nominal dimensions for screw (mm)	B		D		d1		E	F	L	d2		t
		Standard dimension (mm)	Allowance (mm)	Standard dimension (mm)	Allowance (mm)	Standard dimension (mm)	Allowance (mm)				Standard dimension (mm)	Allowance (mm)	
1.5	4	6.6	±0.2	3.4	+0.3 -0.2	1.7	±0.2	4.1	6	16	4.3	+0.2 0	0.7
	4	8											
2.5	4	6.6	±0.2	4.2	+0.3 -0.2	2.3	±0.2	6	6	17.5	4.3	+0.2 0	0.8
	4	8.5											
4	4	9.5	±0.2	5.6	+0.3 -0.2	3.4	±0.2	6	5	20	4.3	+0.2 0	0.9

# Wiring work

## Specification of electronic wire

Power supply	MCCB	ELB or ELCB	Power cable	Earth cable	Communication cable
Max : 242V Min : 198V	X A	X A, 30mmA 0.1 s	2.5mm <sup>2</sup>	2.5mm <sup>2</sup>	0.75~1.5mm <sup>2</sup>

- ◆ Decide the capacity of ELCB(or MCCB+ELB) by below formula.
- ◆ Power supply cords of parts of appliances for outdoor use shall not be lighter than polychloroprene sheathed flexible cord. (Code designation IEC:60245 IEC 57 / CENELEC: H05RN-F or IEC:60245 IEC 66 / CENELEC: H07RN-F)

The capacity of ELCB(or MCCB+ELB)  $X [A] = 1.25 \times 1.1 \times \sum A_i$

- \* X: The capacity of ELCB(or MCCB+ELB).
- \*  $\sum A_i$ : Sum of Rating currents of each indoor unit.
- \* Refer to each installation manual about the rating current of indoor unit.
- ◆ Decide the power cable specification and maximum length within 10% power drop among indoor units.

$$\sum_{k=1}^n \left( \frac{\text{Coef} \times 35.6 \times L_k \times i_k}{1000 \times A_k} \right) < 10\% \text{ of input voltage [V]}$$

\* coef: 1.55  
 \*  $L_k$ : Distance among each indoor unit[m],  $A_k$ : Power cable specification[mm<sup>2</sup>]  
 $i_k$ : Running current of each unit[A]

### Example of Installation

- Total power cable length L = 100(m), Running current of each units 1[A]
- Total 10 indoor units were installed

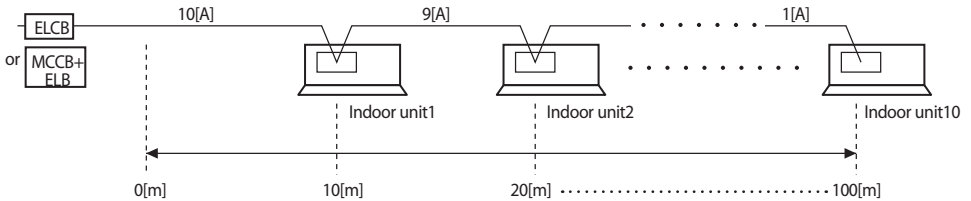

- ◆ Apply following equation.

$$\sum_{k=1}^n \left( \frac{\text{Coef} \times 35.6 \times L_k \times i_k}{1000 \times A_k} \right) < 10\% \text{ of input voltage [V]}$$

### \* Calculation

- Installing with 1 sort wire.

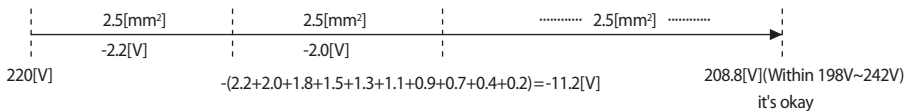

- Installing with 2 different sort wire.

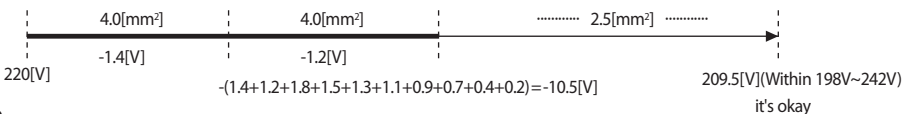

✧ Rating current

Unit	Model	Rating current	Unit	Model	Rating current	Unit	Model	Rating current
AM**FNLD*	*017* *022* *028* *036*	0.30A 0.30A 0.32A 0.33A	AM**NMD*	*022* *028* *036* *045* *056* *071* *090* *112* *128* *140*	0.40A 0.40A 0.55A 1.15A 1.10A 1.25A 1.30A 1.17A 1.67A 1.86A 2.24A	AM**NHD*	*112* *128* *140*	2.35A 2.58A 3.00A
AM**NLD*	*045* *056* *071* *090* *112* *128* *140*	0.52A 0.53A 0.60A 0.96A 0.96A 1.28A 1.43A				AM**MNLD*	*045* *056* *071*	0.45A 0.62A 0.69A
AM**KNLD*	*017* *022* *028* *036*	0.23A 0.25A 0.30A 0.35A						



- CAUTION**
- ◆ **Select the power cable in accordance with relevant local and national regulations.**
  - ◆ **Wire size must comply with local and national code.**
  - ◆ **For the power cable, use the grade of H07RN-F or H05RN-F materials.**
  - ◆ **You should connect the power cable into the power cable terminal and fasten it with a clamp.**
  - ◆ **The unbalanced power must be maintained within 10% of supply rating among whole indoor units.**
  - ◆ **If the power is unbalanced greatly, it may shorten the life of the condenser. If the unbalanced power is exceeded over 10% of supply rating, the indoor unit is protected, stopped and the error mode indicates.**
  - ◆ **To protect the product from water and possible shock, you should keep the power cable and the connection cord of the indoor and outdoor units in the iron pipe.**
  - ◆ **Connect the power cable to the auxiliary circuit breaker.**  
An all pole disconnection from the power supply must be incorporated in the fixed wiring( $\geq 3\text{mm}$ ).
  - ◆ **You must keep the cable in a protection tube.**
  - ◆ **Keep distances of 50mm or more between power cable and communication cable.**
  - ◆ **Maximum length of power cables are decided within 10% of power drop. If it exceeds, you must consider another power supplying method.**
  - ◆ **The circuit breaker(ELCB or MCCB+ELB) should be considered more capacity if many indoor units are connected from one breaker.**
  - ◆ **Use round pressure terminal for connections to the power terminal block.**
  - ◆ **For wiring, use the designated power cable and connect it firmly, then secure to prevent outside pressure being exerted on the terminal board.**
  - ◆ **Use an appropriate screwdriver for tightening the terminal screws. A screwdriver with a small head will strip the head and make proper tightening impossible.**
  - ◆ **Over-tightening the terminal screws may break them.**
  - ◆ **See the table below for tightening torque for the terminal screws.**

Tightening torque		
	N-m	kgf-cm
M3.5	0.8~1.0	8.0~10.0
M4	1.2~1.5	12.0~14.7

# Setting an indoor unit address and installation option

Set the indoor unit address and installation option with remote controller option.

Set the each option separately since you cannot set the ADDRESS setting and indoor unit installation setting option at the same time. You need to set twice when setting indoor unit address and installation option.

## The procedure of option setting

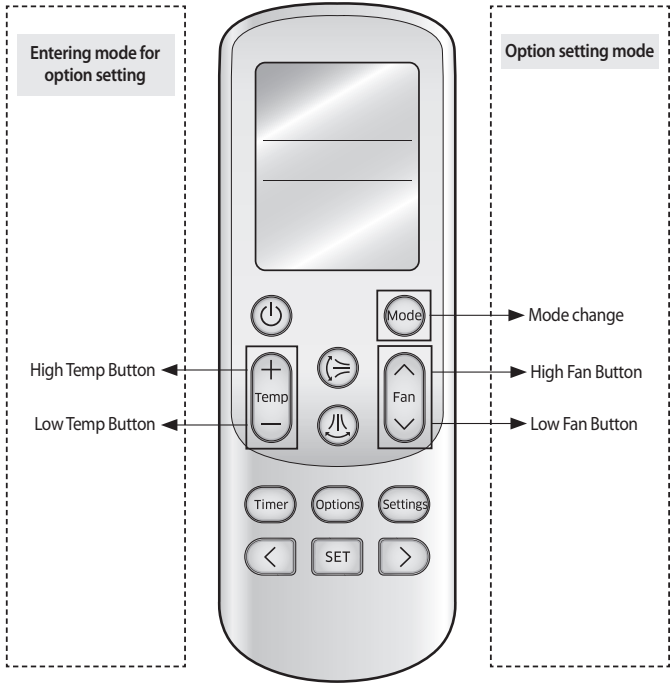

### Step 1. Entering mode to set option

1. Remove batteries from the remote controller.
2. Insert batteries and enter the option setting mode while pressing High Temp button and Low Temp button.

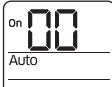
3.  Check if you have entered the option setting status.



### Step 2. The procedure of option setting











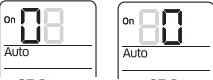

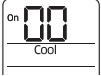

After entering the option setting status, select the option as listed below.



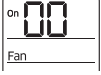

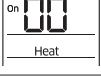

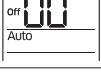
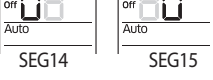

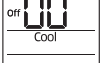
- Option setting is available from SEG1 to SEG 24
- SEG1, SEG7, SEG13, SEG19 are not set as page option.
- Set the SEG2~SEG6, SEG8~SEG12 as ON status and SEG14~18, SEG20~24 as OFF status.

SEG1	SEG2	SEG3	SEG4	SEG5	SEG6	SEG7	SEG8	SEG9	SEG10	SEG11	SEG12
0	X	X	X	X	X	1	X	X	X	X	X
SEG13	SEG14	SEG15	SEG16	SEG17	SEG18	SEG19	SEG20	SEG21	SEG22	SEG23	SEG24
2	X	X	X	X	X	3	X	X	X	X	X

On(SEG1~12)	Off(SEG13~24)
On 00 Auto	off 00 Auto

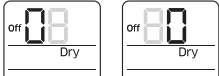
Option setting	Status
<p>1. Setting SEG2, SEG3 option            Press Low Fan button(V) to enter SEG2 value.            Press High Fan button(^) to enter SEG3 value.            Each time you press the button, 0 → 8 → ... E → F will be selected in rotation.</p>	
<p>2. Setting Cool mode   Press Mode button to be changed to Cool mode in the ON status.</p>	
<p>3. Setting SEG4, SEG5 option            Press Low Fan button(V) to enter SEG4 value.            Press High Fan button(^) to enter SEG5 value.            Each time you press the button, 0 → 8 → ... E → F will be selected in rotation.</p>	
<p>4. Setting Dry mode   Press Mode button to be changed to DRY mode in the ON status.</p>	
<p>5. Setting SEG6, SEG8 option            Press Low Fan button(V) to enter SEG6 value.            Press High Fan button(^) to enter SEG8 value.            Each time you press the button, 0 → 8 → ... E → F will be selected in rotation.</p>	
<p>6. Setting Fan mode   Press Mode button to be changed to FAN mode in the ON status.</p>	
<p>7. Setting SEG9, SEG10 option            Press Low Fan button(V) to enter SEG9 value.            Press High Fan button(^) to enter SEG10 value.            Each time you press the button, 0 → 8 → ... E → F will be selected in rotation.</p>	
<p>8. Setting Heat mode   Press Mode button to be changed to HEAT mode in the ON status.</p>	
<p>9. Setting SEG11, SEG12 option            Press Low Fan button(V) to enter SEG11 value.            Press High Fan button(^) to enter SEG12 value.            Each time you press the button, 0 → 8 → ... E → F will be selected in rotation.</p>	
<p>10. Setting Auto mode   Press Mode button to be changed to AUTO mode in the OFF status.</p>	
<p>11. Setting SEG14, SEG15 option            Press Low Fan button(V) to enter SEG14 value.            Press High Fan button(^) to enter SEG15 value.            Each time you press the button, 0 → 8 → ... E → F will be selected in rotation.</p>	
<p>12. Setting Cool mode   Press Mode button to be change to Cool mode in the OFF status.</p>	

# Setting an indoor unit address and installation option

Option setting	Status
<p>13. Setting SEG16, SEG17 option                      Press Low Fan button(V) to enter SEG16 value.                      Press High Fan button(^) to enter SEG17 value.                      Each time you press the button, 0 → 1 → ... E → F will be selected in rotation.</p>	 <p style="text-align: center;">SEG16                  SEG17</p>
<p>14. Setting Dry mode                      (Mode) Press Mode button to be change to Dry mode in the OFF status.</p>	
<p>15. Setting SEG18, SEG20 option                      Press Low Fan button(V) to enter SEG18 value.                      Press High Fan button(^) to enter SEG20 value.                      Each time you press the button, 0 → 1 → ... E → F will be selected in rotation.</p>	 <p style="text-align: center;">SEG18                  SEG20</p>
<p>16. Setting Fan mode                      (Mode) Press Mode button to be change to Fan mode in the OFF status.</p>	
<p>17. Setting SEG21, SEG22 option                      Press Low Fan button(V) to enter SEG21 value.                      Press High Fan button(^) to enter SEG22 value.                      Each time you press the button, 0 → 1 → ... E → F will be selected in rotation.</p>	 <p style="text-align: center;">SEG21                  SEG22</p>
<p>18. Setting Heat mode                      (Mode) Press Mode button to be change to HEAT mode in the OFF status.</p>	
<p>19. Setting SEG23, SEG24 mode                      Press Low Fan button(V) to enter SEG23 value.                      Press High Fan button(^) to enter SEG24 value.                      Each time you press the button, 0 → 1 → ... E → F will be selected in rotation.</p>	 <p style="text-align: center;">SEG23                  SEG24</p>

### Step 3. Check the option you have set

After setting option, press (Mode) button to check whether the option code you input is correct or not.

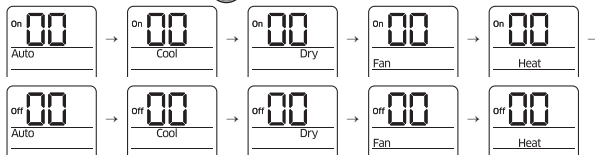

### Step 4. Input option

Press operation button (⏻) with the direction of remote control for set.  
 For the correct option setting, you must input the option twice.

### Step 5. Check operation

1. Reset the indoor unit by pressing the RESET button of indoor unit or outdoor unit.
2. Take the batteries out of the remote controller and insert them again and then press the operation button.

## Setting an indoor unit address (MAIN/RMC)

- Check whether power is supplied or not.
  - When the indoor unit is not plugged in, there should be additional power supply in the indoor unit.
- The panel(display) should be connected to an indoor unit to receive option.
- Before installing the indoor unit, assign an address to the indoor unit according to the air conditioning system plan.
- Assign an indoor unit address by wireless remote controller.
  - The initial setting status of indoor unit ADDRESS(MAIN/RMC) is "0A0000-100000-200000-300000".

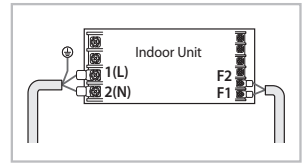

### Option No. : 0AXXXX-1XXXXX-2XXXXX-3XXXXX

Option	SEG1		SEG2		SEG3		SEG4		SEG5		SEG6	
Explanation	PAGE		Mode		Setting Main address		100-digit of indoor unit address		10-digit of indoor unit		The unit digit of an indoor unit	
Remote Controller Display			On <b>AA</b> Auto		On <b>88</b> Auto		On <b>88</b> Cool		On <b>88</b> Cool		On <b>88</b> Dry	
Indication and Details	Indication	Details	Indication	Details	Indication	Details	Indication	Details	Indication	Details	Indication	Details
	0		A		0	No Main address	0~9	100-digit	0~9	10-digit	0~9	A unit digit
				1	Main address setting mode							
Option	SEG7		SEG8		SEG9		SEG10		SEG11		SEG12	
Explanation	PAGE				Setting RMC address				Group channel(*16)		Group address	
Remote Controller Display					On <b>88</b> Fan				On <b>88</b> Heat		On <b>88</b> Heat	
Indication and Details	Indication	Details	—		Indication	Details	—		Indication	Details	Indication	Details
	1				0	No RMC address			RMC1	0~F	RMC2	0~F
				1	RMC address setting mode							



- When "A"~"F" is entered to SEG5~6, the indoor unit MAIN ADDRESS is not changed.
- If you set the SEG 3 as 0, the indoor unit will maintain the previous MAIN ADDRESS even if you input the option value of SEG5~6.
- If you set the SEG 9 as 0, the indoor unit will maintain previous RMC ADDRESS even if you input the option value of SEG11~12.
- You cannot set SEG11 and SEG12 as F value at the same time.

# Setting an indoor unit address and installation option

## Setting an indoor unit installation option (suitable for the condition of each installation location)

- Check whether power is supplied or not.
  - When the indoor unit is not plugged in, there should be additional power supply in the indoor unit.
- The panel(display) should be connected to an indoor unit to receive option.
- Set the installation option according to the installation condition of an air conditioner.
  - The default setting of an indoor unit installation option is "020010-100000- 200000-300000".
  - Individual control of a remote controller(SEG20) is the function that controls an indoor unit individually when there is more than one indoor unit.
- Set the indoor unit option by wireless remote controller.

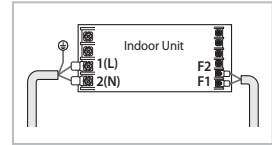

## 02 series installation option

SEG1	SEG2	SEG3	SEG4	SEG5	SEG6
0	2	--	External room temperature sensor / Minimizing fan operation when thermostat is off	Central control	FAN RPM compensation
SEG7	SEG8	SEG9	SEG10	SEG11	SEG12
1	Drain pump	Hot water heater	--	EEV Step when heating stops	--
SEG13	SEG14	SEG15	SEG16	SEG17	SEG18
2	External control	External control output / External heater On or Off signal	S-Plasma ion	Buzzer	Number of hours using filter
SEG19	SEG20	SEG21	SEG22	SEG23	SEG24
3	Individual control of a remote controller	Heating setting compensation / Removing condensated water in heating mode	EEV Step of stopped unit during oil return/ defrost mode	Motion detect sensor	--

- ◆ 1WAY/2WAY/4WAY MODEL : Drain pump(SEG8) will be set to 'USE + 3minute delay' even if the drain pump is set to 0.
- ◆ 1 WAY/2WAY/4WAY,DUCT MODEL : Number of hours using filter(SEG18) will be set to '1000hour' even if the SEG18 is set to except for 2 or 6.
- ◆ When setting the option other than above SEG values, the option will be set as "0".
- ◆ SEG5 central control option is basically set as 1 (Use), so you don't need to set the central control option additionally.  
However, if the central control is not connected but it doesn't indicate an error message, you need to set the central control option as 0 (Disuse) to exclude the indoor unit from the central control.



- ◆ The output of hot water heater in SEG9 is generated from the hot coil part of the terminal board in duct models.

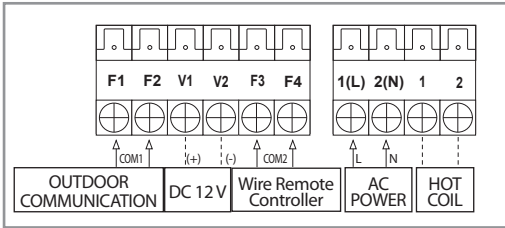

\* The output of hot coil terminal is AC 220V / 230V  
(The same as Indoor Unit's input Power)

- ◆ The external output of SEG15 is generated by MIM-B14 connection. (Refer to the manual of MIM-B14.)

## ■ 02 series installation option(Detailed)

Option No. : 02XXXX-1XXXXX-2XXXXX-3XXXXX

Option	SEG1		SEG2		SEG3		SEG4			SEG5		SEG6		
Explanation	PAGE		MODE		Use of robot cleaning		Use of external room temperature sensor / Minimizing fan operation when thermostat is off			Use of central control		FAN RPM compensation		
Remote Controller Display														
Indication and Details	Indication	Details	Indication	Details	Indication	Details	Indication	Details			Indication	Details	Indication	Details
								Use of External room temperature sensor	Minimizing fan operation when thermostat is off					
	0	2	0	Disuse	0	Disuse		Disuse	0	Disuse	0	Disuse	1	RPM compensation
					1	Use		2						
Option	SEG7		SEG8		SEG9		SEG10			SEG11		SEG12		
Explanation	PAGE		Use of drain pump		Use of hot water heater					EEV Step when heating stops				
Remote Controller Display														
Indication and Details	Indication	Details	Indication	Details	Indication	Details	Indication	Details			Indication	Details	Indication	Details
								Use of External room temperature sensor	Minimizing fan operation when thermostat is off					
	1		0	Disuse	0	Disuse		0	Default value	1	Noise decreasing setting			
			1	Use (*)	2	--								
		2	When an indoor unit stops, drain pump will operate for 3min	2	--									
		3		3	Use (*)									

# Setting an indoor unit address and installation option

Option	SEG13		SEG14		SEG15			SEG16		SEG17		SEG18	
Explanation	PAGE		Use of external control		Setting the output of external control / External heater On/Off signal			S-Plasma ion		Buzzer control		Hours of filter usage	
Remote Controller Display													
Indication and Details	Indication	Details	Indication	Details	Indication	Details		Indication	Details	Indication	Details	Indication	Details
						Setting the output of external control	External heater On/Off signal						
	2	0	Disuse	0	Thermo on	-	0	Disuse	0	Use buzzer	2	1000 Hour	
		1	ON/OFF control	1	Operation on	-	1	Use	1	Disuse buzzer	6	2000 Hour	
		2	OFF control	2	-	Use <sup>(*)3</sup>							
3	Window ON/OFF control	3	-	Use <sup>(*)3</sup>									
Option	SEG19		SEG20		SEG21			SEG22		SEG23		SEG24	
Explanation	PAGE		Individual control of a remote controller		Heating setting compensation / Removing condensated water in heating mode			EEV Step of stopped unit during oil return/ defrost mode		Motion detect sensor		-	
Remote Controller Display													
Indication and Details	Indication	Details	Indication	Details	Indication	Details		Indication	Details	Indication	Details	Indication	Details
						Heating Setting Compensation	Removing Condensated Water in Heating Mode						
	3	0 or 1	channel 1	0	Default <sup>(*)4</sup>	Disuse	0	Default value	0	Disuse			
				1	2°C	Disuse			1	Turn out in 30min. without motion			
				2	5°C	Disuse			2	Turn out in 60min. without motion			
		4	channel 3	3	Default <sup>(*)4</sup>	Use <sup>(*)5</sup>	1	Oil return or Noise decreasing in defrost mode	3	Turn out in 120min. without motion			
				4	2°C	Use <sup>(*)5</sup>			4	Turn out in 180min. without motion			
		5	channel 4	4	2°C	Use <sup>(*)5</sup>	5	5°C	Use <sup>(*)5</sup>	5	Turn out in 30min. without motion or *advanced function		
				6	5°C	Use <sup>(*)5</sup>				6	Turn out in 60min. without motion or *advanced function		
				7	5°C	Use <sup>(*)5</sup>				7	Turn out in 120min. without motion or *advanced function		
8	5°C	Use <sup>(*)5</sup>	8	Turn out in 180min. without motion or *advanced function									

\* Advanced function: Controlling cooling/heating current or power saving with motion detect.

(\*1) Minimizing fan operation when thermostat is off

- Fan operates for 20 seconds at an interval of 5 minutes in heat mode.

(\*2) 1: Fan is turned on continually when the hot water heater is turned on,

3: Fan is turned off when the hot water heater is turned on with cooling only indoor unit

Cooling only indoor unit: To use this option, install the Mode Select switch(MCM-C200) on the outdoor unit and fix it as cool mode.

(\*3) When the following 2 or 3 is used as external heater On/Off signal, the signal for monitoring external contact control will not be output.

2: Fan is turned on continually when the external heater is turned on,

3: Fan is turned off when the external heater is turned on with cooling only indoor unit

Cooling only indoor unit: To use this option, install the Mode Select switch(MCM-C200) on the outdoor unit and fix it as cool mode.

- If Fan is set to off for cooling only indoor unit by setting the SEG9=3 or SEG15=3, you need to use an external sensor or wired remote controller sensor to detect indoor temperature exactly.

(\*4) Default setting value

- 4Way Cassette, Mini 4Way Cassette: 5 °C

- Other indoor units: 2 °C

(\*5) This function can be applied to 4 Way Cassette and Mini 4 Way Cassette only. If the air conditioner operates the heating mode immediately after finishing the cooling mode, the condensated water in the drain pan becomes water vapor by the heat of the indoor unit heat exchanger. Since the water vapor might be condensed on the indoor unit, which may fall into a living space, use this function to get rid of the water vapor out of the indoor unit by operating the fan (for maximum 20 minutes) even when the indoor unit is turned off after cooling mode is turned to heating mode.

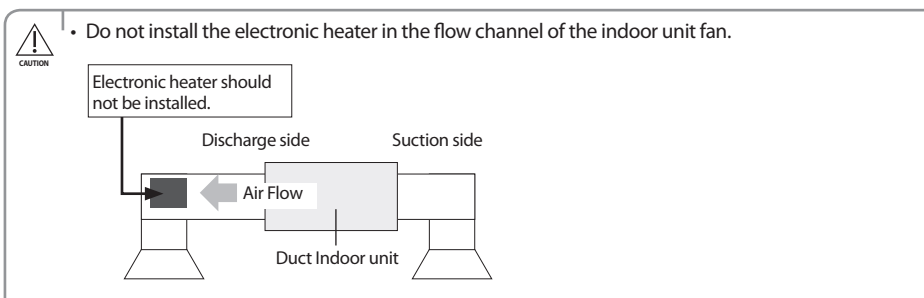









## ■ 05 series installation option

SEG1	SEG2	SEG3	SEG4	SEG5	SEG6
0	5	Use of Auto Change Over for HR only in Auto mode	(When setting SEG3) Standard heating temp. Offset	(When setting SEG3) Standard cooling temp. Offset	(When setting SEG3) Standard for mode change Heating → Cooling
SEG7	SEG8	SEG9	SEG10	SEG11	SEG12
1	(When setting SEG3) Standard for mode change Cooling → Heating	(When setting SEG3) Time required for mode change	Compensation option for Long pipe or height difference between indoor units	-	-
SEG13	SEG14	SEG15	SEG16	SEG17	SEG18
2	-	-	-	-	Control variables when using hot water / external heater
SEG19	SEG20	SEG21	SEG22	SEG23	SEG24
3	-	-	-	-	-

# Setting an indoor unit address and installation option

## ■ 05 series installation option(Detailed)

Option No. : 05XXXX-1XXXXX-2XXXXX-3XXXXX

Option	SEG1		SEG2		SEG3		SEG4		SEG5		SEG6	
Explanation	PAGE		MODE		Use of Auto Change Over for HR only in Auto mode		(When setting SEG3) Standard heating temp. Offset		(When setting SEG3) Standard cooling temp. Offset		(When setting SEG3) Standard for mode change Heating → Cooling	
Remote Controller Display												
Indication and Details	Indication	Details	Indication	Details	Indication	Details	Indication	Details	Indication	Details	Indication	Details
	0		5		0	Follow product option	0	0°C	0	0°C	0	1°C
					1	Use Auto Change Over for HR only	1	0.5°C	1	0.5°C	1	1.5°C
							2	1°C	2	1°C	2	2°C
							3	1.5°C	3	1.5°C	3	2.5°C
							4	2°C	4	2°C	4	3°C
							5	2.5°C	5	2.5°C	5	3.5°C
							6	3°C	6	3°C	6	4°C
7							3.5°C	7	3.5°C	7	4.5°C	
Option	SEG7		SEG8		SEG9		SEG10		SEG11		SEG12	
Explanation	PAGE		(When setting SEG3) Standard for mode changing Cooling → Heating mode		(When setting SEG3) Time required for mode change		Compensation option for Long pipe or height difference between indoor units					
Remote Controller Display												
Indication and Details	Indication	Details	Indication	Details	Indication	Details	Indication	Details				
	1		0	1°C	0	5 min.	0	Use default value				
			1	1.5°C	1	7 min.	1	1)Height difference <sup>1)</sup> is more than 30m or 2)Distance <sup>2)</sup> is longer than 110m				
			2	2°C	2	9 min.						
			3	2.5°C	3	11 min.						
			4	3°C	4	13 min.	2	1)Height difference <sup>1)</sup> is 15~30m or 2)Distance <sup>2)</sup> is 50~110m				
			5	3.5°C	5	15 min.						
			6	4°C	6	20 min.						
7			4.5°C	7	30 min.							

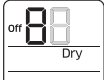
Option	SEG13	SEG14	SEG15	SEG16	SEG17	SEG18 <sup>(*)</sup>			
Explanation						Control variables when using hot water / external heater			
Remote Controller Display									
Indication and Details	2					Indication	Details		
							Set temp. for heater On/Off	Delay time for heater On	
							0	At the same time as thermo on	No delay
							1	At the same time as thermo on	10 minutes
							2	At the same time as thermo on	20 minutes
							3	1.5 °C	No delay
							4	1.5 °C	10 minutes
							5	1.5 °C	20 minutes
							6	3.0 °C	No delay
							7	3.0 °C	10 minutes
							8	3.0 °C	20 minutes
							9	4.5 °C	No delay
							A	4.5 °C	10 minutes
							B	4.5 °C	20 minutes
							C	6.0 °C	No delay
D	6.0 °C	10 minutes							
E	6.0 °C	20 minutes							

(\*1) Height difference : The difference of the height between the corresponding indoor unit and the indoor unit installed at the lowest place.  
For example, When the indoor unit is installed 40m higher than the indoor unit installed at the lowest place, select the option "1".

(\*2) Distance : The difference between the pipe length of the indoor unit installed at farthest place from an outdoor unit and the pipe length of the corresponding indoor unit from an outdoor unit.  
For example, when the farthest pipe length is 100 m(328 ft) and the corresponding indoor unit is 40 m away from an outdoor unit, select the option "2".  
(100 - 40 = 60m)

(\*3) Heater operation when the SEG9 of 02 series installation option is set to using hot water heater or when SEG15 is set to using external heater  
e.g. 1) Setting 02 series SEG9 = "1" / Setting 05 series SEG18 = "0": Hot water heater is turned on at the same time as the heating thermostat is on, and turned off when the heating thermostat is off.  
e.g. 2) Setting 02 series SEG15 = "2" / Setting 05 series SEG18 = "A":  
Room temp. ≤ set temp. + f(heating compensation temp.)  
- External heater is turned on when the temperature is maintained as 4.5 °C for 10 minutes.  
Room temp. > set temp. + f(heating compensation temp.)  
- External heater is turned off when the temperature is maintained as 4.5 °C + 1 °C (1 °C is the Hysteresis for On/Off selection.)

# Setting an indoor unit address and installation option

## SEG 3, 4, 5, 6, 8, 9 additional information

When the SEG 3 is set as "1" and follow Auto Change Over for HR only operation, it will operate as follows.

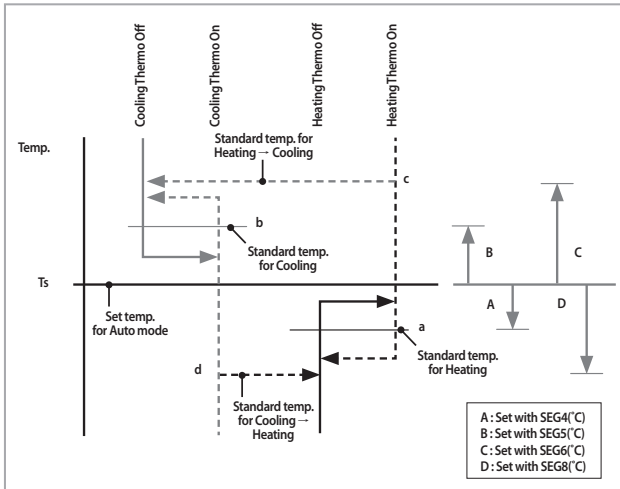

Cooling/Heating mode can be changed when Thermo Off status is maintained during the time with SEG9.

## Changing a particular option

You can change each digit of set option.

Option	SEG1		SEG2		SEG3		SEG4		SEG5		SEG6	
Explanation	PAGE		MODE		The option mode you want to change		The tens' digit of an option SEG you will change		The unit digit of an option SEG you will change		Changed value	
Remote Controller Display												
Indication and Details	Indication	Details	Indication	Details	Indication	Details	Indication	Details	Indication	Details	Indication	Details
	0		D		Option mode	1~6	Tens' digit of SEG	0~9	Unit digit of SEG	0~9	The changed value	0~F

### Note

- When changing a digit of an indoor unit address setting option, set the SEG3 as 'A'.
- When changing a digit of indoor unit installation option, set the SEG3 as '2'.

Ex) When setting the 'buzzer control' into disuse status.

Option	SEG1	SEG2	SEG3	SEG4	SEG5	SEG6
Explanation	PAGE	MODE	The option mode you want to change	The tens' digit of an option SEG you will change	The unit digit of an option SEG you will change	Changed value
Indication	0	D	2	1	7	1



◆ If you are using heat pump model, mixed operation mode (two or more indoor units operating in different operation mode simultaneously) is not available when the indoor units are connected to same outdoor unit. If you set the master indoor unit with a remote controller, outdoor unit will operate in the mode which was set in the master indoor unit.

# Setting temperature control of discharge air

- 1) Use of "Temperature control of discharge air" or target temperature of discharge air in cooling/heating can be set with the service mode of a wired remote controller. (Refer to the installation manual of a wired remote controller.)
  - 2) When using temperature control of discharge air, thermo on/off of Indoor unit is decided by set room temperature and room temperature, and the temperature of discharge air is adjusted to meet the target temperature of discharge air in thermostat On section.
  - 3) When using temperature control of discharge air, the temperature of discharge air cannot always be adjusted to the target temperature due to external conditions or protective control of the outdoor unit.
- \* Temperature control of discharge air can be set with DMS as well.

# Final check and trial operation

***To complete the installation, perform the following checks and tests to ensure that the air conditioner operates correctly.***

Check the following:

- ◆ Strength of the installation site
- ◆ Tightness of pipe connection to detect gas leak
- ◆ Electric wiring connection
- ◆ Heat-resistant insulation of the pipe
- ◆ Drainage
- ◆ Grounding conductor connection
- ◆ Correct operation (follow the steps below)

# Providing information for user

***After finishing the installation of the air conditioner, you should explain the following to the user. Refer to appropriate pages in the user & installation manual.***

- 1 How to start and stop the air conditioner
- 2 How to select the modes and functions
- 3 How to adjust the temperature and fan speed
- 4 How to adjust the airflow direction
- 5 How to set the timers
- 6 How to clean and replace the filters

***Note*** ***When you complete the installation successfully, hand over the user & installation manual to the user for storage in a handy and safe place.***

# Troubleshooting

## Detection of errors

- ◆ If an error occurs during the operation, an LED flickers and the operation is stopped except the LED.
- ◆ If you re-operate the air conditioner, it operates normally at first, then detect an error again.

## LED Display on the receiver & display unit

### LED Display





- ◆ If you turn off the air conditioner when the LED is flickering, the LED is also turned off.
- ◆ If you re-operate the air conditioner, it operates normally at first, then detect an error again.
- ◆ When E108 error occurs, change the address and reset the system.Ex.) When address of the indoor unit #1 and #2 are set as 5, address of the indoor unit #1 will become 5 and indoor unit #2 will display E108, A002.

● On ○ Flickering × Off

Abnormal condition	Error code	LED Display				
		Blue	Red			
Error on indoor temperature sensor (Short or Open)	E121	×	×	○	×	×
1. Error on Eva-in sensor (Short or Open)	E122	○	×	○	×	×
2. Error on Eva-out sensor (Short or Open)	E123					
3. Discharge sensor error (Short or Open)	E126					
Indoor fan error	E154	×	×	×	○	×
1. Error on outdoor temperature sensor (Short or Open)	E221					
2. Error on cond sensor	E237					
3. Error on discharge sensor	E251	○	×	×	○	×
Other outdoor unit sensor error that is not on the above list						
1. When there is no communication between the indoor-outdoor units for 2 minutes	E101					
2. Communication error received from the outdoor unit	E102					
3. 3 minute tracking error on outdoor unit	E202					
4. Communication error after tracking due to unmatching number of installed units	E201	×	×	○	○	×
5. Error due to repeated communication address	E108					
6. Communication address not confirmed	E109					
Other outdoor unit communication error that is not on the above list						
Self diagnosis error display						
1. Error due to opened EEV (2nd detection)	E151					
2. Error due to closed EEV (2nd detection)	E152					
3. Eva in sensor is detached	E128	×	×	○	○	○
4. Eva out sensor is detached	E129					
5. Thermal fuse error (Open)	E198					



● On ○ Flickering × Off

Abnormal condition	Error code	LED Display				
						
		Blue	Red			
1. COND mid sensor is detached	E241					
2. Refrigerant leakage (2nd detection)	E554					
3. Abnormally high temperature on Cond (2nd detection)	E450					
4. Low pressure s/w (2nd detection)	E451					
5. Abnormally high temperature on discharged air on outdoor unit (2nd detection)	E416					
6. Indoor operation stop due to unconfirmed error on outdoor unit	E559					
7. Error due to reverse phase detection	E425					
8. Comp stop due to freeze detection (6th detection)	E403					
9. Error due to reverse phase detection	E301					
10. High pressure sensor is detached	E306					
11. Low pressure sensor is detached	E428	×	×	●	●	●
12. Outdoor unit copression ration error	E413					
13. Outdoor sump down_1 prevention control	E410					
14. Compressor down due to low pressure sensor prevention control_1	E180					
15. Simultaneous opening of cooling/heating MCU SOL valve (1st detection)	E181					
15. Simultaneous opening of cooling/heating MCU SOL valve (2nd detection)						
Other outdoor unit self-diagnosis error that is not on the above list						
Flowating s/w (2nd detection)	E153	×	×	×	●	●
EEPROM error	E162	●	●	●	●	●
EEPROM option error	E163	●	●	●	●	●
Error due to incompatible indoor unit	E164	×	×	×	×	●

# Option table

## E.S.P(External Static Pressure)setting for phase control motor

With its phase control motor, you can adjust the indoor unit fan speed depending on the installation condition. If the external static pressure is high so that the duct becomes longer or if the external static pressure is low so that the duct becomes shorter, adjust the fan speed by referring the following table.

Static Pressure (mmAq)	0	1	2	3	4	6	8	10	12	14
Model	Option code for indoor unit									
AM017*NLD*	010054-12549E-201111-331110	010054-1255B1-201111-331110	-	010054-1255F5-201111-331110	-	-	-	-	-	-
AM022*NLD*	010054-125A80-201616-331110	010054-125AC3-201616-331110	-	010054-125E08-201616-331110	-	-	-	-	-	-
AM028*NLD*	010054-125AE2-201C1C-331110	010054-125E15-201C1C-331110	-	010054-125E7A-201C1C-331110	-	-	-	-	-	-
AM036*NLD*	010054-125E35-202424-331110	010054-125E68-202424-331110	-	010054-125ECD-202424-331110	-	-	-	-	-	-
AM045*NLD*	010054-12599F-202D2D-331110	-	010054-125AE2-202D2D-331110	-	010054-125EF6-202D2D-331110	-	-	-	-	-
AM056*NLD*	010054-125AC1-203838-331110	-	010054-125E34-203838-331110	-	010054-125EF9-203838-331110	-	-	-	-	-
AM071*NLD*	010054-1259BB-204747-331110	-	010054-125D9E-204747-331110	-	010054-125EF4-204747-331110	-	-	-	-	-
AM090*NLD*	010054-1B596C-205A5A-331110	-	-	010054-1B5AD4-205A5A-331110	-	010054-1B5E2A-205A5A-331110	-	-	-	-
AM112*NLD*	010054-1B596C-207070-331110	-	-	010054-1B5AD4-207070-331110	-	010054-1B5E2A-207070-331110	-	-	-	-
AM128*NLD*	010054-1B5AF5-208080-331110	-	-	010054-1B5E4B-208080-331110	-	010054-1B5E8F-208080-331110	-	-	-	-
AM140*NLD*	010054-1B5E3A-208C8C-331110	-	-	010054-1B5E7F-208C8C-331110	-	010054-1B5FC3-208C8C-331110	-	-	-	-



Static Pressure (mmAq)	0	1	2	3	4	6	8	10	12	14
Model	Option code for indoor unit									
AM022*NMD*	010054-1350B6-201616-331110	-	010054-1350EA-201616-331110	-	010054-13541E-201616-331110	010054-1355E4-201616-331110	-	-	-	-
AM028*NMD*	010054-1350E8-201C1C-331110	-	010054-13542C-201C1C-331110	-	010054-135562-201C1C-331110	010054-1359A9-201C1C-331110	-	-	-	-
AM036*NMD*	010054-1350EA-202424-331110	-	010054-1350FB-202424-331110	-	010054-13542C-202424-331110	010054-1354CF-202424-331110	-	-	-	-
AM045*NMD*	010054-125550-202D2D-331110	-	010054-125571-202D2D-331110	-	010054-125583-202D2D-331110	010054-1255A4-202D2D-331110	010054-125906-202D2D-331110	-	-	-
AM056*NMD*	010054-125571-203838-331110	-	010054-125593-203838-331110	-	010054-1255C5-203838-331110	010054-1255F5-203838-331110	010054-125957-203838-331110	-	-	-
AM071*NMD*	010054-125904-204747-331110	-	010054-125936-204747-331110	-	010054-125979-204747-331110	010054-125DF9-204747-331110	010054-125DFC-204747-331110	-	-	-
AM090*NMD*	-	-	-	-	010054-125945-205A5A-331110	010054-125D29-205A5A-331110	010054-125DFD-205A5A-331110	-	-	-
AM112*NMD*	-	-	-	-	010054-122E04-207070-331110	010054-122E26-207070-331110	010054-122EBB-207070-331110	010054-122FF0-207070-331110	010054-122FF0-207070-331110	-
AM128*NMD*	-	-	-	-	010054-12299F-208080-331110	010054-122AC1-208080-331110	010054-122AE3-208080-331110	010054-122E15-208080-331110	010054-122E47-208080-331110	010054-122E69-208080-331110
AM140*NMD*	-	-	-	-	010054-122AF2-208C8C-331110	010054-122E25-208C8C-331110	010054-122E57-208C8C-331110	010054-122E7A-208C8C-331110	010054-122EDD-208C8C-331110	010054-122EFF-208C8C-331110
AM160*NMD*	-	-	-	-	010054-125E79-20A0A0-331110	010054-125EAA-20A0A0-331110	010054-125EDB-20A0A0-331110	010054-125EFC-20A0A0-331110	010054-125EFD-20A0A0-331110	010054-125EFE-20A0A0-331110

# Option table

Static Pressure (mmAq)	0	1	2	3
Model	Option code for indoor unit			
AM017KNLD*	010054-1C9062-201212-331110	010054-1C90B5-201212-331110	010054-1C940A-201212-331110	010054-1C9584-201212-331110
AM022KNLD*	010054-1C9073-201616-331110	010054-1C90D5-201616-331110	010054-1C942A-201616-331110	010054-1C95A4-201616-331110
AM028KNLD*	010054-1C90B3-201C1C-331110	010054-1C9417-201C1C-331110	010054-1C946C-201C1C-331110	010054-1C95C5-201C1C-331110
AM036KNLD*	010054-1C9404-202424-331110	010054-1C9459-202424-331110	010054-1C94AE-202424-331110	010054-1C9916-202424-331110





Static Pressure (mmAq)	5	10	15	20
Model	Option code for indoor unit			
AM112*NHD*	010054-1355E8-207070-331110	010054-13598F-207070-331110	010054-135E19-207070-331110	010054-135E19-207070-331110
AM128*NHD*	010054-13591C-208080-331110	010054-135AC4-208080-331110	010054-135E4E-208080-331110	010054-135F95-208080-331110
AM140*NHD*	010054-13595E-208C8C-331110	010054-135E09-208C8C-331110	010054-135F71-208C8C-331110	010054-135FB7-208C8C-331110

Static Pressure (mmAq)	0	2	4
Model	Option code for indoor unit		
AM045MNLD*	010054-1C5458-202D2D-331110	010054-1C54EA-202D2D-331110	010054-1C585F-202D2D-331110
AM056MNLD*	010054-1C54FC-203838-331110	010054-1C5950-203838-331110	010054-1C59C4-203838-331110
AM071MNLD*	010054-1C54D9-204747-331110	010054-1C584E-204747-331110	010054-1C59B2-204747-331110

- Note**
- ◆  represents E.S.P(External Static Pressure)range of factory setting.  
You don't have to adjust the fan speed separately if the external static pressure of the installation place is in . When it is out of , input the appropriate option code.
  - ◆ If you input the inappropriate option code,error may occur or the air conditioner is out of order. The option code must be inputted correctly by the installation specialist or service agent.
  - ◆ When the indoor unit is installed without an air supply duct by means of the lower air return, make sure to use the corresponding option code in the "0" static pressure column.

# Extending the power cable

1) Prepare the following tools.

Tools	Crimping pliers	Connection sleeve (mm)	Insulation tape	Contraction tube (mm)
Spec	MH-14	20xØ6.5(HxOD)	Width 19mm	70xØ8.0(LxOD)
Shape				

2) As shown in the figure, peel off the shields from the rubber and wire of the power cable.

- Peel off 20 mm of cable shields from the pre-installed tube.



- For information about the power cable specifications for indoor and outdoor units, refer to the installation manual.
- After peeling off cable wires from the pre-installed tube, insert a contraction tube.

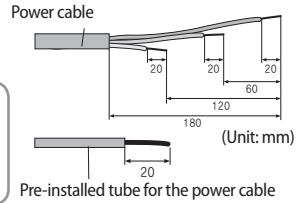

3) Insert both sides of core wire of the power cable into the connection sleeve.

► **Method 1**

Push the core wire into the sleeve from both sides.

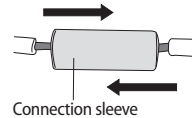

► **Method 2**

Twist the wire cores together and push it into the sleeve.

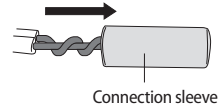

4) Using a crimping tool, compress the two points and flip it over and compress another two points in the same location.

- The compression dimension should be 8.0.

- After compressing it, pull both sides of the wire to make sure it is firmly pressed.

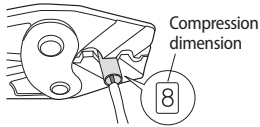

► **Method 1**

Compress it 4 times.

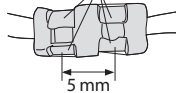

► **Method 2**

Compress it 4 times.

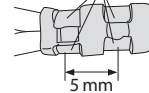

# Extending the power cable

5) Wrap it with the insulation tape twice or more and position your contraction tube in the middle of the insulation tape.

Three or more layers of insulation are required.

► **Method 1**

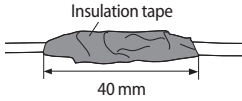

► **Method 2**

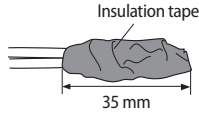

6) Apply heat to the contraction tube to contract it.

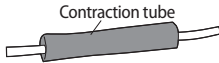

7) After tube contraction work is completed, wrap it with the insulation tape to finish.



- Make sure that the connection parts are not exposed to outside.
- Be sure to use insulation tape and a contraction tube made of approved reinforced insulating materials that have the same level of withstand voltage with the power cable. (Comply with the local regulations on extensions.)

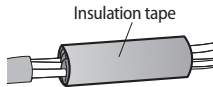

- In case of extending the electric wire, please **DO NOT** use a round-shaped Pressing socket.
- Incomplete wire connections can cause electric shock or a fire.

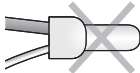

# Memo

---

**SAMSUNG**

**This product is RoHS compliant**





## Duct Type Series

Slim Duct : AM\*\*\*\*NLD\*\*\*

AM022/028/036\*NMD\*\*\*

Ma Duct : AM\*\*\*\*NMD\*\*\*

HSP Duct : AM\*\*\*\*NHD\*\*\*

Home Duct : AM\*\*\*\*MNL\*\*\*

# Air Conditioner installation manual

imagine the possibilities

Thank you for purchasing this Samsung product.



EN DB68-03634A-12

**SAMSUNG**