

features of your new air conditioner

- **Cool Summer Offer**

On those hot sweltering summer days and long restless nights, there is no better escape from the heat than the cool comforts of home. Your new air conditioner brings an end to exhausting hot summer days and lets you rest. This summer, beat the heat with your own air conditioner.

- **Cost Efficient System**

Your new air conditioner not only provides maximum cooling power in the summer, but can also be an efficient heating method in the winter with the advanced “Heat pump” system. This technology is up to 300% more efficient than electrical heating, so you can further reduce its running cost. Now, meet year-round needs with one air conditioner.

- **Flexible installation**

Duct type air conditioner is designed to be slimmer and offers different solutions for any shape room allowing for specific air flow requirements. Also, the air intake can be set up on either the bottom or rear of the unit, so there is more flexibility in installation.

SAMSUNG

For easy future reference write the model and serial number down. You will find your model number on the right side of the air conditioner.

Model # _____
Serial # _____

safety information











To prevent electric shock, disconnect the power before servicing, cleaning, and installing the air conditioner.

SAFETY INFORMATION

Before using your new air conditioner, please read this manual thoroughly to ensure that you know how to safely and efficiently operate the extensive features and functions of your new appliance.

Because the following operating instructions cover various models, the characteristics of your air conditioner may differ slightly from those described in this manual. If you have any questions, call your nearest contact center or find help and information online at www.samsung.com.

Important safety symbols and precautions:

 WARNING	Hazards or unsafe practices that may result in severe personal injury or death.
 CAUTION	Hazards or unsafe practices that may result in minor personal injury or property damage.
 CAUTION	To reduce the risk of fire, explosion, electric shock, or personal injury when using your air conditioner, follow these basic safety precautions:
	Do NOT attempt.
	Do NOT disassemble.
	Do NOT touch.
	Follow directions carefully.
	Unplug the power plug from the wall socket.
	Make sure the machine is grounded to prevent electric shock.
	Call the contact center for help.
	Note.

These warning signs are here to prevent injury to you and others. Please follow them carefully.

After reading this section, keep it in a safe place for future reference.

safety information

SEVERE WARNING SIGNS

-  **Do not place the air conditioner near hazardous substances or equipment that releases free flames to avoid fire, explosions or injuries.**
- Potential risk of fire hazard or explosion.

Do not install the outdoor unit at an unstable place or elevated surface where there is potential risk of falling.

- If the outdoor unit falls, it may cause personal injury or loss of property.

Failure or damage may occur if any changes or modification that is not stated in the installation manual was performed. In this case, user will be responsible for the repair expenses.

Install the air conditioner away from direct exposure to sunlight, heating apparatus, and humid places.

- Hang curtains on windows to boost cooling efficiency and to avoid the risk of electric shock.

Do not cut the power plug and connect to a different power cable.

Do not yank the power cable and touch the power plug with hands.

- Potential risk of fire or electric shock.

Never use a damaged or dusted power plug, power cable, or loosened power receptacle.

- Potential risk of fire or electric shock.

Install an exclusive circuit breaker and short-circuit breaker for the air conditioner.

- Potential risk of electric shock or fire.

Do not insert anything such as fingers or branches into the air conditioner vents while the air conditioner is running.

- Keep the children away from the air conditioner to prevent them from putting their finger on the air conditioner. Potential risk of personal injury.

Ensure no water gets into the air conditioner.

- Potential risk or electric shock.
- If the water gets into the air conditioner, stop and unplug the power source immediately.

Turn off the air conditioner using the provided remote control or control accessory (if provided). Do not unplug to turn off the unit (unless there is an immediate danger).

Do not run the air conditioner for an extended period of time in a room with the door closed or with babies, elderly or disabled people.

- Open the door or windows to ventilate your room at least once an hour to prevent oxygen shortage.

The air conditioner is composed of moving parts. Keep children away from the unit to avoid physical injury.

 **Make sure that children take precautions against access to the air conditioner and they do not play with the unit.**

Do not clean the interior of air conditioner on your own.

- You may damage the parts which can cause electric shock or fire
- Consult contact center for cleaning the interior of the air conditioner.

 **Do not Connect the air conditioner with heating apparatus or attempt to disassemble, remodel or repair it yourself.**

- Potential risk of malfunction, electric shock or fire. If repairs are needed, consult the contact center.

 **Consult the place of purchase or contact to install, reinstall or disassemble the air conditioner.**

- Improper installation carries a risk of unit malfunction, water leakage, electric shock or fire.
- If installing in specialty areas, such as a factory complex or saline coastal area, consult the place of purchase or contact center for specific installation details.
- The units must be installed according to distances declared, in order to permit accessibility from each side, either to guarantee correct operation of maintenance or repairing products. The unit's parts must be reachable and removable completely under safety condition (for people or things).

Consult a dealer regarding the appropriate measures to prevent the allowable concentration from being exceeded.

- If the refrigerant leaks, and cause the concentration limit to be exceeded, hazards due to lack of oxygen in the room may result.

If the indoor unit gets wet, turn the power off immediately and call your nearest contact center.

- Potential risk of fire or electric shock.

Always make sure that the power supply is compliant with current safety standards. Always install the air conditioner in compliance with current local safety standards.

Verify that the voltage and frequency of the power supply comply with the specifications and that the installed power is sufficient to ensure the operation of any other domestic appliance connected to the same electric lines.

Use a rated circuit breaker only.

- Never use steel wires or copper wires as a circuit breaker. It may cause fire or unit malfunctions.

Do not put undue stress or place heavy object on the power cable.

Do not bend the power cable excessively.

- Potential risk of fire or electric shock.

To protect the product from water and possible shock, you should keep the power cable and the connection cord of the indoor and outdoor units in the protection tube.

When opening or closing the front panel, use a stable stool and watch your steps carefully.

 **Disconnect the air conditioner from power supply before it is repaired or disassembled.**

Clean the air conditioner after the inner fan stops operating.

- Potential risk of injury or electric shock.

safety information

SEVERE WARNING SIGNS (CONT'D)

 **Use a receptacle that has a ground terminal. The receptacle must be used exclusively for the air conditioner.**

- Improper electrical grounding may cause electric shock or fire.

Be sure to ground the unit. Do not connect the ground wire to gas or water pipes, lighting rods, or telephone grounding lines.

- If the unit is not properly grounded, electric shock may result.

 **If you smell burning plastic, hear strange sounds, or see smoke coming from the unit, unplug the air conditioner immediately and call a contact center.**

- Potential risk of fire or electric shock.

CAUTION SIGNS

 **Do not block or place items in front of the air conditioner. Do not step, hang onto, or place heavy items on the air conditioner.**

- Potential risk of personal injury.

If failure or damage occurs on the conditions of improper use not followed by the installation manual, there will be an extra labor charge for installing and construction.

- Potential risk of malfunction, electric shock or fire if repairs or installations are attempted by a non-qualified service technician.

Do not spray flammable gases such as insecticide near the air conditioner.

- Potential risk of electric shock, fire or unit malfunction.

Do not open the front grille during operation.

- Potential risk of electric shock or unit malfunction.

Cool air should not flow directly towards people, pets, and plants.

- It is harmful to your health, pets, and plants.

Do not drink drain water coming out of the air conditioner.

- Potential risk of health hazard.

Do not allow children to climb on the air conditioner.

Do not use the air conditioner as a cooling precision instrument for food, pets, plants, cosmetics or machinery.

Do not pull or give excessive shock to the air conditioner.

- Potential risk of fire, or unit malfunction and there are risk of personal injury because unit may fall down.

Do not spray water directly on the air conditioner or use benzene, thinner or alcohol to clean the surface of the unit.

- Potential risk of electric shock or fire.
- Potential risk of damage to the air conditioner.

Do not place any objects, especially containers with liquid.

 Do not touch the pipe connected to the air conditioner.

 Install the indoor unit (receiver) in a place far away from the lighting equipment of the ballast.

- If you use the wireless remote control, reception error may occur due to the ballast of the lighting apparatus.

Install the outdoor unit where operating noise and vibration will not disturb your neighbor and in a well-ventilated area with no obstacle.

- Potential risk of malfunction.
- Operating noise may disturb your neighbor.

Make sure that there are no obstacles or covers that block the air conditioner.

Allow sufficient space for air circulation.

- Insufficient ventilation may result in poor performance.

If the power cable is damaged, the manufacturer or a qualified service technician must replace it.

If a power outage occurs while the air conditioner is working, turn off the power source immediately.

Max current is measured according to IEC standard for safety and current is measured according to ISO standard for energy efficiency.

Check for damage on delivery. If damaged, do not install the air conditioner and call the place of purchase immediately.

Keep indoor temperatures stable and not extremely cold, especially where there are children, elderly or disabled people.

The packaging material and used batteries of the remote controller (optional) must be disposed of in accordance with the national standards.

The refrigerant used in the air conditioner must be treated as chemical waste. Dispose the refrigerant following national standards.

Have a qualified service technician install the air conditioner and perform a trial operation.

Firmly connect the drain hose to the air conditioner for proper water drainage.

Check for damages on the outdoor unit installation pad at least once a year.

- Potential risk of personal injury or property loss.

When using a wireless remote control, the distance should not be more than 7 meters from the air conditioner.

If the remote control is not used for a long period of time, remove the batteries to prevent leakage of electrolyte.

When cleaning the outdoor unit, touch the heat exchanger radiator fins with extreme care.

- Wearing thick gloves can protect your hands.

Make sure that the condensed water dripping from the drain hose runs out properly and safely.

The appliance is not intended for use by persons (including children) with reduced physical, sensory or mental capabilities, or lack of experience and knowledge, unless they have been given supervision or instruction concerning use of the appliance by a person responsible for their safety: Young children should be supervised to ensure that they do not play with the appliance.

safety information

CAUTION SIGNS (CONT'D)

-  **Inspect the condition, electric connections, pipes and external case of the air conditioner regularly by a qualified service technician.**

Do not open doors and windows in the room being cooled during operation unless necessary.

Do not block the air conditioner vents. If objects block the air flow, it may cause unit malfunction or poor performance.

Make sure there are no obstacles under the indoor unit.

- Potential risk of fire or loss of property.

The air conditioner should be used only for the applications for which it has been designed: the indoor unit is not suitable to be installed in areas used for laundry.

Our units must be installed in compliance with the spaces indicated in the installation manual to ensure either accessibility from both sides or ability to perform routine maintenance and repairs. The units' components must be accessible and that can be disassembled in conditions of complete safety either for people or things.

For this reason, where it is not observed as indicated into the Installation Manual, the cost necessary to reach and repair the unit

(in safety, as required by current regulations in force) with slings, trucks, scaffolding or any other means of elevation won't be considered in-warranty and charged to end user.

For use in Europe : This appliance can be used by children aged from 8 years and above and persons with reduced physical, sensory or mental capabilities or lack of experience and knowledge if they have been given supervision or instruction concerning use of the appliance in a safe way and understand the hazards involved. Children shall not play with the appliance. Cleaning and user maintenance shall not be made by children without supervision.

-
-  **Ensure the off-on and protection switches are properly installed.**

Do not use the air conditioner if damaged. If problems occur, immediately stop operation and disconnect the plug from the power supply.

If the air conditioner will not be used for an extended period of time (for example, over several months), unplug the power from the wall.

-
-  **Call the place of purchase or a contact center if repairs are needed.**
 - Potential risk of fire or electric shock if disassembly or repairs are attempted by a non-qualified service technician.

If you smell burning plastic, hear strange sounds, or see smoke coming from the unit, unplug the air conditioner immediately and call a contact center.

- Potential risk of fire or electric shock.

contents

VIEWING YOUR AIR CONDITIONER	10	Slim duct type
		10 MA/HSP duct type
	10	
USING YOUR AIR CONDITIONER	11	Tips on using your air conditioner
	11	
CLEANING AND MAINTAINING THE AIR CONDITIONER	12	Cleaning the filter
		12 Slim duct type
		13 MA/HSP duct type
	14	Maintaining your air conditioner
		14 Periodical checks
		15 Internal protections via the unit control system
	12	
APPENDIX	16	Troubleshooting
		17 Operation ranges
	16	
INSTALLING YOUR AIR CONDITIONER	18	Installation part
	18	



Correct Disposal of This Product (Waste Electrical & Electronic Equipment)

(Applicable in countries with separate collection systems)

This marking on the product, accessories or literature indicates that the product and its electronic accessories (e.g. charger, headset, USB cable) should not be disposed of with other household waste at the end of their working life. To prevent possible harm to the environment or human health from uncontrolled waste disposal, please separate these items from other types of waste and recycle them responsibly to promote the sustainable reuse of material resources.

Household users should contact either the retailer where they purchased this product, or their local government office, for details of where and how they can take these items for environmentally safe recycling.

Business users should contact their supplier and check the terms and conditions of the purchase contract. This product and its electronic accessories should not be mixed with other commercial wastes for disposal.

For information on Samsung's environmental commitments and product specific regulatory obligations e.g. REACH visit: samsung.com/uk/aboutsamsung/samsungelectronics/corporatecitizenship/data_corner.html

viewing your air conditioner

Congratulations on the purchase of the air conditioner. We hope you enjoy the features of your air conditioner and stay cool or warm with optimal efficiency. Please read the user manual to get started and to make the best use of the air conditioner.

SLIM DUCT TYPE

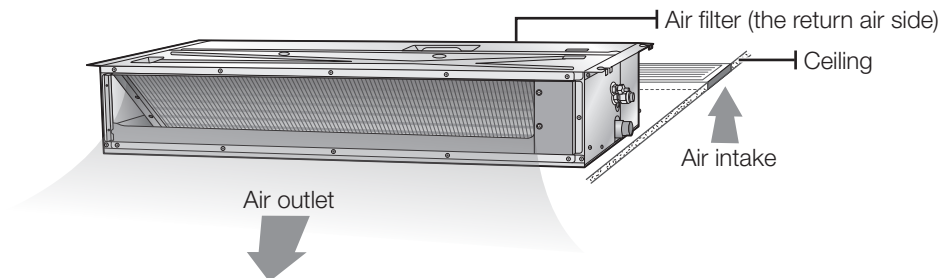

MA DUCT TYPE

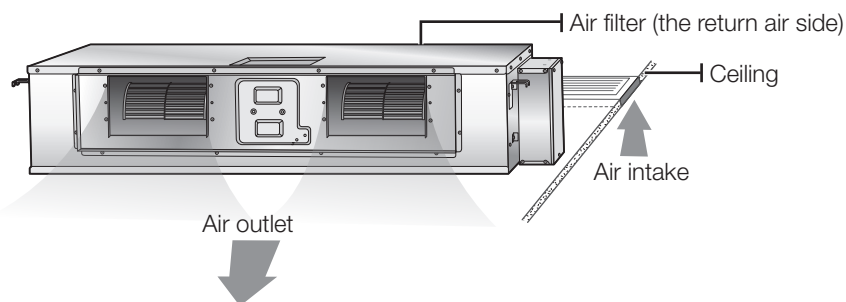

HSP DUCT TYPE

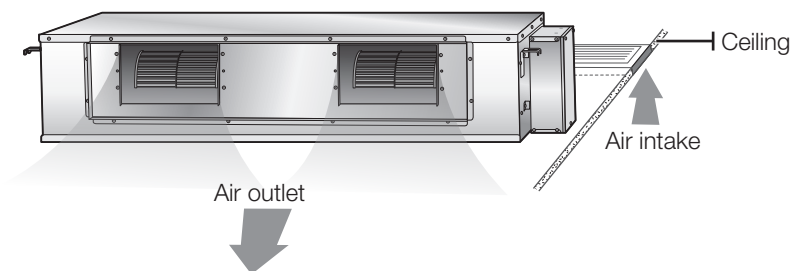

 Your air conditioner may look slightly different from the illustration shown above depending on your model.

using your air conditioner

TIPS ON USING YOUR AIR CONDITIONER

Here are some tips that you would follow when using your air conditioner.

TOPIC	RECOMMENDATION
Cooling	<ul style="list-style-type: none">• If current outside temperatures are much higher than the selected indoor temperature, it may take time to bring the inner temperature to the desired coolness.• Avoid drastically turning down the temperature. Energy is wasted and the room does not cool faster.
Heating	<ul style="list-style-type: none">• Since the air conditioner heats the room by taking heat energy from outdoor air, the heating capacity may decrease when outdoor temperatures are extremely low. If you feel the air conditioner insufficiently heats, using an additional heating appliance in combination with the air conditioner is recommended.
Frost & De-ice	<ul style="list-style-type: none">• When the air conditioner runs in Heat mode, due to temperature difference between the unit and the outside air, frost will form. If this happens:<ul style="list-style-type: none">- The air conditioner stops heating.- The air conditioner will operate automatically in De-ice mode for 10 minutes.- The steam produced on the outdoor unit in De-ice mode is safe.No intervention is required; after about 10 minutes, the air conditioner operates again normally.  The unit will not operate when it starts to de-ice.
Fan	<ul style="list-style-type: none">• Fan may not operate for about 3~5 minutes at the beginning to prevent any cold blasts while the air conditioner is warming up.
High indoor/outdoor temperatures	<ul style="list-style-type: none">• If both indoor and outdoor temperatures are high and the air conditioner is running in Heat mode, the outdoor unit's fan and compressor may stop at times. This is normal; wait until the air conditioner turns on again.
Power failure	<ul style="list-style-type: none">• If a power failure occurs during the operation of the air conditioner, the operating immediately stops and unit will be off. When power returns, the air conditioner will run automatically.
Protection mechanism	<ul style="list-style-type: none">• If the air conditioner has just been turned on after operation stops or being plugged in, cool/warm air does not come out for 3 minutes to protect the compressor of the outdoor unit.

cleaning and maintaining the air conditioner

For the best performance from your air conditioner, clean it periodically. When cleaning, make sure to unplug from the unit for user's safety.

CLEANING THE FILTER

When cleaning the filter, make sure to unplug the power from the unit. Washable foam based Air filter captures large particles from the air. The filter is cleaned with a vacuum or by hand washing.

Slim duct type

1. Slide out the Air filter on the rear side panel to the right side.



2. Clean the Air filter with a vacuum cleaner or soft brush. If dust is too heavy, then rinse it with running water and dry it in a ventilated area.

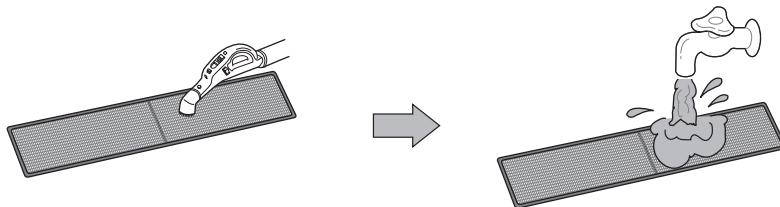

- ☑ For best conditions, repeat every two weeks.
- If the Air filter dries in a confined (or humid) area, odors may generate. If it occurs, re-clean and dry it in a ventilated area.

3. Insert the Air filter back in its original position.

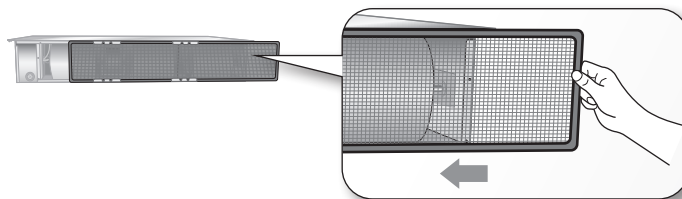

- ☑ The illustration shown above may differ from your depending on your model.
- After cleaning the filter, press the **Filter Reset** button on the remote control for 2 seconds to reset the filter schedule. Filter sign indicator will be on for cleaning time.

MA/HSP duct type

1. Slide out the Air filter on the rear side panel to the right side.

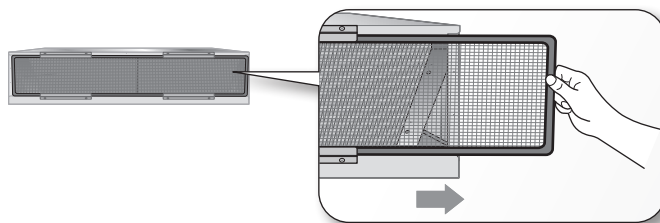

2. Clean the Air filter with a vacuum cleaner or soft brush. If dust is too heavy, then rinse it with running water and dry it in a ventilated area.

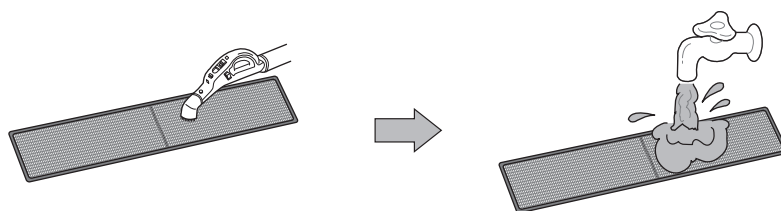

- ☑ • For best conditions, repeat every two weeks.
- If the Air filter dries in a confined (or humid) area, odors may generate. If it occurs, re-clean and dry it in a ventilated area.

3. Insert the Air filter back in its original position.

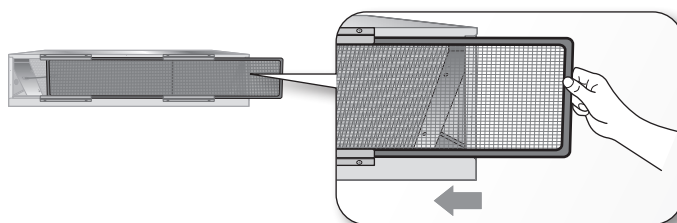

- ☑ • The illustration shown above may differ from your depending on your model.
- After cleaning the filter, press the **Filter Reset** button on the remote control for 2 seconds to reset the filter schedule. Filter sign indicator will be on for cleaning time.

cleaning and maintaining the air conditioner

MAINTAINING YOUR AIR CONDITIONER

If the air conditioner will not be used for an extended period of time, dry the air conditioner to maintain it in best condition.

1. Dry the air conditioner thoroughly by operating in Fan mode for 3 to 4 hours and disconnect the power plug. There may be internal damage if moisture is left in components.
2. Before using the air conditioner again, dry the inner components of the air conditioner again by running in Fan mode for 3 to 4 hours. This helps remove odors which may have generated from dampness.

Periodical checks

Refer to the following chart to maintain the air conditioner properly.

Type	Description	Monthly	Every 4 months	Once a year
Indoor unit	Clean the air filter (1)	●		
	Clean the condensate drain pan (2)			●
	Thoroughly clean the heat exchanger (2)			●
	Clean the condensate drain pipe (2)		●	
	Replace the remote control batteries (1)			●
Outdoor unit	Clean the heat exchanger on the outside of the unit (2)		●	
	Clean the heat exchanger on the inside of the unit (2)			●
	Clean the electric components with jets of air (2)			●
	Verify that all the electric components are firmly tightened (2)			●
	Clean the fan (2)			●
	Verify that all the fan assembly is firmly tightened (2)			●
	Clean the condensate drain pan (2)			●

 The checks and maintenance operations described are essential to guarantee the efficiency of the air conditioner. The frequency of these operations varies according to the characteristics of the area, the amount of dust, etc.

(1) The described operations should be performed more frequently if the area of installation is very dusty.

(2) These operations must always be performed by qualified personnel. For more detailed information, see the Installation Manual.

Internal protections via the unit control system

This internal protection operates if an internal fault occurs in the air conditioner.

Type	Description
Against cold air	The internal fan will be off to against cold air when the heat pump is heating.
De-ice cycle	The internal fan will be off to against cold air when the heat pump is heating.
Anti-protection of internal battery	The compressor will be off to protect internal battery when the air conditioner operates in Cool mode.
Protect compressor	The air conditioner does not start operating immediately to protect the compressor of the outdoor unit after it has been started.



If the heat pump is operating in Heat mode, De-ice cycle is actuated to remove frost from an outdoor unit that may have deposited at low temperatures.

The internal fan is switched off automatically and restarted only after the de-ice cycle is completed.

appendix

TROUBLESHOOTING

Refer to the following chart if the air conditioner operates abnormally. This may save time and unnecessary expenses.

PROBLEM	SOLUTION
The air conditioner does not operate immediately after it has been restarted.	<ul style="list-style-type: none"> Because of the protective mechanism, the appliance does not start operating immediately to keep the unit from overloading. The air conditioner will start in 3 minutes.
The air conditioner does not work at all.	<ul style="list-style-type: none"> Check that the power plug is properly connected. Insert the power plug into the wall socket correctly. Check if the circuit breaker is switched off. Check if there is a power failure. Check your fuse. Make sure it is not blown out.
The temperature does not change.	<ul style="list-style-type: none"> Check if you selected Fan mode. Press the Mode button on the remote control to select another mode.
The cool (warm) air does not come out of the air conditioner.	<ul style="list-style-type: none"> Check if the set temperature is higher (lower) than the current temperature. Press the Temperature button on the remote control to change the set temperature. Press the Temperature button to decrease or increase the temperature. Check if the air filter is blocked by dirt. Clean the air filter every two weeks. Check if the air conditioner has just been turned on. If so, wait 3 minutes. Cool air does not come out to protect the compressor of the outdoor unit. Check if the air conditioner is installed in a place with a direct exposure to sunlight. Hang curtains on windows to boost cooling efficiency. Check if the cover or any obstacle is not near the outdoor unit. Check if the refrigerant pipe is too long. Check if the air conditioner is only available in Cool mode. Check if the remote control is only available for cooling model.
The fan speed does not change.	<ul style="list-style-type: none"> Check if you selected Auto or Dry mode. The air conditioner automatically adjusts the fan speed to Auto in Auto/Dry mode.
Timer function does not set.	<ul style="list-style-type: none"> Check if you press the Power button on the remote control after you have set the time.
Odors permeate in the room during operation.	<ul style="list-style-type: none"> Check if the appliance is running in a smoky area or if there is a smell entering from outside. Operate the air conditioner in Fan mode or open the windows to air out the room.
The air conditioner makes a bubbling sound.	<ul style="list-style-type: none"> A bubbling sound may be heard when the refrigerant is circulating through the compressor. Let the air conditioner operate in a selected mode. When you press the Power button on the remote control, noise may be heard from the drain pump inside the air conditioner.
Water is dripping from the air flow blades.	<ul style="list-style-type: none"> Check if the air conditioner has been cooling for an extended period of time with the air flow blades pointed downwards. Condensation may generate due to the difference in temperature.
Remote control is not working.	<ul style="list-style-type: none"> Check if your batteries are depleted. Make sure batteries are correctly installed. Make sure nothing is blocking your remote control sensor. Check that there are strong lighting apparatus near the air conditioner. Strong light which comes from fluorescent bulbs or neon signs may interrupt the electric waves.
The air conditioner does not turn on or off with the wired remote control.	<ul style="list-style-type: none"> Check if you set the wired remote control for group control.
The wired remote control does not operate.	<ul style="list-style-type: none"> Check if TEST indicator is displayed on the wired remote control. If so, turn off the unit and switch off the circuit breaker. Call your nearest contact center.
The indicators of the digital display flashes.	<ul style="list-style-type: none"> Press the Power button on the remote control to turn the unit off and switch the circuit breaker off. Then, switch it on again.

OPERATION RANGES

The table below indicates the temperature and humidity ranges the air conditioner can be operated within. Refer to the table for efficient use.

MODE	OPERATIONAL TEMPERATURE		INDOOR HUMIDITY	IF OUT OF CONDITIONS
	INDOOR	OUTDOOR		
COOLING	18°C to 32°C	-5°C to 48°C	80% or less	Condensation may occur on the indoor unit with risk to have either water blow off or drops on the floor.
HEATING	27°C or less	-20°C to 24°C	-	Internal protection triggers and the air conditioner will stop.
DRYING	18°C to 32°C	-5°C to 48°C	-	Condensation may occur on the indoor unit with risk to have either water blow off or drops on the floor.

The standardized temperature for heating is 7°C. If the outdoor temperature drops to 0°C or below, the heating capacity can be reduced depending on the temperature condition.

If the cooling operation is used at over 32°C(indoor temperature), it does not cool at its full capacity.



Model specification (Dimension and weight)

Dimension and weight						
Type	Model	Net dimension (WxDxH) (mm)	Net weight (kg)	Model	Net dimension (WxDxH) (mm)	Net weight (kg)
Indoor unit	AM017FNLDEH/EU	700*199*600	19	AM056FNMDEH/EU	900*260*480	29
	AM022FNLDEH/EU	700*199*600	19	AM071FNMDEH/EU	900*260*480	29
	AM028FNLDEH/EU	700*199*600	19	AM090FNMDEH/EU	1150*480*260	32
	AM036FNLDEH/EU	700*199*600	19.5	AM112FNMDEH/EU	1150*320*480	36.5
	AM045FNLDEH/EU	900*199*600	24.5	AM128FNMDEH/EU	1200*360*650	48.5
	AM056FNLDEH/EU	900*199*600	24.5	AM140FNMDEH/EU	1200*360*650	48.5
	AM071FNLDEH/EU	1100*199*600	30	AM112FNHDEH/EU	1200*360*650	57
	AM090FNLDEH/EU	1300*295*690	40	AM128FNHDEH/EU	1200*360*650	57
	AM112FNLDEH/EU	1300*295*690	40	AM140FNHDEH/EU	1200*360*650	57
	AM128FNLDEH/EU	1300*295*690	41.5	AM160KNMDEH/EU	1200*360*650	50
	AM140FNLDEH/EU	1300*295*690	41.5	AM017KNLDEH/EU	700*199*440	15.3
	AM022FNMDEH/EU	900*199*600	23.5	AM022KNLDEH/EU	700*199*440	15.3
	AM028FNMDEH/EU	900*199*600	23.5	AM028KNLDEH/EU	700*199*440	15.3
	AM036FNMDEH/EU	900*199*600	23.5	AM036KNLDEH/EU	700*199*440	15.7
	AM045FNMDEH/EU	900*260*480	29	AM045KNMDEH/EU	900*260*480	28.5
	AM045KNLDEH/EU	900*199*600	25	AM056KNMDEH/EU	900*260*480	28.5
	AM056KNLDEH/EU	900*199*600	25	AM071KNMDEH/EU	900*260*480	28.5
	AM071KNLDEH/EU	1100*199*600	30.5	AM090KNMDEH/EU	1150*260*480	32.5
	AM090KNLDEH/EU	1300*295*690	40.5	AM112KNMDEH/EU	1150*320*480	36
	AM112KNLDEH/EU	1300*295*690	40.5	AM128KNMDEH/EU	1200*360*650	49
	AM128KNLDEH/EU	1300*295*690	42	AM140KNMDEH/EU	1200*360*650	49
	AM140KNLDEH/EU	1300*295*690	42	AM160KNHDEH1EU	1200*360*650	50.5
	AM022KNMDEH/EU	900*199*600	24	AM036KNMDEH/EU	900*199*600	24
	AM028KNMDEH/EU	900*199*600	24	AM045MNLDEH/EU	900*440*199	18.9
AM056MNLDEH/EU	900*440*199	18.9	AM071MNLDEH/EU	1100*440*199	22.3	

Installation Part

Indoor Unit Installation

It is recommended to install the Y-joint before installing the indoor unit.

- Place the pattern sheet on the ceiling at the spot where you want to install the indoor unit.

Note ◆ Since the diagram is made of paper, it may shrink or stretch slightly due to temperature or humidity. For this reason, before drilling the holes maintain the correct dimensions between the markings.

◆ Pattern sheet is supplied depending on the model type.

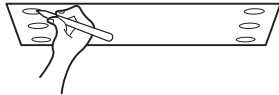

- Insert bolt anchors, use existing ceiling supports or construct a suitable support as shown in figure.

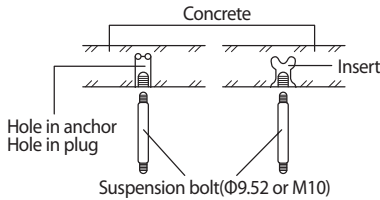

- Install the suspension bolts depending on the ceiling type.



◆ Ensure that the ceiling is strong enough to support the weight of the indoor unit. Before hanging the unit, test the strength of each attached suspension bolt.

◆ If the length of suspension bolt is more than 1.5m, it is required to prevent vibration.

◆ If this is not possible, create an opening on the false ceiling in order to be able to use it to perform the required operations on the indoor unit.

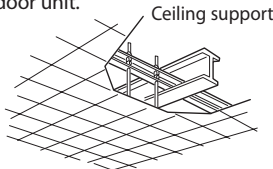

- Screw eight nuts to the suspension bolts making space for hanging the indoor unit.



You must install the suspension bolts more than four when installing the indoor unit.

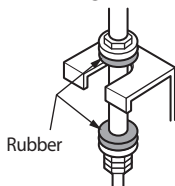

- Hang the indoor unit to the suspension bolts between two nuts.

Note Piping must be laid and connected inside the ceiling when suspending the unit. If the ceiling is already constructed, lay the piping into position for connection to the unit before placing the unit inside the ceiling.

- Screw the nuts to suspend the unit.
- Adjust level of the unit by using measurement plate for all 4 sides.

Note For proper drainage of condensate, give a 10mm(3mm) slant to the left or right side of the unit which will be connected with the drain hose, as shown in the figure. Make a tilt when you wish to install the drain pump, too.

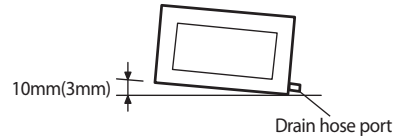

※ AM***NLD***: 3mm
AM022/028/036*NMD***: 3mm
AM***NMD***/AM***NHD***: 10mm



Noise will increase 3~6 dB(A) when the air flow enters from the bottom side (Only for Slim Duct/Home Duct Type product).

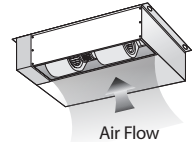

Performing Leak Test & Insulation

Leak test

LEAK TEST WITH NITROGEN (before opening valves)

In order to detect basic refrigerant leaks, before recreating the vacuum and recirculating the R410A, it's responsible of installer to pressurize the whole system with nitrogen (using a pressure regulator) at a pressure above 4.1MPa (gauge).

LEAK TEST WITH R410A (after opening valves)

Before opening valves, discharge all the nitrogen into the system and create vacuum. After opening valves check leaks using a leak detector for refrigerant R410A.

AM***NLD*** / AM022/028/036*NMD***

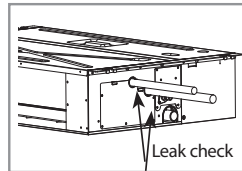

AM***NMD***/AM***NHD***

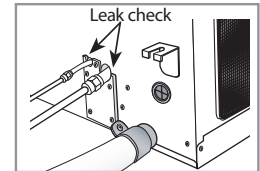

AM***MNL*EH***

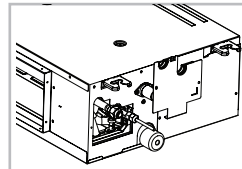

Discharge all the nitrogen to create a vacuum and charge the system.

Insulation

Once you have checked that there are no leaks in the system, you can insulate the piping and hose.

- To avoid condensation problems, place T13.0 or thicker Acrylonitrile Butadien Rubber separately around each refrigerant pipe.

Note Always make the seam of pipes face upwards.

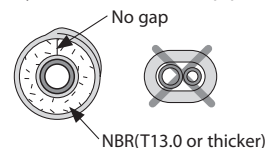

Drain pipe and Drain Hose Installation

AM****NLD*** / AM022/028/036*NMD***

1. Install the drain hose as short as possible.

- Note**
- ◆ In order to discharge condensation water, the drain hose should keep tilted.
 - ◆ Fix the drain hose with Cable-Tie, so that it will not separate from the machine.
 - ◆ The drain pump connection port is used when using a drain pump.

2. When there is no drain pump, Insulate and fix the drain hose according to the figure.

- Note**
- ◆ Lock steel ring of the drain hose according to the figure.
 - ◆ Wind and wrap steel ring and drain hose fully with thermal insulation sponge; fix both ends of external layer with ribbon for thermal insulation.

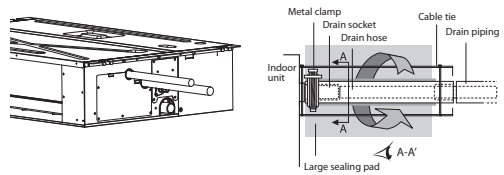

AM****NMD*** / AM****NHD***

1 Install the drain hose as short as possible.

- note**
- ◆ In order to discharge condensation water, the drain hose should keep tilted.
 - ◆ Secure the drain hose with the cable-tie not to be separated from the unit.
 - ◆ The drain pump connection port is used when using a drain pump.

2 When there is no draining pump, insulate the drain hose and then fix it as a picture.

- note**
- ◆ Insert the drain hose to bottom of the outfall of water basin.
 - ◆ Lock steel ring of the drain hose according to the figure.
 - ◆ Wind and wrap steel ring and drain hose fully with thermal insulation sponge; fix both ends of external layer with ribbon for thermal insulation.
 - ◆ After being installed, drain hose must be insulated fully by heat insulating material.(To be provided at site.)

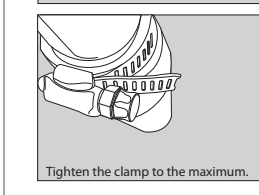
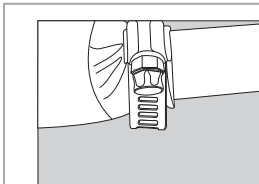
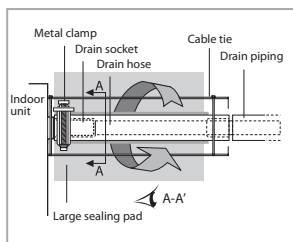

2. Wind insulating tape around the pipes and drain hose avoiding to compress the insulation too much.

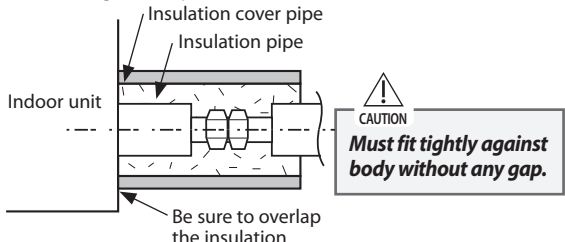

3. Finish wrapping insulating tape around the rest of the pipes leading to the outdoor unit.

4. The pipes and electrical cables connecting the indoor unit with the outdoor unit must be fixed to the wall with suitable ducts.

CAUTION

All refrigerant connection must be accessible, in order to permit either unit maintenance or removing it completely.

5. Select the insulation of the refrigerant pipe.

- ◆ Insulate the gas side and liquid side pipe referring to the thickness according to the pipe size.
- ◆ Indoor temperature of 30°C and humidity of 85% is the standard condition.
If install in a high humidity condition, use one grade thicker insulator by referring to the table below.
If installing in an unfavorable conditions, use thicker one.
- ◆ Insulator's heat-resistance temperature should be more than 120°C.

Pipe	Pipe size	Insulation Type(Heating/Cooling)		Remarks
		Standard [30°C,85%]	High humidity [30°C,over85%]	
Liqued pipe	Φ6.35~Φ9.52	9t	9t	Internal temperature is higher than 120°C
	Φ12.7~Φ50.80	13t	13t	
Gas Pipe	Φ6.35	13t	19t	
	Φ9.52	19t	25t	
	Φ12.70			
	Φ15.88			
	Φ19.05			
	Φ22.23			
	Φ25.40	32t		
	Φ28.58			
	Φ31.75			
	Φ38.10			
Φ44.45				
Φ50.80	25t	38t		

CAUTION

- ◆ **Install the insulation not to get wider and use the adhesives on the connection part of it to prevent moisture from entering.**
- ◆ **Wind the refrigerant pipe with insulation tape if it is exposed to outside sunlight.**
- ◆ **Install the refrigerant pipe respecting that the insulation does not get thinner on the bent part or hanger of pipe.**
- ◆ **Add the additional insulation if the insulation plate gets thinner.**

Drainpipe Connection

Without the drain pump

1. Install horizontal drainpipe with a slope of 1/100 or more and fix it by hanger space of 1.0~1.5m.
2. Install U-trap at the end of the drainpipe to prevent a nasty smell to reach the indoor unit.
3. Do not install the drainpipe to upward position. It may cause water flow back to the unit.

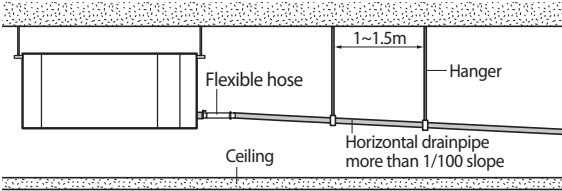

With the drain pump

1. The drain pipe should be installed within 300mm to 550mm from the flexible hose and then lift down 20mm or more.
2. Install horizontal drainpipe with a slope of 1/100 or more and fix it by hanger space of 1.0~1.5m.
3. Install the air vent in the horizontal drainpipe to prevent water flow back to the indoor unit.
Note You may not need to install it if there were proper slope in the horizontal drainpipe.
4. The flexible hose should not be installed upward position, it may cause water flow back to the indoor unit.

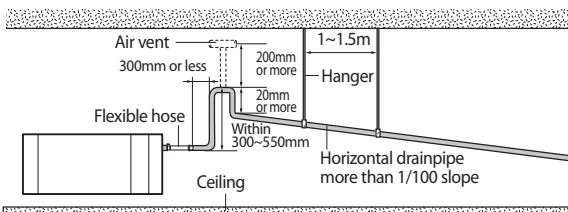

Centralized Drainage

Without the drain pump

1. Install horizontal drainpipe with a slope of 1/100 or more and fix it by hanger space of 1.0~1.5m.
2. Install U-trap at the end of the drainpipe to prevent a nasty smell to reach the indoor unit.

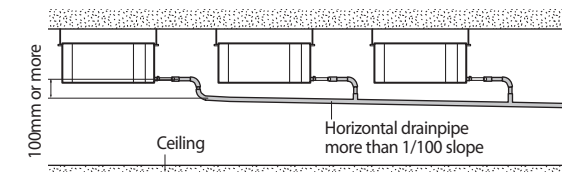

With the drain pump

1. Install main air vent at the front of the farthest indoor unit from the main drain when installed indoor units are more than 3.
2. You may need to install individual air vent to prevent water flow back at the top of each indoor unit drainpipe.

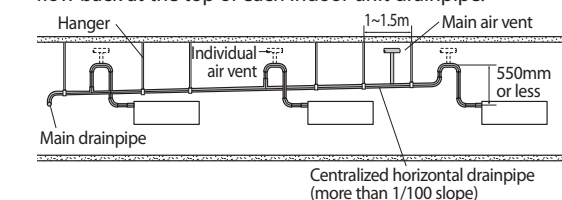

Wiring Work

Power and communication cable connection

1. Before wiring work, you must turn off all power source.
2. Indoor unit power should be supplied through the breaker(ELCB or MCCB+ELB) separated by the outdoor power.
ELCB: Earth Leakage Circuit Breaker
MCCB:Molded Case Circuit Breaker
ELB:Earth Leakage Breaker
3. The power cable should be used only copper wires.
4. Connect the power cable(1(L), 2(N)) among the units within maximum length and communication cable(F1, F2) each.
5. Connect F3, F4(for communication) when installing the wired remote Control.

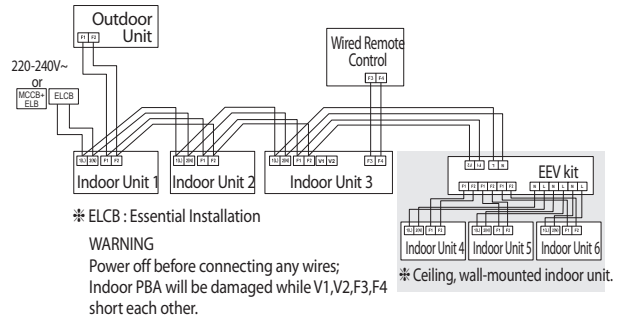

Selecting compressed ring terminal

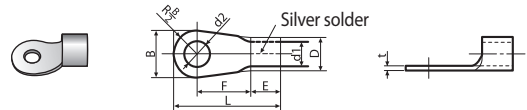

Nominal dimensions for cable (mm ²)	Nominal dimensions for screw (mm)	B		D		d1		E F L			d2		t
		Standard dimension (mm)	Allowance (mm)	Standard dimension (mm)	Allowance (mm)	Standard dimension (mm)	Allowance (mm)	Min.	Min.	Max.	Standard dimension (mm)	Allowance (mm)	
1.5	4	6.6	±0.2	3.4	+0.3 -0.2	1.7	±0.2	4.1	6	16	4.3	+0.2 0	0.7
	8												
2.5	4	6.6	±0.2	4.2	+0.3 -0.2	2.3	±0.2	6	6	17.5	4.3	+0.2 0	0.8
	8.5												
4	4	9.5	±0.2	5.6	+0.3 -0.2	3.4	±0.2	6	5	20	4.3	+0.2 0	0.9

Specification of electronic wire

Power supply	MCCB	ELB or ELCB	Power cable	Earth cable	Communication cable
Max : 242V Min : 198V	X A	X A, 30mA 0.1 s	2.5mm ²	2.5mm ²	0.75~1.5mm ²

- ◆ Decide the capacity of ELCB(or MCCB+ELB) by below formula.
- ◆ Power supply cords of parts of appliances for outdoor use shall not be lighter than polychloroprene sheathed flexible cord.
(Code designation IEC:60245 IEC 57 / CENELEC: H05RN-F or IEC:60245 IEC 66 / CENELEC: H07RN-F)

The capacity of ELCB(or MCCB+ELB) X [A] = 1.25 X 1.1 X ΣAi

- * X : The capacity of ELCB(or MCCB+ELB).
- * ΣAi : Sum of Rating currents of each indoor unit.
- * Refer to each installation manual about the rating current of indoor unit.
- ◆ Decide the power cable specification and maximum length within 10% power drop among indoor units.

$$\sum_{k=1}^n \left(\frac{\text{Coef} \times 35.6 \times L_k \times i_k}{1000 \times A_k} \right) < 10\% \text{ of input voltage[V]}$$

* Coef: 1.55

* L_k: Distance among each indoor unit[m],

A_k: Power cable specification[mm²], i_k: Running current of each unit[A]

Setting an indoor unit address and installation option

Set the indoor unit address and installation option with remote controller option.
Set the each option separately since you cannot set the ADDRESS setting and indoor unit installation setting option at the same time. You need to set twice when setting indoor unit address and installation option.

The procedure of option setting

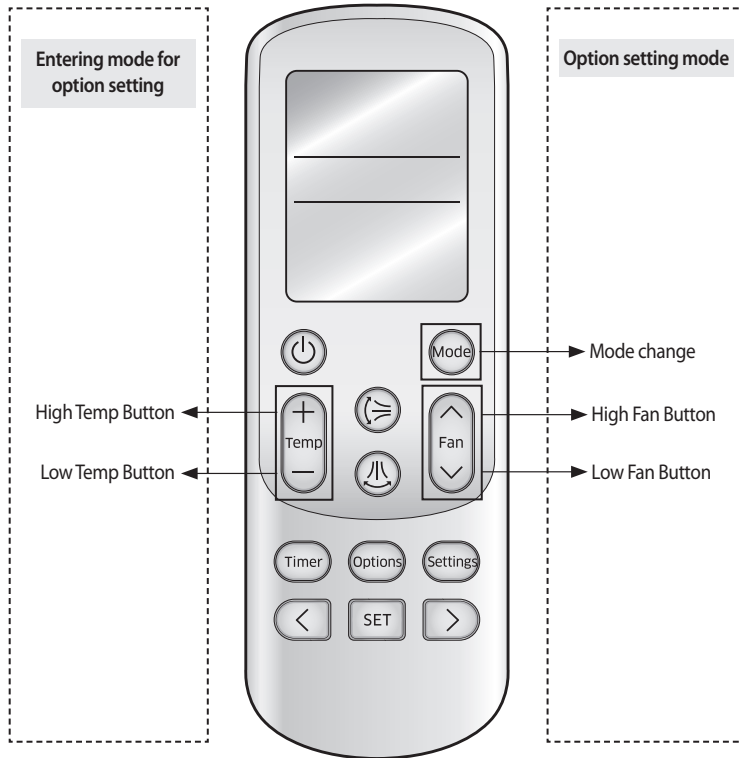

Step 1. Entering mode to set option

1. Remove batteries from the remote controller.
2. Insert batteries and enter the option setting mode while pressing High Temp button and Low Temp button.

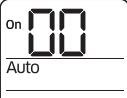
3.  Check if you have entered the option setting status.

Step 2. The procedure of option setting

After entering the option setting status, select the option as listed below.

- Option setting is available from SEG1 to SEG 24
- SEG1, SEG7, SEG13, SEG19 are not set as page option.
- Set the SEG2~SEG6, SEG8~SEG12 as ON status and SEG14~18, SEG20~24 as OFF status.



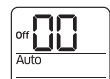





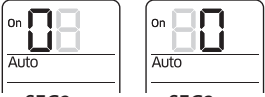

SEG1	SEG2	SEG3	SEG4	SEG5	SEG6	SEG7	SEG8	SEG9	SEG10	SEG11	SEG12
0	X	X	X	X	X	1	X	X	X	X	X
SEG13	SEG14	SEG15	SEG16	SEG17	SEG18	SEG19	SEG20	SEG21	SEG22	SEG23	SEG24
2	X	X	X	X	X	3	X	X	X	X	X

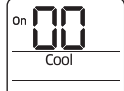
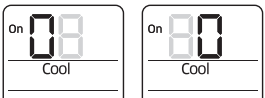

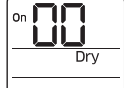
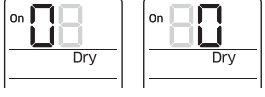

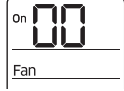
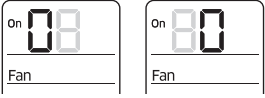

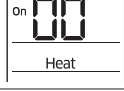
On(SEG1~12)	Off(SEG13~24)
	

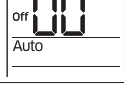
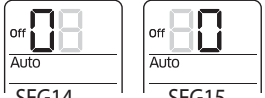

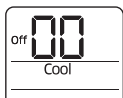
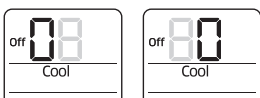
CAUTION

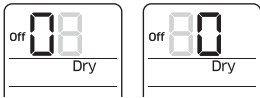
Setting an indoor unit address and installation option(Cont.)

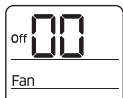
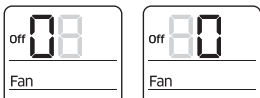
Option setting	Status
<p>1. Setting SEG2, SEG3 option</p> <p>Press Low Fan button(∨) to enter SEG2 value.</p> <p>Press High Fan button(∧) to enter SEG3 value.</p> <p>Each time you press the button, 0 → 8 → ... 8 → 0 will be selected in rotation.</p>	 <p>SEG2 SEG3</p>
<p>2. Setting Cool mode</p> <p> Press Mode button to be changed to Cool mode in the ON status.</p>	
<p>3. Setting SEG4, SEG5 option</p> <p>Press Low Fan button(∨) to enter SEG4 value.</p> <p>Press High Fan button(∧) to enter SEG5 value.</p> <p>Each time you press the button, 0 → 8 → ... 8 → 0 will be selected in rotation.</p>	 <p>SEG4 SEG5</p>
<p>4. Setting Dry mode</p> <p> Press Mode button to be changed to DRY mode in the ON status.</p>	
<p>5. Setting SEG6, SEG8 option</p> <p>Press Low Fan button(∨) to enter SEG6 value.</p> <p>Press High Fan button(∧) to enter SEG8 value.</p> <p>Each time you press the button, 0 → 8 → ... 8 → 0 will be selected in rotation.</p>	 <p>SEG6 SEG8</p>
<p>6. Setting Fan mode</p> <p> Press Mode button to be changed to FAN mode in the ON status.</p>	
<p>7. Setting SEG9, SEG10 option</p> <p>Press Low Fan button(∨) to enter SEG9 value.</p> <p>Press High Fan button(∧) to enter SEG10 value.</p> <p>Each time you press the button, 0 → 8 → ... 8 → 0 will be selected in rotation.</p>	 <p>SEG9 SEG10</p>
<p>8. Setting Heat mode</p> <p> Press Mode button to be changed to HEAT mode in the ON status.</p>	
<p>9. Setting SEG11, SEG12 option</p> <p>Press Low Fan button(∨) to enter SEG11 value.</p> <p>Press High Fan button(∧) to enter SEG12 value.</p> <p>Each time you press the button, 0 → 8 → ... 8 → 0 will be selected in rotation.</p>	 <p>SEG11 SEG12</p>
<p>10. Setting Auto mode</p> <p> Press Mode button to be changed to AUTO mode in the OFF status.</p>	
<p>11. Setting SEG14, SEG15 option</p> <p>Press Low Fan button(∨) to enter SEG14 value.</p> <p>Press High Fan button(∧) to enter SEG15 value.</p> <p>Each time you press the button, 0 → 8 → ... 8 → 0 will be selected in rotation.</p>	 <p>SEG14 SEG15</p>

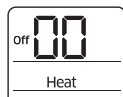
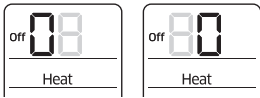
Option setting	Status
<p>12. Setting Cool mode</p> <p> Press Mode button to be change to Cool mode in the OFF status.</p>	
<p>13. Setting SEG16, SEG17 option</p> <p>Press Low Fan button(∨) to enter SEG16 value. Press High Fan button(∧) to enter SEG17 value. Each time you press the button, 0 → 1 → ... 9 → 0 will be selected in rotation.</p>	 <p style="text-align: center;">SEG16 SEG17</p>
<p>14. Setting Dry mode</p> <p> Press Mode button to be change to Dry mode in the OFF status.</p>	
<p>15. Setting SEG18, SEG20 option</p> <p>Press Low Fan button(∨) to enter SEG18 value. Press High Fan button(∧) to enter SEG20 value. Each time you press the button, 0 → 1 → ... 9 → 0 will be selected in rotation.</p>	 <p style="text-align: center;">SEG18 SEG20</p>
<p>16. Setting Fan mode</p> <p> Press Mode button to be change to Fan mode in the OFF status.</p>	
<p>17. Setting SEG21, SEG22 option</p> <p>Press Low Fan button(∨) to enter SEG21 value. Press High Fan button(∧) to enter SEG22 value. Each time you press the button, 0 → 1 → ... 9 → 0 will be selected in rotation.</p>	 <p style="text-align: center;">SEG21 SEG22</p>
<p>18. Setting Heat mode</p> <p> Press Mode button to be change to HEAT mode in the OFF status.</p>	
<p>19. Setting SEG23, SEG24 mode</p> <p>Press Low Fan button(∨) to enter SEG23 value. Press High Fan button(∧) to enter SEG24 value. Each time you press the button, 0 → 1 → ... 9 → 0 will be selected in rotation.</p>	 <p style="text-align: center;">SEG23 SEG24</p>

Step 3. Check the option you have set

After setting option, press  button to check whether the option code you input is correct or not.

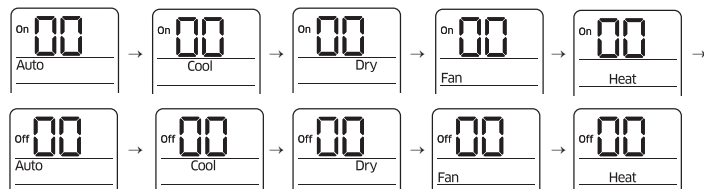

Step 4. Input option

Press operation button  with the direction of remote control for set.
For the correct option setting, you must input the option twice.

Step 5. Check operation

1. Reset the indoor unit by pressing the RESET button of indoor unit or outdoor unit.
2. Take the batteries out of the remote controller and insert them again and then press the operation button.

Setting an indoor unit address and installation option (Cont.)

Setting an indoor unit address (MAIN/RMC)

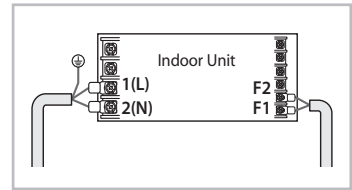

1. Check whether power is supplied or not.
 - When the indoor unit is not plugged in, there should be additional power supply in the indoor unit.
2. The panel(display) should be connected to an indoor unit to receive option.
3. Before installing the indoor unit, assign an address to the indoor unit according to the air conditioning system plan.
4. Assign an indoor unit address by wireless remote controller.
 - The initial setting status of indoor unit ADDRESS(MAIN/RMC) is "0A0000-100000-200000-300000".

Option No. : 0AXXXX-1XXXXX-2XXXXX-3XXXXX

Option	SEG1		SEG2		SEG3		SEG4		SEG5		SEG6	
Explanation	PAGE		Mode		Setting Main address		100-digit of indoor unit address		10-digit of indoor unit		The unit digit of an indoor unit	
Remote Controller Display												
Indication and Details	Indication	Details	Indication	Details	Indication	Details	Indication	Details	Indication	Details	Indication	Details
	0		A		0	No Main address						
					1	Main address setting mode	0~9	100-digit	0~9	10-digit	0~9	A unit digit
Option	SEG7		SEG8		SEG9		SEG10		SEG11		SEG12	
Explanation	PAGE				Setting RMC address				Group channel(*16)		Group address	
Remote Controller Display												
Indication and Details	Indication	Details	—		Indication	Details	—		Indication	Details	Indication	Details
	1				0	No RMC address						
					1	RMC address setting mode			RMC1	0~F	RMC2	0~F



- When "A"~"F" is entered to SEG5~6, the indoor unit MAIN ADDRESS is not changed.
- If you set the SEG 3 as 0, the indoor unit will maintain the previous MAIN ADDRESS even if you input the option value of SEG5~6.
- If you set the SEG 9 as 0, the indoor unit will maintain previous RMC ADDRESS even if you input the option value of SEG11~12.
- You cannot set SEG11 and SEG12 as F value at the same time.

Setting an indoor unit installation option

(suitable for the condition of each installation location)

1. Check whether power is supplied or not.
 - When the indoor unit is not plugged in, there should be additional power supply in the indoor unit.
2. The panel(display) should be connected to an indoor unit to receive option.
3. Set the installation option according to the installation condition of an air conditioner.
 - The default setting of an indoor unit installation option is "020010-100000- 200000-300000".
 - Individual control of a remote controller(SEG20) is the function that controls an indoor unit individually when there is more than one indoor unit.
4. Set the indoor unit option by wireless remote controller.

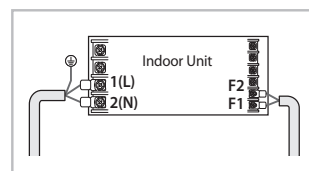

02 series installation option

SEG1	SEG2	SEG3	SEG4	SEG5	SEG6
0	2	--	External room temperature sensor / Minimizing fan operation when thermostat is off	Central control	FAN RPM compensation
SEG7	SEG8	SEG9	SEG10	SEG11	SEG12
1	Drain pump	Hot water heater	--	EEV Step when heating stops	--
SEG13	SEG14	SEG15	SEG16	SEG17	SEG18
2	External control	External control output / External heater On or Off signal	S-Plasma ion	Buzzer	Number of hours using filter
SEG19	SEG20	SEG21	SEG22	SEG23	SEG24
3	Individual control of a remote controller	Heating setting compensation / Removing condensated water in heating mode	EEV Step of stopped unit during oil return/ defrost mode	Motion detect sensor	--

- ◆ 1WAY/2WAY/4WAY MODEL : Drain pump(SEG8) will be set to 'USE + 3minute delay' even if the drain pump is set to 0.
- ◆ 1 WAY/2WAY/4WAY,DUCT MODEL : Number of hours using filter(SEG18) will be set to '1000hour' even if the SEG18 is set to except for 2 or 6.
- ◆ When setting the option other than above SEG values, the option will be set as "0".
- ◆ SEG5 central control option is basically set as 1 (Use), so you don't need to set the central control option additionally.
However, if the central control is not connected but it doesn't indicate an error message, you need to set the central control option as 0 (Disuse) to exclude the indoor unit from the central control.

Setting an indoor unit address and installation option (Cont.)

- The output of hot water heater in SEG9 is generated from the hot coil part of the terminal board in duct models.

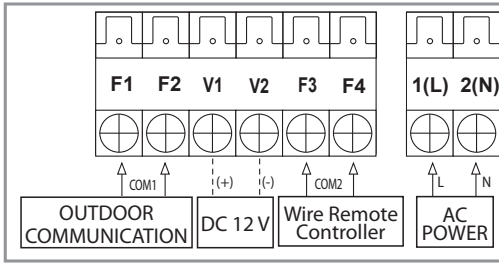

* The output of hot coil terminal is AC 220 V / 230 V
(The same as Indoor Unit's input Power)

- The external output of SEG15 is generated by MIM-B14 connection. (Refer to the manual of MIM-B14.)

02 series installation option(Detailed)

Option No. : 02XXXX-1XXXX-2XXXX-3XXXX

Option	SEG1		SEG2		SEG3		SEG4			SEG5		SEG6	
Explanation	PAGE		MODE		Use of robot cleaning		Use of external room temperature sensor / Minimizing fan operation when thermostat is off			Use of central control		FAN RPM compensation	
Remote Controller Display													
Indication and Details	Indication	Details	Indication	Details	Indication	Details	Indication	Details		Indication	Details	Indication	Details
								Use of External room temperature sensor	Minimizing fan operation when thermostat is off				
	0	2	0	Disuse	0	Disuse	1	Use	Disuse	0	Disuse	1	RPM compensation
					2	Disuse	Use ⁽¹⁾	1	Use				2
				1	Use	3	Use			Use ⁽¹⁾			
Option	SEG7		SEG8		SEG9		SEG10			SEG11		SEG12	
Explanation	PAGE		Use of drain pump		Use of hot water heater					EEV Step when heating stops			
Remote Controller Display													
Indication and Details	Indication	Details	Indication	Details	Indication	Details	Indication	Details		Indication	Details	Indication	Details
	1		0	Disuse	0	Disuse				0	Default value		
		2	When an indoor unit stops, drain pump will operate for 3min	2	--								
		3		3	Use ⁽²⁾								

Option	SEG13		SEG14		SEG15			SEG16		SEG17		SEG18	
Explanation	PAGE		Use of external control		Setting the output of external control / External heater On/Off signal			S-Plasma ion		Buzzer control		Hours of filter usage	
Remote Controller Display													
Indication and Details	Indication	Details	Indication	Details	Indication	Details		Indication	Details	Indication	Details	Indication	Details
						Setting the output of external control	External heater On/Off signal						
	2	0	Disuse	0	Thermo on	-	0	Disuse	0	Use buzzer	2	1000 Hour	
		1	ON/OFF control	1	Operation on	-	1	Use	1	Disuse buzzer	6	2000 Hour	
		2	OFF control	2	-	Use ^(*)							
3	Window ON/OFF control	3	-	Use ^(*)									
Option	SEG19		SEG20		SEG21			SEG22		SEG23		SEG24	
Explanation	PAGE		Individual control of a remote controller		Heating setting compensation / Removing condensated water in heating mode			EEV Step of stopped unit during oil return/ defrost mode		Motion detect sensor		-	
Remote Controller Display													
Indication and Details	Indication	Details	Indication	Details	Indication	Details		Indication	Details	Indication	Details	Indication	Details
						Heating Setting Compensation	Removing Condensated Water in Heating Mode						
	3	0 or 1	channel 1	0	Default ^(*)	Disuse	0	Default value	0	Disuse	1	Turn out in 30min. without motion	
				2	channel 2	1			2 °C	Disuse	2	Turn out in 60min. without motion	
				3	channel 3	2			5 °C	Disuse	3	Turn out in 120min. without motion	
		4	channel 4	3	Default ^(*)	Use ^(*)	1	Oil return or Noise decreasing in defrost mode	4	Turn out in 180min. without motion			
				4	2 °C	Use ^(*)			5	Turn out in 30min. without motion or *advanced function			
				5	5 °C	Use ^(*)			6	Turn out in 60min. without motion or *advanced function			
		7	Turn out in 120min. without motion or *advanced function										
		8	Turn out in 180min. without motion or *advanced function										

Setting an indoor unit address and installation option (Cont.)

* Advanced function: Controlling cooling/heating current or power saving with motion detect.

(*1) Minimizing fan operation when thermostat is off

- Fan operates for 20 seconds at an interval of 5 minutes in heat mode.

(*2) 1: Fan is turned on continually when the hot water heater is turned on,

3: Fan is turned off when the hot water heater is turned on with cooling only indoor unit

Cooling only indoor unit: To use this option, install the Mode Select switch (MCM-C200) on the outdoor unit and fix it as cool mode.

(*3) When the following 2 or 3 is used as external heater On/Off signal, the signal for monitoring external contact control will not be output.

2: Fan is turned on continually when the external heater is turned on,

3: Fan is turned off when the external heater is turned on with cooling only indoor unit

Cooling only indoor unit: To use this option, install the Mode Select switch (MCM-C200) on the outdoor unit and fix it as cool mode.

- If Fan is set to off for cooling only indoor unit by setting the SEG9=3 or SEG15=3, you need to use an external sensor or wired remote controller sensor to detect indoor temperature exactly.

(*4) Default setting value

- 4Way Cassette, Mini 4Way Cassette: 5 °C

- Other indoor units: 2 °C

(*5) This function can be applied to 4 Way Cassette and Mini 4 Way Cassette only. If the air conditioner operates the heating mode immediately after finishing the cooling mode, the condensated water in the drain pan becomes water vapor by the heat of the indoor unit heat exchanger. Since the water vapor might be condensed on the indoor unit, which may fall into a living space, use this function to get rid of the water vapor out of the indoor unit by operating the fan (for maximum 20 minutes) even when the indoor unit is turned off after cooling mode is turned to heating mode.

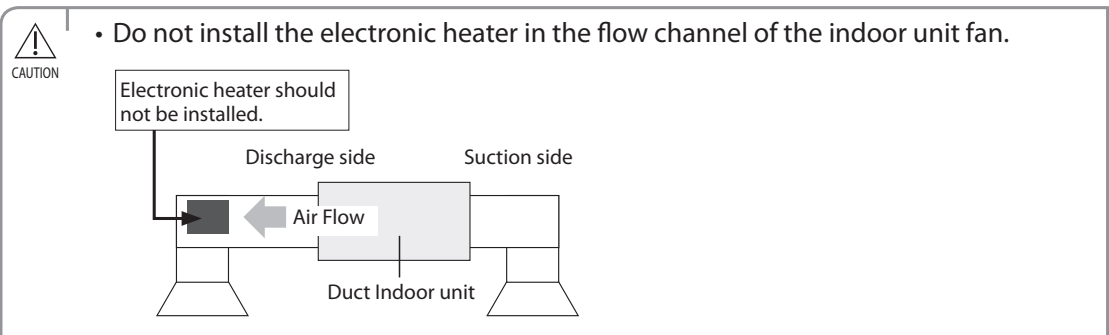

■ 05 series installation option

SEG1	SEG2	SEG3	SEG4	SEG5	SEG6
0	5	Use of Auto Change Over for HR only in Auto mode	(When setting SEG3) Standard heating temp. Offset	(When setting SEG3) Standard cooling temp. Offset	(When setting SEG3) Standard for mode change Heating → Cooling
SEG7	SEG8	SEG9	SEG10	SEG11	SEG12
1	(When setting SEG3) Standard for mode change Cooling → Heating	(When setting SEG3) Time required for mode change	Compensation option for Long pipe or height difference between indoor units	-	-
SEG13	SEG14	SEG15	SEG16	SEG17	SEG18
2	-	-	-	-	Control variables when using hot water / external heater
SEG19	SEG20	SEG21	SEG22	SEG23	SEG24
3	-	-	-	-	-

■ 05 series installation option(Detailed)

Option No. : 05XXXX-1XXXXX-2XXXXX-3XXXXX

Option	SEG1		SEG2		SEG3		SEG4		SEG5		SEG6			
Explanation	PAGE		MODE		Use of Auto Change Over for HR only in Auto mode		(When setting SEG3) Standard heating temp. Offset		(When setting SEG3) Standard cooling temp. Offset		(When setting SEG3) Standard for mode change Heating → Cooling			
Remote Controller Display														
Indication and Details	Indication	Details	Indication	Details	Indication	Details	Indication	Details	Indication	Details	Indication	Details		
	0		5		0	Follow product option	0	0°C	0	0°C	0	1°C		
					1	Use Auto Change Over for HR only	1	1.5°C	1	0.5°C	1	0.5°C	1	1.5°C
							2	2°C	2	1°C	2	1°C	2	2°C
							3	2.5°C	3	1.5°C	3	1.5°C	3	2.5°C
							4	3°C	4	2°C	4	2°C	4	3°C
							5	3.5°C	5	2.5°C	5	2.5°C	5	3.5°C
							6	4°C	6	3°C	6	3°C	6	4°C
7							4.5°C	7	3.5°C	7	3.5°C	7	4.5°C	
Option	SEG7		SEG8		SEG9		SEG10		SEG11		SEG12			
Explanation	PAGE		(When setting SEG3) Standard for mode changing Cooling → Heating mode		(When setting SEG3) Time required for mode change		Compensation option for Long pipe or height difference between indoor units							
Remote Controller Display														
Indication and Details	Indication	Details	Indication	Details	Indication	Details	Indication	Details						
	1		0	1°C	0	5 min.	0	Use default value						
			1	1.5°C	1	7 min.	1	1) Height difference ¹⁾ is more than 30m or 2) Distance ²⁾ is longer than 110m						
			2	2°C	2	9 min.								
			3	2.5°C	3	11 min.								
			4	3°C	4	13 min.	2	1) Height difference ¹⁾ is 15~30m or 2) Distance ²⁾ is 50~110m						
			5	3.5°C	5	15 min.								
			6	4°C	6	20 min.								
7			4.5°C	7	30 min.									

Setting an indoor unit address and installation option (Cont.)

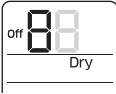
Option	SEG13	SEG14	SEG15	SEG16	SEG17	SEG18 ^{(*)3}					
Explanation						Control variables when using hot water / external heater					
Remote Controller Display											
Indication and Details	2							Indication	Details		
									Set temp. for heater On/Off		Delay time for heater On
									0	At the same time as thermo on	No delay
									1	At the same time as thermo on	10 minutes
									2	At the same time as thermo on	20 minutes
									3	1.5 °C	No delay
									4	1.5 °C	10 minutes
									5	1.5 °C	20 minutes
									6	3.0 °C	No delay
									7	3.0 °C	10 minutes
									8	3.0 °C	20 minutes
									9	4.5 °C	No delay
									A	4.5 °C	10 minutes
									B	4.5 °C	20 minutes
C	6.0 °C	No delay									
D	6.0 °C	10 minutes									
E	6.0 °C	20 minutes									

(*1) Height difference : The difference of the height between the corresponding indoor unit and the indoor unit installed at the lowest place.
For example, When the indoor unit is installed 40m higher than the indoor unit installed at the lowest place, select the option "1".

(*2) Distance : The difference between the pipe length of the indoor unit installed at farthest place from an outdoor unit and the pipe length of the corresponding indoor unit from an outdoor unit.
For example, when the farthest pipe length is 100 m(328 ft) and the corresponding indoor unit is 40 m away from an outdoor unit, select the option "2".
(100 - 40 = 60m)

(*3) Heater operation when the SEG9 of 02 series installation option is set to using hot water heater or when SEG15 is set to using external heater

e.g. 1) Setting 02 series SEG9 = "1" / Setting 05 series SEG18 = "0": Hot water heater is turned on at the same time as the heating thermostat is on, and turned off when the heating thermostat is off.

e.g. 2) Setting 02 series SEG15 = "2" / Setting 05 series SEG18 = "A":

Room temp. ≤ set temp. + f(heating compensation temp.)

- External heater is turned on when the temperature is maintained as 4.5 °C for 10 minutes.

Room temp. > set temp. + f(heating compensation temp.)

- External heater is turned off when the temperature is maintained as 4.5 °C + 1 °C (1 °C is the Hysteresis for On/Off selection.)

SEG 3, 4, 5, 6, 8, 9 additional information

When the SEG 3 is set as "1" and follow Auto Change Over for HR only operation, it will operate as follows.

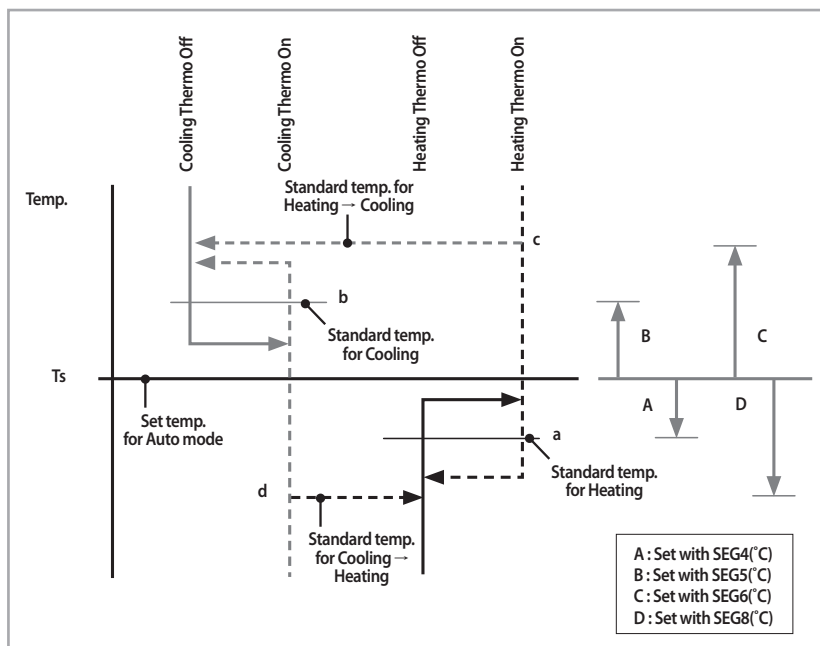

Cooling/Heating mode can be changed when Thermo Off status is maintained during the time with SEG9.

Changing a particular option

You can change each digit of set option.

Option	SEG1		SEG2		SEG3		SEG4		SEG5		SEG6	
Explanation	PAGE		MODE		The option mode you want to change		The tens' digit of an option SEG you will change		The unit digit of an option SEG you will change		The changed value	
Remote Controller Display												
Indication and Details	Indication	Details	Indication	Details	Indication	Details	Indication	Details	Indication	Details	Indication	Details
	0		D		Option mode	1~6	Tens' digit of SEG	0~9	Unit digit of SEG	0~9	The changed value	0~F

- Note**
- When changing a digit of an indoor unit address setting option, set the SEG3 as 'A'.
 - When changing a digit of indoor unit installation option, set the SEG3 as '2'.

Ex) When setting the 'buzzer control' into disuse status.

Option	SEG1	SEG2	SEG3	SEG4	SEG5	SEG6
Explanation	PAGE	MODE	The option mode you want to change	The tens' digit of an option SEG you will change	The unit digit of an option SEG you will change	The changed value
Indication	0	D	2	1	7	1

QUESTIONS OR COMMENTS?

COUNTRY	CALL	OR VISIT US ONLINE AT
AUSTRIA	0800-SAMSUNG (0800-7267864) [Only for KNOX customers] 0800 400848 [Only for Premium HA] 0800-366661 [Only for Dealers] 0810-112233 [Only for E-Store] 0800 100 232	www.samsung.com/at/support
	02-201-24-18	www.samsung.com/be/support (Dutch) www.samsung.com/be_fr/support (French)
	055 233 999	www.samsung.com/support
	*3000 Цена в мрежата 0800 111 31 , Безплатна телефонна линия	www.samsung.com/bg/support
CROATIA	072 726 786	www.samsung.com/hr/support
CZECH	800 - SAMSUNG (800-726786)	www.samsung.com/cz/support
DENMARK	707 019 70	www.samsung.com/dk/support
FINLAND	030-6227 515	www.samsung.com/fi/support
FRANCE	01 48 63 00 00	www.samsung.com/fr/support
GERMANY	06196 77 555 66 *HHP 06196 77 555 77 *OTH	www.samsung.com/de/support
CYPRUS	8009 4000 only from landline, toll free	
GREECE	80111-SAMSUNG (80111 726 7864) only from land line (+30) 210 6897691 from mobile and land line	www.samsung.com/gr/support
HUNGARY	0680SAMSUNG (0680-726-7864)	www.samsung.com/hu/support
ITALIA	800-SAMSUNG (800.7267864)	www.samsung.com/it/support
LUXEMBURG	261 03 710	www.samsung.com/be_fr/support
MONTENEGRO	020 405 888	www.samsung.com/support
SLOVENIA	080 697 267 (brezplačna številka)	www.samsung.com/si
NETHERLANDS	088 90 90 100	www.samsung.com/nl/support
NORWAY	21629099	www.samsung.com/no/support
POLAND	801-172-678* lub +48 22 607-93-33* Dedykowana infolinia do obsługi zapytań dotyczących telefonów komórkowych: 801-672-678* lub +48 22 607-93-33* * (opłata według taryfy operatora)	www.samsung.com/pl/support
PORTUGAL	808 207 267	www.samsung.com/pt/support
ROMANIA	*8000 (apel in retea) 08008-726-78-64 (08008-SAMSUNG) Apel GRATUIT	www.samsung.com/ro/support
SERBIA	011 321 6899	www.samsung.com/rs/support
SLOVAKIA	0800 - SAMSUNG(0800-726 786)	www.samsung.com/sk/support
SPAIN	0034902172678 [HHP] 0034902167267	www.samsung.com/es/support
SWEDEN	0771 726 786	www.samsung.com/se/support
SWITZERLAND	0800 726 78 64 (0800-SAMSUNG)	www.samsung.com/ch/support (German) www.samsung.com/ch_fr/support (French)
UK	0330 SAMSUNG (7267864)	www.samsung.com/uk/support
IRELAND (EIRE)	0818 717100	www.samsung.com/ie/support
LITHUANIA	8-800-77777	www.samsung.com/lt/support
LATVIA	8000-7267	www.samsung.com/lv/support
ESTONIA	800-7267	www.samsung.com/ee/support
RUSSIA	8-800-555-55-55 (VIP care 8-800-555-55-88)	www.samsung.com/ru/support
GEORGIA	0-800-555-555	www.samsung.com/support
ARMENIA	0-800-05-555	www.samsung.com/support
AZERBAIJAN	0-88-555-55-55	www.samsung.com/support
KAZAKHSTAN	8-10-800-500-55-500 (GSM: 7799, VIP care 7700)	www.samsung.com/kz_ru/support
UZBEKISTAN	00-800-500-55-500 (GSM: 7799)	www.samsung.com/support
KYRGYZSTAN	00-800-500-55-500 (GSM: 9977)	www.samsung.com/support
TAJIKISTAN	8-10-800-500-55-500 (GSM: 8888)	www.samsung.com/support
MONGOLIA	1800-25-55	www.samsung.com/support
BELARUS	810-800-500-55-500	www.samsung.com/support
UKRAINE	0-800-502-000	www.samsung.com/ua/support (Ukrainian)
		www.samsung.com/ua_ru/support (Russian)

COUNTRY	CALL	OR VISIT US ONLINE AT
MOLDOVA	0-800-614-40	www.samsung.com/support
U.A.E	800-SAMSUNG (800 - 726 7864)	
OMAN	800-SAM CS (800-72627)	www.samsung.com/ae/support (English)
KUWAIT	183-CALL (183-2255)	www.samsung.com/ae_ar/support (Arabic)
BAHRAIN	8000-GSAM (8000-4726)	
QATAR	800-CALL (800-2255)	
EGYPT	08000-7267864 16580	www.samsung.com/eg/support
ALGERIA	3004	www.samsung.com/n_africa/support
PAKISTAN	0800-Samsung (72678)	www.samsung.com/pk/support
TUNISIA	80 1000 12	www.samsung.com/n_africa/support
JORDAN	0800-22273 06 5777444	www.samsung.com/levant
SYRIA	962 5777444	
IRAN	021-8255 [CE] 021-42132 [HHP]	www.samsung.com/iran/support
MOROCCO	080 100 22 55	www.samsung.com/n_africa/support
SAUDI ARABIA	(+966) 8002474357 (800 24/7 HELP)	www.samsung.com/sa_en/support (English) www.samsung.com/sa/support (Arabic)
TURKEY	444 77 11	www.samsung.com/tr/support
ARGENTINA	0800-555-SAMS(7267)	www.samsung.com/ar
URUGUAY	0800-SAMS(7267)	www.samsung.com/uy
PARAGUAY	0800-11-SAMS(7267)	www.samsung.com/py
BRAZIL	0800-124-421 (Demais cidades e regiões) 4004-0000 (Capitais e grandes centros)	www.samsung.com/br/support
CHILE	800-SAMSUNG(726-7864) [HHP] 2-2482 8200	www.samsung.com/cl/support
BOLIVIA	800-10-7260	www.samsung.com/cl/support
COLOMBIA	Bogotá en el 600 12 72 Sin costo en todo el país 01 8000 112 112 Y desde tu celular #726	www.samsung.com/co/support
COSTA RICA	00-800-1-SAMSUNG (726-7864)	
DOMINICAN REPUBLIC	1-809-200-7264	www.samsung.com/latin/support (Spanish)
ECUADOR	1-800-SAMSUNG (72-6786)	www.samsung.com/latin_en/support (English)
EL SALVADOR	8000-SAMSUNG (726-7864)	
GUATEMALA	1-800-299-0033	
HONDURAS	800-2791-9111	www.samsung.com/latin_en/support (English)
JAMAICA	1-800-SAMSUNG (726-7864)	
NICARAGUA	001-800-5077267	www.samsung.com/latin/support (Spanish)
PANAMA	800-0101	www.samsung.com/latin_en/support (English)
PUERTO RICO	1-800-682-3180	
TRINIDAD & TOBAGO	1-800-SAMSUNG(726-7864)	
PERU	080077708 Desde teléfonos fijos, públicos o celulares	www.samsung.com/pe/support
VENEZUELA	0-800-SAMSUNG (726-7864)	www.samsung.com/latin/support (Spanish) www.samsung.com/latin_en/support (English)
AUSTRALIA	1300 362 603 (Other) 1300 425 299 (HHP) Only for HHP PRODUCT : 02-422-2177 [Standard Landline] OTH PRODUCT :	www.samsung.com/au/support
PHILIPPINES	1-800-10-726-7864 [PLDT Toll Free] 1-800-8-726-7864 [Globe Landline and Mobile] 02-422-2111 [Standard Landline]	www.samsung.com/ph/support
SINGAPORE	1800 7267864 1800-SAMSUNG (Other) 1800 4252997 1800-GALAXYS (HHP)	www.samsung.com/sg/support

SAMSUNG ELECTRONICS CO.,LTD.

No.501 Suhong East Road,Suzhou Industrial Park,Jiangsu Province,P.R.China

Samsung Electronics

Service Department

PO Box 12987, Blackrock, Co. Dublin, Ireland

or

Blackbushe Business Park, Yateley, GU46 6GG, UK



DB68-03635A-15



Duct Type Series

Slim duct : AM*****NLD***

AM022/028/036*NMD***

Ma duct : AM*****NMD***

HSP duct : AM*****NHD***

Home duct : AM*****MNLD**

Air Conditioner user manual

imagine the possibilities

Thank you for purchasing this Samsung product.

SAMSUNG