

INDOOR UNIT

AM017/022HN1DEH/EU
 AM022/028/036FN1DEH/EU
 AM071JN1DEH/EU, AM056/071FN2DEH/EU
 AM045/056/071/090/112/128/140/FN4DEH/EU
 AM045/056/071/090/112/128/140/FN4DEH/AR
 AM045/056/071/090/112/128/140KN4DEH/EU
 AM022/028/036/045/056/060FNNDEH/EU
 AM015HNNDEH/EU
 AM112/128/140/220/280FNHDEH/EU
 AM036/056/071FNFDEH/EU
 AM050/100FNKDEH/EU
 AM017/022/028/036/045/056/071/090/112/128/140FNLDEH/EU
 AM022/028/036/045/056/071/090/112/128/140FNMDEH/EU
 AM056/071FNCDEH/EU
 AM028/036/056FNUDEH/EU
 AM022/028/036/056/071FNTDEH/EU
 AM015HNTDEH/EU
 AM022/028/036/045/056/071FNQDEH/EU
 AM015HNQDEH/EU
 AM160FNBFBEB/EU, 250FNBFBEB/EU
 AM160FNBFBEB/EU, 250FNBFBEB/EU
 AM160FNBDEH/EU, 320FNBDEH/EU, 500FNBDEH/EU
 AM036/045/056/071/090/112/128/140HNMPKH/EU
 AM112/128/140HNHPKH/EU
 AM180/224JNHFKH/EU

AM112/140JNC DKH/EU
 AM015/022/028/036/045/056/071/082JNV DKH/EU
 AM015/022/028/036/045/056/071/082JNADKH/EU
 AM015/022/028/036/045/056/071/082JNVDEH/TK
 AM036FN1DEH/TL
 AM056/071FN1DEH/TL
 AM056/071FN2DEH/TL
 AM045/056/071/090/112/128/140FN4DEH/TL
 AM045/056/071/090/112/128/140FN4DEH/TS
 AM045/056/071/090/112/128/140KN4DEH/TL
 AM022/028/036/045/056/060FNNDEH/TL
 AM022/028/036/045/056/071FNLDEH/TL
 AM056/071/090/112/128/140FNMDEH/TL
 AM022/028/036/045/056/071/082JNV DKH/TL
 AM140/220/280JNEPEH/EU
 AM012/018/024/030/036/048/054/060/072JNZDCH/AA
 AM160KNMDEH/EU, AM022/045KNJDEH/EU
 AM140/280JNPDKH/TK
 AM015/022/028/036/045/056/071KNTDEH/EU
 AM015/022/028/036/045/056/071KNQDEH/EU
 AM022/028/036/045/056/071KNQDEH/TL
 AM007/009/012/018/020/024KNTDCH/TC
 AM007/009/012/018/020/024KNQDCH/TC
 AM017/022/028/036KNLDEH/EU
 AM045/056/071/090/112/128/140KN4DEH/AR

AM022/028/036KNLDEH/TK
 AM022/028/036KNLDEH/TL
 AM036/056/071MNFDEH/EU
 AM140/220/280MNEPEH/EU, AM093MNQDEH/EU
 AM093MNQDEH/TK
 AE022/028/036/056MNLDEH/EU
 AE071/090MNMPEH/EU
 AE022/028/036/056/071MNADEH/EU
 AE022/028/036/056MNJDEH/EU
 AM017/022NN1PEH/EU
 AM022/028/036/056/071NN1DEH/**
 AM022/028/036/045/056/071/082JNADKH/TS
 AM022/028/036/045/056/071/082JNV DKH/TS
 AM093MNQDEH/TS
 AM022/028/036/045/056/060FNNDEH/TS
 AM112/128/140FNHDEH/TS
 AM180/224JNHFKH/TS
 AM036/045/056/071/090/112/128/140HNMPKH/TS
 AM112/128/140HNHPKH/TS
 AM022/028/036/045/056/071/090/112/128/140KNMDEH/TS
 AM160KNMDEH1TS
 AM017/022/028/036/045/056/071/090/112/128/140KNLDEH/TS
 AM056/071FNCDEH/TS
 AM112/140JNC DKH/TS
 AM028/036/045HNNDEH/TL

SERVICE Manual

SYSTEM AIRCONDITIONER



CONTENTS

1. Precautions
2. Product Specifications
3. Disassembly and Reassembly
4. Troubleshooting
5. PCB Diagram and Parts List
6. Wiring Diagram
7. Reference Sheet

Contents

1. Precautions	1
1-1 Precautions for the Service.....	1
1-2 Precautions for the Static Electricity and PL.....	1
1-3 Precautions for the Safety.....	1
1-4 Precautions for Handling Refrigerant for Air Conditioner.....	2
1-5 Precautions for Welding the Air Conditioner Pipe.....	2
1-6 Precautions for Additional Supplement of Air Conditioner Refrigerant.....	2
1-7 Other Precautions.....	2
2. Product Specifications	3
2-1 Product Specifications	3
2-1-1 Indoor Unit.....	3
■ Slim 1way cassette type.....	3
■ 2 way cassette type.....	7
■ 4 way cassette.....	8
■ Global 4Way Cassette(600x600).....	10
■ 4Way Cassette(600x600).....	12
■ Slim duct.....	13
■ Slim Home Duct.....	15
■ Duct Type (Uplevel Static Pressure).....	16
■ MSP duct.....	17
■ 360 cassette.....	19
■ Big Duct.....	21
■ GD-S(Big Duct).....	22
■ HSP Duct.....	23
■ Global Duct.....	24
■ Global Duct (cont.).....	27
■ Ceiling type.....	29
■ Big Ceiling.....	30
■ Console type.....	31
■ Wall Mounted type(Neo Forte without EEV).....	32
■ Wall Mounted type(Neo Forte with EEV).....	34
■ Wall Mounted type(Boracay with EEV).....	36
■ Wall Mounted type(Boracay without EEV).....	38
■ Wall Mounted type(Boracay with EEV).....	40
■ Wall mounted type(Boracay without EEV).....	44
■ Floor Standing Type.....	46
■ Floor Standing Type.....	47
■ ERV Plus.....	48
■ Hydro Unit.....	49
■ Hydro unit HT.....	50
■ Wall Mounted type(A3050 With EEV).....	51
■ Wall Mounted type(A3050 With EEV).....	53
■ Wall Mounted type(A3050 Without EEV).....	55
■ Wall Mounted type (MAX With EEV).....	57
■ Fresh Air Duct.....	58
■ V-AHU.....	59
■ OAP DUCT.....	63
■ EHS TDM PLUS - SLIM DUCT.....	64
■ EHS TDM PLUS - GLOBAL DUCT.....	65
■ EHS TDM PLUS - Console type.....	66
■ EHS TDM PLUS -Wall Monuted type.....	67
2-2 Accessory and Option Specifications	69
2-2-1 Accessories.....	69
3. Disassembly and Reassembly	72
■ Necessary Tools.....	72
3-1 Indoor Unit	73

Contents

■ AM017/022HN1DEH/EU	73
■ AM017/022NN1PEH/EU	76
■ Slim 1 way cassette type	83
■ AM022/028/036NN1DEH/EU	85
■ AM056/071NN1DEH/EU	88
■ AM052/060/072FN1DBH, AM052/060/072HN1DBH1, AM056/071FN1DEH, AM056/071JN1DEH	98
■ BIG DUCT	105
■ GD-S(Big Duct) - AM180JNHFKH/AM224JNHFKH	108
■ Global 4way Cassette type	119
■ Duct type(Slim1,2)	134
■ Duct type(Slim3)	139
■ Slim Home Duct	146
■ Duct type(Mid pressure1)	151
■ Duct type (Mid Pressure2, High Pressure)	156
■ AM036/045/056/071/090/112/128/140HNMPKH, AM112/128/140HNHPKH/EU, AE071/090MNMPEH/EU	161
■ CEILING	166
■ AM112/140JNCDKH/EU	175
■ CONSOLE	180
■ ERV PLUS	185
■ Floor Standin Type	194
■ Wall mount type	198
■ Wall Mounted type (Boracay)	201
■ Wall Mounted type (MAX)	205
■ Global 4Way Cassette type(600x600)	213
■ AM160FNBDEH/320FNBDEH/500FNBDEH	219
■ AM160/250FNBFEH, AM160/250FNBFBG	223
■ Wall Mounted type(A3050)	229
■ OAP DUCT	238
■ OAP Duct (AM140MNEPEH/EU)	240
■ OAP Duct (AM220/280MNEPEH/EU)	247
■ V-AHU	252
■ AM280JNPDKH/TK	257
■ AM140JNPDKH/TK	263
■ 4Way Cassette type(600x600)	271

4. Troubleshooting..... 274

4-1 Check-up Window Description	274
4-2 Service Operation	275
4-2-1 Special Operation	275
4-2-2 DVM S Models EEPROM Code Table	279
4-3 Troubleshooting	280
4-3-1 Setting Option Setup Method	280
4-3-2 Option Items	296
4-3-3 What to check before diagnosis	304
- Floor Standing type	316
- ERV Plus type	318
- Hydro unit / Hydro unit HT	319
4-3-4 Number Display Method (Outdoor Unit, MCU, Cable remote control, wall-mount, etc.)	320
4-4 Appropriate Measures for Different Symptom	326
4-4-1 Outdoor Unit Operation Flow	326
4-4-2 Main PCB has no power phenomenon	327
4-4-3 Indoor Unit ROOM sensor Error (Open/Short)	328
4-4-4 Indoor unit EVAP IN sensor Error (Open/Short)	329
4-4-5 Indoor EVAP OUT sensor Error (Open/Short)	330
4-4-6 Indoor Heat Exchanger's EVAP IN sensor dislocation error	331
4-4-7 Indoor Heat Exchanger's EVA OUT sensor dislocation error (Open/Short)	332
4-4-8 Simultaneous Indoor Heat Exchanger's EVA IN, OUT sensor dislocation error (Open/Short)	333
4-4-9 Electronic Expansion Valve opening malfunction (2nd stage) - E 135	334
4-4-10 Breakdown of EEV (2 nd)	335

Contents

4-4-11 Problem with EEV closure (2 nd).....	336
4-4-12 EEV(Electronic Expansion Valve) opening malfunction (2nd stage)	337
4-4-13 <i>E 152</i> : EEV(Electronic Expansion Valve) closure malfunction (2nd stage)	338
4-4-14 <i>E 153</i> : Detection of Floating Switch of Indoor Unit's Drain Pump.....	339
4-4-15 The operational error of Indoor Unit's Fan Motor	340
4-4-16 Mixed operation Error (Only applicable to Heat Pump Model/Not to HR model).....	341
4-4-17 EEPROM error	342
4-4-18 Option error of the Remote Controller for an Indoor Unit	343
4-4-19 Error due to confused use of Fahrenheit and Celsius	343
4-4-20 Simultaneous opening of Cooling/heating MCU SOL Valves 1 st /2 nd	344
4-4-21 Error due to incorrect Indoor Unit Power/Communication Cable Connection	345
4-4-22 SPI Feedback Error.....	346
4-4-23 Outdoor Unit Pipe Inspection Error.....	347
4-4-24 Communication Error between Indoor and Outdoor Units during Tracking.....	348
4-4-25 Communication Error between Indoor and Outdoor Units after Tracking.....	349
4-4-26 Communication error between main and sub Unit of outdoor unit or between outdoor units	350
4-4-27 Communication Error between MCU and Outdoor Unit	351
4-4-28 Internal Communication error of the Outdoor Unit C-Box.....	352
4-4-29 Internal PCB Communication error of the Outdoor Unit C-Box.....	353
4-4-30 Communication Error between MCU and Outdoor Unit after Tracking is Completed	354
4-4-31 MCU branch part setup error – inconsecutive connection with the use of 2 branch parts.....	355
4-4-32 MCU branch part setup error – Repeated setup for the same address over 3 times	356
4-4-33 MCU branch part setup error – non-installed address setup	357
4-4-34 Setup Error for MCU Branch part – Setup Error for MCU Quantity Used.....	358
4-4-35 MCU branch part setup error – Overlapping Indoor unit Address setup.....	359
4-4-36 MCU branch part setup error – Set as being used without connection to an Indoor unit	360
4-4-37 MCU branch part setup error – Connect an Indoor unit to a branch part not being used.....	361
4-4-38 MCU branch part setup error – Connect more Indoor units than what is actually set up in MCU....	362
4-4-39 Outdoor Temperature Sensor Error.....	363
4-4-40 Outdoor Temperature dislocation error.....	364
4-4-41 Cond Out Temperature Sensor Error (Open/Short).....	365
4-4-42 Outdoor Cond Out sensor breakaway error.....	366
4-4-43 Digital Compressor Discharge Temperature Sensor Error (OPEN/SHORT).....	367
4-4-44 Constant Rate Compressor Discharge Temperature Sensor Error (OPEN/SHORT)	368
4-4-45 Compressor Discharge or Top 1/2 Temperature sensor error	369
4-4-46 <i>E 265</i> : Dislocation error of Compressor SUMP Temperature (oil temperature) Sensor	370
4-4-47 <i>E 269</i> : Suction Temperature sensor breakaway error.....	371
4-4-48 SUMP Temperature Sensor Error (OPEN/SHORT).....	372
4-4-49 High Pressure sensor error (Open/Short).....	373
4-4-50 Low Pressure sensor error (Open/Short).....	374
4-4-51 Suction Temperature sensor error (Open/Short).....	375
4-4-52 Liquid Pipe Temperature sensor error (Open/Short).....	376
4-4-53 EVI In Temperature sensor error (Open/Short).....	377
4-4-54 EVI Out Temperature sensor error (Open/Short).....	378
4-4-55 Suction-2 Temperature Sensor Error (OPEN/SHORT).....	379
4-4-56 <i>E 407</i> : Comp. Down due to High Pressure Protection Control.....	380
4-4-57 <i>E 410</i> : Comp. Down due to Low Pressure Protection Control.....	381
4-4-58 Sump Sensor Error Due to Protection Control.....	382
4-4-59 <i>E 416</i> : Comp. Down due to Compressor Discharge Temperature sensor.....	383
4-4-60 3-phase Input Wiring error.....	384
4-4-61 <i>E 428</i> : Comp. Down by Compression Ratio Control	385
4-4-62 EVI EEV Open error.....	386
4-4-63 Refrigerant Leakage Error	387
4-4-64 <i>E 440</i> , <i>E 442</i> : Prohibition of the operation of Compressor due to Outdoor Temperature..	388
4-4-65 High Pressure Standard Not Met before Air Conditioning (Inability to Re-operate)	389
4-4-66 CCH Malfunction and Sump Sensor Miswiring Error.....	390
4-4-67 Fan starting error	391
4-4-68 Fan lock error.....	392

Contents

4-4-69	Momentary Blackout error	393
4-4-70	Outdoor Fan Motor overheating.....	394
4-4-71	Outdoor Unit Fan Motor RPM Error.....	395
4-4-72	Fan IPM Overheat error.....	396
4-4-73	Over-Voltage Error of an Outdoor Fan Motor.....	397
4-4-74	Counter-Rotation Error of an Outdoor Fan Motor.....	397
4-4-75	<i>E45B</i> : Compressor Excess Current Error	398
4-4-76	Compressor starting error	399
4-4-77	Inverter Overcurrent error.....	400
4-4-78	Overvoltage / Low voltage error.....	401
4-4-79	DC Link voltage sensor error.....	402
4-4-80	Liquid Compression Prevention Control.....	403
4-4-81	Fan Motor Overcurrent error	404
4-4-82	Input / Output Current sensor error.....	405
4-4-83	Outdoor Fan PCB Overvoltage / Low voltage error	406
4-4-84	Hall IC(Fan) error.....	407
4-4-85	Inverter Overheat error	408
4-4-86	Model mismatching of Indoor unit.....	409
4-4-87	Breakdown of an EEV(1 st)	410
4-4-87	Breakdown of an EEV closure	411
4-4-88	Electronic expansion valve closing malfunction (2 nd stage).....	412
4-4-89	Electronic expansion valve opening malfunction (2 nd stage).....	413
4-4-90	Hydro Unit Water In Temperature Sensor Error (Open/Short).....	414
4-4-91	Hydro Unit Water Out Temperature Sensor Error (Open/Short)	415
4-4-92	Hydro Unit Water Tank Temperature Sensor Error (Open/Short).....	416
4-4-93	Emergency Error (Check the Water Piping Equipment).....	417
4-4-94	Error to prevention from freezing and bursting of Heat Exchanger	418
4-4-95	Breakaway of Water Out temperature sensor.....	419
4-4-96	Breakaway of Flow switch.....	420
4-4-97	Thermostat Wiring Error.....	421
4-4-98	DC FAN Motor Feedback Error.....	422
4-4-99	Water Tank Sensor defective	423

5. PCB Diagram and Parts List 424

5-1	Indoor Unit	424
5-1-1	Slim 1 way cassette type (medium).....	424
5-1-2	2 way cassette type.....	426
5-1-3	4way cassette , Global 4Way Cassette type(600x600), Slim 1way cassette (small/large)	428
5-1-4	360 cassette.....	430
5-1-5	Indoor Unit Power PCB.....	432
5-1-6	Display PCB	433
5-1-7	Duct type (Slim Duct 2)	434
5-1-8	Duct type (Slim Duct 3)	437
5-1-9	Slim Home Duct.....	440
5-1-10	Duct type(MSP, HSP, Big Duct).....	442
5-1-11	Duct type(HSP)	444
5-1-12	Duct type (Super)	446
5-1-13	Duct type (Global Duct)	448
5-1-14	Duct type (Global Duct_HSP)	451
5-1-15	Big Duct.....	454
5-1-16	Celing type	457
5-1-17	Big Ceiling	459
5-1-18	Console	461
5-1-19	Wall-Mounted type (Neo Forte).....	465
5-1-20	Wall-Mounted type (Boracay).....	467
5-1-21	ERV Plus	469
5-1-22	Hydro unit/Hydro unit HT	471
5-1-23	Hydro unit HT	473

Contents

5-1-24 Wall Mounted type(A3050)	480
5-1-25 OAP DUCT	483
5-1-26 OAP DUCT.....	485
5-1-27 V-AHU	492
5-1-28 STAND.....	494
5-1-29 Floor Standing Type.....	501
5-1-30 Wall Mounted type(MAX)	505
5-1-30 Wall Mounted type(MAX)	508
5-1-31 Wind-free 1way cassette type.....	510
5-1-32 4Way Cassette(600x600)	513
5-1-33 4Way Cassette(600x600)	515

6. Wiring Diagram 516

6-1 Indoor.....	516
6-1-1 Global 4Way (Global 4Way(600x600)) cassette type, Slim 1way cassette (small/large).....	516
6-1-2 Slim 1 way cassette type (medium)	517
6-1-3 360 cassette	518
6-1-4 BIG Duct.....	519
6-1-5 GD-S(Big Duct).....	520
6-1-6 Ceiling	521
6-1-7 Big Ceiling	522
6-1-8 Console	523
6-1-9 RAC(Neo Forte).....	524
6-1-10 Wall-Mounted type (Boracay).....	525
6-1-11 2way cassette type	526
6-1-12 DUCT type (Slim III).....	527
6-1-13 DUCT type (Slim I, II, MSP)	528
6-1-14 Slim Home Duct.....	529
6-1-15 Duct type (HSP).....	530
6-1-16 Duct type (Global Duct, MSP).....	531
6-1-17 Duct type (Global Duct, HSP).....	532
6-1-18 Floor Stand Type.....	533
6-1-19 ERV Plus	535
6-1-20 Hydro unit	536
6-1-21 Hydro unit HT 3 phase	537
6-1-22 Hydro unit HT Single phase.....	538
6-1-23 Wall Mounted type(A3050)	539
6-1-24 Wall Mounted type(MAX).....	540
6-1-25 OAP DUCT(AM140JNEPEH/EU).....	541
6-1-26 OAP Duct (AM140MNEPEH/EU)	542
6-1-27 OAP Duct (AM140MNEPEH/EU)	543
6-1-28 OAP DUCT(AM220/280*NEPEH/EU).....	544
6-1-29 V-AHU	545
6-1-30 Stand.....	546
6-1-31 4Way Cassette type(600x600).....	550

7. Reference Sheet 551

7-1 Index for Model Name.....	551
7-1-1 Indoor Unit.....	551
7-1-2 Panel	552
7-2 Pump-down Method	553
7-2-1 Precautions for Pump-down	553
7-2-2 For Single Installation of Outdoor Unit (Only One Outdoor Unit Installed).....	553
7-2-3 When Two or More Outdoor Units are Installed.....	553
7-3 How to Put Refrigerant in Refrigerant Container	554
7-3-1 How to put refrigerant in container before pump-down.....	554

1. Precautions

1-1 Precautions for the Service

- **Use the correct parts when changing the electric parts.**
 - Please check the labels and notices for the model name, proper voltage, and proper current for the electric parts.
- **Fully repair the connection for the types of harness when repairing the product after breakdown.**
 - A faulty connection can cause irregular noise and problems.
- **When disassembling or assembling, make sure that the product is laid down on a work cloth.**
 - Doing so will prevent scratching to the exterior of the rear side of the product.
- **Completely remove dust or foreign substances on the housing, connection, and inspection parts when performing repairs.**
 - This can prevent fire hazards for tracking, short, etc.
- **Please tighten the service valve of the outdoor unit and the valve cap of the charging valve as securely as possible by using a monkey spanner.**
- **Check whether the parts are properly and securely assembled after performing repairs.**
 - These parts should be in the same condition as before the repair.

1-2 Precautions for the Static Electricity and PL

- **Please carefully handle the PCB power terminal during repair and measurement when it is turned on since it is vulnerable to static electricity.**
 - Please wear insulation gloves before performing PCB repair and measurement.
- **Check if the place of installation is at least 2m away from electronic appliances such as TV, video players, and stereos.**
 - This can cause irregular noise or degrade the picture quality.
- **Please make sure the customer does not directly repair the product.**
 - Arbitrary dismantling may result in electric shock or fire.

1-3 Precautions for the Safety

- **Do not pull or touch the power plug or the subsidiary power switch with wet hands.**
 - This may result in electric shock or fire.
- **If the power line or the power plug is damaged, then it must be changed since this is a hazard.**
- **Do not bend the wire too much or position it so that it can be damaged by a heavy object on top.**
 - This may result in electric shock or fire.
- **The use of multiple electric outlets should be prohibited.**
 - This may result in electric shock or fire.
- **Ground the connection if it is necessary.**
 - The connection must be grounded if there is any risk of electrical short due to water or moisture.
- **Unplug the power or turn off the subsidiary power switch when changing or repairing electrical parts.**
 - Doing so will prevent electric shock.
- **Explain to workers that the battery for the remote control needs to be separated for storage purposes when the product will not be used for a long time.**
 - This can cause a problem for the remote control since battery fluid may trickle out.

1-4 Precautions for Handling Refrigerant for Air Conditioner

Environmental Cautions: Air pollution due to gas release

- **Safety Cautions**

If liquid gas is released, then body parts that come into contact with it may experience frostbite/blister/numbness.

If a large amount of gas is released, then suffocation may occur due to lack of oxygen. If the released gas is heated, then noxious gas may be produced by combustion.

- **Container Handling Cautions**

Do not subject container to physical shock or overheating. (Flowage is possible while moving within the regulated pressure.)

1-5 Precautions for Welding the Air Conditioner Pipe

- **Dangerous or flammable objects around the pipe must be removed before the welding.**

- **If the refrigerant is kept inside the product or the pipe, then remove the refrigerant prior to welding.**

If the welding is carried out while the refrigerant is kept inside, the welding cannot be properly performed. This will also produce noxious gas that is a health hazard. This leakage will also explode with the refrigerant and oil due to an increase in the refrigerant pressure, posing a danger to workers.

- **Please remove the oxide produced inside the pipe during the welding with nitrogen gas.**

Using another gas may cause harm to the product or others.

1-6 Precautions for Additional Supplement of Air Conditioner Refrigerant

- **Precisely calculate the refrigerant by using a scale and S-net, and proceed with the test operation.**

Excessive supplement can cause harm to the product since it can cause an inflow of the liquid refrigerant into the compressor.

- **Do not heat the refrigerant container for a forced injection.**

This may cause harm to the product or others since the refrigerant container may burst.

- **Do not operate the product after removing the product safety pressure switch and sensor.**

If the product is blocked inside, then this may cause harm to the product or others due to the excess pressure increase of the refrigerant gas.

1-7 Other Precautions

- **There should be no leakage of the pipes after installation. When withdrawing the refrigerant, the compressor should be stopped before removing the connecting pipe.**

If the compressor is operating while the refrigerant pipe is not correctly connected and the service valve is opened, then air and other substances can enter the pipe. The interior of the refrigerant cycle may then build up excessive high pressure resulting in explosion and damage.

2. Product Specifications

2-1 Product Specifications

2-1-1 Indoor Unit

■ Slim 1way cassette type

Model			AM017HN1DEH/EU	AM022HN1DEH/EU	AM022FN1DEH/EU	AM028FN1DEH/EU	AM036FN1DEH/*	
Power Supply			ø/V/Hz	1/220~240/50	1/220~240/50	1/220~240/50	1/220~240/50	
Mode*1)			HP/HR	HP/HR	HP / HR	HP / HR	HP / HR	
Performance	Capacity	Cooling*2)	kW	1.7	2.2	2.2	2.8	3.6
			Btu/h	5800	7500	7,500	9,500	12,200
	Heating*3)	kW	1.9	2.5	2.6	3.2	4.0	
		Btu/h	6400	8500	8,500	10,900	13,600	
Condensate (with High fan speed)		Liters/h	1.6	1.6	1.12	1.44	1.6	
Power	Input	W	24	25	50*5)	45*5)	50*5)	
	Running Current	A	0.14	0.15	0.20*5)	0.23*5)	0.25*5)	
Sound Level	Sound Pressure*4)	dB(A)	33	34	34	37	40	
Fan	Type	-	Crossflow fan	Crossflow fan	Crossflow fan	Crossflow fan	Crossflow fan	
	Motor	Model	-	SIC-41CVJ-F127-2	SIC-41CVJ-F127-2	Y4S476B041L	Y4S476B041L	Y4S476B041L
		Type	-	BLDC	BLDC	Feedback SSR	Feedback SSR	Feedback SSR
		Output	W	27W	27W	-	-	-
Air Flow Rate		m ³ /min	4.8/4.3/4.1	5.1/4.6/4.3	6/5/4	7/6/5	8/7/6	
Refrigerant	Type	-	R410A	R410A	R410A	R410A	R410A	
	Control Method	-	EEV	EEV	EEV	EEV	EEV	
Temperature Control		-	Micom & Thermistors	Micom & Thermistors	Micom & Thermistors	Micom & Thermistors	Micom & Thermistors	
Safety Devices		-	Fuse	Fuse	Fuse	Fuse	Fuse	
Piping Connections	Liquid (Flare)	ø, mm	6.35	6.35	6.35	6.35	6.35	
	Gas (Flare)	ø, mm	12.7	12.7	12.7	12.7	12.7	
	Drain (Quick Lock)	ø, mm	VP20	VP20	VP20 (OD 25, ID 20)	VP20 (OD 25, ID 20)	VP20 (OD 25, ID 20)	
Weight	Net Weight	kg	8	8	10.5	10.5	10.5	
	Shipping Weight	kg	10.8	10.8	13.0	13.0	13.0	
Dimensions	Net Dimensions (W x H x D)	mm	740x135x360	740x135x360	970x135x410	970x135x410	970x135x410	
	Shipping Dimensions (W x H x D)	mm	895x223x435	895x223x435	1,164x212x478	1,164x212x478	1,164x212x478	
Panel Size	Model	-	PC1MWSKAN	PC1MWSKAN	PC1NUSMAN	PC1NUSMAN	PC1NUSMAN	
	Net Weight	kg	2.6	2.6	3.0	3.0	3.0	
	Shipping Weight	kg	4.2	4.2	5.0	5.0	5.0	
	Net Dimensions (W x H x D)	mm	900x25x420	900x25x420	1,180x25x460	1,180x25x460	1,180x25x460	
	Shipping Dimensions (W x H x D)	mm	958x112x482	958x112x482	1,259x144x539	1,259x144x539	1,259x144x539	
Functions	Auto Restart	-	O	O	O	O	O	
	Auto Swing	-	O	O	O	O	O	
	Group/Individual Control	-	O	O	O	O	O	
	External Contact Control	-	O	O	O	O	O	
	Trouble Shooting by LED	-	O	O	O	O	O	
Standard Accessories	Installation Manual	-	O	O	O	O	O	
	Operation Manual	-	X	X	X	X	X	
	Pattern Sheet for Installation	-	O	O	O	O	O	
	Flexible Drain Hose	-	O	O	O	O	O	
	Filter / Safety Grille	-	Filter (Washable)	Filter (Washable)	Filter (Washable)	Filter (Washable)	Filter (Washable)	
	Drain Pump (Pumping speed, lift)	ℓ/h,mm	24, 750	24, 750	24, 750	24, 750	24, 750	
Optional Accessories	Wireless Remote Controller	-	MR-DH00	MR-DH00	MR-DH00	MR-DH00	MR-DH00	
	Wired Remote Controller	-	MWR-WE10N	MWR-WE10N	MWR-WE10N	MWR-WE10N	MWR-WE10N	
	External Contact Interface Module	-	MIM-B14	MIM-B14	MIM-B14	MIM-B14	MIM-B14	



*1) Mode

- HP : Heat Pump, HR : Heat Recovery

*2) Nominal cooling capacities are based on;

- Indoor temperature : 27°C DB, 19°C WB

- Outdoor temperature : 35°C DB, 24°C WB, Equivalent refrigerant piping : 7.5m, Level differences : 0m

*3) Nominal heating capacities are based on;

- Indoor temperature : 20°C DB, 15°C WB

- Outdoor temperature : 7°C DB, 6°C WB, Equivalent refrigerant piping : 7.5m, Level differences : 0m

*4) Sound pressure was acquired in a dead room. Thus actual noise level may be different depending on the installation conditions.

*5) Specifications may be subject to change without prior notice for product improvement.

Indoor Unit (cont.)

■ Slim 1way cassette type (cont.)

Model			AM056*N1DEH*	AM071*N1DEH*	
Power Supply		ø/V/Hz	1/220~240/50	1/220~240/50	
Mode*1)			HP/HR	HP/HR	
Performance	Capacity	Cooling*2)	kW	5.6	7.1
			Btu/h	19,100	24,200
	Heating*3)	kW	6.3	8.0	
		Btu/h	21,500	27,300	
Condensate (with High fan speed)		Liters/h	-	-	
Power	Input	W	55.0	80.0	
	Running Current	A	0.28	0.40	
Sound Level	Sound Pressure *4)	dB(A)	36	39	
Fan	Type		-	Crossflow Fan	Crossflow Fan
	Motor	Model	-	SIC-55CVL-F158-3 FDA6531SSH	SIC-55CVL-F158-3 FDA6531SSH
		Type	-	BLDC	BLDC
		Output	W	54W	54W
Airflow Rate	Cooling (High)	m ³ /min	16.00/14.00/12.50	17.00/15.50/14.00	
	Heating (High)	m ³ /min	16.00/14.00/12.50	17.00/15.50/14.00	
Refrigerant	Type	-	R410A	R410A	
	Control Method	-	EEV	EEV	
Temperature Control		-	Micom & Thermistors	Micom & Thermistors	
Safety Devices		-	Fuse	Fuse	
Piping Connections	Liquid (Flare)	ø, mm	6.35	9.52	
	Gas (Flare)	ø, mm	12.7	15.88	
	Drain (Quick Lock)	ø, mm	VP20 (OD 26, ID 20)	VP20 (OD 26, ID 20)	
Weight	Net Weight	kg	14	14	
	Shipping Weight	kg	18	18	
Dimensions	Net Dimensions (W x H x D)	mm	1200 x 138 x 450	1200 x 138 x 450	
	Shipping Dimensions (W x H x D)	mm	1435 x 224 x 525	1435 x 224 x 525	
Panel Size	Model	-	PC1BWSMAN	PC1BWSMAN	
	Net Weight	kg	6.3	6.3	
	Shipping Weight	kg	8.3	8.3	
	Net Dimensions (W x H x D)	mm	1410 x 23 x 500	1410 x 23 x 500	
	Shipping Dimensions (W x H x D)	mm	1474 x 122 x 566	1474 x 122 x 566	
Functions	Auto Restart	-	O	O	
	Auto Swing	-	O	O	
	Group/Individual Control	-	O	O	
	External Contact Control	-	O	O	
	Trouble Shooting by LED	-	O	O	
Standard Accessories	Installation Manual	-	O	O	
	Operation Manual	-	X	X	
	Pattern Sheet for Installation	-	O	O	
	Flexible Drain Hose	-	O	O	
	Filter / Safety Grille	-	Filter (Washable)	Filter (Washable)	
	Drain Pump (Pumping speed, lift)	ℓ/h,mm	24, 750	24, 750	
Optional Accessories	Wireless Remote Controller	-	MR-DH00	MR-DH00	
	Wired Remote Controller	-	MWR-WE10N	MWR-WE10N	
	External Contact Interface Module	-	MIM-B14	MIM-B14	



*1) Mode

- HP : Heat Pump, HR : Heat Recovery

*2) Nominal cooling capacities are based on;

- Indoor temperature : 27°C DB, 19°C WB

- Outdoor temperature : 35°C DB, 24°C WB, Equivalent refrigerant piping : 7.5m, Level differences : 0m

*3) Nominal heating capacities are based on;

- Indoor temperature : 20°C DB, 15°C WB

- Outdoor temperature : 7°C DB, 6°C WB, Equivalent refrigerant piping : 7.5m, Level differences : 0m

*4) Sound pressure was acquired in a dead room. Thus actual noise level may be different depending on the installation conditions.

*5) Specifications may be subject to change without prior notice for product improvement.

Indoor Unit (cont.)

■ Wind-free 1way cassette type (cont.)

Model			AM017NN1PEH*	AM022NN1PEH*	AM022NN1DEH*	AM028NN1DEH*	AM036NN1DEH*	
Power Supply		ø/N/Hz	1/220~240/50	1/220~240/50	1/220~240/50	1/220~240/50	1/220~240/50	
Mode*1)			HP/HR	HP/HR	HP/HR	HP/HR	HP/HR	
Performance	Capacity	Cooling*2)	kW	1.70	2.20	2.20	2.80	3.60
			Btu/h	5,800	7,500	7,500	9,600	12,300
	Heating*3)	kW	1.90	2.50	2.50	3.20	4.00	
		Btu/h	6,500	8,500	8,500	10,900	13,600	
Condensate (with High fan speed)		Liters/h	-	-	-	-	-	
Power	Input	W	24.0	25.0	40.0	45.0	50.0	
	Running Current	A	0.14	0.15	0.20	0.23	0.25	
Sound Level	Sound Pressure *4)	dB(A)	46	47	47	50	55	
Fan	Type		-	Cross flow fan	Cross flow fan	Cross flow fan	Cross flow fan	Y4S476B041L
	Motor	Model	-	SIC-41CVJ-F127-2	SIC-41CVJ-F127-2	Y4S476B041L	Y4S476B041L	Y4S476B041L
		Type	-	BLDC	BLDC	Feedback SSR	Feedback SSR	Feedback SSR
		Output	W	27 x 1	27 x 1	17 x 1	17 x 1	17 x 1
Air Flow Rate		m ³ /min	4.80/4.30/4.10	5.10/4.60/4.30	6.00/5.00/4.00	7.00/6.00/5.00	8.00/7.00/6.00	
Refrigerant	Type	-	R410A	R410A	R410A	R410A	R410A	
	Control Method	-	EEV	EEV	EEV	EEV	EEV	
Temperature Control		-	Micom & Thermistors	Micom & Thermistors	Micom & Thermistors	Micom & Thermistors	Micom & Thermistors	
Safety Devices			-	Fuse	Fuse	Fuse	Fuse	Fuse
Piping Connections	Liquid (Flare)	ø, mm	6.35	6.35	6.35	6.35	6.35	6.35
	Gas (Flare)	ø, mm	12.70	12.70	12.70	12.70	12.70	12.70
	Drain (Quick Lock)	ø, mm	VP20 (OD 26,ID 20)	VP20 (OD 26,ID 20)	VP20 (OD 26,ID 20)	VP20 (OD 26,ID 20)	VP20 (OD 26,ID 20)	VP20 (OD 26,ID 20)
Weight	Net Weight	kg	8.0	8.0	10.0	10.0	10.0	
	Shipping Weight	kg	10.5	10.5	12.8	12.8	12.8	
Dimensions	Net Dimensions (W x H x D)	mm	740 x 135 x 360	740 x 135 x 360	970 x 135 x 410	970 x 135 x 410	970 x 135 x 410	
	Shipping Dimensions (W x H x D)	mm	895 x 223 x 435	895 x 223 x 435	1,173 x 231 x 487	1,173 x 231 x 487	1,173 x 231 x 487	
Panel Size	Model	-	PC1MWFMAN	PC1MWFMAN	PC1NWFMAN	PC1NWFMAN	PC1NWFMAN	
	Net Weight	kg	2.6	2.6	4.3	4.3	4.3	
	Shipping Weight	kg	3.8	3.8	6.3	6.3	6.3	
	Net Dimensions (W x H x D)	mm	960 x 35 x 420	960 x 35 x 420	1198 x 35 x 500	1198 x 35 x 500	1198 x 35 x 500	
	Shipping Dimensions (W x H x D)	mm	1003 X 482 X 112	1003 X 482 X 112	1262 X 568 X 124	1262 X 568 X 124	1262 X 568 X 124	
Functions	Auto Restart	-	O	O	O	O	O	
	Auto Swing	-	O	O	O	O	O	
	Group/Individual Control	-	O	O	O	O	O	
	External Contact Control	-	O	O	O	O	O	
	Trouble Shooting by LED	-	O	O	O	O	O	
Standard Accessories	Installation Manual	-	O	O	O	O	O	
	Operation Manual	-	X	X	X	X	X	
	Pattern Sheet for Installation	-	O	O	O	O	O	
	Flexible Drain Hose	-	O	O	O	O	O	
	Filter / Safety Grille	-	Filter (Washable)	Filter (Washable)	Filter (Washable)	Filter (Washable)	Filter (Washable)	
	Drain Pump (Pumping speed, lift)	ℓ/h,mm	24/750	24/750	24/750	24/750	24/750	
Optional Accessories	Wireless Remote Controller	-	AR-EH03E	AR-EH03E	AR-EH03E	AR-EH03E	AR-EH03E	
	Wired Remote Controller	-	MWR-WE13N	MWR-WE13N	MWR-WE13N	MWR-WE13N	MWR-WE13N	
	External Contact Interface Module	-	MIM-B14	MIM-B14	MIM-B14	MIM-B14	MIM-B14	



*1) Mode

- HP : Heat Pump, HR : Heat Recovery

*2) Nominal cooling capacities are based on;

- Indoor temperature : 27°C DB, 19°C WB

- Outdoor temperature : 35°C DB, 24°C WB, Equivalent refrigerant piping : 7.5m, Level differences : 0m

*3) Nominal heating capacities are based on;

- Indoor temperature : 20°C DB, 15°C WB

- Outdoor temperature : 7°C DB, 6°C WB, Equivalent refrigerant piping : 7.5m, Level differences : 0m

*4) Sound pressure was acquired in a dead room. Thus actual noise level may be different depending on the installation conditions.

*5) Specifications may be subject to change without prior notice for product improvement.

Indoor Unit (cont.)

■ Wind-free 1way cassette type (cont.)

Model			AM056NN1DEH*	AM071NN1DEH*	
Power Supply		ø/V/Hz	1/220~240/50	1/220~240/50	
Mode*1)			HP/HR	HP/HR	
Performance	Capacity	Cooling*2)	kW	5.60	7.10
			Btu/h	19,100	24,200
		Heating*3)	kW	6.30	8.00
			Btu/h	21,500	27,300
	Condensate (with High fan speed)		Liters/h	-	-
Power	Input	W	55.00	80.00	
	Running Current	A	0.28	0.40	
Sound Level	Sound Pressure *4)	dB(A)	59	60	
Fan	Type		Cross flow fan	Cross flow fan	
	Motor	Model	SIC-55CVL-F158-3	SIC-55CVL-F158-3	
		Type		BLDC	BLDC
		Output	W	54 x 1	54 x 1
Air Flow Rate		m ³ /min	16.00/14.00/12.50	17.00/15.50/14.00	
Refrigerant	Type		R410A	R410A	
	Control Method		EEV	EEV	
Temperature Control			Micom & Thermistors	Micom & Thermistors	
Safety Devices			Fuse	Fuse	
Piping Connections	Liquid (Flare)	ø, mm	6.35	9.52	
	Gas (Flare)	ø, mm	12.70	15.88	
	Drain (Quick Lock)	ø, mm	VP20 (OD 26, ID 20)	VP20 (OD 26, ID 20)	
Weight	Net Weight	kg	13.5	13.5	
	Shipping Weight	kg	17.3	17.3	
Dimensions	Net Dimensions (W x H x D)	mm	1200 x 138 x 450	1200 x 138 x 450	
	Shipping Dimensions (W x H x D)	mm	1,435 x 224 x 525	1,435 x 224 x 525	
Panel Size	Model		PC1BWFCAN	PC1BWFCAN	
	Net Weight	kg	5.0	5.0	
	Shipping Weight	kg	7.0	7.0	
	Net Dimensions (W x H x D)	mm	1,410 x 35 x 500	1,410 x 35 x 500	
	Shipping Dimensions (W x H x D)	mm	1,473 X 568 X 124	1,473 X 568 X 124	
Functions	Auto Restart		O	O	
	Auto Swing		O	O	
	Group/Individual Control		O	O	
	External Contact Control		O	O	
	Trouble Shooting by LED		O	O	
Standard Accessories	Installation Manual		O	O	
	Operation Manual		X	X	
	Pattern Sheet for Installation		O	O	
	Flexible Drain Hose		O	O	
	Filter / Safety Grille		Filter (Washable)	Filter (Washable)	
	Drain Pump (Pumping speed, lift)	ℓ/h, mm	24/750	24/750	
Optional Accessories	Wireless Remote Controller		AR-EH03E	AR-EH03E	
	Wired Remote Controller		MWR-WE13N	MWR-WE13N	
	External Contact Interface Module		MIM-B14	MIM-B14	



*1) Mode

- HP : Heat Pump, HR : Heat Recovery

*2) Nominal cooling capacities are based on;

- Indoor temperature : 27°C DB, 19°C WB

- Outdoor temperature : 35°C DB, 24°C WB, Equivalent refrigerant piping : 7.5m, Level differences : 0m

*3) Nominal heating capacities are based on;

- Indoor temperature : 20°C DB, 15°C WB

- Outdoor temperature : 7°C DB, 6°C WB, Equivalent refrigerant piping : 7.5m, Level differences : 0m

*4) Sound pressure was acquired in a dead room. Thus actual noise level may be different depending on the installation conditions.

*5) Specifications may be subject to change without prior notice for product improvement.

Indoor Unit (cont.)

■ 2 way cassette type

Model			AM056FN2DEH/*	AM071FN2DEH/*	
Power Supply		ø/V/Hz	1/220~240/50	1/220~240/50	
Mode*1)			HP / HR	HP / HR	
Performance	Capacity	Cooling*2)	kW	5.6	7.1
			Btu/h	19,100	24,200
	Heating*3)	kW	6.3	8.0	
		Btu/h	21,400	27,200	
Condensate (with High fan speed)		Liters/h	2.87	3.19	
Power	Input	W	70	75	
	Running Current	A	0.38	0.40	
Sound Level	Sound Pressure *4)	dB(A)	45	46	
Fan	Type	-	Crossflow fan	Crossflow fan	
	Motor	Model	-	PFS027WTVB	PFS027WTVB
		Type	-	Feedback SSR	Feedback SSR
		Output	W	14.0 x 2	14.0 x 2
Airflow Rate	H/M/L (UL)	CMM	14.00/13.00/12.00	15.00/14.00/13.00	
		l/s	233.33/216.67/200.00	250.00/233.33/216.67	
Refrigerant	Type	-	R410A	R410A	
	Control Method	-	EEV	EEV	
Temperature Control		-	Micom & Thermistors	Micom & Thermistors	
Safety Devices		-	Fuse	Fuse	
Piping Connections	Liquid (Flare)	ø, mm	6.35	9.52	
	Gas (Flare)	ø, mm	12.70	15.88	
	Drain (Quick Lock)	ø, mm	VP25 (OD 32, ID 25)	VP25 (OD 32, ID 25)	
Weight	Net Weight	kg	21.0	22.0	
	Shipping Weight	kg	25.0	26.0	
Dimensions	Net Dimensions (W x H x D)	mm	890x230x575	890x230x575	
	Shipping Dimensions (W x H x D)	mm	1,077x299x642	1,077x299x642	
Panel Size	Model	-	PC2NUSMEN	PC2NUSMEN	
	Net Weight	kg	4.0	4.0	
	Shipping Weight	kg	8.0	8.0	
	Net Dimensions (W x H x D)	mm	1,030x25x650	1,030x25x650	
	Shipping Dimensions (W x H x D)	mm	1,103x151x727	1,103x151x727	
Functions	Auto Restart	-	O	O	
	Auto Swing	-	O	O	
	Group/Individual Control	-	O	O	
	External Contact Control	-	O	O	
	Trouble Shooting by LED	-	O	O	
Standard Accessories	Installation Manual	-	O	O	
	Operation Manual	-	X	X	
	Pattern Sheet for Installation	-	O	O	
	Flexible Drain Hose	-	O	O	
	Filter / Safety Grille	-	Filter (Washable)	Filter (Washable)	
Drain Pump (Pumping speed, lift)	ℓ/h,mm	24, 750	24, 750		
Optional Accessories	Wireless Remote Controller	-	MR-DH00	MR-DH00	
	Wired Remote Controller	-	MWR-WE10N	MWR-WE10N	
		-	MWR-WS00	MWR-WS00	
	External Contact Interface Module	-	MIM-B14	MIM-B14	



*1) Mode

- HP : Heat Pump, HR : Heat Recovery

*2) Nominal cooling capacities are based on;

- Indoor temperature : 27°C DB, 19°C WB

- Outdoor temperature : 35°C DB, 24°C WB, Equivalent refrigerant piping : 7.5m, Level differences : 0m

*3) Nominal heating capacities are based on;

- Indoor temperature : 20°C DB, 15°C WB

- Outdoor temperature : 7°C DB, 6°C WB, Equivalent refrigerant piping : 7.5m, Level differences : 0m

*4) Sound pressure was acquired in a dead room. Thus actual noise level may be different depending on the installation conditions.

*5) Specifications may be subject to change without prior notice for product improvement.

Indoor Unit (cont.)

■ 4 way cassette

Model			AM045FN4DEH/※	AM056FN4DEH/※	AM071FN4DEH/※	AM090FN4DEH/※	
Power Supply		ø/V/Hz	1/220~240/50	1/220~240/50	1/220~240/50	1/220~240/50	
Mode*1)			HP / HR	HP / HR	HP / HR	HP / HR	
Performance	Capacity	Cooling*2)	kW	4.5	5.6	7.1	9.0
			Btu/h	15,300	19,100	24,200	30,700
		Heating*3)	kW	5.0	6.3	8.0	10.0
			Btu/h	17,000	21,400	27,200	34,100
	Condensate (with High fan speed)		Liters/h	2.23	2.71	3.51	4.46
Power	Input		W	32	32	45	62
	Running Current		A	0.22	0.22	0.31	0.43
Sound Level	Sound Pressure (Cooling/Heating)*4)		dB(A)	42 / 44	42 / 44	44 / 44	47 / 47
Fan	Type		-	Turbo Fan	Turbo Fan	Turbo Fan	Turbo Fan
	Motor	Model	-	FMC6531SSH	FMC6531SSH	FMC6531SSH	FMC6531SSH
		Type	-	BLDC	BLDC	BLDC	BLDC
		Output	-	W	*5)	*5)	*5)
Airflow Rate	H/M/L (UL)	CMM	14.50/13.50/12.50	15.00/14.00/13.00	17.00/15.50/14.50	19.50/18.00/16.50	
		l/s	241.67/225.00/208.33	250.00/233.33/216.67	283.33/258.33/241.67	325.00/300.00/275.00	
Refrigerant	Type		-	R410A	R410A	R410A	R410A
	Control Method		-	EEV	EEV	EEV	EEV
Temperature Control		-	Micom & Thermistors	Micom & Thermistors	Micom & Thermistors	Micom & Thermistors	
Safety Devices		-	Fuse	Fuse	Fuse	Fuse	
Piping Connections	Liquid (Flare)		ø, mm	6.35	6.35	9.52	9.52
	Gas (Flare)		ø, mm	12.7	12.7	15.88	15.88
	Drain (Quick Lock)		ø, mm	VP25 (OD 32,ID 25)	VP25 (OD 32,ID 25)	VP25 (OD 32,ID 25)	VP25 (OD 32,ID 25)
Weight	Net Weight		kg	15.5	15.5	15.5	15.5
	Shipping Weight		kg	19.5	19.5	19.5	19.5
Dimensions	Net Dimensions (W x H x D)		mm	840x204x840	840x204x840	840x204x840	840x204x840
	Shipping Dimensions (W x H x D)		mm	898x275x898	898x275x898	898x275x898	898x275x898
Panel Size	Model		-	PC4NUSKAN	PC4NUSKAN	PC4NUSKAN	PC4NUSKAN
	Net Weight		kg	5.8	5.8	5.8	5.8
	Shipping Weight		kg	8.4	8.4	8.4	8.4
	Net Dimensions (W x H x D)		mm	950 x 45 x 950	950 x 45 x 950	950 x 45 x 950	950 x 45 x 950
	Shipping Dimensions (W x H x D)		mm	1005 x 100 x 1005	1005 x 100 x 1005	1005 x 100 x 1005	1005 x 100 x 1005
Functions	Auto Restart		-	O	O	O	O
	Auto Swing		-	O	O	O	O
	Group/Individual Control		-	O	O	O	O
	External Contact Control		-	O	O	O	O
	Trouble Shooting by LED		-	O	O	O	O
Standard Accessories	Installation Manual		-	O	O	O	O
	Operation Manual		-	X	X	X	X
	Pattern Sheet for Installation		-	O	O	O	O
	Flexible Drain Hose		-	O	O	O	O
	Filter / Safety Grille		-	Filter / Safety Grille	Filter / Safety Grille	Filter / Safety Grille	Filter / Safety Grille
	Drain Pump (Pumping speed, lift)		ℓ/h,mm	24, 750	24, 750	24, 750	24, 750
Optional Accessories	Wireless Remote Controller		-	MR-DH00	MR-DH00	MR-DH00	MR-DH00
	Wired Remote Controller		-	MWR-WE10N	MWR-WE10N	MWR-WE10N	MWR-WE10N
	External Contact Interface Module		-	MIM-B14	MIM-B14	MIM-B14	MIM-B14



*1) Mode

- HP : Heat Pump, HR : Heat Recovery

*2) Nominal cooling capacities are based on;

- Indoor temperature : 27°C DB, 19°C WB

- Outdoor temperature : 35°C DB, 24°C WB, Equivalent refrigerant piping : 7.5m, Level differences : 0m

*3) Nominal heating capacities are based on;

- Indoor temperature : 20°C DB, 15°C WB

- Outdoor temperature : 7°C DB, 6°C WB, Equivalent refrigerant piping : 7.5m, Level differences : 0m

*4) Sound pressure was acquired in a dead room. Thus actual noise level may be different depending on the installation conditions.

*5) Specifications may be subject to change without prior notice for product improvement.

Indoor Unit (cont.)

■ 4 way cassette (cont.)

Model			AM112FN4DEH/*	AM128FN4DEH/*	AM140FN4DEH/*	
Power Supply		ø/V/Hz	1/220~240/50	1/220~240/50	1/220~240/50	
Mode*1)			HP / HR	HP / HR	HP / HR	
Performance	Capacity	Cooling*2)	kW	11.2	12.8	14.0
			Btu/h	38,200	43,600	47,700
	Heating*3)	kW	12.5	13.8	16.0	
		Btu/h	42,600	47,000	54,500	
Condensate (with High fan speed)		Liters/h	5.58	6.22	7.18	
Power	Input	W	78	73	89	
	Running Current	A	0.55	0.51	0.62	
Sound Level	Sound Pressure (Cooling / Heating)*4)	dB(A)	49 / 49	50 / 50	53 / 53	
Fan	Type		Turbo Fan	Turbo Fan	Turbo Fan	
	Motor	Model	DAI33585ZLB	DAI33585ZLB	DAI33585ZLB	
		Type		BLDC	BLDC	BLDC
		Output		*5)	*5)	*5)
Airflow Rate	H/M/L (UL)	CMM	26.00/24.00/22.00	28.00/26.00/23.00	30.00/28.00/26.00	
		l/s	433.33/400.00/366.67	466.67/433.33/383.33	500.00/466.67/433.33	
Refrigerant	Type		R410A	R410A	R410A	
	Control Method		EEV	EEV	EEV	
Temperature Control			Micom & Thermistors	Micom & Thermistors	Micom & Thermistors	
Safety Devices			Fuse	Fuse	Fuse	
Piping Connections	Liquid (Flare)	ø, mm	9.52	9.52	9.52	
	Gas (Flare)	ø, mm	15.88	15.88	15.88	
	Drain (Quick Lock)	ø, mm	VP25 (OD 32,ID 25)	VP25 (OD 32,ID 25)	VP25 (OD 32,ID 25)	
Weight	Net Weight	kg	17.0	19.0	19.0	
	Shipping Weight	kg	20.0	22.5	22.5	
Dimensions	Net Dimensions (W x H x D)	mm	840x246x840	840x288x840	840x288x840	
	Shipping Dimensions (W x H x D)	mm	898x316x898	898x357x898	898x357x898	
Panel Size	Model		PC4NUSKAN	PC4NUSKAN	PC4NUSKAN	
	Net Weight	kg	5.8	5.8	5.8	
	Shipping Weight	kg	8.4	8.4	8.4	
	Net Dimensions (W x H x D)	mm	950 x 45 x 950	950 x 45 x 950	950 x 45 x 950	
	Shipping Dimensions (W x H x D)	mm	1005 x 100 x 1005	1005 x 100 x 1005	1005 x 100 x 1005	
Functions	Auto Restart		O	O	O	
	Auto Swing		O	O	O	
	Group/Individual Control		O	O	O	
	External Contact Control		O	O	O	
	Trouble Shooting by LED		O	O	O	
Standard Accessories	Installation Manual		O	O	O	
	Operation Manual		X	X	X	
	Pattern Sheet for Installation		O	O	O	
	Flexible Drain Hose		O	O	O	
	Filter / Safety Grille		Filter / Safety Grille	Filter / Safety Grille	Filter / Safety Grille	
Drain Pump (Pumping speed, lift)	ℓ/h,mm	24, 750	24, 750	24, 750		
Optional Accessories	Wireless Remote Controller		AR-DH00	AR-DH00	AR-DH00	
	Wired Remote Controller		MWR-WE10N	MWR-WE10N	MWR-WE10N	
			MWR-WS00	MWR-WS00	MWR-WS00	
External Contact Interface Module		MIM-B14	MIM-B14	MIM-B14		



*1) Mode

- HP : Heat Pump, HR : Heat Recovery

*2) Nominal cooling capacities are based on;

- Indoor temperature : 27°C DB, 19°C WB

- Outdoor temperature : 35°C DB, 24°C WB, Equivalent refrigerant piping : 7.5m, Level differences : 0m

*3) Nominal heating capacities are based on;

- Indoor temperature : 20°C DB, 15°C WB

- Outdoor temperature : 7°C DB, 6°C WB, Equivalent refrigerant piping : 7.5m, Level differences : 0m

*4) Sound pressure was acquired in a dead room. Thus actual noise level may be different depending on the installation conditions.

*5) Specifications may be subject to change without prior notice for product improvement.

Indoor Unit (cont.)

■ Global 4Way Cassette(600x600)

Model			AM015HNNDEH/EU	AM022FNNDDEH*	AM028FNNDDEH*	AM036FNNDDEH*	
Power Supply		ø/V/Hz	1,2,220-240,50	1,2,220-240,50	1,2,220-240,50	1,2,220-240,50	
Mode*1)			HP/HR	HP/HR	HP/HR	HP/HR	
Performance	Capacity (Nominal)	Cooling*2)	kW	1.5	2.2	2.8	3.6
			Btu/h	5,100	7,500	9,600	12,300
		Heating*3)	kW	2.2	2.5	3.2	4
			Btu/h	7,500	8,500	10,900	13,600
Power	Power Input (Nominal)	Cooling*2) Heating*3)	W	18	18	18	20
			18	18	18	20	
	Current Input (Nominal)	Cooling*2) Heating*3)	A	0.17	0.17	0.17	0.19
			0.17	0.17	0.17	0.19	
Fan	Motor	Type	-	Turbo Fan	Turbo Fan	Turbo Fan	Turbo Fan
		Output	W	65 x 1	65 x 1	65 x 1	65 x 1
	Air Flow Rate	H/M/L (UL)	CMM	8.50/7.20/6.50	9.80/8.60/7.40	10.60/9.40/8.20	11.40/10.20/9.00
			CFM	300/260/230	350/300/260	370/330/290	400/360/320
	External Pressure	Min / Std / Max	mmAq	-	-	-	-
Pa			-	-	-	-	
Piping Connections	Liquid (Flare)	ø, mm	6.35	6.35	6.35	6.35	
		ø, inch	1/4	1/4	1/4	1/4	
	Gas (Flare)	ø, mm	12.7	12.7	12.7	12.7	
		ø, inch	1/2	1/2	1/2	1/2	
Drain (Quick Lock)	ø, mm	VP25 (OD 32,ID 25)	VP25 (OD 32,ID 25)	VP25 (OD 32,ID 25)	VP25 (OD 32,ID 25)		
Field Wiring	Power Source Wire	Below 20m / over 20m	mm ²	1.5 ~ 2.5	1.5 ~ 2.5	1.5 ~ 2.5	1.5 ~ 2.5
	Transmission Cable		mm ²	0.75 ~ 1.50	0.75 ~ 1.50	0.75 ~ 1.50	0.75 ~ 1.50
Refrigerant	Type		-	R410A	R410A	R410A	R410A
	Control Method		-	EEV INCLUDED	EEV INCLUDED	EEV INCLUDED	EEV INCLUDED
Sound	Sound Pressure	COOLING / HEATING (HIGH)	dBa	38/40	38/40	40/40	42/40
Dimensions	Net Weight		kg	12.0	12.0	12.0	12.0
	Shipping Weight		kg	14.0	14.0	14.0	14.0
	Net Dimensions (W x H x D)		mm	575 x 250 x 575	575 x 250 x 575	75 x 250 x 575	575 x 250 x 575
	Shipping Dimensions (W x H x D)		mm	623 x 298 x 653	623 x 298 x 653	623 x 298 x 623	623 x 298 x 653
Panel Size	Panel model		-	PC4SUSMAN/PC4SUSMEN	PC4SUSMAN/PC4SUSMEN	PC4SUSMAN/PC4SUSMEN	PC4SUSMAN/PC4SUSMEN
	Panel Net Weight		-	2.7	2.7	2.7	2.7
	Shipping Weight		-	4.2	4.2	4.2	4.2
	Net Dimensions (WxHxD)		-	670 x 45 x 670	670 x 45 x 670	670 x 45 x 670	670 x 45 x 670
	Shipping Dimensions (WxHxD)		-	714 x 106 x 724	714 x 106 x 724	714 x 106 x 724	714 x 106 x 724
Additional Accessories	Drain pump	Drain pump	- / Model	Built-in	Built-in	Built-in	Built-in
		Max. lifting Height / Displacement	mm/liter/h	750/24	750/24	750/24	750/24
	Air Filter		-	Long life filter	Long life filter	Long life filter	Long life filter



*1) Mode

- HP : Heat Pump, HR : Heat Recovery

*2) Nominal cooling capacities are based on;

- Indoor temperature : 27°C DB, 19°C WB

- Outdoor temperature : 35°C DB, 24°C WB, Equivalent refrigerant piping : 7.5m, Level differences : 0m

*3) Nominal heating capacities are based on;

- Indoor temperature : 20°C DB, 15°C WB

- Outdoor temperature : 7°C DB, 6°C WB, Equivalent refrigerant piping : 7.5m, Level differences : 0m

*4) Sound pressure was acquired in a dead room. Thus actual noise level may be different depending on the installation conditions.

*5) Specifications may be subject to change without prior notice for product improvement.

Indoor Unit (cont.)

■ Global 4Way Cassette(600x600) (cont.)

Model			AM045FNDEH*	AM056FNDEH*	AM060FNDEH*
Power Supply			ø/V/Hz	1,2,220-240,50	1,2,220-240,50
Mode*1)			-	HP/HR	HP/HR
Performance	Capacity (Nominal)	Cooling*2)	kW	4.50	5.60
			Btu/h	15,400	19,100
		Heating*3)	kW	5.00	6.30
			Btu/h	17,100	21,500
Power	Power Input (Nominal)	Cooling*2)	W	23.00	28.00
		Heating*3)	W	23.00	28.00
	Current Input (Nominal)	Cooling*2)	A	0.22	0.27
		Heating*3)	A	0.22	0.27
Fan	Motor	Type	-	Turbo Fan	Turbo Fan
		Output	W	65 x 1	65 x 1
	Air Flow Rate	H/M/L (UL)	CMM	12.20/11.00/9.80	13.40/11.80/10.20
			CFM	430/390/350	470/420/360
	External Pressure	Min / Std / Max	mmAq	-	-
Pa			-	-	
Piping Connections	Liquid (Flare)	ø, mm	6.35	6.35	
		ø, inch	1/4	1/4	
	Gas (Flare)	ø, mm	12.7	12.7	
		ø, inch	1/2	1/2	
	Drain (Quick Lock)	ø, mm	VP25 (OD 32,ID 25)	VP25 (OD 32,ID 25)	
Field Wiring	Power Source Wire	mm ²	1.5 ~ 2.5	1.5 ~ 2.5	
	Transmission Cable	mm ²	0.75 ~ 1.50	0.75 ~ 1.50	
Refrigerant	Type	-	R410A	R410A	
	Control Method	-	EEV INCLUDED	EEV INCLUDED	
Sound	Sound Pressure	COOLING / HEATING (HIGH)	dBA	43/43	46/47
Dimensions	Net Weight		kg	12	12
	Shipping Weight		kg	14	14
	Net Dimensions (W x H x D)		mm	575 x 250 x 575	575 x 250 x 575
	Shipping Dimensions (W x H x D)		mm	623 x 298 x 653	623 x 298 x 653
Panel Size	Panel model		-	PC4SUSMAN/PC4SUSMEN	PC4SUSMAN/PC4SUSMEN
	Panel Net Weight		kg	2.7	2.7
	Shipping Weight		kg	4.2	4.2
	Net Dimensions (WxHxD)		mm	670 x 45 x 670	670 x 45 x 670
	Shipping Dimensions (WxHxD)		mm	714 x 106 x 724	714 x 106 x 724
Additional Accessories	Drain pump	Drain pump	- / Model	Built-in	Built-in
		Max. lifting Height / Displacement	mm/liter/h	750/24	750/24
	Air Filter		-	Long life filter	Long life filter



*1) Mode

- HP : Heat Pump, HR : Heat Recovery

*2) Nominal cooling capacities are based on;

- Indoor temperature : 27°C DB, 19°C WB

- Outdoor temperature : 35°C DB, 24°C WB, Equivalent refrigerant piping : 7.5m, Level differences : 0m

*3) Nominal heating capacities are based on;

- Indoor temperature : 20°C DB, 15°C WB

- Outdoor temperature : 7°C DB, 6°C WB, Equivalent refrigerant piping : 7.5m, Level differences : 0m

*4) Sound pressure was acquired in a dead room. Thus actual noise level may be different depending on the installation conditions.

*5) Specifications may be subject to change without prior notice for product improvement.

Indoor Unit (cont.)

■ 4Way Cassette(600x600)

Model			AM028HNNDEH/TL	AM036HNNDEH/TL	AM045HNNDEH/TL	
Power Supply			1,2,220-240,50	1,2,220-240,50	1,2,220-240,50	
Mode*1)			HP/HR	HP/HR	HP/HR	
Performance	Capacity (Nominal)	Cooling*2)	kW	2.8	3.6	4.5
			Btu/h	9,600	12,300	15,400
		Heating*3)	kW	3.2	4	5
			Btu/h	10,900	13,600	17,100
Power	Power Input (Nominal)	Cooling*2)	W	120	120	120
		Heating*3)		120	120	120
	Current Input (Nominal)	Cooling*2)	A	0.87	0.87	0.89
		Heating*3)		0.87	0.87	0.89
Fan	Motor	Type	-	Turbo Fan	Turbo Fan	Turbo Fan
		Output	W	40 x 1	40 x 1	40 x 1
	Air Flow Rate	H/M/L (UL)	CMM	11.8/10.8/9.8	12/11/10	13/12/11
	External Pressure	Min / Std / Max	mmAq	-	-	-
Pa			-	-	-	
Piping Connections	Liquid (Flare)	ø, mm	6.35	6.35	6.35	
		ø, inch	1/4"	1/4"	1/4"	
	Gas (Flare)	ø, mm	12.70	12.70	12.70	
		ø, inch	1/2"	1/2"	1/2"	
Drain (Quick Lock)	ø, mm	VP25 (OD 32,ID 25)	VP25 (OD 32,ID 25)	VP25 (OD 32,ID 25)		
Field Wiring	Power Source Wire	mm ²	2.5	2.5	2.5	
	Transmission Cable	mm ²	VCTF 0.75 ~ 1.5	VCTF 0.75 ~ 1.5	VCTF 0.75 ~ 1.5	
Refrigerant	Type	-	R410A	R410A	R410A	
	Control Method	-	EEV INCLUDED	EEV INCLUDED	EEV INCLUDED	
Sound	Sound Pressure	H/M/L	dBa	40 / 36 / 34	40 / 36 / 34	43 / 41 / 38
Dimensions	Net Weight		kg	16.0	16.0	16.0
	Shipping Weight		kg	18.4	18.4	18.4
	Net Dimensions (W x H x D)		mm	575 x 260 x 575	575 x 260 x 575	575 x 260 x 575
	Shipping Dimensions (W x H x D)		mm	669 x 339 x 644	669 x 339 x 644	669 x 339 x 644
Panel Size	Panel model		-	PC4SUSE1N	PC4SUSE1N	PC4SUSE1N
	Panel Net Weight		kg	3.0	3.0	3.0
	Shipping Weight		kg	5.0	5.0	5.0
	Net Dimensions (WxHxD)		mm	670 x 35 x 670	670 x 35 x 670	670 x 35 x 670
	Shipping Dimensions (WxHxD)		mm	723 x 117 x 723	723 x 117 x 723	723 x 117 x 723
Additional Accessories"	Drain pump	Drain pump	- / Model	Built-in	Built-in	Built-in
		Max. lifting Height / Displacement	mm/liter/h	750/24	750/24	750/24
	Air Filter		-	Pre filter	Pre filter	Pre filter



*1) Mode

- HP : Heat Pump, HR : Heat Recovery

*2) Nominal cooling capacities are based on;

- Indoor temperature : 27°C DB, 19°C WB

- Outdoor temperature : 35°C DB, 24°C WB, Equivalent refrigerant piping : 7.5m, Level differences : 0m

*3) Nominal heating capacities are based on;

- Indoor temperature : 20°C DB, 15°C WB

- Outdoor temperature : 7°C DB, 6°C WB, Equivalent refrigerant piping : 7.5m, Level differences : 0m

*4) Sound pressure was acquired in a dead room. Thus actual noise level may be different depending on the installation conditions.

*5) Specifications may be subject to change without prior notice for product improvement.

Indoor Unit (cont.)

■ Slim duct

Model			AM017FNLDEH/EU	AM022FNLDEH*	AM028FNLDEH*	AM036FNLDEH*	AM045FNLDEH*	AM056FNLDEH*	AM071FNLDEH*	AM090FNLDEH/EU	AM112FNLDEH/EU	AM128FNLDEH/EU	AM140FNLDEH/EU	
Power Supply			ø/V/Hz	1/220~240/50	1/220~240/50	1/220~240/50	1/220~240/50	1/220~240/50	1/220~240/50	1/220~240/50	1/220~240/50	1/220~240/50	1/220~240/50	
Mode*1)				HP / HR	HP / HR	HP / HR	HP / HR	HP / HR	HP / HR	HP / HR	HP / HR	HP / HR	HP / HR	
Performance	Capacity	Cooling*2)	kW	1.7	2.2	2.8	3.6	4.5	5.6	7.1	9.0	11.2	12.8	14.0
		Heating*3)	kW	4,600	7,500	9,500	12,200	15,300	19,100	24,200	30,700	38,200	43,600	47,700
	Btu/h		1.9	2.5	3.2	4.0	5.0	6.3	8.0	10.0	12.5	13.8	16.0	
	Btu/h	5,200	8,500	10,900	13,600	17,000	21,400	27,200	34,100	42,600	47,000	54,500		
Condensate (with High fan speed)			Liters/h	0.80	1.12	1.28	2.07	2.39	2.87	3.83	4.63	4.95	5.26	
Power			Input	W	55	55	60	65	90	95	120	170	200	220
Running Current			A	0.3	0.3	0.32	0.33	0.52	0.53	0.6	0.96	0.96	1.28	1.43
Sound Level			Sound Pressure *4)	dB(A)	37	37	37	40	43	47 / 47	43 / 44	43 / 44	45 / 46	45 / 46
Fan	Type		-	Sirocco Fan	Sirocco Fan	Sirocco Fan	Sirocco Fan	Sirocco Fan	Sirocco Fan	Sirocco Fan	Sirocco Fan	Sirocco Fan	Sirocco Fan	
	Motor	Model	-	YSK95-28-4-B	YSK95-28-4-B	YSK95-28-4-B	YSK95-28-4-B	YSK110-50-4SM	YSK110-50-4SM	YSK140-60-4B	DL-12840SSBC	DL-12840SSBC	DL-12840SSBC	DL-12840SSBC
		Type	-	Non Feedback SSR	Non Feedback SSR	Non Feedback SSR	Non Feedback SSR	Non Feedback SSR	Non Feedback SSR	Non Feedback SSR	BLDC	BLDC	BLDC	BLDC
Output		W	*5)	*5)	*5)	*5)	*5)	*5)	*5)	*5)	*5)	*5)	*5)	
Airflow Rate	Cooling (High)		m ³ /min	5.0	4	7.5	7.5	11.0	12.0	16.5	29.0	31.2	34.0	36.0
	Heating (High)		m ³ /min	5.5	8.2	9.0	9.0	14.0	15.0	20.0	34.0	34.0	36.0	38.0
	External Static Pressure	Standard (Min~Max)	mmHzO	1(0~3)	1(0~3)	1(0~3)	1(0~3)	2(0~4)	2(0~4)	2(0~4)	3(0~6)	3(0~6)	3(0~6)	3(0~6)
Refrigerant	Type		-	R410A	R410A	R410A	R410A	R410A	R410A	R410A	R410A	R410A	R410A	
	Control Method		-	EEV	EEV	EEV	EEV	EEV	EEV	EEV	EEV	EEV	EEV	
Temperature Control			-	Micom & Thermistors	Micom & Thermistors	Micom & Thermistors	Micom & Thermistors	Micom & Thermistors	Micom & Thermistors	Micom & Thermistors	Micom & Thermistors	Micom & Thermistors	Micom & Thermistors	
Safety Devices			-	Fuse	Fuse	Fuse	Fuse	Fuse	Fuse	Fuse	Fuse	Fuse	Fuse	
Piping Connections	Liquid (Flare)		ø, mm	6.35	6.35	6.35	6.35	6.35	6.35	9.52	9.52	9.52	9.52	
	Gas (Flare)		ø, mm	12.7	12.7	12.7	12.7	12.7	12.7	15.88	15.88	15.88	15.88	
	Drain		ø, mm	VP25 (OD 32,ID 25)	VP25 (OD 32,ID 25)	VP25 (OD 32,ID 25)	VP25 (OD 32,ID 25)	VP25 (OD 32,ID 25)	VP25 (OD 32,ID 25)	VP25 (OD 32,ID 25)	VP25 (OD 32,ID 25)	VP25 (OD 32,ID 25)	VP25 (OD 32,ID 25)	
Weight	Net Weight		kg	19.0	19.0	19.0	19.5	23.5	23.5	30.0	44.0	44.0	46.0	46.0
	Shipping Weight		kg	23.0	23.0	23.0	23.5	28.0	28.0	35.0	52.0	52.0	54.0	54.0
Dimensions	Net Dimensions (W x H x D)		mm	700x199x600	700x199x600	700x199x600	700x199x600	900x199x600	900x199x600	1,100x199x600	1,300x295x690	1,300x295x690	1,300x295x690	
	Shipping Dimensions (W x H x D)		mm	950x270x710	950x270x710	950x270x710	950x270x710	1150x280x710	1150x280x710	1350x280x710	1575x370x835	1575x370x835	1575x370x835	
Functions	Auto Restart		-	O	O	O	O	O	O	O	O	O	O	
	Auto Swing		-	X	X	X	X	X	X	X	X	X	X	
	Group/Individual Control		-	O	O	O	O	O	O	O	O	O	O	
	External Contact Control		-	O	O	O	O	O	O	O	O	O	O	
	Trouble Shooting by LED		-	X	X	X	X	X	X	X	X	X	X	
Standard Accessories	Installation Manual		-	O	O	O	O	O	O	O	O	O	O	
	Operation Manual		-	O	O	O	O	O	O	O	O	O	O	
	Pattern Sheet for Installation		-	X	X	X	X	X	X	X	X	X	X	
	Flexible Drain Hose		-	O	O	O	O	O	O	O	O	O	O	
	Filter / Safety Grille		-	Filter (Washable)	Filter (Washable)	Filter (Washable)	Filter (Washable)	Filter (Washable)	Filter (Washable)	Filter (Washable)	Filter (Washable)	Filter (Washable)	Filter (Washable)	
Drain Pump (Pumping speed, lift)			-	MR-BH01	MR-BH01	MR-BH01	MR-BH01	MR-BH01	MR-BH01	MR-BH01	MR-BH01	MR-BH01	MR-BH01	
Wireless Remote Controller			-	MR-DH00	MR-DH00	MR-DH00	MR-DH00	MR-DH00	MR-DH00	MR-DH00	MR-DH00	MR-DH00	MR-DH00	
Optional Accessories	Duct Receiver Kits	Receiver	-	MRK-A10	MRK-A10	MRK-A10	MRK-A10	MRK-A10	MRK-A10	MRK-A10	MRK-A10	MRK-A10	MRK-A10	
		Receiver Wire	-	MRW-10A	MRW-10A	MRW-10A	MRW-10A	MRW-10A	MRW-10A	MRW-10A	MRW-10A	MRW-10A	MRW-10A	
	Wired Remote Controller	Simplified	-	MWR-WE10N	MWR-WE10N	MWR-WE10N	MWR-WE10N	MWR-WE10N	MWR-WE10N	MWR-WE10N	MWR-WE10N	MWR-WE10N	MWR-WE10N	
	External Contact Interface Module		-	MIM-B14	MIM-B14	MIM-B14	MIM-B14	MIM-B14	MIM-B14	MIM-B14	MIM-B14	MIM-B14	MIM-B14	
	Drain Pump		-	MDP-E075SEE3D	MDP-E075SEE3D	MDP-E075SEE3D	MDP-E075SEE3D	MDP-E075SEE3D	MDP-E075SEE3D	MDP-E075SEE3D	MDP-E075SEE3D	MDP-E075SEE3D	MDP-E075SEE3D	



- *1) Mode
- HP : Heat Pump, HR : Heat Recovery
- *2) Nominal cooling capacities are based on;
- Indoor temperature : 27°C DB, 19°C WB
- Outdoor temperature : 35°C DB, 24°C WB, Equivalent refrigerant piping : 7.5m, Level differences : 0m
- *3) Nominal heating capacities are based on;
- Indoor temperature : 20°C DB, 15°C WB
- Outdoor temperature : 7°C DB, 6°C WB, Equivalent refrigerant piping : 7.5m, Level differences : 0m
- *4) Sound pressure was acquired in a dead room. Thus actual noise level may be different depending on the installation conditions.
- *5) Specifications may be subject to change without prior notice for product improvement.

Indoor Unit (cont.)

■ Slim Home Duct

Model			AM017KNLDEH/EU	AM022KNLDEH*	AM028KNLDEH*	AM036KNLDEH*	
Power Supply		ø, #, V, Hz	1,220~240,50	1,220~240,50	1,220~240,50	1,220~240,50	
Mode		-	HP	HP	HP	HP	
Performance	Capacity (Nominal)	Cooling 2)	kW	1.7	2.2	2.8	3.6
			Btu/h	4,600	7,500	9,500	12,200
		Heating 2)	kW	1.9	2.5	3.2	4.0
			Btu/h	5,200	8,500	10,900	13,600
	Condensate (with high fan speed)		Liter/h				
Power	Input	W	28	30	34	40	
	Running Current	A	0.23	0.25	0.28	0.33	
Sound Level	Sound Pressure *4)	dB(A)	31	32	34	36	
Fan	Type	-	Sirocco Fan	Sirocco Fan	Sirocco Fan	Sirocco Fan	
	Motor	Model	-	DB31-00670A	DB31-00670A	DB31-00670A	DB31-00670A
		Type	-	BLDC Feedback	BLDC Feedback	BLDC Feedback	BLDC Feedback
		Output	W	69	69	69	69
Airflow Rate	Cooling (High)	m3/min	4.8	5.4	6.4	7.3	
	Heating (High)	m3/min	6.75	7.35	8.5	9.75	
Refrigerant	Type	-	R410A	R410A	R410A	R410A	
	Control Method	-	EDM EEV 2.4C Sanhua	EDM EEV 2.4C Sanhua	EDM EEV 2.4C Sanhua	EDM EEV 2.4C Sanhua	
Temperature Control		-	Micom&Thermistors	Micom&Thermistors	Micom&Thermistors	Micom&Thermistors	
Safety Devices		-	Fuse:3.15A/1.6A	Fuse:3.15A/1.6A	Fuse:3.15A/1.6A	Fuse:3.15A/1.6A	
Piping Connections	Liquid (Flare)	ø, mm	6.35	6.35	6.35	6.35	
	Gas (Flare)	ø, mm	12.7	12.7	12.7	12.7	
	Drain	ø, mm	VP25 (OD 32,ID 25)	VP25 (OD 32,ID 25)	VP25 (OD 32,ID 25)	VP25 (OD 32,ID 25)	
Weight	Net Weight	kg	15.3	15.3	15.3	15.7	
	Shipping Weight	kg	18.2	18.2	18.2	18.6	
Dimensions	Net Dimensions (W x H x D)	mm	700*199*440	700*199*440	700*199*440	700*199*440	
	Shipping Dimensions (W x H x D)	mm	949*280*544	949*280*544	949*280*544	949*280*544	
Functions	Auto Restart	-	O	O	O	O	
	Auto Swing	-	X	X	X	X	
	Group/Individual Control	-	O	O	O	O	
	External Contact Control	-	O	O	O	O	
	Trouble Shooting by LED	-	X	X	X	X	
Standard Accessories	Installation Manual	-	O	O	O	O	
	Operation Manual	-	O	O	O	O	
	Pattern Sheet for Installation	-	X	X	X	X	
	Flexible Drain Hose	-	O	O	O	O	
	Filter / Safety Grille	-	Filter(Washable)	Filter(Washable)	Filter(Washable)	Filter(Washable)	
Optional Accessories	Wireless Remote Controller	-	MR-DH00	MR-DH00	MR-DH00	MR-DH00	
	Duct Receiver Kits	Receiver	-	MRK-A10	MRK-A10	MRK-A10	MRK-A10
		Receiver Wire	-	MRW-10A	MRW-10A	MRW-10A	MRW-10A
	Wired Remote Controller	Simplified	-	MWR-WE10N	MWR-WE10N	MWR-WE10N	MWR-WE10N
	External Contact Interface Module	-	MIM-B14	MIM-B14	MIM-B14	MIM-B14	



*1) Mode

- HP : Heat Pump, HR : Heat Recovery

*2) Nominal cooling capacities are based on;

- Indoor temperature : 27°C DB, 19°C WB

- Outdoor temperature : 35°C DB, 24°C WB, Equivalent refrigerant piping : 7.5m, Level differences : 0m

*3) Nominal heating capacities are based on;

- Indoor temperature : 20°C DB, 15°C WB

- Outdoor temperature : 7°C DB, 6°C WB, Equivalent refrigerant piping : 7.5m, Level differences : 0m

*4) Sound pressure was acquired in a dead room. Thus actual noise level may be different depending on the installation conditions.

*5) Specifications may be subject to change without prior notice for product improvement.

Indoor Unit (cont.)

■ Duct Type (Uplevel Static Pressure)

Model			AM022FNMDEH/EU	AM028FNMDEH/EU	AM036FNMDEH/EU	AM045FNMDEH/EU	
Power Supply			ø/V/Hz	1/220~240/50	1/220~240/50	1/220~240/50	
Mode*1)				HP / HR	HP / HR	HP / HR	
Performance	Capacity	Cooling*2)	kW	2.2	2.8	3.6	4.5
			Btu/h	7,500	9,500	12,200	15,300
		Heating*3)	kW	2.5	3.2	4.0	5.0
			Btu/h	8,500	10,900	13,600	17,000
Power	Input	W	80	80	85	125	
	Running Current	A	0.4	0.4	0.55	1.15	
Sound Level	Sound Pressure (Cooling/Heating) *4)		dB(A)	37 / 38	38/39	39/40	44 / 46
Fan	Type		-	Sirocco Fan	Sirocco Fan	Sirocco Fan	Sirocco Fan
	Motor	Model	-	YSK110-25-4SM	YSK110-25-4SM	YSK110-50-4SM	YSK140-200-4E1
		Type	-	Non Feedback SSR	Non Feedback SSR	Non Feedback SSR	Non Feedback SSR
		Output	W	*5)	*5)	*5)	*5)
Airflow Rate	Cooling (High)		m ³ /min	7.7	8.8	11.0	13.0
	Heating (High)		m ³ /min	8.9	10.3	12.7	14.5
	External Static Pressure	Standard(Min.~Max)	mmHzO	2 (0~4)	2 (0~4)	2 (0~4)	4 (0~8)
Refrigerant	Type		-	R410A	R410A	R410A	R410A
	Control Method		-	EEV	EEV	EEV	EEV
Temperature Control			-	Micom&Thermistors	Micom&Thermistors	Micom&Thermistors	Micom&Thermistors
Safety Devices			-	Fuse	Fuse	Fuse	Fuse
Piping Connections	Liquid (Flare)		ø, mm	6.35	6.35	6.35	6.35
	Gas (Flare)		ø, mm	12.7	12.7	12.7	12.7
	Drain		ø, mm	VP25 (OD 32,ID 25)	VP25 (OD 32,ID 25)	VP25 (OD 32,ID 25)	VP25 (OD 32,ID 25)
Weight	Net Weight		kg	23.5	23.5	23.5	29.0
	Shipping Weight		kg	28.0	28.0	28.0	33.0
Dimensions	Net Dimensions (W x H x D)		mm	900×199×600	900×199×600	900×199×600	900×260×480
	Shipping Dimensions (W x H x D)		mm	1150×280×710	1150×280×710	1150×280×710	1170×595×340
Functions	Auto Restart		-	O	O	O	O
	Auto Swing		-	X	X	X	X
	Group/Individual Control		-	O	O	O	O
	External Contact Control		-	O	O	O	O
	Trouble Shooting by LED		-	X	X	X	X
Standard Accessories	Installation Manual		-	O	O	O	O
	Operation Manual		-	O	O	O	O
	Pattern Sheet for Installation		-	X	X	X	X
	Flexible Drain Hose		-	O	O	O	O
	Filter / Safety Grille		-	Filter (Washable)	Filter (Washable)	Filter (Washable)	Filter (Washable)
	Drain Pump (Pumping speed, lift)		-	MR-BH01	MR-BH01	MR-BH01	MR-BH01
Optional Accessories	Wireless Remote Controller		-	MR-DH00	MR-DH00	MR-DH00	MR-DH00
	Duct Receiver Kits	Receiver	-	MRK-A10	MRK-A10	MRK-A10	MRK-A10
		Receiver Wire	-	MRW-10A	MRW-10A	MRW-10A	MRW-10A
	Wired Remote Controller	Simplified	-	MWR-WE10N	MWR-WE10N	MWR-WE10N	MWR-WE10N
	External Contact Interface Module			MIM-B14	MIM-B14	MIM-B14	MIM-B14
	Drain Pump			MDP-E075SEE3D	MDP-E075SEE3D	MDP-E075SEE3D	MDP-E075SEE3D



*1) Mode

- HP : Heat Pump, HR : Heat Recovery

*2) Nominal cooling capacities are based on;

- Indoor temperature : 27°C DB, 19°C WB

- Outdoor temperature : 35°C DB, 24°C WB, Equivalent refrigerant piping : 7.5m, Level differences : 0m

*3) Nominal heating capacities are based on;

- Indoor temperature : 20°C DB, 15°C WB

- Outdoor temperature : 7°C DB, 6°C WB, Equivalent refrigerant piping : 7.5m, Level differences : 0m

*4) Sound pressure was acquired in a dead room. Thus actual noise level may be different depending on the installation conditions.

*5) Specifications may be subject to change without prior notice for product improvement.

Indoor Unit (cont.)

■ MSP duct

Model			AM056FNMDH*	AM071FNMDH*	AM090FNMDH*	AM112FNMDH*	AM128FNMDH*	AM140FNMDH*	AM160KNMDH*	
Power Supply		øV/Hz	1/220~240/50	1/220~240/50	1/220~240/50	1/220~240/50	1/220~240/50	1/220~240/50	1/220~240/50	
Mode*1)			HP / HR	HP / HR	HP / HR	HP / HR	HP / HR	HP / HR	HP / HR	
Performance	Capacity	Cooling*2)	kW	5.6	7.1	9	11.2	12.8	14	16.0
			Btu/h	19,100	24,200	30,700	38,200	43,600	47,700	54,000
		Heating*3)	kW	6.3	8.0	10.0	12.5	13.8	16.0	18.0
			Btu/h	21,400	27,200	34,100	42,600	47,000	54,500	60,000
Condensate (with High fan speed)		Liters/h				4.63	4.95	5.1	-	
Power	Input	W	130 ⁵⁾	190 ⁵⁾	240 ⁵⁾	260	370	410	485	
	Running Current	A	1.10 ⁵⁾	1.25 ⁵⁾	1.30 ⁵⁾	1.17	1.67	1.86	2.24	
Sound Level	Sound Pressure *4)	dB(A)	47	47	50	48	50	50	53	
Fan	Type		Sirocco Fan	Sirocco Fan	Sirocco Fan	Sirocco Fan	Sirocco Fan	Sirocco Fan	Sirocco Fan	
	Motor	Model	YSK140-200-4E1	YSK140-200-4E1	YSK140-200-4	YSK140-200-4	Y75423C015	Y75423C015	Y75423C015	
		Type		Non Feedback SSR	Non Feedback SSR	Non Feedback SSR	Non Feedback SSR	Non Feedback SSR	Non Feedback SSR	
		Output	W	-	-	-	-	-	-	
Airflow Rate	Cooling (High)	m ³ /min	14.5	18.5	19.5	27.0	32.0	37.0	39.5	
	Heating (High)	m ³ /min	15.5	20.0	21.5	27.0	31.0	36.0	42.0	
	External Static Pressure	Standard/Min~Max)	mmHzO	4(0~8)	4(0~8)	6(4~8)	8(4~12)	8(4~12)	8(4~12)	8(4~14)
Refrigerant	Type		R410A	R410A	R410A	R410A	R410A	R410A	R410A	
	Control Method		EEV	EEV	EEV	EEV	EEV	EEV	EEV	
Temperature Control			Micom&Thermistors	Micom&Thermistors	Micom&Thermistors	Micom&Thermistors	Micom&Thermistors	Micom&Thermistors	Micom&Thermistors	
Safety Devices			Fuse	Fuse	Fuse	Fuse	Fuse	Fuse	Fuse	
Piping Connections	Liquid (Flare)	ø, mm	6.35	9.52	9.52	9.52	9.52	9.52	9.52	
	Gas (Flare)	ø, mm	12.7	15.88	15.88	15.88	15.88	15.88	15.88	
	Drain	ø, mm	VP25 (OD 32,ID 25)	VP25 (OD 32,ID 25)	VP25 (OD 32,ID 25)	VP25 (OD 32,ID 25)	VP25 (OD 32,ID 25)	VP25 (OD 32,ID 25)	VP20 (OD 25, ID 20)	
Weight	Net Weight	kg	29.0	29.0	34.0	36.0	52.0	52.0	50	
	Shipping Weight	kg	33.0	33.0	39.0	42.0	59.0	59.0	57	
Dimensions	Net Dimensions (W x H x D)	mm	900x260x480	900x260x480	1,150x260x480	1,150x320x480	1,200x360x650	1,200x360x650	1,200x360x650	
	Shipping Dimensions (W x H x D)	mm	1170x595x340	1170x595x340	1420x595x340	1150x320x480	1480x790x420	1480x790x420	1480x790x420	
Functions	Auto Restart		O	O	O	O	O	O	O	
	Auto Swing		X	X	X	X	X	X	X	
	Group/Individual Control		O	O	O	O	O	O	O	
	External Contact Control		O	O	O	O	O	O	O	
	Trouble Shooting by LED		X	X	X	X	X	X	X	
Standard Accessories	Installation Manual		O	O	O	O	O	O	O	
	Operation Manual		O	O	O	O	O	O	O	
	Pattern Sheet for Installation		X	X	X	X	X	X	X	
	Flexible Drain Hose		O	O	O	O	O	O	O	
	Filter / Safety Grille		Filter (Washable)	Filter (Washable)	Filter (Washable)	Filter (Washable)	Filter (Washable)	Filter (Washable)	Filter (Washable)	
Optional Accessories	Wireless Remote Controller		MR-DH00	MR-DH00	MR-DH00	MR-DH00	MR-DH00	MR-DH00	MR-DH00	
	Duct Receiver Kits	Receiver	MRK-A10	MRK-A10	MRK-A10	MRK-A10	MRK-A10	MRK-A10	MRK-A10	
		Receiver Wire	MRW-10A	MRW-10A	MRW-10A	MRW-10A	MRW-10A	MRW-10A	MRW-10A	
	Wired Remote Controller	Simplified	MWR-WE10N	MWR-WE10N	MWR-WE10N	MWR-WE10N	MWR-WE10N	MWR-WE10N	MWR-WE10N	
	External Contact Interface Module		MIM-B14	MIM-B14	MIM-B14	MIM-B14	MIM-B14	MIM-B14	MIM-B14	
	Drain Pump		MDP-M075SGU3D	MDP-M075SGU1D	MDP-M075SGU1D	MDP-M075SGU1D	MDP-M075SGU2D	MDP-M075SGU2D	MDP-M075SGU2D	

Indoor Unit (cont.)

■ 360 cassette

Model			AM045KN4DEH*	AM056KN4DEH*	AM071KN4DEH*	AM090KN4DEH*	AM112KN4DEH*	AM128KN4DEH*	AM140KN4DEH*	
Power Supply		Φ, V, Hz	1,220-240,50	1,220-240,50	1,220-240,50	1,220-240,50	1,220-240,50	1,220-240,50	1,220-240,50	
Mode		-	HP/HR	HP/HR	HP/HR	HP/HR	HP/HR	HP/HR	HP/HR	
Performance	Capacity (Nominal)	Cooling ²⁾	kW	4.5	5.6	7.1	9.0	11.2	12.8	14.0
		Heating ²⁾	kW	5.0	6.3	8.0	10.0	12.5	13.8	16.0
Power	Power Input	Cooling ¹⁾	W	26	30	34	55	53	77	91
		Heating ²⁾	W	26	30	34	55	53	77	91
	Current Input	Cooling ¹⁾	A	0.18	0.21	0.25	0.42	0.41	0.62	0.75
		Heating ²⁾	A	0.18	0.21	0.25	0.42	0.41	0.62	0.75
Fan	Type	Type	-	Turbo Fan	Turbo Fan	Turbo Fan	Turbo Fan	Turbo Fan	Turbo Fan	
	Motor	Output x n	W	65	65	65	65	97	97	
	Air Flow Rate	H/M/L (UL)	CMM	14.5/13.5/12.5	16.0/14.5/13.5	18.0/16.0/14.0	22.0/18.5/16.0	25.5/21.0/17.5	29.5/24.0/19.0	31.5/26.5/21.0
Piping Connections	Liquid Pipe		Φ,mm	6.35	6.35	9.52	9.52	9.52	9.52	9.52
			Φ, inch	1/4	1/4	3/8	3/8	3/8	3/8	3/8
	Gas Pipe		Φ,mm	12.7	12.7	15.88	15.88	15.88	15.88	15.88
			Φ, inch	1/2	1/2	5/8	5/8	5/8	5/8	5/8
Refrigerant	Drain Pipe		Φ,mm	VP25(OD32/ID25)	VP25(OD32/ID25)	VP25(OD32/ID25)	VP25(OD32/ID25)	VP25(OD32/ID25)	VP25(OD32/ID25)	VP25(OD32/ID25)
	Type	-	-	R410A	R410A	R410A	R410A	R410A	R410A	R410A
Control Method		-	-	EEV INCLUDED	EEV INCLUDED	EEV INCLUDED	EEV INCLUDED	EEV INCLUDED	EEV INCLUDED	
External	Net Weight		kg	21	21	21	21	24	24	24
Dimension	Shipping Weight		kg	25	25	25	25	29	29	29
	Net Dimensions (WxHxD)		mm	947*281*947	947*281*947	947*281*947	947*281*947	947*365*947	947*365*947	947*365*947
	Shipping Dimensions (WxHxD)		mm	990*330*990	990*330*990	990*330*990	990*330*990	990*414*990	990*414*990	990*414*990
Panel Size (Ceiling Type)	Panel model		-	PC4NUDMAN	PC4NUDMAN	PC4NUDMAN	PC4NUDMAN	PC4NUDMAN	PC4NUDMAN	PC4NUDMAN
	Panel Net Weight		kg	3.6	3.6	3.6	3.6	3.6	3.6	3.6
	Shipping Weight		kg	6.0	6.0	6.0	6.0	6.0	6.0	6.0
	Net Dimensions (WxHxD)		mm	1000*66*1000	1000*66*1000	1000*66*1000	1000*66*1000	1000*66*1000	1000*66*1000	1000*66*1000
	Shipping Dimensions (WxHxD)		mm	1093*85*1083	1093*85*1083	1093*85*1083	1093*85*1083	1093*85*1083	1093*85*1083	1093*85*1083
Panel Size (Open Type)	Panel model		-	PC4NUNMAN	PC4NUNMAN	PC4NUNMAN	PC4NUNMAN	PC4NUNMAN	PC4NUNMAN	PC4NUNMAN
	Panel Net Weight		kg	2.7	2.7	2.7	2.7	2.7	2.7	2.7
	Shipping Weight		kg	5.1	5.1	5.1	5.1	5.1	5.1	5.1
	Net Dimensions (WxHxD)		mm	1050*94*1050	1050*94*1050	1050*94*1050	1050*94*1050	1050*94*1050	1050*94*1050	1050*94*1050
	Shipping Dimensions (WxHxD)		mm	1093*85*1083	1093*85*1083	1093*85*1083	1093*85*1083	1093*85*1083	1093*85*1083	1093*85*1083
Additional Accessories	Drain pump	Drain pump	- / Model name	Built In	Built In	Built In	Built In	Built In	Built In	Built In
		Max. lifting Height / Displacement	mm / liter/h	750/24	750/24	750/24	750/24	750/24	750/24	750/24
Functions	Auto Restart		-	0	0	0	0	0	0	0
	Auto Swing		-	0	0	0	0	0	0	0
	Group/Individual Control		-	0	0	0	0	0	0	0
	External Contact Control		-	0	0	0	0	0	0	0
	Trouble Shooting by LED		-	0	0	0	0	0	0	0
Standard Accessories	Install Manual		-	0	0	0	0	0	0	0
	User Manual		-	0	0	0	0	0	0	0
	Pattern Sheet for Installation		-	0	0	0	0	0	0	0
	Flexible Drain Hose		-	0	0	0	0	0	0	0
Optional Accessories	Wireless Remote Controller		-	MR-KH00	MR-KH00	MR-KH00	MR-KH00	MR-KH00	MR-KH00	MR-KH00
	Wired Remote Controller		-	MWR-WE10N	MWR-WE10N	MWR-WE10N	MWR-WE10N	MWR-WE10N	MWR-WE10N	MWR-WE10N
	External Contact Interface Module		-	MIM-B14	MIM-B14	MIM-B14	MIM-B14	MIM-B14	MIM-B14	MIM-B14

Indoor Unit (cont.)

■ Big Duct

Model			AM220FNHDEH/EU	AM280FNHDEH/EU	
Power Supply		ø/V/Hz	1/220-240/50	1/220-240/50	
Mode*1)			HP / HR	HP / HR	
Performance	Capacity	Cooling*2)	kW	22.4	28.0
			Btu/h	76,400	95,500
	Heating*3)	kW	25.0	31.5	
		Btu/h	85,300	107,500	
Condensate (with High fan speed)		Liters/h			
Power	Input		W	530	790
	Running Current		A	3.8	5.9
Sound Level	Sound Pressure (High/Low)*4)		dB(A)	47 / 44	48 / 45
Fan	Type		-	Sirocco Fan	Sirocco Fan
	Motor	Model	-	DL-13875SSOB	DL-13875SSOB
		Type	-	BLDC	BLDC
		Output	W		
Airflow Rate	Cooling (High)		m ³ /min	58	72
	Heating (High)		m ³ /min	58	72
	External Static Pressure	Standard(Min.~Max)	mmHzO	15(5-25)	15(5-28)
Refrigerant	Type		-	R410A	R410A
	Control Method		-	EEV	EEV
Temperature Control		-	Micom&Thermistors	Micom&Thermistors	
Safety Devices		-	Fuse	Fuse	
Piping Connections	Liquid (Flare)		ø, mm	9.52	9.52
	Gas (Flare)		ø, mm	19.05	22.2
	Drain		ø, mm	VP25(OD32, ID25)	VP25(OD32, ID25)
Weight	Net Weight		kg	89	89
	Shipping Weight		kg	99	99
Dimensions	Net Dimensions (W x H x D)		mm	1,240x470x1,040	1,240x470x1,040
	Shipping Dimensions (W x H x D)		mm	1,507x558x1,155	1,507x558x1,155
Functions	Auto Restart		-	O	O
	Auto Swing		-	X	X
	Group/Individual Control		-	O	O
	External Contact Control		-	O	O
	Trouble Shooting by LED		-	X	X
Standard Accessories	Installation Manual		-	O	O
	Operation Manual		-	O	O
	Pattern Sheet for Installation		-	O	O
	Flexible Drain Hose		-	O	O
	Filter / Safety Grille		-	X	X
Optional Accessories	Wireless Remote Controller		-	MR-DH00	MR-DH00
	Duct Receiver Kits	Receiver	-	MRK-A10	MRK-A10
		Receiver Wire	-	MRW-10A	MRW-10A
	Wired Remote Controller	Simplified	-	MWR-WE10N	MWR-WE10N
	External Contact Interface Module		-	MIM-B14	MIM-B14
	Drain Pump		-	MDP-N047SNC1D	MDP-N047SNC1D



*1) Mode

- HP : Heat Pump, HR : Heat Recovery

*2) Nominal cooling capacities are based on;

- Indoor temperature : 27°C DB, 19°C WB

- Outdoor temperature : 35°C DB, 24°C WB, Equivalent refrigerant piping : 7.5m, Level differences : 0m

*3) Nominal heating capacities are based on;

- Indoor temperature : 20°C DB, 15°C WB

- Outdoor temperature : 7°C DB, 6°C WB, Equivalent refrigerant piping : 7.5m, Level differences : 0m

*4) Sound pressure was acquired in a dead room. Thus actual noise level may be different depending on the installation conditions.

*5) Specifications may be subject to change without prior notice for product improvement.

Indoor Unit (cont.)

■ GD-S(Big Duct)

Model			AM180JNHFKH/EU	AM224JNHFKH/EU	
Power Supply		ø/V/Hz	1/220-240/50	1/220-240/50	
Mode*1)			HP / HR	HP / HR	
Performance	Capacity	Cooling*2)	kW	18.0	22.4
			Btu/h	-	-
	Heating*3)	kW	20.0	25.0	
		Btu/h	-	-	
Condensate (with High fan speed)		Liters/h	-	-	
Power	Input	W	340	530	
	Running Current	A	1.9	2.9	
Sound Level	Sound Pressure (High/Low)*4)		dB(A)	43	44
Fan	Type		-	Sirocco Fan	Sirocco Fan
	Motor	Model	-	DL-17860SSBA	DL-17860SSBA
		Type	-	BLDC	BLDC
		Output	W		
Airflow Rate	High/Mid/Low		m ³ /min	58/50/43	72/61/51
	External Static Pressure	Standard(Min.-Max)	mmHzO	7.34(5-20)	7.34(5-20)
Refrigerant	Type		-	R410A	R410A
	Control Method		-	EEV	EEV
Temperature Control		-	Micom&Thermistors	Micom&Thermistors	
Safety Devices		-	Fuse	Fuse	
Piping Connections	Liquid (Flare)		ø, mm	9.52	9.52
	Gas (Flare)		ø, mm	19.05	22.2
	Drain		ø, mm	VP25(OD25, ID20)	VP25(OD25, ID20)
Weight	Net Weight		kg	82	82
	Shipping Weight		kg	91.5	91.5
Dimensions	Net Dimensions (W x H x D)		mm	1,350 x 450 x 910	1,350 x 450 x 910
	Shipping Dimensions (W x H x D)		mm	1,629 x 548 x 989	1,629 x 548 x 989
Functions	Auto Restart		-	O	O
	Auto Swing		-	X	X
	Group/Individual Control		-	O	O
	External Contact Control		-	O	O
	Trouble Shooting by LED		-	X	X
Standard Accessories	Installation Manual		-	O	O
	Operation Manual		-	O	O
	Pattern Sheet for Installation		-	O	O
	Flexible Drain Hose		-	O	O
	Filter / Safety Grille		-	X	X
Optional Accessories	Wireless Remote Controller		-	MR-DH00	MR-DH00
	Duct Receiver Kits	Receiver	-	MRK-A10	MRK-A10
		Receiver Wire	-	MRW-10A	MRW-10A
	Wired Remote Controller	Simplified	-	MWR-WE10N	MWR-WE10N
	External Contact Interface Module		-	MIM-B14	MIM-B14
	Drain Pump			MDP-G075SQ (Internal installation)	MDP-G075SQ (Internal installation)
				MDP-G075SP (External installation)	MDP-G075SP (External installation)



*1) Mode

- HP : Heat Pump, HR : Heat Recovery

*2) Nominal cooling capacities are based on;

- Indoor temperature : 27°C DB, 19°C WB

- Outdoor temperature : 35°C DB, 24°C WB, Equivalent refrigerant piping : 7.5m, Level differences : 0m

*3) Nominal heating capacities are based on;

- Indoor temperature : 20°C DB, 15°C WB

- Outdoor temperature : 7°C DB, 6°C WB, Equivalent refrigerant piping : 7.5m, Level differences : 0m

*4) Sound pressure was acquired in a dead room. Thus actual noise level may be different depending on the installation conditions.

*5) Specifications may be subject to change without prior notice for product improvement.

Indoor Unit (cont.)

■ HSP Duct

Model			AM112FNHDEH/EU	AM128FNHDEH/EU	AM140FNHDEH/EU	
Power Supply		ø/V/Hz	1/220~240/50	1/220~240/50	1/220~240/50	
Mode*1)			HP / HR	HP / HR	HP / HR	
Performance	Capacity	Cooling*2)	kW	11.2	12.8	14.0
			Btu/h	38,200	43,600	47,700
	Heating*3)	kW	12.5	13.8	16.0	
		Btu/h	42,600	47,000	54,500	
Condensate (with High fan speed)		Liters/h				
Power	Input	W	305	333	385	
	Running Current	A	2.35	2.58	3.0	
Sound Level	Sound Pressure (High/Low)*4)	dB(A)	43/40	45/40	46/44	
Fan	Type	-	Sirocco Fan AL, Ø226,L200, 2EA, KJBLWR	Sirocco Fan AL, Ø226,L200, 2EA, KJBLWR	Sirocco Fan AL, Ø226,L200, 2EA, KJBLWR	
	Motor	Model	-	BLDC Motor (DL-12840SSB, 8Pole, Ø124)X2	BLDC Motor (DL-12840SSB, 8Pole, Ø124)X2	BLDC Motor (DL-12840SSB, 8Pole, Ø124)X2
		Type	-	BLDC	BLDC	BLDC
		Output	W			
Airflow Rate	Cooling (High)	m ³ /min	33	35	39	
	Heating (High)	m ³ /min	35	37	41	
	External Static Pressure	Standard(Min.-Max)	mmH ₂ O	10 (5~20)	10 (5~20)	10 (5~20)
Refrigerant	Type	-	R410A	R410A	R410A	
	Control Method	-	EEV	EEV	EEV	
Temperature Control		-	Micom&Thermistors	Micom&Thermistors	Micom&Thermistors	
Safety Devices		-	Fuse	Fuse	Fuse	
Piping Connections	Liquid (Flare)	ø, mm	9.52	9.52	9.52	
	Gas (Flare)	ø, mm	15.88	15.88	15.88	
	Drain	ø, mm	VP25 (OD 32,ID 25)	VP25 (OD 32,ID 25)	VP25 (OD 32,ID 25)	
Weight	Net Weight	kg	62.0	62.0	62.0	
	Shipping Weight	kg	70.0	70.0	70.0	
Dimensions	Net Dimensions (W x H x D)	mm	1200x360x650	1200x360x650	1200x360x650	
	Shipping Dimensions (W x H x D)	mm	1447x425x769	1447x425x769	1447x425x769	
Functions	Auto Restart	-	O	O	O	
	Auto Swing	-	X	X	X	
	Group/Individual Control	-	O	O	O	
	External Contact Control	-	O	O	O	
	Trouble Shooting by LED	-	X	X	X	
Standard Accessories	Installation Manual	-	O	O	O	
	Operation Manual	-	O	O	O	
	Pattern Sheet for Installation	-	O	O	O	
	Flexible Drain Hose	-	O	O	O	
	Filter / Safety Grille	-	X	X	X	
Optional Accessories	Wireless Remote Controller	-	MR-DH00	MR-DH00	MR-DH00	
	Duct Receiver Kits	Receiver	-	MRK-A10	MRK-A10	MRK-A10
		Receiver Wire	-	MRW-10A	MRW-10A	MRW-10A
	Wired Remote Controller	Simplified	-	MWR-WE10N	MWR-WE10N	MWR-WE10N
	External Contact Interface Module	-	MIM-B14	MIM-B14	MIM-B14	
	Drain Pump		-	MDP-M075SGU2D	MDP-M075SGU2D	MDP-M075SGU2D



*1) Mode

- HP : Heat Pump, HR : Heat Recovery

*2) Nominal cooling capacities are based on;

- Indoor temperature : 27 °C DB, 19 °C WB - Outdoor temperature : 35 °C DB, 24 °C WB

*3) Nominal heating capacities are based on;

- Indoor temperature : 20 °C DB, 15 °C WB - Outdoor temperature : 7 °C DB, 6 °C WB

*4) Sound pressure was acquired in a dead room. Thus actual noise level may be different depending on the installation conditions.

*5) Specifications may be subject to change without prior notice for product improvement.

Indoor Unit (cont.)

■ Global Duct

Div.			GD-1	
Model		Europe	AM036HNMPKH/EU	
Basic Model		Europe	AC036HBMDKH/EU(CAC)	
Power Supply		φ,V/Hz	1,220~240,50	
Mode ¹⁾		-	HP / HR	
Performance	Capacity	Cooling ²⁾	kW 92% ↑	
		Heating ³⁾	kW 92% ↑	
Power	Input Consumption (Cooling/Heating)		W 110% ↓	
	Running Current (Cooling/Heating)		A 110% ↓	
Indoor unit refrigerant adding amount		Kg/EA	0.22	
Noise Level	开发spec		dB(A) ↓	
	Catalouel 标示值		dB(A) ↓	
Fan	Type	-	Sirrocco Fan (Φ180*2ea)	
	Motor	Model	SIC-70CW-F1153-2 (DB31-00639A)	
		Type	BLDC feedback	
		Output	W	
Fan Speed	Fan(H/M/L)	Standard	rpm±20	
	Cooling (H/M/L)参考	Standard	700/660/620	
	Heating (H/M/L)参考	Standard	700/660/620	
Airflow Rate	Fan(H/M/L)		m ³ /min	
	Cooling (High)参考		-	
	Heating (High)参考		-	
Refrigerant	Type	-	R410a	
	Control Method	-	EDM EEV3.2c Sanhua	
Temperature Control		-	Micom&Thermistors	
Safety Devices		-	Fuse:5A	
External Static Pressure	Standard (Min.~Max)	mmH2O	0-2.5-15	
OPTION CODE	Standard Static Pressure	0 ≤ SP ≤ 2.5	Product	010054-1C5084-202424-331205
			Install	020010-120000-200000-300000
			Cycle	030000-100000-200000-300000
			Install 2	050000-100000-200000-300000
	All Static Pressure	0 ≤ SP ≤ 2.5 2.5 < SP ≤ 5 5 < SP ≤ 7.5 7.5 < SP ≤ 10 10 < SP ≤ 12.5 12.5 < SP ≤ 15	Product	010054-1C5084-202424-331205
			Product	010054-1C50EB-202424-331205
			Product	010054-1C5552-202424-331205
			Product	010054-1C55CA-202424-331205
			Product	010054-1C5A30-202424-331205
			Product	010054-1C5A85-202424-331205
Piping Connections	Liquid (Flare)	Φ,mm	6.35	
		Φ,inch	1/4"	
	Gas (Flare)	Φ,mm	12.7	
		Φ,inch	1/2"	
	Drain	Φ,mm	VP25 (OD 32, ID 25)	
		Φ,inch	-	
Weight	Net Weight	kg	25.5	
	Shipping Weight	kg	30	
Dimensions	Net Dimensions (W×H×D)	mm	850*250*700	
		inch	-	
	Shipping Dimensions (W×H×D)	mm	1064*320*784	
		inch	-	
HEX	Dimension	-	2R*395*TP8.4*675mm	
	Tube hair fin	-	H2.1(9hole)FMC 9.5mm,	
	Fin	-	Louver, FP1.3	
	Pass	-	4*4 Pass	
Micom	-	-	DB91-01629A Version:140708 Checksum:E754	
LOADING QUANTITY	20ft	EA	98	
	40ft	EA	210	
	40ft JUMBO	EA	240	
Panel Size	Model	Europe	-	
	Net Weight	kg	-	
	Shipping Weight	kg	-	
	Net Dimensions (W×H×D)	mm	-	
	Shipping Dimensions (W×H×D)	mm	-	
Optional Accessories	Model	Europe	MDP-G075SQ (Internal installation), MDP-G075SP (External installation)	
	Drain pump	In/Option	Option	
	Max. lifting Height / Displacement	mm / liter/h	750mm, 24l/h	



*1) Mode

- HP : Heat Pump, HR : Heat Recovery

*2) Norminal cooling capacities are based on;

- Indoor temperature : 27 °C DB, 19 °C WB - Outdoor temperature : 35 °C DB, 24 °C WB

*3) Norminal heating capacities are based on;

- Indoor temperature : 20 °C DB, 15 °C WB - Outdoor temperature : 7 °C DB, 6 °C WB

*4) Sound pressure was acquired in a dead room. Thus actual noise level may be different depending on the installation conditions.

*5) Specifications may be subject to change without prior notice for product improvement.

Indoor Unit (cont.)

■ Global Duct (cont.)

Div.			GD-1	GD-1	GD-1	
Model			Europe	AM056HNMPKH/EU	AM071HNMPKH/EU	
Basic Model			Europe	AC052HBMDKH/EU(CAC)	AC071HBMDKH/EU(CAC)	
Power Supply Mode ¹⁾			φ,V,Hz	1,220~240,50	1,220~240,50	
Performance				HP / HR	HP / HR	
Capacity	Cooling ²⁾	kW 92% ↑	4.5	5.6	7.1	
			Heating ³⁾	5.0	6.3	8.0
Power	Input Consumption (Cooling/Heating)	W 110% ↓	60/60	110/110	120/120	
	Running Current (Cooling/Heating)	A 110% ↓	0.60/0.60	0.9/0.9	1.0/1.0	
Indoorunit refrigerant adding amount			Kg/EA	0.22	0.22	
Noise Level	开发spec	dB(A) ↓	44/44	45/45	47/47	
	Catalouel 标示值	dB(A) ↓	31/28/24	32/29/25	37/33/29	
Fan	Type	-	Sirocco Fan (Φ180*2ea)	Sirocco Fan (Φ180*2ea)	Sirocco Fan (Φ180*2ea)	
	Motor	Model	-	SIC-70CW-F1153-2 (DB31-00639A)	SIC-70CW-F1153-2 (DB31-00639A)	SIC-70CW-F1153-2 (DB31-00639A)
		Type	-	BLDC feedback	BLDC feedback	BLDC feedback
		Output	W	153	153	153
Fan Speed	Fan(H/M/L)	Standard	rpm±20	800/720/640	1000/920/840	
	Cooling (H/M/L)参考	Standard		800/720/640	1000/920/840	
	Heating (H/M/L)参考	Standard		800/720/640	1000/920/840	
Airflow Rate	Fan(H/M/L)	m ³ /min	14.00/11.00/8.00	21.00/18.00/15.00	22.00/19.00/16.00	
	Cooling (High)参考	-	-	-	-	
	Heating (High)参考	-	-	-	-	
Refrigerant	Type	-	R410a	R410a	R410a	
	Control Method	-	EDM EEV3.2c Sanhua	EDM EEV3.2c Sanhua	EDM EEV3.2c Sanhua	
Temperature Control			-	Micom&Thermistors	Micom&Thermistors	
Safety Devices			-	Fuse:5A	Fuse:5A	
External Static Pressure	Standard(Min.-Max)		mmH2O	0-3-15	0-3-15	
OPTION CODE	Standard Static Pressure	0≤ SP ≤2.5	Product	010054-1C50D5-202D2D-331204	010054-1C50F1-203838-331203	010054-1C548D-204747-331201
			Install	020010-120000-200000-300000	020010-100000-200000-300000	020010-100000-200000-300000
			Cycle	030000-100000-200000-300000	030000-100000-200000-300000	030000-100000-200000-300000
			Install 2	050000-100000-200000-300000	050000-100000-200000-300000	050000-100000-200000-300000
	All Static Pressure	0≤ SP ≤3 3< SP ≤6 6< SP ≤9 9< SP ≤12 12< SP ≤15	Product	010054-1C50D5-202D2D-331204	010054-1C50F1-203838-331203	010054-1C548D-204747-331201
			Product	010054-1C545D-202D2D-331204	010054-1C5447-203838-331203	010054-1C55E1-204747-331201
			Product	010054-1C55C4-202D2D-331204	010054-1C54AB-203838-331203	010054-1C5935-204747-331201
			Product	010054-1C593B-202D2D-331204	010054-1C581F-203838-331203	010054-1C5989-204747-331201
			Product	010054-1C5AA2-202D2D-331204	010054-1C5973-203838-331203	010054-1C59DF-204747-331201
			Product	010054-1C5935-202D2D-331204	010054-1C5935-203838-331203	010054-1C5935-204747-331201
Piping Connections	Liquid (Flare)	Φ,mm	6.35	6.35	9.52	
		Φinch	1/4"	1/4"	3/8	
	Gas (Flare)	Φ,mm	12.7	12.7	15.88	
		Φinch	1/2"	1/2"	5/8	
	Drain	Φ,mm	VP25 (OD 32, ID 25)	VP25 (OD 32, ID 25)	VP25 (OD 32, ID 25)	
		Φinch	-	-	-	
Weight	Net Weight	kg	25.5	25.5	25.5	
	Shipping Weight	kg	30	30	30	
Dimensions	Net Dimensions (W×H×D)	mm	850*250*700	850*250*700	850*250*700	
		inch	-	-	-	
	Shipping Dimensions (W×H×D)	mm	1064*320*784	1064*320*784	1064*320*784	
		inch	-	-	-	
HEX	Dimension	-	2R*39S*TP8.4*675mm	2R*39S*TP8.4*675mm	2R*39S*TP8.4*675mm	
	Tube hair fin	-	H2.1(9hole)FMC 9.5mm,	H2.1(9hole)FMC 9.5mm,	H2.1(9hole)FMC 9.5mm,	
	Fin	-	Louver, FP1.3	Louver, FP1.3	Louver, FP1.3	
	Pass	-	4*4 Pass	4*4 Pass	4*4 Pass	
Micom	-	-	DB91-01629A Version:140708 Checksum:E754	DB91-01629A Version:140708 Checksum:E754	DB91-01629A Version:140708 Checksum:E754	
LOADING QUANTITY	20ft	EA	98	98	98	
	40ft	EA	210	210	210	
	40ft JUMBO	EA	240	240	240	
Panel Size	Model	Europe	-	-	-	
	Net Weight	kg	-	-	-	
	Shipping Weight	kg	-	-	-	
	Net Dimensions (W×H×D)	mm	-	-	-	
	Shipping Dimensions (W×H×D)	mm	-	-	-	
Optional Accessories	Model	Europe	MDP-G075SQ (Internal installation) MDP-G075SP (External installation)	MDP-G075SQ (Internal installation) MDP-G075SP (External installation)	MDP-G075SQ (Internal installation) MDP-G075SP (External installation)	
	Drain pump	In/Option	Option	Option	Option	
	Max. lifting Height / Displacement	mm / liter/h	750mm, 24l/h	750mm, 24l/h	750mm, 24l/h	



- *1) Mode
- HP : Heat Pump, HR : Heat Recovery
- *2) Norminal cooling capacities are based on;
- Indoor temperature : 27 °C DB, 19 °C WB - Outdoor temperature : 35 °C DB, 24 °C WB
- *3) Norminal heating capacities are based on;
- Indoor temperature : 20 °C DB, 15 °C WB - Outdoor temperature : 7 °C DB, 6 °C WB
- *4) Sound pressure was acquired in a dead room. Thus actual noise level may be different depending on the installation conditions.
- *5) Specifications may be subject to change without prior notice for product improvement.

Indoor Unit (cont.)

■ Global Duct (cont.)

Div.			GD-2	
Model		Europe	AM090HNMPKH/EU	
Basic Model		Europe	AC090HBMKDH/EU(CAC)	
Power Supply Mode ¹⁾		φ,V,Hz	1,220~240,50	
Performance			HP / HR	
Capacity	Cooling ²⁾	kW 92% ↑	9.0	
		Heating ³⁾	10.0	
Power	Input Consumption (Cooling/Heating)	W 110% ↓	145/145	
	Running Current (Cooling/Heating)	A 110% ↓	1.20/1.20	
Indoor unit refrigerant adding amount		Kg/EA	0.31	
Noise Level	开发spec	dB(A) ↓	44/45	
	Catalouel 标示值	dB(A) ↓	38/35/32	
Fan	Type	-	Sirrocco Fan (Φ180*3ea)	
	Motor	Model	SIC-70CW-F1153-3 (DB31-00640A)	
		Type	BLDC feedback	
		Output	W 153	
Fan Speed	Fan(H/M/L)	Standard	rpm±20	
	Cooling (H/M/L)参考	Standard	980/900/840	
	Heating (H/M/L)参考	Standard	980/900/840	
Airflow Rate	Fan(H/M/L)	m ³ /min	29.00/25.00/22.00	
	Cooling (High)参考		-	
	Heating (High)参考		-	
Refrigerant	Type	-	R410a	
	Control Method	-	EDM EEV3.2c Sanhua	
Temperature Control		-	Micom&Thermistors	
Safety Devices		-	Fuse:5A	
External Static Pressure	Standard(Min.~Max)	mmH2O	0-4-15	
OPTION CODE	Standard Static Pressure	0 ≤ SP ≤ 2.5	Product	010054-1C546F-205A5A-331212
			Install	020010-120000-200000-300000
			Cycle	030000-100000-200000-300000
			Install 2	050000-100000-200000-300000
	All Static Pressure	0 ≤ SP ≤ 4 4 < SP ≤ 8 8 < SP ≤ 12 12 < SP ≤ 15	Product	010054-1C546F-205A5A-331212
			Product	010054-1C55E8-205A5A-331212
			Product	010054-1C5A61-205A5A-331212
			Product	010054-1C5AC8-205A5A-331212
Piping Connections	Liquid (Flare)	Φmm	9.52	
		Φinch	3/8	
	Gas (Flare)	Φmm	15.88	
		Φinch	5/8	
	Drain	Φmm	VP25 (OD 32, ID 25)	
		Φinch	-	
Weight	Net Weight	kg	33.0	
	Shipping Weight	kg	38.5	
Dimensions	Net Dimensions (W×H×D)	mm	1200*250*700	
		inch	-	
	Shipping Dimensions (W×H×D)	mm	1429*320*779	
		inch	-	
HEX	Dimension	-	2R*395*TP8.4*925mm	
	Tube hair fin	-	H2.1(9hole)FMC 9.5mm,	
	Fin	-	Louver, FP1.3	
	Pass	-	4*4 Pass	
Micom		-	DB91-01629A Version:140708 Checksum:E754	
LOADING QUANTITY	20ft	EA	77	
	40ft	EA	161	
	40ft JUMBO	EA	184	
Panel Size	Model	Europe	-	
	Net Weight	kg	-	
	Shipping Weight	kg	-	
	Net Dimensions (W×H×D)	mm	-	
	Shipping Dimensions (W×H×D)	mm	-	
Optional Accessories	Model	Europe	MDP-G075SQ (Internal installation) MDP-G075SP (External installation)	
	Drain pump	In/Option	Option	
	Max. lifting Height / Displacement	mm / liter/h	750mm, 24l/h	



*1) Mode

- HP : Heat Pump, HR : Heat Recovery

*2) Norminal cooling capacities are based on;

- Indoor temperature : 27 °C DB, 19 °C WB - Outdoor temperature : 35 °C DB, 24 °C WB

*3) Norminal heating capacities are based on;

- Indoor temperature : 20 °C DB, 15 °C WB - Outdoor temperature : 7 °C DB, 6 °C WB

*4) Sound pressure was acquired in a dead room. Thus actual noise level may be different depending on the installation conditions.

*5) Specifications may be subject to change without prior notice for product improvement.

Indoor Unit (cont.)

■ Global Duct (cont.)

Div.			GD-3	GD-3	GD-3	
Model			AM112HNMPKH/EU	AM128HNMPKH/EU	AM140HNMPKH/EU	
Basic Model			Europe AC120HBMDKH/EU(CAC)	AC120HBMDKH/EU(CAC)	AC140HBMDKH/EU(CAC)	
Power Supply Mode ¹⁾			φ,V/Hz 1,220~240,50	1,220~240,50	1,220~240,50	
Performance			-	HP / HR	HP / HR	
Capacity	Cooling ²⁾	kW 92% ↑	11.2	12.8	14.0	
	Heating ³⁾	kW 92% ↑	12.5	13.8	16.0	
Power	Input Consumption (Cooling/Heating)	W 110% ↓	165/165	175/175	215/215	
	Running Current (Cooling/Heating)	A 110% ↓	1.40/1.40	1.50/1.50	1.70/1.70	
Indoor unit refrigerant adding amount			Kg/EA 0.38	0.38	0.38	
Noise Level	开发spec	dB(A) ↓	45/46	46/47	47/48	
	Catalouel 标示值	dB(A) ↓	38/35/32	39/36/33	40/37/33	
Fan	Type	-	Sirocco Fan (Φ198*3EA)	Sirocco Fan (Φ198*3EA)	Sirocco Fan (Φ198*3EA)	
	Motor	Model	-	SIC-80CW-F1244-1 (DB31-00641A)	SIC-80CW-F1244-1 (DB31-00641A)	SIC-80CW-F1244-1 (DB31-00641A)
		Type	-	BLDC feedback	BLDC feedback	BLDC feedback
		Output	W	244	244	244
Fan Speed	Fan(H/M/L)	Standard	rpm±20 880/820/760	900/840/780	940/860/780	
	Cooling (H/M/L)参考	Standard	880/820/760	900/840/780	940/860/780	
	Heating (H/M/L)参考	Standard	880/820/760	900/840/780	940/860/780	
Airflow Rate	Fan(H/M/L)	m ³ /min	35.00/29.00/22.00	38.00/32.00/25.00	42.00/34.00/25.00	
	Cooling (High)参考	-	-	-	-	
	Heating (High)参考	-	-	-	-	
Refrigerant	Type	-	R410a	R410a	R410a	
	Control Method	-	EDM EEV4.0c Sanhua	EDM EEV4.0c Sanhua	EDM EEV4.0c Sanhua	
Temperature Control			-	Micom&Thermistors	Micom&Thermistors	
Safety Devices			-	Fuse:5A	Fuse:5A	
External Static Pressure			Standard(Min.-Max)	mmH2O 0-5.2-15	0-5.2-15	
OPTION CODE	Standard Static Pressure	0≤SP≤2.5	Product	010054-1C541B-207070-331223	010054-1C542C-208080-331222	010054-1C544C-208C8C-331221
			Install	020010-120000-200000-300000	020010-120000-200000-300000	020010-120000-200000-300000
			Cycle	030000-100000-200000-300000	030000-100000-200000-300000	030000-100000-200000-300000
	All Static Pressure	0≤SP≤5.2 5.2<SP≤8 8<SP≤12 12<SP≤15	Product	010054-1C541B-207070-331223	010054-1C542C-208080-331222	010054-1C544C-208C8C-331221
			Product	010054-1C5560-207070-331223	010054-1C5572-208080-331222	010054-1C5592-208C8C-331221
			Product	010054-1C55EB-207070-331223	010054-1C55EA-208080-331222	010054-1C55FA-208C8C-331221
			Product	010054-1C593D-207070-331223	010054-1C592E-208080-331222	010054-1C593E-208C8C-331221
			Product	010054-1C593D-207070-331223	010054-1C592E-208080-331222	010054-1C593E-208C8C-331221
Piping Connections	Liquid (Flare)	Φ,mm	9.52	9.52	9.52	
		Φ,inch	3/8	3/8	3/8	
	Gas (Flare)	Φ,mm	15.88	15.88	15.88	
		Φ,inch	5/8	5/8	5/8	
	Drain	Φ,mm	VP25 (OD 32, ID 25)	VP25 (OD 32, ID 25)	VP25 (OD 32, ID 25)	
		Φ,inch	-	-	-	
Weight	Net Weight	kg	38.5	38.5	38.5	
	Shipping Weight	kg	44.5	44.5	44.5	
Dimensions	Net Dimensions (W×H×D)	mm	1300*300*700	1300*300*700	1300*300*700	
		inch	-	-	-	
	Shipping Dimensions (W×H×D)	mm	1529*370*779	1529*370*779	1529*370*779	
		inch	-	-	-	
HEX	Dimension	-	2R*455*TP8.4*L1125mm	2R*455*TP8.4*L1125mm	2R*455*TP8.4*L1125mm	
	Tube hair fin	-	H2.1(9hole)FMC 9.5mm,	H2.1(9hole)FMC 9.5mm,	H2.1(9hole)FMC 9.5mm,	
	Fin	-	FP1.3*Louver	FP1.3*Louver	FP1.3*Louver	
	Pass	-	4*4 Pass	4*4 Pass	4*4 Pass	
Micom			-	DB91-01629A	DB91-01629A	
LOADING QUANTITY			Version:140708 Checksum:E754	Version:140708 Checksum:E754	Version:140708 Checksum:E754	
Panel Size	20ft	EA	42	42	42	
	40ft	EA	90	90	90	
	40ft JUMBO	EA	105	105	105	
	Model	Europe	-	-	-	
	Net Weight	kg	-	-	-	
Optional Accessories	Shipping Weight	kg	-	-	-	
	Net Dimensions (W×H×D)	mm	-	-	-	
	Shipping Dimensions (W×H×D)	mm	-	-	-	
	Model	Europe	MDP-G075SQ (Internal installation)	MDP-G075SQ (Internal installation)	MDP-G075SQ (Internal installation)	
Drain pump	In/Option	Option	Option	Option		
Max. lifting Height / Displacement			mm / liter/h 750mm, 24l/h	750mm, 24l/h	750mm, 24l/h	



- *1) Mode
- HP : Heat Pump, HR : Heat Recovery
- *2) Nominal cooling capacities are based on;
- Indoor temperature : 27 °C DB, 19 °C WB - Outdoor temperature : 35 °C DB, 24 °C WB
- *3) Nominal heating capacities are based on;
- Indoor temperature : 20 °C DB, 15 °C WB - Outdoor temperature : 7 °C DB, 6 °C WB
- *4) Sound pressure was acquired in a dead room. Thus actual noise level may be different depending on the installation conditions.
- *5) Specifications may be subject to change without prior notice for product improvement.

Indoor Unit (cont.)

■ Global Duct (cont.)

Div.			GD-3 HSP	GD-3 HSP	GD-3 HSP		
Model			AM112HNHPKH/EU	AM128HNHPKH/EU	AM140HNHPKH/EU		
Basic Model			AC120HBHFKH/SA(CAC)	AC120HBHFKH/SA(CAC)	AC140HBHFKH/SA(CAC)		
Power Supply Mode 1)			1,220~240,50	1,220~240,50	1,220~240,50		
Performance			HP / HR	HP / HR	HP / HR		
Capacity	Cooling 2)	kW 92% ↑	11.2	12.8	14.0		
	Heating 3)	kW 92% ↑	12.5	13.8	16.0		
Power	Input Consumption (Cooling/Heating)	W 110% ↓	205/205	230/230	260/260		
	Running Current (Cooling/Heating)	A 110% ↓	1.20/1.20	1.40/1.40	1.50/1.50		
Indoorunit refrigerant adding amount			Kg/EA	0.38	0.38		
Noise Level			dB(A) ↓	46/47	47/48		
Catalogue 标示值			dB(A) ↓	38/35/32	39/36/33		
Fan	Type	-	Sirocco Fan (Φ198*3EA)	Sirocco Fan (Φ198*3EA)	Sirocco Fan (Φ198*3EA)		
	Motor	Model	-	DL-178305SBA (DB31-00645A)	DL-178305SBA (DB31-00645A)	DL-178305SBA (DB31-00645A)	
		Type	-	BLDC feedback	BLDC feedback	BLDC feedback	
	Output	W	350	350	350		
Fan Speed	Fan(H/M/L)	Standard	rpm±20	940/900/860	980/920/880		
	Cooling (H/M/L)参考	Standard		940/900/860	980/920/880		
	Heating (H/M/L)参考	Standard		940/900/860	980/920/880		
Airflow Rate	Fan(H/M/L)	m³/min	35.00/29.00/22.00	38.00/32.00/25.00	42.00/34.00/25.00		
	Cooling (High)参考	-	-	-	-		
	Heating (High)参考	-	-	-	-		
Refrigerant	Type	-	R410a	R410a	R410a		
	Control Method	-	EDM EEV4.0c Sanhua	EDM EEV4.0c Sanhua	EDM EEV4.0c Sanhua		
Temperature Control			-	Micom&Thermistors	Micom&Thermistors		
Safety Devices			-	Fuse:5A/10A/15A	Fuse:5A/10A/15A		
External Static Pressure			Standard(Min.~Max)	mmH2O	3-6.2-20		
OPTION CODE	Standard Static Pressure	0≤SP≤2.5	Product	010054-1C5540-207070-331226	010054-1C5561-208080-331225	010054-1C5581-208C8C-331224	
			Install	020010-120000-200000-300000	020010-120000-200000-300007	020010-120000-200000-300008	
			Cycle	030000-100000-200000-300000	030000-100000-200000-300007	030000-100000-200000-300008	
	All Static Pressure	3≤SP≤6.2	6.2<SP≤9	Product	010054-1C5540-207070-331226	010054-1C5561-208080-331225	010054-1C5581-208C8C-331224
				Install	050000-100000-200000-300000	050000-100000-200000-300007	050000-100000-200000-300008
				Cycle	060000-100000-200000-300000	060000-100000-200000-300007	060000-100000-200000-300008
				Product	010054-1C5544-207070-331226	010054-1C5563-208080-331225	010054-1C5583-208C8C-331224
				Install	010054-1C5546-207070-331226	010054-1C5565-208080-331225	010054-1C5585-208C8C-331224
				Cycle	010054-1C5548-207070-331226	010054-1C5567-208080-331225	010054-1C5587-208C8C-331224
				Product	010054-1C554A-207070-331226	010054-1C5569-208080-331225	010054-1C5589-208C8C-331224
Piping Connections	Liquid (Flare)	Φ,mm	9.52	9.52	9.52		
			3/8	3/8	3/8		
	Gas (Flare)	Φ,mm	15.88	15.88	15.88		
			5/8	5/8	5/8		
Drain	Φ,mm	VP25 (OD 32, ID 25)	VP25 (OD 32, ID 25)	VP25 (OD 32, ID 25)			
		-	-	-			
Weight	Net Weight	kg	46.5	46.5	46.5		
	Shipping Weight	kg	52.5	52.5	52.5		
Dimensions	Net Dimensions (WxHxD)	mm	1300*300*700	1300*300*700	1300*300*700		
		inch	-	-	-		
	Shipping Dimensions (WxHxD)	mm	1529*370*779	1529*370*779	1529*370*779		
		inch	-	-	-		
HEX	Dimension	-	2R*455*TP8.4*L1125mm	2R*455*TP8.4*L1125mm	2R*455*TP8.4*L1125mm		
	Tube hair fin	-	H2.1(9hole) FME 9.10mm,	H2.1(9hole) FME 9.10mm,	H2.1(9hole) FME 9.10mm,		
	Fin	-	FP1.3*Louver	FP1.3*Louver	FP1.3*Louver		
	Pass	-	4*4 Pass	4*4 Pass	4*4 Pass		
Micom			-	DB91-01629A	DB91-01629A		
Version:140708 Checksum:E754			Version:140708 Checksum:E754	Version:140708 Checksum:E754	Version:140708 Checksum:E754		
LOADING QUANTITY	20ft	EA	42	42	42		
	40ft	EA	90	90	90		
	40ft JUMBO	EA	105	105	105		
Panel Size	Model	Europe	-	-	-		
	Net Weight	kg	-	-	-		
	Shipping Weight	kg	-	-	-		
	Net Dimensions (WxHxD)	mm	-	-	-		
	Shipping Dimensions (WxHxD)	mm	-	-	-		
Optional Accessories	Model	Europe	MDP-G075SQ (Internal installation)	MDP-G075SQ (Internal installation)	MDP-G075SQ (Internal installation)		
	Drain pump	In/Option	Option	Option	Option		
	Max. lifting Height / Displacement	mm / liter/h	750mm, 24l/h	750mm, 24l/h	750mm, 24l/h		



- *1) Mode
- HP : Heat Pump, HR : Heat Recovery
- *2) Norminal cooling capacities are based on;
- Indoor temperature : 27 °C DB, 19 °C WB - Outdoor temperature : 35 °C DB, 24 °C WB
- *3) Norminal heating capacities are based on;
- Indoor temperature : 20 °C DB, 15 °C WB - Outdoor temperature : 7 °C DB, 6 °C WB
- *4) Sound pressure was acquired in a dead room. Thus actual noise level may be different depending on the installation conditions.
- *5) Specifications may be subject to change without prior notice for product improvement.

Indoor Unit (cont.)

■ Ceiling type

Model			AM056FNCDEH/EU	AM071FNCDEH/EU	
Power Supply		ø/V/Hz	1/220~240/50	1/220~240/50	
Mode*1)			HP / HR	HP / HR	
Performance	Capacity	Cooling*2)	kW	5.6	7.1
			Btu/h	19,100	24,200
	Heating*3)	kW	6.3	8.0	
		Btu/h	21,400	27,200	
Condensate (with High fan speed)		Liters/h	2.87	2.87	
Power	Input	W	72/72	80/77	
	Running Current	A	0.33/0.28	0.35/0.29	
Sound Level	Sound Pressure (Cooling / Heating)*4)		dB(A)	45/45	47/47
Fan	Type		-	Sirocco Fan	Sirocco Fan
	Motor	Model	-	Y5S413B214	Y5S413B214
		Type	-	Non Feedback SSR	Non Feedback SSR
		Output	W	*5)	*5)
Airflow Rate	Cooling (High)	m ³ /min	16.5	16.5	
	Heating (High)	m ³ /min	20.0	20.0	
Refrigerant	Type	-	R410A	R410A	
	Control Method	-	EEV	EEV	
Temperature Control		-	Micom&Thermistors	Micom&Thermistors	
Safety Devices		-	Fuse	Fuse	
Piping Connections	Liquid (Flare)	ø, mm	6.35	9.52	
	Gas (Flare)	ø, mm	12.7	15.88	
	Drain	ø, mm	VP25 (OD 32,ID 25)	VP25 (OD 32,ID 25)	
Weight	Net Weight	kg	21.0	21.0	
	Shipping Weight	kg	25.5	25.5	
Dimensions	Net Dimensions (W x H x D)	mm	1000x650x200	1000x650x200	
	Shipping Dimensions (W x H x D)	mm	1080x730x300	1080x730x300	
Functions	Auto Restart	-	O	O	
	Auto Swing	-	X	X	
	Group/Individual Control	-	O	O	
	External Contact Control	-	O	O	
	Trouble Shooting by LED	-	X	X	
Standard Accessories	Installation Manual	-	O	O	
	Operation Manual	-	O	O	
	Pattern Sheet for Installation	-	X	X	
	Flexible Drain Hose	-	O	O	
	Filter / Safety Grille	-	Filter (Washable)	Filter (Washable)	
Optional Accessories	Wireless Remote Controller		-	AR-DH00	AR-DH00
	Wired Remote Controller	Simplified	-	MWR-WE10N	MWR-WE10N
		External Contact Interface Module	-	MIM-B14	MIM-B14



*1) Mode

- HP : Heat Pump, HR : Heat Recovery

*2) Nominal cooling capacities are based on;

- Indoor temperature : 27°C DB, 19°C WB

- Outdoor temperature : 35°C DB, 24°C WB , Equivalent refrigerant piping : 7.5m , Level differences : 0m

*3) Nominal heating capacities are based on;

- Indoor temperature : 20°C DB, 15°C WB

- Outdoor temperature : 7°C DB, 6°C WB , Equivalent refrigerant piping : 7.5m , Level differences : 0m

*4) Sound pressure was acquired in a dead room. Thus actual noise level may be different depending on the installation conditions.

*5) Specifications may be subject to change without prior notice for product improvement.

Indoor Unit (cont.)

■ Big Ceiling

Model			AM112JNC DKH/EU	AM140JNC DKH/EU
Power Supply Mode 1)			φ,V,Hz	1,220~240,50/60
			-	HP / HR
Performance	Capacity	Cooling 2)	kW	11.2
		Heating 3)	kW	12.5
Power	Input Consumption (Cooling/Heating)		W	92/80
	Running Current (Cooling/Heating)		A	0.94/0.83
Indoorunit refrigerant adding amount			Kg/EA	0.56
Noise Level			Actual Noise Pressure (High)	dB(A) ↓
			-	49
Fan	Type		-	Sirocco, Φ168*3EA
	Motor	Model	-	SIC-70CW-F1153-6, DL-12830SSBF (DB31-00660A)
		Type	-	BLDC Feedback
		Output	W	153W
Airflow Rate		Fan(H/M/L)	m ³ /min	29.3/23.9/18.5
Refrigerant	Type		-	R410a
	Control Method		-	EDM EEV 4.0C
Temperature Control			-	Micom&Thermistors
Safety Devices			-	250V/5A
Piping Connections	Liquid (Flare)	Φ,mm		9.52
		Φinch		3/8"
	Gas (Flare)	Φ,mm		15.88
		Φinch		5/8"
	Drain	Φ,mm		VP25 (OD25,JD 20)
Φinch		-		
Weight	Net Weight		kg	33.5
	Shipping Weight		kg	39.5
Dimensions	Net Dimensions (W×H×D)		mm	1350*235*675
			inch	-
	Shipping Dimensions (W×H×D)		mm	1439*758*321
			inch	-
Functions	Auto Restart		-	O
	Auto Swing		-	O
	Group/Individual Control		-	O
	External Contact Control		-	O
	Trouble Shooting by LED		-	O
Standard Accessories	Installation Manual		-	O
	Operation Manual		-	O
	Pattern Sheet for Installation		-	O
	Flexible Drain Hose		-	O
Filter / Safety Grille			-	Filter (Washable)
Optional Accessories	Wireless Remote Controller		-	AR-DH00
	Wired Remote Controller	Simplified	-	MWR-WE10N
		External Contact Interface Module		-



*1) Mode

- HP : Heat Pump, HR : Heat Recovery

*2) Norminal cooling capacities are based on;

- Indoor temperature : 27°C DB, 19°C WB - Outdoor temperature : 35°C DB, 24°C WB

*3) Norminal heating capacities are based on;

- Indoor temperature : 20°C DB, 15°C WB - Outdoor temperature : 7°C DB, 6°C WB

*4) Sound pressure was acquired in a dead room. Thus actual noise level may be different depending on the installation conditions.

*5) Specifications may be subject to change without prior notice for product improvement.

Indoor Unit (cont.)

■ Console type

Model			AM022KNJDEH/EU	AM028FNJDEH/EU	AM036FNJDEH/EU	AM045KNJDEH/EU	AM056FNJDEH/EU	
Power Supply		ø/V/Hz	1/220~240/50	1/220~240/50	1/220~240/50	1/220~240/50	1/220~240/50	
Mode*1)			HP / HR	HP / HR	HP / HR	HP / HR	HP / HR	
Performance	Capacity	Cooling*2)	kW	2.2	2.8	3.6	4.5	5.6
			Btu/h	7,500	9,600	12,300	15,400	19,100
		Heating*3)	kW	2.5	3.2	4.0	5.0	6.3
			Btu/h	8,500	11,000	13,600	17,100	21,400
	Condensate (with High fan speed)		Liters/h	-	0.96	1.75	-	-
Power	Input	W	16 ^{*5)}	30 ^{*5)}	35 ^{*5)}	36 ^{*5)}	62 ^{*5)}	
	Running Current	A	0.13 ^{*5)}	0.25 ^{*5)}	0.29 ^{*5)}	0.30 ^{*5)}	0.49 ^{*5)}	
Sound Level	Sound Pressure (Cooling / Heating)*4)	dB(A)	38/39	41/43	42/44	48/49	49/51	
Fan	Type		Turbo Fan	Turbo Fan	Turbo Fan	Turbo Fan	Turbo Fan	
	Motor	Model	-	SIC-55CV-F137-2	SIC-55CV-F137-2	SIC-55CV-F137-2	SIC-55CV-F137-2	SIC-55CV-F137-2
		Type	-	BLDC	BLDC	BLDC	BLDC	BLDC
		Output	W	37	37.0	37.0	37	37.0
Airflow Rate	Cooling (High)	m ³ /min	5.8	7.76 ^{*5)}	8.67 ^{*5)}	11.0	13.0 ^{*5)}	
	Heating (High)	m ³ /min	6.3	7.22 ^{*5)}	8.89 ^{*5)}	11.3	13.5 ^{*5)}	
Refrigerant	Type	-	R410A	R410A	R410A	R410A	R410A	
	Control Method	-	EEV	EEV	EEV	EEV	EEV	
Temperature Control		-	Micom&Thermistors	Micom&Thermistors	Micom&Thermistors	Micom&Thermistors	Micom&Thermistors	
Safety Devices		-	Fuse	Fuse	Fuse	Fuse	Fuse	
Piping Connections	Liquid (Flare)	ø, mm	6.35	6.35	6.35	6.35	6.35	
	Gas (Flare)	ø, mm	12.7	12.7	12.7	12.7	12.7	
	Drain	ø, mm	ID 18 hose	ID 18 hose	ID 18 hose	ID 18 hose	ID 18 hose	
Weight	Net Weight	kg	16.0	16.0	16.0	16.0	16.0	
	Shipping Weight	kg	21.0	21.0	21.0	21.0	21.0	
Dimensions	Net Dimensions (W x H x D)	mm	720x620x199	720x620x199	720x620x199	720x620x199	720x620x199	
	Shipping Dimensions (W x H x D)	mm	810x710x295	810x710x295	810x710x295	810x710x295	810x710x295	
Functions	Auto Restart	-	O	O	O	O	O	
	Auto Swing	-	O	O	O	O	O	
	Group/Individual Control	-	O	O	O	O	O	
	External Contact Control	-	O	O	O	O	O	
	Trouble Shooting by LED	-	O	O	O	O	O	
Standard Accessories	Installation Manual	-	O	O	O	O	O	
	Operation Manual	-	O	O	O	O	O	
	Pattern Sheet for Installation	-	X	X	X	X	X	
	Flexible Drain Hose	-	O	O	O	O	O	
	Filter / Safety Grille	-	Filter (Washable)	Filter (Washable)	Filter (Washable)	Filter (Washable)	Filter (Washable)	
	Wireless Remote Controller		ARH-1378 (DB93-07547B)	ARH-1378 (DB93-07547B)	ARH-1378 (DB93-07547B)	ARH-1378 (DB93-07547B)	ARH-1378 (DB93-07547B)	
Optional Accessories	Wireless Remote Controller	-	MR-DH00	MR-DH00	MR-DH00	MR-DH00	MR-DH00	
	Wired Remote Controller	Simplified	-	MWR-WE10N	MWR-WE10N	MWR-WE10N	MWR-WE10N	
	External Contact Interface Module		-	MIM-B14	MIM-B14	MIM-B14	MIM-B14	



*1) Mode

- HP : Heat Pump, HR : Heat Recovery

*2) Nominal cooling capacities are based on;

- Indoor temperature : 27°C DB, 19°C WB

- Outdoor temperature : 35°C DB, 24°C WB, Equivalent refrigerant piping : 7.5m, Level differences : 0m

*3) Nominal heating capacities are based on;

- Indoor temperature : 20°C DB, 15°C WB

- Outdoor temperature : 7°C DB, 6°C WB, Equivalent refrigerant piping : 7.5m, Level differences : 0m

*4) Sound pressure was acquired in a dead room. Thus actual noise level may be different depending on the installation conditions.

*5) Specifications may be subject to change without prior notice for product improvement.

Indoor Unit (cont.)

■ Wall Mounted type(Neo Forte without EEV)

Model			AM015HNTDEH/EU	AM022FNTDEH/EU	AM028FNTDEH/EU	AM036FNTDEH/EU	AM056FNTDEH/EU	AM071FNTDEH/EU	
Power Supply Mode*1)			1/220~240/50	1/220~240/50	1/220~240/50	1/220~240/50	1/220~240/50	1/220~240/50	
Performance	Capacity	Cooling*2)	kW	1.5	2.2	2.8	3.6	5.6	
			Btu/h	5,100	7,500	9,500	12,200	19,100	
		Heating*3)	kW	2.2	2.5	3.2	4.0	6.3	
			Btu/h	7,500	8,500	10,900	13,600	21,400	
		Condensate (with High fan speed)		Liters/h	0.74	1.12	1.44	1.91	2.87
Power	Input		W	25*5)	25*5)	30*5)	45*5)	50*5)	
	Running Current		A	0.16*5)	0.16*5)	0.16*5)	0.18*5)	0.27*5)	
Sound Level	Sound Pressure *4)		dB(A)	43	42	43	43	48	
Fan	Type	-		Crossflow fan	Crossflow fan	Crossflow fan	Crossflow fan	Crossflow fan	
	Motor	Model	-		YFK-8-4-SX06	YFK-8-4-SX06	YFK-8-4-SX06	YDK-045542213-02	YDK-045542213-02
		Type	-		Feedback SSR	Resin/steel	Resin/steel	Resin/steel	Resin/steel
		Output	W		-	-	-	-	-
Airflow Rate	Cooling (High)	m ³ /min	5.4*5)	7.80*5)	7.80*5)	9.30*5)	12.00*5)	14.00*5)	
	Heating (High)	m ³ /min	6.3*5)	8.20*5)	8.20*5)	9.50*5)	13.00*5)	15.00*5)	
Refrigerant	Type	-		R410A	R410A	R410A	R410A	R410A	
	Control Method		-		EEV	EEV (Optional)	EEV (Optional)	EEV (Optional)	EEV (Optional)
Temperature Control	-		Micom & Thermistors		Micom & Thermistors	Micom & Thermistors	Micom & Thermistors	Micom & Thermistors	
Safety Devices	-		Fuse		Fuse	Fuse	Fuse	Fuse	
Piping Connections	Liquid (Flare)	ø, mm	6.35	6.35	6.35	6.35	6.35	9.52	
	Gas (Flare)	ø, mm	12.7	12.7	12.7	12.7	12.7	15.88	
	Drain	ø, mm	ID 18 hose	ID 18 hose	ID 18 hose	ID 18 hose	ID 18 hose	ID 18 hose	
Weight	Net Weight		kg	8.3	8.0	8.0	13.0*5)	13.0*5)	
	Shipping Weight		kg	11.3	11.0	11.0	16.0	16.0	
Dimensions	Net Dimensions (W x H x D)		mm	825x285x189	825x285x189	825x285x189	825x285x189	1,099x315x217	
	Shipping Dimensions (W x H x D)		mm	900x349x252	900x349x252	900x349x252	900x349x252	1,137x377x299	
Functions	Auto Restart		-	O	O	O	O	O	
	Auto Swing		-	O	O	O	O	O	
	Group/Individual Control		-	O	O	O	O	O	
	External Contact Control		-	O	O	O	O	O	
	Trouble Shooting by LED		-	O	O	O	O	O	
Standard Accessories	Installation Manual		-	O	O	O	O	O	
	Operation Manual		-	O	O	O	O	O	
	Pattern Sheet for Installation		-	X	X	X	X	X	
	Flexible Drain Hose		-	O	O	O	O	O	
	Filter / Safety Grille		-	Filter (Washable)	Filter (Washable)	Filter (Washable)	Filter (Washable)	Filter (Washable)	
	Wireless Remote Controller		-	ARH-5012	ARH-5012	ARH-5012	ARH-5012	ARH-5012	
Optional Accessories	Wireless Remote Controller		-	MR-DH00	MR-DH00	MR-DH00	MR-DH00	MR-DH00	
	Wired Remote Controller	Simplified	-	MWR-WE10N	MWR-WE10N	MWR-WE10N	MWR-WE10N	MWR-WE10N	
	External Contact Interface Module		-	MIM-B14	MIM-B14	MIM-B14	MIM-B14	MIM-B14	
	EEV Kits		-	MXD, MEV Series	MXD, MEV Series	MXD, MEV Series	MXD, MEV Series	MXD, MEV Series	



*1) Mode
 - HP : Heat Pump, HR : Heat Recovery
 *2) Nominal cooling capacities are based on;
 - Indoor temperature : 27°C DB, 19°C WB
 - Outdoor temperature : 35°C DB, 24°C WB, Equivalent refrigerant piping : 7.5m, Level differences : 0m
 *3) Nominal heating capacities are based on;
 - Indoor temperature : 20°C DB, 15°C WB
 - Outdoor temperature : 7°C DB, 6°C WB, Equivalent refrigerant piping : 7.5m, Level differences : 0m
 *4) Sound pressure was acquired in a dead room. Thus actual noise level may be different depending on the installation conditions.
 *5) Specifications may be subject to change without prior notice for product improvement.

Indoor Unit (cont.)

■ Wall Mounted type(Neo Forte with EEV)

Model			AM015HNQDEH/EU	AM022FNQDEH/EU	AM028FNQDEH/EU	AM036FNQDEH/EU	
Power Supply		øV/Hz	1/220~240/50	1/220~240/50	1/220~240/50	1/220~240/50	
Mode*1)			HP	HP	HP	HP	
Performance	Capacity	Cooling*2)	kW	1.5	2.2	2.8	3.6
			Btu/h	5,100	7,500	9,500	12,200
		Heating*3)	kW	2.2	2.5	3.2	4.0
			Btu/h	7,500	8,500	10,900	13,600
Condensate (with High fan speed)		Liters/h	0.74	1.12	1.44	1.91	
Power	Input	W	25 ^{*5)}	25 ^{*5)}	25 ^{*5)}	30 ^{*5)}	
	Running Current	A	0.16 ^{*5)}	0.16 ^{*5)}	0.16 ^{*5)}	0.18 ^{*5)}	
Sound Level	Sound Pressure *4)	dB(A)	43	43	44	44	
Fan	Type		-	Crossflow fan	Crossflow fan	Crossflow fan	
	Motor	Model	-	YFK-8-4-SX06	YFK-8-4-SX06	YFK-8-4-SX06	YFK-8-4-SX06
		Type	-	Feedback SSR	Feedback SSR	Feedback SSR	Feedback SSR
		Output	W	-	-	-	-
Airflow Rate	Cooling (High)	m ³ /min	5.4 ^{*5)}	7.80 ^{*5)}	7.80 ^{*5)}	9.30 ^{*5)}	
	Heating (High)	m ³ /min	6.3 ^{*5)}	8.20 ^{*5)}	8.20 ^{*5)}	9.50 ^{*5)}	
Refrigerant	Type	-	R410A	R410A	R410A	R410A	
	Control Method	-	EEV	EEV	EEV	EEV	
Temperature Control		-	Micom&Thermistors	Micom&Thermistors	Micom&Thermistors	Micom&Thermistors	
Safety Devices		-	Fuse	Fuse	Fuse	Fuse	
Piping Connections	Liquid (Flare)	ø, mm	6.35	6.35	6.35	6.35	
	Gas (Flare)	ø, mm	12.7	12.7	12.7	12.7	
	Drain	ø, mm	ID 18 hose	ID 18 hose	ID 18 hose	ID 18 hose	
Weight	Net Weight	kg	8.3	8.3	8.3	8.3	
	Shipping Weight	kg	11.3	11.3	11.3	11.3	
Dimensions	Net Dimensions (W x H x D)	mm	825x285x189	825x285x189	825x285x189	825x285x189	
	Shipping Dimensions (W x H x D)	mm	900x349x252	900x349x252	900x349x252	900x349x252	
Functions	Auto Restart	-	O	O	O	O	
	Auto Swing	-	O	O	O	O	
	Group/Individual Control	-	O	O	O	O	
	External Contact Control	-	O	O	O	O	
	Trouble Shooting by LED	-	O	O	O	O	
Standard Accessories	Installation Manual	-	O	O	O	O	
	Operation Manual	-	O	O	O	O	
	Pattern Sheet for Installation	-	X	X	X	X	
	Flexible Drain Hose	-	O	O	O	O	
	Filter / Safety Grille	-	Filter (Washable)	Filter (Washable)	Filter (Washable)	Filter (Washable)	
	Wireless Remote Controller	-	ARH-5012	ARH-5012	ARH-5012	ARH-5012	
Optional Accessories	Wireless Remote Controller	-	MR-DH00	MR-DH00	MR-DH00	MR-DH00	
	Wired Remote Controller	Simplified	-	MWR-WE10N	MWR-WE10N	MWR-WE10N	
	External Contact Interface Module	-	MIM-B14	MIM-B14	MIM-B14	MIM-B14	



*1) Mode

- HP : Heat Pump, HR : Heat Recovery

*2) Nominal cooling capacities are based on;

- Indoor temperature : 27°C DB, 19°C WB

- Outdoor temperature : 35°C DB, 24°C WB, Equivalent refrigerant piping : 7.5m, Level differences : 0m

*3) Nominal heating capacities are based on;

- Indoor temperature : 20°C DB, 15°C WB

- Outdoor temperature : 7°C DB, 6°C WB, Equivalent refrigerant piping : 7.5m, Level differences : 0m

*4) Sound pressure was acquired in a dead room. Thus actual noise level may be different depending on the installation conditions.

*5) Specifications may be subject to change without prior notice for product improvement.

Indoor Unit (cont.)

■ Wall Mounted type(Neo Forte with EEV)(cont.)

Model			AM045FNQDEH/EU	AM056FNQDEH/EU	AM071FNQDEH/EU	
Power Supply		ø/V/Hz	1/220~240/50	1/220~240/50	1/220~240/50	
Mode*1)			HP	HP	HP	
Performance	Capacity	Cooling*2)	kW	4.5	5.6	6.8
			Btu/h	-	19,100	23,200
		Heating*3)	kW	5.0	6.3	7.0
			Btu/h	-	21,400	23,800
	Condensate (with High fan speed)		Liters/h	2.35	2.87	3.51
Power	Input		W	40*5)	45*5)	50*5)
	Running Current		A	0.24*5)	0.27*5)	0.30*5)
Sound Level	Sound Pressure *4)		dB(A)	49	49	49
Fan	Type		-	Crossflow fan	Crossflow fan	Crossflow fan
	Motor	Model	-	YDK-045S42213-02	YDK-045S42213-02	YDK-045S42213-02
		Type	-	Feedback SSR	Feedback SSR	Feedback SSR
		Output	W	-	-	-
Airflow Rate	Cooling (High)		m ³ /min	11.70*5)	13.00*5)	14.00*5)
	Heating (High)		m ³ /min	12.30*5)	13.50*5)	15.00*5)
Refrigerant	Type		-	R410A	R410A	R410A
	Control Method		-	EEV	EEV	EEV
Temperature Control		-	Micom&Thermistors	Micom&Thermistors	Micom&Thermistors	
Safety Devices		-	Fuse	Fuse	Fuse	
Piping Connections	Liquid (Flare)		ø, mm	6.35	6.35	9.52
	Gas (Flare)		ø, mm	12.7	12.7	15.88
	Drain		ø, mm	ID 18 hose	ID 18 hose	ID 18 hose
Weight	Net Weight		kg	13.5	13.5	13.5
	Shipping Weight		kg	16.5	16.5	16.5
Dimensions	Net Dimensions (W x H x D)		mm	1,099x315x217	1,099x315x217	1,099x315x217
	Shipping Dimensions (W x H x D)		mm	1,137x377x299	1,137x377x299	1,137x377x299
Functions	Auto Restart		-	O	O	O
	Auto Swing		-	O	O	O
	Group/Individual Control		-	O	O	O
	External Contact Control		-	O	O	O
	Trouble Shooting by LED		-	O	O	O
Standard Accessories	Installation Manual		-	O	O	O
	Operation Manual		-	O	O	O
	Pattern Sheet for Installation		-	X	X	X
	Flexible Drain Hose		-	O	O	O
	Filter / Safety Grille		-	Filter (Washable)	Filter (Washable)	Filter (Washable)
	Wireless Remote Controller		-	ARH-5012	ARH-5012	ARH-5012
Optional Accessories	Wireless Remote Controller		-	MR-DH00	MR-DH00	MR-DH00
	Wired Remote Controller	Simplified	-	MWR-WE10N	MWR-WE10N	MWR-WE10N
		External Contact Interface Module		-	MIM-B14	MIM-B14



*1) Mode

- HP : Heat Pump, HR : Heat Recovery

*2) Nominal cooling capacities are based on;

- Indoor temperature : 27°C DB, 19°C WB

- Outdoor temperature : 35°C DB, 24°C WB, Equivalent refrigerant piping : 7.5m, Level differences : 0m

*3) Nominal heating capacities are based on;

- Indoor temperature : 20°C DB, 15°C WB

- Outdoor temperature : 7°C DB, 6°C WB, Equivalent refrigerant piping : 7.5m, Level differences : 0m

*4) Sound pressure was acquired in a dead room. Thus actual noise level may be different depending on the installation conditions.

*5) Specifications may be subject to change without prior notice for product improvement.

Indoor Unit (cont.)

■ Wall Mounted type(Boracay with EEV)

Model		AM015KNQDEH/EU	AM022KNQDEH/EU	AM028KNQDEH/EU	AM036KNQDEH/EU	AM045KNQDEH/EU	AM056KNQDEH/EU	AM071KNQDEH/EU		
Power Supply		ø, #, V, Hz	1,220~240,50	1,220~240,50	1,220~240,50	1,220~240,50	1,220~240,50	1,220~240,50		
Mode		-	HP / HR	HP / HR	HP / HR	HP / HR	HP / HR	HP / HR		
Performance	Capacity (Nominal)	Cooling 2)	kW	1.5	2.2	2.8	3.6	4.5	5.6	6.8
		Btu/h	5,100	7,500	9,600	12,300	15,400	19,100	23,200	
	Heating 2)	kW	1.7	2.5	3.2	4.0	5.0	6.3	7.0	
		Btu/h	5,800	8,500	10,900	13,600	17,050	21,400	23,800	
Condensate (with high fan speed)		Liter/h	-	-	-	-	-	-		
Power	Input	W	32	32	38	42	47	48	51	
	Running Current	A	0.20	0.20	0.22	0.23	0.27	0.27	0.28	
Sound Level	Sound Pressure *4)	dB(A)	35	36	35	41	43	44	45	
Fan	Type	-	Crossflow Fan Ø94*L601	Crossflow Fan Ø94*L601	Crossflow Fan Ø94*L601	Crossflow Fan Ø94*L601	Crossflow Fan Ø94*L844.3	Crossflow Fan Ø94*L844.3	Crossflow Fan Ø94*L844.3	
	Motor	Model	-	Y45476B038L	Y45476B038L	Y45476B038L	Y45476B82	Y45476B82	Y45476B82	
		Type	-	SSR Feedback	SSR Feedback	SSR Feedback	SSR Feedback	SSR Feedback	SSR Feedback	
	Output	W	-	-	-	-	-	-	-	
Airflow Rate	Cooling (High)	m3/min	5.9	6.2	6.7	8.1	11.7	12.1	13.1	
	Heating (High)	m3/min	6.9	7.1	6.7	7.8	13.9	14.4	16.1	
Refrigerant	Type	-	R410a	R410a	R410a	R410a	R410a	R410a	R410a	
	Control Method	-	EDM EEV 1.3C	EDM EEV 1.3C	EDM EEV 1.3C	EDM EEV 1.3C	EDM EEV 2.0C	EDM EEV 2.0C	EDM EEV 2.0C	
Temperature Control	-	Micom&Thermistors	Micom&Thermistors	Micom&Thermistors	Micom&Thermistors	Micom&Thermistors	Micom&Thermistors	Micom&Thermistors		
Safety Devices	-	Fuse:1.6A	Fuse:1.6A	Fuse:1.6A	Fuse:1.6A	Fuse:1.6A	Fuse:1.6A	Fuse:1.6A		
Piping Connections	Liquid (Flare)	ø, mm	6.35	6.35	6.35	6.35	6.35	6.35	9.52	
	Gas (Flare)	ø, mm	12.7	12.7	12.7	12.7	12.7	12.7	15.88	
	Drain	ø, mm	ID 18 hose	ID 18 hose	ID 18 hose	ID 18 hose	ID 18 hose	ID 18 hose	ID 18 hose	
Weight	Net Weight	kg	8.5	8.5	9.0	9.0	12.5	12.5	12.5	
	Shipping Weight	kg	10.2	10.2	10.6	10.6	14.5	14.5	14.5	
Dimensions	Net Dimensions (W x H x D)	mm	820*285*227	820*285*227	820*285*227	820*285*227	1065*298*243	1065*298*243	1065*298*243	
	Shipping Dimensions (W x H x D)	mm	880*280*363	880*280*363	880*280*363	880*280*363	1128*299*378	1128*299*378	1128*299*378	
Functions	Auto Restart	-	O	O	O	O	O	O	O	
	Auto Swing	-	O	O	O	O	O	O	O	
	Group/Individual Control	-	O	O	O	O	O	O	O	
	External Contact Control	-	O	O	O	O	O	O	O	
	Trouble Shooting by LED	-	O	O	O	O	O	O	O	
Standard Accessories	Installation Manual	-	O	O	O	O	O	O	O	
	Operation Manual	-	O	O	O	O	O	O	O	
	Pattern Sheet for Installation	-	X	X	X	X	X	X	X	
	Flexible Drain Hose	-	O	O	O	O	O	O	O	
	Filter / Safety Grille	-	Filter (Washable)	Filter (Washable)	Filter (Washable)	Filter (Washable)	Filter (Washable)	Filter (Washable)	Filter (Washable)	
	Wireless Remote Controller	-	ARH-5012	ARH-5012	ARH-5012	ARH-5012	ARH-5012	ARH-5012	ARH-5012	
Optional Accessories	Wireless Remote Controller	-	MR-DH00	MR-DH00	MR-DH00	MR-DH00	MR-DH00	MR-DH00	MR-DH00	
	Wired Remote Controller	Simplified	-	MWR-WE10N	MWR-WE10N	MWR-WE10N	MWR-WE10N	MWR-WE10N	MWR-WE10N	
		External Contact Interface Module	-	MIM-B14	MIM-B14	MIM-B14	MIM-B14	MIM-B14	MIM-B14	
	EEV Kits	-	MXD, MEV Series	MXD, MEV Series	MXD, MEV Series	MXD, MEV Series	MXD, MEV Series	MXD, MEV Series	MXD, MEV Series	



- *1) Mode
- HP : Heat Pump, HR : Heat Recovery
- *2) Nominal cooling capacities are based on;
- Indoor temperature : 27°C DB, 19°C WB
- Outdoor temperature : 35°C DB, 24°C WB, Equivalent refrigerant piping : 7.5m, Level differences : 0m
- *3) Nominal heating capacities are based on;
- Indoor temperature : 20°C DB, 15°C WB
- Outdoor temperature : 7°C DB, 6°C WB, Equivalent refrigerant piping : 7.5m, Level differences : 0m
- *4) Sound pressure was acquired in a dead room. Thus actual noise level may be different depending on the installation conditions.
- *5) Specifications may be subject to change without prior notice for product improvement.

Indoor Unit (cont.)

■ Wall Mounted type(Boracay without EEV)

Model			AM015KNTDEH/EU	AM022KNTDEH/EU	AM028KNTDEH/EU	AM036KNTDEH/EU	AM045KNTDEH/EU	AM056KNTDEH/EU	AM071KNTDEH/EU	
Power Supply			1,220~240,50	1,220~240,50	1,220~240,50	1,220~240,50	1,220~240,50	1,220~240,50	1,220~240,50	
Mode			-	HP / HR	HP / HR	HP / HR	HP / HR	HP / HR	HP / HR	
Performance	Capacity (Nominal)	Cooling 2)	kW	1.5	2.2	2.8	3.6	4.5	5.6	7.1
		Btu/h	5,100	7,500	9,600	12,300	15,400	19,100	23,200	
	Heating 2)	kW	1.7	2.5	3.2	4.0	5.0	6.3	7.0	
		Btu/h	5,800	8,500	10,900	13,600	17,050	21,400	23,800	
Condensate (with high fan speed)			Liter/h	-	-	-	-	-	-	
Power	Input		W	32	32	38	42	47	48	51
	Running Current		A	0.20	0.20	0.22	0.23	0.27	0.27	0.28
Sound Level	Sound Pressure *4)		dB(A)	35	26	25	41	43	44	45
Fan	Type	-	Crossflow Fan Φ94*L601	Crossflow Fan Φ94*L601	Crossflow Fan Φ94*L601	Crossflow Fan Φ94*L601	Crossflow Fan Φ94*L844.3	Crossflow Fan Φ94*L844.3	Crossflow Fan Φ94*L844.3	
	Motor	Model	-	Y45476B038L	Y45476B038L	Y45476B038L	Y45476B038L	Y45476B82	Y45476B82	Y45476B82
		Type	-	SSR Feedback	SSR Feedback	SSR Feedback	SSR Feedback	SSR Feedback	SSR Feedback	SSR Feedback
		Output	W	-	-	-	-	-	-	-
Airflow Rate	Cooling (High)	m3/min	5.9	6.2	6.7	8.1	11.7	12.1	13.1	
	Heating (High)	m3/min	6.9	7.1	7.4	8.5	13.9	14.4	16.1	
Refrigerant	Type	-	R410a	R410a	R410a	R410a	R410a	R410a	R410a	
	Control Method	-	-	-	-	-	-	-	-	
Temperature Control	-		Micom&Thermistors	Micom&Thermistors	Micom&Thermistors	Micom&Thermistors	Micom&Thermistors	Micom&Thermistors	Micom&Thermistors	
Safety Devices	-		Fuse:1.6A	Fuse:1.6A	Fuse:1.6A	Fuse:1.6A	Fuse:1.6A	Fuse:1.6A	Fuse:1.6A	
Piping Connections	Liquid (Flare)	ø, mm	6.35	6.35	6.35	6.35	6.35	6.35	9.52	
	Gas (Flare)	ø, mm	12.7	12.7	12.7	12.7	12.7	12.7	15.88	
	Drain	ø, mm	ID 18 hose	ID 18 hose	ID 18 hose	ID 18 hose	ID 18 hose	ID 18 hose	ID 18 hose	
Weight	Net Weight	kg	8.0	8.0	8.5	8.5	12.0	12.0	12.0	
	Shipping Weight	kg	9.7	9.7	10.2	10.2	14.0	14.0	14.0	
Dimensions	Net Dimensions (W x H x D)	mm	820*285*227	820*285*227	820*285*227	820*285*227	1065*298*243	1065*298*243	1065*298*243	
	Shipping Dimensions (W x H x D)	mm	880*280*363	880*280*363	880*280*363	880*280*363	1128*299*378	1128*299*378	1128*299*378	
Functions	Auto Restart	-	0	0	0	0	0	0	0	
	Auto Swing	-	0	0	0	0	0	0	0	
	Group/Individual Control	-	0	0	0	0	0	0	0	
	External Contact Control	-	0	0	0	0	0	0	0	
	Trouble Shooting by LED	-	0	0	0	0	0	0	0	
Standard Accessories	Installation Manual	-	0	0	0	0	0	0	0	
	Operation Manual	-	0	0	0	0	0	0	0	
	Pattern Sheet for Installation	-	X	X	X	X	X	X	X	
	Flexible Drain Hose	-	0	0	0	0	0	0	0	
	Filter / Safety Grille	-	Filter (Washable)	Filter (Washable)	Filter (Washable)	Filter (Washable)	Filter (Washable)	Filter (Washable)	Filter (Washable)	
	Wireless Remote Controller	-	ARH-5012	ARH-5012	ARH-5012	ARH-5012	ARH-5012	ARH-5012	ARH-5012	
Optional Accessories	Wireless Remote Controller	-	MR-DH00	MR-DH00	MR-DH00	MR-DH00	MR-DH00	MR-DH00	MR-DH00	
	Wired Remote Controller	Simplified	-	MWR-WE10N	MWR-WE10N	MWR-WE10N	MWR-WE10N	MWR-WE10N	MWR-WE10N	
	External Contact Interface Module	-	MIM-B14	MIM-B14	MIM-B14	MIM-B14	MIM-B14	MIM-B14	MIM-B14	
	EEV Kits	-	MXD, MEV Series	MXD, MEV Series	MXD, MEV Series	MXD, MEV Series	MXD, MEV Series	MXD, MEV Series	MXD, MEV Series	



- *1) Mode
- HP : Heat Pump, HR : Heat Recovery
- *2) Nominal cooling capacities are based on;
- Indoor temperature : 27°C DB, 19°C WB
- Outdoor temperature : 35°C DB, 24°C WB, Equivalent refrigerant piping : 7.5m, Level differences : 0m
- *3) Nominal heating capacities are based on;
- Indoor temperature : 20°C DB, 15°C WB
- Outdoor temperature : 7°C DB, 6°C WB, Equivalent refrigerant piping : 7.5m, Level differences : 0m
- *4) Sound pressure was acquired in a dead room. Thus actual noise level may be different depending on the installation conditions.
- *5) Specifications may be subject to change without prior notice for product improvement.

Indoor Unit (cont.)

■ Wall Mounted type(Boracay with EEV)

Model			AM022KNQDEH/TL	AM028KNQDEH/TL	AM036KNQDEH/TL	AM045KNQDEH/TL	AM056KNQDEH/TL	AM071KNQDEH/TL
Power Supply		ø, #, V, Hz	1,220~240,50	1,220~240,50	1,220~240,50	1,220~240,50	1,220~240,50	1,220~240,50
Mode			HP / HR	HP / HR	HP / HR	HP / HR	HP / HR	HP / HR
Performance	Capacity (Nominal)	Cooling 2)	kW	2.2	2.8	3.6	4.5	5.6
			Btu/h	7,500	9,600	12,300	15,400	19,100
	Heating 2)	kW	2.5	3.2	4.0	5.0	6.3	7.0
		Btu/h	8,500	10,900	13,600	17,050	21,400	23,800
Condensate (with high fan speed)		Liter/h	-	-	-	-	-	-
Power	Input	W	32	38	42	47	48	51
	Running Current	A	0.20	0.22	0.23	0.27	0.27	0.28
Sound Level	Sound Pressure *4)	dB(A)	36	35	41	43	44	45
Fan	Type		Crossflow Fan Ø94*L601	Crossflow Fan Ø94*L601	Crossflow Fan Ø94*L601	Crossflow Fan Ø94*L844.3	Crossflow Fan Ø94*L844.3	Crossflow Fan Ø94*L844.3
	Motor	Model	Y4S476B038L	Y4S476B038L	Y4S476B038L	Y4S476B82	Y4S476B82	Y4S476B82
		Type	SSR Feedback	SSR Feedback	SSR Feedback	SSR Feedback	SSR Feedback	SSR Feedback
		Output	W	-	-	-	-	-
Airflow Rate	Cooling (High)	m3/min	6.2	6.7	8.1	11.7	12.1	13.1
	Heating (High)	m3/min	7.1	6.7	7.8	13.9	14.4	16.1
Refrigerant	Type		R410a	R410a	R410a	R410a	R410a	R410a
	Control Method		EDM EEV 1.3C	EDM EEV 1.3C	EDM EEV 1.3C	EDM EEV 2.0C	EDM EEV 2.0C	EDM EEV 2.0C
Temperature Control			Micom&Thermistors	Micom&Thermistors	Micom&Thermistors	Micom&Thermistors	Micom&Thermistors	Micom&Thermistors
Safety Devices			Fuse:1.6A	Fuse:1.6A	Fuse:1.6A	Fuse:1.6A	Fuse:1.6A	Fuse:1.6A
Piping Connections	Liquid (Flare)	ø, mm	6.35	6.35	6.35	6.35	6.35	9.52
	Gas (Flare)	ø, mm	12.7	12.7	12.7	12.7	12.7	15.88
	Drain	ø, mm	ID 18 hose	ID 18 hose	ID 18 hose	ID 18 hose	ID 18 hose	ID 18 hose
Weight	Net Weight	kg	8.5	9.0	9.0	12.5	12.5	12.5
	Shipping Weight	kg	10.0	10.5	10.5	14.5	14.5	14.5
Dimensions	Net Dimensions (W x H x D)	mm	820*285*227	820*285*227	820*285*227	1065*298*243	1065*298*243	1065*298*243
	Shipping Dimensions (W x H x D)	mm	880*280*363	880*280*363	880*280*363	1128*299*378	1128*299*378	1128*299*378
Functions	Auto Restart		O	O	O	O	O	O
	Auto Swing		O	O	O	O	O	O
	Group/Individual Control		O	O	O	O	O	O
	External Contact Control		O	O	O	O	O	O
	Trouble Shooting by LED		O	O	O	O	O	O
Standard Accessories	Installation Manual		O	O	O	O	O	O
	Operation Manual		O	O	O	O	O	O
	Pattern Sheet for Installation		X	X	X	X	X	X
	Flexible Drain Hose		O	O	O	O	O	O
	Filter / Safety Grille		Filter (Washable)	Filter (Washable)	Filter (Washable)	Filter (Washable)	Filter (Washable)	Filter (Washable)
	Wireless Remote Controller		ARH-5012	ARH-5012	ARH-5012	ARH-5012	ARH-5012	ARH-5012
Optional Accessories	Wireless Remote Controller		MR-DH00	MR-DH00	MR-DH00	MR-DH00	MR-DH00	MR-DH00
	Wired Remote Controller	Simplified		MWR-WE10N	MWR-WE10N	MWR-WE10N	MWR-WE10N	MWR-WE10N
		External Contact Interface Module		MIM-B14	MIM-B14	MIM-B14	MIM-B14	MIM-B14



- *1) Mode
- HP : Heat Pump, HR : Heat Recovery
- *2) Nominal cooling capacities are based on;
- Indoor temperature : 27°C DB, 19°C WB
- Outdoor temperature : 35°C DB, 24°C WB, Equivalent refrigerant piping : 7.5m, Level differences : 0m
- *3) Nominal heating capacities are based on;
- Indoor temperature : 20°C DB, 15°C WB
- Outdoor temperature : 7°C DB, 6°C WB, Equivalent refrigerant piping : 7.5m, Level differences : 0m
- *4) Sound pressure was acquired in a dead room. Thus actual noise level may be different depending on the installation conditions.
- *5) Specifications may be subject to change without prior notice for product improvement.

Indoor Unit (cont.)

■ Wall mounted type(Boracay with EEV)(cont.)

Model			AM007KNQDCH/TC	AM009KNQDCH/TC	AM012KNQDCH/TC	AM018KNQDCH/TC	AM020KNQDCH/TC	AM024KNQDCH/TC
Power Supply Mode			1,208~230,60	1,208~230,60	1,208~230,60	1,208~230,60	1,208~230,60	1,208~230,60
			HP / HR	HP / HR	HP / HR	HP / HR	HP / HR	HP / HR
Performance	Capacity (Nominal)	Cooling 2)	-	-	-	-	-	-
		Btu/h	7,500	9,500	12,000	18,000	20,000	23,200
	Heating 2)	kW	-	-	-	-	-	-
		Btu/h	8,500	10,500	13,500	20,000	23,000	23,800
Condensate (with high fan speed)			Liter/h	-	-	-	-	-
Power	Input		W	30	39	42	57	58
	Running Current		A	0.18	0.21	0.22	0.32	0.32
Sound Level	Sound Pressure *4)		dB(A)	36	35	41	44	45
Fan	Type		-	Crossflow Fan Φ94*L601	Crossflow Fan Φ94*L601	Crossflow Fan Φ94*L601	Crossflow Fan Φ94*L844.3	Crossflow Fan Φ94*L844.3
	Motor	Model	-	Y45476B038L	Y45476B038L	Y45476B038L	Y45476B82	Y45476B82
		Type	-	SSR Feedback	SSR Feedback	SSR Feedback	SSR Feedback	SSR Feedback
		Output	W	-	-	-	-	-
Airflow Rate	Cooling (High)	m3/min	6.2	6.7	8.1	12.1	-	13.1
	Heating (High)	m3/min	7.1	7.4	8.5	14.4	-	16.1
Refrigerant	Type	-	R410a	R410a	R410a	R410a	R410a	R410a
	Control Method	-	EDM EEV 1.3C	EDM EEV 1.3C	EDM EEV 1.3C	EDM EEV 2.0C	EDM EEV 2.0C	EDM EEV 2.0C
Temperature Control			-	Micom&Thermistors	Micom&Thermistors	Micom&Thermistors	Micom&Thermistors	Micom&Thermistors
Safety Devices			-	Fuse:1.6A	Fuse:1.6A	Fuse:1.6A	Fuse:1.6A	Fuse:1.6A
Piping Connections	Liquid (Flare)	ø, mm	6.35	6.35	6.35	6.35	6.35	9.52
	Gas (Flare)	ø, mm	12.7	12.7	12.7	12.7	12.7	15.88
	Drain	ø, mm	ID 18 hose	ID 18 hose	ID 18 hose	ID 18 hose	ID 18 hose	ID 18 hose
Weight	Net Weight		kg	8.5	9.0	9.0	12.5	12.5
	Shipping Weight		kg	10.0	10.5	10.5	14.5	14.5
Dimensions	Net Dimensions (W x H x D)		mm	820*285*227	820*285*227	820*285*227	1065*298*243	1065*298*243
	Shipping Dimensions (W x H x D)		mm	880*280*363	880*280*363	880*280*363	1128*299*378	1128*299*378
Functions	Auto Restart		-	0	0	0	0	0
	Auto Swing		-	0	0	0	0	0
	Group/Individual Control		-	0	0	0	0	0
	External Contact Control		-	0	0	0	0	0
	Trouble Shooting by LED		-	0	0	0	0	0
Standard Accessories	Installation Manual		-	0	0	0	0	0
	Operation Manual		-	0	0	0	0	0
	Pattern Sheet for Installation		-	X	X	X	X	X
	Flexible Drain Hose		-	0	0	0	0	0
	Filter / Safety Grille		-	Filter (Washable)	Filter (Washable)	Filter (Washable)	Filter (Washable)	Filter (Washable)
Optional Accessories	Wireless Remote Controller		-	MR-EH00	MR-EH00	MR-EH00	MR-EH00	MR-EH00
	Wired Remote Controller	Simplified	-	MWR-WE10N	MWR-WE10N	MWR-WE10N	MWR-WE10N	MWR-WE10N
	External Contact Interface Module		-	MIM-B14	MIM-B14	MIM-B14	MIM-B14	MIM-B14



- *1) Mode
- HP : Heat Pump, HR : Heat Recovery
- *2) Nominal cooling capacities are based on;
- Indoor temperature : 27°C DB, 19°C WB
- Outdoor temperature : 35°C DB, 24°C WB, Equivalent refrigerant piping : 7.5m, Level differences : 0m
- *3) Nominal heating capacities are based on;
- Indoor temperature : 20°C DB, 15°C WB
- Outdoor temperature : 7°C DB, 6°C WB, Equivalent refrigerant piping : 7.5m, Level differences : 0m
- *4) Sound pressure was acquired in a dead room. Thus actual noise level may be different depending on the installation conditions.
- *5) Specifications may be subject to change without prior notice for product improvement.

Indoor Unit (cont.)

■ Wall mounted type(Boracay without EEV)

Model			AM007KNTDCH/TC	AM009KNTDCH/TC	AM012KNTDCH/TC	AM018KNTDCH/TC	AM020KNTDCH/TC	AM024KNTDCH/TC
Power Supply		ø, #, V, Hz	1,208~230,60	1,208~230,60	1,208~230,60	1,208~230,60	1,208~230,60	1,208~230,60
Mode			HP / HR	HP / HR	HP / HR	HP / HR	HP / HR	HP / HR
Performance	Capacity (Nominal)	Cooling 2)	-	-	-	-	-	-
		Btu/h	7,500	9,500	12,000	18,000	20,000	23,200
	Heating 2)	kW	-	-	-	-	-	-
		Btu/h	8,500	10,500	13,500	20,000	23,000	23,800
Condensate (with high fan speed)		Liter/h	-	-	-	-	-	-
Power	Input	W	30	39	42	57	58	60
	Running Current	A	0.18	0.21	0.22	0.32	0.32	0.32
Sound Level	Sound Pressure *4)	dB(A)	36	35	41	44	44	45
Fan	Type		Crossflow Fan Ø94*L601	Crossflow Fan Ø94*L601	Crossflow Fan Ø94*L601	Crossflow Fan Ø94*L844.3	Crossflow Fan Ø94*L844.3	Crossflow Fan Ø94*L844.3
	Motor	Model	Y45476B038L	Y45476B038L	Y45476B038L	Y45476B82	Y45476B82	Y45476B82
		Type	SSR Feedback	SSR Feedback	SSR Feedback	SSR Feedback	SSR Feedback	SSR Feedback
		Output	W	-	-	-	-	-
Airflow Rate	Cooling (High)	m3/min	6.2	6.7	8.1	12.1	-	13.1
	Heating (High)	m3/min	7.1	7.4	8.5	14.4	-	16.1
Refrigerant	Type		R410a	R410a	R410a	R410a	R410a	R410a
	Control Method		-	-	-	-	-	-
Temperature Control			Micom&Thermistors	Micom&Thermistors	Micom&Thermistors	Micom&Thermistors	Micom&Thermistors	Micom&Thermistors
Safety Devices			Fuse:1.6A	Fuse:1.6A	Fuse:1.6A	Fuse:1.6A	Fuse:1.6A	Fuse:1.6A
Piping Connections	Liquid (Flare)	ø, mm	6.35	6.35	6.35	6.35	6.35	9.52
	Gas (Flare)	ø, mm	12.7	12.7	12.7	12.7	12.7	15.88
	Drain	ø, mm	ID 18 hose	ID 18 hose	ID 18 hose	ID 18 hose	ID 18 hose	ID 18 hose
Weight	Net Weight	kg	8.5	9.0	9.0	12.5	12.5	12.5
	Shipping Weight	kg	10.0	10.5	10.5	14.5	14.4	14.4
Dimensions	Net Dimensions (W x H x D)	mm	820*285*227	820*285*227	820*285*227	1065*298*243	1065*298*243	1065*298*243
	Shipping Dimensions (W x H x D)	mm	880*280*363	880*280*363	880*280*363	1128*299*378	1128*299*378	1128*299*378
Functions	Auto Restart		0	0	0	0	0	0
	Auto Swing		0	0	0	0	0	0
	Group/Individual Control		0	0	0	0	0	0
	External Contact Control		0	0	0	0	0	0
	Trouble Shooting by LED		0	0	0	0	0	0
Standard Accessories	Installation Manual		0	0	0	0	0	0
	Operation Manual		0	0	0	0	0	0
	Pattern Sheet for Installation		X	X	X	X	X	X
	Flexible Drain Hose		0	0	0	0	0	0
	Filter / Safety Grille		Filter (Washable)	Filter (Washable)	Filter (Washable)	Filter (Washable)	Filter (Washable)	Filter (Washable)
Optional Accessories	Wireless Remote Controller		MR-EH00	MR-EH00	MR-EH00	MR-EH00	MR-EH00	MR-EH00
	Wired Remote Controller	Simplified	MWR-WE10N	MWR-WE10N	MWR-WE10N	MWR-WE10N	MWR-WE10N	MWR-WE10N
	External Contact Interface Module		MIM-B14	MIM-B14	MIM-B14	MIM-B14	MIM-B14	MIM-B14



- *1) Mode
- HP : Heat Pump, HR : Heat Recovery
- *2) Nominal cooling capacities are based on;
- Indoor temperature : 27°C DB, 19°C WB
- Outdoor temperature : 35°C DB, 24°C WB, Equivalent refrigerant piping : 7.5m, Level differences : 0m
- *3) Nominal heating capacities are based on;
- Indoor temperature : 20°C DB, 15°C WB
- Outdoor temperature : 7°C DB, 6°C WB, Equivalent refrigerant piping : 7.5m, Level differences : 0m
- *4) Sound pressure was acquired in a dead room. Thus actual noise level may be different depending on the installation conditions.
- *5) Specifications may be subject to change without prior notice for product improvement.

Indoor Unit (cont.)

■ Floor Standing Type

Model			AM036FNFDEH/EU	AM056FNFDEH/EU	AM071FNFDEH/EU
Power Supply			∅,V,Hz	220 - 240 V~ 50Hz	220 - 240 V~ 50Hz
Mode				HP / HR	HP / HR
Performance	Capacity	Cooling	kW	3.6	5.6
			Btu/h	12,200	19,100
		Heating	kW	4.0	6.3
			Btu/h	13,600	21,400
Power	Running Current	Cooling	A	0.24 ^{*5)}	0.53 ^{*5)}
		Heating	A	0.24 ^{*5)}	0.53 ^{*5)}
	Input	Cooling	W	50.0 ^{*5)}	110.0 ^{*5)}
		Heating	W	50.0 ^{*5)}	110.0 ^{*5)}
Sound Level	Sound Pressure	dB	43.0	45.0	
FAN	Type		-	Sirocco	Sirocco
	Motor	Model	-	OS-KRD306(KR035)	OS-KRD306A(KR045)
Airflow Rate	Cooling(High)	m ³ /min	10.0 ^{*5)}	16.5 ^{*5)}	16.5 ^{*5)}
	Heating(High)	m ³ /min	11.0 ^{*5)}	19.0 ^{*5)}	19.0 ^{*5)}
Refrigerant	Type		-	R410	R410
	Control Method		-	EEV	EEV
Temperature Control			-	Micom & Thermistors	Micom & Thermistors
Safety Devices			-	Fuse	Fuse
Piping connections	Liquid(Flare)	∅,mm	6.35	6.35	9.52
	Gas(Flare)	∅,mm	12.70	12.70	15.88
	Drain	∅,mm	ID18 HOSE	ID18 HOSE	ID18 HOSE
Weight	Net Weight	kg	23.0	28.5	28.5
	Shipping Weight	kg	27.0	33.3	33.3
Dimensions	Net Dimensions	mm	945x600x220	1225x600x220	1225x600x220
	Shipping Dimensions	mm	1035x690x310	1335x690x310	1335x690x310
Functions	Auto Restart		-	O	O
	Auto Swing		-	X	X
	Group/Individual Control		-	O	O
	External Contact Control		-	O	O
	Trouble Shooting by LED		-	O	O
Standard Accessories	Installation Manual		-	O	O
	Operation Manual		-	X	X
	Pattern Sheet for Installation		-	X	X
	Flexible Drain Hose		-	O	O
	Filter / Safety Grille		-	O	O
	Drain Pump (Pumping, Speed, Lift)	ℓ/h,mm		X	X
Optional Accessories	Wireless Remote Controller		-	X	X
	Wired Remote Controller		-	MWR-WE10N	MWR-WE10N
	External Contact Interface Module		-	X	X



*1) Mode

- HP : Heat Pump, HR : Heat Recovery

*2) Nominal cooling capacities are based on;

- Indoor temperature : 27°C DB, 19°C WB

- Outdoor temperature : 35°C DB, 24°C WB, Equivalent refrigerant piping : 7.5m, Level differences : 0m

*3) Nominal heating capacities are based on;

- Indoor temperature : 20°C DB, 15°C WB

- Outdoor temperature : 7°C DB, 6°C WB, Equivalent refrigerant piping : 7.5m, Level differences : 0m

*4) Sound pressure was acquired in a dead room. Thus actual noise level may be different depending on the installation conditions.

*5) Specifications may be subject to change without prior notice for product improvement.

Indoor Unit (cont.)

■ Floor Standing Type

Model			AM036MNFDEH/EU	AM056MNFDEH/EU	AM071MNFDEH/EU	
Power Supply			Φ, #, V, Hz	1,2,220~240,50	1,2,220~240,50	
Mode			-	HP/HR	HP/HR	
Performance	Capacity (Nominal)	Cooling 2)	T1 (kW)	3.6	5.6	7.1
			T1 (Btu/h)	-	-	-
		Heating 2)	T1 (kW)	4.0	6.3	8.0
			T1 (Btu/h)	-	-	-
Power	Power Input (Nominal)	Cooling 1)	T1 (W)	22.0	42.0	42.0
		Heating 2)	T1 (W)	22.0	42.0	42.0
	Current Input (Nominal)	Cooling 1)	T1 (A)	0.2	0.37	0.37
		Heating 2)	T1 (A)	0.2	0.37	0.37
Fan	Type		-	Sirocco Fan	Sirocco Fan	Sirocco Fan
	Motor	Output x n	W	100 x 1	100 x 1	100 x 1
	Air Flow Rate	H/M/L (UL)	CMM	10.0/8.5/6.0	15.5/14.0/11.0	15.5/14.0/11.0
			l/s	-	-	-
	External Static Pressure	Standard (Min.~Max)	mmAq	0 (0~6)	0 (0~6)	0 (0~6)
Pa			-	-	-	
Fan Speed	Fan(H/M/L)	0 (Standard)	rpm±20	880/740/620	940/800/640	940/800/640
		3mmAq	rpm±20	1200/1040/880	1200/1040/880	1200/1040/880
		6mmAq	rpm±20	1380/1140/920	1420/1220/1020	1420/1220/1020
Piping Connections	Liquid Pipe	Φ,mm	6.35	6.35	9.52	
		Φ, inch	1/4"	1/4"	3/8"	
	Gas Pipe	Φ,mm	12.70	12.70	15.88	
		Φ, inch	1/2"	1/2"	5/8"	
Drain Pipe	Φ,mm	ID 18 HOSE	ID 18 HOSE	ID 18 HOSE		
Field Wiring	Power Source Wire	mm ²	1.5 ~ 2.5	1.5 ~ 2.5	1.5 ~ 2.5	
	Transmission Cable	mm ²	0.75 ~ 1.50	0.75 ~ 1.50	0.75 ~ 1.50	
Refrigerant	Type	-	R410A	R410A	R410A	
	Control Method	-	EEV INCLUDED	EEV INCLUDED	EEV INCLUDED	
Sound	Sound Pressure	High	dB(A)	43	45	45
Dimensions	Net Weight		kg	22	27	27
	Shipping Weight		kg	27	32.5	32.5
	Net Dimensions (WxHxD)		mm	945 x 600 x 220	1225 x 600 x 220	1225 x 600 x 220
	Shipping Dimensions (WxHxD)		mm	1035 x 690 x 310	1335 x 690 x 310	1335 x 690 x 310
Functions	Auto Restart		-	O	O	O
	Auto Swing		-	X	X	X
	Group/Individual Control		-	O	O	O
	External Contact Control		-	O	O	O
	Trouble Shooting by LED		-	O	O	O
Standard Accessories	Installation Manual		-	O	O	O
	Operation Manual		-	X	X	X
	Pattern Sheet for Installation		-	X	X	X
	Flexible Drain Hose		-	O	O	O
	Filter / Safety Grille		-	O	O	O
Optional Accessories	Drain Pump (Pumping, Speed, Lift)	ℓ/h,mm		X	X	X
	Wireless Remote Controller		-	X	X	X
	Wired Remote Controller		-	MWR-WE10N	MWR-WE10N	MWR-WE10N
Option Code	External Contact Interface Module		-	X	X	X
	0	010054-1C5414-202424-330010	010054-1C5445-203838-330010	010054-1C5445-204747-330010	010054-1C5445-204747-330010	
	3	010054-1C5911-202424-330010	010054-1C5911-203838-330010	010054-1C5911-204747-330010	010054-1C5911-204747-330010	
6	010054-1C59A3-202424-330010	010054-1C59C8-203838-330010	010054-1C59C8-204747-330010	010054-1C59C8-204747-330010		



*1) Mode

- HP : Heat Pump, HR : Heat Recovery

*2) Nominal cooling capacities are based on;

- Indoor temperature : 27°C DB, 19°C WB

- Outdoor temperature : 35°C DB, 24°C WB, Equivalent refrigerant piping : 7.5m, Level differences : 0m

*3) Nominal heating capacities are based on;

- Indoor temperature : 20°C DB, 15°C WB



- Outdoor temperature : 7°C DB, 6°C WB, Equivalent refrigerant piping : 7.5m, Level differences : 0m

*4) Sound pressure was acquired in a dead room. Thus actual noise level may be different depending on the installation conditions.

*5) Specifications may be subject to change without prior notice for product improvement.

Indoor Unit (cont.)

■ ERV Plus

Item			Development Model		
			AM050FNKDEH/EU	AM100FNKDEH/EU	
Image	Product				
	Remote Controller		 MWR-WE10N		
Power Source Application	V/Hz/ø		220-240/50/1		
Function	Ventilation		HEAT-EX, BY-PASS, AUTO		
	Heating/Cooling		HEATING, COOLING, AUTO		
	Fan Speed		Turbo, High, Low, Quiet		
Performance	Air Volume	(m³/h)	500	1,000	
	External Static Pressure	(Pa)	160	150	
	Power Consumption	(W)	220	510	
	Temperature Exchange Rate	Cooling	(%)	70	70
		Heating	(%)	75	75
	Enthalpy Exchange Rate	Cooling	(%)	60	62
		Heating	(%)	73	75
	Cooling Capacity *():The heat reclaimed from the ERV	(kW)	5.1(1.5)	10.5(3.4)	
Heating Capacity *():The heat reclaimed from the ERV	(kW)	6.5(2.5)	13.2(5.2)		
Humidifier Capacity(Optional Kit)	(kg/h)	2.7	5.4		
Piping Connections	Liquid	Φ,mm	φ6.4 C1220T (Flare Connection)		
	Gas	Φ,mm	φ12.7 C1220T (Flare Connection)		
	Water Supply	mm	1/2 inch		
	Drain	mm	VP25		
Set Size	Weight	kg	61	90	
	Dimensions (WxHxD)	mm	1,553x270x1,000	1,763x340x1,135	
Operating Temp. Range	Around Unit	-	0~40°C DB, 80%RH ↓		
	OA	-	-15~40°C DB, 80%RH ↓		
	RA	-	0~40°C DB, 80%RH ↓		



*** Specifications may be subject to change without prior notice for product improvement.**

- *1) Nominal cooling capacities are based on;
- Indoor temperature : 27°C DB, 19°C WB - Outdoor temperature : 35°C DB, 24°C WB, Equivalent refrigerant piping : 7.5m, Level differences : 0m
- *2) Nominal heating capacities are based on;
- Indoor temperature : 20°C DB, 15°C WB
- Outdoor temperature : 7°C DB, 6°C WB, Equivalent refrigerant piping : 7.5m, Level differences : 0m
- *3) Humidifying capacity is based on;
- Indoor temperature : 20°C DB, 15°C WB
- Outdoor temperature : 7°C DB, 6°C WB, Equivalent refrigerant piping : 7.5m, Level differences : 0m
- *4) Sound pressure was acquired in an anechoic room.
Thus actual noise level may be different depending on the installation conditions.
- *5) OA: fresh air from outdoor. RA: return air from room.

Indoor Unit (cont.)

■ Hydro Unit

Type (Hydro Unit)					
Model			AM160FNBDEH/EU	AM320FNBDEH/EU	AM500FNBDEH/EU
Division			Cooling/Heating	Cooling/Heating	Cooling/Heating
Power Supply			1ø, 220-240V, 50Hz	1ø, 220-240V, 50Hz	1ø, 220-240V, 50Hz
Performance	Horse Power	HP	5	10	16
		Cooling	kW	14.0	28.0
	Kcal/h		12040	24080	38528
	Heating	kW	16.0	31.5	50.4
		Kcal/h	13760	27090	43344
Power	Running Current	A	0.05	0.05	0.05
	Input	W	10	10	10
Piping (Refrigerant)	Liquid	ø,mm	9.52	9.52	12.7
	Gas	ø,mm	15.9	22.2	28.58
Piping (Water)	Inlet/Outlet	A(Inch)	25A(PT1)	25A(PT1)	32A(PT 1-1/4)
	Max. Hydraulic	Mpa	1.0	1.0	1.0
Rated flow rate(Water Piping)		LPM	48	92	150
Set Size	Net Weight	kg	29	33	40
	Shipping Weight	kg	31	35	42
	Net Dimension(WxHxD)	mm	518X627X330	518X627X330	518X627X330
	Shipping Dimension(WxHxD)	mm	652X700X426	652X700X426	652X700X426



- 1) Nominal cooling capacities are based on;
 - Indoor temperature : 27°C DB, 19°C WB
 - Outdoor temperature : 35°C DB, 24°C WB, Rated flow standard : Temperature of the Outlet water 18°C
- 2) Nominal heating capacities are based on;
 - Indoor temperature : 20°C DB, 15°C WB
 - Outdoor temperature : 7°C DB, 6°C WB, Rated flow standard : Temperature of the Outlet water 35°C
- 3) Rated heating capacity : Outdoor temperature 7°C standard and outdoor temperature falls below zero, heating capacity can drop, depending on the temperature condition.
- 4) Equivalent refrigerant piping : 7.5m, Level differences : 0m

Indoor Unit (cont.)

■ Hydro unit HT

Type (Hydro Unit HT)						
Model			AM160FNBFEF/EU	AM250FNBFEF/EU	AM160FNBFGF/EU	AM250FNBFGF/EU
Division			Heating	Heating	Heating	Heating
Power Supply			1ø, 220-240V, 50Hz	1ø, 220-240V, 50Hz	3ø, 380-415V, 50Hz	3ø, 380-415V, 50Hz
Performance	Horse Power	HP	5	8	5	8
	Heating	kW	16.0	25.0	16.0	25.0
		Kcal/h	13760	21500	13760	21500
Power	Running Current	A	14.3	23.1	4.85	7.85
	Input	W	3,100	5,000	3,100	5,000
Refrigerant	Type	-	R-134a	R-134a	R-134a	R-134a
	Charging	kg	2.15	2.15	2.15	2.15
Piping (Refrigerant)	Liquid	ø,mm	9.52	9.52	9.52	9.52
	Gas	ø,mm	15.88	15.88	15.88	15.88
Piping(Water)	Inlet/Outlet	A(Inch)	25A(PT1)	25A(PT1)	25A(PT1)	25A(PT1)
	Max. Hydraulic	Mpa	1.0	1.0	1.0	1.0
Rated flow rate(Water Piping)		LPM	23	36	23	36
Set Size	Net Weight	kg	104	104	104	104
	Shipping Weight	kg	107	107	107	107
	Net Dimension(WxHxD)	mm	518x1,210x330	518x1,210x330	518x1,210x330	518x1,210x330
	Shippingt Dimension(WxHxD)	mm	652x1,289x426	652x1,289x426	652x1,289x426	652x1,289x426



- 1) Nominal heating capacities are based on;
 - Indoor temperature : 20°C DB, 15°C WB
 - Outdoor temperature : 7°C DB, 6°C WB, Rated flow standard : Temperature of the Outlet water 65°C
- 2) Rated heating capacity : Outdoor temperature 7°C standard and outdoor temperature falls below zero, heating capacity can drop, depending on the temperature condition.
- 3) Equivalent refrigerant piping : 7.5m, Level differences : 0m

Indoor Unit (cont.)

■ Wall Mounted type(A3050 With EEV)

Model				AM015JNVDKH/EU	AM022JNVDKH*	AM028JNVDKH*	AM036JNVDKH*
Power Supply			Φ,#,V,Hz	1,220~240,50	1,220~240,50	1,220~240,50	1,220~240,50
Mode *1)				HP / HR	HP / HR	HP / HR	HP / HR
Performance	Capacity	Cooling*2)	kW	1.5	2.2	2.8	3.6
			Btu/h	5,115	7,502	9,548	12,276
		Heating*3)	kW	1.7	2.5	3.2	4.0
			Btu/h	5,797	8,525	10,912	13,640
Power	Power Input	Cooling	W	14 *5)	15 *5)	16 *5)	20 *5)
		Heating	W	16 *5)	18 *5)	24 *5)	28 *5)
	Current Input	Cooling	A	0.12 *5)	0.13 *5)	0.13 *5)	0.15 *5)
		Heating	A	0.13 *5)	0.15 *5)	0.19 *5)	0.20 *5)
Fan	Motor	Type	-	Crossflow Fan Φ83*L552	Crossflow Fan Φ83*L552	Crossflow Fan Φ83*L552	Crossflow Fan Φ98*L633
		Output	W	27	27	27	27
		Number of unit		1	1	1	1
	Airflow Rate	Cooling(High)	m ³ /min	4.40 *5)	4.50 *5)	5.70 *5)	7.10 *5)
		Heating(High)	m ³ /min	5.80 *5)	6.00 *5)	8.50 *5)	10.00 *5)
Piping Connections	Liquid Pipe		Φ,mm	6.35	6.35	6.35	6.35
			Φ,inch	1/4"	1/4"	1/4"	1/4"
	Gas Pipe		Φ,mm	12.70	12.70	12.70	12.70
			Φ,inch	1/2"	1/2"	1/2"	1/2"
Drain Pipe		Φ,mm	ID 18 HOSE	ID 18 HOSE	ID 18 HOSE	ID 18 HOSE	
Field Wiring	Power Source Wire	Below 20m/ over 20m"	mm ²	1.5 ~ 2.5	1.5 ~ 2.5	1.5 ~ 2.5	1.5 ~ 2.5
	Transmission Cable		mm ²	0.75 ~ 1.50	0.75 ~ 1.50	0.75 ~ 1.50	0.75 ~ 1.50
Refrigerant	Type		-	R410A	R410A	R410A	R410A
	Control Method		-	EEV INCLUDED	EEV INCLUDED	EEV INCLUDED	EEV INCLUDED
Sound	Sound Pressure*4)	High/Mid/Low	dBa	28/25/24	33/29/25	36/31/26	37/33/29
Dimensions	Net Weight		kg	8.1	8.1	8.2	9.8
	Shipping Weight		kg	9.7	9.7	9.8	11.7
	Net Dimensions (W x H x D)		mm	750*250*242	750*250*242	750*250*242	826*275*260
	Shipping Dimensions (W x H x D)		mm	800*302*298	800*302*298	800*302*298	886*335*317
Functions	Auto Restart		-	O	O	O	O
	Auto Swing		-	O	O	O	O
	Group/Individual Control		-	O	O	O	O
	External Contact Control		-	O	O	O	O
	Trouble Shooting by LED		-	O	O	O	O
Standard Accessories	Installation Manual		-	O	O	O	O
	Operation Manual		-	O	O	O	O
	Pattern Sheet for Installation		-	X	X	X	X
	Flexible Drain Hose		-	O	O	O	O
	Filter / Safety Grille		-	Filter (Washable)	Filter (Washable)	Filter (Washable)	Filter (Washable)
	Wireless Remote Controller		-	MR-EH00	MR-EH00	MR-EH00	MR-EH00
Optional Accessories	Wireless Remote Controller		-	-	-	-	-
	Wired Remote Controller	Simplified	-	MWR-WE10N	MWR-WE10N	MWR-WE10N	MWR-WE10N
	External Contact Interface Module		-	MIM-B14	MIM-B14	MIM-B14	MIM-B14



*1) Mode

- HP : Heat Pump, HR : Heat Recovery

*2) Nominal cooling capacities are based on;

- Indoor temperature : 27°C DB, 19°C WB

- Outdoor temperature : 35°C DB, 24°C WB, Equivalent refrigerant piping : 7.5m, Level differences : 0m

*3) Nominal heating capacities are based on;

- Indoor temperature : 20°C DB, 15°C WB

- Outdoor temperature : 7°C DB, 6°C WB, Equivalent refrigerant piping : 7.5m, Level differences : 0m

*4) Sound pressure was acquired in a dead room. Thus actual noise level may be different depending on the installation conditions.

*5) Specifications may be subject to change without prior notice for product improvement.

Indoor Unit (cont.)

■ Wall Mounted type(A3050 With EEV)(cont.)

Model			AM045JNVDKH*	AM056JNVDKH*	AM071JNVDKH*	AM082JNVDKH*	
Power Supply			Φ,#,V,Hz	1,220~240,50	1,220~240,50	1,220~240,50	
Mode *1)				HP / HR	HP / HR	HP / HR	
Performance	Capacity	Cooling*2)	kW	4.5	5.6	7.1	8.2
			Btu/h	15,345	19,096	24,211	27,962
		Heating*3)	kW	5.0	6.3	8.0	8.5
			Btu/h	17,050	21,483	27,280	28,985
Power	Power Input	Cooling	W	31	27	41	55
		Heating	W	41	37	53	72
	Current Input	Cooling	A	0.24	0.21	0.31	0.42
		Heating	A	0.31	0.29	0.41	0.55
Fan	Motor	Type	-	Crossflow Fan Φ98*L633	Crossflow Fan Φ106*L830	Crossflow Fan Φ106*L830	Crossflow Fan Φ106*L830
		Output	W	27	27	27	27
		Number of unit		1	1	1	1
	Airflow Rate	Cooling(High)	m ³ /mim	9.30	11.80	14.80	17.30
		Heating(High)	m ³ /mim	12.60	15.00	18.00	20.40
Piping Connections	Liquid Pipe		Φ,mm	6.35	6.35	9.52	9.52
			Φ,inch	1/4"	1/4"	3/8"	3/8"
	Gas Pipe		Φ,mm	12.70	12.70	15.88	15.88
			Φ,inch	1/2"	1/2"	5/8"	5/8"
Drain Pipe		Φ,mm	ID 18 HOSE	ID 18 HOSE	ID 18 HOSE	ID 18 HOSE	
Field Wiring	Power Source Wire	Below 20m/ over 20m	mm2	1.5 ~ 2.5	1.5 ~ 2.5	1.5 ~ 2.5	1.5 ~ 2.5
	Transmission Cable		mm2	0.75 ~ 1.50	0.75 ~ 1.50	0.75 ~ 1.50	0.75 ~ 1.50
Refrigerant	Type		-	R410A	R410A	R410A	R410A
	Control Method		-	EEV INCLUDED	EEV INCLUDED	EEV INCLUDED	EEV INCLUDED
Sound	Sound Pressure*4)	High/Mid/Low	dBa	42/38/35	39/36/33	44/41/36	47/44/41
Dimensions	Net Weight		kg	9.8	14.6	14.6	14.6
	Shipping Weight		kg	11.7	17.0	17.0	17.0
	Net Dimensions (W x H x D)		mm	826*275*260	1063*317*294	1063*317*294	1063*317*294
	Shipping Dimensions (W x H x D)		mm	886*335*317	1123*384*354	1123*384*354	1123*384*354
Functions	Auto Restart		-	O	O	O	O
	Auto Swing		-	O	O	O	O
	Group/Individual Control		-	O	O	O	O
	External Contact Control		-	O	O	O	O
	Trouble Shooting by LED		-	O	O	O	O
Standard Accessories	Installation Manual		-	O	O	O	O
	Operation Manual		-	O	O	O	O
	Pattern Sheet for Installation		-	X	X	X	X
	Flexible Drain Hose		-	O	O	O	O
	Filter / Safety Grille		-	Filter (Washable)	Filter (Washable)	Filter (Washable)	Filter (Washable)
	Wireless Remote Controller		-	MR-EH00	MR-EH00	MR-EH00	MR-EH00
Optional Accessories	Wireless Remote Controller		-	-	-	-	
	Wired Remote Controller	Simplified	-	MWR-WE10N	MWR-WE10N	MWR-WE10N	MWR-WE10N
	External Contact Interface Module		-	MIM-B14	MIM-B14	MIM-B14	MIM-B14



*1) Mode

- HP : Heat Pump, HR : Heat Recovery

*2) Nominal cooling capacities are based on;

- Indoor temperature : 27°C DB, 19°C WB

- Outdoor temperature : 35°C DB, 24°C WB, Equivalent refrigerant piping : 7.5m, Level differences : 0m

*3) Nominal heating capacities are based on;

- Indoor temperature : 20°C DB, 15°C WB

- Outdoor temperature : 7°C DB, 6°C WB, Equivalent refrigerant piping : 7.5m, Level differences : 0m

*4) Sound pressure was acquired in a dead room. Thus actual noise level may be different depending on the installation conditions.

*5) Specifications may be subject to change without prior notice for product improvement.

Indoor Unit (cont.)

■ Wall Mounted type(A3050 With EEV)

Model			AM015JNVDEH/TK	AM022JNVDEH/TK	AM028JNVDEH/TK	AM036JNVDEH/TK	
Power Supply			Φ,#,V,Hz	1,220~240,50	1,220~240,50	1,220~240,50	1,220~240,50
Mode *1)				HP / HR	HP / HR	HP / HR	HP / HR
Performance	Capacity	Cooling*2)	kW	1.5	2.2	2.8	3.6
			Btu/h	5,115	7,502	9,548	12,276
		Heating*3)	kW	1.7	2.5	3.2	4.0
			Btu/h	5,797	8,525	10,912	13,640
Power	Power Input	Cooling	W	14	15	16	20
		Heating	W	16	18	24	28
	Current Input	Cooling	A	0.12	0.13	0.13	0.15
		Heating	A	0.13	0.15	0.19	0.20
Fan	Motor	Type	-	Crossflow Fan Φ83*L552	Crossflow Fan Φ83*L552	Crossflow Fan Φ83*L552	Crossflow Fan Φ98*L633
		Output	W	27	27	27	27
		Number of unit		1	1	1	1
	Airflow Rate	Cooling(High)	m ³ /mim	4.40	4.50	5.70	7.10
		Heating(High)	m ³ /mim	5.80	6.00	8.50	10.00
Piping Connections	Liquid Pipe		Φ,mm	6.35	6.35	6.35	6.35
			Φ,inch	1/4"	1/4"	1/4"	1/4"
	Gas Pipe		Φ,mm	12.70	12.70	12.70	12.70
			Φ,inch	1/2"	1/2"	1/2"	1/2"
Drain Pipe		Φ,mm	ID 18 HOSE	ID 18 HOSE	ID 18 HOSE	ID 18 HOSE	
Field Wiring	Power Source Wire	Below 20m/ over 20m"	mm ²	1.5 ~ 2.5	1.5 ~ 2.5	1.5 ~ 2.5	1.5 ~ 2.5
	Transmission Cable		mm ²	0.75 ~ 1.50	0.75 ~ 1.50	0.75 ~ 1.50	0.75 ~ 1.50
Refrigerant	Type		-	R410A	R410A	R410A	R410A
	Control Method		-	EEV INCLUDED	EEV INCLUDED	EEV INCLUDED	EEV INCLUDED
Sound	Sound Pressure*4)	High/Mid/Low	dBA	28/25/24	33/29/25	36/31/26	37/33/29
Dimensions	Net Weight		kg	8.1	8.1	8.2	9.8
	Shipping Weight		kg	9.8	9.8	9.9	11.8
	Net Dimensions (W x H x D)		mm	750*250*242	750*250*242	750*250*242	826*275*260
	Shipping Dimensions (W x H x D)		mm	800*302*298	800*302*298	800*302*298	886*335*317
Functions	Auto Restart		-	O	O	O	O
	Auto Swing		-	O	O	O	O
	Group/Individual Control		-	O	O	O	O
	External Contact Control		-	O	O	O	O
	Trouble Shooting by LED		-	O	O	O	O
Standard Accessories	Installation Manual		-	O	O	O	O
	Operation Manual		-	O	O	O	O
	Pattern Sheet for Installation		-	X	X	X	X
	Flexible Drain Hose		-	O	O	O	O
	Filter / Safety Grille		-	Filter (Washable)	Filter (Washable)	Filter (Washable)	Filter (Washable)
	Wireless Remote Controller		-	MR-EH00	MR-EH00	MR-EH00	MR-EH00
Optional Accessories	Wireless Remote Controller		-	-	-	-	-
	Wired Remote Controller	Simplified	-	MWR-WE10N	MWR-WE10N	MWR-WE10N	MWR-WE10N
	External Contact Interface Module		-	MIM-B14	MIM-B14	MIM-B14	MIM-B14



*1) Mode

- HP : Heat Pump, HR : Heat Recovery

*2) Nominal cooling capacities are based on;

- Indoor temperature : 27°C DB, 19°C WB

- Outdoor temperature : 35°C DB, 24°C WB, Equivalent refrigerant piping : 7.5m, Level differences : 0m

*3) Nominal heating capacities are based on;

- Indoor temperature : 20°C DB, 15°C WB

- Outdoor temperature : 7°C DB, 6°C WB, Equivalent refrigerant piping : 7.5m, Level differences : 0m

*4) Sound pressure was acquired in a dead room. Thus actual noise level may be different depending on the installation conditions.

*5) Specifications may be subject to change without prior notice for product improvement.

Indoor Unit (cont.)

■ Wall Mounted type(A3050 With EEV)(cont.)

Model			AM045JNVDEH/TK	AM056JNVDEH/TK	AM071JNVDKH/TK	AM082JNVDEH/TK	
Power Supply			Φ,#,V,Hz	1,220~240,50	1,220~240,50	1,220~240,50	
Mode *1)				HP / HR	HP / HR	HP / HR	
Performance	Capacity	Cooling*2)	kW	4.5	5.6	7.1	8.2
			Btu/h	15,345	19,096	24,211	27,962
		Heating*3)	kW	5.0	6.3	8.0	8.5
			Btu/h	17,050	21,483	27,280	28,985
Power	Power Input	Cooling	W	31	27	41	55
		Heating	W	41	37	53	72
	Current Input	Cooling	A	0.24	0.21	0.31	0.42
		Heating	A	0.31	0.29	0.41	0.55
Fan	Motor	Type	-	Crossflow Fan Φ98*L633	Crossflow Fan Φ106*L830	Crossflow Fan Φ106*L830	Crossflow Fan Φ106*L830
		Output	W	27	27	27	27
		Number of unit		1	1	1	1
	Airflow Rate	Cooling(High)	m ³ /mim	9.30	11.80	14.80	17.30
		Heating(High)	m ³ /mim	12.60	15.00	18.00	20.40
Piping Connections	Liquid Pipe		Φ,mm	6.35	6.35	9.52	9.52
			Φ,inch	1/4"	1/4"	3/8"	3/8"
	Gas Pipe		Φ,mm	12.70	12.70	15.88	15.88
			Φ,inch	1/2"	1/2"	5/8"	5/8"
Drain Pipe		Φ,mm	ID 18 HOSE	ID 18 HOSE	ID 18 HOSE	ID 18 HOSE	
Field Wiring	Power Source Wire	Below 20m/ over 20m"	mm2	1.5 ~ 2.5	1.5 ~ 2.5	1.5 ~ 2.5	1.5 ~ 2.5
	Transmission Cable		mm2	0.75 ~ 1.50	0.75 ~ 1.50	0.75 ~ 1.50	0.75 ~ 1.50
Refrigerant	Type		-	R410A	R410A	R410A	R410A
	Control Method		-	EEV INCLUDED	EEV INCLUDED	EEV INCLUDED	EEV INCLUDED
Sound	Sound Pressure*4)	High/Mid/Low	dBa	42/38/35	39/36/33	44/41/36	47/44/41
Dimensions	Net Weight		kg	9.8	14.6	14.6	14.6
	Shipping Weight		kg	11.8	17.1	17.1	17.1
	Net Dimensions (W x H x D)		mm	826*275*260	1063*317*294	1063*317*294	1063*317*294
	Shipping Dimensions (W x H x D)		mm	886*335*317	1123*384*354	1123*384*354	1123*384*354
Functions	Auto Restart		-	O	O	O	O
	Auto Swing		-	O	O	O	O
	Group/Individual Control		-	O	O	O	O
	External Contact Control		-	O	O	O	O
	Trouble Shooting by LED		-	O	O	O	O
Standard Accessories	Installation Manual		-	O	O	O	O
	Operation Manual		-	O	O	O	O
	Pattern Sheet for Installation		-	X	X	X	X
	Flexible Drain Hose		-	O	O	O	O
	Filter / Safety Grille		-	Filter (Washable)	Filter (Washable)	Filter (Washable)	Filter (Washable)
	Wireless Remote Controller		-	MR-EH00	MR-EH00	MR-EH00	MR-EH00
Optional Accessories	Wireless Remote Controller		-	-	-	-	-
	Wired Remote Controller	Simplified	-	MWR-WE10N	MWR-WE10N	MWR-WE10N	MWR-WE10N
	External Contact Interface Module		-	MIM-B14	MIM-B14	MIM-B14	MIM-B14



*1) Mode

- HP : Heat Pump, HR : Heat Recovery

*2) Nominal cooling capacities are based on;

- Indoor temperature : 27°C DB, 19°C WB

- Outdoor temperature : 35°C DB, 24°C WB, Equivalent refrigerant piping : 7.5m, Level differences : 0m

*3) Nominal heating capacities are based on;

- Indoor temperature : 20°C DB, 15°C WB

- Outdoor temperature : 7°C DB, 6°C WB, Equivalent refrigerant piping : 7.5m, Level differences : 0m

*4) Sound pressure was acquired in a dead room. Thus actual noise level may be different depending on the installation conditions.

*5) Specifications may be subject to change without prior notice for product improvement.

Indoor Unit (cont.)

■ Wall Mounted type(A3050 Without EEV)

Model			AM015JNADKH/EU	AM022JNADKH/EU	AM028JNADKH/EU	AM036JNADKH/EU	
Power Supply			Φ,#,V,Hz	1,220~240,50	1,220~240,50	1,220~240,50	1,220~240,50
Mode *1)				HP / HR	HP / HR	HP / HR	HP / HR
Performance	Capacity	Cooling*2)	kW	1.5	2.2	2.8	3.6
			Btu/h	5,115	7,502	9,548	12,276
		Heating*3)	kW	1.7	2.5	3.2	4.0
			Btu/h	5,797	8,525	10,912	13,640
Power	Power Input	Cooling	W	14	15	16	20
		Heating	W	16	18	24	28
	Current Input	Cooling	A	0.12	0.13	0.13	0.15
		Heating	A	0.13	0.15	0.19	0.20
Fan	Motor	Type	-	Crossflow Fan Φ83*L552	Crossflow Fan Φ83*L552	Crossflow Fan Φ83*L552	Crossflow Fan Φ98*L633
		Output	W	27	27	27	27
		Number of unit		1	1	1	1
	Airflow Rate	Cooling(High)	m ³ /min	4.40	4.50	5.70	7.10
		Heating(High)	m ³ /min	5.80	6.00	8.50	10.00
Piping Connections	Liquid Pipe		Φ,mm	6.35	6.35	6.35	6.35
			Φ,inch	1/4"	1/4"	1/4"	1/4"
	Gas Pipe		Φ,mm	12.70	12.70	12.70	12.70
			Φ,inch	1/2"	1/2"	1/2"	1/2"
Drain Pipe		Φ,mm	ID 18 HOSE	ID 18 HOSE	ID 18 HOSE	ID 18 HOSE	
Field Wiring	Power Source Wire	Below 20m/ over 20m"	mm2	1.5 ~ 2.5	1.5 ~ 2.5	1.5 ~ 2.5	1.5 ~ 2.5
	Transmission Cable		mm2	0.75 ~ 1.50	0.75 ~ 1.50	0.75 ~ 1.50	0.75 ~ 1.50
Refrigerant	Type		-	R410A	R410A	R410A	R410A
	Control Method		-	EEV NOT INCLUDED	EEV NOT INCLUDED	EEV NOT INCLUDED	EEV NOT INCLUDED
Sound	Sound Pressure*4)	High/Mid/Low	dBa	28/25/24	33/29/25	36/31/26	37/33/29
Dimensions	Net Weight		kg	7.9	7.9	8.0	9.5
	Shipping Weight		kg	9.5	9.5	9.6	11.4
	Net Dimensions (W x H x D)		mm	750*250*242	750*250*242	750*250*242	826*275*260
	Shipping Dimensions (W x H x D)		mm	800*302*298	800*302*298	800*302*298	886*335*317
Functions	Auto Restart		-	O	O	O	O
	Auto Swing		-	O	O	O	O
	Group/Individual Control		-	O	O	O	O
	External Contact Control		-	O	O	O	O
	Trouble Shooting by LED		-	O	O	O	O
Standard Accessories	Installation Manual		-	O	O	O	O
	Operation Manual		-	O	O	O	O
	Pattern Sheet for Installation		-	X	X	X	X
	Flexible Drain Hose		-	O	O	O	O
	Filter / Safety Grille		-	Filter (Washable)	Filter (Washable)	Filter (Washable)	Filter (Washable)
	Wireless Remote Controller		-	MR-EH00	MR-EH00	MR-EH00	MR-EH00
Optional Accessories	Wireless Remote Controller		-	-	-	-	-
	Wired Remote Controller	Simplified	-	MWR-WE10N	MWR-WE10N	MWR-WE10N	MWR-WE10N
	External Contact Interface Module		-	MIM-B14	MIM-B14	MIM-B14	MIM-B14



*1) Mode

- HP : Heat Pump, HR : Heat Recovery

*2) Nominal cooling capacities are based on;

- Indoor temperature : 27°C DB, 19°C WB

- Outdoor temperature : 35°C DB, 24°C WB, Equivalent refrigerant piping : 7.5m, Level differences : 0m

*3) Nominal heating capacities are based on;

- Indoor temperature : 20°C DB, 15°C WB

- Outdoor temperature : 7°C DB, 6°C WB, Equivalent refrigerant piping : 7.5m, Level differences : 0m

*4) Sound pressure was acquired in a dead room. Thus actual noise level may be different depending on the installation conditions.

*5) Specifications may be subject to change without prior notice for product improvement.

Indoor Unit (cont.)

■ Wall Mounted type(A3050 Without EEV)(cont.)

Model			AM045JNADKH/EU	AM056JNADKH/EU	AM071JNADKH/EU	AM082JNADKH/EU	
Power Supply			Φ,#,V,Hz	1,220~240,50	1,220~240,50	1,220~240,50	
Mode *1)				HP / HR	HP / HR	HP / HR	
Performance	Capacity	Cooling*2)	kW	4.5	5.6	7.1	8.2
			Btu/h	15,345	19,096	24,211	27,962
		Heating*3)	kW	5.0	6.3	8.0	8.5
			Btu/h	17,050	21,483	27,280	28,985
Power	Power Input	Cooling	W	31	27	41	55
		Heating	W	41	37	53	72
	Current Input	Cooling	A	0.24	0.21	0.31	0.42
		Heating	A	0.31	0.29	0.41	0.55
Fan	Motor	Type	-	Crossflow Fan Φ98*L633	Crossflow Fan Φ106*L830	Crossflow Fan Φ106*L830	Crossflow Fan Φ106*L830
		Output	W	27	27	27	27
		Number of unit		1	1	1	1
	Airflow Rate	Cooling(High)	m ³ /mim	9.30	11.80	14.80	17.30
		Heating(High)	m ³ /mim	12.60	15.00	18.00	20.40
Piping Connections	Liquid Pipe		Φ,mm	6.35	6.35	9.52	9.52
			Φ,inch	1/4"	1/4"	3/8"	3/8"
	Gas Pipe		Φ,mm	12.70	12.70	15.88	15.88
			Φ,inch	1/2"	1/2"	5/8"	5/8"
Drain Pipe		Φ,mm	ID 18 HOSE	ID 18 HOSE	ID 18 HOSE	ID 18 HOSE	
Field Wiring	Power Source Wire	Below 20m/ over 20m"	mm2	1.5 ~ 2.5	1.5 ~ 2.5	1.5 ~ 2.5	1.5 ~ 2.5
	Transmission Cable		mm2	0.75 ~ 1.50	0.75 ~ 1.50	0.75 ~ 1.50	0.75 ~ 1.50
Refrigerant	Type		-	R410A	R410A	R410A	R410A
	Control Method		-	EEV NOT INCLUDED	EEV NOT INCLUDED	EEV NOT INCLUDED	EEV NOT INCLUDED
Sound	Sound Pressure*4)	High/Mid/Low	dBa	42/38/35	39/36/33	44/41/36	47/44/41
Dimensions	Net Weight		kg	9.5	14.3	14.3	14.3
	Shipping Weight		kg	11.4	16.7	16.7	16.7
	Net Dimensions (W x H x D)		mm	826*275*260	1063*317*294	1063*317*294	1063*317*294
	Shipping Dimensions (W x H x D)		mm	886*335*317	1123*384*354	1123*384*354	1123*384*354
Functions	Auto Restart		-	O	O	O	O
	Auto Swing		-	O	O	O	O
	Group/Individual Control		-	O	O	O	O
	External Contact Control		-	O	O	O	O
	Trouble Shooting by LED		-	O	O	O	O
Standard Accessories	Installation Manual		-	O	O	O	O
	Operation Manual		-	O	O	O	O
	Pattern Sheet for Installation		-	X	X	X	X
	Flexible Drain Hose		-	O	O	O	O
	Filter / Safety Grille		-	Filter (Washable)	Filter (Washable)	Filter (Washable)	Filter (Washable)
	Wireless Remote Controller		-	MR-EH00	MR-EH00	MR-EH00	MR-EH00
Optional Accessories	Wireless Remote Controller		-	-	-	-	-
	Wired Remote Controller	Simplified	-	MWR-WE10N	MWR-WE10N	MWR-WE10N	MWR-WE10N
	External Contact Interface Module		-	MIM-B14	MIM-B14	MIM-B14	MIM-B14



*1) Mode

- HP : Heat Pump, HR : Heat Recovery

*2) Nominal cooling capacities are based on;

- Indoor temperature : 27°C DB, 19°C WB

- Outdoor temperature : 35°C DB, 24°C WB, Equivalent refrigerant piping : 7.5m, Level differences : 0m

*3) Nominal heating capacities are based on;

- Indoor temperature : 20°C DB, 15°C WB

- Outdoor temperature : 7°C DB, 6°C WB, Equivalent refrigerant piping : 7.5m, Level differences : 0m

*4) Sound pressure was acquired in a dead room. Thus actual noise level may be different depending on the installation conditions.

*5) Specifications may be subject to change without prior notice for product improvement.

Indoor Unit (cont.)

■ Wall Mounted type (MAX With EEV)

Model				AM093MNQDEH/EU	AM093MNQDEH/TK
Power Supply			Φ,#,V,Hz	1,220~240,50	1,220~240,50
Mode *1)			-	HP / HR	HP / HR
Performance	Capacity	Cooling*2)	kW	9.3	9.3
			Btu/h	31,700	31,700
		Heating*3)	kW	9.8	9.8
			Btu/h	33,400	33,400
Power	Power Input	Cooling	W	66	66
		Heating	W	76	76
	Current Input	Cooling	A	0.47	0.47
		Heating	A	0.54	0.54
Fan	Type		-	Crossflow Fan Φ107*L485, 2EA	Crossflow Fan Φ107*L485, 2EA
	Motor	Type	-	BLDC	BLDC
		Output	W	58	58
		Number of unit	-	1	1
	Airflow Rate	Cooling(High)	m ³ /min	22.5	22.5
Heating(High)		m ³ /min	25.0	25.0	
Piping Connections	Liquid Pipe		Φ,mm	9.52	9.52
			Φ,inch	3/8"	3/8"
	Gas Pipe		Φ,mm	15.88	15.88
			Φ,inch	5/8"	5/8"
Drain Pipe		Φ,mm	ID 18 HOSE	ID 18 HOSE	
Field Wiring	Power Source Wire	Below 20m/ over 20m	mm ²	1.5 ~ 2.5	1.5 ~ 2.5
	Transmission Cable		mm ²	0.75 ~ 1.50	0.75 ~ 1.50
Refrigerant	Type		-	R410A	R410A
	Control Method		-	EEV INCLUDED	EEV INCLUDED
Sound	Sound Pressure*4)	Cooling/Heating	dBA	55/56	55/56
Dimensions	Net Weight		kg	18.5	18.5
	Shipping Weight		kg	22	22
	Net Dimensions (W x H x D)		mm	1280*345*253	1280*345*253
	Shipping Dimensions (W x H x D)		mm	1352*420*326	1352*420*326
Functions	Auto Restart		-	O	O
	Auto Swing		-	O	O
	Group/Individual Control		-	O	O
	External Contact Control		-	O	O
	Trouble Shooting by LED		-	O	O
Standard Accessories	Installation Manual		-	O	O
	Operation Manual		-	O	O
	Pattern Sheet for Installation		-	X	X
	Flexible Drain Hose		-	O	O
	Filter / Safety Grille		-	Filter (Washable)	Filter (Washable)
	Wireless Remote Controller		-	MR-EH00	MR-EH00
Optional Accessories	Wireless Remote Controller		-	-	-
	Wired Remote Controller	Simplified	-	MWR-WE10N	MWR-WE10N
	External Contact Interface Module		-	MIM-B14	MIM-B14



*1) Mode

- HP : Heat Pump, HR : Heat Recovery

*2) Nominal cooling capacities are based on;

- Indoor temperature : 27°C DB, 19°C WB

- Outdoor temperature : 35°C DB, 24°C WB, Equivalent refrigerant piping : 7.5m, Level differences : 0m

*3) Nominal heating capacities are based on;

- Indoor temperature : 20°C DB, 15°C WB

- Outdoor temperature : 7°C DB, 6°C WB, Equivalent refrigerant piping : 7.5m, Level differences : 0m

*4) Sound pressure was acquired in a dead room. Thus actual noise level may be different depending on the installation conditions.

*5) Specifications may be subject to change without prior notice for product improvement.

Indoor Unit (cont.)

■ Fresh Air Duct

Model			AM140JNEPEH/EU	AM220JNEPEH/EU	AM280JNEPEH/EU
Power Supply		Φ, #, V, Hz	1,2,220-240,50	1,2,220-240,50	1,2,220-240,50
Mode*1)			HP	HP	HP
Performance	Capacity	Cooling*2)	kW	14.0	28.0
			Btu/h	-	-
	Heating*3)	kW	8.9	17.4	17.4
		Btu/h	-	-	-
Condensate (with High fan speed)		Liters/h			
Power	Input		W	220	300
	Running Current		A	1.6	2.2
Sound Level	Sound Pressure (High/Low)*4)		dB(A)	48	52
Fan	Type		-	Sirocco Fan	Sirocco Fan
	Motor	Model	-		
		Type	-	BLDC	BLDC
		Output	W		
Airflow Rate	H/M/L		m3/min	18	28
	External Pressure	Min/Std/Max	mmAq	20	25
Refrigerant	Type		-	R410A	R410A
	Control Method		-	EEV	EEV
Temperature Control			-	Micom&Thermistors	Micom&Thermistors
Safety Devices			-	Fuse	Fuse
Piping Connections	Liquid (Flare)		ø, mm	9.52	9.52
	Gas (Flare)		ø, mm	15.88	22.22
	Drain		ø, mm	VP25 (OD 32,ID 25)	VP25 (OD 32,ID 25)
Weight	Net Weight		kg	51	85
	Shipping Weight		kg	61	95
Dimensions	Net Dimensions (W x H x D)		mm	1110x390x650	1240x470x1040
	Shipping Dimensions (W x H x D)		mm	1335x512x829	1507x558x1155
Functions	Auto Restart		-	O	O
	Auto Swing		-	X	X
	Group/Individual Control		-	O	O
	External Contact Control		-	O	O
	Trouble Shooting by LED		-	O	O
Standard Accessories	Installation Manual		-	O	O
	Operation Manual		-	O	O
	Pattern Sheet for Installation		-	O	O
	Flexible Drain Hose		-	X	X
	Filter / Safety Grille		-	X	X
Optional Accessories	Wireless Remote Controller		-		
	DMS 2.0		-	MIM-D00AN	MIM-D00AN
	Wired Remote Controller	Simplified	-	MWR-WE10N	MWR-WE10N
		EHS	-	MWR-WW00N	MWR-WW00N
	External Contact Interface Module		-	MIM-B14	MIM-B14
Drain Pump			MDP-N047SNC0D	ADP-N047SNC1D	



*1) Mode

- HP : Heat Pump, HR : Heat Recovery

*2) Nominal cooling capacities are based on;

- Indoor temperature : 27°C DB, 19°C WB

- Outdoor temperature : 35°C DB, 24°C WB, Equivalent refrigerant piping : 7.5m, Level differences : 0m

*3) Nominal heating capacities are based on;

- Indoor temperature : 20°C DB, 15°C WB

- Outdoor temperature : 7°C DB, 6°C WB, Equivalent refrigerant piping : 7.5m, Level differences : 0m

*4) Sound pressure was acquired in a dead room. Thus actual noise level may be different depending on the installation conditions.

*5) Specifications may be subject to change without prior notice for product improvement.

Indoor Unit (cont.)

■ V-AHU

Model			V-AHU			
			AM012JNZDCH/AA	AM018JNZDCH/AA	AM024JNZDCH/AA	
Power Supply		Φ, #, V, Hz	1,2,208-230,60	1,2,208-230,60	1,2,208-230,60	
Mode		-	HP, HR	HP, HR	HP, HR	
Performance	Capacity (Nominal)	Cooling	kW	-	-	
			Btu/h	12,000	18,000	24,000
		Heating	kW	-	-	-
			Btu/h	13,500	22,000	27,000
Power	Power Input (Nominal)	Cooling	W	64	94	144
		Heating	W	64	94	144
	Current Input (Nominal)	Cooling	A	0.49	0.74	1.12
		Heating	A	0.49	0.74	1.12
Fan	Motor	Type	-	ECM (ACTAP)	ECM (ACTAP)	ECM (ACTAP)
		Output x n	W	290 x 1	290 x 1	290 x 1
	Air Flow Rate	H/M/L (UL) @ Std ESP	CFM	373 / - / 320	531 / - / 467	706 / - / 630
			CMM	10.6 / - / 9.1	15.0 / - / 13.2	20.0 / - / 17.8
			l/s	-	-	-
	External Pressure	Min / Std / Max	in w.c.	0.1 / 0.4 / 0.5	0.1 / 0.4 / 0.7	0.1 / 0.4 / 0.7
mmAq			2.5 / 10 / 12.5	2.5 / 10 / 17.5	2.5 / 10 / 17.5	
Sound	Sound Pressure (Catalog)	High / Mid / Low	dB(A)	38 / - / -	39 / - / -	41 / - / -
	Sound Pressure	High / Mid / Low		43 / - / -	44 / - / -	47 / - / -
	Sound Power	Cooling		-	-	-
Refrigerant	Type	-	R-410A	R-410A	R-410A	
	Control Method	-	EEV INCLUDED	EEV INCLUDED	EEV INCLUDED	
Piping Connections	Liquid Pipe	Φ, mm	-	-	-	
		Φ, inch	1/4	1/4	3/8	
	Gas Pipe	Φ, mm	-	-	-	
		Φ, inch	1/2	1/2	5/8	
Drain Pipe	Φ, inch	FPT 3/4"	FPT 3/4"	FPT 3/4"		
Dimensions	Net Weight	lbs	97	101	101	
		kg	44.0	45.8	45.8	
	Shipping Weight	lbs	106	110	110	
		kg	48.3	50.1	50.1	
	Net Dimensions (WxHxD)	inch	17 1/2 x 43 x 21	17 1/2 x 43 x 21	17 1/2 x 43 x 21	
		mm	445 x 1,092 x 533	445 x 1,092 x 533	445 x 1,092 x 533	
Shipping Dimensions (WxHxD)	inch	19 1/2 x 44 3/4 x 26 1/4	19 1/2 x 44 3/4 x 26 1/4	19 1/2 x 44 3/4 x 26 1/4		
	mm	493 x 1,135 x 665	493 x 1,135 x 665	493 x 1,135 x 665		
Panel Size	Panel model	-	-	-	-	
	Panel Net Weight	kg	-	-	-	
	Shipping Weight	kg	-	-	-	
	Net Dimensions (WxHxD)	mm	-	-	-	
	Shipping Dimensions (WxHxD)	mm	-	-	-	
Function	Auto Restart	-	○	○	○	
	Auto Swing	-	X	X	X	
	Group/Individual Control	-	○	○	○	
	External Contact Control	-	○	○	○	
	Trouble Shooting by LED	-	○	○	○	
Additional Accessories	Individual CONTROLLER	WIRED REMOTE	MWR-WE10N	MWR-WE10N(Optional)	MWR-WE10N(Optional)	MWR-WE10N(Optional)
		Simple Wired Remote Controller	MWR-SH00N	MWR-SH00N(Optional)	MWR-SH00N(Optional)	MWR-SH00N(Optional)
	Drain pump	Drain pump	- / model name	-	-	-
		Max. lifting Height / Displacement	mm / liter/h	-	-	-
Air Filter		-	X	X	X	



*1) Mode

- HP : Heat Pump, HR : Heat Recovery

*2) Nominal cooling capacities are based on;

- Indoor temperature : 27°C DB, 19°C WB

- Outdoor temperature : 35°C DB, 24°C WB, Equivalent refrigerant piping : 7.5m, Level differences : 0m

*3) Nominal heating capacities are based on;

- Indoor temperature : 20°C DB, 15°C WB

- Outdoor temperature : 7°C DB, 6°C WB, Equivalent refrigerant piping : 7.5m, Level differences : 0m

*4) Sound pressure was acquired in a dead room. Thus actual noise level may be different depending on the installation conditions.

*5) Specifications may be subject to change without prior notice for product improvement.

Indoor Unit (cont.)

■ V-AHU(cont.)

Model			V-AHU		
			AM030JNZDCH/AA	AM036JNZDCH/AA	AM048JNZDCH/AA
Power Supply		Φ, #, V, Hz	1,2,208-230,60	1,2,208-230,60	1,2,208-230,60
Mode		-	HP,HR	HP,HR	HP,HR
Performance	Capacity (Nominal)	Cooling	kW	-	-
			Btu/h	30,000	36,000
	Heating		kW	-	-
			Btu/h	34,000	40,000
Power	Power Input (Nominal)	Cooling	W	218	218
		Heating		218	218
	Current Input (Nominal)	Cooling	A	1.58	1.58
		Heating		1.58	1.58
Fan	Motor	Type	-	ECM (ACTAP)	ECM (ACTAP)
		Output x n	W	410 x 1	410 x 1
	Air Flow Rate	H/M/L (UL) @ Std ESP	CFM	1,053 / - / 921	1,053 / - / 921
			CMM	29.8 / - / 26.1	29.8 / - / 26.1
			l/s	-	-
	External Pressure	Min / Std / Max	in w.c.	0.1 / 0.4 / 1.0	0.1 / 0.4 / 1.0
mmAq			2.5 / 10 / 25.0	2.5 / 10 / 25.0	
Sound	Sound Pressure (Catalog)	High / Mid / Low	dB(A)	42 / - / -	42 / - / -
	Sound Pressure	High / Mid / Low		47 / - / -	47 / - / -
	Sound Power	Cooling		-	-
Refrigerant	Type		-	R-410A	R-410A
	Control Method		-	EEV INCLUDED	EEV INCLUDED
Piping Connections	Liquid Pipe	Φ,mm	-	-	-
		Φ,inch	3/8	3/8	3/8
	Gas Pipe	Φ,mm	-	-	-
		Φ,inch	5/8	5/8	5/8
Drain Pipe	Φ,inch	FPT 3/4"	FPT 3/4"	FPT 3/4"	
Dimensions	Net Weight	lbs	120	126	157
		kg	54.5	57.2	71.2
	Shipping Weight	lbs	131	137	170
		kg	59.3	62.0	77.1
	Net Dimensions (WxHxD)	inch	21 x 48 x 21	21 x 48 x 21	24 1/2 x 58 3/4 x 21 3/4
		mm	533 x 1,219 x 533	533 x 1,219 x 533	622 x 1,492 x 553
Shipping Dimensions (WxHxD)	inch	23 1/4 x 51 1/2 x 26 1/4	23 1/4 x 51 1/2 x 26 1/4	26 1/2 x 62 1/2 x 27 1/4	
	mm	590 x 1,305 x 665	590 x 1,305 x 665	676 x 1,588 x 695	
Panel Size	Panel model		-	-	-
	Panel Net Weight		kg	-	-
	Shipping Weight		kg	-	-
	Net Dimensions (WxHxD)		mm	-	-
	Shipping Dimensions (WxHxD)		mm	-	-
Function	Auto Restart		-	○	○
	Auto Swing		-	X	X
	Group/Individual Control		-	○	○
	External Contact Control		-	○	○
	Trouble Shooting by LED		-	○	○
Additional Accessories	Individual CONTROLLER	WIRED REMOTE	MWR-WE10N	MWR-WE10N(Optional)	MWR-WE10N(Optional)
		Simple Wired Remote Controller	MWR-SH00N	MWR-SH00N(Optional)	MWR-SH00N(Optional)
	Drain pump	Drain pump	- / model name	-	-
		Max. lifting Height / Displacement	mm / liter/h	-	-
	Air Filter		-	X	X



- *1) Mode
- HP : Heat Pump, HR : Heat Recovery
- *2) Nominal cooling capacities are based on;
- Indoor temperature : 27°C DB, 19°C WB
- Outdoor temperature : 35°C DB, 24°C WB, Equivalent refrigerant piping : 7.5m, Level differences : 0m
- *3) Nominal heating capacities are based on;
- Indoor temperature : 20°C DB, 15°C WB
- Outdoor temperature : 7°C DB, 6°C WB, Equivalent refrigerant piping : 7.5m, Level differences : 0m
- *4) Sound pressure was acquired in a dead room. Thus actual noise level may be different depending on the installation conditions.
- *5) Specifications may be subject to change without prior notice for product improvement.

Indoor Unit (cont.)

■ V-AHU(cont.)

Model			V-AHU			
			AM054JNZDCH/AA	AM060JNZDCH/AA	AM072JNZDCH/AA	
Power Supply		Φ, #, V, Hz	1,2,208-230,60	1,2,208-230,60	1,2,208-230,60	
Mode		-	HP,HR	HP,HR	HP,HR	
Performance	Capacity (Nominal)	Cooling	kW	-	-	
			Btu/h	54,000	60,000	72,000
		Heating	kW	-	-	-
			Btu/h	60,000	64,000	80,000
Power	Power Input (Nominal)	Cooling	W	341	380	620
		Heating	W	341	380	620
	Current Input (Nominal)	Cooling	A	2.42	2.74	4.20
		Heating	A	2.42	2.74	4.20
Fan	Motor	Type	-	ECM (AC TAP)	ECM (AC TAP)	ECM (AC TAP)
		Output x n	W	590 x 1	590 x 1	950 x 1
	Air Flow Rate	H/M/L (UL) @ Std ESP	CFM	1,603 / - / 1,031	1,768 / - / 1,564	2,110 / - / 1,880
			CMM	45.4 / - / 29.5	50.1 / - / 44.3	59.8 / - / 53.3
			l/s	-	-	-
	External Pressure	Min / Std / Max	in w.c.	0.1 / 0.4 / 1.0	0.1 / 0.4 / 1.0	0.1 / 0.4 / 1.0
mmAq			2.5 / 10 / 25.0	2.5 / 10 / 25.0	2.5 / 10 / 25.0	
Sound	Sound Pressure (Catalog)	High / Mid / Low	dB(A)	43 / - / -	46 / - / -	50 / - / -
	Sound Pressure	High / Mid / Low		48 / - / -	51 / - / -	55 / - / -
	Sound Power	Cooling		-	-	-
Refrigerant	Type	-	R-410A	R-410A	R-410A	
	Control Method	-	EEV INCLUDED	EEV INCLUDED	EEV INCLUDED	
Piping Connections	Liquid Pipe	Φ,mm	-	-	-	
		Φ, inch	3/8	3/8	3/8	
	Gas Pipe	Φ,mm	-	-	-	
		Φ, inch	3/4	3/4	3/4	
Drain Pipe	Φ, inch	FPT 3/4"	FPT 3/4"	FPT 3/4"		
Dimensions	Net Weight	lbs	169	180	182	
		kg	76.6	81.6	82.5	
	Shipping Weight	lbs	182	193	195	
		kg	82.5	87.5	88.4	
	Net Dimensions (WxHxD)	inch	24 1/2 x 58 3/4 x 21 3/4	24 1/2 x 58 3/4 x 21 3/4	24 1/2 x 58 3/4 x 21 3/4	
		mm	622 x 1,492 x 553	622 x 1,492 x 553	622 x 1,492 x 553	
Shipping Dimensions (WxHxD)	inch	26 1/2 x 62 1/2 x 27 1/4	26 1/2 x 62 1/2 x 27 1/4	26 1/2 x 62 1/2 x 27 1/4		
	mm	676 x 1,588 x 695	676 x 1,588 x 695	676 x 1,588 x 695		
Panel Size	Panel model	-	-	-	-	
	Panel Net Weight	kg	-	-	-	
	Shipping Weight	kg	-	-	-	
	Net Dimensions (WxHxD)	mm	-	-	-	
	Shipping Dimensions (WxHxD)	mm	-	-	-	
Function	Auto Restart	-	○	○	○	
	Auto Swing	-	X	X	X	
	Group/Individual Control	-	○	○	○	
	External Contact Control	-	○	○	○	
	Trouble Shooting by LED	-	○	○	○	
Additional Accessories	Individual CONTROLLER	WIRED REMOTE	MWR-WE10N	MWR-WE10N(Option)	MWR-WE10N(Option)	MWR-WE10N(Option)
		Simple Wired Remote Controller	MWR-SH00N	MWR-SH00N(Option)	MWR-SH00N(Option)	MWR-SH00N(Option)
	Drain pump	Drain pump	- / model name	-	-	-
		Max. lifting Height / Displacement	mm / liter/h	-	-	-
	Air Filter	-	-	X	X	X



*1) Mode

- HP : Heat Pump, HR : Heat Recovery

*2) Nominal cooling capacities are based on;

- Indoor temperature : 27°C DB, 19°C WB

- Outdoor temperature : 35°C DB, 24°C WB, Equivalent refrigerant piping : 7.5m, Level differences : 0m

*3) Nominal heating capacities are based on;

- Indoor temperature : 20°C DB, 15°C WB

- Outdoor temperature : 7°C DB, 6°C WB, Equivalent refrigerant piping : 7.5m, Level differences : 0m

*4) Sound pressure was acquired in a dead room. Thus actual noise level may be different depending on the installation conditions.

*5) Specifications may be subject to change without prior notice for product improvement.

Indoor Unit (cont.)

■ V-AHU(cont.)

Type			FLOOR STANDING	FLOOR STANDING		
Model			AM140JNPKH/TK	AM280JNPKH/TK		
Power Supply		Φ, #, V, Hz	1,2,208-230,50/60	1,2,220-240,50		
Mode		-	HP/HR	HP/HR		
Performance	Capacity (Nominal)	Cooling 2)	T1 (kW)	14.0	28.0	
			T1 (Btu/h)	47800	95500	
			T3 (kW)	12.5	24.5	
			T3 (Btu/h)	42700	83600	
		Heating 2)	T1 (kW)	16.0	31.5	
			T3 (kW)	-	-	
Power	Power Input (Nominal)	Cooling 1)	T1 (W)	190	955	
			T3 (W)	190	955	
		Heating 2)	T1 (W)	190	955	
			T3 (A)	0.9	4.73	
	Fan	Type	Type	-	Sirocco Fan	Sirocco Fan
		Motor	Output x n	W	154 x 1	700 x 1
Air Flow Rate		H/M/L (UL)	CMM	35.0/30.5/27.5	70.0/60.0/50.0	
			l/s	583.3/508.3/458.3	1,166.7/1,000.0/833.3	
Piping Connections	Liquid Pipe		Φ,mm	9.52	9.52	
			Φ, inch	3/8"	3/8"	
	Gas Pipe		Φ,mm	15.88	22.22	
			Φ, inch	5/8"	7/8"	
	Drain Pipe		Φ,mm	ID 18 HOSE	VP25 (OD 32,ID 25)	
	Field Wiring		Power Source Wire	mm2	2.5	2.5
		Transmission Cable	mm2	VCTF 0.75 ~ 1.5	VCTF 0.75 ~ 1.5	
Refrigerant	Type		-	R410A	R410A	
	Control Method		-	EEV INCLUDED	EEV INCLUDED	
Sound	Sound Pressure	High	dB(A)	58	61	
Dimensions	Net Weight		kg	48	115.0	
	Shipping Weight		kg	55	130.0	
	Net Dimensions (W×H×D)		mm	610 x 1850 x 400	1100 x 1800 x 485	
	Shipping Dimensions (W×H×D)		mm	705 x 1963 x 493	1177 x 1950 x 563	
Panel Size	Panel model		-	-	-	
	Panel Net Weight		kg	-	-	
	Shipping Weight		kg	-	-	
	Net Dimensions (W×H×D)		mm	-	-	
	Shipping Dimensions (W×H×D)		mm	-	-	
Additional Accessories	Drain pump	Drain pump	- / model name	-	-	
		Max. lifting Height / Displacement	mm / liter/h	-	-	
	Air Filter		-	-	-	
Functions	Auto Restart		-	O	O	
	Auto Swing		-	O	X	
	Group/Individual Control		-	O	O	
	External Contact Control		-	O	O	
	Trouble Shooting by LED		-	-	-	
Standard Accessories	Install Manual		-	O	O	
	User Manual		-	O	O	
	Pattern Sheet for Installation		-	X	X	
	Flexible Drain Hose		-	X	X	



*1) Mode

- HP : Heat Pump, HR : Heat Recovery

*2) Nominal cooling capacities are based on;

- Indoor temperature : 27°C DB, 19°C WB

- Outdoor temperature : 35°C DB, 24°C WB, Equivalent refrigerant piping : 7.5m, Level differences : 0m

*3) Nominal heating capacities are based on;

- Indoor temperature : 20°C DB, 15°C WB

- Outdoor temperature : 7°C DB, 6°C WB, Equivalent refrigerant piping : 7.5m, Level differences : 0m

*4) Sound pressure was acquired in a dead room. Thus actual noise level may be different depending on the installation conditions.

*5) Specifications may be subject to change without prior notice for product improvement.

Indoor Unit (cont.)

■ OAP DUCT

Model			AM140MNEPEH/EU	AM220MNEPEH/EU	AM280MNEPEH/EU	
Power Supply		ø/V/Hz	1,220~240,50	1,220~240,50	1,220~240,50	
Mode*1)			HP	HP	HP	
Performance	Capacity	Cooling*2)	kW	14.0	22.4	28.0
			Btu/h	47,800	76,400	95,500
	Heating*3)	kW	8.9	13.9	17.4	
		Btu/h	30,400	47,400	59,400	
Condensate (with High fan speed)		Liters/h	-	-	-	
Power	Input	W	300	450	600	
	Running Current	A	2.2	3.5	4.6	
Sound Level	Sound Pressure (High/Low)*4)	dB(A)	42	46	47	
Fan	Type		-	Sirocco Fan	Sirocco Fan	Sirocco Fan
	Motor	Model	-	ZWS-183-BA02	DL-17860SSBA	DL-17860SSBA
		Type	-	BLDC Nonfeedback	BLDC	BLDC
		Output	W	183	630	630
Airflow Rate	H/M/L	m3/min	18	28	35	
	External Pressure	Standard(Min.~Max)	mmH2O	20(15~25)	23(18~29)	25(20~30)
Refrigerant	Type		-	R410	R410	R410
	Control Method		-	EDM EEV 4.0C	EDM EEV 6.4C	EDM EEV 6.4C
Temperature Control			-	Micom&Thermistors	Micom&Thermistors	Micom&Thermistors
Safety Devices			-	Fuse : 3.15A	Fuse : 5A/15A	Fuse : 5A/15A
Piping Connections	Liquid (Flare)		ø, mm	9.52	9.52	9.52
	Gas (Flare)		ø, mm	15.88	19.05	22.22
	Drain		ø, mm	VP25 (OD 32,ID 25)	VP25 (OD 32,ID 25)	VP25 (OD 32,ID 25)
Weight	Net Weight		kg	49	81.5	81.5
	Shipping Weight		kg	56	90.5	90.5
Dimensions	Net Dimensions (W x H x D)		mm	1210*370*656	1360*460*910	1360*460*910
	Shipping Dimensions (W x H x D)		mm	1456*778*434	1612* 519 * 984	1612*519*984
Functions	Auto Restart		-	O	O	O
	Auto Swing		-	X	X	X
	Group/Individual Control		-	O	O	O
	External Contact Control		-	O	O	O
	Trouble Shooting by LED		-	X	X	X
Standard Accessories	Installation Manual		-	O	O	O
	Operation Manual		-	O	O	O
	Pattern Sheet for Installation		-	O	O	O
	Flexible Drain Hose		-	O	O	O
	Filter / Safety Grille		-	X	X	X
Optional Accessories	Wireless Remote Controller		-	MR-DH00	MR-DH00	MR-DH00
	Duct Receiver Kits	Receiver	-	MRK-A10	MRK-A10	MRK-A10
		Receiver Wire	-	MRW-10A	MRW-10A	MRW-10A
	Wired Remote Controller	Simplified	-	MWR-WE10N	MWR-WE10N	MWR-WE10N
		External Contact Interface Module	-	MIM-B14	MIM-B14	MIM-B14
	Drain Pump			MDP-M075SGU2D	MDP-G075SP	MDP-G075SP



*1) Mode

- HP : Heat Pump, HR : Heat Recovery

*2) Nominal cooling capacities are based on;

- Indoor temperature : 27°C DB, 19°C WB

- Outdoor temperature : 35°C DB, 24°C WB, Equivalent refrigerant piping : 7.5m, Level differences : 0m

*3) Nominal heating capacities are based on;

- Indoor temperature : 20°C DB, 15°C WB

- Outdoor temperature : 7°C DB, 6°C WB, Equivalent refrigerant piping : 7.5m, Level differences : 0m

*4) Sound pressure was acquired in a dead room. Thus actual noise level may be different depending on the installation conditions.

*5) Specifications may be subject to change without prior notice for product improvement.

Indoor Unit (cont.)

■ EHS TDM PLUS - SLIM DUCT

Model			AE022MNLDEH/EU	AE028MNLDEH/EU	AE036MNLDEH/EU	AE056MNLDEH/EU	
Power Supply		ø/V/Hz	1/220~240/50	1/220~240/50	1/220~240/50	1/220~240/50	
Mode*1)			HP / HR	HP / HR	HP / HR	HP / HR	
Performance	Capacity	Cooling*2)	kW	2.2	2.8	3.6	5.6
			Btu/h	7,500	9,500	12,200	19,100
	Heating*3)	kW	2.5	3.2	4.0	6.3	
		Btu/h	8,500	10,900	13,600	21,400	
Condensate (with High fan speed)		Liters/h	0.80	1.12	1.28	2.39	
Power	Input	W	55	60	65	95	
	Running Current	A	0.3	0.32	0.33	0.53	
Sound Level	Sound Pressure *4)	dB(A)	37	37	37	43	
Fan	Type	-	Sirocco Fan	Sirocco Fan	Sirocco Fan	Sirocco Fan	
	Motor	Model	-	YSK95-28-4-B	YSK95-28-4-B	YSK95-28-4-B	YSK110-50-45M
		Type	-	Non Feedback SSR	Non Feedback SSR	Non Feedback SSR	Non Feedback SSR
		Output	W	*5)	*5)	*5)	*5)
Airflow Rate	Cooling (High)	m ³ /min	4	7.5	7.5	12.0	
	Heating (High)	m ³ /min	8.2	9.0	9.0	15.0	
	External Static Pressure	Standard (Min.-Max)	mmH ₂ O	1 (0~3)	1 (0~3)	1 (0~3)	2 (0~4)
Refrigerant	Type	-	R410A	R410A	R410A	R410A	
	Control Method	-	EEV	EEV	EEV	EEV	
Temperature Control		-	Micom & Thermistors	Micom & Thermistors	Micom & Thermistors	Micom & Thermistors	
Safety Devices		-	Fuse	Fuse	Fuse	Fuse	
Piping Connections	Liquid (Flare)	ø, mm	6.35	6.35	6.35	6.35	
	Gas (Flare)	ø, mm	12.7	12.7	12.7	12.7	
	Drain	ø, mm	VP25 (OD 32, ID 25)	VP25 (OD 32, ID 25)	VP25 (OD 32, ID 25)	VP25 (OD 32, ID 25)	
Weight	Net Weight	kg	19.0	19.0	19.5	23.5	
	Shipping Weight	kg	23.0	23.0	23.5	28.0	
Dimensions	Net Dimensions (W x H x D)	mm	700x199x600	700x199x600	700x199x600	900x199x600	
	Shipping Dimensions (W x H x D)	mm	950x270x710	950x270x710	950x270x710	1150x280x710	
Functions	Auto Restart	-	O	O	O	O	
	Auto Swing	-	X	X	X	X	
	Group/Individual Control	-	O	O	O	O	
	External Contact Control	-	O	O	O	O	
	Trouble Shooting by LED	-	X	X	X	X	
Standard Accessories	Installation Manual	-	O	O	O	O	
	Operation Manual	-	O	O	O	O	
	Pattern Sheet for Installation	-	X	X	X	X	
	Flexible Drain Hose	-	O	O	O	O	
	Filter / Safety Grille	-	Filter (Washable)	Filter (Washable)	Filter (Washable)	Filter (Washable)	
	Drain Pump (Pumping speed, lift)	-	MR-BH01	MR-BH01	MR-BH01	MR-BH01	
Optional Accessories	Wireless Remote Controller	-	MR-DH00	MR-DH00	MR-DH00	MR-DH00	
	Duct Receiver Kits	Receiver	-	MRK-A10	MRK-A10	MRK-A10	MRK-A10
		Receiver Wire	-	MRW-10A	MRW-10A	MRW-10A	MRW-10A
	Wired Remote Controller	Simplified	-	MWR-WE10N	MWR-WE10N	MWR-WE10N	MWR-WE10N
	External Contact Interface Module			MIM-B14	MIM-B14	MIM-B14	MIM-B14
Drain Pump			MDP-E075SEE3D	MDP-E075SEE3D	MDP-E075SEE3D	MDP-E075SEE3D	



*1) Mode

- HP : Heat Pump, HR : Heat Recovery

*2) Nominal cooling capacities are based on;

- Indoor temperature : 27°C DB, 19°C WB

- Outdoor temperature : 35°C DB, 24°C WB, Equivalent refrigerant piping : 7.5m, Level differences : 0m

*3) Nominal heating capacities are based on;

- Indoor temperature : 20°C DB, 15°C WB

- Outdoor temperature : 7°C DB, 6°C WB, Equivalent refrigerant piping : 7.5m, Level differences : 0m

*4) Sound pressure was acquired in a dead room. Thus actual noise level may be different depending on the installation conditions.

*5) Specifications may be subject to change without prior notice for product improvement.

Indoor Unit (cont.)

■ EHS TDM PLUS - GLOBAL DUCT

Div.			AE071MNMPEH/EU	AE090MNMPEH/EU
Model		Europe	AM071HNMPKH/EU	AM090HNMPKH/EU
Basic Model		Europe	AC071HBMDKH/EU(CAC)	AC090HBMDKH/EU(CAC)
Power Supply		φ,V,Hz	1,220~240,50	1,220~240,50
Mode 1)		-	HP / HR	HP / HR
Performance	Capacity	Cooling 2)	kW 92% ↑	7.1
		Heating 3)	kW 92% ↑	8.0
Power	Input Consumption (Cooling/Heating)		W 110% ↓	120/120
	Running Current (Cooling/Heating)		A 110% ↓	1.0/1.0
Indoor unit refrigerant adding amount		Kg/EA	0.22	0.31
Noise Level	开发spec		dB(A) ↓	47/47
	Catalogue 标示值		dB(A) ↓	37/33/29
Fan	Type		-	Sirocco Fan (Φ180*2ea)
	Motor	Model	-	SIC-70CW-F1153-2 (DB31-00639A)
		Type	-	BLDC feedback
		Output	W	153
Fan Speed	Fan(H/M/L)		Standard	rpm±20
	Cooling (H/M/L)参考		Standard	1020/940/860
	Heating (H/M/L)参考		Standard	1020/940/860
Airflow Rate	Fan(H/M/L)		m ³ /min	22.00/19.00/16.00
	Cooling (High)参考		-	-
	Heating (High)参考		-	-
Refrigerant	Type		-	R410a
	Control Method		-	EDM EEV3.2c Sanhua
Temperature Control		-	Micom&Thermistors	Micom&Thermistors
Safety Devices		-	Fuse:5A	Fuse:5A
External Static Pressure	Standard (Min.~Max)		mmH2O	0-3-15
OPTION CODE	Standard Static Pressure	0 ≤ SP ≤ 2.5	Product	010054-1C548D-204747-331201
			Install	020010-100000-200000-300000
			Cycle	030000-100000-200000-300000
			Install 2	050000-100000-200000-300000
	All Static Pressure	0 ≤ SP ≤ 3 4 < SP ≤ 8 3 < SP ≤ 6 6 < SP ≤ 9 8 < SP ≤ 12 9 < SP ≤ 12 12 < SP ≤ 15	Product	010054-1C548D-204747-331201
			Product	-
			Product	010054-1C55E1-204747-331201
			Product	010054-1C5935-204747-331201
			Product	-
			Product	010054-1C5989-204747-331201
Product	010054-1C59DF-204747-331201	010054-1C5A61-205A5A-331212		
Piping Connections	Liquid (Flare)	Φ,mm	9.52	
		Φ,inch	3/8	
	Gas (Flare)	Φ,mm	15.88	
		Φ,inch	5/8	
	Drain	Φ,mm	VP25 (OD 32, ID 25)	
		Φ,inch	-	
Weight	Net Weight		kg	25.5
	Shipping Weight		kg	30
Dimensions	Net Dimensions (W×H×D)		mm	850*250*700
			inch	-
	Shipping Dimensions (W×H×D)		mm	1064*320*784
			inch	-
HEX	Dimension		-	2R*39S*TP8.4*675mm
	Tube hair fin		-	H2.1(9hole)FMC 9.5mm,
	Fin		-	Louver, FP1.3
	Pass		-	4*4 Pass
Micom		-	DB91-01629A Version:140708 Checksum:E754	DB91-01629A Version:140708 Checksum:E754
LOADING QUANTITY	20ft		EA	98
	40ft		EA	210
	40ft JUMBO		EA	240
Panel Size	Model		Europe	-
	Net Weight		kg	-
	Shipping Weight		kg	-
	Net Dimensions (W×H×D)		mm	-
	Shipping Dimensions (W×H×D)		mm	-
Optional Accessories	Model		Europe	MDP-G075SQ (Internal installation) MDP-G075SP (External installation)
	Drain pump		In/Option	Option
	Max. lifting Height / Displacement		mm / liter/h	750mm, 24l/h



- *1) Mode
- HP : Heat Pump, HR : Heat Recovery
- *2) Nominal cooling capacities are based on;
- Indoor temperature : 27 °C DB, 19 °C WB - Outdoor temperature : 35 °C DB, 24 °C WB
- *3) Nominal heating capacities are based on;
- Indoor temperature : 20 °C DB, 15 °C WB - Outdoor temperature : 7 °C DB, 6 °C WB
- *4) Sound pressure was acquired in a dead room. Thus actual noise level may be different depending on the installation conditions.
- *5) Specifications may be subject to change without prior notice for product improvement.

Indoor Unit (cont.)

■ EHS TDM PLUS -Console type

Model			AE022MNJDEH/EU	AE028MNJDEH/EU	AE036MNJDEH/EU	AE056MNJDEH/EU	
Power Supply		ø/V/Hz	1/220~240/50	1/220~240/50	1/220~240/50	1/220~240/50	
Mode*1)			HP / HR	HP / HR	HP / HR	HP / HR	
Performance	Capacity	Cooling*2)	kW	2.2	2.8	3.6	5.6
			Btu/h	7,500	9,600	12,300	19,100
		Heating*3)	kW	2.5	3.2	4.0	6.3
			Btu/h	8,500	11,000	13,600	21,400
	Condensate (with High fan speed)		Liters/h	-	0.96	1.75	-
Power	Input	W	16 ^{*5)}	30 ^{*5)}	35 ^{*5)}	62 ^{*5)}	
	Running Current	A	0.13 ^{*5)}	0.25 ^{*5)}	0.29 ^{*5)}	0.49 ^{*5)}	
Sound Level	Sound Pressure (Cooling / Heating)*4)		dB(A)	38/39	41/43	42/44	49/51
Fan	Type		-	Turbo Fan	Turbo Fan	Turbo Fan	Turbo Fan
	Motor	Model	-	SIC-55CV-F137-2	SIC-55CV-F137-2	SIC-55CV-F137-2	SIC-55CV-F137-2
		Type	-	BLDC	BLDC	BLDC	BLDC
		Output	W	37	37.0	37.0	37.0
Airflow Rate	Cooling (High)	m ³ /min	5.8	7.76 ^{*5)}	8.67 ^{*5)}	13.0 ^{*5)}	
	Heating (High)	m ³ /min	6.3	7.22 ^{*5)}	8.89 ^{*5)}	13.5 ^{*5)}	
Refrigerant	Type	-	R410A	R410A	R410A	R410A	
	Control Method	-	EEV	EEV	EEV	EEV	
Temperature Control		-	Micom&Thermistors	Micom&Thermistors	Micom&Thermistors	Micom&Thermistors	
Safety Devices		-	Fuse	Fuse	Fuse	Fuse	
Piping Connections	Liquid (Flare)	ø, mm	6.35	6.35	6.35	6.35	
	Gas (Flare)	ø, mm	12.7	12.7	12.7	12.7	
	Drain	ø, mm	ID 18 hose	ID 18 hose	ID 18 hose	ID 18 hose	
Weight	Net Weight	kg	16.0	16.0	16.0	16.0	
	Shipping Weight	kg	21.0	21.0	21.0	21.0	
Dimensions	Net Dimensions (W x H x D)	mm	720x620x199	720x620x199	720x620x199	720x620x199	
	Shipping Dimensions (W x H x D)	mm	810x710x295	810x710x295	810x710x295	810x710x295	
Functions	Auto Restart	-	O	O	O	O	
	Auto Swing	-	O	O	O	O	
	Group/Individual Control	-	O	O	O	O	
	External Contact Control	-	O	O	O	O	
	Trouble Shooting by LED	-	O	O	O	O	
Standard Accessories	Installation Manual	-	O	O	O	O	
	Operation Manual	-	O	O	O	O	
	Pattern Sheet for Installation	-	X	X	X	X	
	Flexible Drain Hose	-	O	O	O	O	
	Filter / Safety Grille	-	Filter (Washable)	Filter (Washable)	Filter (Washable)	Filter (Washable)	
	Wireless Remote Controller	-	ARH-1378 (DB93-07547B)	ARH-1378 (DB93-07547B)	ARH-1378 (DB93-07547B)	ARH-1378 (DB93-07547B)	
Optional Accessories	Wireless Remote Controller	-	MR-DH00	MR-DH00	MR-DH00	MR-DH00	
	Wired Remote Controller	Simplified	-	MWR-WE10N	MWR-WE10N	MWR-WE10N	
	External Contact Interface Module	-	MIM-B14	MIM-B14	MIM-B14	MIM-B14	



*1) Mode

- HP : Heat Pump, HR : Heat Recovery

*2) Nominal cooling capacities are based on;

- Indoor temperature : 27°C DB, 19°C WB

- Outdoor temperature : 35°C DB, 24°C WB, Equivalent refrigerant piping : 7.5m, Level differences : 0m

*3) Nominal heating capacities are based on;

- Indoor temperature : 20°C DB, 15°C WB

- Outdoor temperature : 7°C DB, 6°C WB, Equivalent refrigerant piping : 7.5m, Level differences : 0m

*4) Sound pressure was acquired in a dead room. Thus actual noise level may be different depending on the installation conditions.

*5) Specifications may be subject to change without prior notice for product improvement.

Indoor Unit (cont.)

■ EHS TDM PLUS -Wall Monuted type

Model			AE022MNADEH/EU	AE028MNADEH/EU	AE036MNADEH/EU	
Power Supply			Φ,#,V,Hz	1,220~240,50	1,220~240,50	1,220~240,50
Mode *1)				HP / HR	HP / HR	HP / HR
Performance	Capacity	Cooling*2)	kW	2.2	2.8	3.6
			Btu/h	7,502	9,548	12,276
		Heating*3)	kW	2.5	3.2	4.0
			Btu/h	8,525	10,912	13,640
Power	Power Input	Cooling	W	15 *5)	16 *5)	20 *5)
		Heating	W	18 *5)	24 *5)	28 *5)
	Current Input	Cooling	A	0.13 *5)	0.13 *5)	0.15 *5)
		Heating	A	0.15 *5)	0.19 *5)	0.20 *5)
Fan	Motor	Type	-	Crossflow Fan Φ83*L552	Crossflow Fan Φ83*L552	Crossflow Fan Φ98*L633
		Output	W	27	27	27
		Number of unit		1	1	1
	Airflow Rate	Cooling(High)	m ³ /min	4.50 *5)	5.70 *5)	7.10 *5)
		Heating(High)	m ³ /min	6.00 *5)	8.50 *5)	10.00 *5)
Piping Connections	Liquid Pipe		Φ,mm	6.35	6.35	6.35
			Φ,inch	1/4"	1/4"	1/4"
	Gas Pipe		Φ,mm	12.70	12.70	12.70
			Φ,inch	1/2"	1/2"	1/2"
Drain Pipe		Φ,mm	ID 18 HOSE	ID 18 HOSE	ID 18 HOSE	
Field Wiring	Power Source Wire	Below 20m/ over 20m"	mm2	1.5 ~ 2.5	1.5 ~ 2.5	1.5 ~ 2.5
	Transmission Cable		mm2	0.75 ~ 1.50	0.75 ~ 1.50	0.75 ~ 1.50
Refrigerant	Type		-	R410A	R410A	R410A
	Control Method		-	EEV INCLUDED	EEV INCLUDED	EEV INCLUDED
Sound	Sound Pressure*4)	High/Mid/Low	dBa	33/29/25	36/31/26	37/33/29
Dimensions	Net Weight		kg	8.1	8.2	9.8
	Shipping Weight		kg	9.7	9.8	11.7
	Net Dimensions (W x H x D)		mm	750*250*242	750*250*242	826*275*260
	Shipping Dimensions (W x H x D)		mm	800*302*298	800*302*298	886*335*317
Functions	Auto Restart		-	O	O	O
	Auto Swing		-	O	O	O
	Group/Individual Control		-	O	O	O
	External Contact Control		-	O	O	O
	Trouble Shooting by LED		-	O	O	O
Standard Accessories	Installation Manual		-	O	O	O
	Operation Manual		-	O	O	O
	Pattern Sheet for Installation		-	X	X	X
	Flexible Drain Hose		-	O	O	O
	Filter / Safety Grille		-	Filter (Washable)	Filter (Washable)	Filter (Washable)
	Wireless Remote Controller		-	MR-EH00	MR-EH00	MR-EH00
Optional Accessories	Wireless Remote Controller		-	-	-	-
	Wired Remote Controller	Simplified	-	MWR-WE10N	MWR-WE10N	MWR-WE10N
	External Contact Interface Module		-	MIM-B14	MIM-B14	MIM-B14



*1) Mode

- HP : Heat Pump, HR : Heat Recovery

*2) Nominal cooling capacities are based on;

- Indoor temperature : 27°C DB, 19°C WB

- Outdoor temperature : 35°C DB, 24°C WB, Equivalent refrigerant piping : 7.5m, Level differences : 0m

*3) Nominal heating capacities are based on;

- Indoor temperature : 20°C DB, 15°C WB

- Outdoor temperature : 7°C DB, 6°C WB, Equivalent refrigerant piping : 7.5m, Level differences : 0m

*4) Sound pressure was acquired in a dead room. Thus actual noise level may be different depending on the installation conditions.

*5) Specifications may be subject to change without prior notice for product improvement.

Indoor Unit (cont.)

■ EHS TDM PLUS -Wall Monuted type(cont.)

Model				AE056MNADEH/EU	AE071MNADEH/EU
Power Supply			Φ,#,V,Hz	1,220~240,50	1,220~240,50
Mode *1)				HP / HR	HP / HR
Performance	Capacity	Cooling*2)	kW	5.6	7.1
			Btu/h	19,096	24,211
		Heating*3)	kW	6.3	8.0
			Btu/h	21,483	27,280
Power	Power Input	Cooling	W	27	41
		Heating	W	37	53
	Current Input	Cooling	A	0.21	0.31
		Heating	A	0.29	0.41
Fan	Motor	Type	-	Crossflow Fan Φ106*L830	Crossflow Fan Φ106*L830
		Output	W	27	27
		Number of unit		1	1
	Airflow Rate	Cooling(High)	m ³ /mim	11.80	14.80
		Heating(High)	m ³ /mim	15.00	18.00
Piping Connections	Liquid Pipe		Φ,mm	6.35	9.52
			Φ,inch	1/4"	3/8"
	Gas Pipe		Φ,mm	12.70	15.88
			Φ,inch	1/2"	5/8"
	Drain Pipe		Φ,mm	ID 18 HOSE	ID 18 HOSE
Field Wiring	Power Source Wire	Below 20m/ over 20m	mm2	1.5 ~ 2.5	1.5 ~ 2.5
	Transmission Cable		mm2	0.75 ~ 1.50	0.75 ~ 1.50
Refrigerant	Type		-	R410A	R410A
	Control Method		-	EEV INCLUDED	EEV INCLUDED
Sound	Sound Pressure*4)	High/Mid/Low	dBa	39/36/33	44/41/36
Dimensions	Net Weight		kg	14.6	14.6
	Shipping Weight		kg	17.0	17.0
	Net Dimensions (W x H x D)		mm	1063*317*294	1063*317*294
	Shipping Dimensions (W x H x D)		mm	1123*384*354	1123*384*354
Functions	Auto Restart		-	O	O
	Auto Swing		-	O	O
	Group/Individual Control		-	O	O
	External Contact Control		-	O	O
	Trouble Shooting by LED		-	O	O
Standard Accessories	Installation Manual		-	O	O
	Operation Manual		-	O	O
	Pattern Sheet for Installation		-	X	X
	Flexible Drain Hose		-	O	O
	Filter / Safety Grille		-	Filter (Washable)	Filter (Washable)
Optional Accessories	Wireless Remote Controller		-	MR-EH00	MR-EH00
	Wired Remote Controller	Simplified	-	MWR-WE10N	MWR-WE10N
		External Contact Interface Module		-	MIM-B14



*1) Mode

- HP : Heat Pump, HR : Heat Recovery

*2) Nominal cooling capacities are based on;

- Indoor temperature : 27°C DB, 19°C WB

- Outdoor temperature : 35°C DB, 24°C WB, Equivalent refrigerant piping : 7.5m, Level differences : 0m

*3) Nominal heating capacities are based on;

- Indoor temperature : 20°C DB, 15°C WB





















- Outdoor temperature : 7°C DB, 6°C WB, Equivalent refrigerant piping : 7.5m, Level differences : 0m

*4) Sound pressure was acquired in a dead room. Thus actual noise level may be different depending on the installation conditions.









*5) Specifications may be subject to change without prior notice for product improvement.

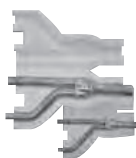
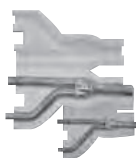
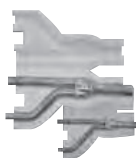
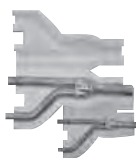
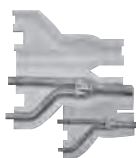



















2-2 Accessory and Option Specifications

2-2-1 Accessories

Classification		Product	Model	Image	Application model
Integrated management system	Controller	DMS 2	MIM-D00AN		DVM Series, FJM, CAC, ERV Hydro unit, Hydro unit HT
		S-NET 3	MST-P3P		DVM Series, FJM, CAC, ERV Hydro unit, Hydro unit HT
	Interface Module	SIM MIM-	MIM-B12N		DVM Series, FJM
Centralized control system	Controller	Centralized controller	MCM-A202DN		DVM Series, FJM, CAC, ERV Hydro unit, Hydro unit HT
		Operation mode selection switch	MCM-C200		DVM Series (Except HR models)
		New touch CONTROLLER	MCM-A300N		
Individual control system ControllerController	Controller	Wireless remote controller	MR-DH00		Cassette, Duct (Receiver needed)
			MR-EH00		Cassette, Duct (Receiver needed)
			MR-KH00		360 cassette
			AR-EH03E		All model
		Wired remote controller (Multi function)	MWR-WE10N		Cassette, Wall-mounted, Ceiling, Duct, Console, ERV
			MWR-WE13N		All model
		Wired remote controller (Multi function)	MWR-WW00N		Hydro unit / Hydro unit HT
		Wireless signal receiver	MRK-A10		Duct (For wireless remote controller)
		Remote sensor	MRW-TA		Cassette, Wall-mounted, Ceiling, Duct, Console
		ERV CO2 Sensor	MOS-C1		ERV, ERV PLUS
Building management system	Lonworks interface module	MIM-B18N		DVM Series, FJM, CAC, ERV	
	DMS-Bnet (BACnet)	MIM-B17N		DVM Series, FJM Hydro unit, Hydro unit HT	
Guest room management system	External contact interface module	MIM-B14		Mini DVM(R-410A), DVM PLUS III, FJM	
Power distribution			MIM-B16N		DVM Series, FJM
Converter			MIM-C02N		DVM Series, FJM, CAC
			MIM-N00		
Multi Tenant Function Controller			MCM-C210		







※ DVM Series : DVM mini, DVM PLUS III, DVM PLUS III HR, DVM PLUS IV, DVM PLUS IV HR

Classification	Feature	Model	Description	Relevant unit	Remark	
Y-JOINT		MXJ-YA1509M	15.0 kW and below	DVMS HP / HR	Requisite	
		MXJ-YA2512M	Over 15.0 ~ 40.6 kW and below			
		MXJ-YA2812M	Over 40.6 ~ 46.4 kW and below			
		MXJ-YA2815M	Over 46.4 ~ 69.6 kW and below			
		MXJ-YA3419M	Over 69.6 ~ 98.6 kW and below			
		MXJ-YA4119M	Over 98.6 ~ 139.2 kW and below			
		MXJ-YA4422M	Over 139.2 kW			
Y-joint(High Pressure Gas) for DVM S HR		MXJ-YA1500M	23.2 kW and below	DVMS HR	Requisite	
		MXJ-YA2500M	Over 23.2 ~ 69.6 kW and below			
		MXJ-YA3100M	Over 69.6 ~ 139.2 kW and below			
		MXJ-YA3800M	Over 139.2 kW			
Outdoor joint (Outdoor Connection)		MXJ-TA3819M	Below 48 HP	DVMS HP / HR	Requisite	
		MXJ-TA4422M	Over 50 HP			
Outdoor joint (High Pressure Gas) for DVM S HR		MXJ-TA3100M	Below 48 HP	DVMS HR	Requisite	
		MXJ-TA3800M	Over 50 HP			
Header joint		MXJ-HA2512M	Below 46.4 kW	DVMS HP / HR	Requisite	
		MXJ-HA3115M	Below 69.6 kW			
		MXJ-HA3819M	Over 69.7 kW			
EEV kits		MXD-E13K116A	Below 3.6 kW (1 Room) + 5.6 kW ~9.0 kW (1Room)	Wall-mounted & Ceiling indoor unit (For 2 indoor units)	Option	
		MXD-E13K200A	Below 3.6 kW (2 Rooms)			
		MXD-E16K200A	5.6 kW~9.0 kW (2Rooms)			
		MXD-E22K200A	Over 9.0 kW (2Rooms)			
		MXD-E13K216A	Below 3.6 kW (2 Rooms) + 5.6 kW ~9.0 kW (1Room)	Wall-mounted & Ceiling indoor unit (For 3 indoor units)		
		MXD-E13K300A	Below 3.6 kW (3 Rooms)			
		MXD-E16K213A	Below 3.6 kW (1 Room) + 5.6 kW ~9.0 kW (2Rooms)			
		MXD-E16K300A	5.6 kW ~ 9.0 kW (3Rooms)			
		MEV-E13SA	Below 3.6 kW (1 Room)	Wall-mounted & Ceiling indoor unit (for single unit)		
		MEV-E16SA	5.6 kW ~ 9.0 kW (1Room)			
Drain Pump		MDP-N047SNC1D	HSP Duct 22.0/28.0kW	-	Option	
			MDP-M075SGU1D	MSP Duct (9.0/11.2) kW		-
			MDP-M075SGU2D	MSP Duct (12.8/14.0) kW HSP Duct (11.2/12.8/14.0) kW		
	MDP-M075SGU3D		MSP Duct (5.6/7.1) kW			
		MDP-E075SEE3D	SlimDuct (1.7~14.0) kW	-		
		MDP-G075SQ (Internal installation)	Global Duct GD-S Big Duct	-		
		MDP-G075SP (External installation)		-		

Classification	Feature	Model	Description	Relevant unit	Remark
MCU		MCU-S4NEE1N	Below 4 indoor units	DVMS HR	Requisite (HR Only)
		MCU-S6NEE1N	Below 2 large capacity ducts		
		MCU-S4NEE2N	Below 6 indoor units		
AHU KIT		MXD-K025AN	7.0kW~8.75kW	-	Option
		MXD-K050AN	14.0kW~17.5kW		
		MXD-K075AN	21.0kW~26.25kW		
		MXD-K100AN	28.0kW~35.0kW		
PDM KIT		MXD-A38K2A	8~12HP	DVMS	Option
		MXD-A58K2A	14~22HP		
Humidifier		MVO-VA050100	500CMH	-	Option
		MVO-VA100100	1000CMH		
S-Plasmalon KIT		MSD-CAN1	4way Cassette	-	Option
		MSD-EAN1	ERV-Plus		
Motion detect sensor		MCR-SMA	4way Cassette	-	Option
Front panel		PC1MWSKAN	Slim 1way cassette	-	Requisite
		PC1NWSMAN	Slim 1way cassette		
		PC1BWSMAN	Slim 1way cassette		
		PC1MWFMAN	Wind-free 1way cassette		
		PC1NWFMAN			
		PC1BWFMAN			
		PC1NUSMAN	Slim 1way cassette		
		PC1NUPMAN	Slim 1way cassette		
		PC2NUSMEN	2 way cassette		
		PC4SUSMAN	Global 4Way Cassette(600x600)		
		PC4SYSTEMEN	Global 4Way Cassette(600x600)		
		PC4SUSE1N	4Way Cassette(600x600) (only AM***HNNDEH/TL)		
		PC4NUSKAN	4 way cassette		
		PC4NUSKEN	4 way cassette		
		PC4NBSKAN	4 way cassette		
		PC4NUDMAN	360 cassette		
	PC4NUNMAN	360 cassette			

3. Disassembly and Reassembly



■ Necessary Tools

Item	Remark
+Screw Driver	
Monkey Spanner	
-Screw Driver	
Nipper	
Electric Motion Driver	
L-Wrench	

3-1 Indoor Unit

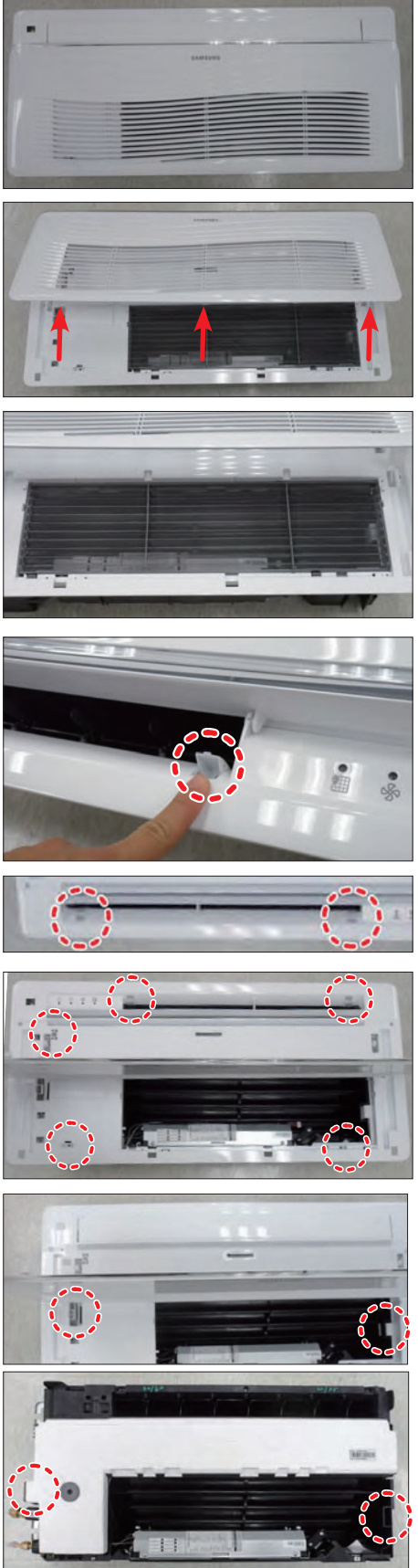
■ AM017/022HN1DEH/EU

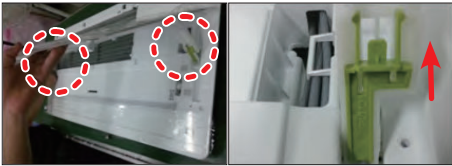
No	Parts	Procedure	Remark
1	PANEL And FILTER (Continues)	<p>1) Open the GRILLE as shown in the figure.</p> <p>2) Remove the FILTER from the PANEL.</p> <p>3) Remove the 2 COVER SCREW as shown in the figure.</p> <p>4) Remove the 5 screws fixed in PANEL and then remove the PANEL. (Use +Screw Driver)</p> <p>5) Press the left and right PANEL HOOK and then separate the PANEL from the indoor unit.</p>	

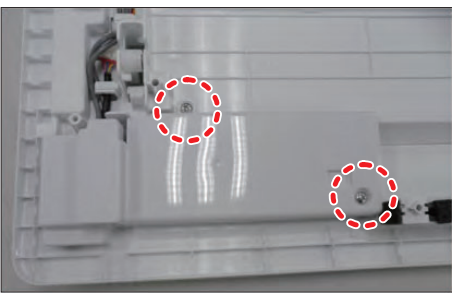
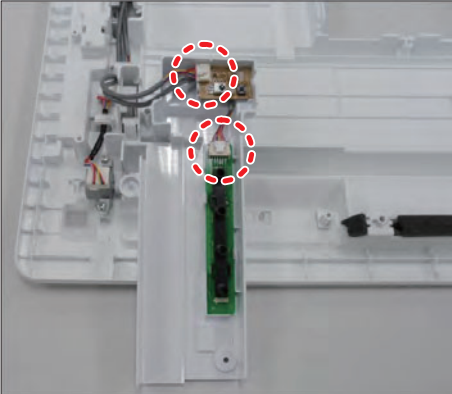
No	Parts	Procedure	Remark
	<p>PANEL And FILTER (Continues)</p>	<p>6) Open the GRILLE and then raise the LINK LEVER SWITCH(yellowish green) of both sides in the direction of arrow and separate the LINK LEVER.</p> <p>7) Remove the 2 screws fixed in COVER DISPLAY and then remove the COVER DISPLAY.(Use +Screw Driver)</p> <p>8) Disconnect the connector. (Remote control receiver PBA and Display PBA)</p>	    

■ AM017/022NN1PEH/EU



Wind-free PANEL

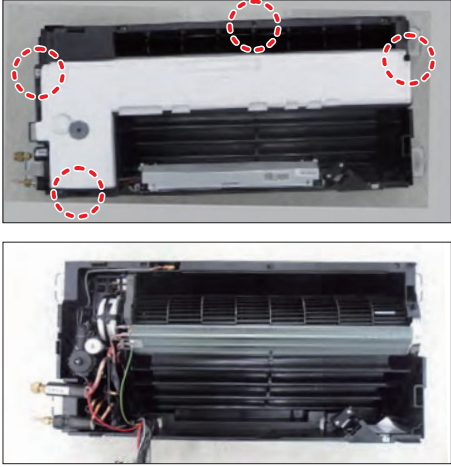
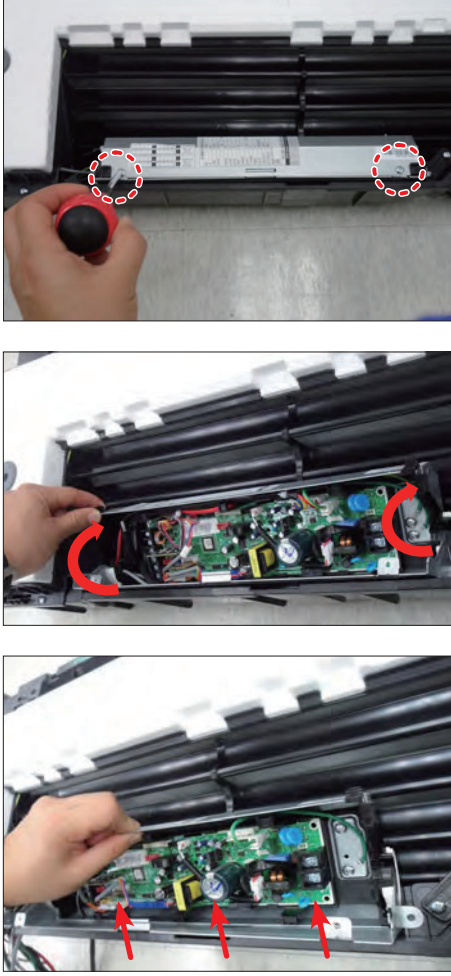

No	Parts	Procedure	Remark
1	<p>PANEL And FILTER</p> <p>WIND FREE TYPE (PC1MWFMAN)</p>	<p>1) Open the GRILLE as shown in the figure. - 3point</p> <p>2) Remove the FILTER from the PANEL.</p> <p>3) Remove the 3 COVER SCREW as shown in the figure.</p> <p>4) Remove the 5 screws fixed in PANEL and then remove the PANEL. (Use +Screw Driver)</p> <p>5) Press the left and right PANEL HOOK and then separate the PANEL from the indoor unit.</p>	

No	Parts	Procedure	Remark
	<p>PANEL And FILTER (Continues)</p>	<p>6) Open the GRILLE and then separate the CLIP WIRE.</p> <p>7) Remove the screws fixed in COVER DISPLAY, COVER MOTOR RIGHT and then remove the COVER DISPLAY, COVER MOTOR RIGHT . (Use +Screw Driver)</p> <p>8) Disconnect the connector. (Remote control receiver PBA and Display PBA)</p>	

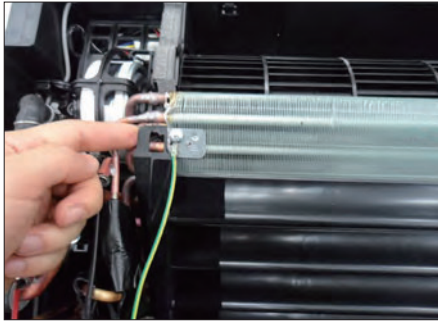
No	Parts	Procedure	Remark
	<p>PANEL And FILTER (Continues)</p>	<p>9) Remove the 2 screws fixed in STEP MOTOR and then remove the MOTOR. (Use +Screw Driver)</p> <p>10) Remove the 2 HINGE and then separate the BLADE H.</p> <p>11) Separate the SENSOR HUMIDITY.</p> <p>12) Remove the 3 screws fixed in GUIDE AIR and then remove the GUIDE AIR. (Use +Screw Driver)</p>	     



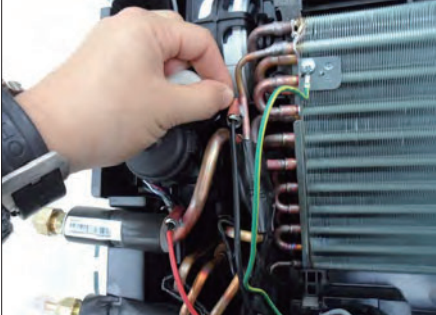

No	Parts	Procedure	Remark
2	DRAIN PAN	<p>1) Remove the 4 screws fixed in DRAIN PAN. (Use +Screw Driver)</p> <p>2) Pull the DRAIN PAN from the indoor unit and remove.</p> <p>⚠ By Hair-Pin, be careful not to damage and weldment is flowed in.</p> <p>⚠ When you remove the DRAIN PAN, be careful not to fall off the remaining water.</p>	
3	Electrical equipment	<p>1) Remove the 2 screws fixed in Electrical equipment and then remove the cover. (Use +Screw Driver)</p> <p>2) Push up as shown in the figure with hand and then disconnect the 8 connectors from the indoor unit PCB.</p> <p>3) Lift up the control part and remove.</p>	

No	Parts	Procedure	Remark
			 <p data-bbox="1018 533 1370 562">State after separating Electrical equipment.</p>
4	DRAIN SUB	1) Push the HOOK of DRAIN SUB and remove.	 

No	Parts	Procedure	Remark
5	Heat Exchanger	<ol style="list-style-type: none"> <li data-bbox="485 315 916 371">1) Remove the 1 screw fixed in Heat Exchanger. (Use +Screw Driver) <li data-bbox="485 674 916 730">2) Separate the SENSOR of indoor unit from the Heat Exchanger. <li data-bbox="485 1010 916 1066">3) Separate the Heat Exchanger from the indoor unit. 	  

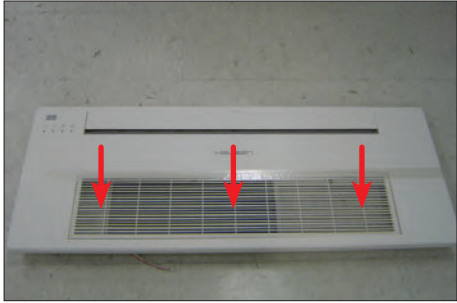
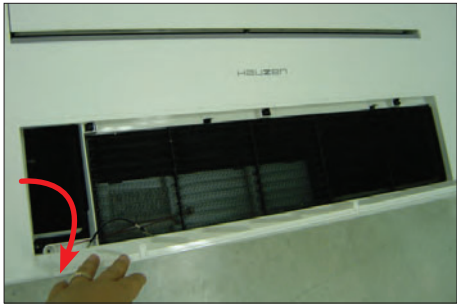
No	Parts	Procedure	Remark
6	CORSS FAN	<ol style="list-style-type: none"> 1) Remove the 2 screws fixed in COVER FAN MOTOR. (Use +Screw Driver) 2) Separate the COVER FAN MOTOR from the indoor unit. 3) Disconnect the CROSS FAN connector. 4) Separate the FAN MOTOR and CROSS FAN from the indoor unit. 5) Remove the screw fixed in CROSS FAN and then remove the FAN MOTOR and CROSS FAN. (Use +Screw Driver) 	     

■ Slim 1 way cassette type

No	Parts	Procedure	Remark
1	Panel & Filter (A type)	<ol style="list-style-type: none"> 1) Press the Push Button on the Grill and open it 2) Separate 1 clip from the Panel and tilt the Grill to 45° and separate the Grille from the Panel. 3) Separate the Filter from the Panel. 4) Separate 3 cover screws from it. 5) Unscrew 6 fixed screws and separate them from the Indoor Unit. (Use +Screw Driver) 	    

No	Parts	Procedure	Remark
		<p>6) Press the left and right Hooks to separate the Panel from the Indoor Unit.</p>	

■ AM022/028/036NN1DEH/EU

Wind-free PANEL

No	Parts	Procedure	Remark
1	PANEL And FILTER WIND FREE TYPE (PC1NWFMAN)	<ol style="list-style-type: none"> 1) Open the GRILLE as shown in the figure. - 3point 2) Remove the FILTER from the PANEL. 3) Remove the 3 COVER SCREW as shown in the figure. 4) Remove the 6 screws fixed in PANEL and then remove the PANEL. (Use +Screw Driver) 5) Press the left and right PANEL HOOK and then separate the PANEL from the indoor unit. 	

No	Parts	Procedure	Remark
	<p>PANEL And FILTER (Continues)</p>	<p>6) Open the GRILLE and then separate the CLIP WIRE.</p> <p>7) Remove the screws fixed in COVER DISPLAY, COVER MOTOR RIGHT and then remove the COVER DISPLAY, COVER MOTOR RIGHT . (Use +Screw Driver)</p> <p>8) Disconnect the connector. (Remote control receiver PBA and Display PBA)</p>	







No	Parts	Procedure	Remark
	<p>PANEL And FILTER (Continues)</p>	<p>9) Remove the 4 screws fixed in STEP MOTOR and then remove the MOTOR. (Use +Screw Driver)</p> <p>10) Remove the 4 HINGE and then separate the BLADE H.</p> <p>11) Separate the SENSOR HUMIDITY.</p> <p>12) Remove the 4 screws fixed in GUIDE AIR and then remove the GUIDE AIR. (Use +Screw Driver)</p> <p>13) Separate the PLATE</p>	     

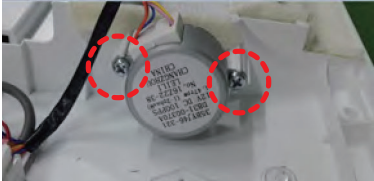

■ AM056/071NN1DEH/EU

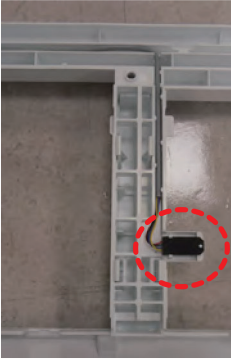
Wind-free PANEL

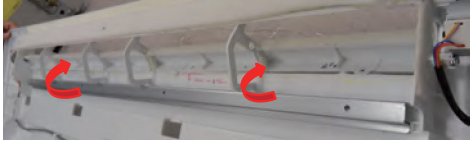
No	Parts	Procedure	Remark
1	PANEL And FILTER WIND FREE TYPE (PC1BWFMAN)	<ol style="list-style-type: none"> 1) Open the GRILLE as shown in the figure. - 4point 2) Remove the FILTER from the PANEL. 3) Remove the 3 COVER SCREW as shown in the figure. 4) Remove the 7 screws fixed in PANEL and then remove the PANEL. (Use +Screw Driver) 5) Press the left and right PANEL HOOK and then separate the PANEL from the indoor unit. 	

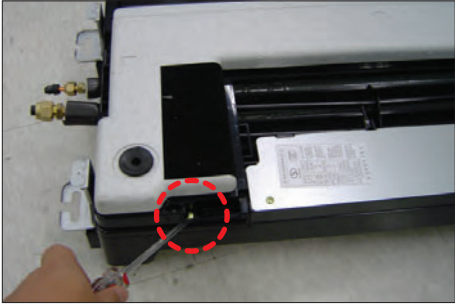
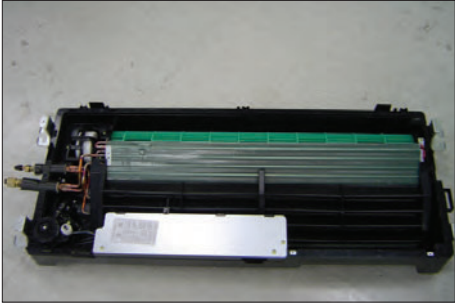

No	Parts	Procedure	Remark
	<p>PANEL And FILTER (Continues)</p>	<p>6) Open the GRILLE and then separate the CLIP WIRE.</p> <p>7) Remove the screws fixed in COVER DISPLAY, COVER MOTOR RIGHT and then remove the COVER DISPLAY, COVER MOTOR RIGHT . (Use +Screw Driver)</p> <p>8) Disconnect the connector. (Remote control receiver PBA and Display PBA)</p>	

No	Parts	Procedure	Remark
	<p>PANEL And FILTER (Continues)</p>	<p>9) Remove the 4 screws fixed in STEP MOTOR and then remove the MOTOR. (Use +Screw Driver)</p> <p>10) Remove the 4 HINGE and then separate the BLADE H.</p> <p>11) Separate the SENSOR HUMIDITY.</p> <p>12) Remove the 5 screws fixed in GUIDE AIR and then remove the GUIDE AIR. (Use +Screw Driver)</p> <p>13) Separate the PLATE.</p>	      

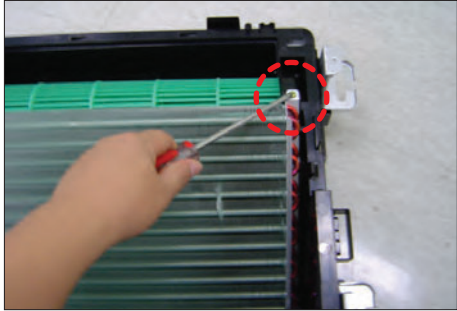
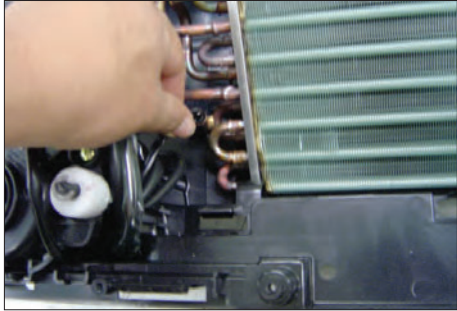
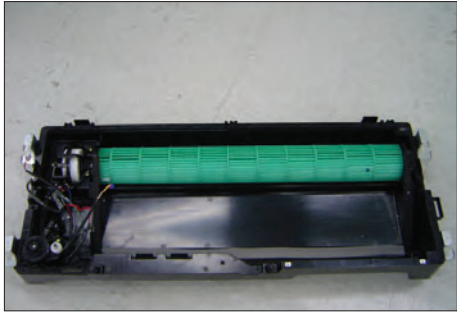
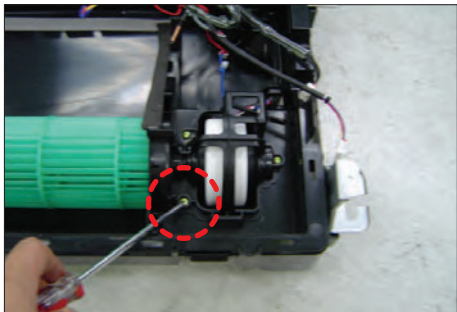
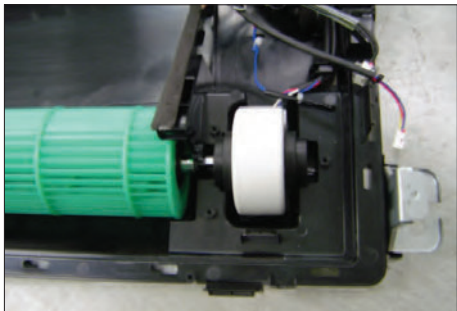

No	Parts	Procedure	Remark
2	Drain Pan	<p>1) Separate 5 fixing screws from the Drain Pan. (Use +Screw Driver)</p> <p>2) Pull the Drain Pan to separate them from the Indoor Unit.</p> <p>⚠ When disassembling the Pan, be careful not to touch the heat exchanger board with a bare hand.</p>	 
3	Control In	<p>1) Undo 3 fixing screws in the Control In appliance part to separate the Cover. (Use +Screw Driver)</p>	 

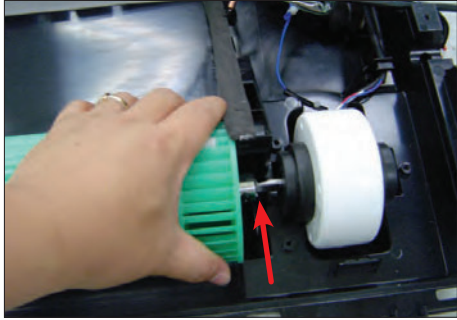
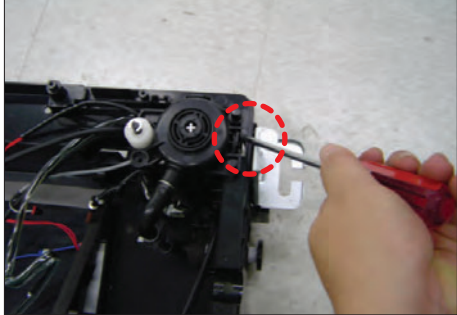
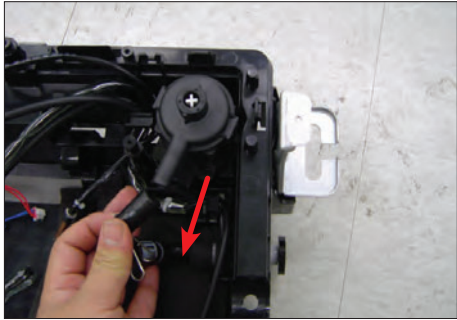
No	Parts	Procedure	Remark
		<p>2) Separate 8 connectors on the PCB of the Indoor Unit.</p> <p>3) Separate the Control In from the Indoor Unit.</p>	  
4	Drain Sub	1) Push the hook on the Drain Sub to separate it.	 



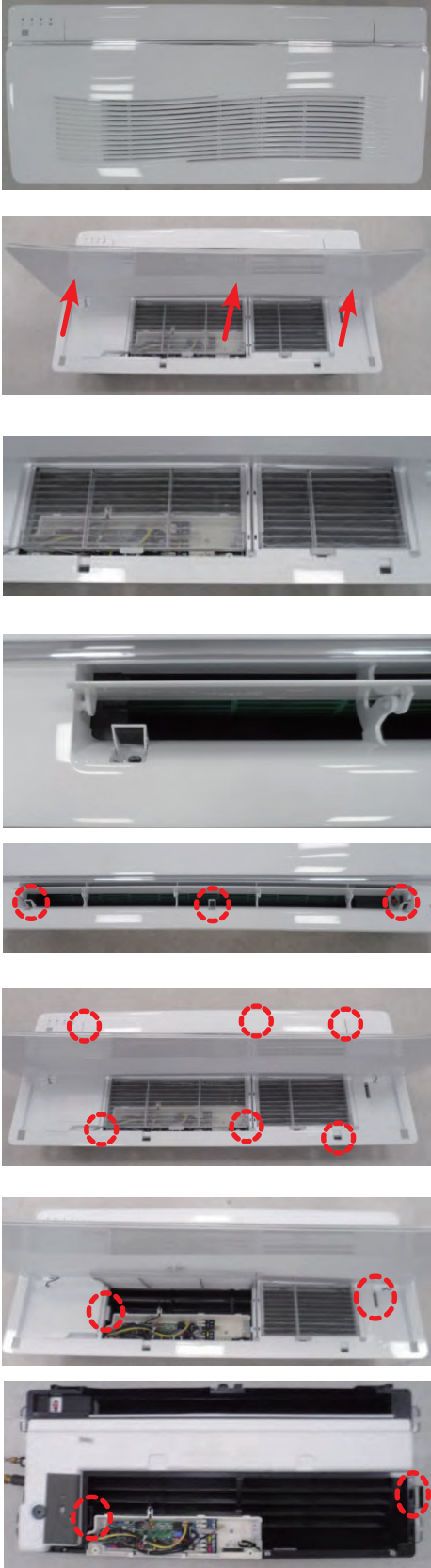

No	Parts	Procedure	Remark
5	Heat Exchanger	<ol style="list-style-type: none"> 1) Undo fixing screw in the Heat Exchanger. (Use +Screw Driver) 2) Separate an Indoor Sensor from the Heat Exchanger. 3) Separate the Heat Exchanger from the Indoor Unit. 	  
6	Cross Fan	<ol style="list-style-type: none"> 1) Undo 3 fixing screws on the Cover Fan Motor. (Use +Screw Driver) 2) Separate the Cover Fan Motor from the Indoor Unit. 	 

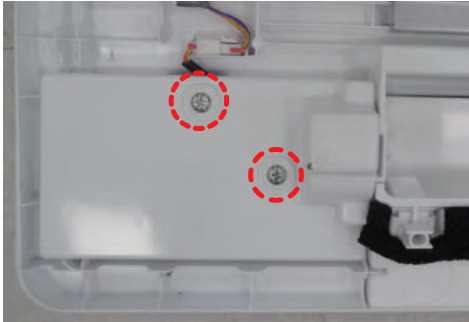
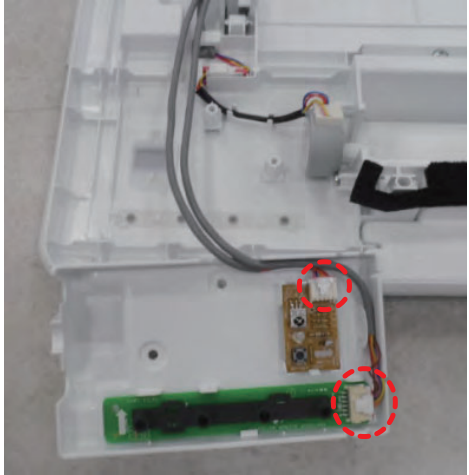
No	Parts	Procedure	Remark
		<p>3) Separate the Cross Fan from the Indoor Unit.</p>	
7	Drain Pump	<p>1) Separate fixing screw in the Cover Drain Pump. (Use +Screw Driver)</p> <p>2) Separate the Drain Hose from the Drain Pump.</p> <p>3) Separate the Drain Pump from the Indoor Unit.</p>	  

No	Parts	Procedure	Remark
1	PANEL & FILTER INTERIOR TYPE (PC1NWSMAN PC1BWSMAN)	<ol style="list-style-type: none"> 1) Open the GRILLE, as shown in the picture. 2) Separate the FILTER from the PANEL. 3) Remove the 2 COVER SCREW. 4) Remove the 5 screws fixed in PANEL and then separate from the indoor unit. (Use +Screw Driver) 5) Press the left and right side HOOK of PANEL and then separate the PANEL from the indoor unit. 	

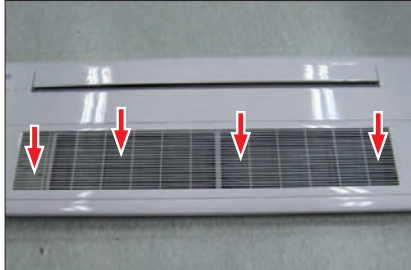

No	Parts	Procedure	Remark
	<p>PANEL & FILTER (cont.)</p>	<p>6) Open the GRILLE and then raise the LINK LEVER SWITCH (yellowish green) of left and right in the direction of arrow and then separate the LINK LEVER.</p> <p>7) Remove the fixing screws from the COVER DISPLAY using electric motion driver and separate it.</p> <p>8) Disconnect the connectors of remote control receiver PBA / display PBA.</p>	    

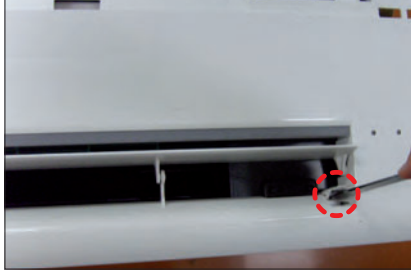

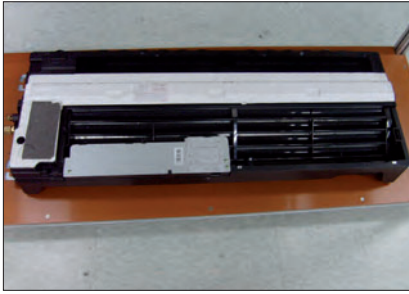
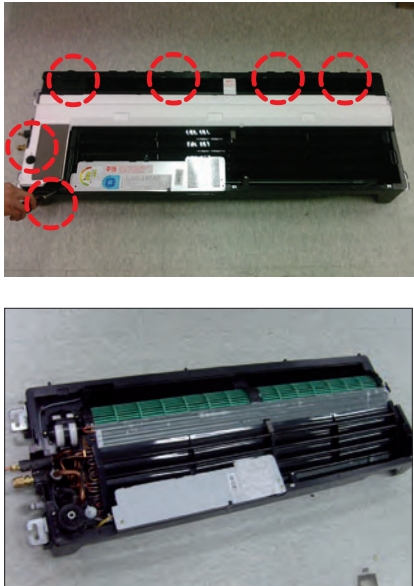
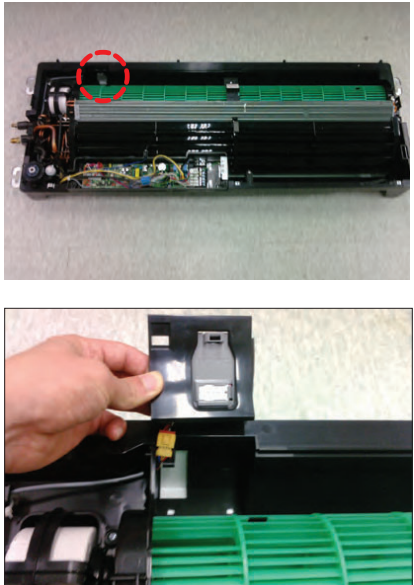
■ AM052/060/072FN1DBH, AM052/060/072HN1DBH1, AM056/071FN1DEH, AM056/071JN1DEH

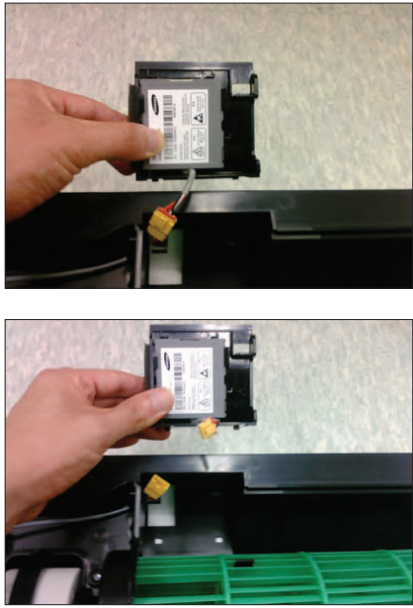
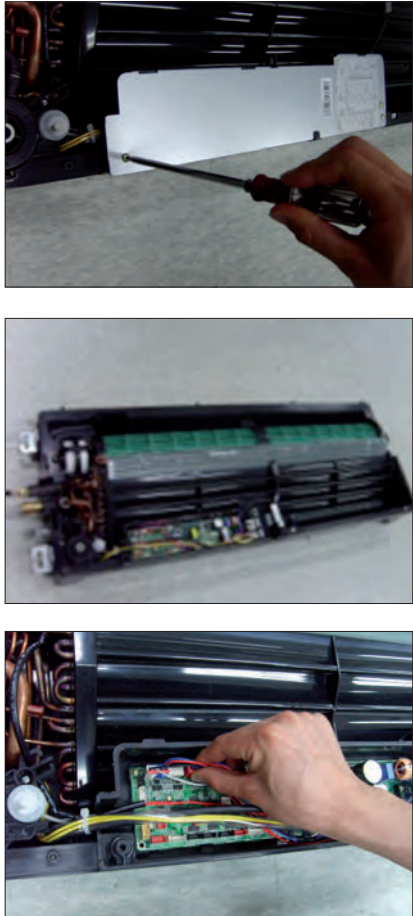

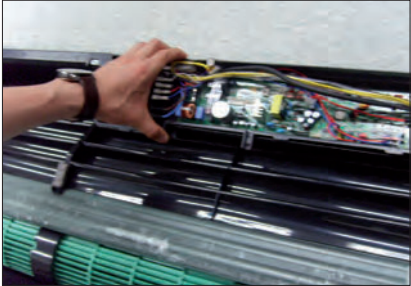
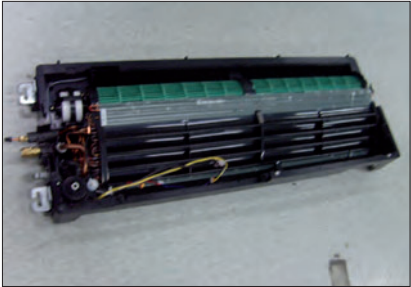
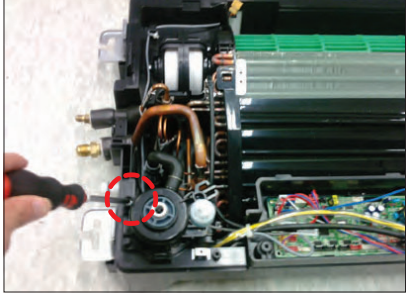
No	Parts	Procedure	Remark
1	PANEL & FILTER	<p>1) Press the PUSH BUTTON and open the GRILL.</p> <p>2) First, remove the clip from the PANEL. And then incline the GRILLE by 90° and separate the GRILLE from the PANEL.</p> <p>3) Separate the FILTER from the PANEL.</p> <p>4) Remove the 4 COVER SCREW.</p> <p>5) Remove the 7 screws fixed in PANEL and then separate from the indoor unit. (Use +Screw Driver)</p>	    

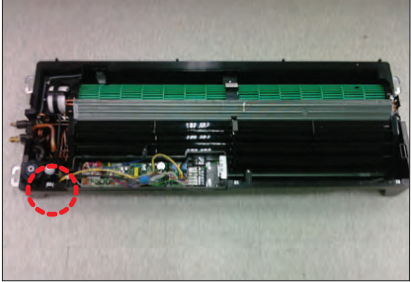
No	Parts	Procedure	Remark
		<p>1) Press the left and right side HOOK of PANEL and then separate the PANEL from the indoor unit.</p>	
2	DRAIN PAN	<p>1) Remove the 6 screws fixed in DRAIN PAN. (Use +Screw Driver)</p> <p>2) Remove the 2 HOOK fixed in DRAIN PAN and then separate from the indoor unit.</p> <p>⚠ When disassembling the PAN, be careful not to touch the heat exchanger board with a bare hand.</p>	
3	SPI-KIT (Option)	<p>1) Remove the SPI KIT from the indoor unit, as shown in the picture.</p>	

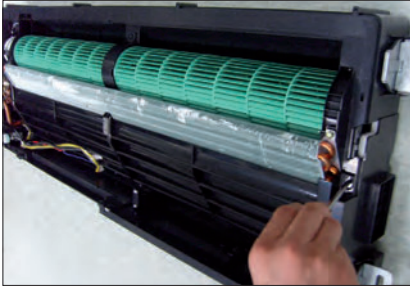
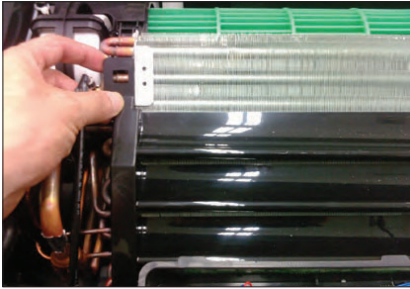
No	Parts	Procedure	Remark
			
4	Electrical equipment parts	<p>1) Remove the 3 screws fixed in electrical equipment parts and then separate the COVER. (Use +Screw Driver)</p> <p>2) Separate the 8 connectors from the indoor unit PCB, as shown in the picture.</p> <p>⚠ Turn off the power necessarily in case of contact pan area. Be careful, it may cause injury on the sharp sides of the pan.</p>	

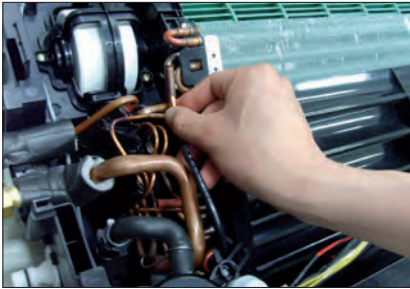
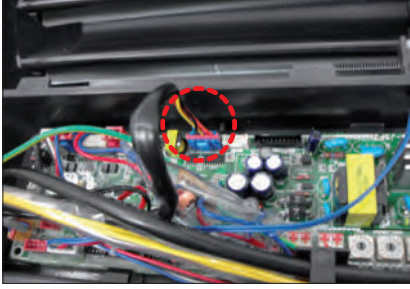
No	Parts	Procedure	Remark
		<p>3) Separate the electrical equipment parts from the indoor unit.</p>	 
5	DRAIN PUMP	<p>1) Remove the 3 screws fixed in COVER DRAIN PUMP. (Use +Screw Driver)</p> <p>2) First, loosen the BAND RING. And then separate the DRAIN HOSE from the DRAIN PUMP.</p> <p>3) Separate the DRAIN PUMP from the indoor unit.</p>	  

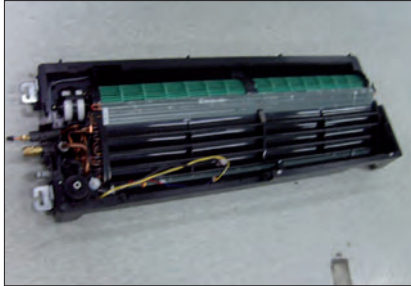
No	Parts	Procedure	Remark
6	DRAIN SUB	1) Remove the screw fixed in DRAIN SUB. (Use +Screw Driver) 2) Hold the HOOK of DRAIN SUB and separate it.	 
7	Heat Exchanger	1) Remove the screw fixed in Heat Exchanger. (Use +Screw Driver) 2) Separate the indoor unit SENSOR from the Heat Exchanger. 3) Separate the EEV connector from the PCB.	  

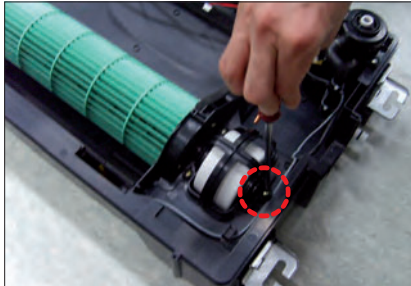
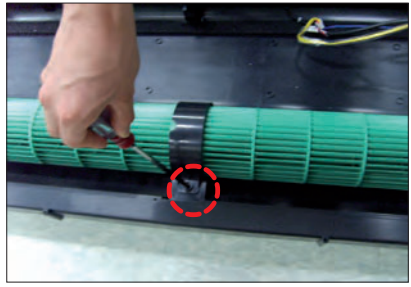
No	Parts	Procedure	Remark
		<p>4) Separate the Heat Exchanger from the indoor unit.</p> <p>5) Separate the EXPANSION COIL from the EEV BODY. (When servicing the EEV)</p>	 
5	DRAIN PUMP	<p>1) Remove the 3 screws fixed in COVER FAN MOTOR. (Use +Screw Driver)</p> <p>2) Remove the screw fixed in HOLDER FAN. (Use +Screw Driver)</p> <p>⚠ If the reassembly, end surface of HOLDER FAN and surface of ASSY CROSS FAN_L should be consistent.</p>	 

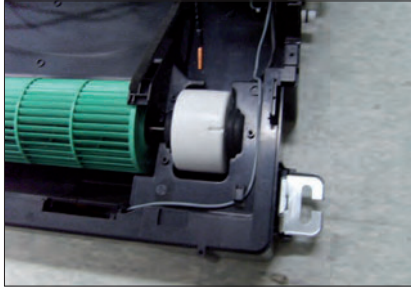
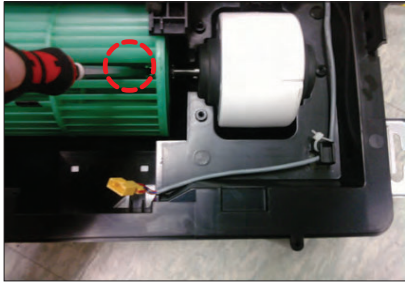
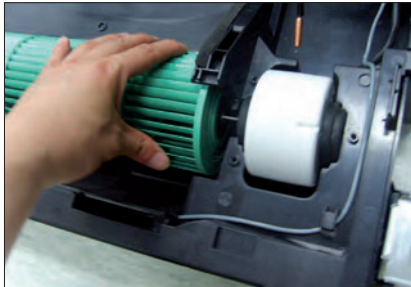
No	Parts	Procedure	Remark
		<p>3) Separate the COVER FAN MOTOR from the indoor unit.</p> <p>4) Remove the screw fixed in CROSS FAN. (Use +Screw Driver)</p> <p>5) Separate the CROSS FAN from the indoor unit.</p>	  

■ BIG DUCT

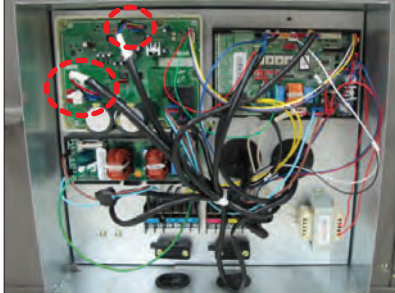
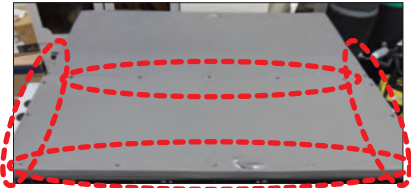
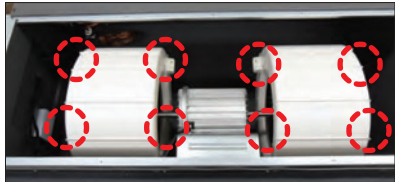
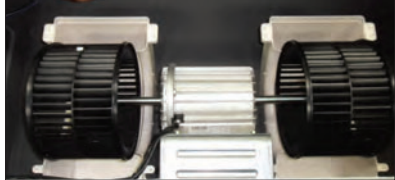
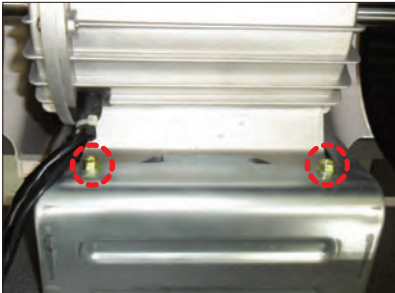
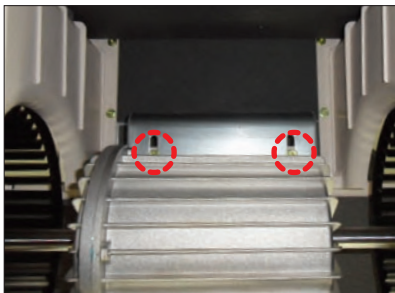

No	Parts	Procedure	Remark
1	MOTOR & BLOWER	<p>1) Detach the motor connectors from the PCB.</p> <p>2) Unscrew 16 screws and detach Cabinet-Base Blower. (Use+Screw Driver)</p> <p>3) Unscrew 8 screws and detach Case-Blower. (Use +Screw Driver)</p> <p>4) Unscrew 4 bolts and separate Motor & blower from Bracket-Motor. (Use +Screw Driver)</p>	     

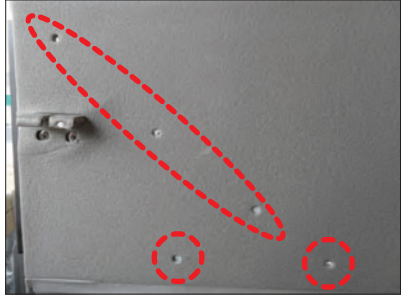
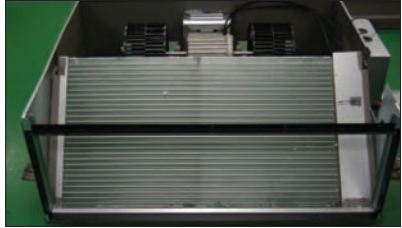
No	Parts	Procedure	Remark
		5) Unscrew bolt and Separate Blower from the motor. (Use +Screw Driver)	
2	EVAPORATOR & DRAIN-PAN	1) Detach EEV and Sensor connectors from the PCB. (Use +Screw Driver) 2) Unscrew 8 screws and Detach Cover-Pipe. (Use +Screw Driver) 3) Unscrew 31 screws and detach Cabinet-Base Blower and Cabinet-Base Drain. (Use +Screw Driver)	   

No	Parts	Procedure	Remark
		<p>4) Unscrew 10 screws and detach Drain-Pan from the indoor unit. (Use +Screw Driver)</p> <p>5) Separate Evaporator from the indoor unit.</p>	  

■ GD-S(Big Duct) - AM180JNHFKH/AM224JNHFKH

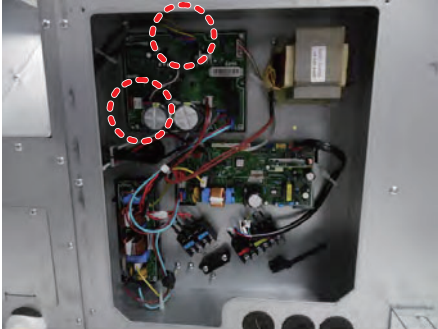
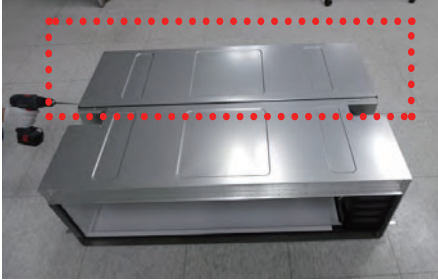
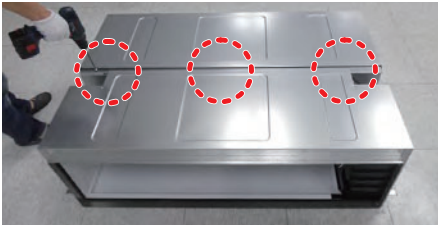
No	Parts	Procedure	Remark
1	Commom	1) Disasseble the Cover Control. - Unscrew 2 screws. ⚠ You must turn off the Power before disassembly.	

No	Parts	Procedure	Remark
2	Motor & Fan	<p>1) Disassemble the connection wire to take the motor fan out</p> <p>2) Disassemble th Cabinet Top Fan. - Unscrew 6 screws</p> <p>3) Disassemble the Link Screw. - Unscrew 3 screws</p> <p>4) Disassemble Cabinet Top Fan.</p>	    

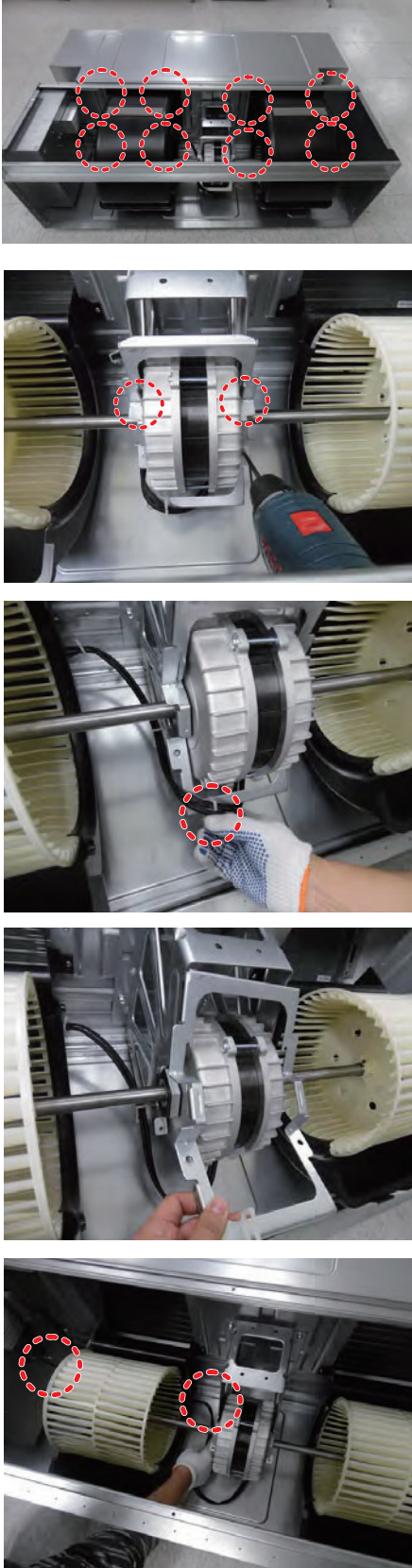
No	Parts	Procedure	Remark
		<p>5) Disassemble 2 Case Blower Top. - Unscrew 8 screws</p> <p>6) Disassemble 1 Holder Motor. - Unscrew 2 screws</p> <p>7) Disassemble Motor wire from 2 holder wire,</p>	

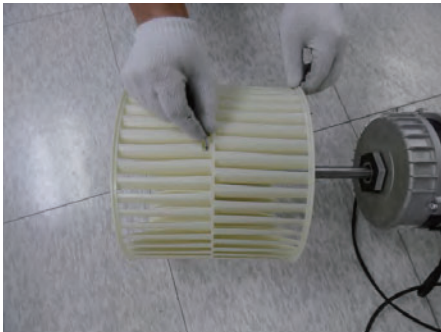
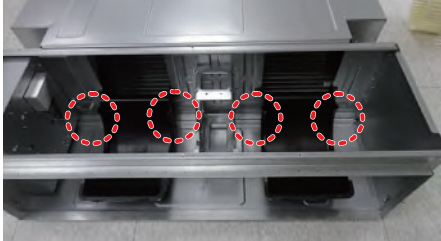
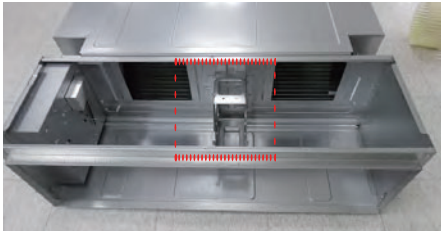
No	Parts	Procedure	Remark
		<p>8) After disassemble the Motor and Blower for the set, disassemble the Blower by use of 3mm wrench.</p> <p>9) Disassemble 2 Case blower bottom. - Unscrew 4 screws.</p> <p>10) Disassemble the Bracket Motor. - Unscrew 4 screws.</p>	   



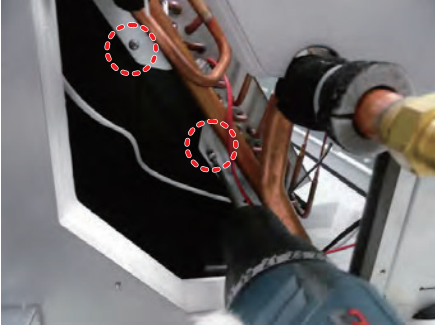

No	Parts	Procedure	Remark
3	Control Box	<p>1) Disassemble Evap Sensor wire and EEV wire(20kW only)</p> <p>2) Disassemble the Case Control. - Unscrew 3 screws</p>	  

No	Parts	Procedure	Remark
4	Evap	<p>1) Disassemble The Case Evap Top.</p> <ul style="list-style-type: none"> - [AC***JNHFKH] Unscrew 8 screws. - [AC***JNHPKH] Unscrew 6 screws. <p>2) Disassemble The Cushion Front.</p> <p>3) Disassemble The Cushion Support.</p> <ul style="list-style-type: none"> - Unscrew 1 screw 	

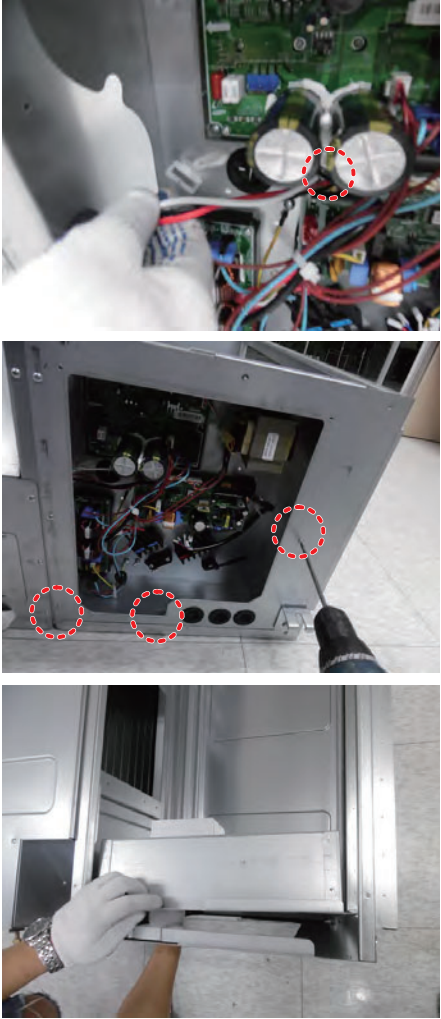
No	Parts	Procedure	Remark
		<p>4) Disassemble The Cover pipe. - Unscrew 3 screws</p> <p>5) Remove The cable tie on the Support Evap.</p> <p>6) Disassemble The Evap. - Unscrew 4 screws</p>	    

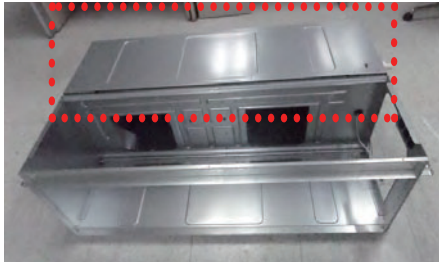

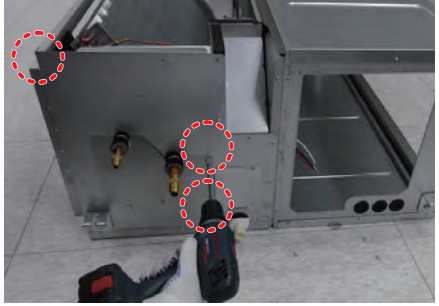
No	Parts	Procedure	Remark
		<p>1) Disassemble the connection wire to take the motor fan out.</p> <p>2) Disassemble The Cabi Fan Bottom. - Unscrew 9 screws.</p> <p>3) Disassemble the Link Screw. - Unscrew 3 screws</p> <p>4) Disassemble 2 Case blower bottom. - Unscrew 4 screws</p> <p>5) Disassemble Bracket Motor and Motor. - Unscrew 4 screws</p> <p>6) After disassemble the Motor and Blower for the set, disassemble the Blower by use of 3mm wrench.</p>	      

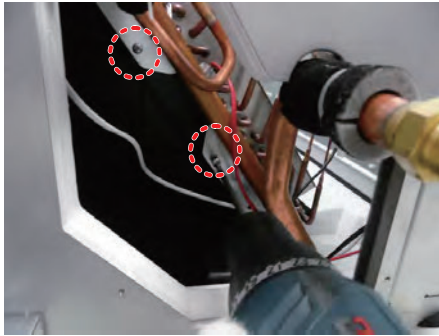
No	Parts	Procedure	Remark
2	Control Box	1) Disassemble Evap Sensor wire and EEV wire(20kW only) 2) Disassemble the Case Control. - Unscrew 3 screws	

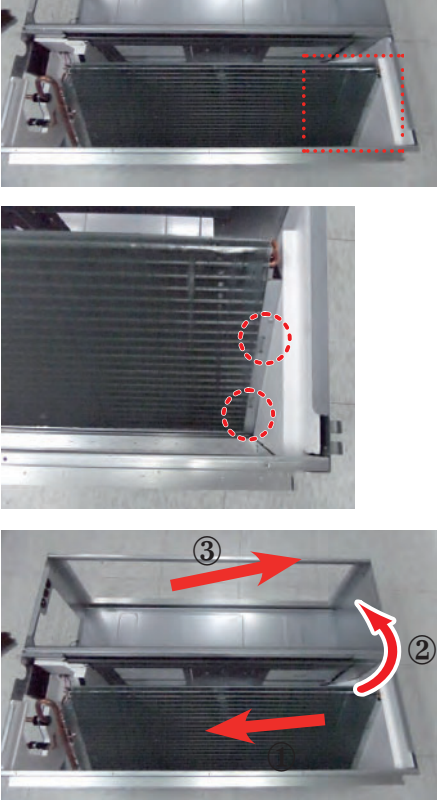

No	Parts	Procedure	Remark
3	Evap	<p>1) Disassemble The Case Evap Bottom. - [AC***JNHFKH]Unscrew 11 screws. - [AC***JNHPKH]Unscrew 7 screws.</p> <p>2) Disassemble The Drain Pan.</p> <p>3) Disassemble The Cover pipe. - Unscrew 3 screws</p> <p>4) Remove The cable tie on the Support Evap.</p> <p>5) Disassemble The Support Evap. - Unscrew 2 screws</p>	    

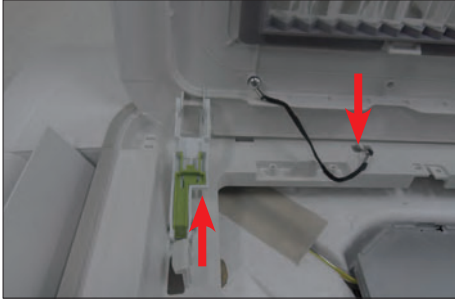
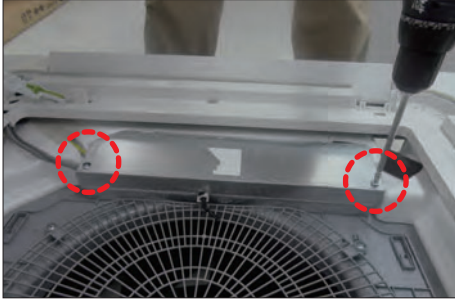
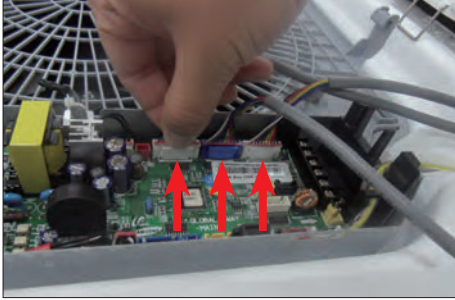

No	Parts	Procedure	Remark
		<p>6) Disassemble The Evap. - Unscrew 2 screws.</p> <p>① Moving the Evap 2~5cm to pipe direction.</p> <p>② Holding the pipe side and then rotating the opposite side.</p> <p>③ Moving the Evap in the direction of the arrow 3.</p>	

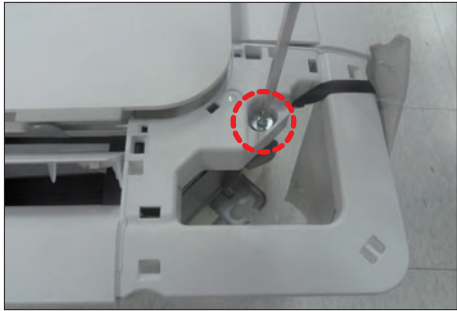
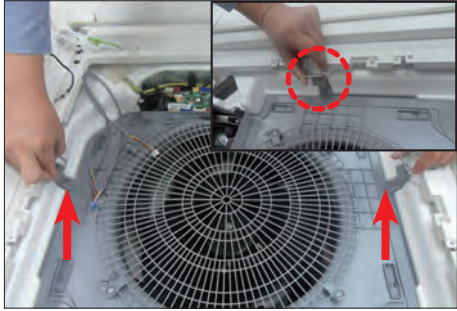
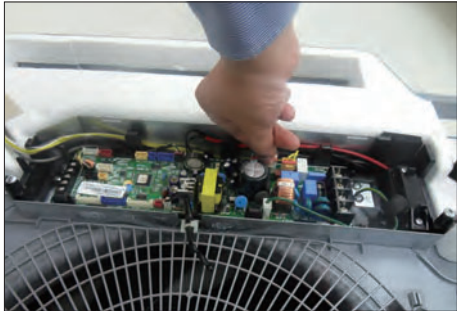
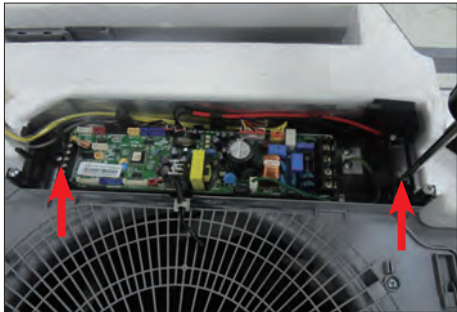
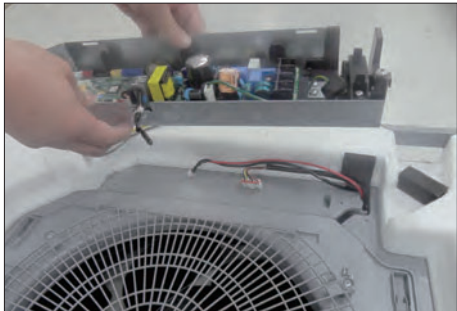

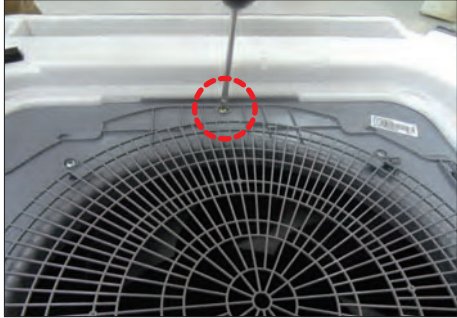

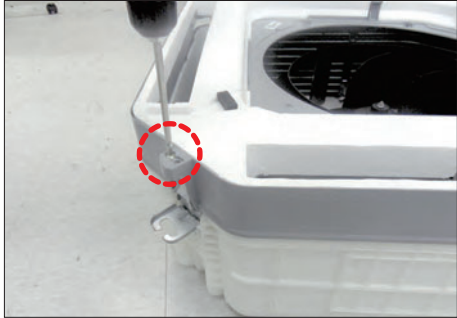
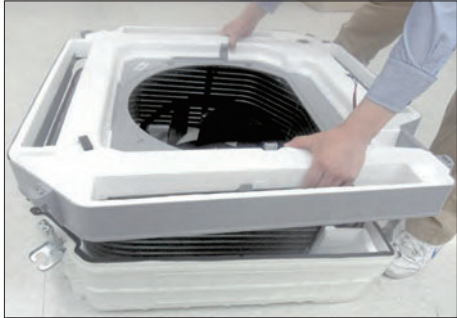
■ Global 4way Cassette type

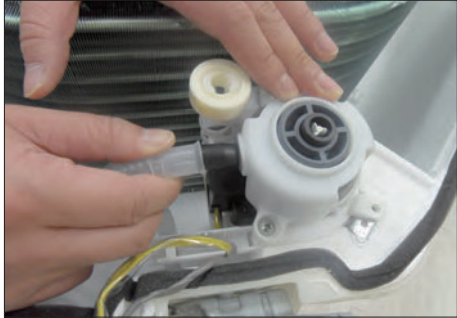
No	Parts	Procedure	Remark
1	Panel	<p>1) Push the handles on both sides of the Samsung logo towards the product's interior to open the Grille.</p> <p>2) Push up the green knob in the Open direction, and detach the white link from the panel. Detach the safety clip.</p> <p>3) Remove the 2 fixed screws to remove the Control-Box Cover. (Use +Screw Driver)</p> <p>4) Remove the Remocon-Receiver and Blade Connector Wire from the PBA. (3EA)</p> <p>5) Push the 4 panel corners and cover downwards to remove it.</p>	    

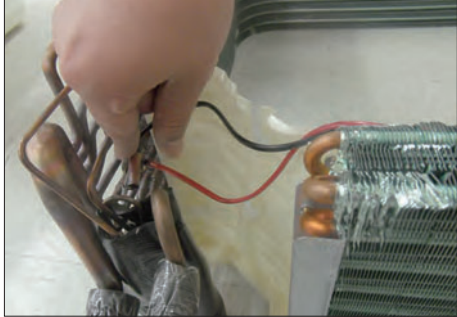
No	Parts	Procedure	Remark
		<p>6) Disassemble the bolts that are assembled with the indoor unit at the 4 panel corners.</p> <p>7) Press the Steel Hangers at both sides of the panel inwards, and rotate them 90 degrees to remove it from the indoor unit's Hock. Remove the panel from the indoor unit.</p>	 
2	Control-Box	<p>1) Disconnect the Connector Wire that is connected to the indoor unit's PBA from the PBA.</p> <p>2) Unscrew the 2 fixed screws on both sides of the Control Box, and disassemble the Control Box from the indoor unit. (Use +Screw Driver)</p>	  

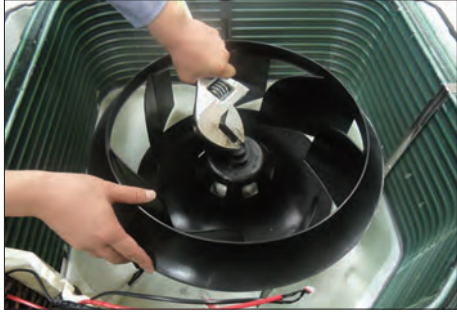



No	Parts	Procedure	Remark
3	Bell-Mouth	<p>1) Unscrew the screw fixed on the Bell-Mouth. (Use +Screw Driver)</p> <p>2) Push the Bell-Mouth in the direction opposite to where it's installed on the Control-Box to remove it.</p>	 
4	Drain Pan	<p>1) Unscrew the screws on the 4 corners of the indoor unit. (Use +Screw Driver)</p> <p>2) Remove the Drain Pan from the indoor unit.</p>	 



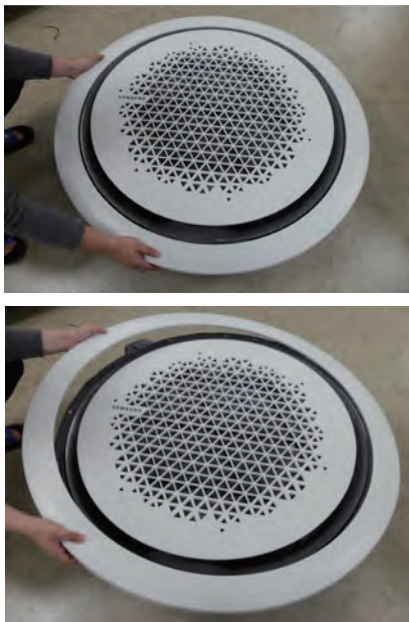

No	Parts	Procedure	Remark
5	Drain Pump & Hose	<p>1) Remove the 2 fixed screws and connect the white drainage hose from the Drain Pump. (Use +Screw Driver)</p> <p>2) Remove the 2 screws and take the Hose out from the indoor unit to assemble the transparent Drain-Hose on the side of the indoor unit. (Use +Screw Driver)</p>	<p>dis- the</p>   <p>Drain- disas- fixed on</p> 
6	Evap. Temperature Sensor	<p>1) Use your hand to remove the temperature sensor attached to the Evap Pipe along with the fixing clip.</p>	

No	Parts	Procedure	Remark
7	Fan & Motor	<p>1) Turn the hexangular nut attached to the top of the Fan counterclockwise to remove it. Take the Fan out of the Motor.</p> <p>2) Turn the three hexangular nuts on the Motor counterclockwise to remove the nuts. Take the Motor Wires attached to these three locations out with your hands prior to removing the Motor.</p>	  
8	Evaporator	<p>1) Remove the screws of the 2 Steel Holder Evaps that are used to fix the Heat Exchanger, and then remove it. (Use +Screw Driver)</p> <p>2) Remove the 2 fixing screws of the Partition Evap at the Heat Exchanger's In/Out Pipe. (Use +Screw Driver)</p>	 



No	Parts	Procedure	Remark
		<p>3) Remove the screw of the Cover Pipe that is used to fix the In/Out Pipe. Remove the In/Out Pipe. (Use +Screw Driver)</p> <p>4) Remove the Heat Exchanger from the indoor unit's cabinet.</p>	  

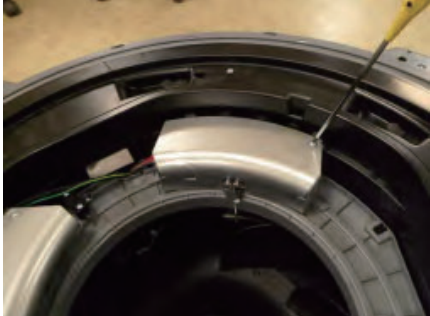

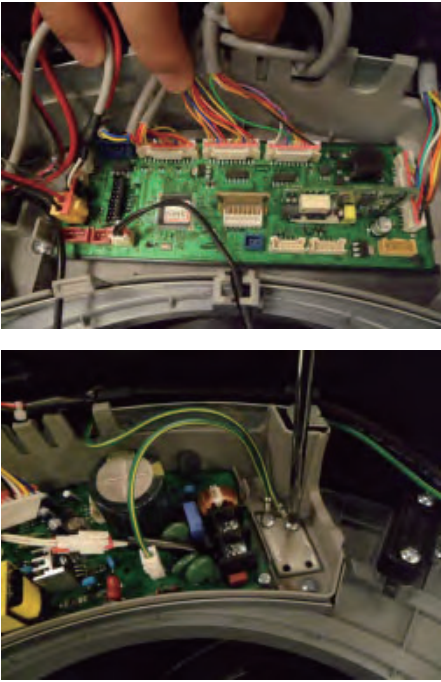
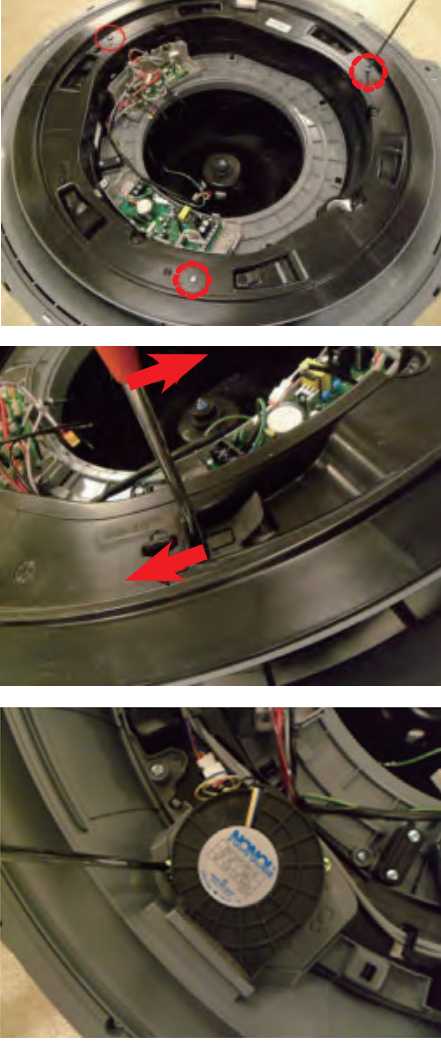

No.	Parts	Procedure	Remark
1	Panel	<p>► Ceiling type Panel</p> <p>1) Pull up the corner 4 places of Panel and separate it.</p> <p>2) Remove the 4 screws from the corner of Panel. (Use +Screw Driver)</p> <p>3) Pull the hook of Panel and then separate the Panel from the Indoor Unit.</p>	
1	Panel	<p>► Open type Panel</p> <p>1) Rotate the outside Panel to counterclockwise direction and then separate it.</p>	

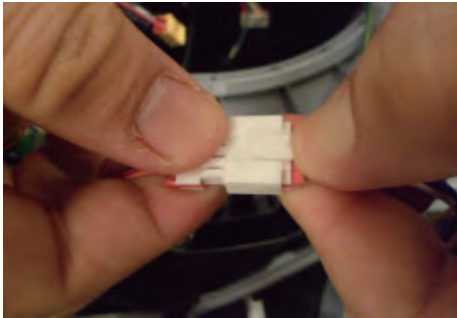
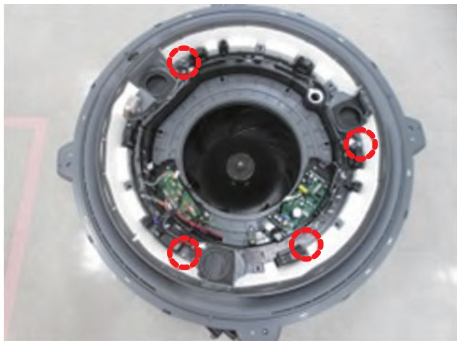

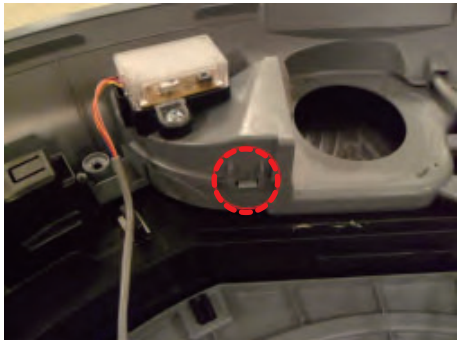
No.	Parts	Procedure	Remark
1	Panel	<p>2) Rotate the Grille to counterclockwise direction.</p> <p>3) Remove the safety clip of Grill inside and then separate the Panel from the Indoor Unit.</p> <p>4) Pull up the Filter from the Grill and separate it.</p>	  
2	Control Box	<p>1) Reomove the 2 screws which is fixed to the Indoor Unit upper part.(Use +Screw Driver)</p> <p>2) Rotate the Guard Fan to counterclockwise direction and separate it</p>	 

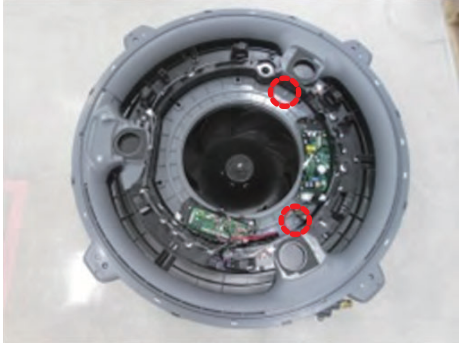



No.	Parts	Procedure	Remark
2	Control Box	<p>3) Reomove the 1 screw which is fixed to the Indoor Unit upper part.(Use +Screw Driver)</p> <p>4) Put finger in the "PULL" marked groove and then pull up the Cover</p> <p>5) Put finger in the "PULL" marked groove and then avoids the hook and it opens the Control Box Cover</p>	    

No.	Parts	Procedure	Remark
2	Control Box	<p>6) Separate the connectors from the Control Box.</p> <p>7) Remove the ground screw. (Use +Screw Driver)</p>	
3	Top Cover & Drain Pan	<p>1) Remove the 3 screws. (Use +Screw Driver)</p> <p>2) Push the hook and separate the Cover. ⚠ Damage can occur to product in case of use a sharp tool.</p> <p>3) Remove the screw which is fixed to Booster Fan. (Use +Screw Driver)</p>	

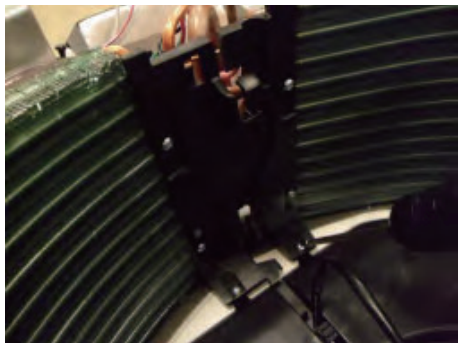
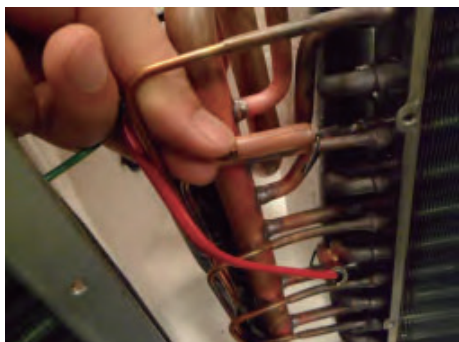

No.	Parts	Procedure	Remark
3	Top Cover & Drain Pan	<p>4) Pull the Booster Fan connector and separate the connector.</p> <p>5) Remove the 4 screws. (Use +Screw Driver)</p> <p>6) Push the hook and separate the Cover.</p>	    

No.	Parts	Procedure	Remark
3	Top Cover & Drain Pan	<p>7) Remove the screw and separate the Display Cover. (Use +Screw Driver)</p> <p>8)) Remove the 2 screws. (Use +Screw Driver)</p> <p>9) Push the hook and separate the Cover.</p> <p>10) Remove the 8 screws. (Use +Screw Driver)</p> <p>11) Separate the Indoor Unit upper part from the Body</p>	    

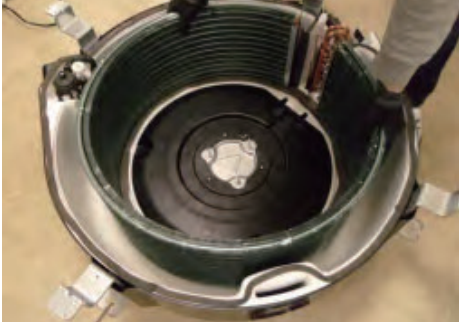
No.	Parts	Procedure	Remark
4	Drain Pump & Hose	2) Remove the 2 screws and separate the Drain Hose that is on the side lower part of Indoor Unit (Use +Screw Driver)	
5	Fan & Motor	<p>1) Remove the hex nut which is fixed to top of Fan and separate the Fan from the Motor. (Use Monkey Spanner)</p> <p>2) Remove the 3 hex nuts which is fixed to Motor and separate the Motor from the Indoor Unit. (Use Monkey Spanner)</p>	 
6	Temperature Sensor	<p>1) Remove the 6 screws which is fixed to Evaporator and separate the Partition.</p> <p>2) Separates the Temperature Sensor which is fixed to Evaporator Pipe with the fixing clip together by the hand.</p>	 

No.	Parts	Procedure	Remark
4	Evaporator	<p>1) Remove the screws which is fixed to Indoor Unit and separate the Evaporator fixing bracket. (Use +Screw Driver)</p> <p>2) Remove screws which is fixed to Indoor Unit and pull the hook and then separate the Drain Cover. (Use +Screw Driver)</p> <p>⚠ When assemble, be careful with the interference structure of piping projecting part.</p> <p>3) Separate the Evaporator from the Indoor Unit.</p> <p>⚠ If you remove the Evaporator with bare hands, it may injure your hands, gloves must be worn.</p>	    

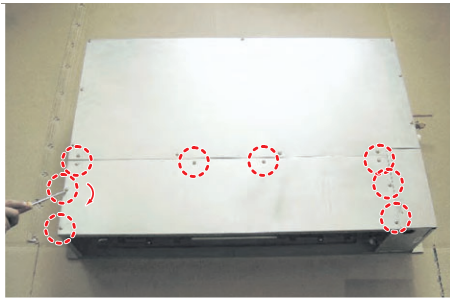
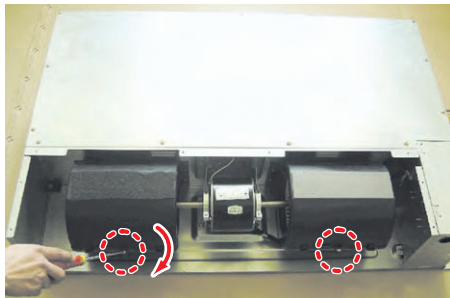
■ Duct type(Slim1,2)

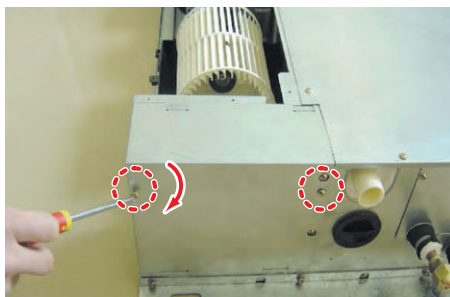
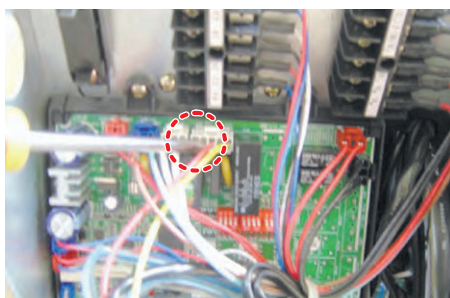
No	Parts	Procedure	Remark
1	Motor & Blower	<p>1) Disassemble the Cabinet-Top Motor. – Unscrew 8 screws</p> <p>2) Disassemble 2 Cover Blower Uppers. – After unscrewing 2 screws</p> <p>– Disassemble the Cover Blower Upper with pushing its hook.</p> <p>3) Disassemble the Cover Control. – Unscrew 2 screws</p> <p>4) Disassemble Motor Wires connected to the inside of PCB and connected to the Capacitor.</p>	    

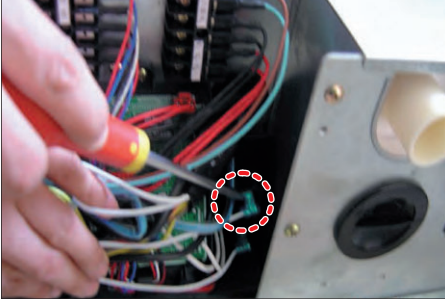
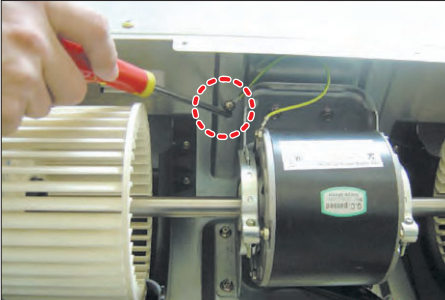
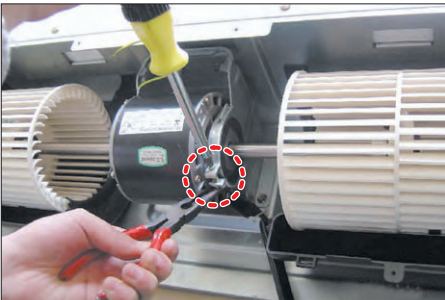
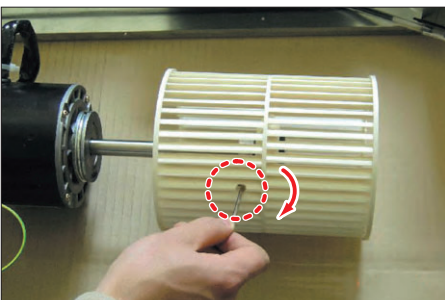
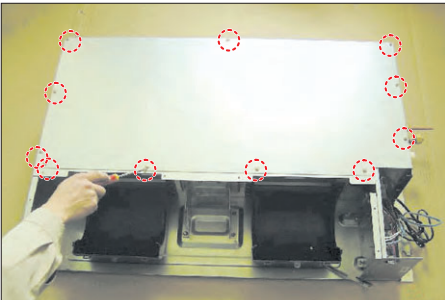
No	Parts	Procedure	Remark
		<p>5) Disassemble the Motor earth wire connected to the Partition. – Unscrew a screw</p> <p>6) Disassemble the band Motor for fixing the Motor. – Unscrew 2 screws</p> <p>7) After disassembling the Motor and Blower for the set, disassemble the Blower by use of 3mm wrench.</p>	   
2	Ass'y Drain Pan	<p>1) Disassemble the Cabinet-Top Evap. – Unscrew 11 screws</p>	

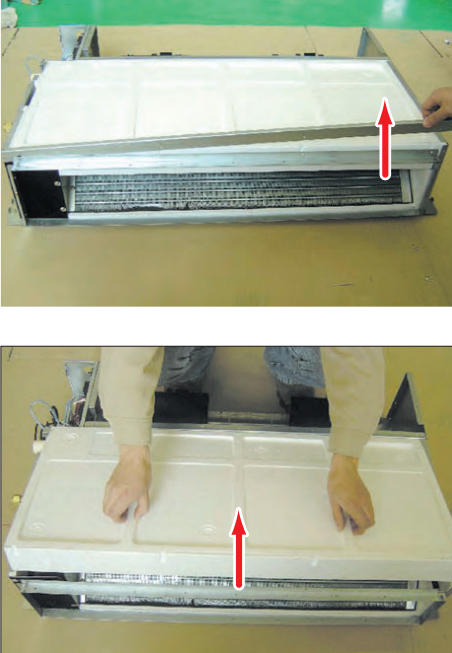
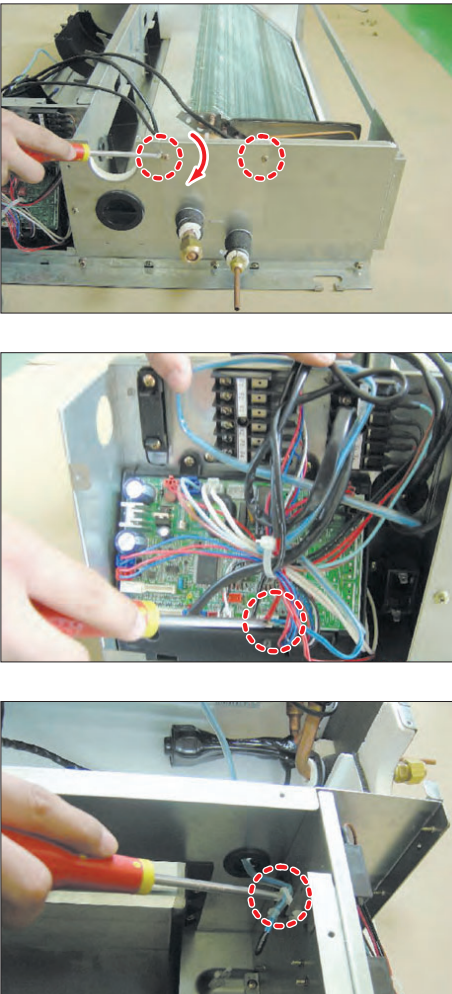
No	Parts	Procedure	Remark
		<p>2) Disassemble the Bracket Outlet Sub that fixes the Drain Pan equipped on the front of the set. – Unscrew 6 screws</p> <p>3) Disassemble the Drain Cushion from the set.</p>	
3	Ass'y Evap	<p>⚠ The Evaporator should be disassembled after disassembling the Cover Control 1-3) and the Drain Pan 2-1), 2-2), 2-3).</p> <p>1) Disassemble the Cover Pipe that fixes the high/ low pressure Pipe. – Unscrew 2 screws</p> <p>2) Disassemble the refrigerant temperature sensor, Inlet air temperature sensor, and EEV wire that connected to the inside of PCB.</p>	

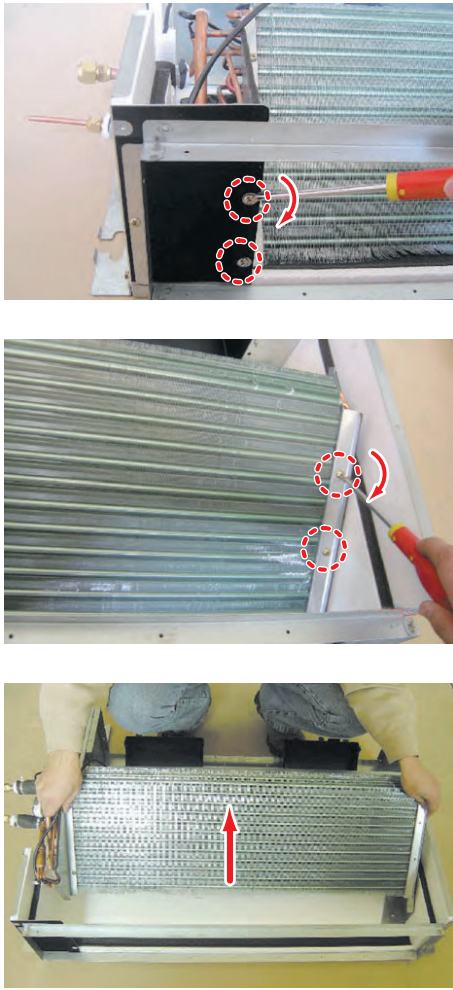
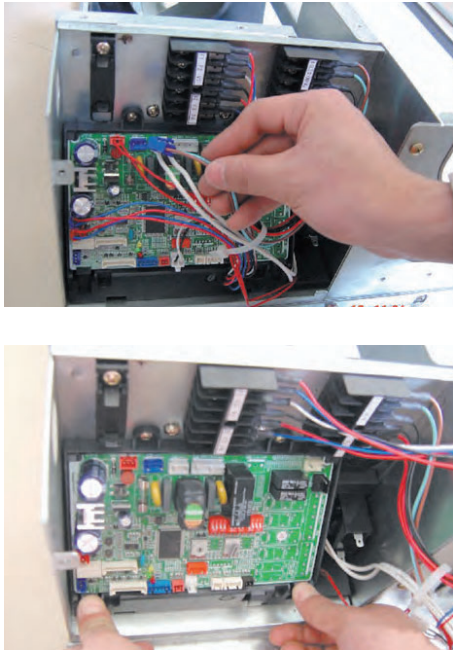
No	Parts	Procedure	Remark
		<p>3) Disassemble the Support Evap. LF that fixes the Evaporator. – Unscrew 2 screws</p> <p>4) Disassemble the Support Evap RH. – Unscrew 2 screws</p> <p>5) Disassemble the Evaporator form the set.</p>	
4	Ass'y Control In	<p>⚠ The Control In should be disassembled after disassembling the Cover Control 1-3).</p> <p>1) Disassemble all Control Wires connected to the inside of PCB.</p> <p>2) In case of disassembling the PCB separately, disassemble the PCB from the case with pushing the hook after unscrewing the screw. – Unscrew 1 screw</p>	

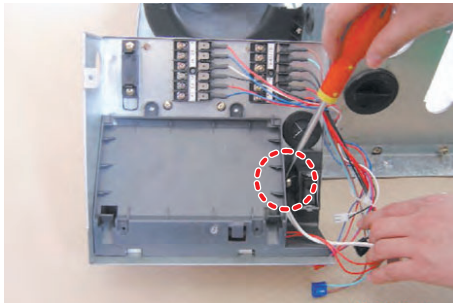
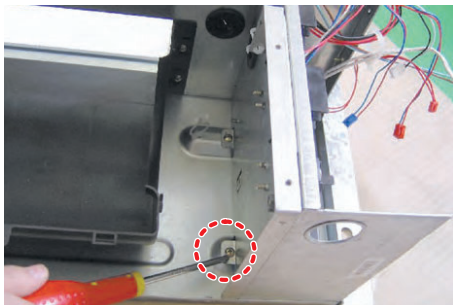
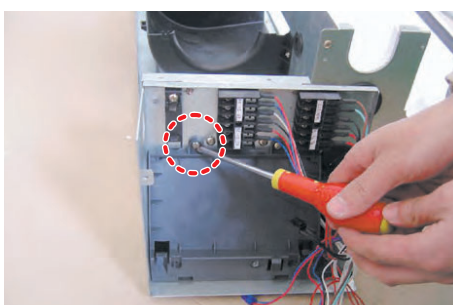
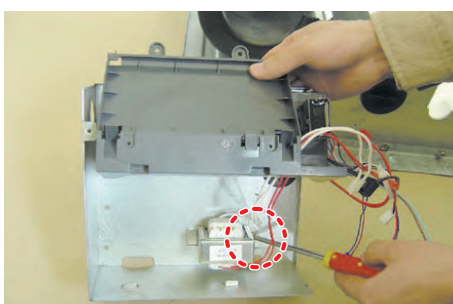
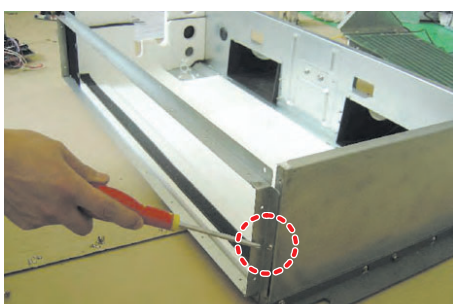

No	Parts	Procedure	Remark
		<p>3) In case of disassembling the Capacitor separately, disassemble the Capacitor from the Case.</p> <p>4) In case of disassembling the Case Control, disassemble the Case Control from the set after unscrewing the screw connected to the direction of Blower.</p> <p>⚠ Disassemble if after disassembling the Cabinet Top Motor 1-1).</p> <p>5) In case of disassembling the Trans Power, unscrew the screw fixing on the Case.</p> <p>⚠ Disassemble if after disassembling the case PCB 4-4).</p>	  
5	Bracket Outlet	<p>1) Disassemble the Bracket Outlet assembled on the Cabinet.</p> <p>– Unscrew 10 screws</p>	 

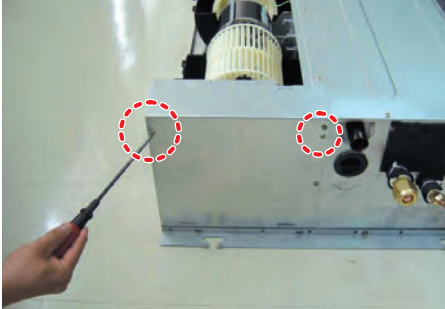
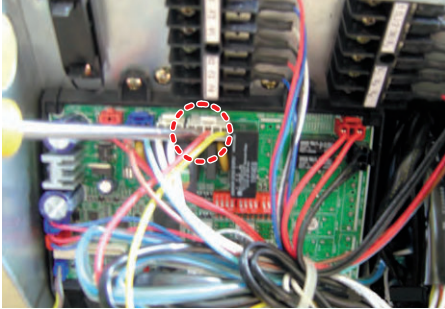
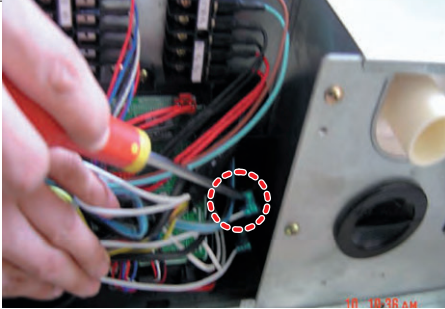
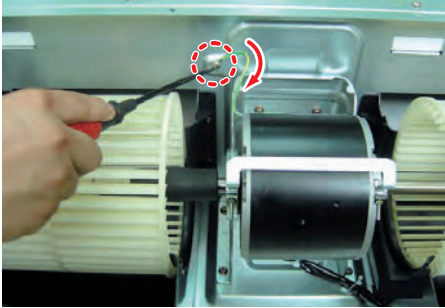
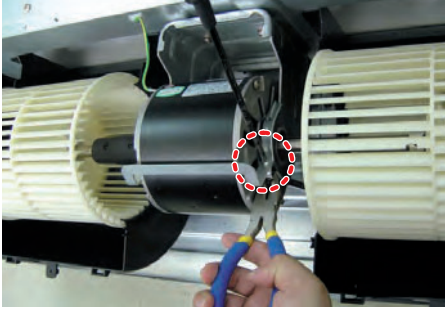

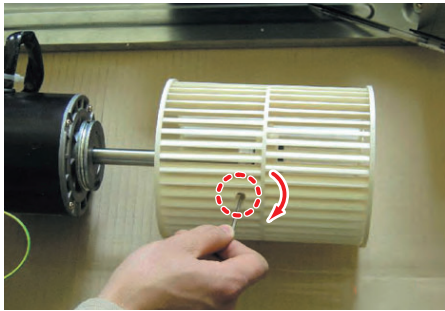
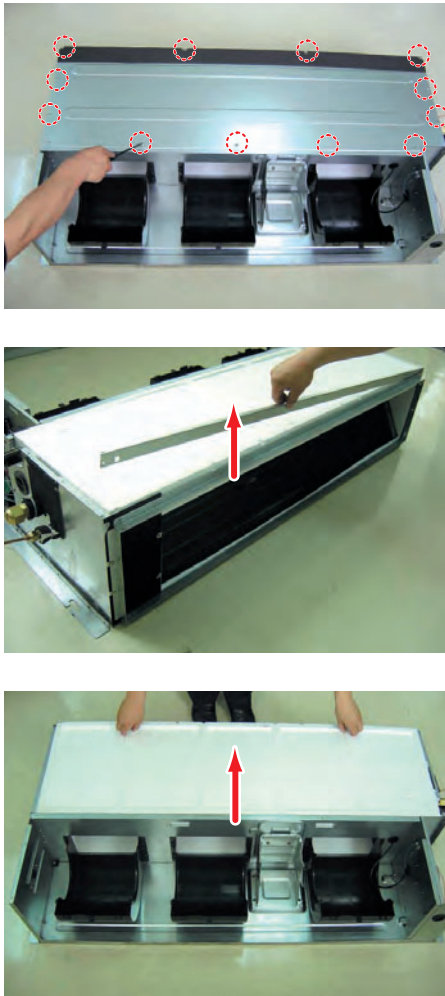
No	Parts	Procedure	Remark
		<p>3) If the Cabinet-Top Motor is assembled on the side of the set, the procedure of disassembling the Filter is just as the above.</p>	
5	Bracket Outlet	<p>1) After disassembling 13 indicating screws, detach Ass'y Cabinet-Top Motor.</p> <p>2) After disassembling 3 indicating screws, detach Ass'y Case Blower Upper.</p> <p>– Press the pothook of the Case Blower and detach Ass'y Case Blower Upper.</p>	

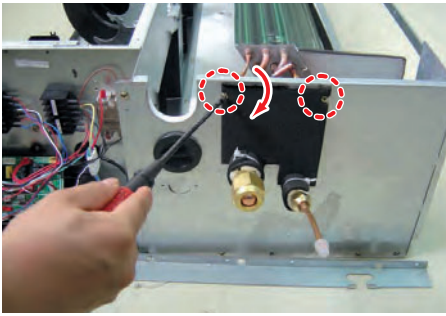
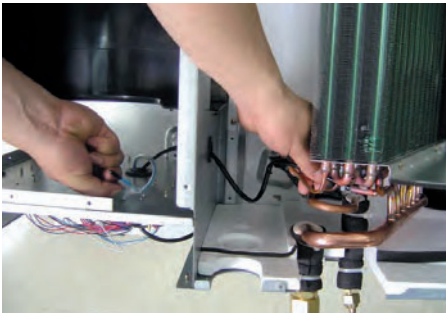
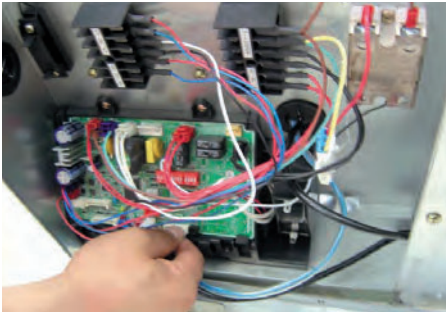
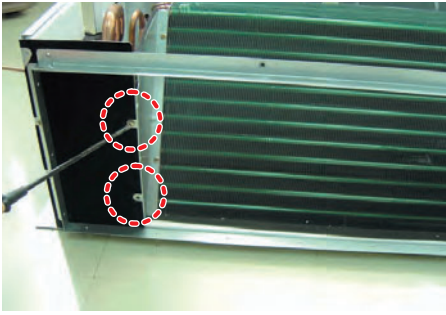
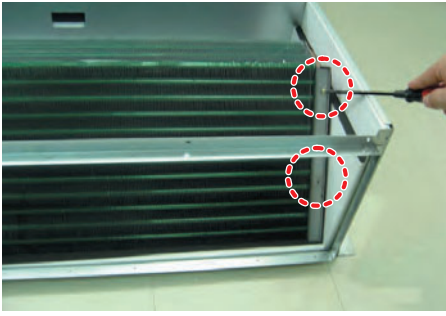
No	Parts	Procedure	Remark
		<p>3) After disassembling 2 indicating screws, detach the Cover Control.</p> <p>4) Detach the Motor Wire Connected to PCB and Capacitor.</p> <p>5) After disassembling the indicating screws, detach the wire connected to the Partition.</p> <p>6) After disassembling 2 indicating screws, detach the Ass'y Band Motor.</p>	    

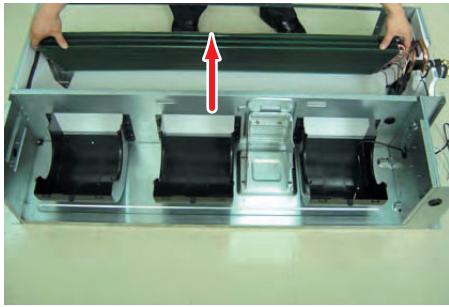
No	Parts	Procedure	Remark
		<p>7) After disassembling the Motor and Blowers, detach the Blowers from the axis of the Motor by 3mm inner hexagon spanner.</p>	
3	Drain Pan	<p>1) After disassembling 15 indicating screws, detach Ass'y Cabinet-Top Evap.</p> <p>2) After disassembling 6 indicating screws, detach the Bracket Outlet.</p> <p>3) Detach the Drain Pan.</p>	

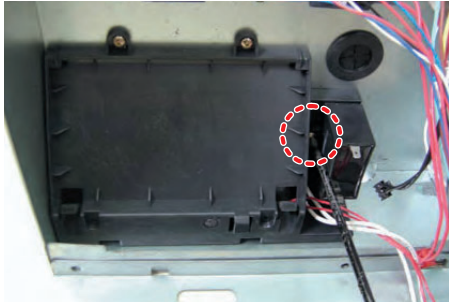
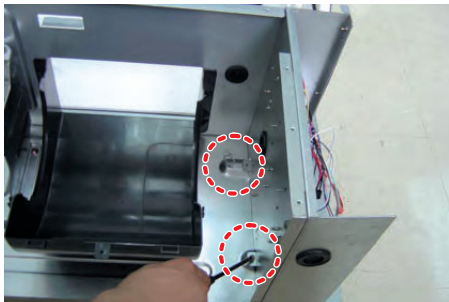
No	Parts	Procedure	Remark
4	Evaporator	<p>⚠ After finished the procedures above, detach the Evaporator.</p> <p>1) After disassembling 2 indicating screws, detach Ass'y Cover Pipe.</p> <p>2) Detach the Sensor from the Control Box.(including 2 Sensors)</p> <p>3) After disassembling 2 indicating screws, detach Ass'y Support Evap LF.</p> <p>4) After disassembling 2 indicating screws, detach Ass'y Support Evap RH.</p>	    

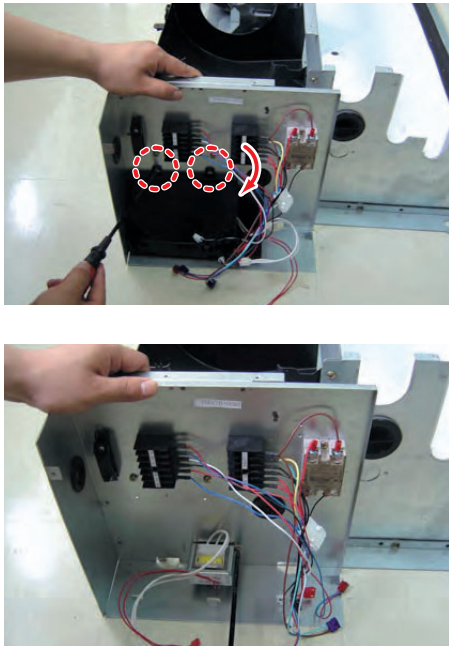

No	Parts	Procedure	Remark
		<p>5) Detach the Evaporator from the set.</p>	
<p>5</p>	<p>Control In</p>	<p>⚠ Detach the parts of Control In after disassembling the Cover Control.</p> <p>1) Detach all the wires connected to the PCB.</p> <p>2) If only the disassembly of PCB required, press the Pothook and detach the PCB from the set.</p> <p>3) If only the disassembly of Capacitor is required, detach it from the set.</p> <p>4) If only the disassembly of Case Control is required, detach it from the set after disassembling 2 indicating screws.</p>	   



No	Parts	Procedure	Remark
7	Ass'y Cross Fan	5) Detach the Transformer after disassembling 2 indicating screws. ⚠ Work is possible after disassembling the Case PCB.	
6	Ass'y Bracket Outlet	2) After disassembling 16 indicating screws, detach Ass'y Bracket Outlet.	

■ Slim Home Duct

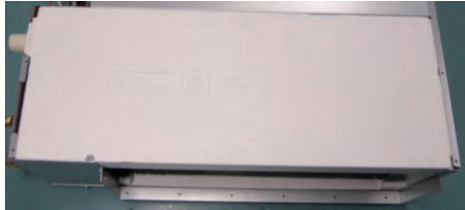

- AM017/022/028/036KNLDEH*

No	Parts	Procedure	Remark
1	Motor & Blower	<p>1) Disassemble the Cabinet Top Motor. - Unscrew 6 screws</p> <p>2) Disassemble the Cover Blower Upper with pushing its hook.</p> <p>3) Disassemble the Cover Control. - Unscrew 2 screws</p> <p>4) Disassemble Motor Wires connected to the inside of PCB.</p> <p>5) Disassemble the band Motor for fixing the Motor. - Unscrew 2 screws</p>	    

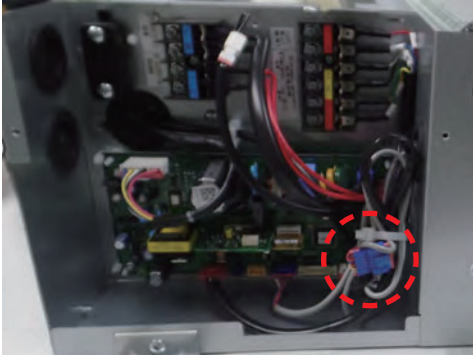

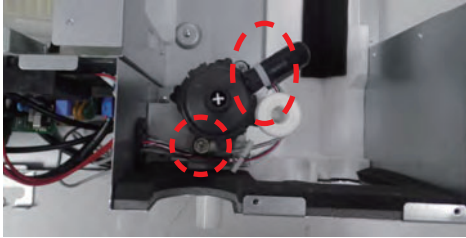
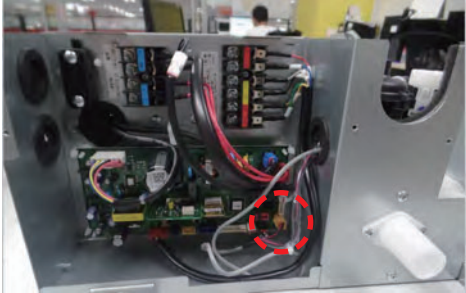

No	Parts	Procedure	Remark
		<p>6) After disassembling the Motor and Blower for the set, disassemble the Blower by use of 3mm wrench.</p>	
2	Drain Pan	<p>1) Disassemble the Cabinet Top Evap. - Unscrew 4 screws.</p> <p>2) Disassemble the Drain Cushion from the set.</p>	 

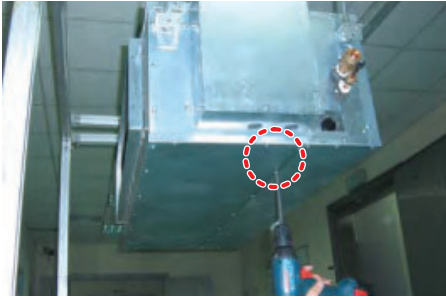

No	Parts	Procedure	Remark
3	Evaporator	<p>1) Disassemble the Cover Pipe that fixes the high/ low pressure Pipe. - Unscrew 2 screws</p> <p>2) Disassemble the Support Evap RH. - Unscrew 4 screws</p> <p>3) Disassemble the refrigerant temperature sensor, Inlet air temperature sensor, and EEV wire that connected to the inside of PCB.</p> <p>4) Disassemble the Evaporator form the set.</p>	  

No	Parts	Procedure	Remark
4	Control In	<p>1) Disassemble the control. - Unscrew 4 screws</p> <p>2) Disassemble the control box form the set.</p>	





No	Parts	Procedure	Remark
5	Drain Pump &Flow-switch	<p>1) Disassemble the Drain Pump. - Unscrew 2 screws - Cut 2 tie</p> <p>2) Disassemble the Drain Pump and Flow-switch wire that connected to the inside of PCB.</p> <p>3) Disassemble Drain Pump &Flow-switch from the set.</p>	  

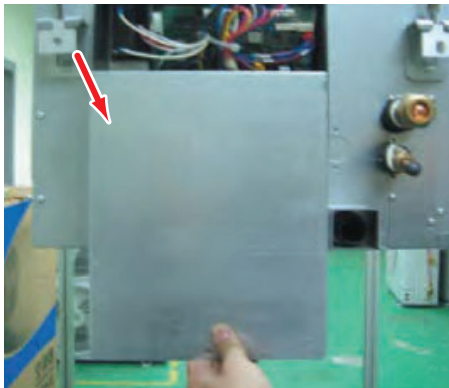
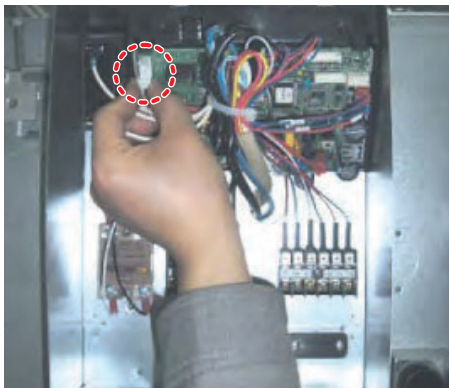

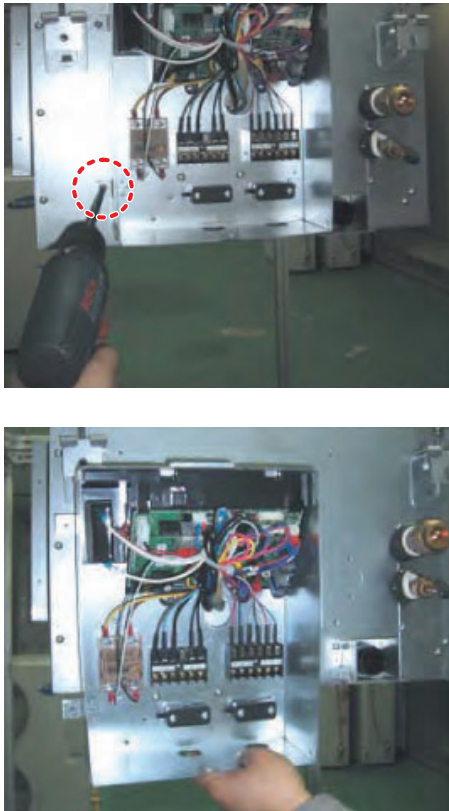
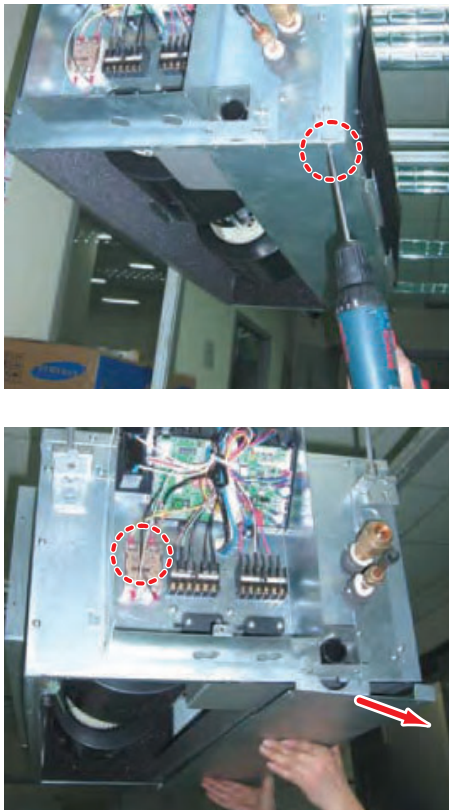

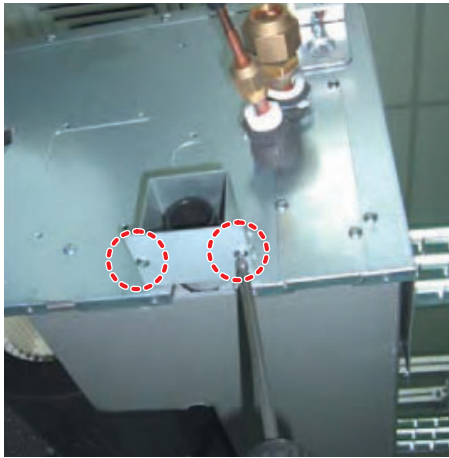
■ Duct type(Mid pressure1)

No	Parts	Procedure	Remark
1	Filter	<p>1) After disassembling 16 places indicating screws, detach Ass'y Cabi Bottom Blower. (Use +Screw Driver.)</p> <p>2) Detach from Ass'y Control In the capacitor connection wire between the Motor Fan and housing connector.</p> <p>3) After disassembling 2 places indicating screws, detach the 2 Fan Case. (Use +Screw Driver.)</p>	   



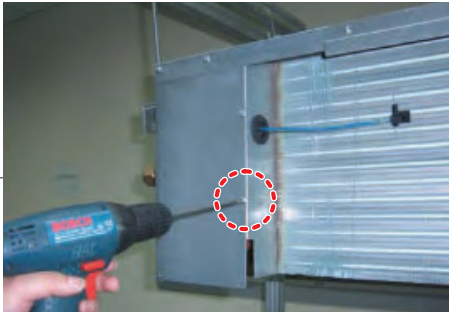
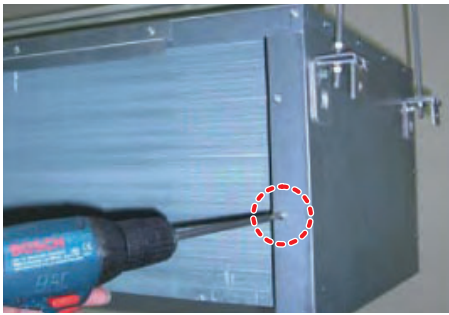

No	Parts	Procedure	Remark
		<p>4) After disassembling 2 places indicating screws, detach Fan Motor and Blower from the set.</p>	
2	Control In	<p>1) After disassembling 1 Indicating screw, detach the Cover control. (Use +Screw Driver.)</p> <p>2) Detach the Motor-Fan and Sensor Connector from the PCB.</p>	  



No	Parts	Procedure	Remark
		<p>3) Disassemble 4 indicating screws and detach Control In from the set. (Use +Screw Driver.)</p>	
3	Drain Pan	<p>※ Work is possible when Disassembling the Ass'y Cabi Bottom Blower.</p> <p>1) Disassemble 7 indicating screws and detach Ass'y Cabi Bottom Drain. (Use +Screw Driver.)</p>	

No	Parts	Procedure	Remark
		<p>2) Disassemble 2 indicating screws and detach Holder Pipe. (Use +Screw Driver.)</p> <p>3) Disassemble 4 indicating screws and detach the Drain Pan. (2 screws each at left and right side) (Use +Screw Driver.)</p>	   

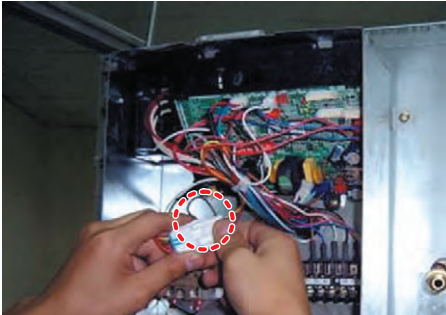

No	Parts	Procedure	Remark
4	Evap	<p>Work is possible when Disassembling the Ass'y Drain Pan.</p> <p>1) Disassemble 5 indicating screws to detach Cover Pipe.(Use +Screw Driver.)</p> <p>2) Disassemble Sensor on the Evap.</p> <p>3) Disassemble 4 indicating screws which are in the near of Hanger Plate to detach the Evap. (2 screws each at left and right side) (Use +Screw Driver.)</p> <p>⚠ It needs 2 peoples.</p>	    

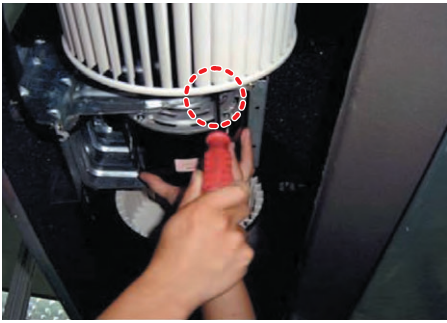
■ Duct type (Mid Pressure2, High Pressure)

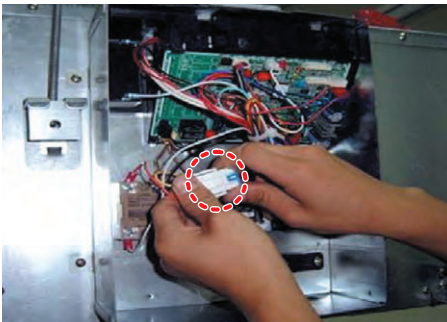
No	Parts	Procedure	Remark
1	Blower & Motor	<p>1) After disassembling 15 places indicating screws, detach Ass'y Cabi Bottom Blower. (Use +Screw Driver.)</p> <p>2) Detach from Ass'y Control In the capacitor connection wire between the Motor Fan and housing connector.</p> <p>3) After disassembling 4 places indicating screws, detach the 2 Fan Case. (Use +Screw Driver.)</p>	   

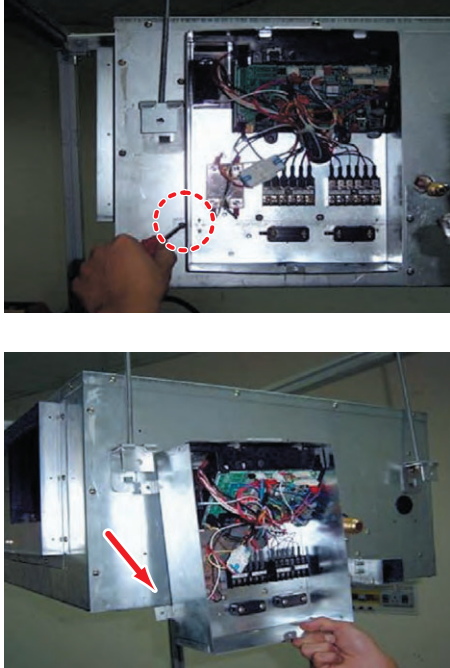
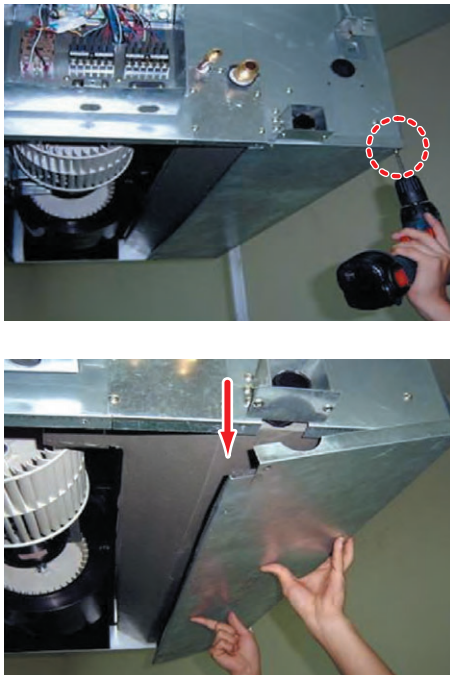
No	Parts	Procedure	Remark
		<p>4) After disassembling 2 places indicating screws, detach Fan Motor and Blower from the set. (Use +Screw Driver.)</p>	
3	Drain Pan	<p>1) After disassembling 1 Indicating screw, detach the Cover control.(Use +Screw Driver.)</p> <p>2) Detach the Motor-Fan and Sensor Connector from the PCB.</p>	  

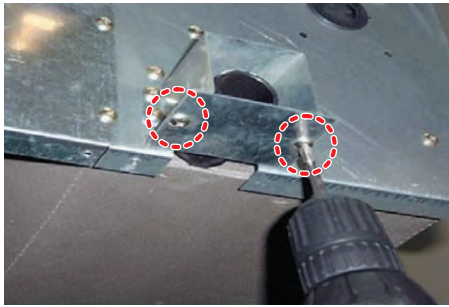
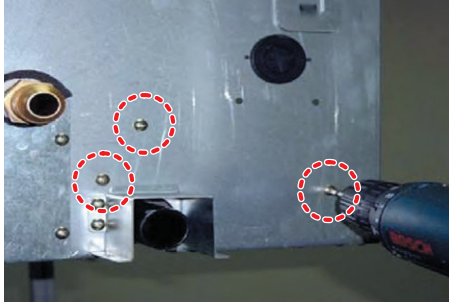
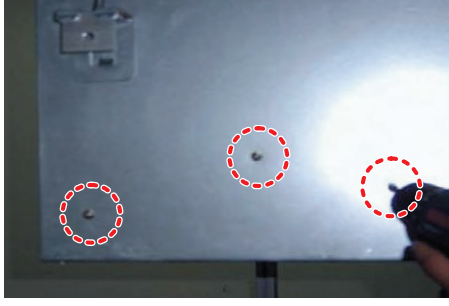

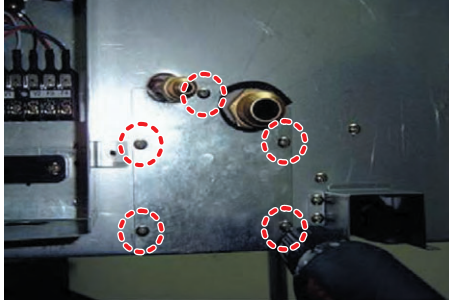
No	Parts	Procedure	Remark
		3) Disassemble 4 indicating screws and detach Control In from the set. (Use +Screw Driver.)	
3	Drain Pan	※ Work is possible when Disassembling the Ass'y Cabi Bottom Blower. 1) Disassemble 6 indicating screws and detach Ass'y Cabi Bottom Drain. (Use +Screw Driver.)	

No	Parts	Procedure	Remark
		<p>2) Disassemble 2 indicating screws and detach Holder Pipe. (Use +Screw Driver.)</p> <p>3) Disassemble 6 indicating screws and detach the Drain Pan. (Use +Screw Driver.) (3 screws each at left and right side)</p>	   
4	Evap	<p>※ Work is possible when Disassembling the Ass'y Cabi Bottom Blower.</p> <p>1) Disassemble 6 indicating screws and detach Ass'y Cabi Bottom Drain. (Use +Screw Driver.)</p>	

■ AM036/045/056/071/090/112/128/140HNMPKH,
AM112/128/140HNHPKH/EU, AE071/090MNMPEH/EU

No	Parts	Procedure	Remark
1	Common	<p>1)Disassemble the Cabinet Bottom Fan. - Unscrew 11 screws</p> <p>⚠ You must turn off the Power before disassembly.</p> <p>2)Disassemble the Case Filter Pre.</p> <p>3)Disassemble the Cover Control. - Unscrew 2 screws</p> <p>4)Disassemble the Cabinet Bottom Evap. - Unscrew 8 screws</p>	   

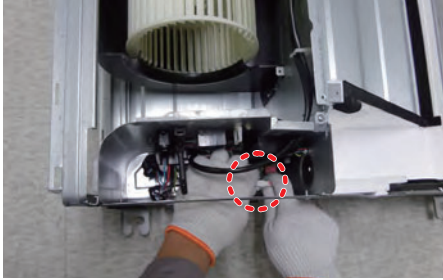
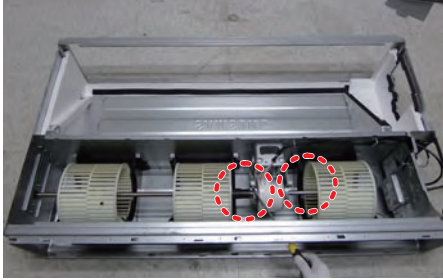
No	Parts	Procedure	Remark
2	Drain Pan & Evap	<p>1)Disassemble the Drain Pan from the set.</p> <p>2)Disassemble the 3 Case Blower Bottom. - Unscrew 6 screws</p> <p>3)Disassemble the Cover Pipe. - Unscrew 2 screws</p> <p>4)Disassemble the Support Evap. - Unscrew 1 screws</p> <p>5)Disassemble the Evap. - Unscrew 3 screws</p>	    

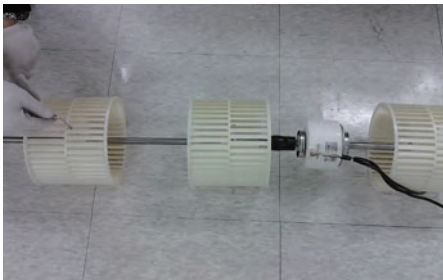
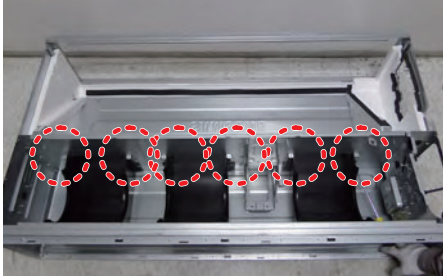

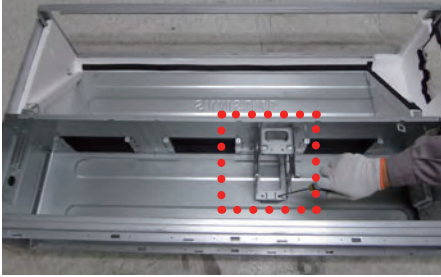
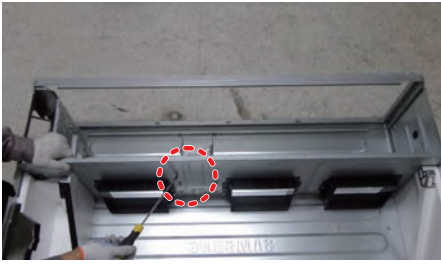
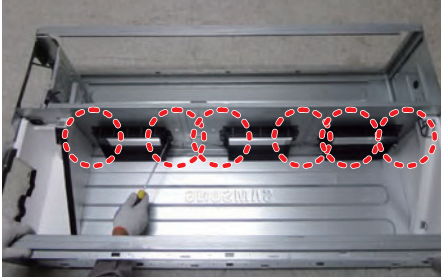
No	Parts	Procedure	Remark
3	Motor & Fan	<p>1)Disassembl the connection wire,the take the Motor Fan out</p> <p>2)Disassemble the 2 Holder Motor. - Unscrew 2 screws</p> <p>3)After disassembling the Motor and Blower for the set, disassemble the Blower by use of 3mm wrench.</p> <p>4)Disassemble the 3 Case Blower Top. - Unscrew 6 screws</p>	    

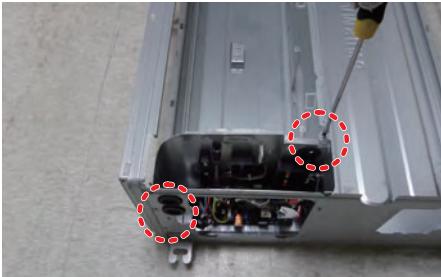
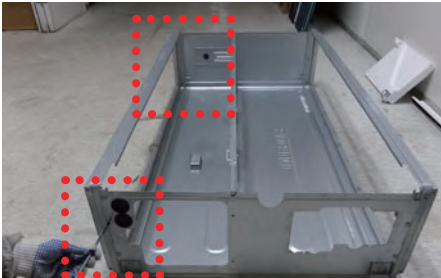

No	Parts	Procedure	Remark
		<p>5)Disassemble the Bracket Motor. - Unscrew 6 screws</p> <p>6)Disassemble the 3 Case Blower Out - Unscrew 6 screws</p>	  

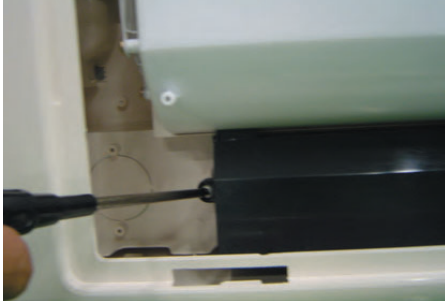
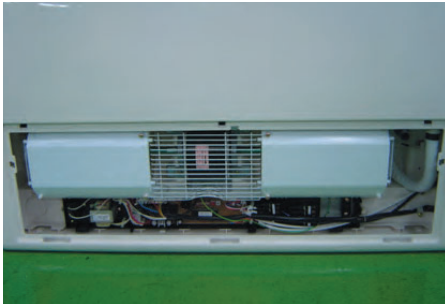

No	Parts	Procedure	Remark
4	Cushion	1)Disassemble the Assy Cushion Right. - Unscrew 1 screws 2)Disassemble the Seal Cushion LF. - Unscrew 1 screws	
5	Control	1)Disassemble the Case Control. - Unscrew 2screws	
6	Frame	1)Disassemble the Frame. - Unscrew 6 screws	

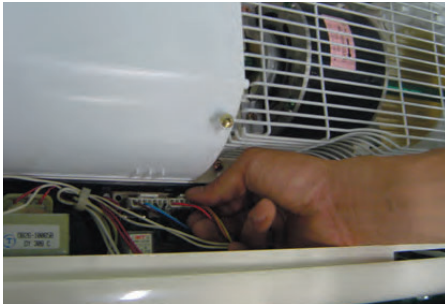
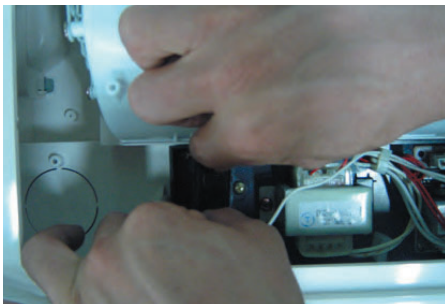

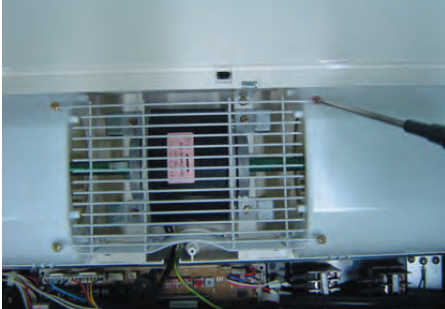
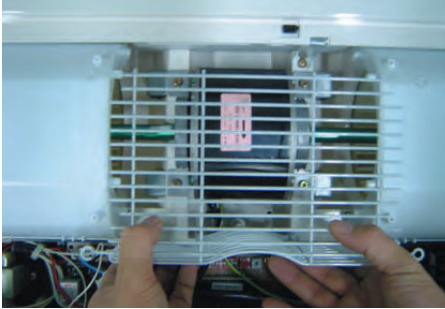
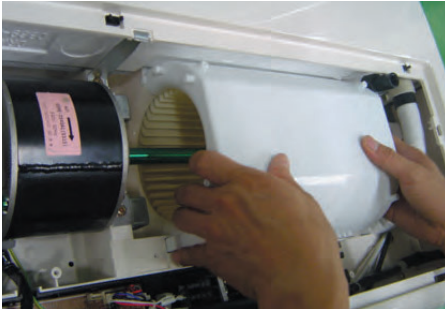

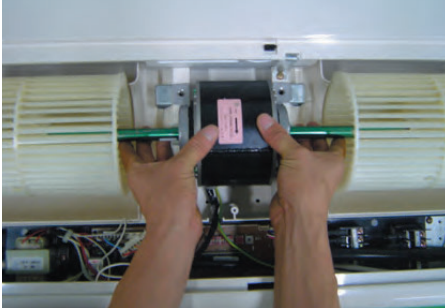
■ CEILING

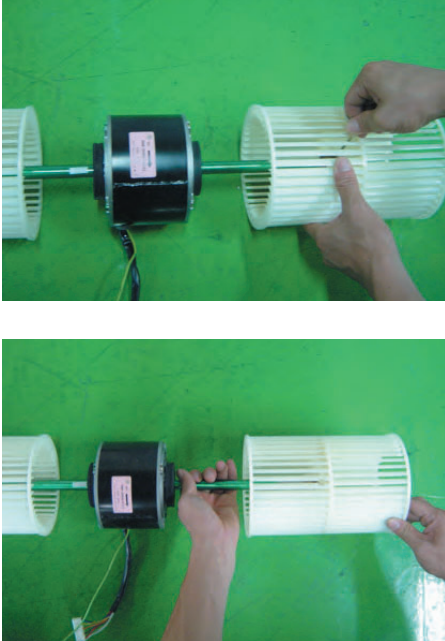
No	Parts	Procedure	Remark
1	Electrical Part	<p>1) Open the Grille by pressing 3 position. (center and both side)</p> <p>2) Detach the Air Inlet Grille.</p> <p>3) Open the Cover of Component Electrical Box by removing 3 screws. (center and both side)</p>	   





No	Parts	Procedure	Remark
			 
2	Fan & Motor	<p>1) Detach the screw and untie earth wire of Motor.</p> <p>2) Disconnect of housing of Motor Wire.</p> <p>3) Disconnect the Capacitor Wire.</p>	  

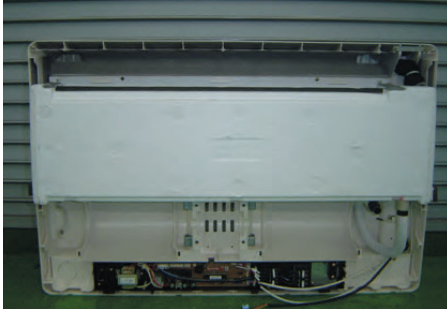

No	Parts	Procedure	Remark
		<p>4) Loosen the Guard Safety by removing 6 screws.</p>	 
		<p>5) Detach the Upper Case of Fan. (2EA)</p>	
		<p>6) Loosen the 4 screws what is fix the Motor.</p>	
		<p>7) Detach the Fan and Motor assembly.</p>	

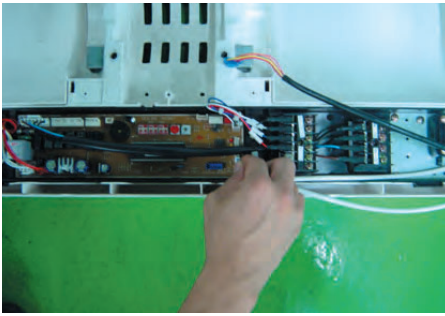
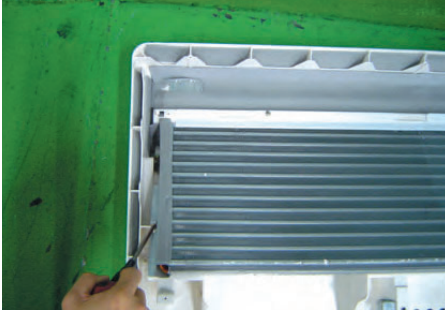

No	Parts	Procedure	Remark
		<p>8) Loosen the set fixing bolts. (with a M3 wrench)</p> <p>9) Detach the Fan.</p>	 <p>The first photograph shows a person using a green M3 wrench to loosen a bolt on a black motor assembly. The second photograph shows the person pulling the white fan housing away from the motor.</p>
3	Drain Pan	<p>1) Disconnect the Display PCB Wire as shown in picture. (white housing)</p> <p>2) Disconnect the Step Motor Wire as shown in picture. (blue housing)</p> <p>3) Disassemble the Hanger Bracket by removing the 1 screw.</p>	 <p>The first photograph shows a hand disconnecting a white wire from a display PCB. The second photograph shows a hand disconnecting a blue wire from a step motor. The third photograph shows the interior of a white drain pan with a hanger bracket being removed.</p>

No	Parts	Procedure	Remark
		<p>4) Loosen the 3 screws of Front Side.</p> <p>5) Disassemble the assembly Front Cover Part.</p> <p>6) Disconnect the Step Motor Wire as shown in picture.</p> <p>7) Detach the Wire Clamp fixed in Base Part.</p> <p>8) Detach the Front Cover assembly completely.</p>	    

No	Parts	Procedure	Remark
		<p>9) Loosen the screw what is fix with Base Part and Drain Pan. (Upper Side:2EA)</p> <p>10) Loosen the screw what is fix with Base Part and Drain Pan. (Lower Side:2EA)</p> <p>11) Detach the Drain Pan completely.</p>	  



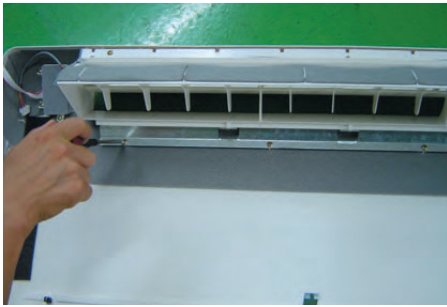

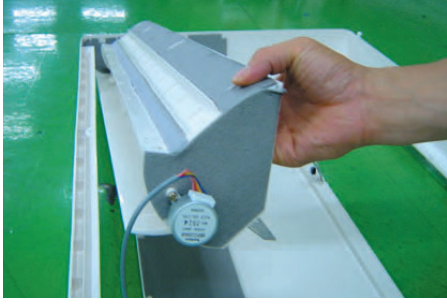
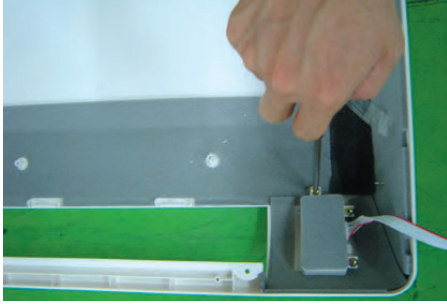
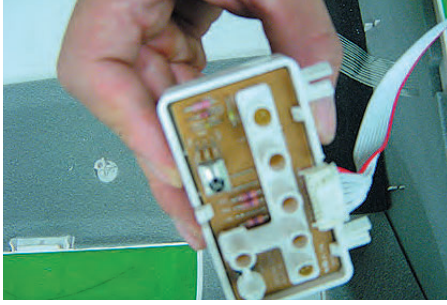
No	Parts	Procedure	Remark
		<p>1) Disconnect the Thermistor Wire as shown in picture. (white housing)</p> <p>2) Loosen the 2 screws shown in picture.</p> <p>3) Loosen the 2 screws shown in picture and remove Plastic Part. (white)</p> <p>4) Loosen the 2 screws shown in picture and remove Steel Bracket.</p> <p>5) Disassemble the 4 screws Steel Plate in rear side of the unit.</p>	    

No	Parts	Procedure	Remark
		<p data-bbox="456 293 839 320">6 Loosen the 2 screws as shown in picture.</p> <p data-bbox="456 645 807 696">7) Detach the Plastic Cover as shown in picture.</p> <p data-bbox="456 976 775 1003">8) Detach the Evaporator assembly.</p>	  

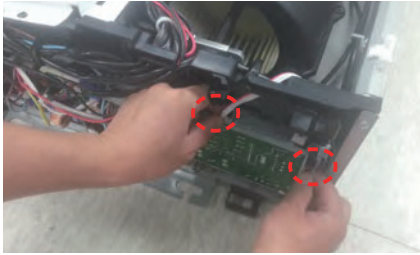
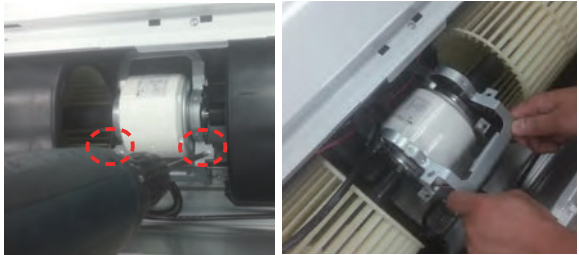

No	Parts	Procedure	Remark
5	Stepping Motor	<ol style="list-style-type: none"> 1) Loosen the 4 screws in rear side of Front Cover assembly as shown in picture. 2) Loosen the 2 screws as shown in picture. 3) Disassemble the Blade and Stepping Motor assembly and remove the 2 Screws Stepping Motor. 	  
6	Display PCB	<ol style="list-style-type: none"> 1) Loosen the 3 screws in rear side of Front Cover assembly as shown in picture. 2) Disassemble Display PCB assembly and Disconnect Wire. 3) Disassemble the Display PCB. 	 

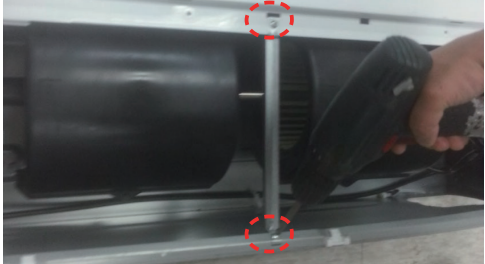

■ AM112/140JNCDKH/EU

No	Parts	Procedure	Remark
1	Electrial Part	<p>1) Open the Grille by sliding 4 position and removing 4 screws.</p> <p>2) Detach the Air Inlet Grille.</p> <p>3) Detach the Cover side by removing 1 screw and sliding Cover.</p> <p>4) Open the cover of Component Electrical Box by removing 2 screws.</p> <p>5) Open the cover of Terminal block Box by removing 2 screws</p>	

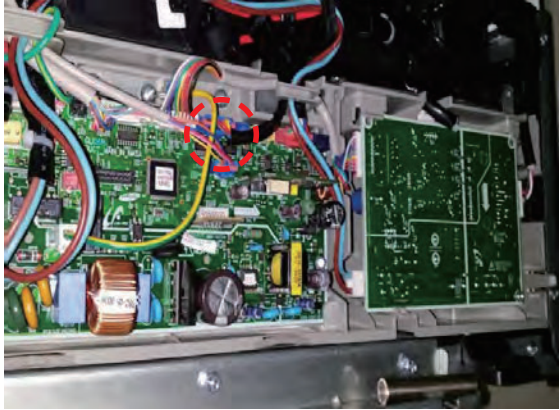
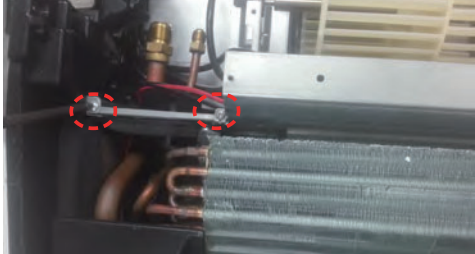

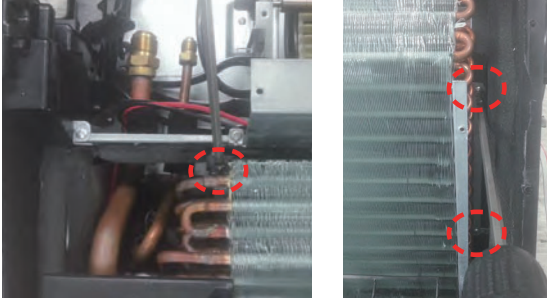
No	Parts	Procedure	Remark
2	Fan & Motor	<p>1) Disconnect 2 wires of Motor.</p> <p>2) Detach Holder Motor by removing 2 screws.</p> <p>3) Detach the Upper case of Fan. (AM112JNCDKH : 3EA, AM140JNCDKH : 4EA)</p> <p>4) Detach Bracket Grille by removing 2 Screws. (AM112JNCDKH : 1EA, AM140JNCDKH : 2EA)</p>	    

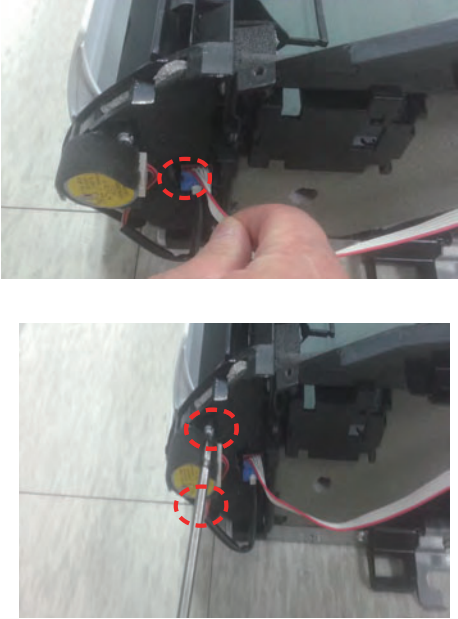

No	Parts	Procedure	Remark
3	Drain Pan	<p>1) Detach the Cabinet Front by removing 7 screws.</p> <p>2) Remove 1 screw in the middle of drain pan.</p> <p>3) Detach the Drian pan. Be careful that there might be some water left in the drain pan when you remove the drain pan.</p>	

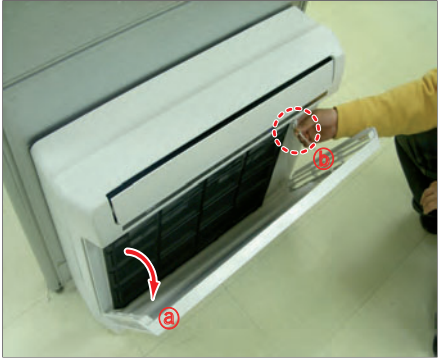
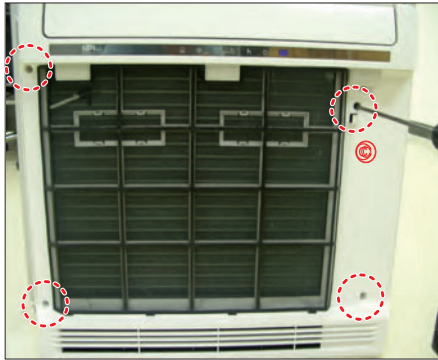

No	Parts	Procedure	Remark
4	Evaporator	<p>1) First, Separate the connector of the expansion valve.</p> <p>2) Detache the Cover Pipe by removing 2 screws.</p> <p>3) Detache the Cover Evap LF/RH by removing 4 screws.</p> <p>4) Detach the Evaporator assembly by removing 3 screws.</p>	   

No	Parts	Procedure	Remark
5	Stepping Motor	1) Detach the Connector. 2) Detache the Stepping Motor by emoving 2 screws.	
6	Holder Blade	1) Remove 4 screws at both side of the Holder blade.	

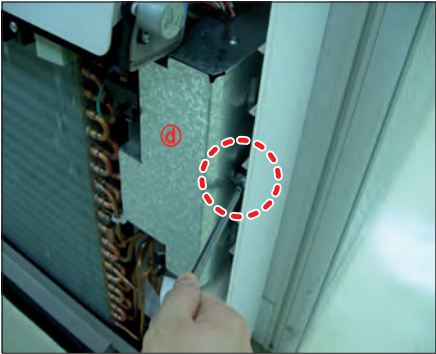
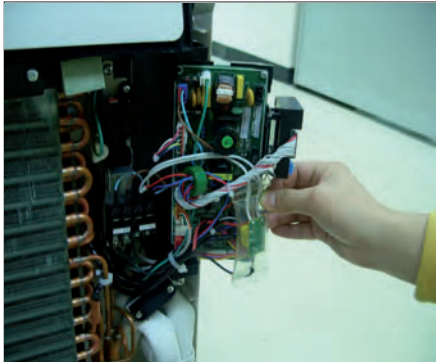
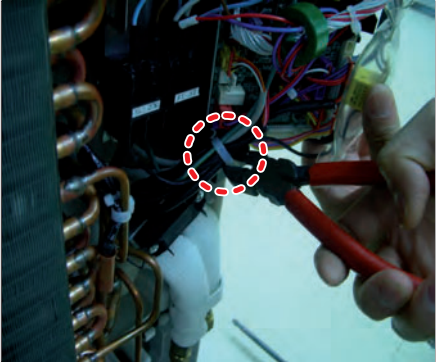

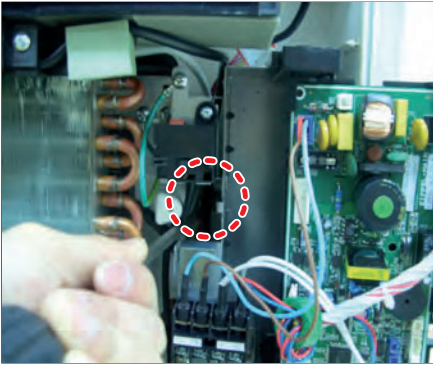
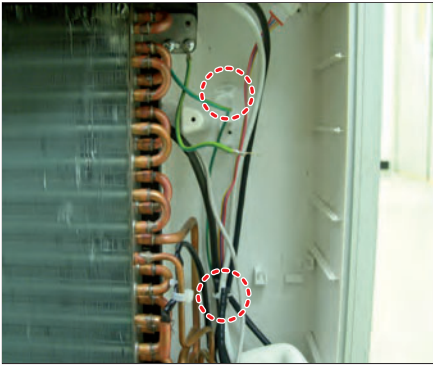

■ CONSOLE

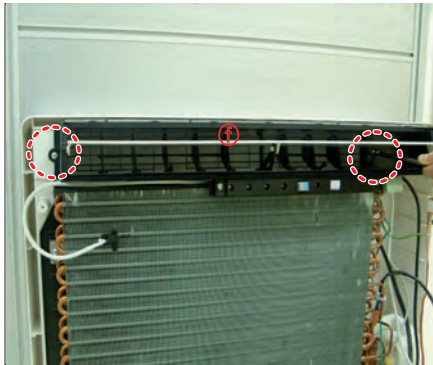
No	Parts	Procedure	Remark
1	Cabi Parts	<p>1) Open the Panel Front(a). Remove the Clip Wire(b).</p> <p>2) Release 4 screws on the Body Front(c).</p> <p>3) Open the Body Front(c) by pulling from bottom of the part.</p>	  

No	Parts	Procedure	Remark
2	Electrical Parts	<p>1) Open the cover of Control Box (④).</p> <p>2) Pull the PBA out along the slide guide.</p> <p>3) Cut the Cable tie.</p> <p>4) Pull all wires out from the PBA.</p>	   

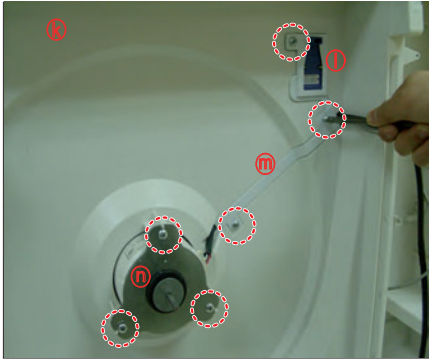

No	Parts	Procedure	Remark
		<p>5) Release the 2 screws. (one is top of the C-Box, the other is left of it)</p> <p>6) Release 2 Hold Wires and pull all wires out from it</p>	 
3	Blowing & Evap Part	<p>1) Pull the Bracket Pipe(④)out.</p> <p>2) Release 2 screws and pull Top Discharge Kit(⑤) out.</p>	 

No	Parts	Procedure	Remark
		<p>3) Release 2 screws and pull Bottom Discharge Kit(⑨) out.</p> <p>4) Disconnect the Step Motor wire(⑧) from the connect wire . This part is right side of the Bottom Discharge Kit(⑨).</p> <p>5) Pull Bottom Discharge Kit(⑨) Out from the bottom of it.</p> <p>6) Release 3 screws and pull the Evap out from top to bottom direction.</p>	   

No	Parts	Procedure	Remark
4	Fan Part	<p>1) Release 1 screw and pull the Bell Mouth (①) out.</p> <p>2) Release the Nut and pull Fan Turbo(①)out.</p> <p>3) Release 6 screw on the Body Back(⑫). Pull the Cap MPI(①), Bracket Wire(⑓) and Bracket Motor(⑒) out.</p> <p>4) Pull the MPI Kit(①) and Motor</p>	   

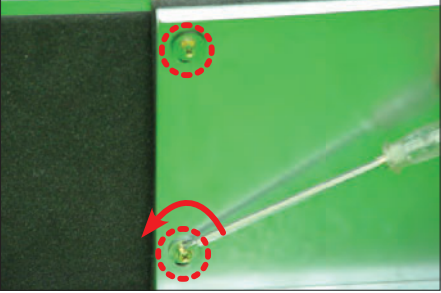

■ ERV PLUS

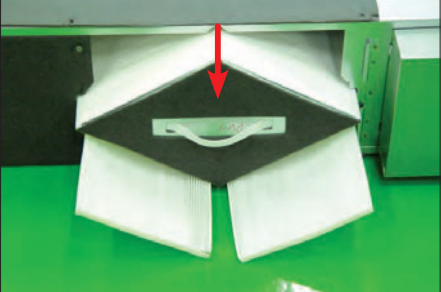
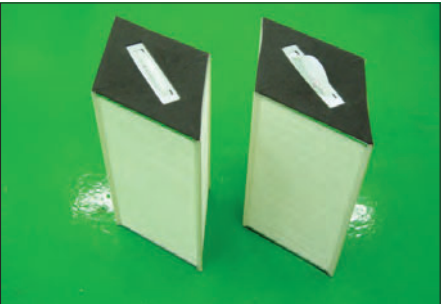
– All the procedure has to be verified because the cover should not open when the unit is installed.

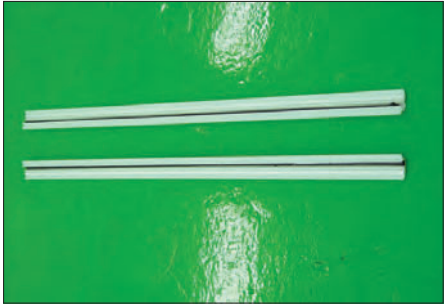
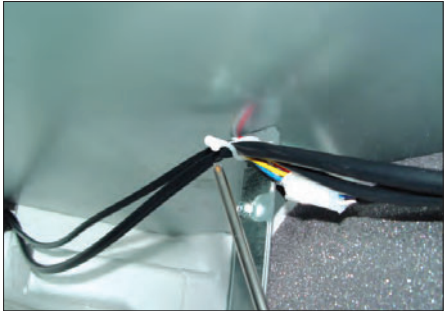
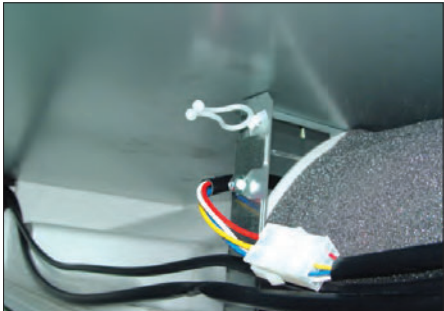
No	Parts	Procedure	Remark
1	ERV (Energy Recovery Ventilator)	1) Stop the air conditioner operation and shut off the main power. 2) Remove the unit from ceiling suspension. (Disassembly is not required when Fan, Motor, Element, Filter replacement or cleaning.)	
2	Cover Element	1) Remove the 2 bolts of the Cover Element. (Use +Screw Driver.) 2) Find the Element and 2 Dust Filters.	 
3	Ass'y Element Ass'y Filter	1) Detach Element and Filter from the unit. Make sure detach the Filter before the Element. 2) There are 2 Element within the product.	 

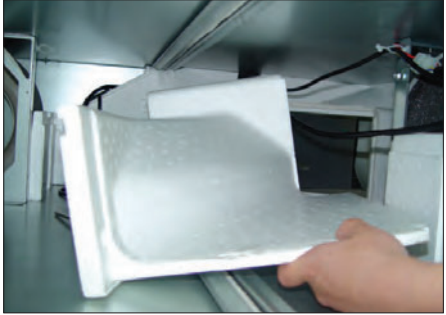
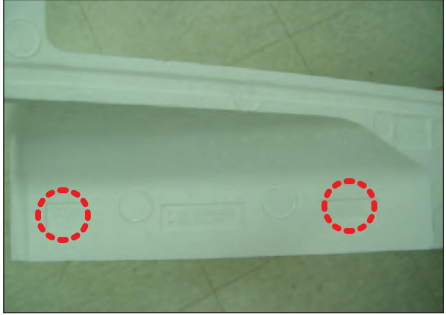
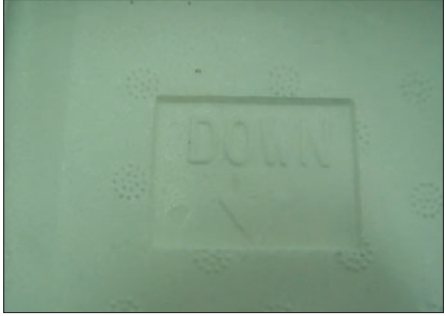
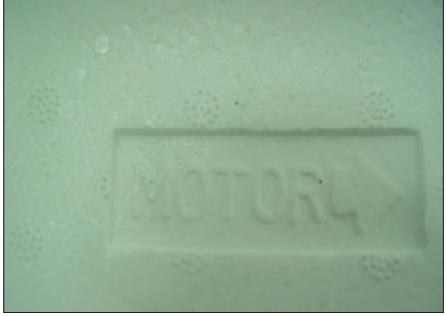

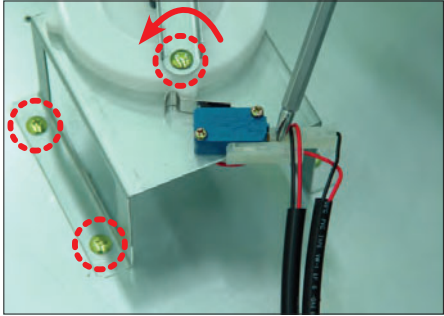
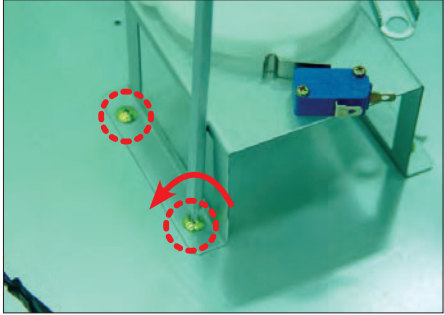
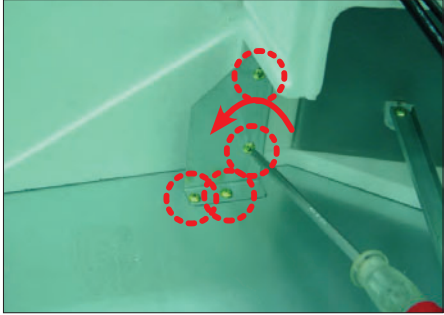
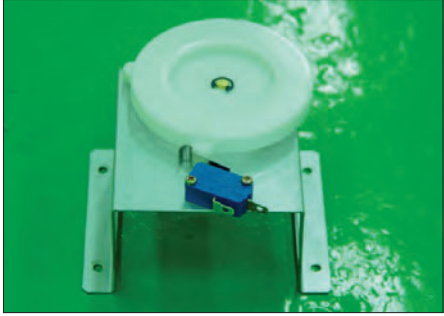
No	Parts	Procedure	Remark
4	Guide Element	1) Separate the guides fixing Element. (Use +Screw Driver.) 1 Guide is located at each left and right end of the product. Each guide is attached to the product with 1 bolt.	 
5	Ass'y Fan Parts	1) Separate motor connectors. 2) Loosen the holder fixing the motor wire by twisting it slightly. 3) 2 Motors are placed within the product for supply air and exhaust air.	 

No	Parts	Procedure	Remark
6	Cushion Mid	<p>1) As seen in the picture besides, pull out the EPS structure located at the center of exhaust air and supply air.</p> <p>2) Pull out the EPS structure through the inspection hole.</p> <p>3) Assemble the product by adjusting it with the direction, following the direction carved on the surface of Cushion Mid. Put the part written with Down↓ downwards and put the part with Motor→ towards the Motor when assembling the unit.</p> <p>⚠ Make sure not to break down EPS structure.</p>	    

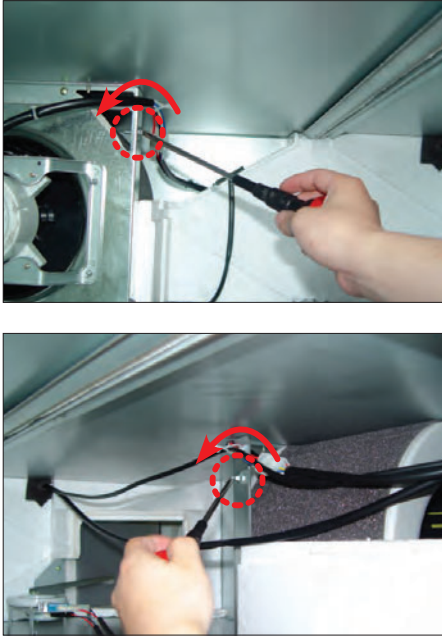
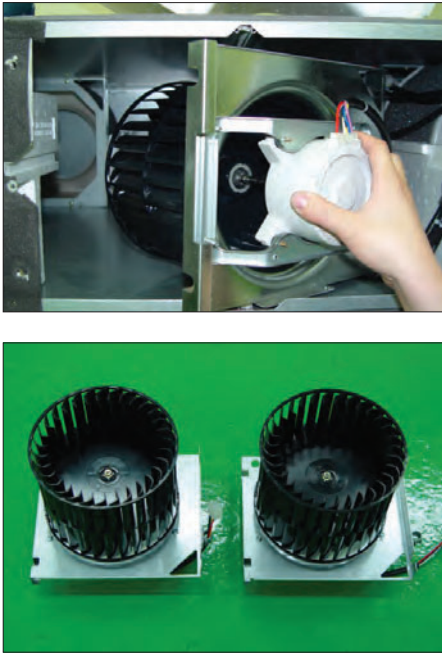
No	Parts	Procedure	Remark
7	Connector Damper Cam	<ol style="list-style-type: none"> 1) Separate the Damper from the unit. (Use +Screw Driver.) 2) Separate the connectors by holding their bodies and pulling them out. 3) Unscrew bolts attached to Bracket and Cam. (Use +Screw Driver.) 	    

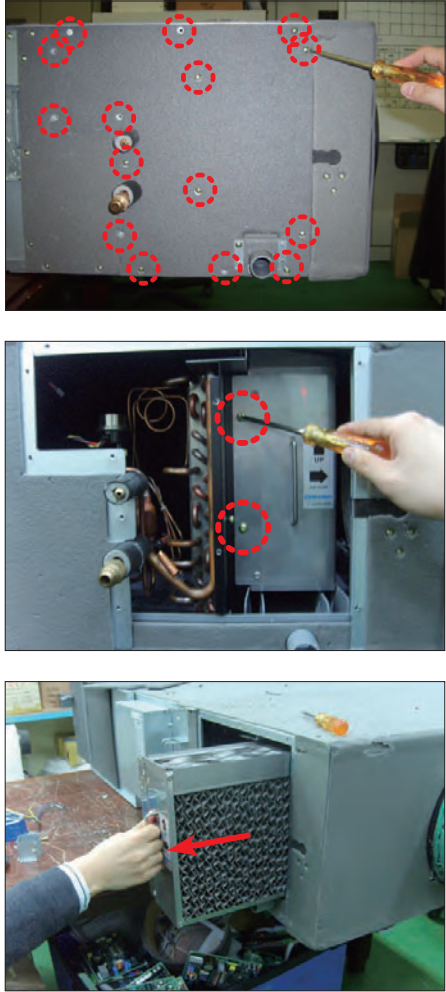
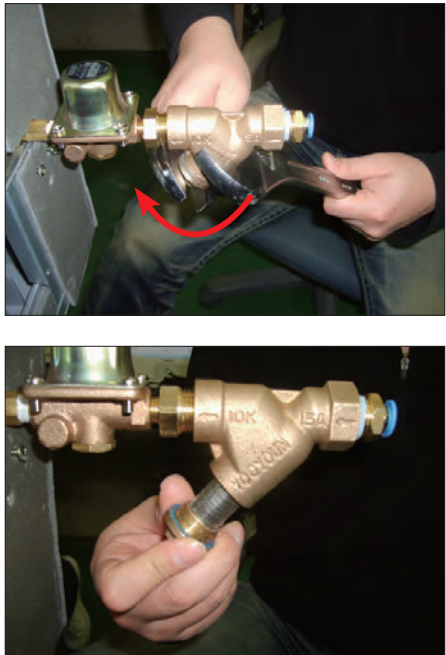
No	Parts	Procedure	Remark
8	Ass'y Fan Parts	<p>⚠ Ensure to separate the Damper before the Fan.</p> <p>1) Rotate bolts fixing the Bracket 10 turns. Input and outlet of the products have 2 bolts each. (Use +Screw Driver.)</p> <p>⚠ The bolts are not required to be removed.</p>	
9	Ass'y Bracket Motor	<p>1) Detach the whole Ass'y Blower Motor (which is made up of Fan, Motor, Bracket Motor, and Cover Bell Mouse) through the inspection hole.</p> <p>2) 2 Motors are placed within the unit for supply air and exhaust air.</p>	

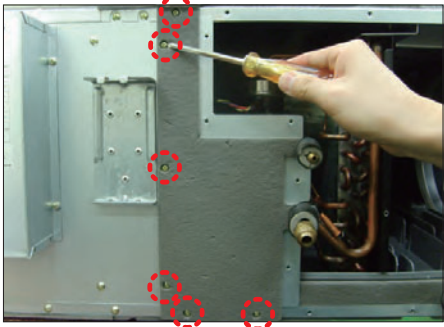
No	Parts	Procedure	Remark
11	Element Etc Humidifier	<p>1) Unscrew 15 screws from the Cover Humid to separate them from the product.</p> <p>2) Unscrew 2 screws from the Element Humidifier.</p> <p>3) Hold the handle of the Element Humidifier and pull to the direction indicated by the arrow to separate it from the product.</p>	
12	Ass'y Flow Valve	<p>1) Use 2 monkey spanners to hold the Ass'y Flow Valve as shown in the image, and rotate the monkey spanner on the right hand to the direction indicated by the arrow to unscrew the plug.</p> <p>2) Completely separate the plug by hand and remove foreign substances.</p>	

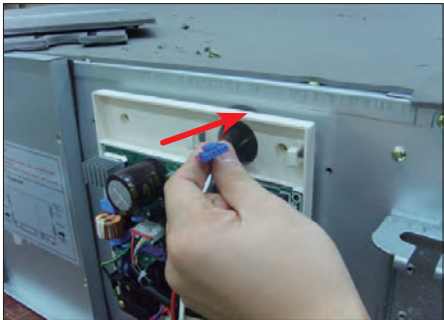
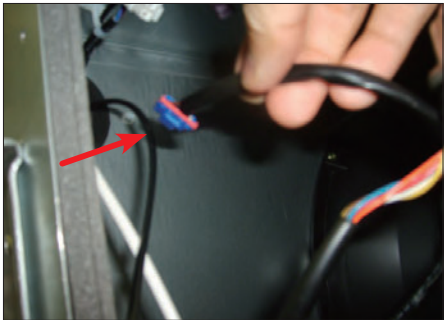
No	Parts	Procedure	Remark
13	Ass'y Evap Parts	<ol style="list-style-type: none"> 1) Unscrew 6 screws from the Cover Evap to separate them from the product. 2) Unscrew 4 screws from the Case PCB to separate them from the product. 3) Separate the PCB connection housing of the Valve Expan and move the housing as shown in the picture. 	    

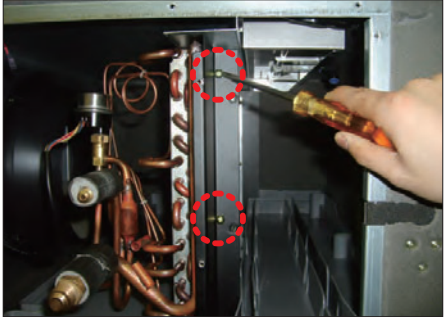
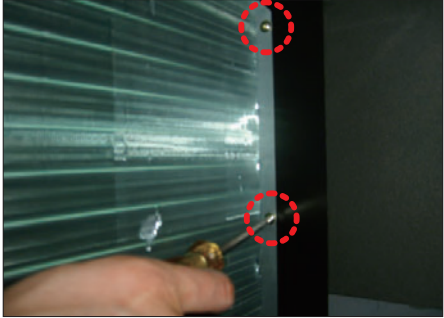
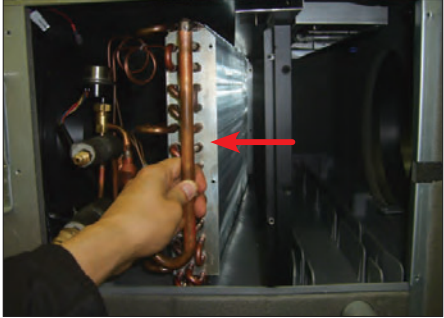
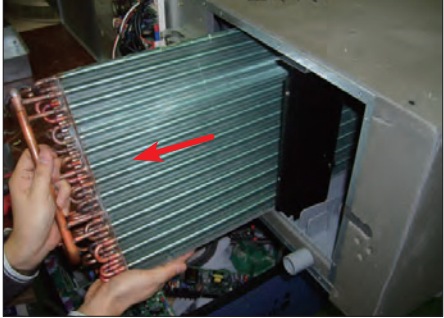
No	Parts	Procedure	Remark
		<p>4) Separate the 2 thermal sensors attached to Ass'y Evap.</p> <p>5) Unscrew 2 screws from the Support Evap L.</p> <p>6) Unscrew 2 screws from the Support Evap R.</p> <p>7) Pull the Ass'y Evap to the direction indicated by the arrow to separate it from the fixed part.</p> <p>8) Hold the end part of the Ass'y Evap and pull to the direction indicated by the arrow to separate it from the product.</p>	    

■ Floor Standin Type

– All the procedure has to be verified because the cover should not open when the unit is installed.

No	Parts	Procedure	Remark
1	Cabinnet	<p>1) Unscrew fixed screw of the upper part cabinet, and please separate</p> <p>2) Please separate front cabinet.</p>	

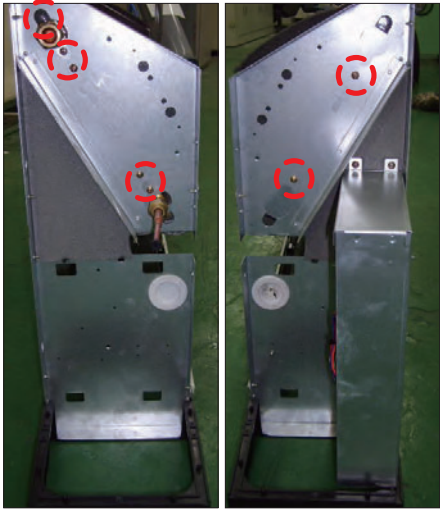
No	Parts	Procedure	Remark
2	Heat Exchanger	<p>1) Unscrew two fixed screws, and please separate heat exchanger cover.</p> <p>2) Unscrew fixed screw on both side of heat exchanger plate. And then pulls heat exchanger to the right side, and please separate.</p>	  
3	Drain Pan	<p>1) Please remove PLATE for fixation of DRAIN PAN located in the side.</p>	

No	Parts	Procedure	Remark
4	Motor & Fan	<p>1) Process hopes for DRAIN PAN isolation work in this work earlier.</p> <p>2) Unscrew MOTOR BRACKET fixation screw located in the front surface, and please separate.</p> <p>3) Unscrew MOTOR BRACKET fixation screw located in the side, and please separate.</p> <p>4) Separate out MOTOR BRACKET for front side.</p>	  

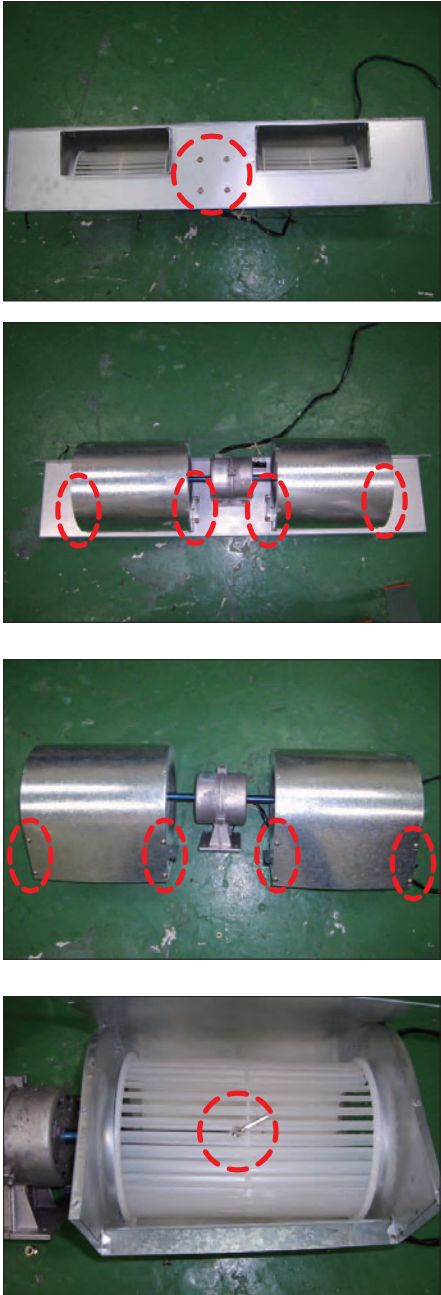
No	Parts	Procedure	Remark
4	Motor & Fan	<p>5) Unscrew fixed screw of MOTOR BRACKET and FAN CASING, and please separate.</p> <p>6) Unscrew fixed screw of FAN CASING, and please separate.</p> <p>7) Unscrew FAN and the fixed screw of the MOTOR axis, and please separate. (use Wrench)</p>	

■ Wall mount type

– All the procedure has to be verified because the cover should not open when the unit is installed.



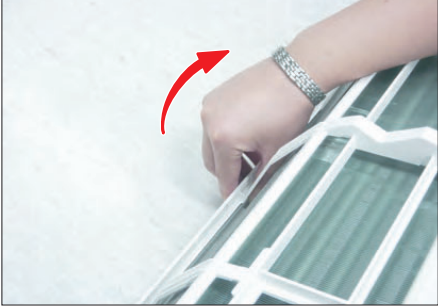
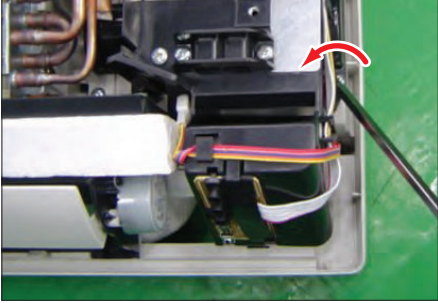
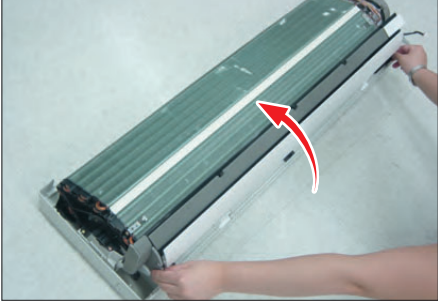

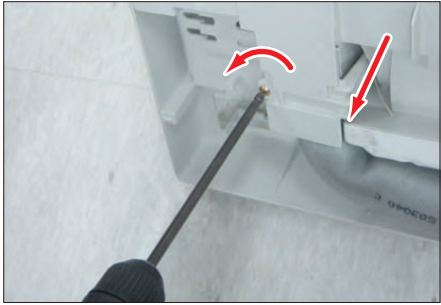
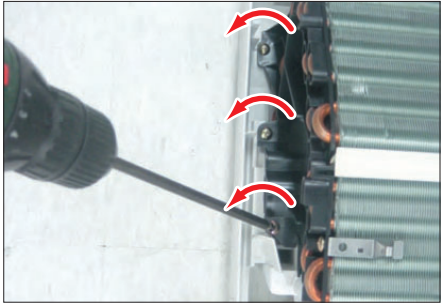
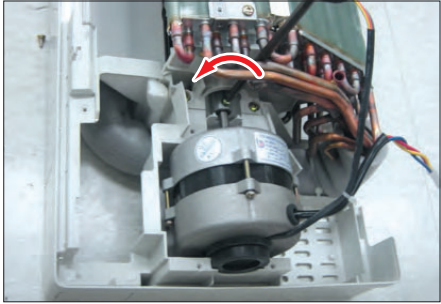
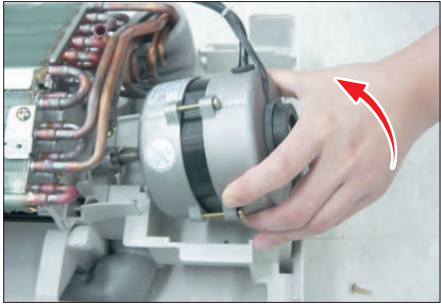
No	Parts	Procedure	Remark
1	Front Grille	<p>1) Stop the air conditioner operation and shut off the main power.</p> <p>2) Open the Front Grille by pulling right and left sides of the hook.</p> <p>3) Loosen 1 of the right screw(CCW) and detach the Terminal Cover. (Use +Screw Driver.)</p> <p>4) Detach the thermistor from the Front Grille.</p> <p>5) Loosen 2 fixing screws(CCW) of Front Grille.</p> <p>6) Unlock 3 hooks to fix Panel Front and Tray Drain. (Use +Screw Driver.)</p>	    

No	Parts	Procedure	Remark
		<p>7) Unlock 3 hooks to fix Panel Front and Back-Body.</p>	
2	Control-In (Main PCB)	<p>1) Take all the connector of PCB upper side out. (Inclusion Power Cord) 2) Detach the outdoor unit connection wire from the Terminal Block. 3) Loosen 4 fixing screws(CCW) of Ass'y Control-In. (Use +Screw Driver.)</p> <p>⚠ You can disassembly Ass'y Control In without evaporator disassembled.</p>	
3	Tray Drain	<p>1) Pull Tray Drain out from the Back Body.</p>	

No	Parts	Procedure	Remark
4	Heat Exchanger	<ol style="list-style-type: none"> 1) Loosen 2 fixing earth screws(CCW) of right side. (Use +Screw Driver.) 2) Detach the Connection Pipe. 3) Detach the Holder Pipe at the rear side. 4) Loosen the 4 fixing screws(CCW) of right and left side. (Use +Screw Driver.) 5) Lifting the Heat Exchanger up a little to push the up side for separation from the indoor unit. <p style="color: red; font-weight: bold;">⚠ First, check Comp. Down and then disconnect the connection pipes before you disassemble the Evaporator from indoor unit.</p>	 
5	Fan Motor & Cross Fan	<ol style="list-style-type: none"> 1) Loosen the fixing screw(CCW). (Use +Screw Driver.) 2) Detach the Fan Motor from the Fan. 3) Detach the Fan From the left Holder Bearing. 	 



■ Wall Mounted type (Boracay)

– All the procedure has to be verified because the cover should not open when the unit is installed.

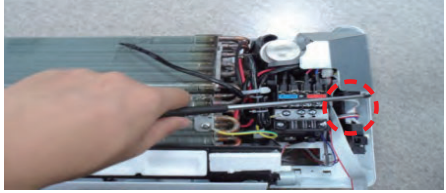
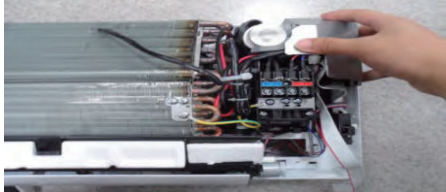
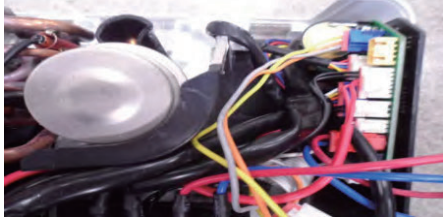
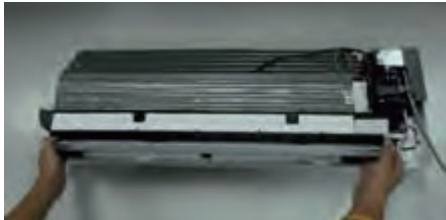
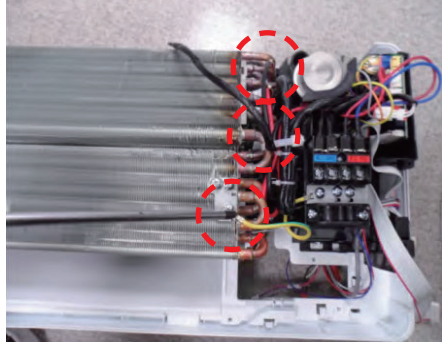

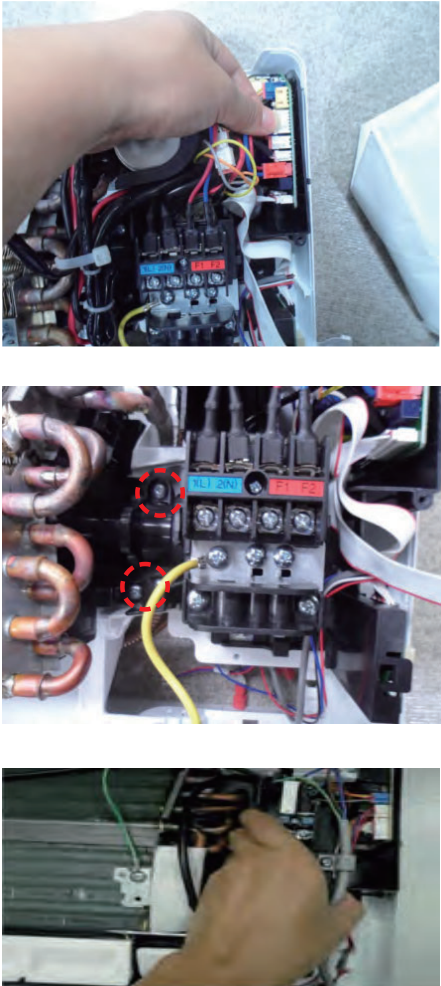
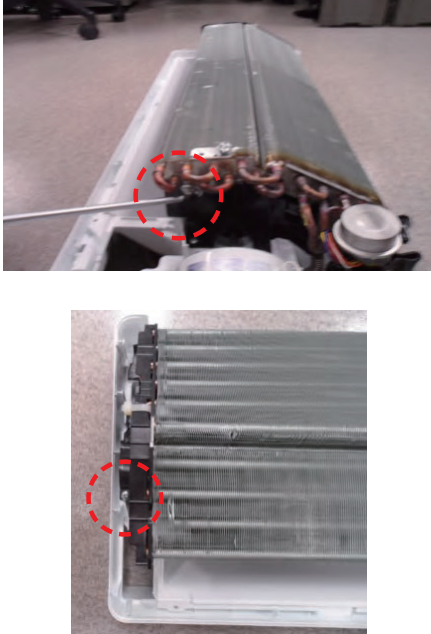

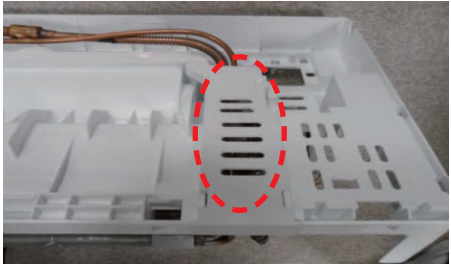
No	Parts	Procedure	Remark
1	Front Grille	<ol style="list-style-type: none"> 1) Stop the air conditioner operation and shut off the main power. 2) Open the FRONT-GRILLE and pull out from the PANEL-FRONT. 3) Detach COVER-TERMINAL from the PANEL-FRONT. (Use +Screw Driver.) 4) Loosen connector wire (white) and detach the temperature sensor wire. 5) To detach the FRONT-PANEL the main frame unfasten 2 screw at the gutter. (Use +Screw Driver.) 6) Take off the FRONT-PANEL, lifting up the button. 	    

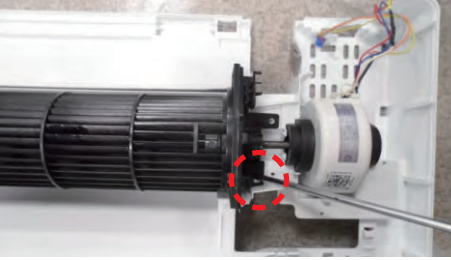
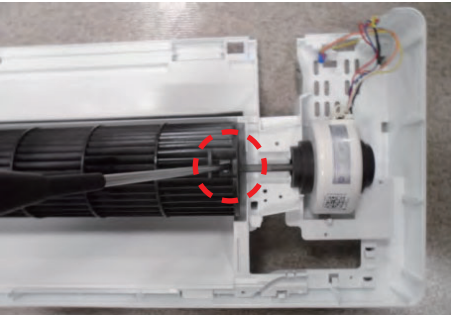



No	Parts	Procedure	Remark
2	TRAY DRAIN	<ol style="list-style-type: none"> 1) Unfasten the screw. 2) Detach COVER- CONTROL from the CASE- CONTROL. 3) Loosen stepping motor wire and detach the hook of main frame. 4) To detach TRAY-DRAIN from the main frame pull the bottom of the TRAY - DRAIN towards you. 	   
3	Contol-box	<ol style="list-style-type: none"> 1) Unfasten the earth screw. (use + Screw Driver) 2) Detach the temperature sensor. 	

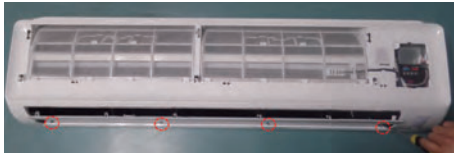

No	Parts	Procedure	Remark
		<p>3) Disconnect the Connector Wire that is connected to the indoor unit's PBA from the PBA.</p> <p>4) Unfasten the 2 screw. (use + Screw Driver)</p> <p>5) Take off the CASE-CONTROL from the main frame.</p>	
3	EVAPORATOR	<p>1) Unfasten the screw at the right side. (use+ Screw Driver)</p> <p>2) Unfasten the screw at the LEFT side. (use+ Screw Driver)</p>	

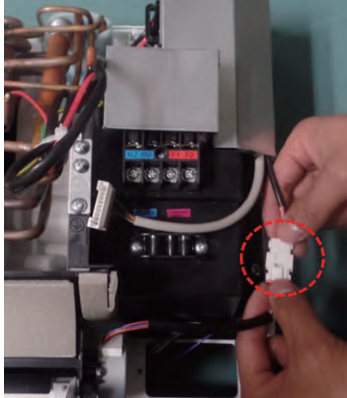
No	Parts	Procedure	Remark
		<p>3) Detach the HOLDER PIPE.</p> <p>4) Take off the EVAPORATOR from the main frame.</p>	 
5	FAN MOTOR & CROSS FAN	<p>1) Unfasten the screw. (use+ Screw Driver)</p> <p>2) Take off the ??? from the main frame.</p> <p>3) Unfasten the screw a little. (use + Screw Driver)</p> <p>4) Pull the CROSS-FAN & FAN MOTOR from the main frame.</p>	 

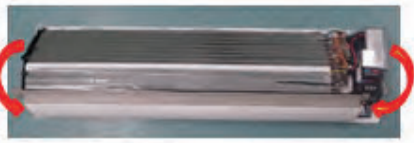
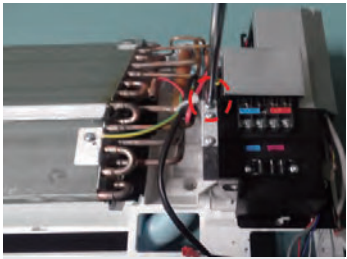
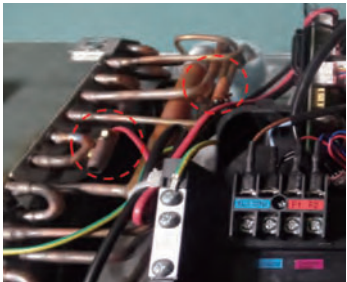
■ Wall Mounted type (MAX)

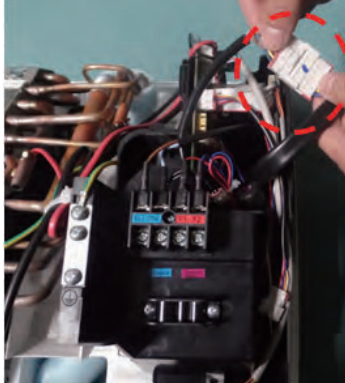

No	Parts	Procedure	Remark
1	Front Grille	<ol style="list-style-type: none"> 1) Stop the air conditioner operation and shut off the main power. 2) Open the FRONT-GRILLE and pull out from the PANEL-FRONT. 3) Detach COVER-TERMINAL from the PANEL-FRONT. (Use +Screw Driver.) 4) Loosen connector wire (white) and detach the temperature sensor wire. 5) To detach the FRONT-PANEL the main frame unfasten 2 screw at the gutter. (Use +Screw Driver.) 6) Take off the FRONT-PANEL, lifting up the button. 	    

No	Parts	Procedure	Remark
2	TRAY DRAIN	<ol style="list-style-type: none"> 1) Loosen stepping motor wire and detach the hook of main frame. 2) To detach TRAY-DRAIN from the main frame, pull the bottom of the TRAY-DRAIN towards you. 3) To detach TRAY-DRAIN from the main frame , pull the bottom of the TRAY-DRAIN towards you. 	  
3	CONTROL IN	<ol style="list-style-type: none"> 1) Unfasten the earth screw.(use + ScrewDriver) 2) Detach the temperature sensor and Humidity sensor. 3) Detach the temperature sensor. 	   

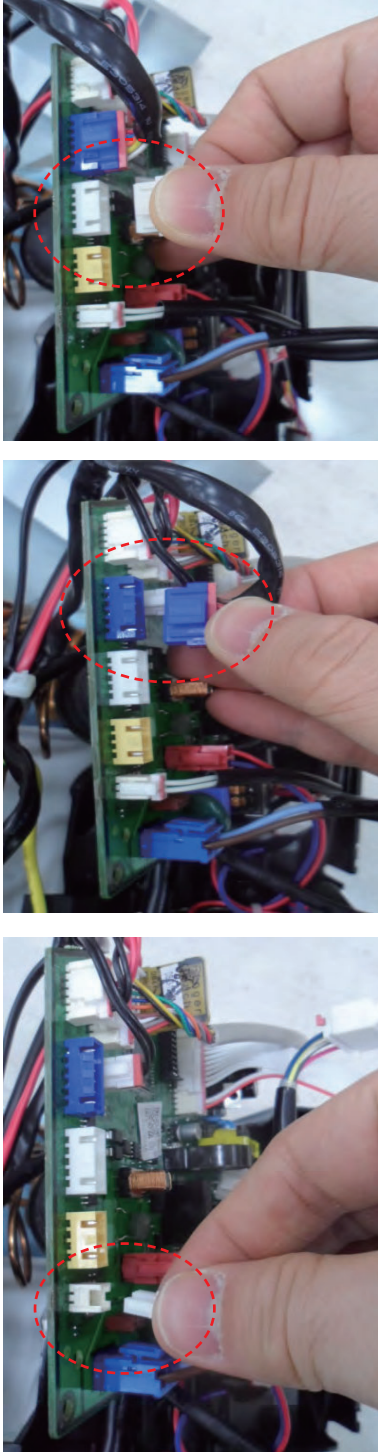

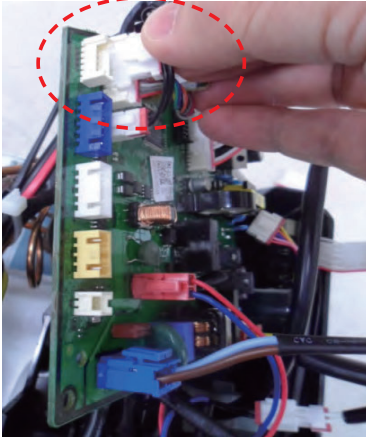
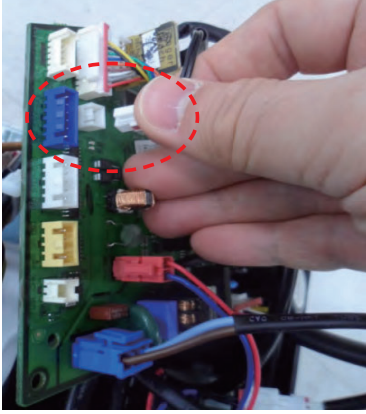
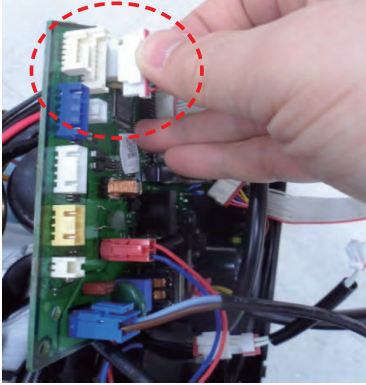
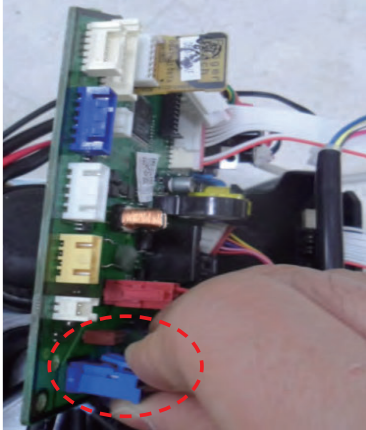

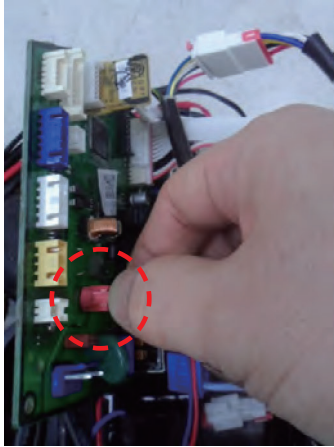
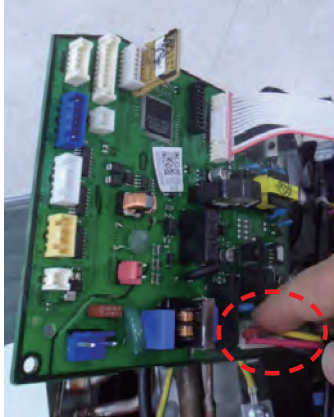
No	Parts	Procedure	Remark
		<p>4) Loosen MOTOR wires(white).</p> <p>5) Take off the CASE-CONTROL from the main frame. (use + Screw Driver)</p>	 

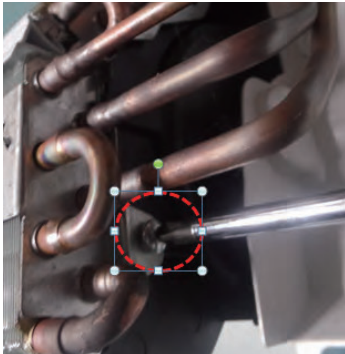
No	Parts	Procedure	Remark
4	PBA	<p>1) Loosen the STEP UP/DOWN connector(CN802).</p> <p>⚠ When you separate the connector, pull pressing the locking button.</p> <p>2) Loosen the EEV connector(CN801).</p> <p>⚠ When you separate the connector, pull pressing the locking button.</p> <p>3) Loosen the FUSE CHK connector (CN140).</p> <p>⚠ When you separate the connector, pull pressing the locking button.</p>	

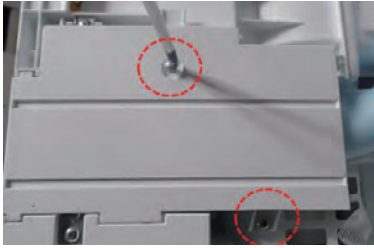
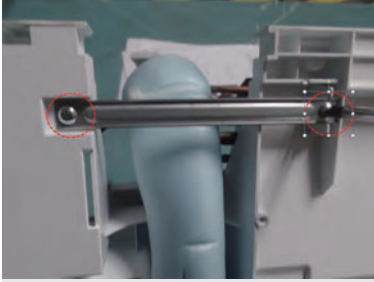
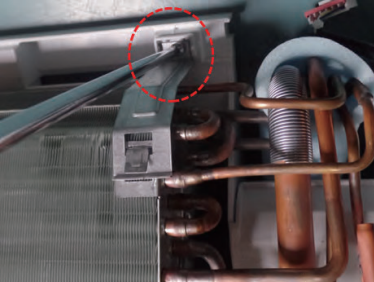
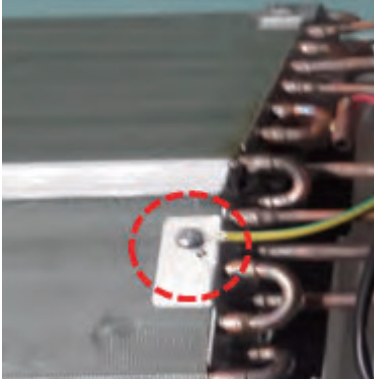

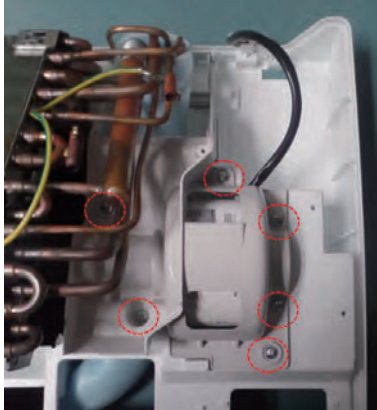

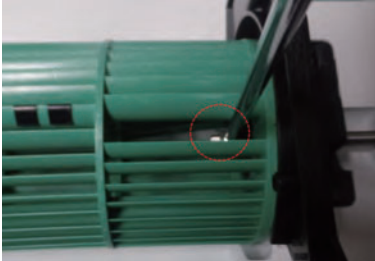
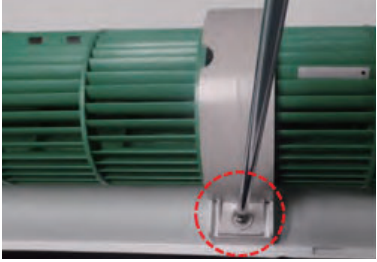
No	Parts	Procedure	Remark
		<p>4) Loosen the EVA IN/OUT connector. (CN403)</p> <p>⚠ When you separate the connector, pull pressing the locking button.</p>	
		<p>5) Loosen the Humidity sensor connector(CN401). → Option connector.</p> <p>⚠ The terminal is locking type. So, when you separate terminals, pull pressing the button.</p>	
		<p>6) Loosen the DISPLAY connector. (CN501).</p> <p>⚠ The terminal is locking type. So, when you separate terminals, pull pressing the button.</p>	
		<p>7) Loosen the POWER connector.</p> <p>⚠ When you separate the connector, pull pressing the locking button.</p>	

No	Parts	Procedure	Remark
		<p>8) Loosen the COMM wire connector(CN303).</p> <p>⚠ When you take off the PBA, don't touch the components. Please hold the PBA both side.</p> <p>9) Loosen the Motor connector(CN701).</p> <p>⚠ When you separate the connector, pull pressing the locking button.</p> <p>10) Take off the main PBA from the ASS'Y Control in.</p> <p>⚠ When you take off the PBA, don't touch the components. Please hold the PBA both side.</p>	  
5	EVAPORATOR	<p>1) Unfasten the screw at the right side. (use + ScrewDriver)</p>	



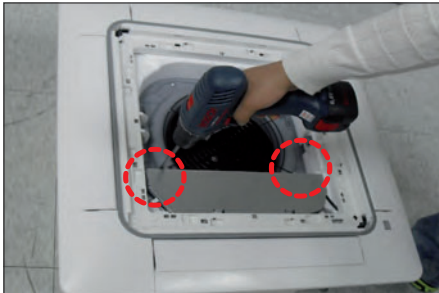

No	Parts	Procedure	Remark
		<p>2) Unfasten the screw at the left side. (use + ScrewDriver)</p>	
		<p>3) Detach the HOLDER PIPE. (use + Screw Driver)</p>	
		<p>4) Detach the BRACKET-EVAP. (use + Screw Driver)</p>	
		<p>5) Detach the HOLDER EVAP. (use + Screw Driver)</p>	
		<p>6) Loosen 1 fixing earth screw right side. (use + Screw Driver)</p>	



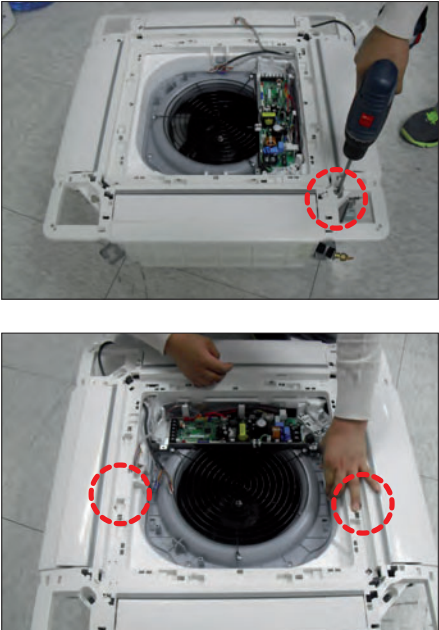
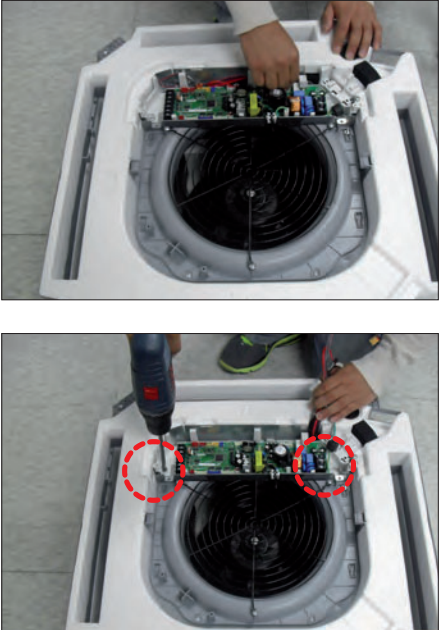

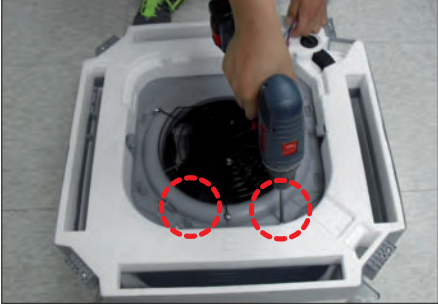
No	Parts	Procedure	Remark
6	FAN MOTOR & CROSS FAN	<ol style="list-style-type: none"> 1) Loosen 6 fixing screws of HOLDER-MOTOR. 2) Unfasten the screw a little. (use + Screw Driver) 3) Unfasten the screw a little and pull the MOTOR FAN to the right side. (use + Screw Driver) 4) Loosen 1 fixing screws of HOLDER-FAN. (use + Screw Driver) 5) Unfasten the screw a little. (use + Screw Driver) 	    

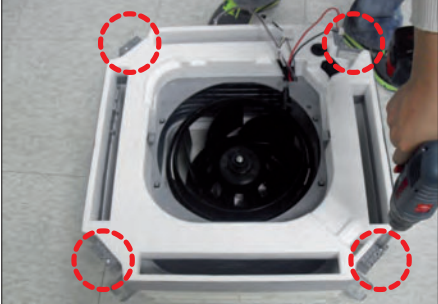

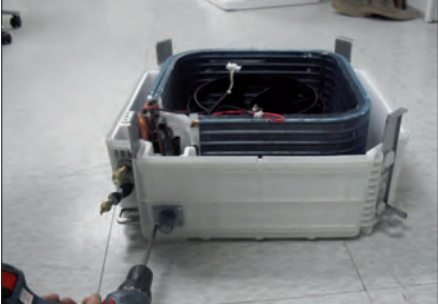

■ Global 4Way Cassette type(600x600)

No	Parts	Procedure	Remark
1	Panel	<p>1) Pull both hooks and take the grille downward. Two safety clips are mounted to the front grille to prevent it from dropping.</p> <p>2) Detach the safety clip and take up the grille.</p> <p>3) Remove the 2 fixed screws to remove the Control-Box Cover. (Use +Screw Driver)</p> <p>4) Remove the Remocon-Receiver and Blade Connector Wire from the PBA. (3EA)</p> <p>5) Push the 4 panel corners and cover downwards to remove it.</p>	    

No	Parts	Procedure	Remark
		<p>6) Disassemble the bolts that are assembled with the indoor unit at the 4 panel corners.</p> <p>7) Press the Hangers at both sides of the panel inwards, to remove it from the indoor unit's hook. Remove the panel from the indoor unit.</p>	
2	Control-Box	<p>1) Disconnect the Connector Wire that is connected to the indoor unit's PBA</p> <p>2) Unscrew the 2 fixed screws on both sides of the Control Box, and disassemble the Control Box from the indoor unit. (Use +Screw Driver)</p>	

No	Parts	Procedure	Remark
3	Bell-Mouth	<p>1) Unscrew the screw fixed on the Bell-Mouth. (Use +Screw Driver)</p> <p>2) Push the Bell-Mouth in the direction opposite to where it's installed on the Control-Box to remove it.</p>	 
4	Drain Pan	<p>1) Unscrew the screws on the 4 corners of the indoor unit. (Use +Screw Driver)</p> <p>2) Remove the Drain Pan from the indoor unit.</p>	 

No	Parts	Procedure	Remark
5	Drain Pump & Hose	<p>1) Remove the 2 fixed screws and disconnect the white drainage hose from the Drain Pump. (Use +Screw Driver)</p> <p>2) Remove the 2 screws and take the Drain-Hose out from the indoor unit to disassemble the transparent Drain-Hose fixed on the side of the indoor unit. (Use +Screw Driver)</p>	  
6	Evap. Temperature Sensor	<p>1) Use your hand to remove the temperature sensor attached to the Evap Pipe along with the fixing clip.</p>	

No	Parts	Procedure	Remark
7	Fan & Motor	<p>1) Turn the hexagonal nut attached to the top of the Fan counterclockwise to remove it. Take the Fan out of the Motor.</p> <p>2) Turn the three hexagonal nuts on the Motor counterclockwise to remove the nuts. Take the Motor Wires attached to these three locations out with your hands prior to removing the Motor.</p>	  
8	Evaporator	<p>1) Remove the screws of the Steel Holder Evaps that are used to fix the Heat Exchanger, and then remove it. (Use +Screw Driver)</p> <p>2) Remove the 2 fixing screws of the Partition Evap at the Heat Exchanger's In/Out Pipe. (Use +Screw Driver)</p>	 

No	Parts	Procedure	Remark
		<p>3) Remove the screw of the Cover Pipe that is used to fix the In/Out Pipe. Remove the In/Out Pipe. (Use +Screw Driver)</p> <p>4) Remove the Heat Exchanger from the indoor unit's cabinet.</p>	  

■ AM160FNBDEH/320FNBDEH/500FNBDEH

No	Parts	Procedure	Remark
1	CABINET TOP/FRONT/BACK	<p>⚠ Carried out after shut off the power before disassembly.</p> <p>1) Remove the 4 screws from the left and right of the CABI TOP, and then separate it.</p> <p>2) Remove the 2 screws from the ASSY CABI FRONT upper part and then separate the ASSY CABI FRONT upward after incline CABINET forward.</p> <p>3) Separate the ASSY CABI BACK by method such as ASSY CABI FRONT.</p>	

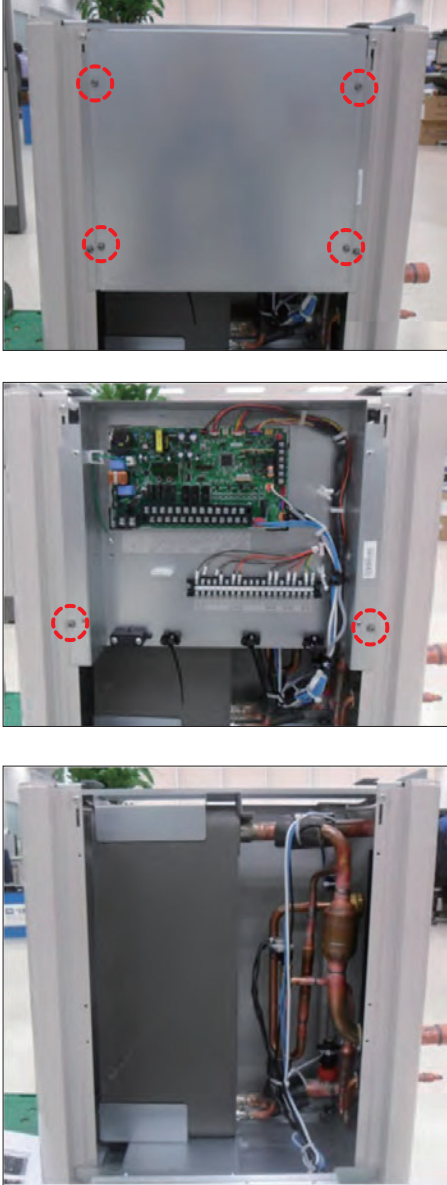
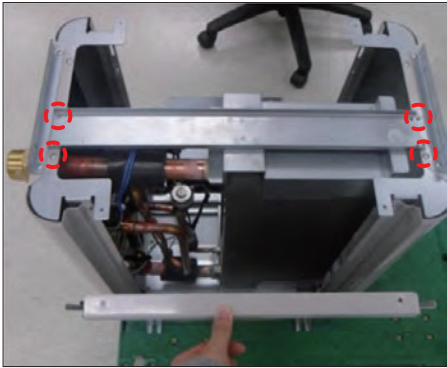

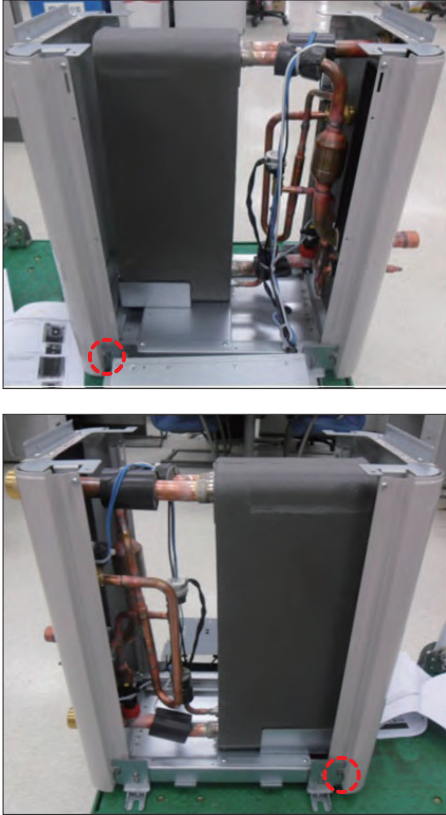
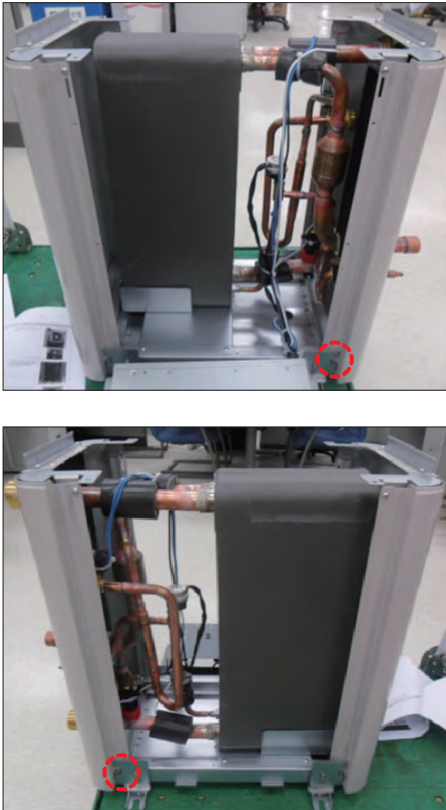

No	Parts	Procedure	Remark
2	Control BOX	<p>4) Remove the 4 screws and then pull the COVER CONTROL to upward, and separate it.</p> <p>5) Remove the 2 screws from the ASSY CONTROL BOX.</p> <p>6) Separate the C/BOX from the product.</p>	
3	CABINET LF/RH	<p>7) Remove the 4 screws from the BRACKET COND UP, and separate it.</p>	



No	Parts	Procedure	Remark
		<p>8) Remove the 2 screws from the front and rear and then separate the ASSY CABI LF to side.</p>	
		<p>9) Remove the 2 screws from the ASSY CABI RH.</p>	

No	Parts	Procedure	Remark
4	ASSY PHE	1) Remove the 8 screws from the side of the ASSY CABI RH.	 <p>The top photograph shows the front panel of the ASSY CABI RH. It is a white rectangular unit with several ports and labels. Eight screws are circled in red, indicating they are to be removed. The labels 'WATER OUT' and 'WATER IN' are visible. The bottom photograph shows the ASSY CABI RH removed from the ASSY PHE, revealing the internal components, including a large black heat exchanger and various pipes and valves.</p>

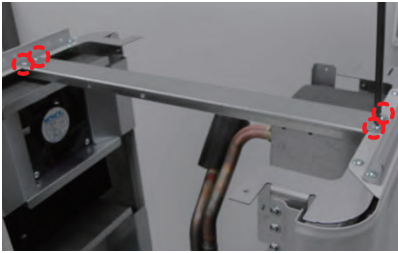

■ AM160/250FNBFEF, AM160/250FNBFGF

No	Parts	Procedure	Remark
1	CABINET	<p>⚠ Stop the air conditioner operation and shut off the main power.</p> <p>1) Remove the 4 screws in CABI TOP left/right side and then separate it.</p> <p>2) Remove the 2 screws in ASSY CABI FRONT upper part. Tilt the CABINET forward and then separate upward.</p> <p>3) ASSY CABI BACK separate by method such as upside.</p> <p>4) Remove the 4 screws from COVER CONTROL and then pull it forward.</p>	

No	Parts	Procedure	Remark
		<p>5) Remove the 2 screws and open the HINGE PBA PLATE.</p> <p>6) Pull the SLIDE PBA and then separate the WIRE CONNECTOR.</p> <p>7) Remove the 6 screws from the ASSY CONTROL BOX.</p> <p>8) Remove the 4 screws from the BRACKET UPPER and separate it.</p>	    

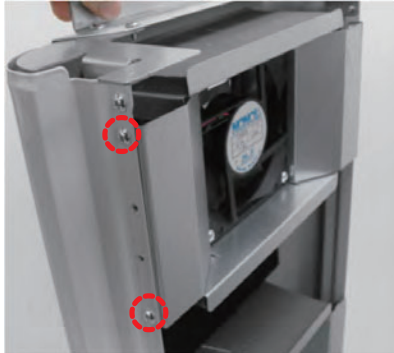

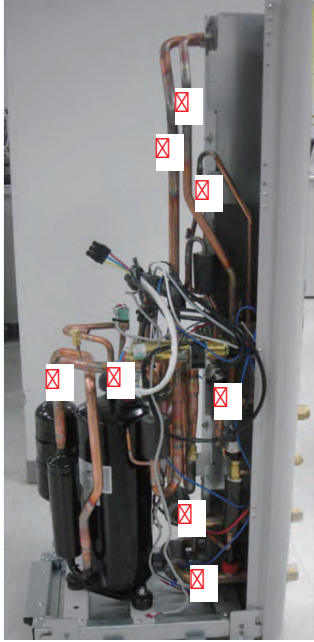

No	Parts	Procedure	Remark
		<p>9) Loosen the CONDUIT from ASSY CONTROL COOLER IN lower part and then separate the TEMP SENSOR.</p>	
		<p>10) Remove the 2 screws from front and rear parts. Remove the 2 screws from side part and then separate the ASSY CABI LF in the direction of the side.</p>	
		<p>11) Replace of REACTOR and FAN is available after remove the ASSY CABI LF.</p>	

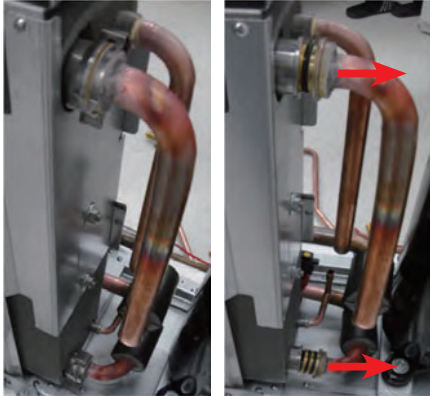
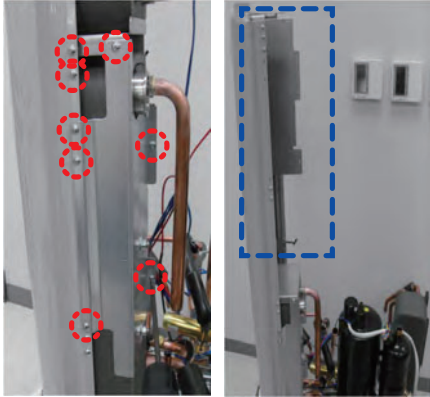
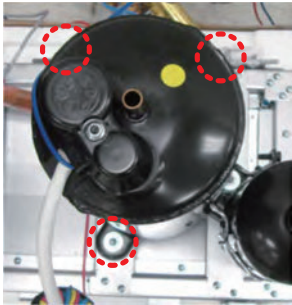





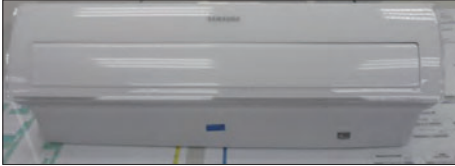

No	Parts	Procedure	Remark
		<p>12) When need CONDUIT control for temperature sensor : Remove the 4 screws in ASSY CONTROL COOLER side.</p>	

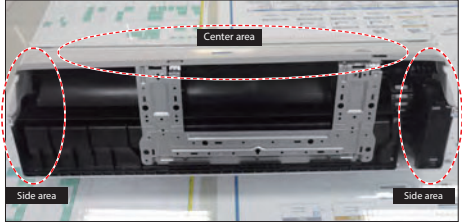

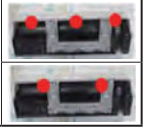
No	Parts	Procedure	Remark
2	PIPE	<p>1) Remove the COMP FELT</p> <ul style="list-style-type: none"> ① CLOTH COMP SOUND ② CLOTH COMP TOP ③ FELT COMP SOUND ④ FELT COMP TOP <p>2) When you need to replace parts, weld zone 8 places that should separate.</p> <ul style="list-style-type: none"> ■ Replace the COMP <ul style="list-style-type: none"> ① COMP DISCHARGE ② ACCUM IN ■ Replace the ASSY EVAP <ul style="list-style-type: none"> ③ R134a EVAP IN ④ R134a EVAP OUT ⑤ R410a EVAP IN ⑥ R410a EVAP OUT ■ Replace the ASSY COND <ul style="list-style-type: none"> ⑦ R134a COND IN ⑧ R134a COND OUT <p>⚠ ▶ Separate Pipe by welding machine after extract perfectly refrigerant of Compressor inside in case of separate COMPRESSOR, ASSY COND and PIPE.</p> <p>▶ When replace the ASSY EVAP : Outdoor unit is commissioning (PUMP DOWN the refrigerant) and then separate a pipe using welding machine.</p>	  

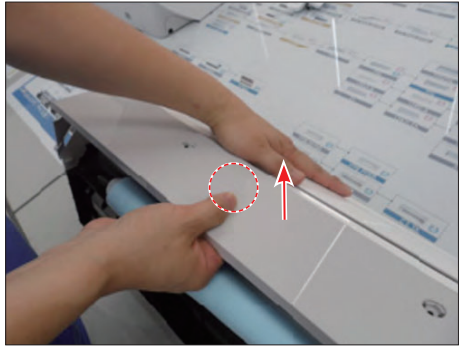
No	Parts	Procedure	Remark
3	PHE & COMP	<p>1) When separate the water piping and refrigerant nipple : Remove the M5 screws from the ASSY CABI SIDE LH.</p> <p>2) When separate the water piping : Remove the QUICK FASTENER and then moved horizontally and separate it.</p> <p>3) When separate the ASSY COND and ASSY EVAP : Remove the 6 screws from the BRACKET PHE.</p> <p>4) When Replace the COMP : Remove the 3 nuts from the FOOT part.</p>	   

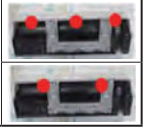
■ Wall Mounted type(A3050)

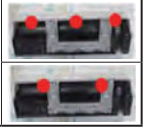
No	Parts	Procedure	Remark
1	PANEL-FRONT	<p>1) Stop the driving of air conditioner and shut off main power supply.</p> <p>2) Detach FILTER PRE from the PANEL FRONT.</p> <p>3) Cover Panel is assembled on bottom of indoor unit as shown in the figure. Remove the Cap Screw as shown on the right side and then remove the screw and separate the Cover Panel.</p>	   

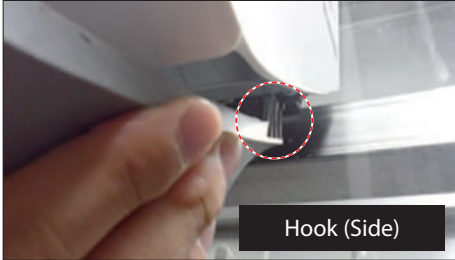
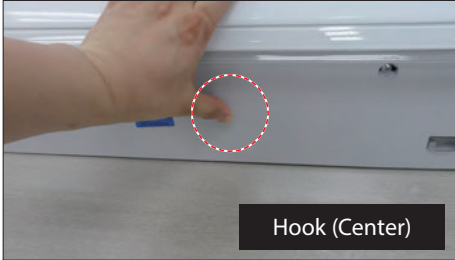
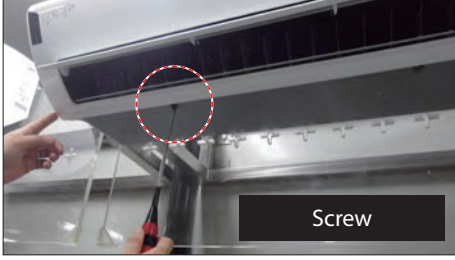
No	Parts	Procedure	Remark						
		<p>4) Cover Panel is fixed to body by Hook in center area and side area.</p>	 <table border="1" data-bbox="938 555 1401 712"> <thead> <tr> <th colspan="2">HOOK</th> </tr> </thead> <tbody> <tr> <td>015/022/028/ 036/045</td> <td></td> </tr> <tr> <td>056/071/082</td> <td></td> </tr> </tbody> </table> <p>5) Separate the hook after pushing both end of Cover Panel as shown in the figure. (Watch out for the damage of the hook)</p>  <p>6) Raise front part upward obliquely as shown in the figure and then remove the hooks.</p>  	HOOK		015/022/028/ 036/045		056/071/082	
HOOK									
015/022/028/ 036/045									
056/071/082									

No	Parts	Procedure	Remark
		<p>⚠ Caution:</p> <p>Assembly of Cover Panel after service end.</p> <ul style="list-style-type: none"> - Reassembly is in the reverse order of the removal. - Piping and drain hose must be careful not to damage and Progress must be done with both hands. 	    

No	Parts	Procedure	Remark
		<p>9) Remove the Panel Frame from the Main Frame as shown on the right side.</p>	

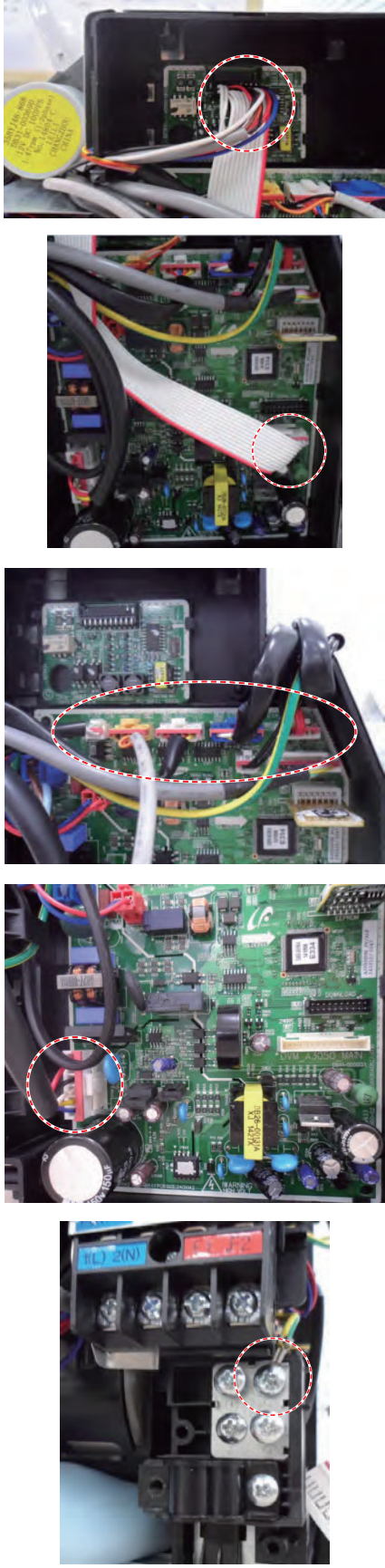

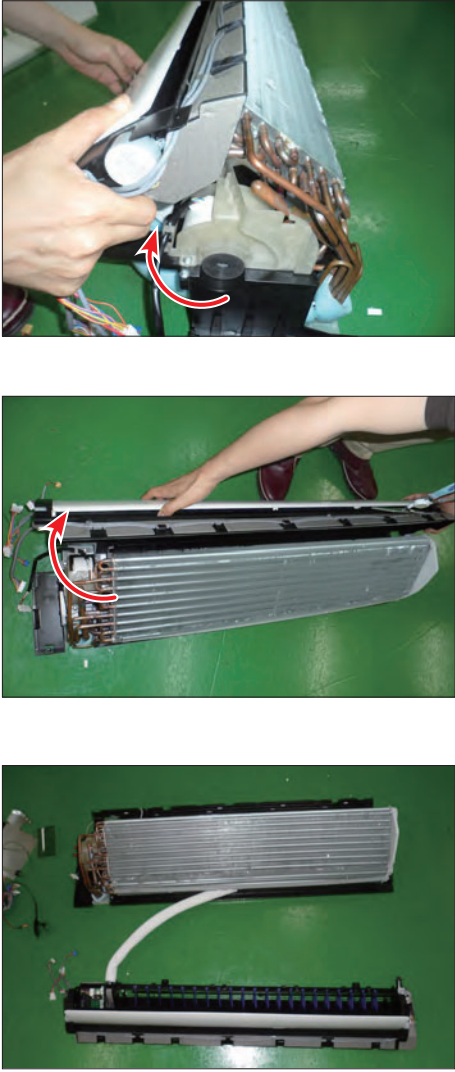
No	Parts	Procedure	Remark
2	CONTORL IN	<p>1) Lossen Sub PBA Wire. ⚠ Caution: When you separate the connector, pull pressing the locking button.</p> <p>2) Lossen Stepping Motor, EEV, Display, Sensor, SPI, Fuse Wire. ⚠ Caution: When you separate the connector, pull pressing the locking button.</p> <p>3) Lossen Motor, Terminal Wire. ⚠ Caution: When you separate the connector, pull pressing the locking button.</p> <p>4) Loosen Earth Wire.</p>	



No	Parts	Procedure	Remark
5	EVAPORATOR	<p>9) Take off the CASE-CONTROL from the main frame after loosen the remaining connector.</p> <p>⚠ Caution: When you separate the connector, pull pressing the locking button.</p>	
3	TRAY DRAIN	<p>1) To detach TRAY-DRAIN from the main frame, pull the bottom of the TRAY-DRAIN towards you.</p>	

No	Parts	Procedure	Remark
4	Evaporator	<p>1) Detach the HOLDER PIPE.</p> <p>2) Unfasten the screw at the left side. (use + Screw Driver)</p> <p>3) Unfasten the screw at the right side. (use + Screw Driver)</p> <p>4) To detach Evaporator from the main frame, pull the bottom of the Evaporator towards you.</p>	   

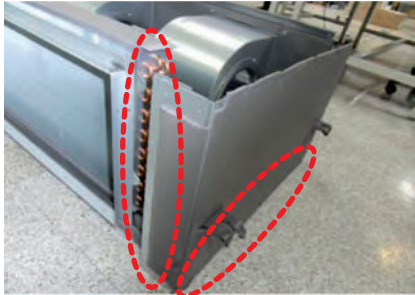
No	Parts	Procedure	Remark
5	FAN MOTOR & CROSS FAN	<p>1) Unfasten the screw. (use + Screw Driver)</p> <p>2) Detach the FAN Motor case.</p> <p>3) Unfasten the screw a little. (use + Screw Driver)</p> <p>4) Pull the CROSS-FAN to the left side.</p>	   

■ OAP DUCT
- AM140JNEPEH/EU

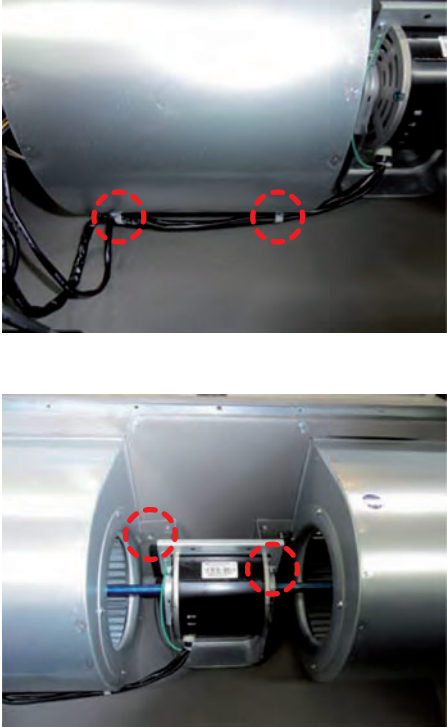

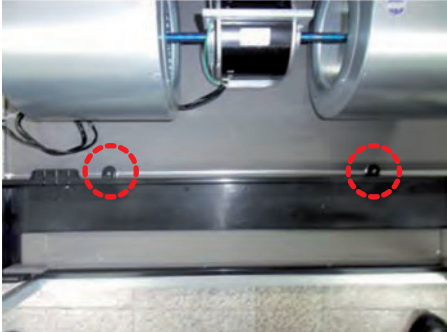
No	Parts	Procedure	Remark
1	MOTOR & BLOWER	<ol style="list-style-type: none"> 1) Open the CONTROL BOX and detach EEV WIRE, SENSOR WIRES and BYPASS WIRE. (Use + Screw Driver) 2) Unscrew 2 fixing screws of the Case Control screw, Unscrew 6 fixing screws of the Cover and detach. (Use+Sscrew Driver) 3) Unscrew 28 screws and detach CABINETTOP. (Use + Screw Diriver) 4) Unscrew 29 screws and detach CABINET SIDE RH and LF. (Use + Screw Diriver) 5) Unscrew 10 screws and detach BLOWER COVER . (Use + Screw Diriver) Detach the BLOWER . (Use the wrench(4mm)) 	    

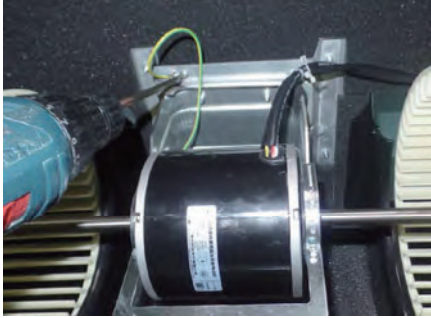
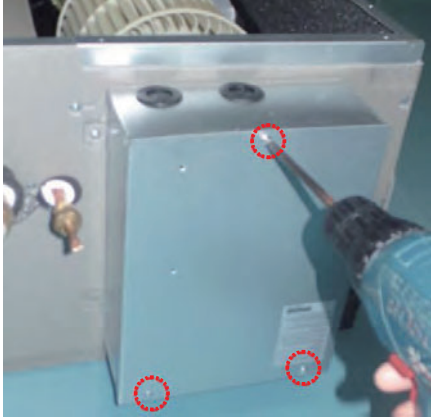
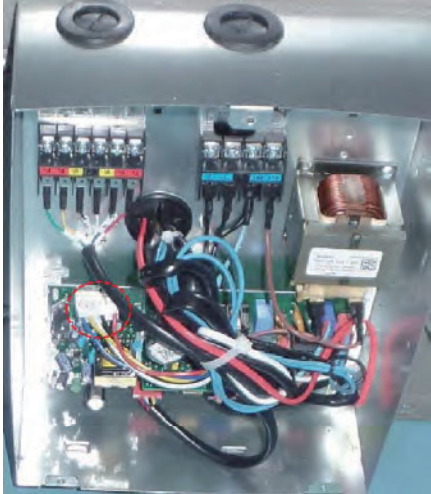

No	Parts	Procedure	Remark
		<p>6) Unscrew 2 screws and detach MOTOR WIRE. (Use + Screw Diriver)</p> <p>7) Disassemble MOTOR EARTH WIRE connected the Partition. Unscrew 2 screws and detach MOTOR. (Use + Screw Diriver)</p>	
	<p>EVAPDRATOR</p>	<p>⚠ Caution: After finished the procedures 1-1) ~ 1-4), detach the Evaporator.</p> <p>1) Unsrew 4 fixing screws of the Evaporator. (Use + Screw Diriver)</p>	
	<p>DRAINPAIN</p>	<p>⚠ Caution: After finished the procedures , detach DRAIN PAN.</p> <p>1) Unsrew 4 fixing screws of the DRAIN PAN. (Use + Screw Diriver)</p>	

■ OAP Duct (AM140MNEPEH/EU)

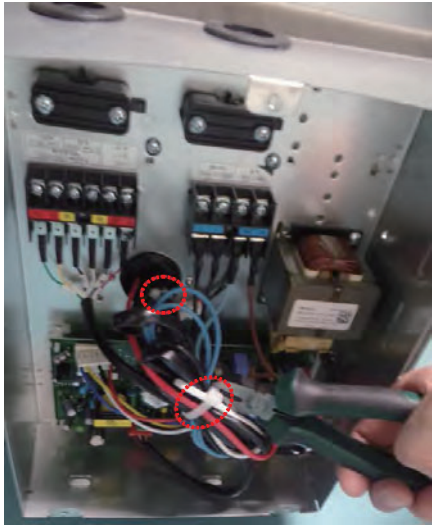
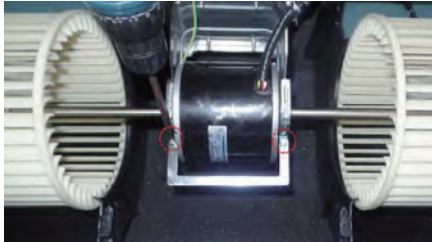

No	Parts	Procedure	Remark
1	Motor & Blower	<p>1. After disassembling 15 indicating screws, detach Ass'y Cabinet-Top Motor.</p> <p>2. After disassembling 4 indicating screws, detach Ass'y Case Blower Upper.</p>	

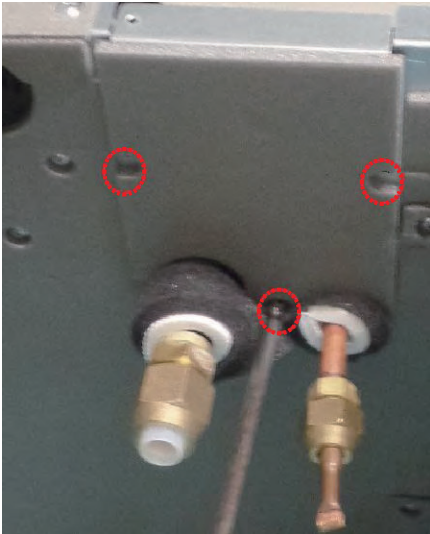
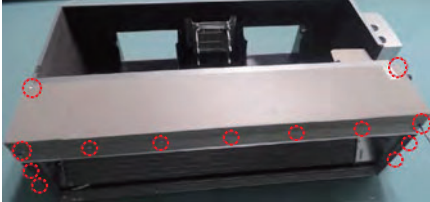
No	Parts	Procedure	Remark
1	Motor & Blower	<p>3. Disassemble the Motor earth wire connected to the Partition. – Unscrew a screw</p> <p>4. Disassemble the Cover Control.</p> <p>5. Disassemble Motor Wires connected to the inside of PCB and connected to the Capacitor.</p>	  

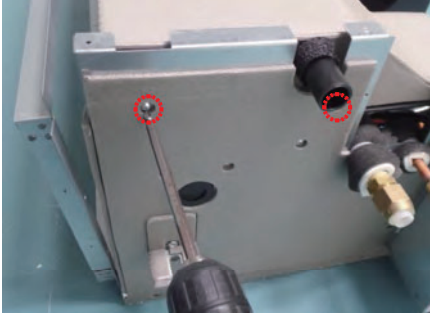
No	Parts	Procedure	Remark
1	Motor & Blower	<p>6. Disassemble cable tie.</p> <p>7. Disassemble the band Motor for fixing the Motor. – Unscrew 2 screws</p> <p>8. After disassembling the Motor and Blower for the set, disassemble the Blower by use of wrench.</p>	  

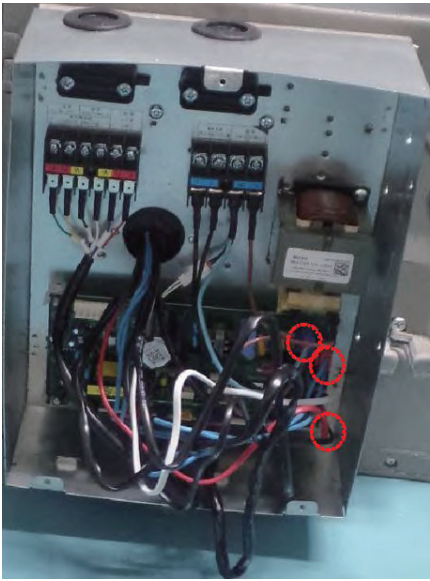

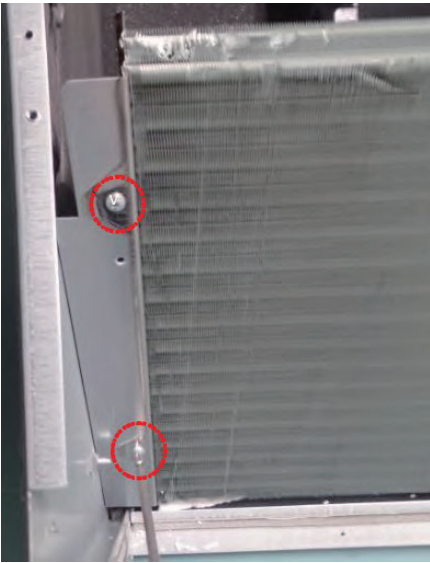

No	Parts	Procedure	Remark
2	Assy Drain Pan	<p>1. Disassemble the Cover Pipe that fixes the high/low pressure Pipe. – Unscrew 2 screws</p> <p>2. Disassemble the Cabinet-Top Evap. – Unscrew 13 screws</p> <p>3. Unscrew 4 screws</p>	   



No	Parts	Procedure	Remark
2	Ass'y Drain Pan	4. Disassemble the Drain Cushion from the set.	
3	Ass'y Evap	1. Disassemble the refrigerant temperature sensor, Inlet air temperature sensor, and EEV wire that connected to the inside of PCB.	

No	Parts	Procedure	Remark
3	Ass'y Evap	<p>2. Disassemble the Cabi LF – Unscrew 2 screws</p> <p>3. Disassemble the Support Evap RH – Unscrew 2 screws</p> <p>4. Disassemble the Evaporator form the set.</p>	  

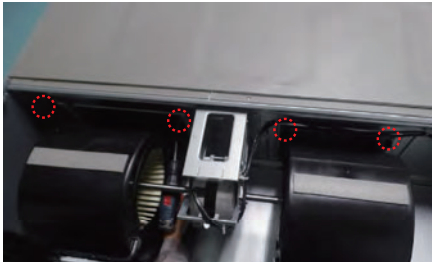

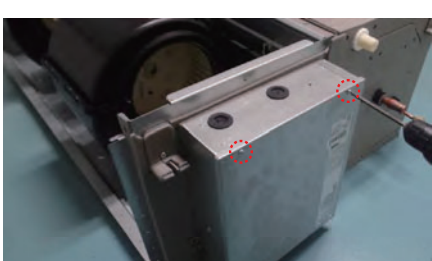
No	Parts	Procedure	Remark
4	Ass'y Control In	<ol style="list-style-type: none"> 1. Disassemble all Control Wires connected to the inside of PCB. 2. In case of disassembling the PCB separately, disassemble the PCB from the case after unscrewing the screw. – Unscrew 4 screw 	 <p>The top photograph shows the internal components of a control assembly. A green printed circuit board (PCB) is mounted at the top. Four screws are circled in red, indicating they need to be removed. Below the PCB, there are various wires, a transformer, and other electronic components. The bottom photograph shows the same assembly after the PCB has been removed, leaving the case empty except for the remaining components and wiring.</p>

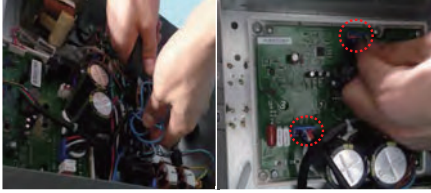
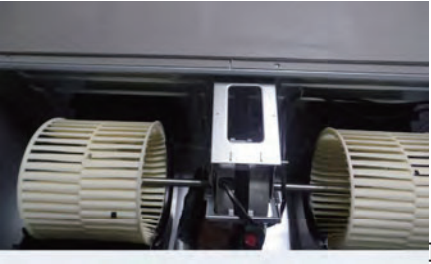
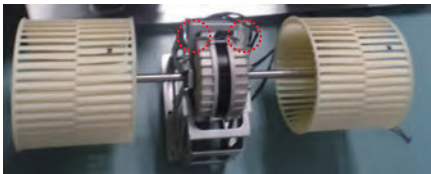
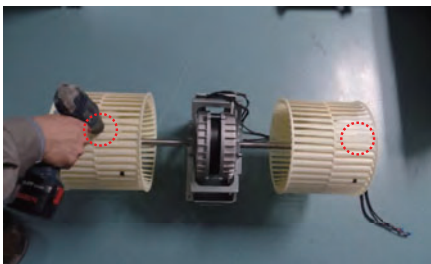
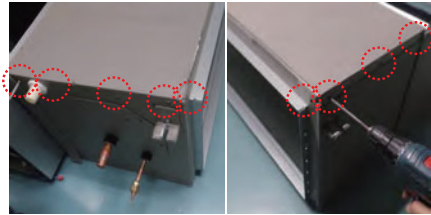

■ OAP Duct (AM220/280MNEPEH/EU)

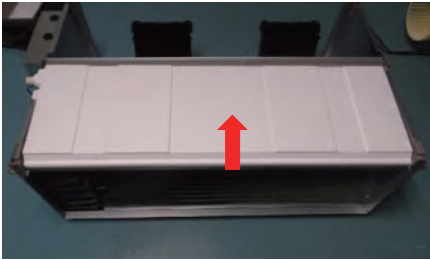
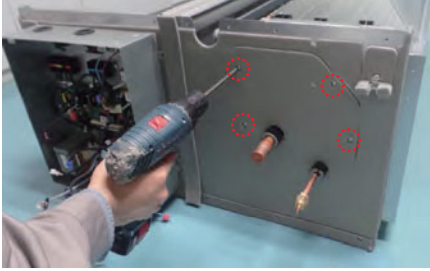
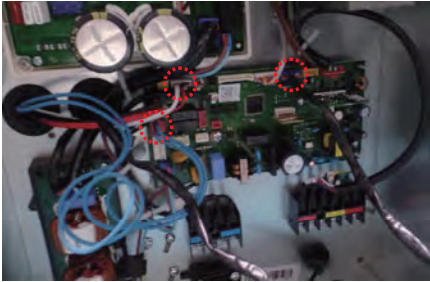
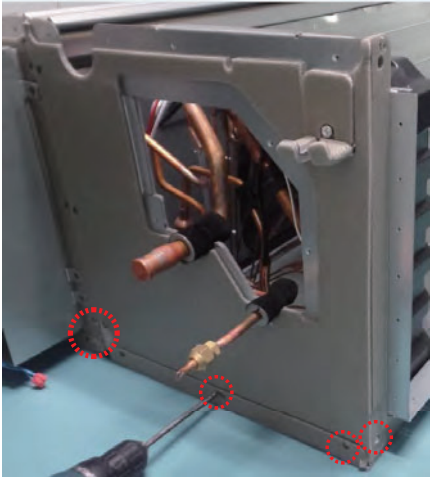
No	Parts	Procedure	Remark
1	Motor & Blower	<p>1. After disassembling 8 indicating screws, detach Ass'y Cabinet-Top Motor.</p> <p>2. After disassembling 4 indicating screws, detach Ass'y Case Blower Upper.</p> <p>3. Press the pothook of the Case Blower and detach Ass'y Case Blower Upper.</p> <p>4. Disassemble the Cover Control.</p>	    

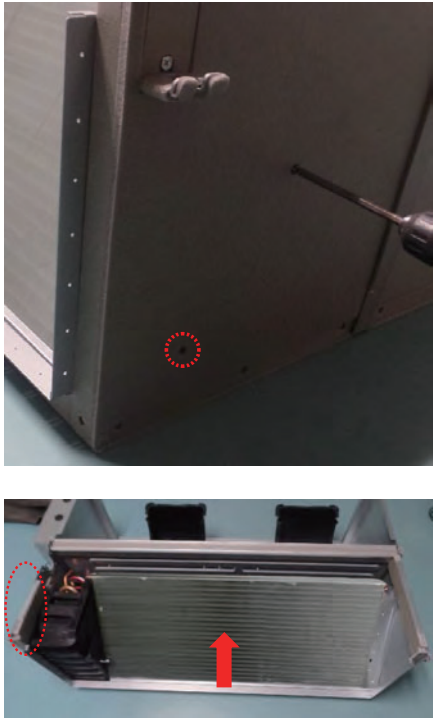
No	Parts	Procedure	Remark
1	Motor & Blower	<p>5. Disassemble Motor Wires connected to the inside of PCB and connected to the Capacitor.</p> <p>6. Disassemble the band Motor for fixing the Motor. – Unscrew 2 screws</p> <p>7. After disassembling the Motor and Blower for the set, disassemble the Blower by use of wrench.</p>	   
2	Ass'y Drain Pan	<p>1. Disassemble the Cabinet-Top Evap. – Unscrew 9 screws</p>	 

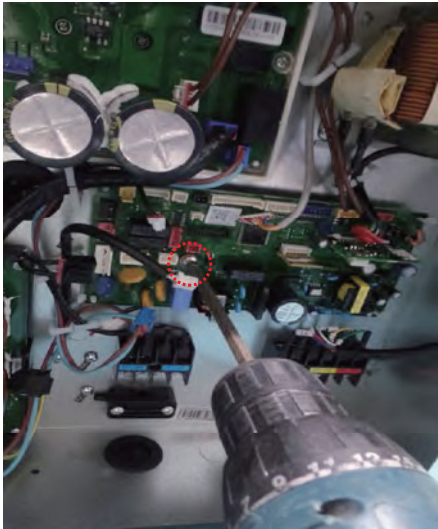

No	Parts	Procedure	Remark
2	Ass'y Drain Pan	2. Disassemble the Drain Cushion from the set.	
3	Ass'y Evap	<p>1. Disassemble the Cover Pipe that fixes the high/low pressure Pipe. – Unscrew 4 screws</p> <p>2. Disassemble the refrigerant temperature sensor, Inlet air temperature sensor, and EEV wire that connected to the inside of PCB.</p> <p>3. Unscrew 4 screws</p>	  

No	Parts	Procedure	Remark
3	Ass'y Evap	<p>4. Unscrew 2 screws</p> <p>5. Disassemble the Evaporator form the set.</p>	
4	Ass'y Control In	<p>1. Disassemble all Control Wires connected to the inside of PCB.</p>	

No	Parts	Procedure	Remark
4	Ass'y Control In	<p>2. In case of disassembling the PCB separately, disassemble the PCB from the case after unscrewing the screw. – Unscrew 5 screw</p> <p>3. In case of disassembling the Case Control, disassemble the Case Control from the set after unscrewing the screw. – Unscrew 6 screw</p>	  

■ V-AHU

- AM012/018/024/030/036/048/054/060/072JNZDCH/AA

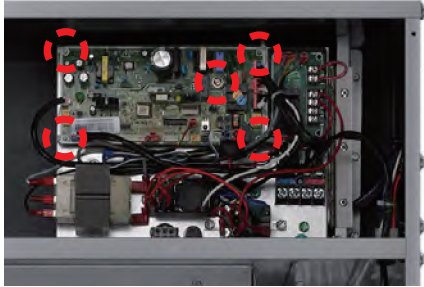
No	Parts	Procedure	Remark
1	FRONT VIEW	1) Stop the operation of the air conditioner and disconnect the main power supply.	
2	Control-BOX	1) Loosen 11 of the front screw(CCW) and detach the Cabinet Front Up. 2) Disconnect the Connector Wire that is connected to the indoor unit's PBA 3) Unscrew the 1 fixed screws on middle of the PBA and 4 fixed PBA HOLDER, and disassemble the PBA from the indoor unit. (Use + Screw Driver)	 



No	Parts	Procedure	Remark
3	DRAIN PAN	<p>1) Loosen 11 of the front screw(CCW) and detach the Cabinet Front Down.</p> <p>2) Loosen 2 of the Left side screw(CCW).</p> <p>3) Loosen 5 of the front screw(CCW) and detach the 2 Bracket drain and 1 Bracket Low</p> <p>4) Pull the Heat Exchanger and Drain.</p> <p>5) Detach the Drain from indoor Unit.</p>	

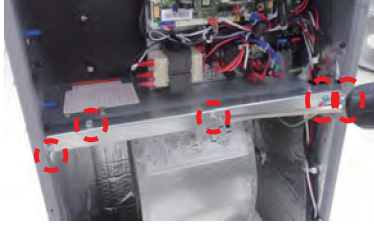
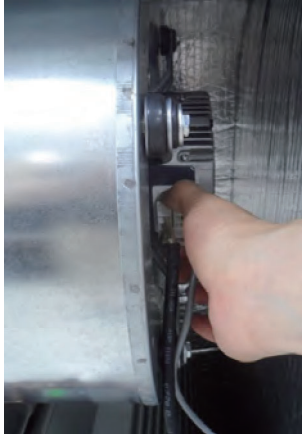
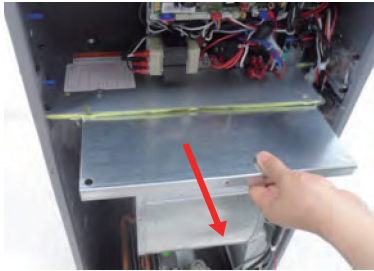

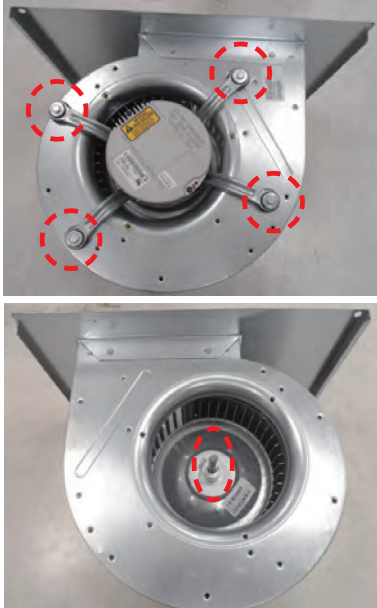

No	Parts	Procedure	Remark
4	Heat Exchanger	<p>1) Loosen 11 of the front screw(CCW) and detach the Cabinet Front Down.</p> <p>2) Loosen 2 of the Left side screw(CCW).</p> <p>3) Loosen 5 of the front screw(CCW) and detach the 2 Bracket drain and 1 Bracket Low.</p> <p>4) Disconnect the Connector Wire that is connected to the Heat Exchanger.</p> <p>5) Pull the Heat Exchanger and Drain.</p> <p>6) Detach the Heat Exchanger.</p>	



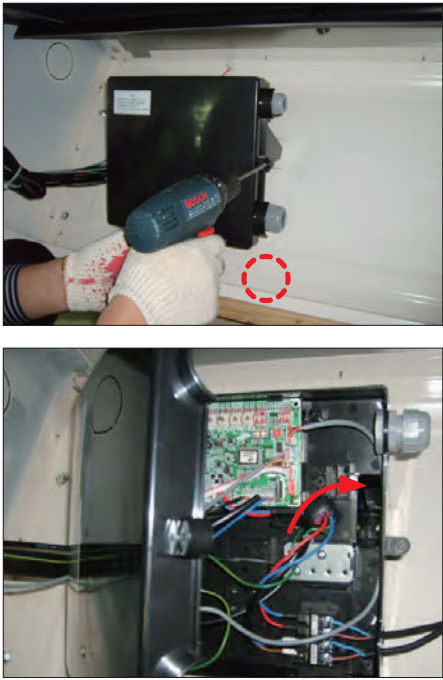

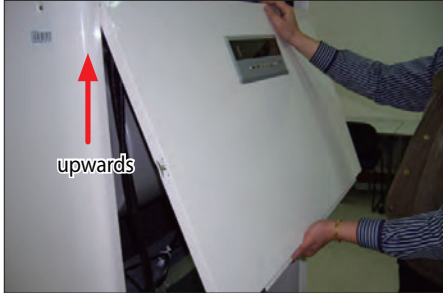
No	Parts	Procedure	Remark
5	FAN & MOTOR	<p>1) Loosen 11 of the front screw(CCW) and detach the Cabinet Front Down.</p> <p>2) Loosen 6 of the Front screw(CCW) and detach the Bracket.</p> <p>3) Disconnect the Connector Wire that is connected to the Motor.</p> <p>5) Pull the A'ssy Fan Blower.</p>	   

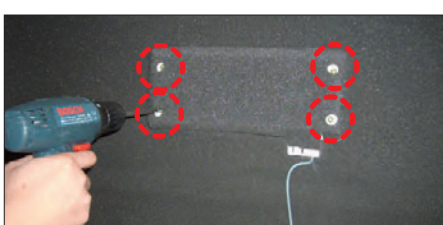

No	Parts	Procedure	Remark
		<p>6) Loosen 4 of the screw and 1 nut on the CASE and Detach the motor and fan.</p>	

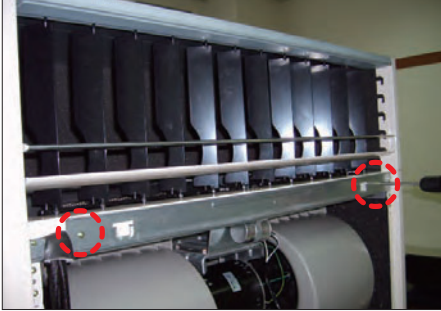

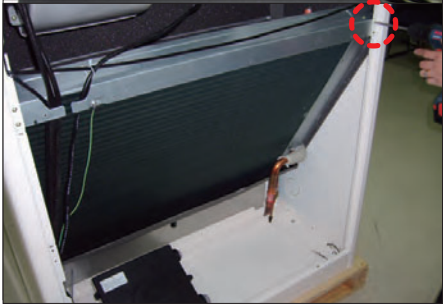

■ AM280JNPDKH/TK

No	Parts	Procedure	Remark
1	FRONT	1) Stop operation of air conditioner and cut the main power supply. 2) Collect all refrigerant to out door unit through discharging refrigerant operation in case of major repair. 3) Discharge all refrigerant from refrigerant drum using refrigerant discharge machines and empty refrigerant drum in case of major repair in a disable power.	
2	ASS'Y INLET GRILLE	1) Open ASS'Y INLET and Separates the connection link.	
3	ASS'Y MAIN PCB PART	1) Unscrew a Cover-Main PCB screw and Separates it.(using + SCREW DRIVER)	

No	Parts	Procedure	Remark
4	ASS'Y FRONT PANEL & DISPLAY PCB PART	<p>1) Unscrew 4 FRONT PANEL BOTTOM screws. (using + SCREW DRIVER)</p> <p>2) Separates FRONT PANEL by pulling upwards.</p> <p>3) Pilfer the wire from wire jam spot and leave FRONT PANEL on a flat ground.</p> <p>4) Separates wire from wire fixed holder on back of FRONT PANEL.</p> <p>5) Unscrew 4 DISPLAY COVER screws. (using + SCREW DRIVER)</p> <p>6) Unscrew a display PCB screw. (using + SCREW DRIVER)</p>	     

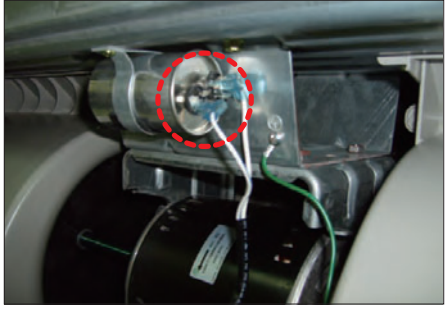
No	Parts	Procedure	Remark
5	OUTLET GRILLE PART	<p>1) Unscrew 2 discharge grille screws of front blower fixed bracket. (using + SCREW DRIVER)</p> <p>2) Unscrew 14 top cover screws.</p> <p>3) Separates the top cover.</p> <p>4) Separates discharge grille by pulling upwards.</p>	    

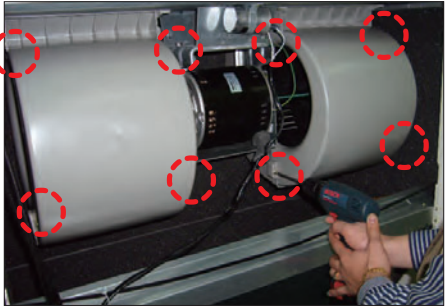
No	Parts	Procedure	Remark
6	ASS'Y EVAP PART	<p>▲ 1) Heat exchanger service is a major repair service item.</p> <p>2) First of all, after checking whether refrigerant surely be discharged or not through discharging refrigerant operation, start operation.</p> <p>3) Please work by a qualified worker as items requiring welding operations.</p> <p>4) Please dispose fire extinguisher around work place surely against fire emergency.</p> <p>1) Separates a high pressure pipe flare nut.(Using MONKEY SPANNER)</p> <p>2) Separates low pressure pipe (9/8 inch) carefully using gas welding machine.</p> <p>▲ Separates low pressure pipe carefully that welding heat does not touch drain fan made of plastic.</p> <p>3) Unscrew 4 heat exchanger top screws. (using + SCREW DRIVER)</p> <p>4) Unscrew 4 fixed screws of heat exchanger cover's right. (using + SCREW DRIVER)</p> <p>5) Unscrew 4 fixed screws of heat exchanger cover's left. (using + SCREW DRIVER)</p>	   

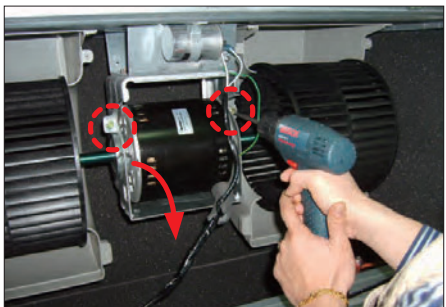
No	Parts	Procedure	Remark
7	FAN BLOWER & MOTOR PART	<p>1) Separates a socket of motor driving capacitor.</p> <p>2) Unscrew 8 cover screws of FAN BLOWER DUCT. (using + SCREW DRIVER)</p> <p>3) Separates FAN BLOWER cover.</p> <p>4) Unscrew 2 FAN MOTOR BRACKET screws. (using + SCREW DRIVER)</p> <p>5) Separates FAN MOTOR BRACKET by pulling frontwards.</p>	    

No	Parts	Procedure	Remark
		<p>6) Separates FAN & MOTOR by pulling front-wards & supporting with both hands.</p>	



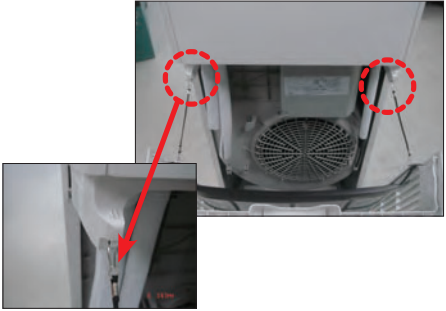
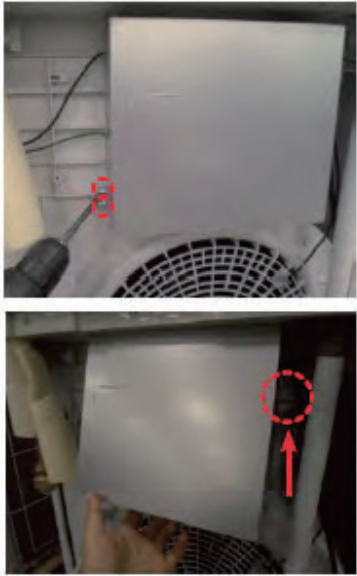

■ AM140JNPDKH/TK

No	Parts	Procedure	Remark
1	FRONT	1) Stop operation of air conditioner and cut the main power supply.	
2	ASS'Y INLET PART	1) Open ASS'Y INLET and Separates the connection link.	
3	ASS'Y COVER CONTROL	<p>1) Unscrew a ASSY COVER CONTROL screw and Separates it.(using + SCREW DRIVER) Unscrew a ASSY COVER CONTROL screw and Separates it.(using + SCREW DRIVER)</p> <p>2) Separates ASS'Y COVER CONTROL frontwards by pulling upwards.</p>	

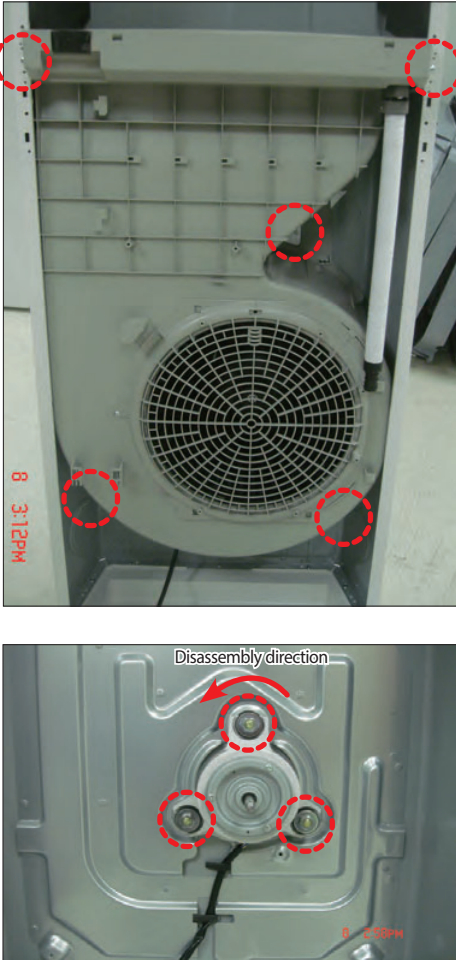
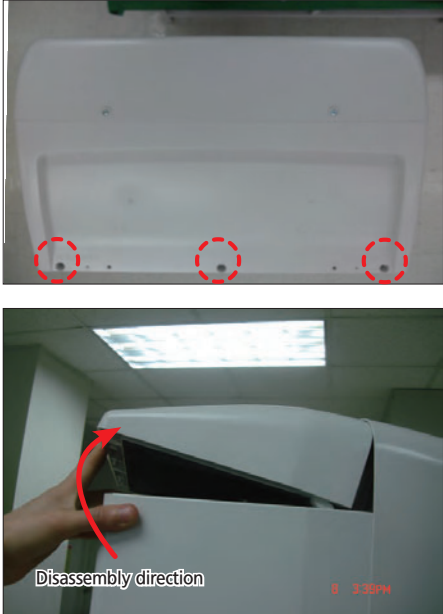

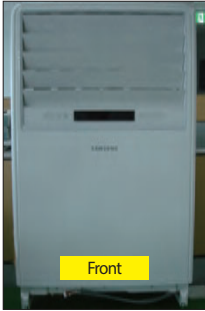
No	Parts	Procedure	Remark
		<p>3) SEPARATES MOTOR CONNECTOR & CONNECTOR CONNECTED TO PANEL-OUTLET.</p>	
<p>4</p>	<p>ASS'Y PANEL-OUTLET</p>	<p>1) AFTER UNSCREW 7 ASS'Y PANEL-OUTLET SCREWS, SEPARATES ASS'Y PANEL-OUTLET BY PUSHING UPWARDS. (USING + SCREW DRIVER)</p>	

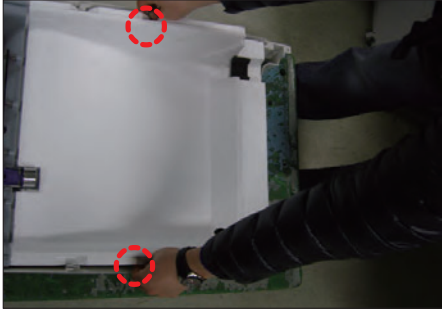
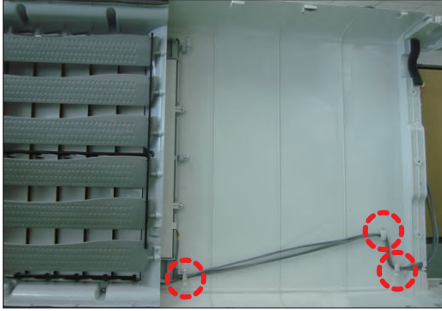

No	Parts	Procedure	Remark
5	ASS'Y EVA	<p>1) UNSCREW 2 BRACKET EVA SCREWS.</p> <p>2) UNSCREW A FIXED SCREW OF BRACKET EVA'S RIGHT.</p> <p>3) SEPARATES A GROUND SCREW.</p> <p>4) PULL OUT SENSOR WIRE.</p> <p>5) PULL OUT BRACKET PIPE UPWARDS.</p> <p>6) SEPARATES HEAT EXCHANGER TOP BY PULLING FRONTWARDS & SUPPORTING WITH BOTH HANDS.</p> <p>7) UNSCREW 2 COVER EVA SCREWS.</p>	
6	ASS'Y CONTROL IN	<p>1) UNSCREW 2 ASS'Y CONTROL SCREWS.</p> <p>2) UNSCREW A EVA GROUND SCREW.</p> <p>3) SEPARATES ASS'Y CONTROL IN BY PUSHING TO THE RIGHT.</p>	

No	Parts	Procedure	Remark
8	ASS'Y MOTOR BLOWER	<p>1) Unscrew 5 ASS'Y DUCT CASE screws. (using + SCREW DRIVER)</p> <p>2) Loosen 3 MOTOR nuts and unscrew a ground screw. (using MONKEY SPANNER) (Separates a connected connector before disassembling motor.</p>	
9	COVER TOP	<p>1) UNSCREW 3 COVER TOP SCREWS. (USING +SCREW DRIVER) (SCREW : TH 2TYPE M4, L10, BLK)</p> <p>2) SEPARATES COVER TOP BY LIFTING COVER TOP'S BACK PARTS.</p>	

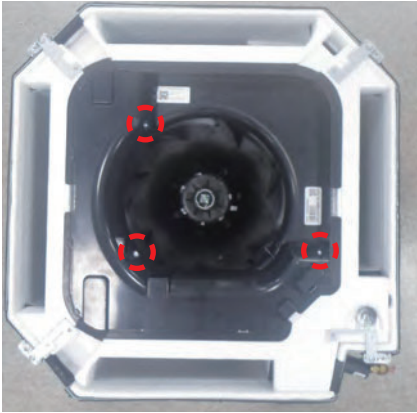
No	Parts	Procedure	Remark
10	ASS'Y PANEL-OUTLET	<p>1) PANEL-OUTLET appearance.</p> <p>2) Separates PARTITION forward from the bottom by pushing 2 hook of panel both sides outwards.</p> <p>3) Separates the wire that fixed to the HOLDER WIRE.</p> <p>4) Separates the wire that fixed to the HOLDER WIRE.</p>	    

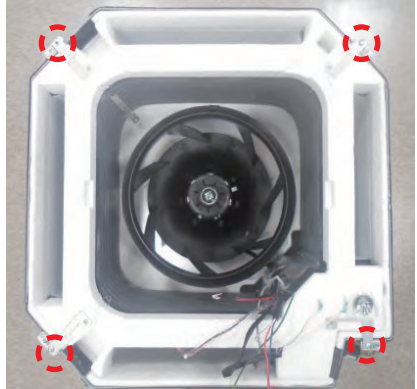
■ 4Way Cassette type(600x600)

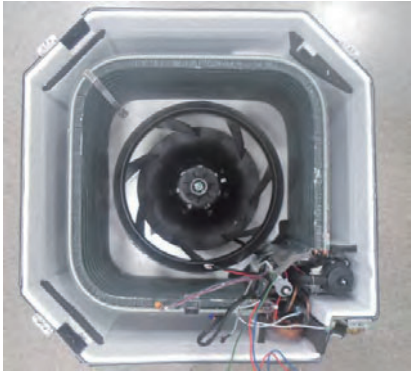
No	Parts	Procedure	Remark
1	Control Part	1) Remove the 3 fixed screws to remove the Control-Box Cover. (Use +Screw Driver)	
		2) Disconnect the Connector Wire that is connected to the indoor unit's PBA. 3) Unscrew the 2 fixed screws on both sides of the Control Box, and disassemble the Control Box from the indoor unit. (Use +Screw Driver)	
2	Drain Pan	1) Unscrew the screws on the 4 corners of the indoor unit. (Use +Screw Driver) 2) Remove the Drain Pan from the indoor unit.	

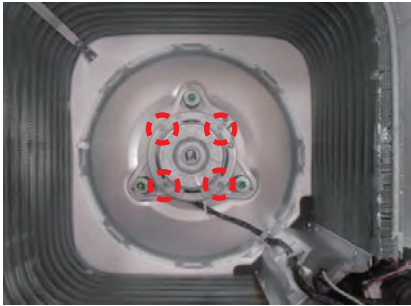
No	Parts	Procedure	Remark
3	FAN & MOTOR	<p>1) Turn the hexangular nut attached to the top of the Fan counterclockwise to remove it. Take the Fan out of the Motor.</p> <p>2) Turn the four hexangular nuts on the Motor counterclockwise to remove the nuts. Take the Motor Wires attached to these three locations out with your hands prior to removing the Motor.</p>	  

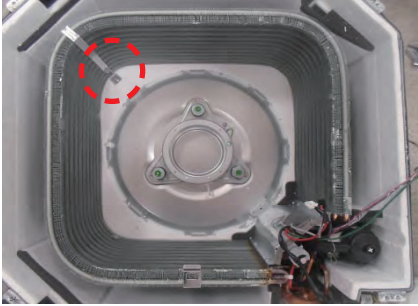
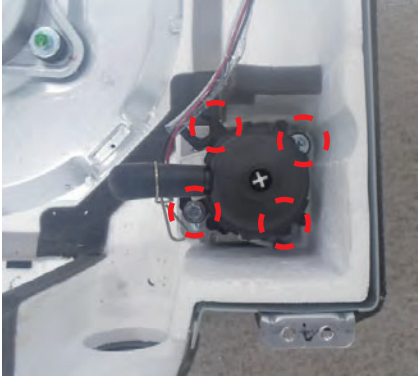
No	Parts	Procedure	Remark
4	EVAPORATOR	<p>1) Remove the 4 fixing screws of the Cover Pipe at the Heat Exchanger's In/Out Pipe. (Use +Screw Driver)</p> <p>2) Remove the screws of the Steel Holder Evaps that are used to fix the Heat Exchanger, and then remove it. (Use +Screw Driver)</p>	 
5	DRAIN PUMP	<p>1) Remove the 4 fixed screws and disconnect the white drainage hose from the Drain Pump. (Use +Screw Driver)</p>	

4. Troubleshooting

4-1 Check-up Window Description

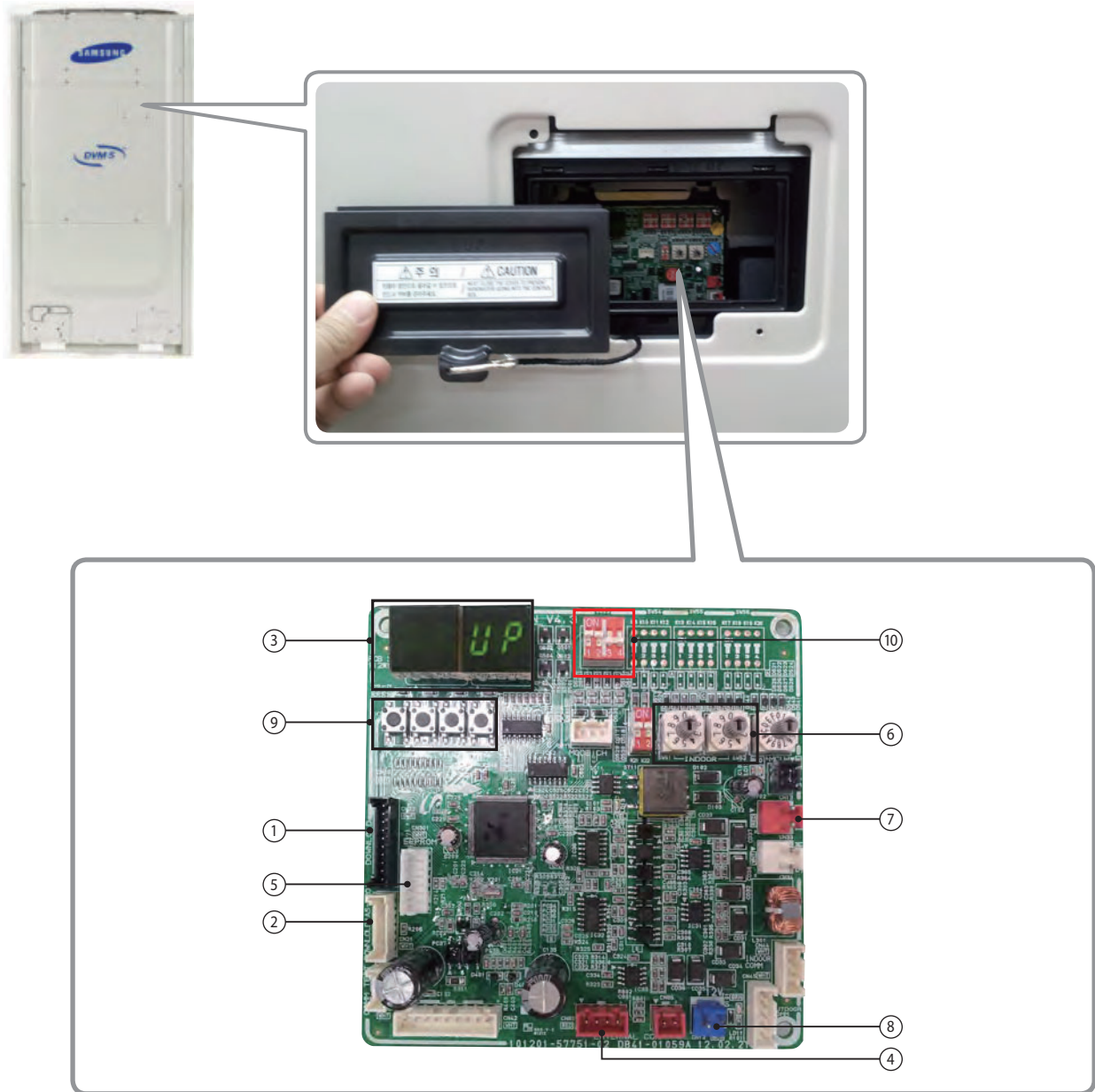

No.	Function	No.	Function
1	CN22 download (PC) (SMW200-10 black)	6	Set up the number of connected outdoor units
2	MICOM. download (AS-PRO) (SMW200-07P white)	7	For checking indoor unit communication (YW396-02P red)
3	ERROR DISPLAY	8	Transmitter 12V (YW396-02P blue)
4	State Check (SMW250-04P red)	9	Outdoor Unit Tact Switch
5	EEPROM SOCKET	10	Outdoor Unit Dip Switch

4-2 Service Operation

4-2-1 Special Operation

▶ **Key input of the outdoor unit when the service enters the operation mode.**

K1 (Number of press)	Key operation	Display on segment
1 time	Refrigerant charging in Heating mode	K, 1, BLANK, BLANK
2 times	Trial operation in Heating mode	K, 2, BLANK, BLANK
3 times	Pump out in Heating mode (Outdoor unit address 1)	K, 3, BLANK, 1
4 times	Pump out in Heating mode (Outdoor unit address 2)	K, 3, BLANK, 2
5 times	Pump out in Heating mode (Outdoor unit address 3)	K, 3, BLANK, 3
6 times	Pump out in Heating mode (Outdoor unit address 4)	K, 3, BLANK, 4
7 times	Vacuümig (Outdoor unit address 1)	K, 4, BLANK, 1
8 times	Vacuümig (Outdoor unit address 2)	K, 4, BLANK, 2
9 times	Vacuümig (Outdoor unit address 3)	K, 4, BLANK, 3
10 times	Vacuümig (Outdoor unit address 4)	K, 4, BLANK, 4
11 times	Vacuüming (All outdoor units)	K, 4, BLANK, A
12 times	End Key operation	-
Press and hold 1 time	Auto trial operation	K, K, BLANK, BLANK

K2 (Number of press)	Key operation	Display on segment
1 time	Refrigerant charging in Cooling mode	K, 5, BLANK, BLANK
2 times	Trial operation in Cooling mode	K, 6, BLANK, BLANK
3 times	Pump down all units in Cooling mode	K, 7, BLANK, BLANK
4 times	H/R: Checking the pipe connection H/P: Automatic setting of operation mode (Cooling/Heating) for trail operation	K, 8, BLANK, BLANK
5 times	Checking the amount of refrigerant	K 9 X X (Display of last two digits may differ depending on the progress)
6 times	Discharge mode of DC link voltage	K, A, BLANK, BLANK
7 times	Forced defrost operation	K, B, BLANK, BLANK
8 times	Forced oil collection	K, C, BLANK, BLANK
9 times	End Key operation	-

※ Inv1 & Inv2 voltage during discharge mode are displayed alternately.

※ Outdoor Power Off even when the Inverter PCB, Fan PCB is a high DC voltage charging contacts at danger.

※ When you run the repair and replacement of the PCB should work after the power is turned off, the DC voltage discharge. (Natural discharge until Please wait for at least 15 minutes.)

※ If an error occurs, the discharge mode may not work properly. In particular, E464 & E364 is power devices can be damaged. Therefore, the discharge mode, do not use.

■ Commissioning

- ▶ **After initial installation, stable operation for a certain period of time limited to operation conditions.**

	Cooling	Heating
Method of Entry	K2 Tact Switch twice	K2 Tact Switch twice
Compressor	Normal operation, but the maximum frequency limit (differ by model)	
Indoor Unit	Whole operation (The set temperature=3°C)	Whole operation (The set temperature=40°C)
Outdoor fan and valves	Normally control conduct	
Operation time	Min : 60 minutes, Max : 10 hours	
Etc.	<ul style="list-style-type: none"> · Exceed the maximum operating time at stops and waits. · Protection and control, self-diagnosis is performed. 	

■ Refrigerant filling operation

- ▶ **Operation to filling the refrigerant compressor was fixed at a certain frequency.**

	Cooling	Heating
Method of Entry	K2 Tact Switch one time	K1 Tact Switch one time
Compressor	Starting frequency (Mild Start frequency) operation	
Indoor Unit	Whole operation (The set temperature=3°C)	Whole operation (The set temperature=40°C)
Outdoor fan and valves	Normally control conduct	
Operation time	60 minutes	
Etc.	During the filling operation does not enter the special operation, such as oil recovery, defrost.	

■ Heating Pump Out

- ▶ Operation for the repair of the Individual outdoor unit, the outdoor unit refrigerant emissions to the indoor part.
- ▶ Liquid pipe service valve and the gas pipe service valve operation, the operator manually need to close.
- ▶ Observe low pressure using View Mode of K4 button if compressor operate.
If low pressure goes down below about 0.2 MPa.g : Immediately lock the gas side service valve, Pump Out operation is shut down.
(Pump out operation shut down : K1 button once more press or K3 button one time press)
- ▶ If operation of low pressure goes down below 0.1 MPa.g : Will be stopped automatically for the protection of the compressor.

How to Initiate	K1 Tact Switch 3 times~6 times
Compressor	60Hz
Indoor Unit	Whole Operation (The set temperature=40°C)
4Way Valve	ON (Heating Mode)
Outdoor Fan	Maximum air flow
Main EEV	Operation side : 700 Step (Stop side : 0 step)
Maximum Operation Time	10 minutes
Protection Control	Conduct the discharge temperature, high pressure control. (Low pressure protection control is not carried out) ※ Low pressure is outside normal limits : Operation is shut down after gas pipe manually closed.
Etc.	Entry after safety start. (Only the corresponding Outdoor Unit operation.) To pump out more than 2 : Except communication between Outdoor Unit of relevant set after working for one, remainder set makes Pump Out add.

■ Cooling Pump Down

- ▶ Recover the refrigerant of Indoor Unit and Piping to outdoor side.
- ▶ Liquid pipe service valve and the gas pipe service valve operation, the operator manually need to close.
- ▶ If the installation of the long pipe : Any refrigerant into the outdoor unit can not be recovered, therefore should use a separate container.
- ▶ Observe low pressure using View Mode of K4 button if compressor operate.
If low pressure goes down below about 0.2 MPa.g : Immediately lock the gas side service valve, Pump Out operation is shut down.
(Pump out operation shut down : K1 button once more press or K3 button one time press)
- ▶ If operation of low pressure goes down below 0.1 MPa.g : Will be stopped automatically for the protection of the compressor.

How to Initiate	K2 Tact Switch 3 times
Compressor	Address No.1 Outdoor Unit - 60Hz (Other Outdoor Unit COMP OFF)
Indoor Unit	Whole Operation (The set temperature=3°C)
4Way Valve	OFF (Cooling Mode)
Outdoor Fan	Maximum air flow
Main EEV	Operation side : 2000 Step , Stop side : 2000 step
Maximum Operation Time	30 minutes
Etc.	Does not conduct the operation of the special operation, and protection control. Pressure and temperature is outside normal limits : Operation is shut down after gas pipe manually closed.

■ Vacuum Operation

- ▶ **Operation to facilitate vacuum to open the valve after the Outdoor Unit repair.**

How to Initiate	K1 Tact Switch 7 times~11 times
Compressor	OFF
Indoor Unit/Outdoor Fan	OFF
4Way Valve	OFF
Valves	Open all valves maximum
Etc.	If not turn off the vacuum mode, the start of normal operation is prohibited.

■ Piping Inspection Operation

- ▶ Operation mode to check the status of the piping between the MCU and the indoor unit.
- ▶ Heat Pump Model: Outdoor temperature is more than 15°C / Cooling commissioning start
Outdoor temperature is less than 15°C / Heating commissioning start

■ Discharge Mode Operation

- ▶ Outdoor power is turned off, the Inverter PCB and Fan PCB charging a high DC voltage, so dangerous to touch.
 - To replace the PCB, first turn off the power and the begin if DC voltage is discharged.
 - If not use the discharge mode, the discharge time of about 15 minutes takes.
 - If an error occurs, the discharge mode may not properly run. (Wait until natural discharge.)
 - In particular, E 464, E364, power devices may be damaged, therefore do not use the discharge mode.
- ▶ Block the Inverter PCB 3-phase relay after connected the power, and through compressor, DC voltage is discharging.
 - INV1 and INV2 DC voltage during discharge mode are displayed alternately.
 - Discharge mode Display (Rotate the three page display, as shown below.)
 'K' 'A' ' ' ' ' → DC Link Volt1 (For example, 120[V] 0 1 2 0 display)
 → DCLinkVolt2 (For example, 120[V] 0 1 2 0 display) → 'K' 'A' ' ' ' ' → DC Link Volt1 ...
- ▶ Discharge is complete, the power of the Inverter PCB and Fan PCB is being blocked, communication function is blocked, E206 will occur.
- ▶ If want operation again after complete discharge mode : Restart after K3 key to Reset or Power Reset.

■ Forced defrost operation

- ▶ **Forced defrost operation : Is operation when Frost Formation occurs in the outdoor. (When carried out the service)**

Method of Entry	K2 Tact Switch 6 times
Start pattern	Heating commissioning pattern
Defrost start	Defrost start : It is after 10 minutes which Safety Start finishes.
Defrost off	General defrost operation conditions are the same as.
Etc.	Defrost shut down and stop the normal pattern of the outdoor unit stop.

■ Forced oil recovery operation

- ▶ **Forced oil recovery operation : Oil recovery in the outdoor unit for the purpose of moving, installation if necessary.**

Method of Entry	K2 Tact Switch 7 times
Start pattern	Outdoor temperature is more than 10°C : Cooling commissioning Outdoor temperature is less than 10°C : Heating commissioning
Oil recovery start	Oil recovery start : It is after 10 minutes which Safety Start finishes.
Etc.	Oil recovery shut down and stop the normal pattern of the outdoor unit stop.

4-2-2 DVM S Models EEPROM Code Table

No.	Model Name	EEP Code
1	AM080FXVAGH/EU	DB82-01358A
2	AM100FXVAGH/EU	DB82-01359A
3	AM120FXVAGH/EU	DB82-01360A
4	AM140FXVAGH/EU	DB82-01361A
5	AM160FXVAGH/EU	DB82-01362A
6	AM180FXVAGH/EU	DB82-01363A
7	AM200FXVAGH/EU	DB82-01364A
8	AM220FXVAGH/EU	DB82-01365A
9	AM080FXVAGR/EU	DB82-01330A
10	AM100FXVAGR/EU	DB82-01331A
11	AM120FXVAGR/EU	DB82-01332A
12	AM140FXVAGR/EU	DB82-01333A
13	AM160FXVAGR/EU	DB82-01334A
14	AM180FXVAGR/EU	DB82-01335A
15	AM200FXVAGR/EU	DB82-01336A
16	AM220FXVAGR/EU	DB82-01337A
17	AM080FXMDGH/EU	DB82-01774A
18	AM090FXMDGH/EU	DB82-01776A

4-3 Troubleshooting

4-3-1 Setting Option Setup Method



4-3-1-1 PCB option code input method

- ▶ Set the indoor unit address and installation option with remote controller option.
Set the each option separately since you cannot set the ADDRESS setting and indoor unit installation setting option at the same time. You need to set twice when setting indoor unit address and installation option.

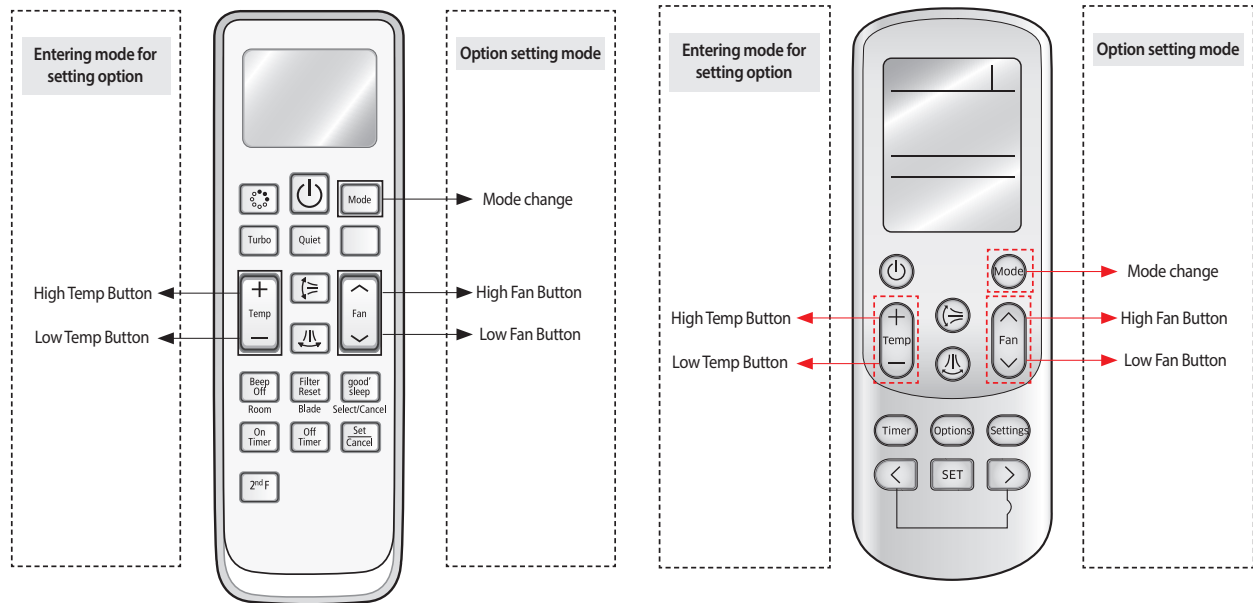
■ The procedure of setting option



Step 1 Entering mode to set option

1. Remove batteries from the remote controller.
2. Insert batteries and enter the option setting mode while pressing High Temp button and Low Temp button .
3.  Check if you have entered the option setting status.

Step 2 The procedure of option setting

After entering the option setting status, select the option as listed below.









- The total number of available options are 24: SEG1 to SEG24.
- Because SEG1, SEG7, SEG13, and SEG19 are the page options used by the previous remote control models, the modes to set values for these options are skipped automatically.
- Set a 2-digit value for each option pair in the following order: SEG2 and SEG3 ▮ SEG4 and SEG5 ▮ SEG6 and SEG8 ▮ SEG9 and SEG10 ▮ SEG11 and SEG12 ▮ SEG14 and SEG15 ▮ SEG16 and SEG17 ▮ SEG18 and SEG20 ▮ SEG21 and SEG22 ▮ SEG23 and SEG24.

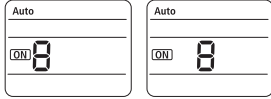
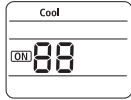
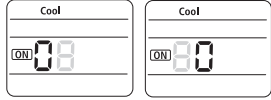
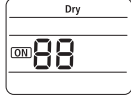

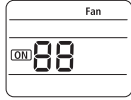
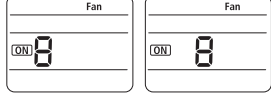

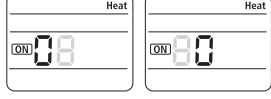

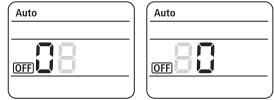

SEG1	SEG2	SEG3	SEG4	SEG5	SEG6	SEG7	SEG8	SEG9	SEG10	SEG11	SEG12
0	X	X	X	X	X	1	X	X	X	X	X
SEG13	SEG14	SEG15	SEG16	SEG17	SEG18	SEG19	SEG20	SEG21	SEG22	SEG23	SEG24
2	X	X	X	X	X	3	X	X	X	X	X

On(SEG1~12)	Off(SEG13~24)
Auto	Auto
00	00

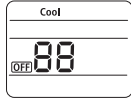
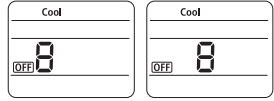
■ The procedure of setting option

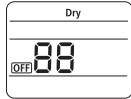
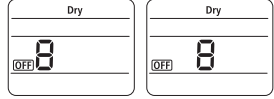
Option setting	Status
<p>1. Setting SEG2, SEG3 option Press Low Fan button(∨) to enter SEG2 value. Press High Fan button(∧) to enter SEG3 value. Each time you press the button, 0 □ 8 □ ... 8 □ F will be selected in rotation.</p>	 <p style="text-align: center;">SEG2 SEG3</p>
<p>2. Setting Cool mode <input type="button" value="Mode"/> Press Mode button to be changed to Cool mode in the ON status.</p>	
<p>3. Setting SEG4, SEG5 option Press Low Fan button(∨) to enter SEG4 value. Press High Fan button(∧) to enter SEG5 value. Each time you press the button, 0 □ 8 □ ... 8 □ F will be selected in rotation.</p>	 <p style="text-align: center;">SEG4 SEG5</p>
<p>4. Setting Dry mode <input type="button" value="Mode"/> Press Mode button to be changed to DRY mode in the ON status.</p>	
<p>5. Setting SEG6, SEG8 option Press Low Fan button(∨) to enter SEG6 value. Press High Fan button(∧) to enter SEG8 value. Each time you press the button, 0 □ 8 □ ... 8 □ F will be selected in rotation.</p>	 <p style="text-align: center;">SEG6 SEG8</p>
<p>6. Setting Fan mode <input type="button" value="Mode"/> Press Mode button to be changed to FAN mode in the ON status.</p>	
<p>7. Setting SEG9, SEG10 option Press Low Fan button(∨) to enter SEG9 value. Press High Fan button(∧) to enter SEG10 value. Each time you press the button, 0 □ 8 □ ... 8 □ F will be selected in rotation.</p>	 <p style="text-align: center;">SEG9 SEG10</p>
<p>8. Setting Heat mode <input type="button" value="Mode"/> Press Mode button to be changed to HEAT mode in the ON status.</p>	
<p>9. Setting SEG11, SEG12 option Press Low Fan button(∨) to enter SEG11 value. Press High Fan button(∧) to enter SEG12 value. Each time you press the button, 0 □ 8 □ ... 8 □ F will be selected in rotation.</p>	 <p style="text-align: center;">SEG11 SEG12</p>
<p>10. Setting Auto mode <input type="button" value="Mode"/> Press Mode button to be changed to AUTO mode in the OFF status.</p>	

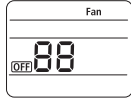
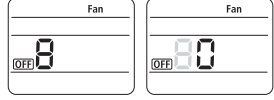
■ The procedure of setting option (cont.)

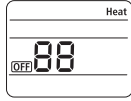
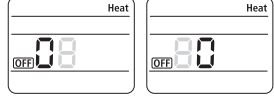
Option setting	Status
<p>11. Setting SEG14, SEG15 option Press Low Fan button(∨) to enter SEG14 value. Press High Fan button(∧) to enter SEG15 value. Each time you press the button, 0 8 ... 8 0 will be selected in rotation.</p>	 <p style="text-align: center;">SEG14 SEG15</p>
<p>12. Setting Cool mode  Press Mode button to be change to Cool mode in the OFF status.</p>	
<p>13. Setting SEG16, SEG17 option Press Low Fan button(∨) to enter SEG16 value. Press High Fan button(∧) to enter SEG17 value. Each time you press the button, 0 8 ... 8 0 will be selected in rotation.</p>	 <p style="text-align: center;">SEG16 SEG17</p>
<p>14. Setting Dry mode  Press Mode button to be change to Dry mode in the OFF status.</p>	
<p>15. Setting SEG18, SEG20 option Press Low Fan button(∨) to enter SEG18 value. Press High Fan button(∧) to enter SEG20 value. Each time you press the button, 0 8 ... 8 0 will be selected in rotation.</p>	 <p style="text-align: center;">SEG18 SEG20</p>
<p>16. Setting Fan mode  Press Mode button to be change to Fan mode in the OFF status.</p>	
<p>17. Setting SEG21, SEG22 option Press Low Fan button(∨) to enter SEG21 value. Press High Fan button(∧) to enter SEG22 value. Each time you press the button, 0 8 ... 8 0 will be selected in rotation.</p>	 <p style="text-align: center;">SEG21 SEG22</p>
<p>18. Setting Heat mode  Press Mode button to be change to HEAT mode in the OFF status.</p>	
<p>19. Setting SEG23, SEG24 mode Press Low Fan button(∨) to enter SEG23 value. Press High Fan button(∧) to enter SEG24 value. Each time you press the button, 0 8 ... 8 0 will be selected in rotation.</p>	

Step 3 Check the option you have set

After setting option, press  button to check whether the option code you input is correct or not.

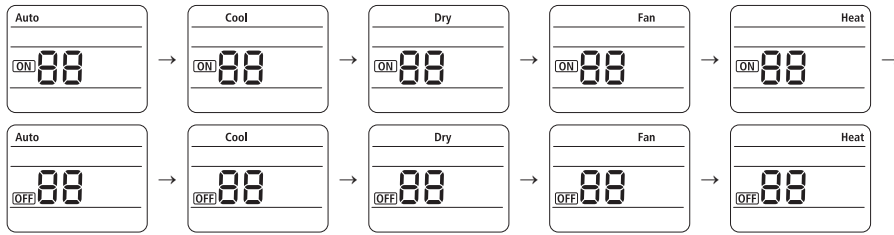

Step 4 Input option

Press operation button  with the direction of remote control for set.
For the correct option setting, you must input the option twice.

Step 5 Check operation

1. Reset the indoor unit by pressing the RESET button of indoor unit or outdoor unit.
2. Take the batteries out of the remote controller and insert them again and then press the operation button.

- Setting an indoor unit address and installation option

■ Setting an indoor unit installation option (suitable for the condition of each installation location)

1. Check whether power is supplied or not.
 - When the indoor unit is not plugged in, there should be additional power supply in the indoor unit.
2. The panel(display) should be connected to an indoor unit to receive option.
3. Set the installation option according to the installation condition of an air conditioner.
 - The default setting of an indoor unit installation option is 020010-100000-200000-300000.
 - Individual control of a remote controller(SEG20) is the function that controls an indoor unit individually when there is more than one indoor unit.

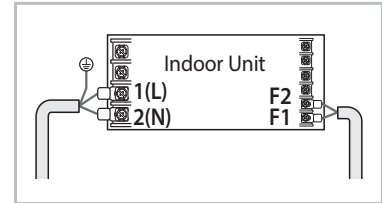

4. Set the indoor unit option by wireless remote controller.

SEG1	SEG2	SEG3	SEG4	SEG5	SEG6
0	2	RESERVED	Exterior temperature sensor	Central control	FAN RPM compensation
SEG7	SEG8	SEG9	SEG10	SEG11	SEG12
1	Drain pump	Hot water heater	Electronic heater	Opening the electronic expansion valve	Master / Slave
SEG13	SEG14	SEG15	SEG16	SEG17	SEG18
2	External control	External control output	S-Plasma ion	Buzzer	Number of hours using filter
SEG19	SEG20	SEG21	SEG22	SEG23	SEG24
3	Individual control of a remote controller	Heating setting compensation	EEV opening of an indoor unit stopped during oil return or Defrost operation.	-	Human sensor

- ▶ 1WAY/2WAY/4WAY MODEL : Drain pump(SEG8) will be set to 'USE + 3minute delay' even if the drain pump is set to 0.
- ▶ 1 WAY/2WAY/4WAY,DUCT MODEL : Number of hours using filter(SEG18) will be set to '1000hour' even if the SEG18 is set to except for 2 or 6.
- ▶ If you input a number other than 0~4 of the individual control of the indoor unit(SEG20), the indoor is set as indoor 1.
- ▶ SEG5 central control option is basically set as 1 (Use), so you don't need to set the central control option additionally. However, if the central control is not connected but it doesn't indicate an error message, you need to set the central control option as 0 (Disuse) to exclude the indoor unit from the central control.

Option No. : 02XXXX-1XXXX-2XXXX-3XXXX

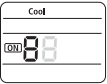
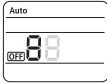
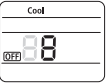
Option	SEG1		SEG2		SEG3		SEG4		SEG5		SEG6	
Explanation	PAGE		MODE		Use of robot cleaning		Use of external temperature sensor		Use of central control		FAN RPM compensation	
Remote Controller Display												
Indication and Details	Indication	Details	Indication	Details	Indication	Details	Indication	Details	Indication	Details	Indication	Details
	0		2		0	Disuse	0	Disuse	0	Disuse	0	Disuse
					1	Use	1	Use	1	Use	1	Use
											2	High ceiling KIT
Option	SEG7		SEG8		SEG9		SEG10		SEG11		SEG12	
Explanation	PAGE		Use of drain pump		Use of hot water heater		Use of electronic heater		Opening the electronic expansion valve of an indoor unit when heating operation stops.		Master / Slave	
Remote Controller Display												
Indication and Details	Indication	Details	Indication	Details	Indication	Details	Indication	Details	Indication	Details	Indication	Details
	1		0	Disuse	0	Disuse	0	Disuse	0	0	0	slave
			1	Use	1	Use	1	Use	1	80	1	master
2			Use + 3minute delay									
Option	SEG13		SEG14		SEG15		SEG16		SEG17		SEG18	
Explanation	PAGE		Use of external control		Setting the output of external control		S-Plasma ion		Buzzer control		Number of hours using filter	
Remote Controller Display												
Indication and Details	Indication	Details	Indication	Details	Indication	Details	Indication	Details	Indication	Details	Indication	Details
	2		0	Disuse	0	Thermo on	0	Disuse	0	Mixed operation control1/Use buzzer	2	1000 Hour
			1	ON/OFF Control	1	Operation on	1	Use	1	Mixed operation control1/Disuse of buzzer	6	2000 Hour
			2	OFF Control					2	Mixed operation control2/Use buzzer		
3	Mixed operation control2/Disuse of buzzer											
Option	SEG19		SEG20		SEG21		SEG22		SEG23		SEG24	
Explanation	PAGE		Individual control of a remote controller		Heating setting compensation		EEV opening of an indoor unit stopped during oil return or defrost operation.		-		Human sensor	
Remote Controller Display												
Indication and Details	Indication	Details	Indication	Details	Indication	Details	Indication	Details	Indication	Details	Indication	Details
	3		0 or 1	channel 1	0	Disuse	0	150 step			8	Disuse
			2	channel 2	1	2°C	1	0 step			9	Use
			3	channel 3								
4			channel 4									

► 360 cassette

You cannot set both of the indoor unit addresses and the installation options in a batch: set both of them respectively.

Common steps for setting the addresses and options

AR-KH00E remote control (for 360 cassette only)

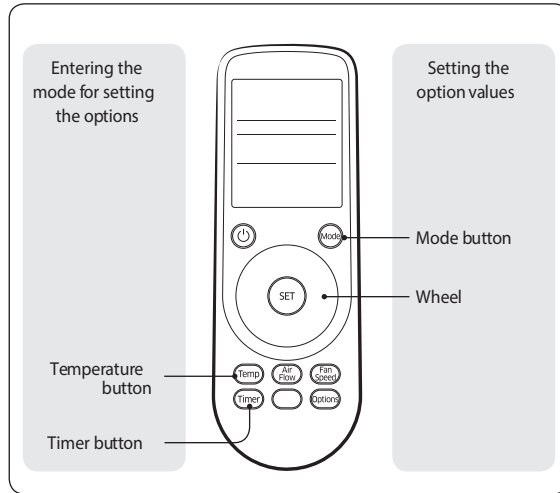

NOTE
The remote control display may vary depending on the model.

1. Enter the mode for setting the options:
 - a. Remove the batteries from the remote control.
 - b. While holding down the **Temp** (Temp) and **Timer** (Timer) buttons simultaneously, insert the batteries into the remote control.
 - c. Make sure that you are entered to the mode for setting the options:

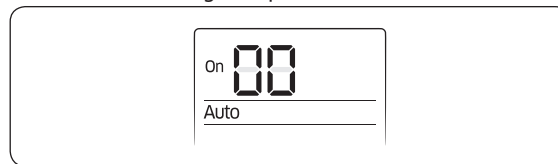

2. Set the option values.







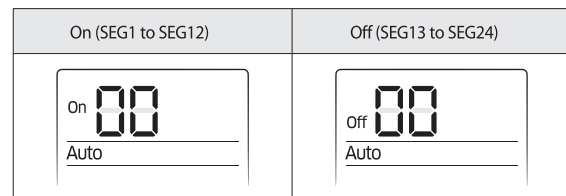



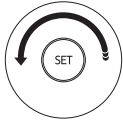
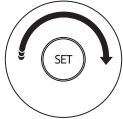





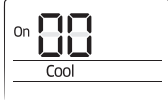
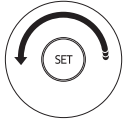

CAUTION

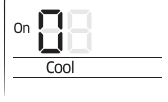
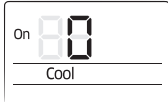



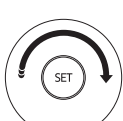

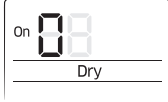
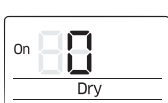



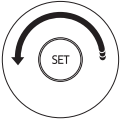
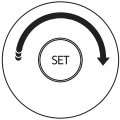

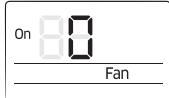

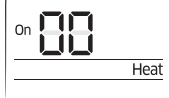
- The total number of available options are 24: SEG1 to SEG24.
- Because SEG1, SEG7, SEG13, and SEG19 are the page options used by the previous remote control models, the modes to set values for these options are skipped automatically.
- Set a 2-digit value for each option pair in the following order: SEG2 and SEG3 → SEG4 and SEG5 → SEG6 and SEG8 → SEG9 and SEG10 → SEG11 and SEG12 → SEG14 and SEG15 → SEG16 and SEG17 → SEG18 and SEG20 → SEG21 and SEG22 → SEG23 and SEG24.

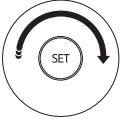



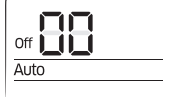
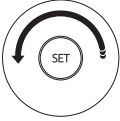
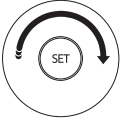



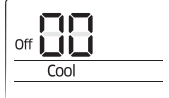
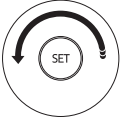
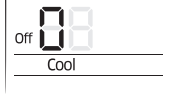

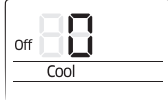





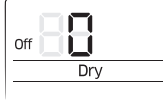

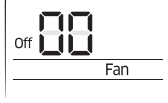
SEG1	SEG2	SEG3	SEG4	SEG5	SEG6
0	X	X	X	X	X
SEG7	SEG8	SEG9	SEG10	SEG11	SEG12
1	X	X	X	X	X
SEG13	SEG14	SEG15	SEG16	SEG17	SEG18
2	X	X	X	X	X
SEG19	SEG20	SEG21	SEG22	SEG23	SEG24
3	X	X	X	X	X

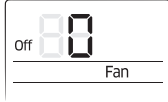

Take the steps presented in the following table:

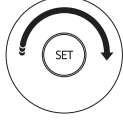

Steps	Remote control display
<p>1 Set the SEG2 and SEG3 values:</p> <p>a Set the SEG2 value by rotating the Wheel counterclockwise until the value you want to set appears on the remote control display.</p>  <p>b Set the SEG3 value by rotating the Wheel clockwise until the value you want to set appears on the remote control display.</p>  <p>When you rotate the Wheel, values appear in the following order:  → </p>	 <p>SEG2</p>  <p>SEG3</p>
<p>2 Press the  (Mode) button. Cool and On appear on the remote control display.</p>	
<p>3 Set the SEG4 and SEG5 values:</p> <p>a Set the SEG4 value by rotating the Wheel counterclockwise until the value you want to set appears on the remote control display.</p>  <p>b Set the SEG5 value by rotating the Wheel clockwise until the value you want to set appears on the remote control display.</p>  <p>When you rotate the Wheel, values appear in the following order:  → </p>	 <p>SEG4</p>  <p>SEG5</p>
<p>4 Press the  (Mode) button. Dry and On appear on the remote control display.</p>	
<p>5 Set the SEG6 and SEG8 values:</p> <p>a Set the SEG6 value by rotating the Wheel counterclockwise until the value you want to set appears on the remote control display.</p>  <p>b Set the SEG8 value by rotating the Wheel clockwise until the value you want to set appears on the remote control display.</p>  <p>When you rotate the Wheel, values appear in the following order:  → </p>	 <p>SEG6</p>  <p>SEG8</p>
<p>6 Press the  (Mode) button. Fan and On appear on the remote control display.</p>	

Steps	Remote control display
<p>7 Set the SEG9 and SEG10 values:</p> <p>a Set the SEG9 value by rotating the Wheel counterclockwise until the value you want to set appears on the remote control display.</p>  <p>b Set the SEG10 value by rotating the Wheel clockwise until the value you want to set appears on the remote control display.</p>  <p>When you rotate the Wheel, values appear in the following order: 0 → 1 → ... E → F</p>	 <p>SEG9</p>  <p>SEG10</p>
<p>8 Press the  (Mode) button. Heat and On appear on the remote control display.</p>	
<p>9 Set the SEG11 and SEG12 values:</p> <p>a Set the SEG11 value by rotating the Wheel counterclockwise until the value you want to set appears on the remote control display.</p>  <p>b Set the SEG12 value by rotating the Wheel clockwise until the value you want to set appears on the remote control display.</p>  <p>When you rotate the Wheel, values appear in the following order: 0 → 1 → ... E → F</p>	 <p>SEG11</p>  <p>SEG12</p>
<p>10 Press the  (Mode) button. Auto and Off appear on the remote control display.</p>	
<p>11 Set the SEG14 and SEG15 values:</p> <p>a Set the SEG14 value by rotating the Wheel counterclockwise until the value you want to set appears on the remote control display.</p>  <p>b Set the SEG15 value by rotating the Wheel clockwise until the value you want to set appears on the remote control display.</p>  <p>When you rotate the Wheel, values appear in the following order: 0 → 1 → ... E → F</p>	 <p>SEG14</p>  <p>SEG15</p>
<p>12 Press the  (Mode) button. Cool and Off appear on the remote control display.</p>	
<p>13 Set the SEG16 and SEG17 values:</p> <p>a Set the SEG16 value by rotating the Wheel counterclockwise until the value you want to set appears on the remote control display.</p> 	 <p>SEG16</p>

Steps	Remote control display
<p>b Set the SEG17 value by rotating the Wheel clockwise until the value you want to set appears on the remote control display.</p>  <p>When you rotate the Wheel, values appear in the following order: $\square \rightarrow \text{H} \rightarrow \dots \text{E} \rightarrow \text{F}$</p>	 <p>SEG17</p>
<p>14 Press the  (Mode) button. Dry and Off appear on the remote control display.</p>	
<p>15 Set the SEG18 and SEG20 values:</p> <p>a Set the SEG18 value by rotating the Wheel counterclockwise until the value you want to set appears on the remote control display.</p>  <p>b Set the SEG20 value by rotating the Wheel clockwise until the value you want to set appears on the remote control display.</p>  <p>When you rotate the Wheel, values appear in the following order: $\square \rightarrow \text{H} \rightarrow \dots \text{E} \rightarrow \text{F}$</p>	 <p>SEG18</p>  <p>SEG20</p>
<p>16 Press the  (Mode) button. Fan and Off appear on the remote control display.</p>	
<p>17 Set the SEG21 and SEG22 values:</p> <p>a Set the SEG21 value by rotating the Wheel counterclockwise until the value you want to set appears on the remote control display.</p>  <p>b Set the SEG22 value by rotating the Wheel clockwise until the value you want to set appears on the remote control display.</p>  <p>When you rotate the Wheel, values appear in the following order: $\square \rightarrow \text{H} \rightarrow \dots \text{E} \rightarrow \text{F}$</p>	 <p>SEG21</p>  <p>SEG22</p>
<p>18 Press the  (Mode) button. Heat and Off appear on the remote control display.</p>	
<p>19 Set the SEG23 and SEG24 values:</p> <p>a Set the SEG23 value by rotating the Wheel counterclockwise until the value you want to set appears on the remote control display.</p>  <p>b Set the SEG24 value by rotating the Wheel clockwise until the value you want to set appears on the remote control display.</p>  <p>When you rotate the Wheel, values appear in the following order: $\square \rightarrow \text{H} \rightarrow \dots \text{E} \rightarrow \text{F}$</p>	 <p>SEG23</p>  <p>SEG24</p>

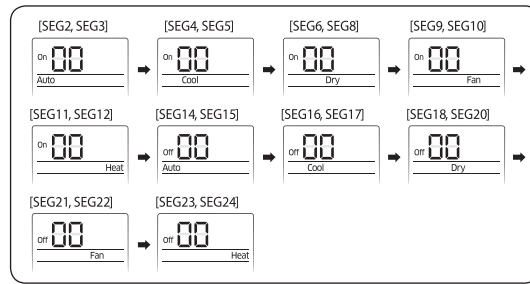
3. Check whether the option values that you have set are correct by pressing the  (Mode) button repeatedly.



4. Save the option values into the indoor unit: Point the remote control to the remote control sensor on the indoor unit and then press the  (Power) button on the remote control twice. Make sure that this command is received by the indoor unit. When it is successfully received, you can hear a short sound from the indoor unit. If the command is not received, press the  (Power) button again.
5. Check whether the air conditioner operates in accordance with the option values you have set:
- Reset the indoor unit by disconnecting and then reconnecting the power cable of the indoor unit or by pressing the RESET button on the outdoor unit.
 - Remove the batteries from the remote control, insert them again, and then press the  (Power) button on the remote control.

 NOTE

- If the fan is set to off for cooling only indoor unit by setting the SEG9=3 or SEG15=3, you need to use an external sensor or wired remote control sensor to detect indoor temperature exactly..

Installation options for the 02 series

SEG1	SEG2	SEG3	SEG4	SEG5	SEG6
0	2	-	Use of external temperature sensor / Minimizing fan operation when thermostat is off	Use of central control	Compensation of the fan RPM
SEG7	SEG8	SEG9	SEG10	SEG11	SEG12
1	Use of drain pump	Use of hot water heater	-	EEV step when heating stops	-
SEG13	SEG14	SEG15	SEG16	SEG17	SEG18
2	Use of external control	Setting the output of external control / External heater On or Off signal	-	Buzzer control	Maximum filter usage time
SEG19	SEG20	SEG21	SEG22	SEG23	SEG24
3	Individual control with remote control	Heating setting compensation offset / Removing condensated water in the Heat mode	EEV step of stopped unit during the oil return or the defrost mode	Motion detection sensor	Cycle time of Swing

- Even if you set the Use of drain pump (SEG8) option to 0, it is automatically set to 2 (the drain pump is used with 3 minute delay).
- If you set the Maximum filter usage time (SEG18) option to a value other than 2 and 6, it is automatically set to 2 (1000 hours).
- If you set an option to a value that is out of range specified above, the option is automatically set to 0 by default.
- The SEG5 option (Use of central control) is set to 1 (Use) by default. Therefore, you don't need to set the SEG5 option additionally. Note that even if the central control system is not connected, no errors occur. If you want a specific indoor unit not to be controlled by the central control system, set the SEG option of that indoor unit to 0 (Disuse).
- The external output of SEG15 is generated via MIM-B14 connection. (Refer to the manual of MIM-B14.)
- If you set the Individual control with remote control (SEG20) option to a value other than 0 to 4, it is automatically set to 0 (Indoor 1).

Installation options for the 02 series (detailed)

Option No. for an indoor unit address: 02XXXX-1XXXXX-2XXXXX-3XXXXX

Option	SEG1		SEG2		SEG3		SEG4			SEG5		SEG6	
Function	Page		Mode		-		Use of external temperature sensor / Minimizing fan operation when thermostat is off			Use of central control		Compensation of the fan RPM	
Indication and details	Indication	Details	Indication	Details	-	Indication	Details		Indication	Details	Indication	Details	
							Use of external temperature sensor	Minimizing fan operation when thermostat is off					
		0		2	-	0	Disuse	(Cooling, Heating) Disuse	0	Disuse	0	Disuse (recessed installation)	
	1					Use	(Cooling, Heating) Disuse						
	2					Disuse	(Heating) Use (*2)	1	Use	1	Use	1	High-ceiling mode (recessed installation)
	3					Use	(Heating) Use (*2)						
	4					Disuse	(Cooling) Use						
	5					Use	(Cooling) Use	5	High-ceiling mode (exposed installation)				
	6					Disuse	(Cooling, Heating) Use (*2)						
7	Use					(Cooling, Heating) Use (*2)							
Option	SEG7		SEG8		SEG9		SEG10			SEG11		SEG12	
Function	Page		Use of drain pump		Use of hot water heater		-			EEV step when heating stops		-	
Indication and detail	Indication	Details	Indication	Details	Indication	Details	-			Indication	Details	-	
	1	Use	1	Use (*3)	1	Noise decreasing setting							
	2	Use with 3 minute delay	2	-									
	1		3	Use (*3)									

Option	SEG13		SEG14		SEG15			SEG16		SEG17		SEG18		
Function	Page		Use of external control		Setting the output of external control / External heater On or Off signal			S-Plasma ion		Buzzer control		Maximum filter usage time		
Indication and details	Indication	Details	Indication	Details	Indication	Details		Indication	Details	Indication	Details	Indication	Details	
						Setting the output of external control	External heater On or Off signal							
				0	Disuse	0	Thermo On	-	0	Disuse	0	Use of buzzer	2	1000 hours
				1	ON or OFF control	1	Operation On	-						
				2	OFF control	2	-	Use (*4)	1	Use	1	Disuse of buzzer	6	2000 hours
			3	Window ON or OFF control	3	-	Use (*4)							
Option	SEG19		SEG20		SEG21			SEG22		SEG23		SEG24		
Function	Page		Individual control with remote control		Heating setting compensation offset / Removing condensated water in the Heat mode			EEV step of stopped unit during the oil return or the defrost mode		Motion detection sensor		Cycle time of Swing		
Indication and details	Indication	Details	Indication	Details	Indication	Details		Indication	Details	Indication	Details	Indication	Details	
						Heating setting compensation offset	Removing condensated water in the Heat mode							
				0 or 1	Indoor 1	0	Default (*5)	Disuse	0	Default	0	Disuse	0	34 seconds (default)
						1	2 °C	Disuse			1	Turn out in 30 min. without motion	1	30 seconds
				2	Indoor 2	2	5 °C	Disuse	1	Oil return or Noise decreasing in defrost mode	2	Turn out in 60 min. without motion	2	38 seconds

Indication and details	3	3	Indoor 3	3	Default (*5)	Use (*6)	1	Oil return or Noise decreasing in defrost mode	2	Turn out in 60 min. without motion	2	38 seconds
		4	Indoor 4	4	2 °C	Use (*6)			3	Turn out in 120 min. without motion		
				5	5 °C	Use (*6)			5	Turn out in 180 min. without motion		
		4	Indoor 4	5	5 °C	Use (*6)			6	Turn out in 60 min. without motion or advanced function (*1)		
									7	Turn out in 120 min. without motion or advanced function (*1)		
									8	Turn out in 180 min. without motion or advanced function (*1)		

(*1) Advanced function: Either controlling the cooling or heating current or power saving with motion detection.

(*2) Minimizing fan operation when thermostat is off :

The fan operates for 20 seconds at an interval of 5 minutes in the Heat mode.

(*3) 1: The fan is turned on continually when the hot water heater is turned on,

3: The fan is turned off when the hot water heater is turned on with cooling only indoor unit.

(Cooling only indoor unit: To use this option, install the Mode Select switch (MCM-C200) on the outdoor unit and fix it to the Cool mode.)

(*4) When the following 2 or 3 is used as external heater On or Off signal, the signal for monitoring external contact control will not be output.

2: The fan is turned on continually when the external heater is turned on,

3: The fan is turned off when the external heater is turned on with cooling only indoor unit

(Cooling only indoor unit: To use this option, install the Mode Select switch (MCM-C200) on the outdoor unit and fix it to the Cool mode.)

(*5) Default setting value: 5 °C

(*6) If the air conditioner operates in the Heat mode immediately after finishing the cooling operation, the condensated water in the drain pan becomes water steam by the heat of the indoor unit heat exchanger. Since the water steam might be condensed on the indoor unit, which may fall into a living space, use this function to remove the water steam out of the indoor unit by operating the fan (for maximum 20 minutes) although the indoor unit is turned off after the Cool mode is turned to the Heat mode.

Installation options for the 05 series

SEG1	SEG2	SEG3	SEG4	SEG5	SEG6
0	5	Use of the HR-specific auto changeover function in the Auto mode	(When setting SEG3) Offset for the heating reference temperature	(When setting SEG3) Offset for the cooling reference temperature	(When setting SEG3) Reference for change from Heat mode to Cool mode
SEG7	SEG8	SEG9	SEG10	SEG11	SEG12
1	(When setting SEG3) Reference for change from Cool mode to Heat mode	(When setting SEG3) Time required for mode change	Compensation option for a long pipe and the height difference between indoor units	-	-
SEG13	SEG14	SEG15	SEG16	SEG17	SEG18
2	-	-	-	-	Control variables when the hot water heater or an external heater is used
SEG19	SEG20	SEG21	SEG22	SEG23	SEG24
3	-	-	-	-	-

4-3-2 Option Items

Item	Model	SEG																								Static Pressure
		1	2	3	4	5	6	7	8	9	10	11	12	13	14	15	16	17	18	19	20	21	22	23	24	
Slim 1-Way Cassette	AM017HN1DEH/EU	0	1	D	0	4	4	1	9	6	0	8	5	2	0	2	0	2	0	3	3	0	0	0	0	
	AM022HN1DEH/EU	0	1	D	0	4	4	1	9	7	0	A	6	2	0	1	4	1	4	3	3	0	0	0	0	
	AM022FN1DEH/EU	0	1	7	0	4	4	1	1	8	0	C	8	2	0	1	6	1	6	3	3	0	0	1	0	
	AM028FN1DEH/EU	0	1	7	0	4	4	1	1	8	0	F	8	2	0	1	C	1	C	3	3	0	0	1	0	
	AM036FN1DEH/TL	0	1	7	0	4	4	1	1	5	4	5	D	2	0	2	4	2	4	3	3	0	0	1	0	
	AM036FN1DEH/EU	0	1	7	0	4	4	1	1	5	4	5	D	2	0	2	4	2	4	3	3	0	0	1	0	
	AM056FN1DEH/TL	0	1	8	0	4	4	1	9	5	4	3	C	2	0	3	8	3	8	3	3	0	0	1	0	
AM056FN1DEH/EU	0	1	8	0	4	4	1	9	5	4	5	F	2	0	4	7	4	7	3	3	0	0	1	0		
2-Way Cassette	AM056FN2DEH/TL	0	1	2	0	4	4	1	1	5	5	6	1	2	0	3	8	3	8	3	3	0	0	1	0	
	AM056FN2DEH/EU	0	1	2	0	4	4	1	1	5	5	6	1	2	0	3	8	3	8	3	3	0	0	1	0	
Global 4-Way Cassette	AM045FN4DEH/TL	0	1	4	0	4	F	1	9	5	0	9	7	2	0	2	D	2	D	3	3	0	0	0	0	
	AM045FN4DEH/EU	0	1	4	0	4	F	1	9	5	0	9	7	2	0	2	D	2	D	3	3	0	0	0	0	
	AM045FN4DEH/AR	0	1	4	0	4	F	1	9	5	0	9	7	2	0	2	D	2	D	3	3	0	0	0	0	
	AM056FN4DEH/TL	0	1	4	0	4	F	1	9	5	0	A	7	2	0	3	8	3	8	3	3	0	0	0	0	
	AM056FN4DEH/EU	0	1	4	0	4	F	1	9	5	0	A	7	2	0	3	8	3	8	3	3	0	0	0	0	
	AM056FN4DEH/AR	0	1	4	0	4	F	1	9	5	0	A	7	2	0	3	8	3	8	3	3	0	0	0	0	
	AM071FN4DEH/TL	0	1	4	0	4	F	1	9	4	0	B	8	2	0	4	7	4	7	3	3	0	0	0	0	
	AM071FN4DEH/EU	0	1	4	0	4	F	1	9	4	0	B	8	2	0	4	7	4	7	3	3	0	0	0	0	
	AM071FN4DEH/AR	0	1	4	0	4	F	1	9	4	0	B	8	2	0	4	7	4	7	3	3	0	0	0	0	
	AM090FN4DEH/TL	0	1	4	0	4	F	1	9	5	0	F	9	2	0	5	A	5	A	3	3	0	0	0	0	
AM090FN4DEH/EU	0	1	4	0	4	F	1	9	5	0	F	9	2	0	5	A	5	A	3	3	0	0	0	0		
AM090FN4DEH/AR	0	1	4	0	4	F	1	9	5	0	F	9	2	0	5	A	5	A	3	3	0	0	0	0		
AM112FN4DEH/TL	0	1	4	0	4	F	1	9	5	4	1	A	2	0	7	0	7	0	3	3	0	0	1	0		
AM112FN4DEH/EU	0	1	4	0	4	F	1	9	5	4	1	A	2	0	7	0	7	0	3	3	0	0	1	0		
AM112FN4DEH/AR	0	1	4	0	4	F	1	9	5	4	1	A	2	0	7	0	7	0	3	3	0	0	1	0		
AM128FN4DEH/TL	0	1	4	0	4	F	1	9	5	4	2	C	2	0	8	0	8	0	3	3	0	0	2	0		
AM128FN4DEH/EU	0	1	4	0	4	F	1	9	5	4	2	C	2	0	8	0	8	0	3	3	0	0	2	0		
AM128FN4DEH/AR	0	1	4	0	4	F	1	9	5	4	2	C	2	0	8	0	8	0	3	3	0	0	2	0		
AM140FN4DEH/TL	0	1	4	0	4	F	1	9	5	4	4	C	2	0	8	C	8	C	3	3	0	0	2	0		
AM140FN4DEH/EU	0	1	4	0	4	F	1	9	5	4	4	C	2	0	8	C	8	C	3	3	0	0	2	0		
AM140FN4DEH/AR	0	1	4	0	4	F	1	9	5	4	4	C	2	0	8	C	8	C	3	3	0	0	2	0		
BIG Duct	AM220FNHDEH/EU	0	1	1	0	5	4	1	9	5	0	9	7	2	0	D	C	D	C	3	3	1	1	1	0	5mmAq
		0	1	1	0	5	4	1	9	5	0	C	7	2	0	D	C	D	C	3	3	1	1	1	0	10mmAq
		0	1	1	0	5	4	1	9	5	0	E	8	2	0	D	C	D	C	3	3	1	1	1	0	15mmAq
		0	1	1	0	5	4	1	9	5	4	4	D	2	0	D	C	D	C	3	3	1	1	1	0	20mmAq
		0	1	1	0	5	4	1	9	5	4	9	F	2	0	D	C	D	C	3	3	1	1	1	0	25mmAq
	AM280FNHDEH/EU	0	1	1	0	5	4	1	9	5	4	0	7	2	3	1	C	1	C	3	3	1	1	1	0	5mmAq
		0	1	1	0	5	4	1	9	5	4	2	9	2	3	1	C	1	C	3	3	1	1	1	0	10mmAq
		0	1	1	0	5	4	1	9	5	4	5	B	2	3	1	C	1	C	3	3	1	1	1	0	15mmAq
		0	1	1	0	5	4	1	9	5	4	9	E	2	3	1	C	1	C	3	3	1	1	1	0	20mmAq
		0	1	1	0	5	4	1	9	5	5	D	1	2	3	1	C	1	C	3	3	1	1	1	0	25mmAq
0	1	1	0	5	4	1	9	5	5	F	3	2	3	1	C	1	C	3	3	1	1	1	0	28mmAq		
GD-S(Big Duct)	AM180JNHFKH/EU	0	1	2	0	7	4	1	C	5	0	8	0	2	0	B	4	B	4	3	3	1	1	1	0	5 ≤ SP < 7.5
		0	1	2	0	7	4	1	C	5	0	A	1	2	0	B	4	B	4	3	3	1	1	1	0	7.5 ≤ SP < 10
		0	1	2	0	7	4	1	C	5	0	D	3	2	0	B	4	B	4	3	3	1	1	1	0	10 ≤ SP < 12.5
		0	1	2	0	7	4	1	C	5	0	F	5	2	0	B	4	B	4	3	3	1	1	1	0	12.5 ≤ SP < 15
		0	1	2	0	7	4	1	C	5	4	3	7	2	0	B	4	B	4	3	3	1	1	1	0	15 ≤ SP < 17.5
	AM224JNHFKH/EU	0	1	2	0	7	4	1	C	5	4	4	8	2	0	B	4	B	4	3	3	1	1	1	0	17.5 ≤ SP ≤ 20
		0	1	2	0	7	4	1	C	5	0	C	0	2	0	E	0	E	0	3	3	1	1	1	0	5 ≤ SP < 7.5
		0	1	2	0	7	4	1	C	5	0	E	3	2	0	E	0	E	0	3	3	1	1	1	0	7.5 ≤ SP < 10
		0	1	2	0	7	4	1	C	5	0	F	5	2	0	E	0	E	0	3	3	1	1	1	0	10 ≤ SP < 12.5
		0	1	2	0	7	4	1	C	5	4	3	6	2	0	E	0	E	0	3	3	1	1	1	0	12.5 ≤ SP < 15
0	1	2	0	7	4	1	C	5	4	5	8	2	0	E	0	E	0	3	3	1	1	1	0	15 ≤ SP < 17.5		
0	1	2	0	7	4	1	C	5	4	8	E	2	0	E	0	E	0	3	3	1	1	1	0	17.5 ≤ SP ≤ 20		

Option Items(cont.)

Item	Model	SEG																								Static Pressure
		1	2	3	4	5	6	7	8	9	10	11	12	13	14	15	16	17	18	19	20	21	22	23	24	
Floor Standing	AM036FNFDEH/EU	0	1	A	0	5	4	1	0	5	0	0	0	2	0	2	4	2	4	3	3	0	0	1	0	
	AM056FNFDEH/EU	0	1	A	0	5	4	1	0	5	0	0	0	2	0	3	8	3	8	3	3	0	0	1	0	
	AM071FNFDEH/EU	0	1	A	0	5	4	1	0	5	0	0	0	2	0	4	7	4	7	3	3	0	0	1	0	
	AM036MNFDEH/EU	0	1	0	0	5	4	1	C	5	4	1	4	2	0	2	4	2	4	3	3	0	0	1	0	0mmAq
		0	1	0	0	5	4	1	C	5	9	1	1	2	0	2	4	2	4	3	3	0	0	1	0	3mmAq
		0	1	0	0	5	4	1	C	5	9	A	3	2	0	2	4	2	4	3	3	0	0	1	0	6mmAq
	AM056MNFDEH/EU	0	1	0	0	5	4	1	C	5	4	4	5	2	0	3	8	3	8	3	3	0	0	1	0	0mmAq
		0	1	0	0	5	4	1	C	5	9	1	1	2	0	3	8	3	8	3	3	0	0	1	0	3mmAq
		0	1	0	0	5	4	1	C	5	9	C	8	2	0	3	8	3	8	3	3	0	0	1	0	6mmAq
		0	1	0	0	5	4	1	C	5	4	4	5	2	0	4	7	4	7	3	3	0	0	1	0	0mmAq
AM071MNFDEH/EU	0	1	0	0	5	4	1	C	5	9	1	1	2	0	4	7	4	7	3	3	0	0	1	0	3mmAq	
	0	1	0	0	5	4	1	C	5	9	C	8	2	0	4	7	4	7	3	3	0	0	1	0	6mmAq	
	0	1	0	0	5	4	1	C	5	9	C	8	2	0	4	7	4	7	3	3	0	0	1	0	6mmAq	
ERV Plus	AM050FNKDEH/EU	0	1	E	0	4	4	1	9	5	5	7	3	2	0	4	7	4	7	3	3	2	0	2	0	
	AM100FNKDEH/EU	0	1	E	0	4	4	1	9	5	5	7	3	2	0	4	7	4	7	3	3	2	0	2	0	
Global 4Way Cassette (600x600)	AM015HNNDEH/EU	0	1	5	0	4	F	1	9	7	0	B	8	2	0	0	F	0	F	3	3	0	0	0	0	
	AM022FNNDEH/EU	0	1	5	0	4	F	1	9	7	0	E	8	2	0	1	6	1	6	3	3	0	0	0	0	
	AM028FNNDEH/EU	0	1	5	0	4	F	1	9	5	4	0	A	2	0	1	C	1	C	3	3	0	0	0	0	
	AM036FNNDEH/EU	0	1	5	0	4	F	1	9	3	4	2	C	2	0	2	4	2	4	3	3	0	0	0	0	
	AM045FNNDEH/EU	0	1	5	0	4	F	1	9	5	4	4	E	2	0	2	D	2	D	3	3	0	0	0	0	
	AM056FNNDEH/EU	0	1	5	0	4	F	1	9	5	4	7	F	2	0	3	8	3	8	3	3	0	0	0	0	
	AM060FNNDEH/EU	0	1	5	0	4	F	1	9	5	5	9	1	2	0	3	C	3	C	3	3	0	0	0	0	
SLIM DUCT-S	AM017FNLDEH/EU	0	1	0	0	5	4	1	2	5	4	9	E	2	0	1	1	1	1	3	3	1	1	1	0	0mmAq
		0	1	0	0	5	4	1	2	5	5	B	1	2	0	1	1	1	1	3	3	1	1	1	0	1mmAq
		0	1	0	0	5	4	1	2	5	5	F	5	2	0	1	1	1	1	3	3	1	1	1	0	3mmAq
	AM022FNLDEH/EU	0	1	0	0	5	4	1	2	5	E	0	8	2	0	1	6	1	6	3	3	1	1	1	0	3mmAq
		0	1	0	0	5	4	1	2	5	A	C	3	2	0	1	6	1	6	3	3	1	1	1	0	1mmAq
		0	1	0	0	5	4	1	2	5	A	8	0	2	0	1	6	1	6	3	3	1	1	1	0	0mmAq
	AM028FNLDEH/EU	0	1	0	0	5	4	1	2	5	E	7	A	2	0	1	C	1	C	3	3	1	1	1	0	3mmAq
		0	1	0	0	5	4	1	2	5	E	1	5	2	0	1	C	1	C	3	3	1	1	1	0	1mmAq
		0	1	0	0	5	4	1	2	5	A	E	2	2	0	1	C	1	C	3	3	1	1	1	0	0mmAq
		0	1	0	0	5	4	1	2	5	E	C	D	2	0	2	4	2	4	3	3	1	1	1	0	3mmAq
AM036FNLDEH/EU	0	1	0	0	5	4	1	2	5	E	6	8	2	0	2	4	2	4	3	3	1	1	1	0	1mmAq	
	0	1	0	0	5	4	1	2	5	E	3	5	2	0	2	4	2	4	3	3	1	1	1	0	0mmAq	
	0	1	0	0	5	4	1	2	5	E	F	6	2	0	2	D	2	D	3	3	1	1	1	0	4mmAq	
SLIM DUCT-1	AM045FNLDEH/EU	0	1	0	0	5	4	1	2	5	A	E	2	2	0	2	D	2	D	3	3	1	1	1	0	2mmAq
		0	1	0	0	5	4	1	2	5	9	9	F	2	0	2	D	2	D	3	3	1	1	1	0	0mmAq
		0	1	0	0	5	4	1	2	5	E	F	9	2	0	3	8	3	8	3	3	1	1	1	0	4mmAq
AM056FNLDEH/EU	0	1	0	0	5	4	1	2	5	E	3	4	2	0	3	8	3	8	3	3	1	1	1	0	2mmAq	
	0	1	0	0	5	4	1	2	5	A	C	1	2	0	3	8	3	8	3	3	1	1	1	0	0mmAq	
	0	1	0	0	5	4	1	2	5	E	F	4	2	0	4	7	4	7	3	3	1	1	1	0	4mmAq	
SLIM DUCT-2	AM071FNLDEH/EU	0	1	0	0	5	4	1	2	5	D	9	E	2	0	4	7	4	7	3	3	1	1	1	0	2mmAq
		0	1	0	0	5	4	1	2	5	9	B	B	2	0	4	7	4	7	3	3	1	1	1	0	0mmAq
		0	1	0	0	5	4	1	2	5	E	2	A	2	0	5	A	5	A	3	3	1	1	1	0	6mmAq
SLIM DUCT-3	AM090FNLDEH/EU	0	1	0	0	5	4	1	B	5	A	D	4	2	0	5	A	5	A	3	3	1	1	1	0	3mmAq
		0	1	0	0	5	4	1	B	5	9	6	C	2	0	5	A	5	A	3	3	1	1	1	0	0mmAq
		0	1	0	0	5	4	1	B	5	E	2	A	2	0	7	0	7	0	3	3	1	1	1	0	6mmAq
	AM112FNLDEH/EU	0	1	0	0	5	4	1	B	5	A	D	4	2	0	7	0	7	0	3	3	1	1	1	0	3mmAq
		0	1	0	0	5	4	1	B	5	9	6	C	2	0	7	0	7	0	3	3	1	1	1	0	0mmAq
		0	1	0	0	5	4	1	B	5	E	8	F	2	0	8	0	8	0	3	3	1	1	1	0	6mmAq
	AM128FNLDEH/EU	0	1	0	0	5	4	1	B	5	E	4	B	2	0	8	0	8	0	3	3	1	1	1	0	3mmAq
		0	1	0	0	5	4	1	B	5	A	F	5	2	0	8	0	8	0	3	3	1	1	1	0	0mmAq
		0	1	0	0	5	4	1	B	5	F	C	3	2	0	8	C	8	C	3	3	1	1	1	0	6mmAq
	AM140FNLDEH/EU	0	1	0	0	5	4	1	B	5	E	7	F	2	0	8	C	8	C	3	3	1	1	1	0	3mmAq
0		1	0	0	5	4	1	B	5	E	3	A	2	0	8	C	8	C	3	3	1	1	1	0	0mmAq	
0		1	0	0	5	4	1	3	5	5	E	4	2	0	1	6	1	6	3	3	1	1	1	0	6mmAq	
0		1	0	0	5	4	1	3	5	4	1	E	2	0	1	6	1	6	3	3	1	1	1	0	4mmAq	
SLIM DUCT-1 (Uplevel Static Pressure)	AM022FNMDEH/EU	0	1	0	0	5	4	1	3	5	0	E	A	2	0	1	6	1	6	3	3	1	1	1	0	2mmAq
		0	1	0	0	5	4	1	3	5	0	E	A	2	0	1	6	1	6	3	3	1	1	1	0	0mmAq
		0	1	0	0	5	4	1	3	5	9	A	9	2	0	1	C	1	C	3	3	1	1	1	0	6mmAq
		0	1	0	0	5	4	1	3	5	5	6	2	2	0	1	C	1	C	3	3	1	1	1	0	4mmAq
	AM028FNMDEH/EU	0	1	0	0	5	4	1	3	5	4	2	C	2	0	1	C	1	C	3	3	1	1	1	0	2mmAq
		0	1	0	0	5	4	1	3	5	0	E	8	2	0	1	C	1	C	3	3	1	1	1	0	0mmAq
		0	1	0	0	5	4	1	3	5	4	C	F	2	0	2	4	2	4	3	3	1	1	1	0	6mmAq
	AM036FNMDEH/EU	0	1	0	0	5	4	1	3	5	4	2	C	2	0	2	4	2	4	3	3	1	1	1	0	4mmAq
		0	1	0	0	5	4	1	3	5	0	F	B	2	0	2	4	2	4	3	3	1	1	1	0	2mmAq
		0	1	0	0	5	4	1	3	5	0	E	A	2	0	2	4	2	4	3	3	1	1	1	0	0mmAq

Option Items(cont.)

Item	Model	SEG																								Static Pressure	
		1	2	3	4	5	6	7	8	9	10	11	12	13	14	15	16	17	18	19	20	21	22	23	24		
MSP DUCT-S [Uplevel Static Pressure]	AM045FNMDEH/EU	0	1	0	0	5	4	1	2	5	9	0	6	2	0	2	D	2	D	3	3	1	1	1	0	8mmAq	
		0	1	0	0	5	4	1	2	5	5	A	4	2	0	2	D	2	D	3	3	1	1	1	0	6mmAq	
		0	1	0	0	5	4	1	2	5	5	7	1	2	0	2	D	2	D	3	3	1	1	1	0	4mmAq	
		0	1	0	0	5	4	1	2	5	5	5	0	2	0	2	D	2	D	3	3	1	1	1	0	2mmAq	
MSP DUCT-S	AM056FNMDEH/EU	0	1	0	0	5	4	1	2	5	9	5	7	2	0	3	8	3	8	3	3	1	1	1	0	8mmAq	
		0	1	0	0	5	4	1	2	5	5	F	5	2	0	3	8	3	8	3	3	1	1	1	0	6mmAq	
		0	1	0	0	5	4	1	2	5	5	C	5	2	0	3	8	3	8	3	3	1	1	1	0	4mmAq	
		0	1	0	0	5	4	1	2	5	5	9	3	2	0	3	8	3	8	3	3	1	1	1	0	2mmAq	
	AM071FNMDEH/EU	0	1	0	0	5	4	1	2	5	5	7	1	2	0	3	8	3	8	3	3	1	1	1	0	0mmAq	
		0	1	0	0	5	4	1	2	5	D	F	C	2	0	4	7	4	7	3	3	1	1	1	0	8mmAq	
		0	1	0	0	5	4	1	2	5	D	F	9	2	0	4	7	4	7	3	3	1	1	1	0	6mmAq	
		0	1	0	0	5	4	1	2	5	9	7	9	2	0	4	7	4	7	3	3	1	1	1	0	4mmAq	
		0	1	0	0	5	4	1	2	5	9	3	6	2	0	4	7	4	7	3	3	1	1	1	0	2mmAq	
		0	1	0	0	5	4	1	2	5	9	0	4	2	0	4	7	4	7	3	3	1	1	1	0	0mmAq	
MSP DUCT-0	AM090FNMDEH/EU	0	1	0	0	5	4	1	2	5	D	F	D	2	0	5	A	5	A	3	3	1	1	1	0	8mmAq	
		0	1	0	0	5	4	1	2	5	D	2	9	2	0	5	A	5	A	3	3	1	1	1	0	6mmAq	
HSP Duct	AM112FNHDEH/EU	0	1	0	0	5	4	1	3	5	5	E	8	2	0	7	0	7	0	3	3	1	1	1	0	4mmAq	
		0	1	0	0	5	4	1	3	5	9	8	F	2	0	7	0	7	0	3	3	1	1	1	0	5mmAq	
		0	1	0	0	5	4	1	3	5	E	1	9	2	0	7	0	7	0	3	3	1	1	1	0	10mmAq	
		0	1	0	0	5	4	1	3	5	E	7	0	2	0	7	0	7	0	3	3	1	1	1	0	15mmAq	
	AM128FNHDEH/EU	0	1	0	0	5	4	1	3	5	9	1	C	2	0	8	0	8	0	3	3	1	1	1	0	20mmAq	
		0	1	0	0	5	4	1	3	5	A	C	4	2	0	8	0	8	0	3	3	1	1	1	0	5mmAq	
		0	1	0	0	5	4	1	3	5	E	4	E	2	0	8	0	8	0	3	3	1	1	1	0	10mmAq	
		0	1	0	0	5	4	1	3	5	F	9	5	2	0	8	0	8	0	3	3	1	1	1	0	15mmAq	
	AM140FNHDEH/EU	0	1	0	0	5	4	1	3	5	F	9	5	2	0	8	0	8	0	3	3	1	1	1	0	20mmAq	
		0	1	0	0	5	4	1	3	5	E	5	E	2	0	8	C	8	C	3	3	1	1	1	0	5mmAq	
		0	1	0	0	5	4	1	3	5	E	0	9	2	0	8	C	8	C	3	3	1	1	1	0	10mmAq	
		0	1	0	0	5	4	1	3	5	F	7	1	2	0	8	C	8	C	3	3	1	1	1	0	15mmAq	
	MSP DUCT-1	AM112FNMDEH/EU	0	1	0	0	5	4	1	2	2	F	F	0	2	0	7	0	7	0	3	3	1	1	1	0	20mmAq
			0	1	0	0	5	4	1	2	2	F	F	0	2	0	7	0	7	0	3	3	1	1	1	0	12mmAq
			0	1	0	0	5	4	1	2	2	E	B	B	2	0	7	0	7	0	3	3	1	1	1	0	10mmAq
			0	1	0	0	5	4	1	2	2	E	2	6	2	0	7	0	7	0	3	3	1	1	1	0	8mmAq
0			1	0	0	5	4	1	2	2	E	0	4	2	0	7	0	7	0	3	3	1	1	1	0	6mmAq	
0			1	0	0	5	4	1	2	2	E	6	9	2	0	8	0	8	0	3	3	1	1	1	0	4mmAq	
MSP DUCT-2	AM128FNMDEH/EU	0	1	0	0	5	4	1	2	2	E	6	9	2	0	8	0	8	0	3	3	1	1	1	0	14mmAq	
		0	1	0	0	5	4	1	2	2	E	4	7	2	0	8	0	8	0	3	3	1	1	1	0	12mmAq	
		0	1	0	0	5	4	1	2	2	E	1	5	2	0	8	0	8	0	3	3	1	1	1	0	10mmAq	
		0	1	0	0	5	4	1	2	2	A	E	3	2	0	8	0	8	0	3	3	1	1	1	0	8mmAq	
		0	1	0	0	5	4	1	2	2	A	C	1	2	0	8	0	8	0	3	3	1	1	1	0	6mmAq	
		0	1	0	0	5	4	1	2	2	9	9	F	2	0	8	0	8	0	3	3	1	1	1	0	4mmAq	
	AM140FNMDEH/EU	0	1	0	0	5	4	1	2	2	E	F	F	2	0	8	C	8	C	3	3	1	1	1	0	14mmAq	
		0	1	0	0	5	4	1	2	2	E	D	2	0	8	C	8	C	3	3	1	1	1	0	12mmAq		
		0	1	0	0	5	4	1	2	2	E	7	A	2	0	8	C	8	C	3	3	1	1	1	0	10mmAq	
		0	1	0	0	5	4	1	2	2	E	5	7	2	0	8	C	8	C	3	3	1	1	1	0	8mmAq	
		0	1	0	0	5	4	1	2	2	E	2	5	2	0	8	C	8	C	3	3	1	1	1	0	6mmAq	
		0	1	0	0	5	4	1	2	2	A	F	2	2	0	8	C	8	C	3	3	1	1	1	0	4mmAq	
		0	1	0	0	5	4	1	2	5	E	F	E	2	0	A	0	A	0	3	3	1	1	1	0	14mmAq	
		0	1	0	0	5	4	1	2	5	E	F	D	2	0	A	0	A	0	3	3	1	1	1	0	12mmAq	
		0	1	0	0	5	4	1	2	5	E	F	C	2	0	A	0	A	0	3	3	1	1	1	0	10mmAq	
		0	1	0	0	5	4	1	2	5	E	D	B	2	0	A	0	A	0	3	3	1	1	1	0	8mmAq	
360 cassette	AM045KN4DEH*	0	1	0	0	4	F	1	9	5	0	B	7	2	0	2	D	2	D	3	3	0	0	0	0	-	
	AM056KN4DEH*	0	1	0	0	4	F	1	9	5	0	C	7	2	0	3	8	3	8	3	3	0	0	0	0	-	
	AM071KN4DEH*	0	1	0	0	4	F	1	9	5	0	D	8	2	0	4	7	4	7	3	3	0	0	0	0	-	
	AM090KN4DEH*	0	1	0	0	4	F	1	9	5	4	1	A	2	0	5	A	5	A	3	3	0	0	0	0	-	
	AM112KN4DEH*	0	1	0	0	4	F	1	9	5	4	2	B	2	0	7	0	7	0	3	3	0	0	2	0	-	
	AM128KN4DEH*	0	1	0	0	4	F	1	9	5	4	6	C	2	0	8	0	8	0	3	3	0	0	2	0	-	
AM140KN4DEH*	0	1	0	0	4	F	1	9	5	4	8	E	2	0	8	C	8	C	3	3	0	0	2	0	-		

Option Items(cont.)

Item	Model	SEG																								Static Pressure	
		1	2	3	4	5	6	7	8	9	10	11	12	13	14	15	16	17	18	19	20	21	22	23	24		
Duct S	AM036HNMPKH/EU	0	1	0	0	5	4	1	C	5	0	8	1	2	0	2	4	2	4	3	3	1	2	0	5	0≤SP≤2.5	
		0	1	0	0	5	4	1	C	5	0	E	3	2	0	2	4	2	4	3	3	1	2	0	5	2.5<SP≤5	
		0	1	0	0	5	4	1	C	5	4	5	9	2	0	2	4	2	4	3	3	1	2	0	5	5<SP≤7.5	
		0	1	0	0	5	4	1	C	5	4	C	D	2	0	2	4	2	4	3	3	1	2	0	5	7.5<SP≤10	
		0	1	0	0	5	4	1	C	5	9	3	1	2	0	2	4	2	4	3	3	1	2	0	5	10<SP≤12.5	
	AM045HNMPKH/EU	0	1	0	0	5	4	1	C	5	9	8	3	2	0	2	4	2	4	3	3	1	2	0	5	12.5<SP≤15	
		0	1	0	0	5	4	1	C	5	0	D	1	2	0	2	D	2	D	3	3	1	2	0	4	0≤SP≤3	
		0	1	0	0	5	4	1	C	5	4	5	3	2	0	2	D	2	D	3	3	1	2	0	4	3<SP≤6	
		0	1	0	0	5	4	1	C	5	4	C	7	2	0	2	D	2	D	3	3	1	2	0	4	6<SP≤9	
		0	1	0	0	5	4	1	C	5	8	3	B	2	0	2	D	2	D	3	3	1	2	0	4	9<SP≤12	
Duct S	AM056HNMPKH/EU	0	1	0	0	5	4	1	C	5	8	A	F	2	0	2	D	2	D	3	3	1	2	0	4	12<SP≤15	
		0	1	0	0	5	4	1	C	5	0	F	1	2	0	3	8	3	8	3	3	1	2	0	3	0≤SP≤3	
		0	1	0	0	5	4	1	C	5	4	4	7	2	0	3	8	3	8	3	3	1	2	0	3	3<SP≤6	
		0	1	0	0	5	4	1	C	5	4	A	B	2	0	3	8	3	8	3	3	1	2	0	3	6<SP≤9	
		0	1	0	0	5	4	1	C	5	8	1	F	2	0	3	8	3	8	3	3	1	2	0	3	9<SP≤12	
	AM071HNMPKH/EU	0	1	0	0	5	4	1	C	5	9	7	3	2	0	3	8	3	8	3	3	1	2	0	3	12<SP≤15	
		0	1	0	0	5	4	1	C	5	4	8	D	2	0	4	7	4	7	3	3	1	2	0	1	0≤SP≤3	
		0	1	0	0	5	4	1	C	5	5	E	1	2	0	4	7	4	7	3	3	1	2	0	1	3<SP≤6	
		0	1	0	0	5	4	1	C	5	9	3	5	2	0	4	7	4	7	3	3	1	2	0	1	6<SP≤9	
		0	1	0	0	5	4	1	C	5	9	8	9	2	0	4	7	4	7	3	3	1	2	0	1	9<SP≤12	
Duct S	AM090HNMPKH/EU	0	1	0	0	5	4	1	C	5	9	D	F	2	0	4	7	4	7	3	3	1	2	0	1	12<SP≤15	
		0	1	0	0	5	4	1	C	5	4	6	D	2	0	5	A	5	A	3	3	1	2	1	2	0≤SP≤4	
		0	1	0	0	5	4	1	C	5	5	E	3	2	0	5	A	5	A	3	3	1	2	1	2	4<SP≤8	
		0	1	0	0	5	4	1	C	5	9	6	9	2	0	5	A	5	A	3	3	1	2	1	2	8<SP≤12	
	AM112HNMPKH/EU	0	1	0	0	5	4	1	C	5	9	C	D	2	0	5	A	5	A	3	3	1	2	1	2	12<SP≤15	
		0	1	0	0	5	4	1	C	5	4	1	2	2	0	7	0	7	0	3	3	1	2	2	3	0≤SP≤5.2	
		0	1	0	0	5	4	1	C	5	4	6	6	2	0	7	0	7	0	3	3	1	2	2	3	5.2<SP≤8	
		0	1	0	0	5	4	1	C	5	4	E	A	2	0	7	0	7	0	3	3	1	2	2	3	8<SP≤12	
	AM128HNMPKH/EU	0	1	0	0	5	4	1	C	5	8	3	E	2	0	7	0	7	0	3	3	1	2	2	3	12<SP≤15	
		0	1	0	0	5	4	1	C	5	4	2	6	2	0	8	0	8	0	3	3	1	2	2	2	0≤SP≤5.2	
		0	1	0	0	5	4	1	C	5	4	7	8	2	0	8	0	8	0	3	3	1	2	2	2	5.2<SP≤8	
		0	1	0	0	5	4	1	C	5	4	E	E	2	0	8	0	8	0	3	3	1	2	2	2	8<SP≤12	
	AM140HNMPKH/EU	0	1	0	0	5	4	1	C	5	9	2	0	2	0	8	0	8	0	3	3	1	2	2	2	12<SP≤15	
		0	1	0	0	5	4	1	C	5	4	4	4	2	0	8	C	8	C	3	3	1	2	2	1	0≤SP≤5.2	
		0	1	0	0	5	4	1	C	5	4	9	8	2	0	8	C	8	C	3	3	1	2	2	1	5.2<SP≤8	
		0	1	0	0	5	4	1	C	5	4	F	A	2	0	8	C	8	C	3	3	1	2	2	1	8<SP≤12	
	AM112HNHPKH/EU	0	1	0	0	5	4	1	C	5	8	3	E	2	0	8	C	8	C	3	3	1	2	2	1	12<SP≤15	
		0	1	0	0	5	4	1	C	5	4	4	6	2	0	7	0	7	0	3	3	1	2	2	6	3≤SP≤6.2	
		0	1	0	0	5	4	1	C	5	4	A	7	2	0	7	0	7	0	3	3	1	2	2	6	6.2<SP≤9	
		0	1	0	0	5	4	1	C	5	4	C	9	2	0	7	0	7	0	3	3	1	2	2	6	9<SP≤11	
		0	1	0	0	5	4	1	C	5	8	0	B	2	0	7	0	7	0	3	3	1	2	2	6	11<SP≤13	
		0	1	0	0	5	4	1	C	5	8	4	D	2	0	7	0	7	0	3	3	1	2	2	6	13<SP≤15	
		0	1	0	0	5	4	1	C	5	8	7	F	2	0	7	0	7	0	3	3	1	2	2	6	15<SP≤17	
		0	1	0	0	5	4	1	C	5	9	A	1	2	0	7	0	7	0	3	3	1	2	2	6	17<SP≤19	
		0	1	0	0	5	4	1	C	5	9	B	2	2	0	7	0	7	0	3	3	1	2	2	6	19<SP≤20	
		AM128HNHPKH/EU	0	1	0	0	5	4	1	C	5	4	6	6	2	0	8	0	8	0	3	3	1	2	2	5	3≤SP≤6.2
			0	1	0	0	5	4	1	C	5	4	B	9	2	0	8	0	8	0	3	3	1	2	2	5	6.2<SP≤9
			0	1	0	0	5	4	1	C	5	4	E	C	2	0	8	0	8	0	3	3	1	2	2	5	9<SP≤11
	0		1	0	0	5	4	1	C	5	8	1	E	2	0	8	0	8	0	3	3	1	2	2	5	11<SP≤13	
	0		1	0	0	5	4	1	C	5	9	4	0	2	0	8	0	8	0	3	3	1	2	2	5	13<SP≤15	
	0		1	0	0	5	4	1	C	5	9	8	2	2	0	8	0	8	0	3	3	1	2	2	5	15<SP≤17	
	0		1	0	0	5	4	1	C	5	9	B	3	2	0	8	0	8	0	3	3	1	2	2	5	17<SP≤19	
	0		1	0	0	5	4	1	C	5	9	C	4	2	0	8	0	8	0	3	3	1	2	2	5	19<SP≤20	
	AM140HNHPKH/EU	0	1	0	0	5	4	1	C	5	4	8	6	2	0	8	C	8	C	3	3	1	2	2	4	3≤SP≤6.2	
		0	1	0	0	5	4	1	C	5	4	D	7	2	0	8	C	8	C	3	3	1	2	2	4	6.2<SP≤9	
		0	1	0	0	5	4	1	C	5	8	0	9	2	0	8	C	8	C	3	3	1	2	2	4	9<SP≤11	
		0	1	0	0	5	4	1	C	5	8	3	B	2	0	8	C	8	C	3	3	1	2	2	4	11<SP≤13	
		0	1	0	0	5	4	1	C	5	8	6	D	2	0	8	C	8	C	3	3	1	2	2	4	13<SP≤15	
		0	1	0	0	5	4	1	C	5	8	8	F	2	0	8	C	8	C	3	3	1	2	2	4	15<SP≤17	
		0	1	0	0	5	4	1	C	5	9	C	0	2	0	8	C	8	C	3	3	1	2	2	4	17<SP≤19	
0		1	0	0	5	4	1	C	5	9	D	1	2	0	8	C	8	C	3	3	1	2	2	4	19<SP≤20		
CEILING	AM056FNCDEH/EU	0	1	3	0	5	4	1	0	5	0	0	2	0	3	8	3	8	3	3	0	0	1	0			
	AM071FNCDEH/EU	0	1	3	0	5	4	1	0	5	0	0	0	2	0	4	7	4	7	3	3	0	0	1	0		
Big Ceiling	AM112JNC DKH/EU	0	1	3	0	5	4	1	C	2	4	7	9	2	0	7	0	7	0	3	3	0	0	0	0		
	AM140JNC DKH/EU	0	1	3	0	5	4	1	C	5	4	B	E	2	0	8	C	8	C	3	3	0	0	0	0		

Option Items(cont.)

Item	Model	SEG																								Static Pressure
		1	2	3	4	5	6	7	8	9	10	11	12	13	14	15	16	17	18	19	20	21	22	23	24	
CONSOLE	AM022KNJDEH/EU	0	1	9	0	4	4	1	9	5	0	7	4	2	0	1	6	1	6	3	3	0	0	1	0	
	AM028FNJDEH/EU	0	1	9	0	4	4	1	9	5	0	B	7	2	0	1	C	1	C	3	3	0	0	1	0	
	AM036FNJDEH/EU	0	1	9	0	4	4	1	9	5	0	D	7	2	0	2	4	2	4	3	3	0	0	1	0	
	AM045KNJDEH/EU	0	1	9	0	4	4	1	9	5	0	F	9	2	0	2	D	2	D	3	3	0	0	1	0	
NEO-FORTE without EEV	AM056FNJDEH/EU	0	1	9	0	4	4	1	9	5	4	1	B	2	0	3	8	3	8	3	3	0	0	1	0	
	AM015HNTDEH/EU	0	1	0	0	4	4	1	1	7	0	B	8	2	0	0	F	0	F	3	3	0	0	0	0	
	AM022FNTDEH/EU	0	1	0	0	4	4	1	1	7	0	F	A	2	0	1	6	1	6	3	3	0	0	0	0	
	AM028FNTDEH/EU	0	1	0	0	4	4	1	1	7	0	F	A	2	0	1	C	1	C	3	3	0	0	0	0	
	AM036FNTDEH/EU	0	1	0	0	4	4	1	1	7	4	4	D	2	0	2	4	2	4	3	3	0	0	0	0	
NEO-FORTE with EEV	AM056FNTDEH/EU	0	1	0	0	4	4	1	1	6	4	6	F	2	0	3	8	3	8	3	3	0	0	2	0	
	AM071FNTDEH/EU	0	1	0	0	4	4	1	1	6	4	8	F	2	0	4	7	4	7	3	3	0	0	2	0	
	AM015HNQDEH/EU	0	1	0	0	4	4	1	1	7	0	B	8	2	0	0	F	0	F	3	1	0	0	0	0	
	AM022FNQDEH/EU	0	1	0	0	4	4	1	1	7	0	F	A	2	0	1	6	1	6	3	1	0	0	0	0	
	AM028FNQDEH/EU	0	1	0	0	4	4	1	1	7	0	F	A	2	0	1	C	1	C	3	1	0	0	0	0	
Hydro unit	AM036FNQDEH/EU	0	1	0	0	4	4	1	1	7	4	4	D	2	0	2	4	2	4	3	1	0	0	0	0	
	AM045FNQDEH/EU	0	1	0	0	4	4	1	1	6	4	3	F	2	0	2	D	2	D	3	1	0	0	2	0	
	AM056FNQDEH/EU	0	1	0	0	4	4	1	1	6	4	6	F	2	0	3	8	3	8	3	1	0	0	2	0	
	AM071FNQDEH/EU	0	1	0	0	4	4	1	1	6	4	8	F	2	0	4	7	4	7	3	1	0	0	2	0	
Hydro unit HT	AM160FNBDEH/EU	0	1	0	0	4	C	1	0	5	0	0	0	2	0	8	C	8	C	3	3	2	2	0	0	
	AM320FNBDEH/EU	0	1	0	0	4	C	1	0	5	0	0	0	2	3	1	C	1	C	3	3	2	2	0	0	
	AM500FNBDEH/EU	0	1	0	0	4	C	1	0	5	0	0	0	2	3	2	D	2	D	3	3	2	2	0	0	
A3050 (EEV INCLUDED)	AM160FNBFB/EU	0	1	1	0	4	C	1	0	5	0	0	0	2	0	A	0	A	0	3	3	2	2	0	0	
	AM250FNBFB/EU	0	1	1	0	4	C	1	0	5	0	0	0	2	0	F	A	F	A	3	3	2	1	0	0	
	AM160FNBFBG/EU	0	1	1	0	4	C	1	0	5	0	0	0	2	0	A	0	A	0	3	3	2	2	0	0	
	AM250FNBFBG/EU	0	1	1	0	4	C	1	0	5	0	0	0	2	0	F	A	F	A	3	3	2	1	0	0	
A3050 (EEV NOT INCLUDED)	AM015JNVDKH/EU	0	1	2	0	4	4	1	9	9	0	D	9	2	0	0	F	0	F	3	1	0	0	0	0	
	AM022JNVDKH/EU	0	1	2	0	4	4	1	9	9	4	2	A	2	0	1	6	1	6	3	1	0	0	0	0	
	AM028JNVDKH/EU	0	1	2	0	4	4	1	9	9	4	5	C	2	0	1	C	1	C	3	1	0	0	0	0	
	AM036JNVDKH/EU	0	1	2	0	4	4	1	9	8	4	5	E	2	0	2	4	2	4	3	1	0	0	1	0	
	AM045JNVDKH/EU	0	1	2	0	4	4	1	9	5	5	A	2	2	0	2	D	2	D	3	1	0	0	1	0	
	AM056JNVDKH/EU	0	1	2	0	4	4	1	9	9	4	2	C	2	0	3	8	3	8	3	1	0	0	2	0	
A3050 (EEV INCLUDED)	AM071JNVDKH/EU	0	1	2	0	4	4	1	9	8	4	7	F	2	0	4	7	4	7	3	1	0	0	2	0	
	AM082JNVDKH/EU	0	1	2	0	4	4	1	9	5	5	A	3	2	0	5	2	5	2	3	1	0	0	2	0	
	AM015JNADKH/EU	0	1	2	0	4	4	1	9	9	0	D	9	2	0	0	F	0	F	3	3	0	0	0	0	
	AM022JNADKH/EU	0	1	2	0	4	4	1	9	9	4	2	A	2	0	1	6	1	6	3	3	0	0	0	0	
	AM028JNADKH/EU	0	1	2	0	4	4	1	9	9	4	5	C	2	0	1	C	1	C	3	3	0	0	0	0	
	AM036JNADKH/EU	0	1	2	0	4	4	1	9	8	4	5	E	2	0	2	4	2	4	3	3	0	0	1	0	
	AM045JNADKH/EU	0	1	2	0	4	4	1	9	5	5	A	2	2	0	2	D	2	D	3	3	0	0	1	0	
A3050 (EEV NOT INCLUDED)	AM056JNADKH/EU	0	1	2	0	4	4	1	9	9	4	2	C	2	0	3	8	3	8	3	3	0	0	2	0	
	AM071JNADKH/EU	0	1	2	0	4	4	1	9	8	4	7	F	2	0	4	7	4	7	3	3	0	0	2	0	
	AM082JNADKH/EU	0	1	2	0	4	4	1	9	5	5	A	3	2	0	5	2	5	2	3	3	0	0	2	0	
	AM015JNVDKH/TK	0	1	2	0	4	4	1	9	9	0	D	9	2	0	0	F	0	F	3	1	0	0	0	0	
	AM022JNVDKH/TK	0	1	2	0	4	4	1	9	9	4	2	A	2	0	1	6	1	6	3	1	0	0	0	0	
	AM028JNVDKH/TK	0	1	2	0	4	4	1	9	9	4	5	C	2	0	1	C	1	C	3	1	0	0	0	0	
	AM036JNVDKH/TK	0	1	2	0	4	4	1	9	8	4	5	E	2	0	2	4	2	4	3	1	0	0	1	0	
Global 4Way Cassette (600x600)	AM045JNVDKH/TK	0	1	2	0	4	4	1	9	5	5	A	2	2	0	2	D	2	D	3	1	0	0	1	0	
	AM056JNVDKH/TK	0	1	2	0	4	4	1	9	9	4	2	C	2	0	3	8	3	8	3	1	0	0	2	0	
	AM071JNVDKH/TK	0	1	2	0	4	4	1	9	8	4	7	F	2	0	4	7	4	7	3	1	0	0	2	0	
	AM082JNVDKH/TK	0	1	2	0	4	4	1	9	5	5	A	3	2	0	5	2	5	2	3	1	0	0	2	0	
	AM022FNNDEH/TL	0	1	5	0	4	F	1	9	7	0	E	8	2	0	1	6	1	6	3	3	0	0	0	0	
	AM028FNNDEH/TL	0	1	5	0	4	F	1	9	5	4	0	A	2	0	1	C	1	C	3	3	0	0	0	0	
Slim Duct-S	AM036FNNDEH/TL	0	1	5	0	4	F	1	9	3	4	2	A	2	0	2	4	2	4	3	3	0	0	0		
	AM045FNNDEH/TL	0	1	5	0	4	F	1	9	5	4	4	E	2	0	2	D	2	D	3	3	0	0	0		
	AM056FNNDEH/TL	0	1	5	0	4	F	1	9	5	4	7	F	2	0	3	8	3	8	3	3	0	0	0		
	AM060FNNDEH/TL	0	1	5	0	4	F	1	9	5	5	9	1	2	0	3	C	3	C	3	3	0	0	0	0	
Slim Duct-1	AM022FNLDEH/TL	0	1	0	0	5	4	1	2	5	A	8	0	2	0	1	6	1	6	3	3	1	1	1	0	0
	AM028FNLDEH/TL	0	1	0	0	5	4	1	2	5	A	C	3	2	0	1	6	1	6	3	3	1	1	1	0	1
	AM036FNLDEH/TL	0	1	0	0	5	4	1	2	5	E	0	8	2	0	1	6	1	6	3	3	1	1	1	0	3
Slim Duct-S	AM045FNLDEH/TL	0	1	0	0	5	4	1	2	5	A	E	2	2	0	1	C	1	C	3	3	1	1	1	0	0
	AM056FNLDEH/TL	0	1	0	0	5	4	1	2	5	E	1	5	2	0	1	C	1	C	3	3	1	1	1	0	1
	AM071FNLDEH/TL	0	1	0	0	5	4	1	2	5	E	7	A	2	0	1	C	1	C	3	3	1	1	1	0	3
Slim Duct-1	AM082FNLDEH/TL	0	1	0	0	5	4	1	2	5	E	3	5	2	0	2	4	2	4	3	3	1	1	1	0	0
	AM015FNLDEH/TL	0	1	0	0	5	4	1	2	5	E	6	8	2	0	2	4	2	4	3	3	1	1	1	0	1
	AM022FNLDEH/TL	0	1	0	0	5	4	1	2	5	E	C	D	2	0	2	4	2	4	3	3	1	1	1	0	3
Slim Duct-1	AM045FNLDEH/TL	0	1	0	0	5	4	1	2	5	9	9	F	2	0	2	D	2	D	3	3	1	1	1	0	0
	AM056FNLDEH/TL	0	1	0	0	5	4	1	2	5	A	E	2	2	0	2	D	2	D	3	3	1	1	1	0	2
	AM071FNLDEH/TL	0	1	0	0	5	4	1	2	5	E	F	6	2	0	2	D	2	D	3	3	1	1	1	0	4

Option Items(cont.)

Item	Model	SEG																								Static Pressure
		1	2	3	4	5	6	7	8	9	10	11	12	13	14	15	16	17	18	19	20	21	22	23	24	
Slim Duct-1	AM056FNLDEH/TL	0	1	0	0	5	4	1	2	5	A	C	1	2	0	3	8	3	8	3	3	1	1	1	0	0
		0	1	0	0	5	4	1	2	5	E	3	4	2	0	3	8	3	8	3	3	1	1	1	0	2
		0	1	0	0	5	4	1	2	5	E	F	9	2	0	3	8	3	8	3	3	1	1	1	0	4
Slim Duct-2	AM071FNLDEH/TL	0	1	0	0	5	4	1	2	5	9	B	B	2	0	4	7	4	7	3	3	1	1	1	0	0
		0	1	0	0	5	4	1	2	5	D	9	E	2	0	4	7	4	7	3	3	1	1	1	0	2
		0	1	0	0	5	4	1	2	5	E	F	4	2	0	4	7	4	7	3	3	1	1	1	0	4
MSP DUCT-S	AM056FNMDEH/TL	0	1	0	0	5	4	1	2	5	5	7	1	2	0	3	8	3	8	3	3	1	1	1	0	0
		0	1	0	0	5	4	1	2	5	5	7	1	2	0	3	8	3	8	3	3	1	1	1	0	2
		0	1	0	0	5	4	1	2	5	5	7	1	2	0	3	8	3	8	3	3	1	1	1	0	4
		0	1	0	0	5	4	1	2	5	5	7	1	2	0	3	8	3	8	3	3	1	1	1	0	6
MSP DUCT-S	AM071FNMDEH/TL	0	1	0	0	5	4	1	2	5	9	0	4	2	0	4	7	4	7	3	3	1	1	1	0	0
		0	1	0	0	5	4	1	2	5	9	3	6	2	0	4	7	4	7	3	3	1	1	1	0	2
		0	1	0	0	5	4	1	2	5	9	7	9	2	0	4	7	4	7	3	3	1	1	1	0	4
		0	1	0	0	5	4	1	2	5	D	F	9	2	0	4	7	4	7	3	3	1	1	1	0	6
MSP DUCT-0	AM090FNMDEH/TL	0	1	0	0	5	4	1	2	5	D	F	C	2	0	4	7	4	7	3	3	1	1	1	0	8
		0	1	0	0	5	4	1	2	5	9	4	5	2	0	5	A	5	A	3	3	1	1	1	0	4
		0	1	0	0	5	4	1	2	5	D	2	9	2	0	5	A	5	A	3	3	1	1	1	0	6
MSP DUCT-1	AM112FNMDEH/TL	0	1	0	0	5	4	1	2	2	E	0	4	2	0	7	0	7	0	3	3	1	1	1	0	4
		0	1	0	0	5	4	1	2	2	E	2	6	2	0	7	0	7	0	3	3	1	1	1	0	6
		0	1	0	0	5	4	1	2	2	E	B	B	2	0	7	0	7	0	3	3	1	1	1	0	8
		0	1	0	0	5	4	1	2	2	F	F	0	2	0	7	0	7	0	3	3	1	1	1	0	10
MSP DUCT-2	AM128FNMDEH/TL	0	1	0	0	5	4	1	2	2	F	F	0	2	0	7	0	7	0	3	3	1	1	1	0	12
		0	1	0	0	5	4	1	2	2	9	9	F	2	0	8	0	8	0	3	3	1	1	1	0	4
		0	1	0	0	5	4	1	2	2	A	C	1	2	0	8	0	8	0	3	3	1	1	1	0	6
		0	1	0	0	5	4	1	2	2	A	E	3	2	0	8	0	8	0	3	3	1	1	1	0	8
		0	1	0	0	5	4	1	2	2	E	1	5	2	0	8	0	8	0	3	3	1	1	1	0	10
MSP DUCT-2	AM140FNMDEH/TL	0	1	0	0	5	4	1	2	2	E	4	7	2	0	8	0	8	0	3	3	1	1	1	0	12
		0	1	0	0	5	4	1	2	2	E	6	9	2	0	8	0	8	0	3	3	1	1	1	0	14
		0	1	0	0	5	4	1	2	2	A	F	2	2	0	8	C	8	C	3	3	1	1	1	0	4
		0	1	0	0	5	4	1	2	2	E	2	5	2	0	8	C	8	C	3	3	1	1	1	0	6
		0	1	0	0	5	4	1	2	2	E	5	7	2	0	8	C	8	C	3	3	1	1	1	0	8
A3050 (EEV INCLUDED)	AM022JNVDKH/TL	0	1	2	0	4	4	1	9	9	4	2	A	2	0	1	6	1	6	3	1	0	0	0		
	AM028JNVDKH/TL	0	1	2	0	4	4	1	9	9	4	5	C	2	0	1	C	1	C	3	1	0	0	0		
	AM036JNVDKH/TL	0	1	2	0	4	4	1	9	8	4	5	E	2	0	2	4	2	4	3	1	0	0	1	0	
	AM045JNVDKH/TL	0	1	2	0	4	4	1	9	5	5	A	2	2	0	2	D	2	D	3	1	0	0	1	0	
	AM056JNVDKH/TL	0	1	2	0	4	4	1	9	9	4	2	C	2	0	3	8	3	8	3	1	0	0	2	0	
	AM071JNVDKH/TL	0	1	2	0	4	4	1	9	8	4	7	F	2	0	4	7	4	7	3	1	0	0	2	0	
AM082JNVDKH/TL	0	1	2	0	4	4	1	9	5	5	A	3	2	0	5	2	5	2	3	1	0	0	2	0		
OAP DUCT	AM140JNEPEH/EU	0	1	B	0	6	4	1	B	4	F	F	B	2	0	8	C	8	C	3	3	3	0	0	0	25mmAq
		0	1	B	0	6	4	1	B	4	F	9	5	2	0	8	C	8	C	3	3	3	0	0	0	20mmAq
		0	1	B	0	6	4	1	B	4	E	2	E	2	0	8	C	8	C	3	3	3	0	0	0	15mmAq
		0	1	B	0	6	4	1	B	4	A	A	6	2	0	8	C	8	C	3	3	3	0	0	0	10mmAq
		0	1	B	0	6	4	1	B	4	A	5	1	2	0	8	C	8	C	3	3	3	0	0	0	7.5mmAq
		0	1	B	0	6	4	1	B	4	9	0	B	2	0	8	C	8	C	3	3	3	0	0	0	5mmAq
	AM220JNEPEH/EU	0	1	B	0	6	4	1	9	4	5	3	0	2	3	1	6	1	6	3	3	3	0	0	0	25mmAq
		0	1	B	0	6	4	1	9	4	4	1	F	2	3	1	6	1	6	3	3	3	0	0	0	23mmAq
		0	1	B	0	6	4	1	9	4	0	E	C	2	3	1	6	1	6	3	3	3	0	0	0	20mmAq
		0	1	B	0	6	4	1	9	4	0	C	A	2	3	1	6	1	6	3	3	3	0	0	0	17.5mmAq
		0	1	B	0	6	4	1	9	4	0	9	7	2	3	1	6	1	6	3	3	3	0	0	0	15mmAq
		0	1	B	0	6	4	1	9	4	0	7	5	2	3	1	6	1	6	3	3	3	0	0	0	12.5mmAq
	AM280JNEPEH/EU	0	1	B	0	6	4	1	9	4	0	6	4	2	3	1	6	1	6	3	3	3	0	0	0	10mmAq
		0	1	B	0	6	4	1	9	4	5	8	1	2	3	1	C	1	C	3	3	3	0	0	0	27.5mmAq
		0	1	B	0	6	4	1	9	4	5	5	0	2	3	1	C	1	C	3	3	3	0	0	0	25mmAq
		0	1	B	0	6	4	1	9	4	5	3	0	2	3	1	C	1	C	3	3	3	0	0	0	22.5mmAq
		0	1	B	0	6	4	1	9	4	4	0	E	2	3	1	C	1	C	3	3	3	0	0	0	20mmAq
		0	1	B	0	6	4	1	9	4	0	D	B	2	3	1	C	1	C	3	3	3	0	0	0	17.5mmAq
OAP DUCT	AM280JNEPEH/EU	0	1	B	0	6	4	1	9	4	0	A	8	2	3	1	C	1	C	3	3	3	0	0	0	15mmAq
		0	1	B	0	6	4	1	9	4	0	8	6	2	3	1	C	1	C	3	3	3	0	0	0	12.5mmAq
		0	1	B	0	6	4	1	9	4	0	6	4	2	3	1	C	1	C	3	3	3	0	0	0	10mmAq
		0	1	B	0	6	4	1	9	4	0	6	4	2	3	1	C	1	C	3	3	3	0	0	0	10mmAq
		0	1	B	0	6	4	1	9	4	0	6	4	2	3	1	C	1	C	3	3	3	0	0	0	10mmAq
		0	1	B	0	6	4	1	9	4	0	6	4	2	3	1	C	1	C	3	3	3	0	0	0	10mmAq

Option Items(cont.)

Item	Model	SEG																								Static Pressure	
		1	2	3	4	5	6	7	8	9	10	11	12	13	14	15	16	17	18	19	20	21	22	23	24		
OAP DUCT	AM140MNEPEH/EU	0	1	B	0	6	4	1	B	4	F	8	6	2	0	8	C	8	C	3	3	3	0	0	0	15 mmAq	
		0	1	B	0	6	4	1	B	4	F	D	A	2	0	8	C	8	C	3	3	3	0	0	0	20 mmAq	
		0	1	B	0	6	4	1	B	4	F	F	D	2	0	8	C	8	C	3	3	3	0	0	0	25 mmAq	
	AM220MNEPEH/EU	0	1	B	0	6	4	1	9	3	0	9	7	2	0	E	0	E	0	3	3	3	0	0	0	18 mmAq	
		0	1	B	0	6	4	1	9	3	0	E	B	2	0	E	0	E	0	3	3	3	0	0	0	23 mmAq	
		0	1	B	0	6	4	1	9	3	5	2	0	2	0	E	0	E	0	3	3	3	0	0	0	29 mmAq	
	AM280MNEPEH/EU	0	1	B	0	6	4	1	9	4	0	C	A	2	3	1	C	1	C	3	3	3	0	0	0	20 mmAq	
		0	1	B	0	6	4	1	9	3	4	1	F	2	3	1	C	1	C	3	3	3	0	0	0	25 mmAq	
		0	1	B	0	6	4	1	9	3	5	5	3	2	3	1	C	1	C	3	3	3	0	0	0	30 mmAq	
V-AHU	SMALL	AM012JNZDCH/AA	0	1	A	0	5	4	1	0	5	0	0	0	2	0	2	3	2	3	3	3	0	1	0	0	
		AM018JNZDCH/AA	0	1	A	0	5	4	1	0	5	0	0	0	2	0	3	5	3	5	3	3	0	1	0	0	
		AM024JNZDCH/AA	0	1	A	0	5	4	1	0	5	0	0	0	2	0	4	6	4	6	3	3	0	1	0	0	
	MIDDLE	AM030JNZDCH/AA	0	1	A	0	5	4	1	0	5	0	0	0	2	0	5	8	5	8	3	3	0	1	0	0	
		AM036JNZDCH/AA	0	1	A	0	5	4	1	0	5	0	0	0	2	0	6	9	6	9	3	3	0	1	0	0	
		AM048JNZDCH/AA	0	1	A	0	5	4	1	0	5	0	0	0	2	0	8	D	8	D	3	3	0	1	0	0	
	LARGE	AM054JNZDCH/AA	0	1	A	0	5	4	1	0	5	0	0	0	2	0	9	E	9	E	3	3	0	1	0	0	
		AM060JNZDCH/AA	0	1	A	0	5	4	1	0	5	0	0	0	2	0	B	0	B	0	3	3	0	1	0	0	
		AM072JNZDCH/AA	0	1	A	0	5	4	1	0	5	0	0	0	2	0	D	3	D	3	3	3	0	1	0	0	
BORACAY	AM015KNTDEH/EU	0	1	0	0	4	4	1	1	9	0	E	A	2	0	0	F	0	F	3	3	0	0	0	0	-	
	AM022KNTDEH/EU	0	1	0	0	4	4	1	1	9	0	F	A	2	0	1	6	1	6	3	3	0	0	0	0	-	
	AM028KNTDEH/EU	0	1	0	0	4	4	1	1	6	0	C	8	2	0	1	C	1	C	3	3	0	0	0	0	-	
	AM036KNTDEH/EU	0	1	0	0	4	4	1	1	5	4	0	B	2	0	2	4	2	4	3	3	0	0	0	0	-	
	AM045KNTDEH/EU	0	1	0	0	4	4	1	1	5	4	1	C	2	0	2	D	2	D	3	3	0	0	2	0	-	
	AM056KNTDEH/EU	0	1	0	0	4	4	1	1	5	4	2	C	2	0	3	8	3	8	3	3	0	0	2	0	-	
	AM071KNTDEH/EU	0	1	0	0	4	4	1	1	6	4	4	F	2	0	4	7	4	7	3	3	0	0	2	0	-	
	AM007KNTDCH/TC	0	1	0	0	4	4	1	1	9	0	F	A	2	0	1	6	1	6	3	3	0	0	0	0	-	
	AM009KNTDCH/TC	0	1	0	0	4	4	1	1	6	0	C	8	2	0	1	C	1	C	3	3	0	0	0	0	-	
	AM012KNTDCH/TC	0	1	0	0	4	4	1	1	5	4	0	B	2	0	2	4	2	4	3	3	0	0	0	0	-	
	AM018KNTDCH/TC	0	1	0	0	4	4	1	1	5	4	2	C	2	0	3	4	3	4	3	3	0	0	2	0	-	
	AM020KNTDCH/TC	0	1	0	0	4	4	1	1	5	4	3	C	2	0	3	B	3	B	3	3	0	0	2	0	-	
	AM024KNTDCH/TC	0	1	0	0	4	4	1	1	6	4	4	F	2	0	4	7	4	7	3	3	0	0	2	0	-	
BORACAY (with EEV)	AM015KNQDEH/EU	0	1	0	0	4	4	1	1	9	0	E	A	2	0	0	F	0	F	3	1	0	0	0	0	-	
	AM022KNQDEH/EU	0	1	0	0	4	4	1	1	9	0	F	A	2	0	1	6	1	6	3	1	0	0	0	0	-	
	AM028KNQDEH/EU	0	1	0	0	4	4	1	1	6	0	C	8	2	0	1	C	1	C	3	1	0	0	0	0	-	
	AM036KNQDEH/EU	0	1	0	0	4	4	1	1	5	4	0	B	2	0	2	4	2	4	3	1	0	0	0	0	-	
	AM045KNQDEH/EU	0	1	0	0	4	4	1	1	5	4	1	C	2	0	2	D	2	D	3	1	0	0	2	0	-	
	AM056KNQDEH/EU	0	1	0	0	4	4	1	1	5	4	2	C	2	0	3	8	3	8	3	1	0	0	2	0	-	
	AM071KNQDEH/EU	0	1	0	0	4	4	1	1	6	4	4	F	2	0	4	7	4	7	3	1	0	0	2	0	-	
	AM022KNQDEH/TL	0	1	0	0	4	4	1	1	9	0	F	A	2	0	1	6	1	6	3	1	0	0	0	0	-	
	AM028KNQDEH/TL	0	1	0	0	4	4	1	1	6	0	C	8	2	0	1	C	1	C	3	1	0	0	0	0	-	
	AM036KNQDEH/TL	0	1	0	0	4	4	1	1	5	4	0	B	2	0	2	4	2	4	3	1	0	0	0	0	-	
	AM045KNQDEH/TL	0	1	0	0	4	4	1	1	5	4	1	C	2	0	2	D	2	D	3	1	0	0	2	0	-	
	AM056KNQDEH/TL	0	1	0	0	4	4	1	1	5	4	2	C	2	0	3	8	3	8	3	1	0	0	2	0	-	
	AM071KNQDEH/TL	0	1	0	0	4	4	1	1	6	4	4	F	2	0	4	7	4	7	3	1	0	0	2	0	-	
	AM007KNQDCH/TC	0	1	0	0	4	4	1	1	9	0	F	A	2	0	1	6	1	6	3	1	0	0	0	0	-	
	AM009KNQDCH/TC	0	1	0	0	4	4	1	1	6	0	C	8	2	0	1	C	1	C	3	1	0	0	0	0	-	
	AM012KNQDCH/TC	0	1	0	0	4	4	1	1	5	4	0	B	2	0	2	4	2	4	3	1	0	0	0	0	-	
	AM018KNQDCH/TC	0	1	0	0	4	4	1	1	5	4	2	C	2	0	3	4	3	4	3	1	0	0	2	0	-	
	AM020KNQDCH/TC	0	1	0	0	4	4	1	1	5	4	3	C	2	0	3	B	3	B	3	1	0	0	2	0	-	
	AM024KNQDCH/TC	0	1	0	0	4	4	1	1	6	4	4	F	2	0	4	7	4	7	3	1	0	0	2	0	-	
	Slim Home Duct	AM017KNLDEH/EU	0	1	0	0	5	4	1	C	9	0	6	2	2	0	1	2	1	2	3	3	1	1	1	0	0
0			1	0	0	5	4	1	C	9	0	B	5	2	0	1	2	1	2	3	3	1	1	1	0	1	
0			1	0	0	5	4	1	C	9	4	0	A	2	0	1	2	1	2	3	3	1	1	1	0	2	
0			1	0	0	5	4	1	C	9	5	8	4	2	0	1	2	1	2	3	3	1	1	1	0	3	
0			1	0	0	5	4	1	C	9	0	7	3	2	0	1	6	1	6	3	3	1	1	1	0	0	
AM022KNLDEH*		0	1	0	0	5	4	1	C	9	0	D	5	2	0	1	6	1	6	3	3	1	1	1	0	1	
		0	1	0	0	5	4	1	C	9	4	2	A	2	0	1	6	1	6	3	3	1	1	1	0	2	
		0	1	0	0	5	4	1	C	9	5	A	4	2	0	1	6	1	6	3	3	1	1	1	0	3	
		0	1	0	0	5	4	1	C	9	0	B	3	2	0	1	C	1	C	3	3	1	1	1	0	0	
		0	1	0	0	5	4	1	C	9	4	1	7	2	0	1	C	1	C	3	3	1	1	1	0	1	
AM028KNLDEH*		0	1	0	0	5	4	1	C	9	4	6	C	2	0	1	C	1	C	3	3	1	1	1	0	2	
		0	1	0	0	5	4	1	C	9	5	C	5	2	0	1	C	1	C	3	3	1	1	1	0	3	
		0	1	0	0	5	4	1	C	9	4	0	A	2	0	2	4	2	4	3	3	1	1	1	0	0	
		0	1	0	0	5	4	1	C	9	4	5	9	2	0	2	4	2	4	3	3	1	1	1	0	1	
		0	1	0	0	5	4	1	C	9	4	A	E	2	0	2	4	2	4	3	3	1	1	1	0	2	
MAX (with EEV)	AM093MNOQDEH/EU	0	1	3	0	4	4	1	9	7	4	6	E	2	0	5	D	5	D	3	1	0	0	2	0	-	
		0	1	3	0	4	4	1	9	7	4	6	E	2	0	5	D	5	D	3	1	0	0	2	0	-	
		0	1	3	0	4	4	1	9	7	4	6	E	2	0	5	D	5	D	3	1	0	0	2	0	-	

Option Items(cont.)

Item	Model	SEG																								Static Pressure	
		1	2	3	4	5	6	7	8	9	10	11	12	13	14	15	16	17	18	19	20	21	22	23	24		
EHS TDM PLUS	Slim Duct	AE022MNLDEH/EU	0	1	0	9	5	4	1	2	5	E	0	8	2	0	1	6	1	6	3	2	1	1	1	0	4mmAq
			0	1	0	9	5	4	1	2	5	A	C	3	2	0	1	6	1	6	3	2	1	1	1	0	2mmAq(STD)
			0	1	0	9	5	4	1	2	5	A	8	0	2	0	1	6	1	6	3	2	1	1	1	0	0mmAq
		AE028MNLDEH/EU	0	1	0	9	5	4	1	2	5	E	7	A	2	0	1	C	1	C	3	2	1	1	1	0	4mmAq
			0	1	0	9	5	4	1	2	5	E	1	5	2	0	1	C	1	C	3	2	1	1	1	0	2mmAq(STD)
			0	1	0	9	5	4	1	2	5	A	E	2	2	0	1	C	1	C	3	2	1	1	1	0	0mmAq
	AE036MNLDEH/EU	0	1	0	9	5	4	1	2	5	E	C	D	2	0	2	4	2	4	3	2	1	1	1	0	4mmAq	
		0	1	0	9	5	4	1	2	5	E	6	8	2	0	2	4	2	4	3	2	1	1	1	0	2mmAq(STD)	
		0	1	0	9	5	4	1	2	5	E	3	5	2	0	2	4	2	4	3	2	1	1	1	0	0mmAq	
	AE056MNLDEH/EU	0	1	0	9	5	4	1	2	5	E	F	9	2	0	3	8	3	8	3	2	1	1	1	0	4mmAq	
		0	1	0	9	5	4	1	2	5	E	3	4	2	0	3	8	3	8	3	2	1	1	1	0	2mmAq(STD)	
		0	1	0	9	5	4	1	2	5	A	C	1	2	0	3	8	3	8	3	2	1	1	1	0	0mmAq	
EHS TDM PLUS	Global Duct	AE071MNMPEH/EU	0	1	0	9	5	4	1	C	5	9	8	9	2	0	4	7	4	7	3	2	1	2	0	1	12~15mmAq
			0	1	0	9	5	4	1	C	5	9	3	5	2	0	4	7	4	7	3	2	1	2	0	1	9~12mmAq
			0	1	0	9	5	4	1	C	5	5	E	1	2	0	4	7	4	7	3	2	1	2	0	1	6~9mmAq
		AE090MNMPEH/EU	0	1	0	9	5	4	1	C	5	4	8	D	2	0	4	7	4	7	3	2	1	2	0	1	3~6mmAq
			0	1	0	9	5	4	1	C	5	9	C	D	2	0	5	A	5	A	3	2	1	2	1	2	0~3mmAq(STD)
			0	1	0	9	5	4	1	C	5	9	6	9	2	0	5	A	5	A	3	2	1	2	1	2	12~15mmAq
	A3050 (EEV NOT INCLUDED)	AE022MNADEH/EU	0	1	2	9	4	4	1	9	9	4	2	A	2	0	1	6	1	6	3	2	0	0	0	0	8~12mmAq
		AE028MNADEH/EU	0	1	2	9	4	4	1	9	9	4	5	C	2	0	1	C	1	C	3	2	0	0	0	0	4~8mmAq
		AE036MNADEH/EU	0	1	2	9	4	4	1	9	8	4	5	E	2	0	2	4	2	4	3	2	0	0	1	0	0~4mmAq(STD)
		AE056MNADEH/EU	0	1	2	9	4	4	1	9	9	4	2	C	2	0	3	8	3	8	3	2	0	0	2	0	-
		AE071MNLDEH/EU	0	1	2	9	4	4	1	9	8	4	7	F	2	0	4	7	4	7	3	2	0	0	2	0	-
		Console	AE022MNJDEH/EU	0	1	9	9	4	4	1	9	5	0	7	4	2	0	1	6	1	6	3	2	0	0	1	0
	AE028MNJDEH/EU		0	1	9	9	4	4	1	9	5	0	B	7	2	0	1	C	1	C	3	2	0	0	1	0	-
	AE036MNJDEH/EU		0	1	9	9	4	4	1	9	5	0	D	7	2	0	2	4	2	4	3	2	0	0	1	0	-
	AE056MNJDEH/EU		0	1	9	9	4	4	1	9	5	4	1	B	2	0	3	8	3	8	3	2	0	0	1	0	-
	Wind-Free 1way Cassette	AM017NN1PEH/EU	0	1	D	0	4	4	1	9	6	0	8	6	2	0	1	1	1	1	3	3	0	0	0	0	-
		AM022NN1PEH/EU	0	1	D	0	4	4	1	9	7	0	A	6	2	0	1	6	1	6	3	3	0	0	0	0	-
		AM022NN1DEH/EU	0	1	7	0	4	4	1	1	8	0	C	8	2	0	1	6	1	6	3	3	0	0	1	0	-
AM028NN1DEH/EU		0	1	7	0	4	4	1	1	8	0	F	8	2	0	1	C	1	C	3	3	0	0	1	0	-	
AM036NN1DEH/EU		0	1	7	0	4	4	1	1	5	4	5	D	2	0	2	4	2	4	3	3	0	0	1	1	-	
AM056NN1DEH/EU		0	1	8	0	4	4	1	9	5	4	3	C	2	0	3	8	3	8	3	3	0	0	1	5	-	
4Way Cassette (600x600)	AM071NN1DEH/EU	0	1	8	0	4	4	1	9	4	5	F	2	0	4	7	4	7	3	3	0	0	1	8	-		
	AM028HNNDEH/TL	0	1	6	0	5	7	1	2	5	9	5	E	2	0	1	C	1	C	3	3	0	0	1	0	-	
	AM036HNNDEH/TL	0	1	6	0	5	7	1	2	5	A	B	3	2	0	2	D	2	D	3	3	0	0	1	0	-	

* If you are going to use up to SEG 24, please refer to following instruction.

SEG 17 : 0 → 1: Using high ceiling kit for 4way

SEG 18 :

	Not in use	Use
Change temperature display	0(Celsius)	1(Fahrenheit)
Sound Mute	0	2
Mixed operation control	0	4

• If you want to use multiple functions, add each of the 'use' value of the function you want to used and input the final addition as option value. (Use Fahrenheit + Sound mute + Mixed operation control : 1 + 2 + 4 = 7)

Ex) 044217-1d00e6-200000-300000

When using Sound mute : 044217-1d00e6-200002-300000

When using high ceiling kit for 4way and mixed operation error preventing function : 044217-1d00e6-200014-300000

4-3-3 What to check before diagnosis





4-3-3-1 Lamp combination expression method display (cassette type indoor unit)

- Slim 1-Way, 2 -Way, Global 4Way Cassette type(600x600)

■ Error detection and restart

- When error occurs during operation, indicate a problem with LED flashes, and no other operations but LED stops.
- When restarting operation with remote controller or switch, it will determine the appropriate error mode after normal operation .

■ LED lamp display with error detection

Abnormal condition	Error code	LED Display				
						
		Green	Red			
Error on indoor temperature sensor (Short or Open)	E121	×	×	◐	×	×
1. Error on Eva-in sensor (Short or Open) 2. Error on Eva-out sensor (Short or Open) 3. Discharge sensor error (Short or Open)	E122 E123 E126	◐	×	◐	×	×
Indoor fan error	E154	×	×	×		×
1. Error on outdoor temperature sensor (Short or Open) 2. Error on cond sensor 3. Error on discharge sensor Other outdoor unit sensor error that is not on the above list	E221 E237 E251	◐	×	×	◐	×
1. When there is no communication between the indoor-outdoor units for 2 minutes 2. Communication error received from the outdoor unit 3. 3 minute tracking error on outdoor unit 4. Communication error after tracking due to unmatching number of installed units 5. Error due to repeated communication address 6. Communication address not confirmed Other outdoor unit communication error that is not on the above list	E101 E102 E202 E201 E108 E109	×	×	◐	◐	×
Self diagnosis error display 1. Error due to opened EEV (2nd detection) 2. Error due to closed EEV (2nd detection) 3. Eva in sensor is detached 4. Eva out sensor is detached 5. Thermal fuse error (Open)	E151 E152 E128 E129 E198	×	×	◐	◐	◐

● : On ◐ : Flickering × : Off

- If you turn off the air conditioner when the LED is flickering, the LED is also turned off.
- If you re-operate the air conditioner, it operates normally at first, then detect an error again.
- When E108 error occurs, change the address and reset the system.
- Ex.) When address of the indoor unit #1 and #2 are set as 5, address of the indoor unit #1 will become 5 and indoor unit #2 will display E108, A002.

■ LED lamp display with error detection (cont.)

Abnormal condition	Error code	LED Display				
		Green	Red			
1. COND mid sensor is detached	E241					
2. Refrigerant leakage (2nd detection)	E554					
3. Abnormally high temperature on Cond (2nd detection)	E450					
4. Low pressure s/w (2nd detection)	E451					
5. Abnormally high temperature on discharged air on outdoor unit (2nd detection)	E416					
6. Indoor operation stop due to unconfirmed error on outdoor unit	E559					
7. Error due to reverse phase detection	E425					
8. Comp stop due to freeze detection (6th detection)	E403					
9. High pressure sensor is detached	E301	×	×	◐	◐	◐
10. Low pressure sensor is detached	E306					
11. Outdoor unit copression ration error	E428					
12. Outdoor sump down_1 prevetion control	E413					
13. Compressor down due to low pressure sensor prevention control_1	E410					
14. Simultaneous opening of cooling/heating MCU SOL valve (1st detection)	E180					
15. Simultaneous opening of cooling/heating MCU SOL valve (2nd detection)	E181					
Other outdoor unit self-diagnosis error that is not on the above list						
Flowating s/w (2nd detection)	E153	×	×	×	◐	◐
EEPROM error	E162	◐	◐	◐	◐	◐
EEPROM option error	E163	◐	◐	◐	◐	◐
Error due to incompatible indoor unit	E164	×	×	×	×	◐

● : On ◐ : Flickering × : Off



- If you turn off the air conditioner when the LED is flickering, the LED is also turned off.
 - If you re-operate the air conditioner, it operates normally at first, then detect an error again.
 - When E108 error occurs, change the address and reset the system.
- Ex.) When address of the indoor unit #1 and #2 are set as 5, address of the indoor unit #1 will become 5 and indoor unit #2 will display E108, A002.

- Global 4way cassette type











■ Error detection and restart

- When error occurs during operation, indicate a problem with LED flashes, and no other operations but LED stops.
- When restarting operation with remote controller or switch, it will determine the appropriate error mode after normal operation

■ LED lamp display with error detection

Abnormal condition	Error code	LED Display			
		Operation	Defrost	Timer	Filter
					
Error on indoor temperature sensor (Short or Open)	E121	×	◐	×	×
1. Error on Eva-in sensor (Short or Open) 2. Error on Eva-out sensor (Short or Open) 3. Discharge sensor error (Short or Open)	E122 E123 E126	◐	◐	×	×
Indoor fan error	E154	×	×	◐	×
1. Error on outdoor temperature sensor (Short or Open) 2. Error on cond sensor 3. Error on discharge sensor Other outdoor unit sensor error that is not on the above list	E221 E237 E251	◐	×	◐	×
1. When there is no communication between the indoor-outdoor units for 2 minutes 2. Communication error received from the outdoor unit 3. 3 minute tracking error on outdoor unit 4. Communication error after tracking due to unmatching number of installed units 5. Error due to repeated communication address 6. Communication address not confirmed Other outdoor unit communication error that is not on the above list	E101 E102 E202 E201 E108 E109	×	◐	◐	×
Self diagnosis error display 1. Error due to opened EEV (2nd detection) 2. Error due to closed EEV (2nd detection) 3. Eva in sensor is detached 4. Eva out sensor is detached 5. Thermal fuse error (Open)	E151 E152 E128 E129 E198	×	◐	◐	◐
1. COND mid sensor is detached. 2. Refrigerant leakage (2nd detection). 3. Abnormally high temperature on Cond. (2nd detection) 4. Low pressure s/w. (2nd detection) 5. Abnormally high temperature on discharged air on outdoor unit. (2nd detection) 6. Indoor operation stop due to unconfirmed error on outdoor unit. 7. Error due to reverse phase detection. 8. Comp stop due to freeze detection. (6th detection) 9. High pressure sensor is detached. 10. Low pressure sensor is detached. 11. Outdoor unit copression ration error 12. Outdoor sump down_1 prevetion control 13. Compressor down due to low pressure sensor prevention control_1 14. Simultaneous opening of cooling/heating MCU SOL valve (1st detection) 15. Simultaneous opening of cooling/heating MCU SOL valve (2nd detection) Other outdoor unit self-diagnosis error that is not on the above list	E241 E554 E450 E451 E416 E559 E425 E403 E301 E306 E428 E413 E410 E180 E181	×	◐	◐	◐
Flowating s/w (2nd detection)	E153	×	×	◐	◐
EEPROM error	E162	◐	◐	◐	◐

■ LED lamp display with error detection (cont.)

Abnormal condition	Error code	LED Display			
		Operation	Defrost	Timer	Filter
					
EEPROM option error	E163				
Error due to incompatible indoor unit	E164			×	

● : On ◐ : Flickering × : Off

- If you turn off the air conditioner when the LED is flickering, the LED is also turned off.
 - If you re-operate the air conditioner, it operates normally at first, then detect an error again.
 - When E108 error occurs, change the address and reset the system.
- Ex.) When address of the indoor unit #1 and #2 are set as 5, address of the indoor unit #1 will become 5 and indoor unit #2 will display E108, A002.

Condition of the indoor unit	Error code	Indoor unit display indications			
		Ice blue	Yellow green	Blue	Red
Power reset (blinking once every 2 seconds)	NO ERROR	●	X	X	X
In the defrost operation (blinking once every 10 seconds)	NO ERROR	●	X	X	X
Open or short circuit error of the indoor-temperature sensor	E121	X	X	X	●
Open or short circuit error of the evaporator-in sensor	E122	X	●	X	●
Open or short circuit error of the evaporator-out sensor	E123	X	X	●	●
Error of the fan in the indoor unit	E154	X	X	●	X
1. Open or short circuit error of the outdoor-temperature sensor	E221				
2. Open or short circuit error of the condenser sensor	E237				
3. Open or short circuit error of the discharge sensor	E251				
Errors of the sensors of the outdoor unit other than the errors listed above					
1. Error due to the opened EEV (2nd detection)	E151				
2. Error due to the closed EEV (2nd detection)	E152				
3. The evaporator-in sensor is detached.	E128				
4. The evaporator-out sensor is detached.	E129				
5. The condenser mid sensor is detached.	E241				
6. Refrigerant leakage (2nd detection)	E554				
7. Abnormal high temperature on the condenser (2nd detection)	E554				
8. Low pressure switch (2nd detection)	E451				
9. Abnormal high temperature on the air discharged from the outdoor unit (2nd detection)	E416				
10. The indoor unit stops due to an unknown error of the outdoor unit.	E559				
11. Error of detection of a reverse phase	E425				
12. The compressor stops due to freeze detection (6th detection)	E403				
13. The high pressure sensor is detached.	E301				
14. The low pressure sensor is detached.	E306				
15. Compression ratio error of the outdoor unit	E428				
16. Outdoor sump down_1 prevention control	E413				
17. Compressor shutdown due to the low-pressure-sensor prevention control_1	E410				
18. Simultaneous opening of the cooling and heating MCU SOL valves (1st detection)	E180				
19. Simultaneous opening of the cooling and heating MCU SOL valves (2nd detection)	E181				
Self-diagnosis errors other than the errors listed above					

Condition of the indoor unit	Error code	Indoor unit display indications			
		Ice blue	Yellow green	Blue	Red
No communication occurs between the indoor and outdoor units for 2 minutes.	E101				
Communication error received from the outdoor unit	E102				
Error of 3 minute tracking on the outdoor unit	E202				
The number of the installed indoor units that is transmitted via communication after the tracking is different.	E201	X	●	X	X
Error of duplicated communication addresses (NASA only)	E108				
The communication address is not confirmed. (NASA only)	E109				
Communication errors other than the errors listed above					
Error of the second detection of the float switch	E153	X	●	●	X
EEPROM error	E162	●	●	X	●
EEPROM option error	E163				
Error of incompatibility of the indoor unit	E164	●	X	X	●
Error of mixed operation	E161	●	●	X	X
Open circuit error of the thermal fuse	E198	●	X	●	X

● : On ● : Flickering × : Off



Ice blue	Yellow green
Blue	Red

- Duct type, 4Way Cassette type(600x600)

■ Error detection and restart

- When error occurs during operation, indicate a problem with LED flashes, and no other operations but LED stops.
- When restarting operation with remote controller or switch, it will determine the appropriate error mode after normal operation





■ LED lamp display with error detection(Remote Control Receiver)

Abnormal condition	Error code	LED Display				
Error on indoor temperature sensor (Short or Open)	E121	×	×	◐	×	×
1. Error on Eva-in sensor (Short or Open) 2. Error on Eva-out sensor (Short or Open) 3. Discharge sensor error (Short or Open)	E122 E123 E126	◐	×	◐	×	×
Indoor fan error	E154	×	×	×	◐	×
1. Error on outdoor temperature sensor (Short or Open) 2. Error on cond sensor 3. Error on discharge sensor Other outdoor unit sensor error that is not on the above list	E221 E237 E251	◐	×	×	◐	×
1. When there is no communication between the indoor-outdoor units for 2 minutes 2. Communication error received from the outdoor unit 3. 3 minute tracking error on outdoor unit 4. Communication error after tracking due to unmatching number of installed units 5. Error due to repeated communication address 6. Communication address not confirmed Other outdoor unit communication error that is not on the above list	E101 E102 E202 E201 E108 E109	×	×	◐	◐	×
Self diagnosis error display 1. Error due to opened EEV (2nd detection) 2. Error due to closed EEV (2nd detection) 3. Eva in sensor is detached 4. Eva out sensor is detached 5. Thermal fuse error (Open)	E151 E152 E128 E129 E198	×	×	◐	◐	◐

● : On ◐ : Flickering × : Off

- If you turn off the air conditioner when the LED is flickering, the LED is also turned off.
- If you re-operate the air conditioner, it operates normally at first, then detect an error again.
- When E108 error occurs, change the address and reset the system.Ex.) When address of the indoor unit #1 and #2 are set as 5, address of the indoor unit #1 will become 5 and indoor unit #2 will display E108, A002.

■ LED lamp display with error detection(Remote Control Receiver) (cont.)

Abnormal condition	Error code	LED Display				
						
1. COND mid sensor is detached 2. Refrigerant leakage (2nd detection) 3. Abnormally high temperature on Cond (2nd detection) 4. Low pressure s/w (2nd detection) 5. Abnormally high temperature on discharged air on outdoor unit (2nd detection)	E241 E554 E450 E451 E416					
6. Indoor operation stop due to unconfirmed error on outdoor unit 7. Error due to reverse phase detection 8. Comp stop due to freeze detection (6th detection)	E559 E425 E403	×	×	◐	◐	◐
9. High pressure sensor is detached 10. Low pressure sensor is detached 11. Outdoor unit copression ration error 12. Outdoor sump down_1 prevetion control 13. Compressor down due to low pressure sensor prevention control_1 14. Simultaneous opening of cooling/heating MCU SOL valve (1st detection) 15. Simultaneous opening of cooling/heating MCU SOL valve (2nd detection) Other outdoor unit self-diagnosis error that is not on the above list	E301 E306 E428 E413 E410 E180 E181					
Flowating s/w (2nd detection)	E153	×	×	×	◐	◐
EEPROM error	E162	◐	◐	◐	◐	◐
EEPROM option error	E163	◐	◐	◐	◐	◐
Error due to incompatible indoor unit	E164	×	×	×	×	◐

● : On ◐ : Flickering × : Off

- If you turn off the air conditioner when the LED is flickering, the LED is also turned off.
- If you re-operate the air conditioner, it operates normally at first, then detect an error again.
- When E108 error occurs, change the address and reset the system.Ex.) When address of the indoor unit #1 and #2 are set as 5, address of the indoor unit #1 will become 5 and indoor unit #2 will display E108, A002.

- Ceiling type

■ Error detection and reoperation

- If an error occurs during the operation, an LED flickers and the operation is stopped except the LED.
- If you re-operate the air conditioner, it operates normally at first, then detect an error again.

■ Indoor unit LED lamp display at error detecting

Abnormal condition	Error code	LED Display				
Error on indoor temperature sensor (Short or Open)	E121	×	×	●	×	×
1. Error on Eva-in sensor (Short or Open) 2. Error on Eva-out sensor (Short or Open)	E122 E123	●	×	●	×	×
Indoor fan error	E154	×	×	×	●	×
1. Error on outdoor temperature sensor (Short or Open) 2. Error on cond sensor 3. Error on discharge sensor	E221 E237 E251	●	×	×	●	×
1. When there is no communication between the indoor-outdoor units for 2 minutes 2. Communication error received from the outdoor unit 3. 3 minute tracking error on outdoor unit 4. Communication error after tracking due to unmatching number of installed units 5. Error due to repeated communication address 6. Communication address not confirmed other outdoor unit communication error that is not on the above list	E101 E102 E202 E201 E108 E109	×	×	●	●	×
Self diagnosis error display 1. Error due to opened EEV (2nd detection) 2. Error due to closed EEV (2nd detection) 3. Eva in sensor is detached 4. Eva out sensor is detached 5. Thermal fuse error (Open)	E151 E152 E128 E128 E198	×	×	●	●	●
1. COND mid sensor is detached 2. Refrigerant leakage (2nd detection) 3. Abnormally high temperature on Cond (2nd detection) 4. Low pressure s/w. (2nd detection) 5. Abnormally high temperature on discharged air on outdoor unit. (2nd detection) 6. Indoor operation stop due to unconfirmed error on outdoor unit 7. Error due to reverse phase detection 8. Comp stop due to freeze detection (6th detection) 9. High pressure sensor is detached 10. Low pressure sensor is detached 11. Outdoor unit copression ration error 12. Outdoor sump down_1 prevetion control 13. Compressor down due to low pressure sensor prevention control_1 14. Simultaneous opening of cooling/heating MCU SOL valve (1st detection) 15. Simultaneous opening of cooling/heating MCU SOL valve (2nd detection)	E241 E554 E450 E451 E416 E559 E425 E403 E301 E306 E428 E413 E410 E180 E181	×	×	●	●	●
Flowating s/w (2nd detection)	E153	×	×	×	●	●
EEPROM option error	E162	●	●	●	●	●
EEPROM option error	E163	●	●	●	●	●
Error due to incompatible indoor unit	E164	×	×	×	×	●

● : On ● : Flickering × : Off

- If you turn off the air conditioner when the LED is flickering, the LED is also turned off.
- If you re-operate the air conditioner, it operates normally at first, then detect an error again.

- Big Ceiling

■ Error detection and reoperation

- If error occurs during the operation, badness is indicated by LED flickering and all operation is stopped except LED.
- If you re-operate the air conditioner, it operates normally at first, then detect an error again.

■ Indoor unit LED lamp display at error detecting

Error mode	Product operation with error				Remarks
	Blue	Green	Orange	Red	
Power reset	○	X	X	X	0.5[S]=On, 0.5[S]=Off
Operation on	●	X	X	X	
Operation off	X	X	X	X	-
Reservation	X	●	X	X	-
Filter sign	X	X	●	X	-
Defrosting	○	X	X	X	1[S]=On, 9[S]=Off
Communication error between indoor units	X	○	X	X	-
EEPROM error / EEPROM option error	○	X	X	○	-
Error of temperature sensor in indoor unit(open/short)	X	X	X	○	-
Error of outdoor Unit/ Self-Diagnosis	X	X	○	X	-
Error of the indoor Unit pipe sensor	X	○	X	○	
High pressure blockage error	X	X	○	○	
Indoor fan error	○	○	X	X	
Thermal Fuse open error	○	X	○	X	
Indoor unit float S/W 2nd detection	X	○	○	X	

● : On ○ : Flickering × : Off



- If you turn off the air conditioner when the LED is flickering, the LED is also turned off.
- If you re-operate the air conditioner, it operates normally at first, then detects an error again.
- If the LED displays only one color, it is turned on for a second and turned off for a second.
- If the LED displays more than two colors, each color is shown for a second alternately.

- Console type

■ Error detection and reoperation

- If an error occurs during the operation, an LED flickers and the operation is stopped except the LED.
- If you re-operate the air conditioner, it operates normally at first, then detect an error again.

■ Indoor unit LED lamp display at error detecting

Abnormal condition	Error code	LED Display				
						
Error on indoor temperature sensor (Short or Open)	E121	×	×	◐	×	×
1. Error on Eva-in sensor (Short or Open) 2. Error on Eva-out sensor (Short or Open)	E122 E123	◐	×	◐	×	×
Indoor fan error	E154	×	×	×	◐	×
1. Error on outdoor temperature sensor (Short or Open) 2. Error on cond sensor 3. Error on discharge sensor	E221 E237 E251	◐	×	×	◐	×
1. When there is no communication between the indoor-outdoor units for 2 minutes 2. Communication error received from the outdoor unit 3. 3 minute tracking error on outdoor unit 4. Communication error after tracking due to unmatching number of installed units 5. Error due to repeated communication address 6. Communication address not confirmed other outdoor unit communication error that is not on the above list	E101 E102 E202 E201 E108 E109	×	×	◐	◐	×
Self diagnosis error display 1. Error due to opened EEV (2nd detection) 2. Error due to closed EEV (2nd detection) 3. Eva in sensor is detached 4. Eva out sensor is detached 5. Thermal fuse error (Open)	E151 E152 E128 E128 E198	×	×	◐	◐	×
1. COND mid sensor is detached 2. Refrigerant leakage (2nd detection) 3. Abnormally high temperature on Cond (2nd detection) 4. Low pressure s/w (2nd detection) 5. Abnormally high temperature on discharged air on outdoor unit. (2nd detection) 6. Indoor operation stop due to unconfirmed error on outdoor unit 7. Error due to reverse phase detection 8. Comp stop due to freeze detection (6th detection) 9. High pressure sensor is detached 10. Low pressure sensor is detached 11. Outdoor unit copression ration error 12. Outdoor sump down_1 prevetion control 13. Compressor down due to low pressure sensor prevention control_1 14. Simultaneous opening of cooling/heating MCU SOL valve (1st detection) 15. Simultaneous opening of cooling/heating MCU SOL valve (2nd detection)	E241 E554 E450 E451 E416 E559 E425 E403 E301 E306 E428 E413 E410 E180 E181	×	×	◐	◐	◐
Flowating s/w (2nd detection)	E153	×	×	×	◐	◐
EEPROM error	E162	◐	◐	◐	◐	◐
EEPROM option error	E163	◐	◐	◐	◐	◐
Error due to incompatible indoor unit	E164	×	×	×	×	◐

● : On ◐ : Flickering × : Off

- If you turn off the air conditioner when the LED is flickering, the LED is also turned off.

- Wall-mounted type

■ Error detection and reoperation

- If an error occurs during the operation, an LED flickers and the operation is stopped except the LED.
- If you re-operate the air conditioner, it operates normally at first, then detect an error again.

■ Indoor unit LED lamp display at error detecting

Abnormal condition	Error code	LED Display		
Error on indoor temperature sensor (Short or Open)	E121	×	●	×
1. Error on Eva-in sensor (Short or Open) 2. Error on Eva-out sensor (Short or Open)	E122 E123	●	●	×
Indoor fan error	E154	×	×	●
1. Error on outdoor temperature sensor (Short or Open) 2. Error on cond sensor 3. Error on discharge sensor	E221 E237 E251	●	×	●
1. When there is no communication between the indoor-outdoor units for 2 minutes 2. Communication error received from the outdoor unit 3. 3 minute tracking error on outdoor unit 4. Communication error after tracking due to unmatching number of installed units 5. Error due to repeated communication address 6. Communication address not confirmed other outdoor unit communication error that is not on the above list	E101 E102 E202 E201 E108 E109	×	●	●
Self diagnosis error display 1. Error due to opened EEV (2nd detection) 2. Error due to closed EEV (2nd detection) 3. Eva in sensor is detached 4. Eva out sensor is detached 5. Thermal fuse error (Open)	E151 E152 E128 E128 E198	●	●	●
1. COND mid sensor is detached 2. Refrigerant leakage (2nd detection) 3. Abnormally high temperature on Cond (2nd detection) 4. Low pressure s/w (2nd detection) 5. Abnormally high temperature on discharged air on outdoor unit (2nd detection) 6. Indoor operation stop due to unconfirmed error on outdoor unit 7. Error due to reverse phase detection 8. Comp stop due to freeze detection (6th detection) 9. High pressure sensor is detached 10. Low pressure sensor is detached 11. Outdoor unit copression ration error 12. Outdoor sump down_1 prevetion control 13. Compressor down due to low pressure sensor prevention control_1 14. Simultaneous opening of cooling/heating MCU SOL valve (1st detection) 15. Simultaneous opening of cooling/heating MCU SOL valve (2nd detection)	E241 E554 E450 E451 E416 E559 E425 E403 E301 E306 E428 E413 E410 E180 E181	●	●	●
EEPROM error	E162	●	●	●
EEPROM option error	E163	●	●	●
Error due to incompatible indoor unit	E164	●	●	●

● : On ● : Flickering × : Off

- If you turn off the air conditioner when the LED is flickering, the LED is also turned off.

- Floor Standing type

■ Error detection and reoperation

- If an error occurs during the operation, an LED flickers and the operation is stopped except the LED.
- If you re-operate the air conditioner, it operates normally at first, then detect an error again.

■ Indoor unit LED lamp display at error detecting

Abnormal condition	Error code	LED Display				
Error on indoor temperature sensor (Short or Open)	E121	×	×	◐	×	×
1. Error on Eva-in sensor (Short or Open) 2. Error on Eva-out sensor (Short or Open)	E122 E123	◐	×	◐	×	×
Indoor fan error	E154	×	×	×	◐	×
1. Error on outdoor temperature sensor (Short or Open) 2. Error on cond sensor 3. Error on discharge sensor Other outdoor unit sensor error that is not on the above list	E221 E237 E251	◐	×	×	◐	×
1. When there is no communication between the indoor-outdoor units for 2 minutes 2. Communication error received from the outdoor unit 3. 3 minute tracking error on outdoor unit 4. Communication error after tracking due to unmatching number of installed units 5. Error due to repeated communication address 6. Communication address not confirmed Other outdoor unit communication error that is not on the above list	E101 E102 E202 E201 E108 E109	×	×	◐	◐	×
Self diagnosis error display 1. Error due to opened EEV (2nd detection) 2. Error due to closed EEV (2nd detection) 3. Eva in sensor is detached 4. Eva out sensor is detached 5. Thermal fuse error (Open)	E151 E152 E128 E129 E198	×	×	◐	◐	×

● : On ◐ : Flickering × : Off

- If you turn off the air conditioner when the LED is flickering, the LED is also turned off.
- If you re-operate the air conditioner, it operates normally at first, then detect an error again.
- When E108 error occurs, change the address and reset the system.

Ex.) When address of the indoor unit #1 and #2 are set as 5, address of the indoor unit #1 will become 5 and indoor unit #2 will display E108, A002.

- Floor Standing type (cont.)

■ Indoor unit LED lamp display at error detecting (cont.)

Abnormal condition	Error code	LED Display				
1. COND mid sensor is detached	E241					
2. Refrigerant leakage (2nd detection)	E554					
3. Abnormally high temperature on Cond (2nd detection)	E450					
4. Low pressure s/w (2nd detection)	E451					
5. Abnormally high temperature on discharged air on outdoor unit (2nd detection)	E416					
6. Indoor operation stop due to unconfirmed error on outdoor unit	E559					
7. Error due to reverse phase detection	E425					
8. Comp stop due to freeze detection (6th detection)	E403	×	×	◐	◐	◐
9. High pressure sensor is detached	E301	×	×	◐	◐	◐
10. Low pressure sensor is detached	E306					
11. Outdoor unit copression ration error	E428					
12. Outdoor sump down_1 prevetion control	E413					
13. Compressor down due to low pressure sensor prevention control_1	E410					
14. Simultaneous opening of cooling/heating MCU SOL valve (1st detection)	E180					
15. Simultaneous opening of cooling/heating MCU SOL valve (2nd detection)	E181					
Other outdoor unit self-diagnosis error that is not on the above list						
Flowating s/w (2nd detection)	E153	×	×	×	◐	◐
EEPROM error	E162	◐	◐	◐	◐	◐
EEPROM option error	E163	◐	◐	◐	◐	◐
Error due to incompatible indoor unit	E164	×	×	×	×	◐

● : On ◐ : Flickering × : Off

- If you turn off the air conditioner when the LED is flickering, the LED is also turned off.
- If you re-operate the air conditioner, it operates normally at first, then detect an error again.
- When E108 error occurs, change the address and reset the system.

Ex.) When address of the indoor unit #1 and #2 are set as 5, address of the indoor unit #1 will become 5 and indoor unit #2 will display E108, A002.

- ERV Plus type

If an error occurs during the operation, The Wired Remote controller show that Error mode.

- When ERRORS related to cooling and heating operation occur, the ventilator (ERV) continues to perform in normal operation.
- When ERRORS related to a ventilator (ERV) occur, it stops operating.

■ ERROR CODE DISPLAY on Wired remote controller

Error code	Explanation	Classifications
E101	No communication between indoor unit and outdoor unit	ERRORS RELATED TO COOLING AND HEATING OPERATION
E102	Indoor unit receiving the communication error from outdoor unit	
E122	EVA-IN Sensor(open/short)	
E123	EVA-OUT Sensor(open/short)	
E128	Breakaway of EVA-IN Sensor	
E129	Breakaway of EVA-OUT Sensor	
E174	EVA-IN Air sensor(open/short)	
E151	Error of EEV open	
E152	Error of EEV close	
E161	Error of mixed operation	
E201	Communication error from outdoor unit due to the mismatching of the communication numbers and installed numbers after tracking	
E121	Indoor Temperature Sensor(open/short)	Errors related to ventilator (ERV) operation
E175	Outdoor Temperature Sensor(open/short)	
E139	CO2 sensor (open/short)	
E162	EEPROM ERROR	
E163	EEPROM option setting error	
E186	SPI Error	
E561	Supply Air Fan Motor error	
E562	Exhaust Air Fan Motor error	
E654	Damper ERROR (When there is no switch input for 100 seconds while monitoring the damper)	

- Hydro unit / Hydro unit HT

If an error occurs during the operation, The Wired Remote controller show that Error mode.

- When ERRORS related to cooling and heating operation occur, the ventilator (ERV) continues to perform in normal operation.
- When ERRORS related to a ventilator (ERV) occur, it stops operating.

■ ERROR CODE DISPLAY on Wired remote controller

Error code	Explanation
E101	Communication error between DVM Hydro unit / Hydro unit HT and outdoor unit (When DVM Hydro unit / Hydro unit HT is having trouble with receiving data from outdoor unit)
E102	Communication error on outdoor unit (When outdoor unit is having trouble sending data to DVM Hydro unit / Hydro unit HT)
E110	Communication error between DVM Hydro unit / Hydro unit HT and Control Kit (Detection from the Control Kit)
E121	Error on room temperature sensor of DVM Hydro unit / Hydro unit HT (Short or Open)
E122	Error on EVA IN sensor of DVM Hydro unit / Hydro unit HT (Short or Open)
E123	Error on EVA OUT sensor of DVM Hydro unit / Hydro unit HT (Short or Open)
E128	EVA IN sensor of DVM Hydro unit / Hydro unit HT is detached
E129	EVA OUT sensor of DVM Hydro unit / Hydro unit HT is detached
E130	EVA IN and EVA OUT sensor of DVM Hydro unit / Hydro unit HT is detached
E151	Error due to opened EEV of DVM Hydro unit / Hydro unit HT (2nd detection)
E152	Error due to closed EEV of DVM Hydro unit / Hydro unit HT (2nd detection)
E161	Mixed operation mode error
E162	EEPROM error
E163	EEPROM option setting error
E177	Check the water circulating
E185	Cross wiring error (When power line is connected to communication line of DVM Hydro unit / Hydro unit HT)
E198	Error due to disconnected Thermal Fuse (When the temperature of terminal block is increases)
E601	Communication error between remote controller and the DVM Hydro unit / Hydro unit HT
E602	Communication error between master and slave remote controller
E604	Tracking error between remote controller and the DVM Hydro unit / Hydro unit HT
E618	Error due to exceeding maximum numbers of Hydro unit installation (16 units)
E627	Error due to exceeding maximum numbers of wired remote controller installation (2 units)
E633	Error caused by installing mixed models
E653	Remote controller's temperature sensor is disconnected or has problem
E654	Data error on remote controller (Memory read/write error)
E901	Error on the sensor of water inlet pipe (Short or Open)
E902	Error on the sensor of water outlet pipe (Short or Open)
E904	EEPROM option setting error
E907	Error due to pipe rupture protection
E908	Error due to freeze prevention(Re-operation is possible)
E909	Error due to freeze prevention(Re-operation is impossible)
E910	Water temperature sensor on water outlet pipe is detached
E911	Flow switch off error, When the switch is turned off within 10 seconds after a pump starts its operation(Re-operation is possible)
E913	Six times detection for Flow Switch Error(Re-operation is not possible)
E914	Error due to incorrect thermostat connection
E915	Error on DC fan(Non-operating)
E917	Water Tank Sensor Configuration Error

4-3-4 Number Display Method (Outdoor Unit, MCU, Cable remote control, wall-mount, etc.)

■ How to Display Integrated Error Code

▶ **Meanings of First Alphabetical Character / Number of Error Code**

Displayed alphabet	Explanation	
<i>E</i>	When displaying Error 101~700	
<i>P</i>	When displaying Error 701~800	
<i>C</i>	When E206 occurs	Displays address of subordinate within the set C001 : HUB, C002: FAN, C003: INV1, C004: INV2
	When MCU error occurs	Displays address of MCU Ex) C100: MCU address 0, C101: MCU address 1, C102: MCU address 2
<i>U</i>	When displaying outdoor unit address Ex) U200: Outdoor unit 1, U201: Outdoor unit 2, U202: Outdoor unit 3, U203: Indoor unit 4	
<i>A</i>	When displaying indoor unit address Ex) A000: Indoor unit address 0, A001: Indoor unit address 1, A002: Indoor unit address 2	

▶ **Order of Error Display**

Classification	Error display method	Display Example
Display method for error that occurred in indoor unit	Error Number → Indoor unit address → Error Number, repeat display	E471 → A002 → E471 → A002
Display method for error that occurred in outdoor unit and other methods of error display	Error Number → Outdoor unit address → Error Number, repeat display	E471 → U200 → E471 → U200 E206 → C001 → E206 → C002

■ Diagnosis and Adjustment (Error Code)

▶ Error code related indoor unit

CODE	Explanation
E-101	Indoor unit communication error. Indoor unit can not receive any data from outdoor unit.
E-102	Communication error between indoor unit and outdoor unit. Displayed in indoor unit.
E-108	Error due to repeated address setting (When 2 or more devices has same address within the network)
E-109	Communication address not confirmed other outdoor unit communication error that is not on the above list
E-110	Communication error between Hydro unit HT(Main PBA) and Control kit PBA(Detection from the Control kit)
E-121	Error on indoor temperature sensor of indoor unit (Short or Open)
E-122	Error on EVA IN sensor of indoor unit (Short or Open)
E-123	Error on EVA OUT sensor of indoor unit (Short or Open)
E-128	EVA IN temperature sensor of indoor unit is detached from EVA IN pipe
E-129	EVA OUT temperature sensor of indoor unit is detached from EVA OUT pipe
E-130	Heat exchanger in/out sensors of indoor unit are detached
E-135	RPM feedback error of indoor unit's cleaning fan
E-151	Error due to opened EEV of indoor unit (2nd detection)
E-152	Error due to closed EEV of indoor unit (2nd detection)
E-153	Error on floating switch of indoor unit (2nd detection)
E-154	RPM feedback error of indoor unit
E-161	Mixed operation mode error of indoor unit; When outdoor unit is getting ready to operate in cooling (or heating) and some of the indoor unit is trying to operate in heating (or cooling) mode
E-162	EEPROM error of MICOM (Physical problem of parts/circuit)
E-163	Indoor unit's remote controller option input is Incorrect or missing. Outdo or unit EEPROM data error
E-180	Simultaneous opening of cooling/heating MCU SOL V/V (1st detection)
E-181	Simultaneous opening of cooling/heating MCU SOL V/V (2nd detection)
E-185	Cross wiring error between communication and power cable of indoor unit
E-186	Connection error or problem on SPi
E-190	No temperature changes in EVA IN during pipe inspection or changes in temperature is seen in indoor unit with wrong address
E-191	No temperature changes in EVA OUT during pipe inspection or changes in temperature is seen in indoor unit with wrong address
E-198	Error due to disconnected thermal fuse of indoor unit
E-201	Communication error between indoor and outdoor units (installation number setting error, repeated indoor unit address, indoor unit communication cable error)
E-202	Communication error between indoor and outdoor units (Communication error on all indoor unit, outdoor unit communication cable error)
E-203	Communication error between main and sub outdoor units
E-205	Communication error on all PBA within the outdoor unit C-Box, communication cable error
E-206	E206-C001: HUB PBA communication error / E206-C002: FAN PBA communication error E206-C003: INV1 PBA communication error / E206-C004: INV2 PBA communication error

■ Diagnosis and Adjustment (Error Code)

▶ Error code related to the Communications / Settings / HW (cont.)

CODE	Explanation
E-211	When single indoor unit uses 2 MCU ports that are not in series.
E-212	If the rotary switch (on the MCU) for address setting of the indoor unit has 3 or more of the same address
E-213	When total number of indoor units assigned to MCU is same as actual number of installed indoor units but there is indoor unit that is not installed even though it is assigned on MCU
E-214	When number of MCU is not set correctly on the outdoor unit or when two or more MCU was installed some of them have the same address
E-215	When two different MCU's have same address value on the rotary switch
E-216	When indoor unit is not installed to a MCU port but the switch on the port is set to On.
E-217	When indoor unit is connected to a MCU port but indoor unit is assigned to a MCU and the switch on the port is set to Off
E-218	When there's at least one or more actual number of indoor unit connection compared to number of indoor units assigned to MCU
E-219	Error on temperature sensor located on MCU intercooler inlet (Short or Open)
E-220	Error on temperature sensor located on MCU intercooler outlet (Short or Open)
E-221	Error on outdoor temperature sensor of outdoor unit (Short or open)
E-231	Error on COND OUT temperature sensor of main outdoor unit (Short or Open)
E-241	COND OUT sensor is detached
E-251	Error on discharge temperature sensor of compressor 1 (Short or Open)
E-257	Error on discharge temperature sensor of compressor 2 (Short or Open)
E-262	Discharge temperature sensor of compressor 1 is detached from the sensor holder on the pipe
E-263	Discharge temperature sensor of compressor 2 is detached from the sensor holder on the pipe
E-266	Top sensor of compressor 1 is detached
E-267	Top sensor of compressor 2 is detached
E-269	Suction temperature sensor is detached from the sensor holder on the pipe
E-276	Error on top sensor of compressor 1 (Short or Open)
E-277	Error on top sensor of compressor 2 (Short or Open)
E-291	Refrigerant leakage or error on high pressure sensor (Short or Open)
E-296	Refrigerant leakage or error on low pressure sensor (Short or Open)
E-308	Error on suction temperature sensor (Short or Open)

■ Diagnosis and Adjustment (Error Code)

▶ Error code related to the Communications / Settings / HW (cont.)

CODE	Explanation
E-311	Error on temperature sensor of double layer pipe/liquid pipe(sub heat exchanger) (Short or Open)
E-321	Error on EVI (ESC) IN temperature sensor (Short or Open)
E-322	Error on EVI (ESC) OUT temperature sensor (Short or Open)
E-323	Error on suction sensor 2 (Short or Open)
E-346	Error due to operation failure of Fan2
E-347	Motor wire of Fan2 is not connected
E-348	Lock error on Fan2 of outdoor unit
E-353	Error due to overheated motor of outdoor unit's Fan2
E-355	Error due to overheated IPM of Fan2
E-361	Error due to operation failure of inverter compressor 2
E-364	Error due to over-current of inverter compressor 2
E-365	V-limit error of inverter compressor 2
E-366	Error due to over voltage /low voltage of inverter PBA2
E-367	Error due to unconnected wire of compressor 2
E-368	Output current sensor error of inverter PBA2
E-369	DC voltage sensor error of inverter PBA2
E-374	Heat sink temperature sensor error of inverter PBA2
E-378	Error due to overcurrent of Fan2
E-385	Error due to input current of inverter 2
E-386	Over-voltage/low-voltage error of Fan2
E-387	Hall IC connection error of Fan2
E-389	V-limit error on Fan2 of compressor
E-393	Output current sensor error of Fan2
E-396	DC voltage sensor error of Fan2
E-399	Heat sink temperature sensor error of Fan2
E-400	Error due to overheat caused by contact failure on IPM of Inverter PBA2
E-407	Compressor operation stop due to high pressure protection control
E-410	Compressor operation stop due to low pressure protection control or refrigerant leakage
E-416	Compressor operation stop due to discharge temperature protection control
E-425	Phase reversal or phase failure (3Ø outdoor unit wiring, R-S-T-N), connection error on 3 phase input
E-428	Compressor operation stop due abnormal compression ratio
E-438	EVI (ESC) EEV leakage or internal leakage of intercooler or incorrect connector insertion of EVI (ESC) EEV
E-439	Error due to refrigerant leakage
E-440	Heating mode restriction due to high air temperature
E-441	Cooling mode restriction due to low air temperature
E-442	Refrigerant charging restriction in heating mode when air temperature is over 15 °C
E-443	Operation prohibited due to the pressure drop
E-445	CCH is deatched
E-446	Error due to operation failure of Fan1

■ **Diagnosis and Adjustment (Error Code)**

▶ **Error code related to the Communications / Settings / HW (cont.)**

CODE	Explanation
E-447	Motor wire of Fan1 is not connected
E-448	Lock error on Fan1
E-452	Error due to ZPC detection circuit problem or power failure
E-453	Error due to overheated motor of outdoor unit's Fan1
E-455	Error due to overheated IPM of Fan1
E-461	Error due to operation failure of inverter compressor 1
E-462	Compressor stop due to full current control or error due to low current on CT2
E-464	Error due to over-current of inverter compressor 1
E-465	V-limit error of inverter compressor 1
E-466	Error due to over voltage /low voltage of inveter PBA1
E-467	Error due to unconnected wire of compressor 1
E-468	Output current sensor error of inverter PBA1
E-469	DC voltage sensor error of inver PBA1
E-474	Heat sink temperature sensor error of inverter PBA1
E-478	Error due to overcurrent of Fan1
E-485	Error due to input current of inverter 1
E-486	Error due to over voltage/low voltage of Fan
E-487	Hall IC error of Fan1
E-489	V-limit error on Fan1 of compressor
E-493	Output current sensor error of Fan1
E-496	DC voltage sensor error of Fan1
E-499	Heat sink temperature sensor error of Fan1
E-500	Error due to overheat caused by contact failure on IPM of Inverter PBA1
E-503	Error due to alert the user to check if the service valve is closed
E-504	Error due to self diagnosis of compressor operation
E-505	Error due to self diagnosis of high pressure sensor
E-506	Error due to self diagnosis of low pressure sensor
E-560	Outdoor unit's option switch setting error (when inappropriate option switch is on)
E-563	Error due to module installation of indoor unit with old version (Micom version needs to be checked)
E-573	Error due to using single type outdoor unit in a module installation
E-601	Communication error between remote controller and the DVM Hydro unit / Hydro unit HT
E-602	Communication error between master and slave remote controller
E-604	Tracking error between remote controller and the DVM Hydro unit / Hydro unit HT
E-618	Error due to exceeding maximum numbers of Hydro unit installation (16 units)
E-627	Error due to exceeding maximum numbers of wired remote controller installation (2 units)
E-633	Error caused by installing mixed models
E-653	Remote controller's temperature sensor is disconnected or has problem
E-654	Data error on remote controller (Memory read/write error)

■ Diagnosis and Adjustment (Error Code)

▶ Error code related to the Communications / Settings / HW (cont.)

CODE	Explanation
E-702	Error due to closed EEV of indoor unit (1st detection)
E-703	Error due to opened EEV of indoor unit (1st detection)
E-901	Error on the sensor of water inlet pipe (Short or Open)
E-902	Error on the sensor of water outlet pipe (Short or Open)
E-904	Error on water tank (Short or open)
E-907	Error due to pipe rupture protection
E-908	Error due to freeze prevention(Re-operation is possible)
E-909	Error due to freeze prevention(Re-operation is impossible)
E-910	Water temperature sensor on water outlet pipe is detached
E-911	Flow switch off error, When the switch is turned off within 10 seconds after a pump starts its operation(Re-operation is possible)
E-913	Six times detection for Flow Switch Error(Re-operation is not possible)
E-914	Error due to incorrect thermostat connection
E-915	Error on DC fan(Non-operating)
E-917	Water Tank Sensor Configuration Error
UP	Trial operation incompleted (UnPrepared) - It will be cleared when trial operation was executed for 1 hour or when automatic inspection is completed

4-4 Appropriate Measures for Different Symptom

4-4-1 Outdoor Unit Operation Flow

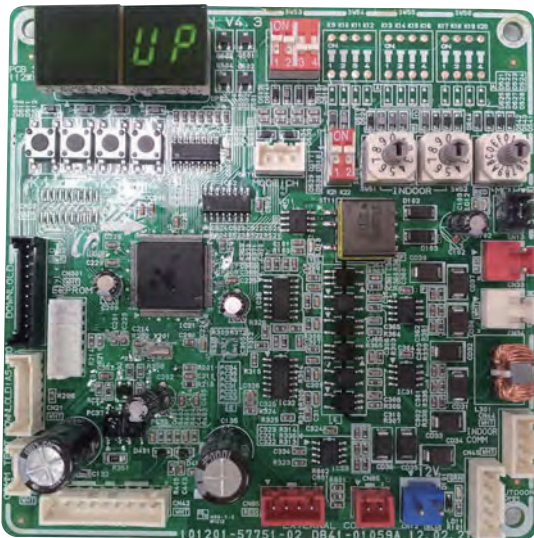
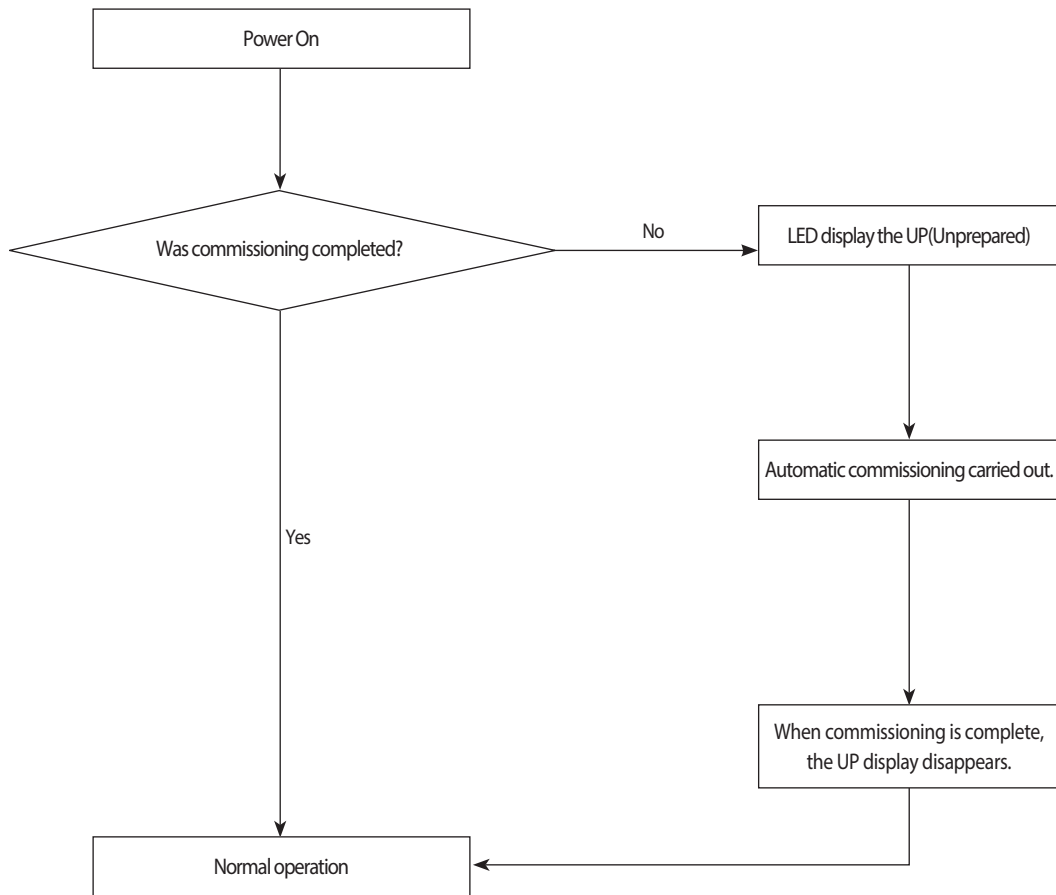

Commissioning if it is not running - UP is displayed

Prior to starting the air conditioning operation after the initial installation and automatic commissioning is carried out. This process, the stable operation to protect the system and verify the defect of the product.

1. Tracking is complete and after the initial installation, if you do not have a history of commissioning is completed, UP will be displayed.
2. Execute the automatic commissioning by Tact Switch.
3. UP display disappears after commissioning is complete, normal operation is possible.
4. Automatic commissioning is completed, if there is a history, normal operation execution immediately.

4-4-2 Main PCB has no power phenomenon

Outdoor unit display	Main PCB has no power phenomenon (7-seg does not blink)
Judgment Method	Hub PCB power and connection wire to detect.
Cause of problem	<ul style="list-style-type: none"> · HUB PCB connector wire defects and the connection is not. · Main PCB defective. · Hub PCB defective. · High pressure switch operation

1. Cause of problem

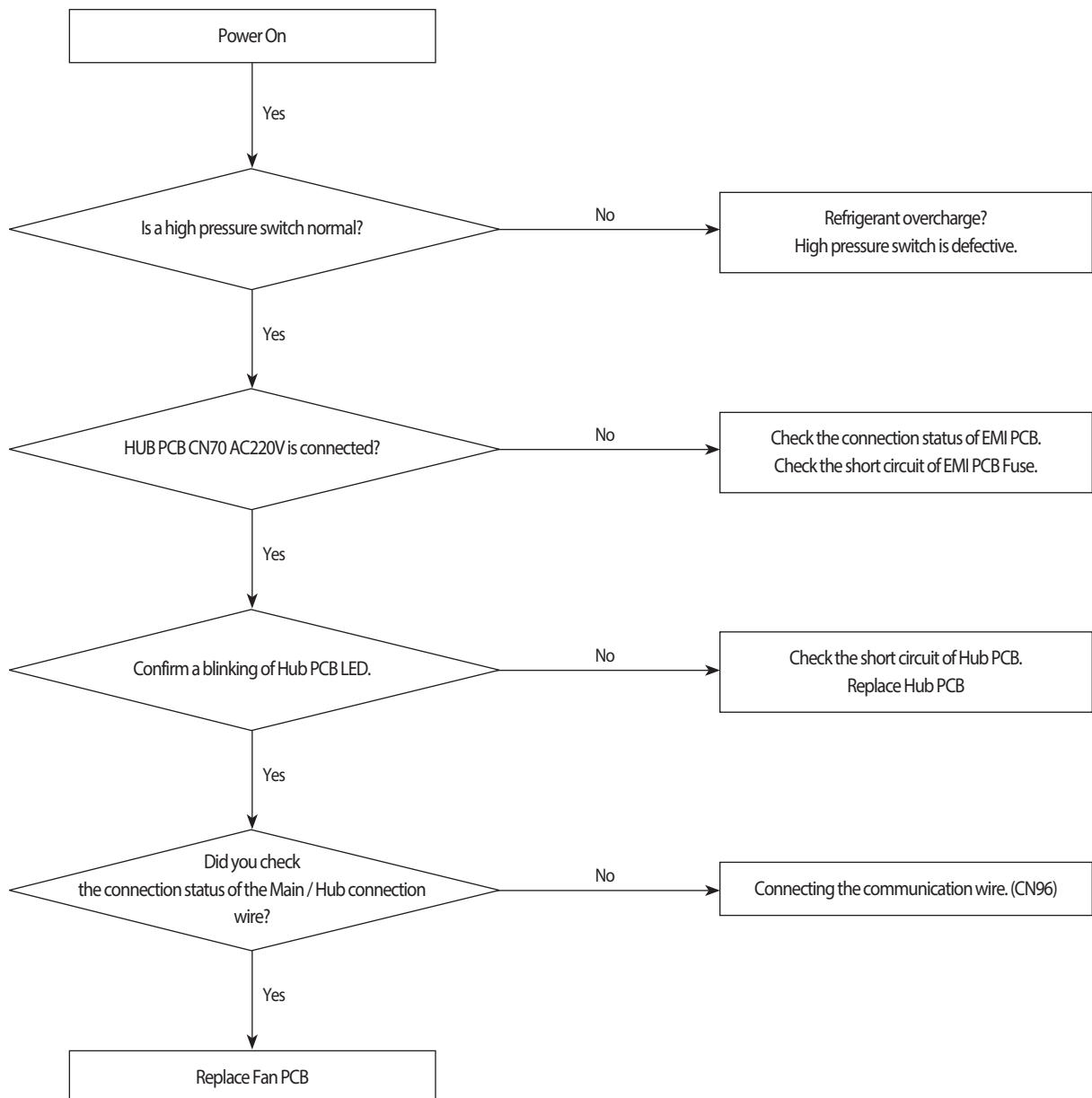

4-4-3 Indoor Unit ROOM sensor Error (Open/Short)

Outdoor unit display	E 121 ← A x x x (x x x : The address of the error occurred indoor unit)																	
Indoor unit display	Duct, Cassette (1 way / 2 way / Mini-4 way)				4 Way Cassette Type				Wall mounted Type				Circular Cassette Type					
	Display LED																	
	1 way	Blue	Yellow-Green	or	or	Start /Stop	Defroster	Reser- -vation	Filter -clean	18 °C	21 °C	Reser- -vation	24 °C	27 °C	Sky- -Blue	Yellow- -Green	Blue	Red
	2 way	Green	Red	or	or	or	or	or	or	or	or	or	or	or	or	or	or	or
	×	×	○	×	×	×	○	×	×	×	×	×	×	×	×	×	×	○
Criteria	• Refer to how to determine below																	
Cause of problem	• The room temperature sensor of No. XXX indoor unit has defective OPEN/SHORT																	

1. How to check

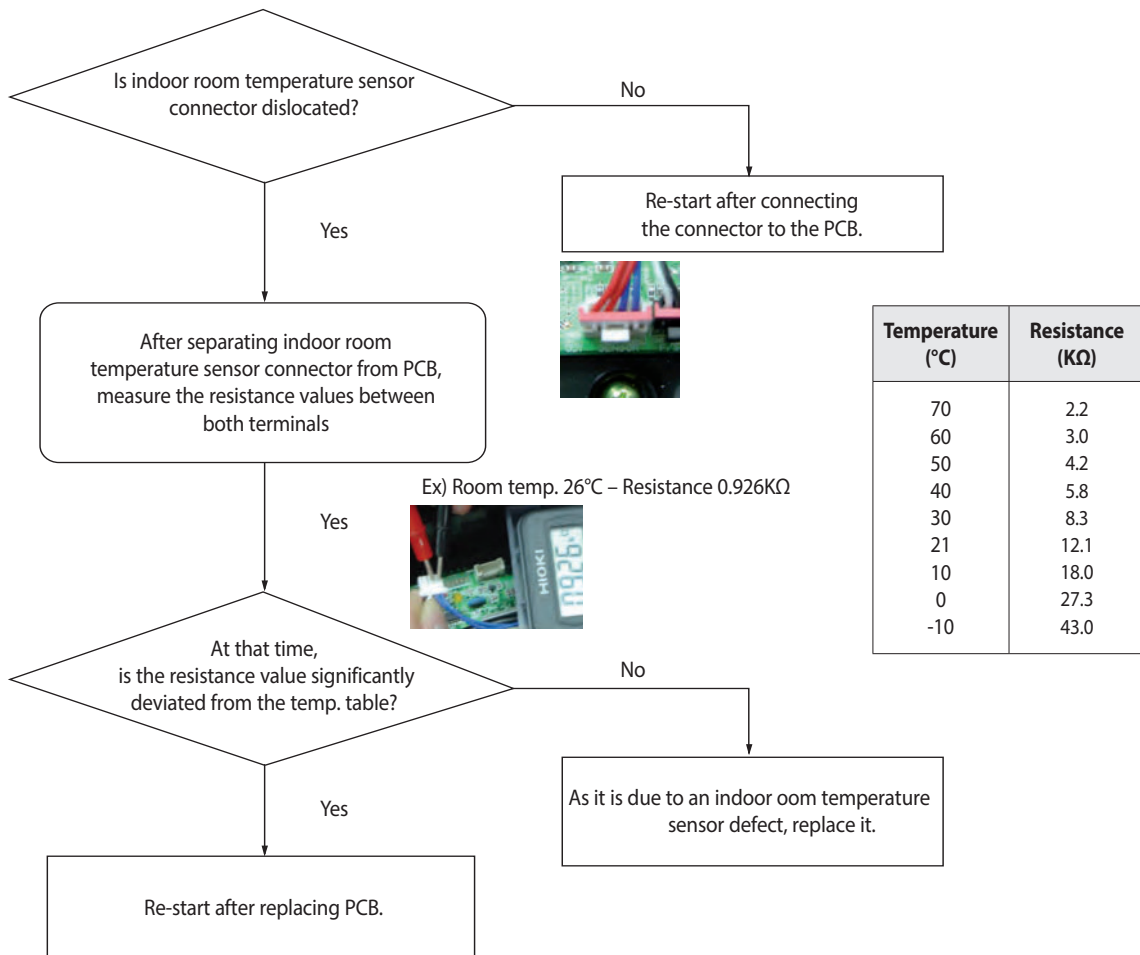

4-4-4 Indoor unit EVAP IN sensor Error (Open/Short)

Outdoor unit display	E 122 ← A x x x (x x x : The address of the error occurred indoor unit)																	
Indoor unit display	Duct, Cassette (1 way / 2 way / Mini-4 way)				4 Way Cassette Type				Wall mounted Type				Circular Cassette Type					
	Display LED																	
	1 way	Blue	Yellow-Green	or	or	Start /Stop	Defroster	Reser- -vation	Filter- -clean	18 °C	21 °C	Reser- -vation	24 °C	27 °C	Sky- -Blue	Yellow- -Green	Blue	Red
	2 way	Green	Red	or	or	Start /Stop	Defroster	Reser- -vation	Filter- -clean	18 °C	21 °C	Reser- -vation	24 °C	27 °C	Sky- -Blue	Yellow- -Green	Blue	Red
	●	×	●	×	×	●	●	×	×	●	×	●	×	×	×	●	×	●
Criteria	• Refer to how to determine below																	
Cause of problem	• The EVAP IN sensor of No. XXX indoor unit has defective OPEN/SHORT																	

1. How to check

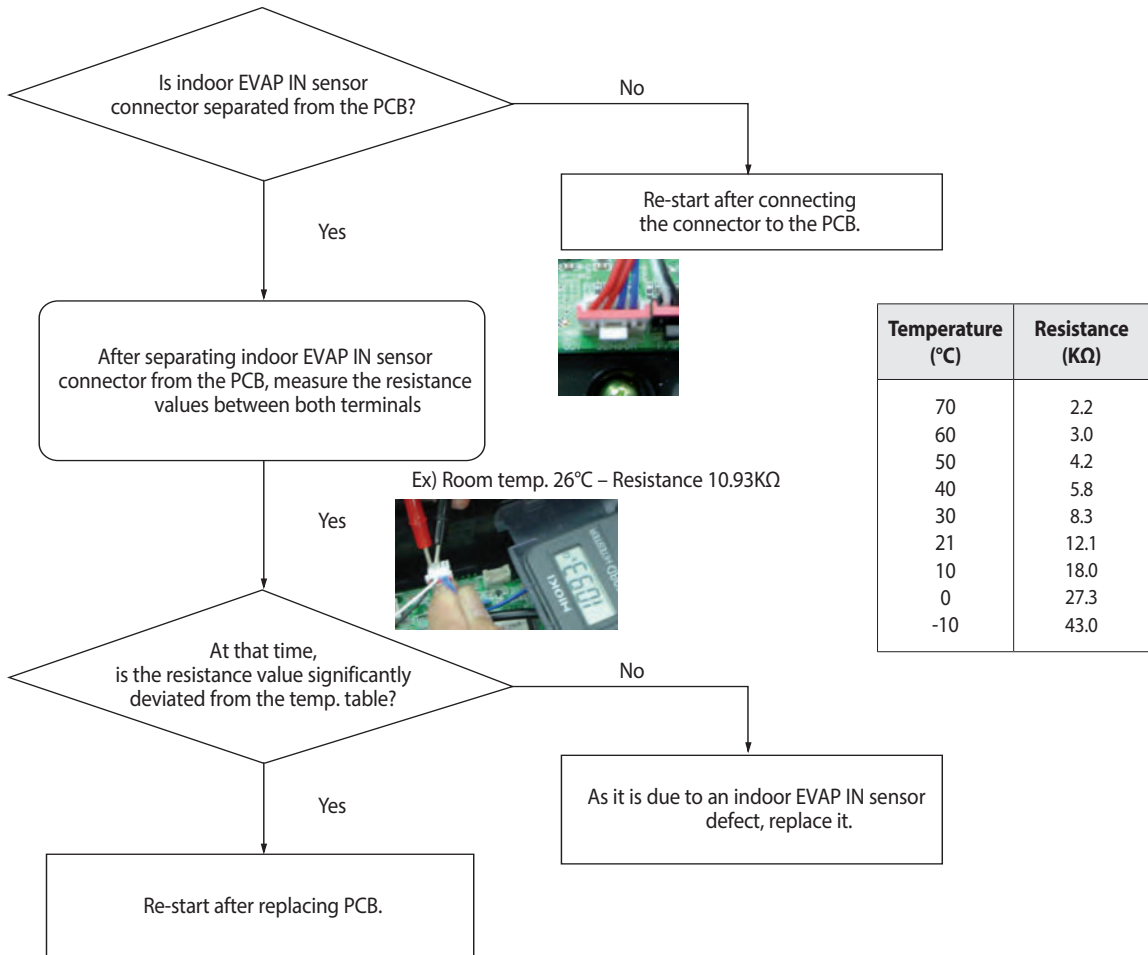

4-4-5 Indoor EVAP OUT sensor Error (Open/Short)

Outdoor unit display	E 123 ↔ A x x x (x x x : The address of the error occurred indoor unit)																		
Indoor unit display	Duct, Cassette (1 way / 2 way / Mini-4 way)				4 Way Cassette Type				Wall mounted Type				Circular Cassette Type						
	Display LED																		
	1 way	Blue	Yellow-Green	2 way	Green	Red	Start /Stop	Defroster	Reser- -vation	Filter -clean	18 °C	21 °C	Reser- -vation	24 °C	27 °C	Sky- -Blue	Yellow- -Green	Blue	Red
	○	○	○	○	○	○	○	○	○	○	○	○	○	○	○	○	○	○	○
Criteria	• Refer to how to determine below																		
Cause of problem	• The EVAP out sensor of No. XXX indoor unit has defective OPEN/SHORT																		

1. How to check

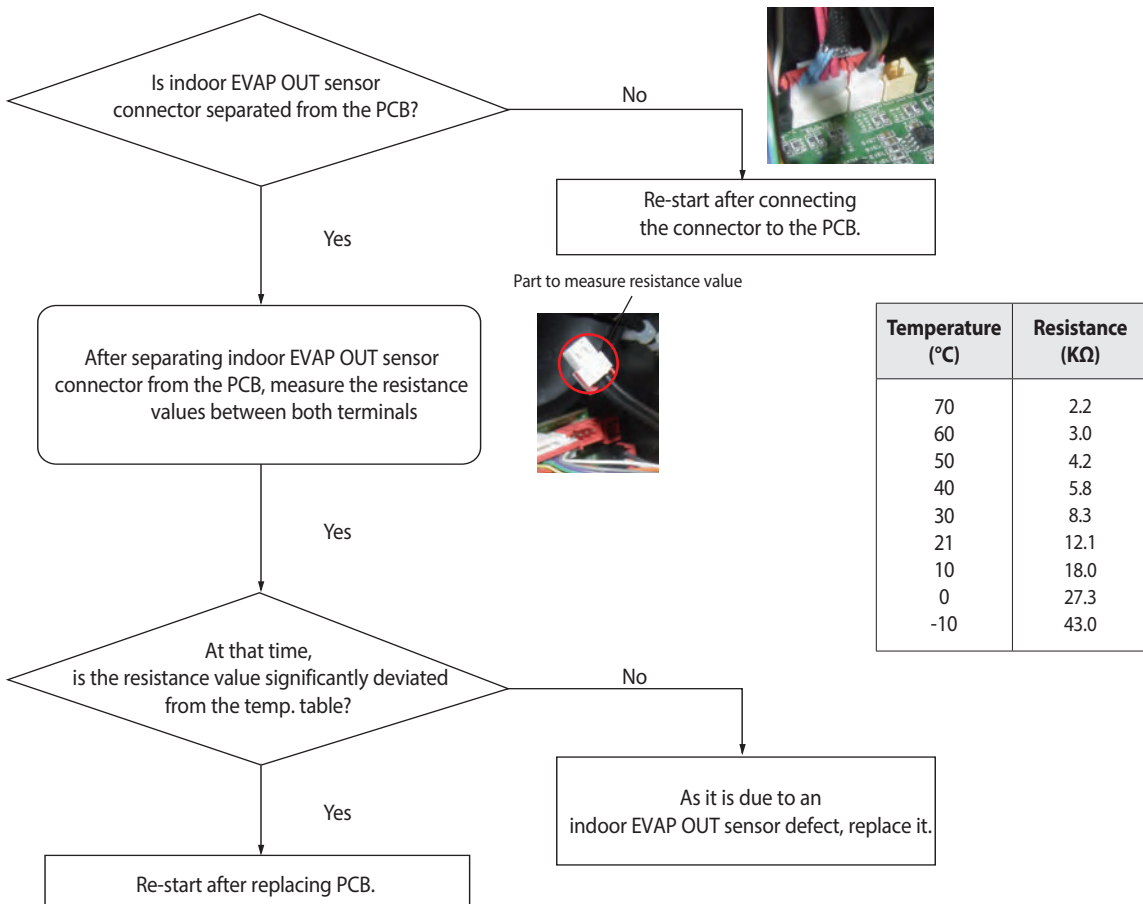

4-4-6 Indoor Heat Exchanger's EVAP IN sensor dislocation error

Outdoor unit display	E 128 ← A x x x (x x x : The address of the error occurred indoor unit)																	
Indoor unit display	Duct, Cassette (1 way / 2 way / Mini-4 way)			4 Way Cassette Type				Wall mounted Type				Circular Cassette Type						
	Display LED																	
	1 way	Blue	Yellow-Green	or	or	Start /Stop	Defroster	Reser- -vation	Filter -clean	18 °C	21 °C	Reser- -vation	24 °C	27 °C	Sky -Blue	Yellow -Green	Blue	Red
	2 way	Green	Red	or	or	Start /Stop	Defroster	Reser- -vation	Filter -clean	18 °C	21 °C	Reser- -vation	24 °C	27 °C	Sky -Blue	Yellow -Green	Blue	Red
Criteria	• Refer to how to determine below																	
Cause of problem	• Indoor heat exchanger's EVAP IN piping sensor has been dislocated																	

1. How to diagnose

1) During Cooling Operation

Tcond, out - Tair, out > 3°C	OK
Tair, in - Teva, out > 4°C	NO
Tair, in - Teva, out > 4°C	OK
Compressor in operation & Indoor Unit operation & Thermo On	OK
Error details	Breakaway Error of Indoor Heat Exchanger EVA Out sensor

* Hydro Unit : Before and after the Compressor operation, EVA Out temperature difference is less than 3°C.

2) During Heating operation

Average high pressure > 25kg/cm ²	OK
Average low pressure > 8.5kg/cm ²	OK
Tcond, out - Tair, out ≥ 3°C	OK
Tair, in - Teva, out ≥ 2°C	NO
Tcond, out - Tair, out < -2°C	OK
Compressor in operation & Indoor Unit operation & Thermo On	OK
Error details	Breakaway Error of Indoor Heat Exchanger EVA Out sensor

2. How to check

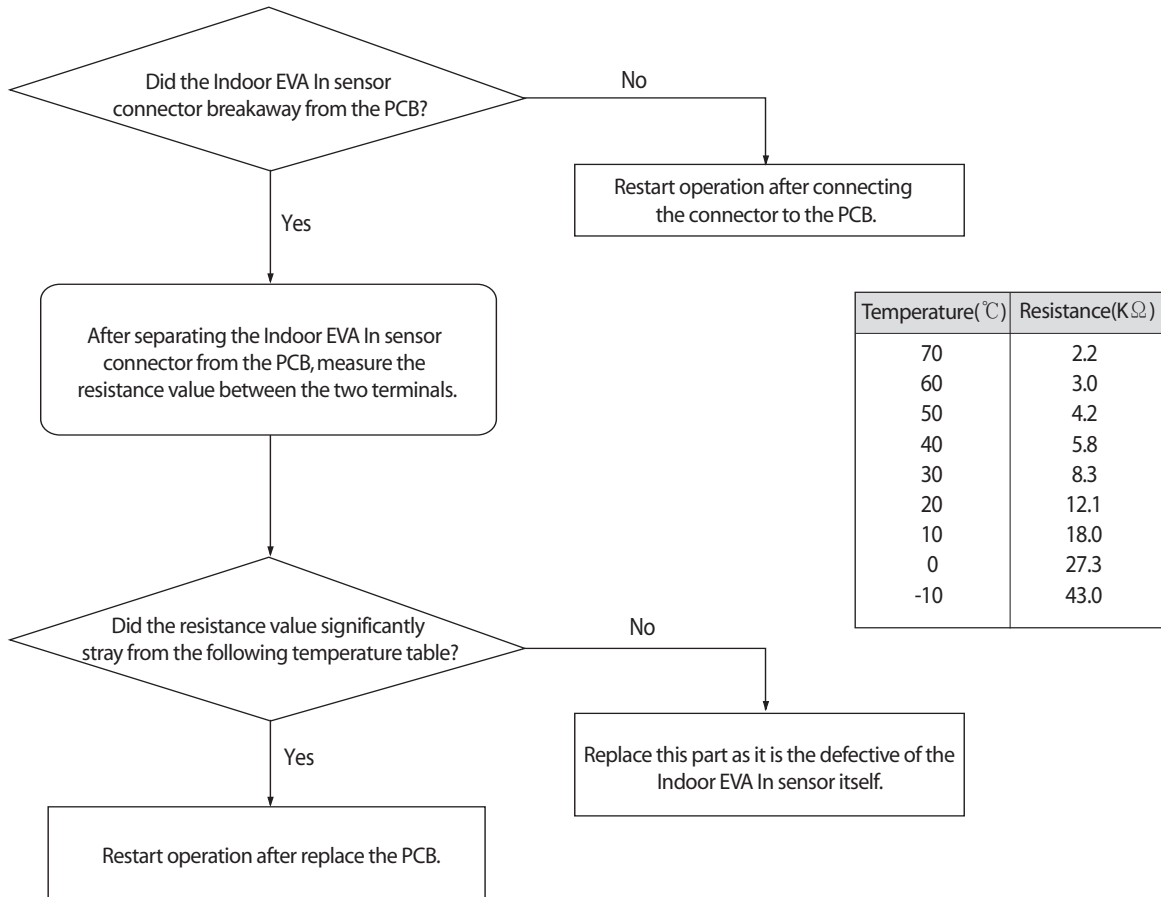

4-4-7 Indoor Heat Exchanger's EVA OUT sensor dislocation error (Open/Short)

Outdoor unit display	E 129 ← A xxx (xxx : The address of the error occurred indoor unit)																	
Indoor unit display	Duct, Cassette (1 way / 2 way / Mini-4 way)			4 Way Cassette Type				Wall mounted Type				Circular Cassette Type						
	Display LED																	
	1 way	Blue	Yellow-Green	or	or	Start /Stop	Defroster	Reser- -vation	Filter -clean	18 °C	21 °C	Reser- -vation	24 °C	27 °C	Sky- -Blue	Yellow- -Green	Blue	Red
	2 way	Green	Red	or	or	Start /Stop	Defroster	Reser- -vation	Filter -clean	18 °C	21 °C	Reser- -vation	24 °C	27 °C	Sky- -Blue	Yellow- -Green	Blue	Red
Criteria	• Refer to the judgment method below.																	
Cause of problem	• Breakaway of Indoor Heat Exchanger EVA Out sensor																	

1. How to diagnose

1) During Cooling Operation

Tcond, out - Tair, out > 3°C	OK
Tair, in - Teva, out > 4°C	NO
Tair, in - Teva, out > 4°C	OK
Compressor in operation & Indoor Unit operation & Thermo On	OK
Error details	Breakaway Error of Indoor Heat Exchanger EVA Out sensor

* Hydro Unit : Before and after the Compressor operation, EVA Out temperature difference is less than 3°C.

2) During Heating operation

Average high pressure > 25kg/cm ²	OK
Average low pressure > 8.5kg/cm ²	OK
Tcond, out - Tair, out ≥ 3°C	OK
Tair, in - Teva, out ≥ 2°C	NO
Tcond, out - Tair, out < -2°C	OK
Compressor in operation & Indoor Unit operation & Thermo On	OK
Error details	Breakaway Error of Indoor Heat Exchanger EVA Out sensor

2. How to check

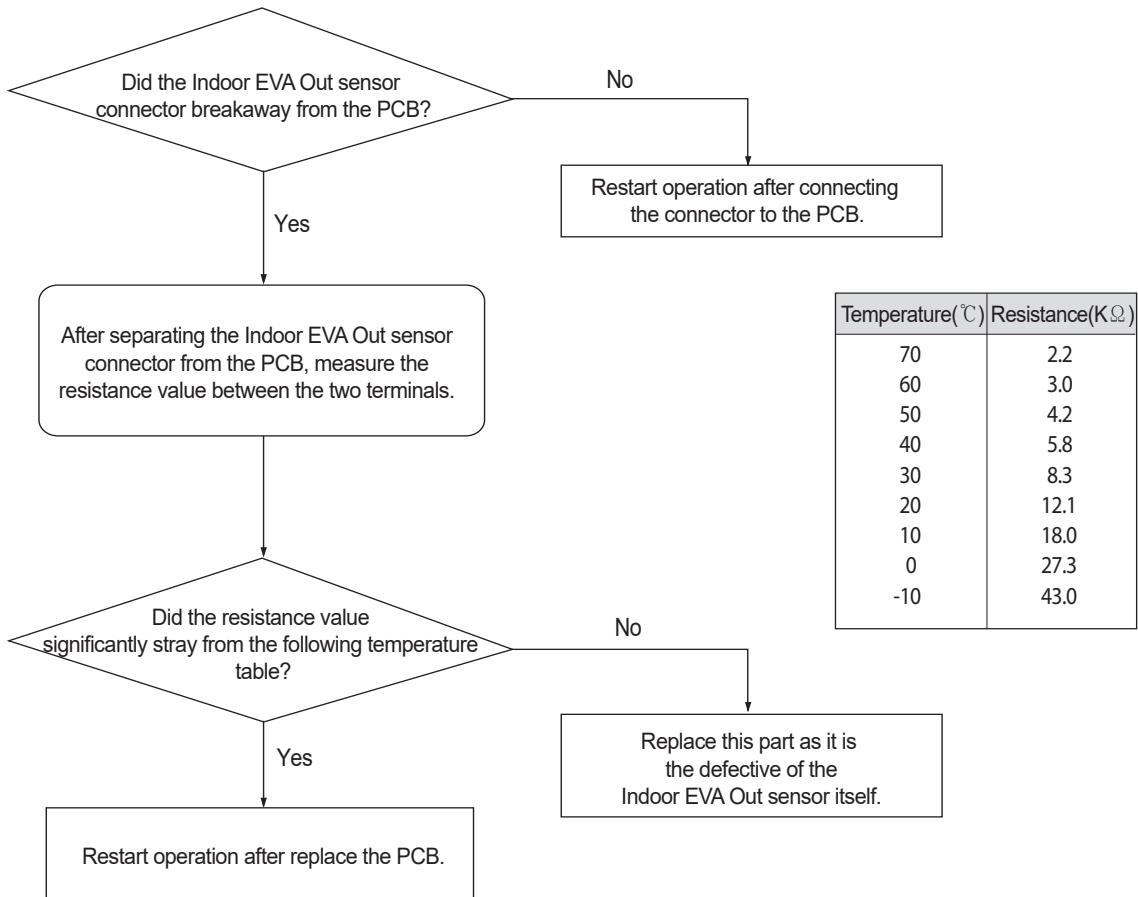

4-4-8 Simultaneous Indoor Heat Exchanger's EVA IN, OUT sensor dislocation error (Open/Short)

1. How to diagnose

1) During Cooling Operation

Tcond, out - Tair, out > 3°C	OK
Tair, in - Teva, out > 4°C	NO
Tair, in - Teva, out > 4°C	NO
Compressor in operation & Indoor unit operation & Thermo On	OK
Error details	Simultaneous indoor heat exchanger's EVA IN, OUT sensor dislocation error

2) During Heating operation

Average high pressure > 25kg/cm ²	OK
Average low pressure > 8.2kg/cm ²	OK
Teva, out - Tair, out ≥ 3°C	NO
Tair, in - Teva, out ≥ 2°C	NO
Tcond, out - Tair, out < -2°C	OK
Compressor in operation & Indoor unit operation & Thermo On	OK
Error details	Simultaneous Indoor heat exchanger's EVA IN, OUT sensor dislocation error

2. How to check

Check if an Indoor heat exchanger's EVA IN, OUT sensor has been dislocated then is correct after assembling.

4-4-9 Electronic Expansion Valve opening malfunction (2nd stage) - E 135

Outdoor unit display	1st detection : P703 (Outdoor Unit display only) 2nd detection : E 135 ↔ A ××× (××× : The address of the error occurred indoor unit)
Indoor unit display	×(Operation) ×(Timer) ●(Fan) ×(Filter) ×(Defrost)
Criteria	• Refer to the judgment method below.
Cause of problem	• Faulty Indoor Unit EEV action. (Refrigerant will leak into the stopped Indoor Unit.)

1. How to diagnose

- During Cooling operation, the temperature of the inlet or outlet of stopped Heat Exchanger is kept lower than 0°C for more than 20 minutes without cessation.
- Hydro Unit : During the defrost operation, detection from stop-side Indoor Unit. (Temperature of the inlet of Heat Exchanger is kept lower than 0°C for more than 20 minutes without cessation.)

2. How to check

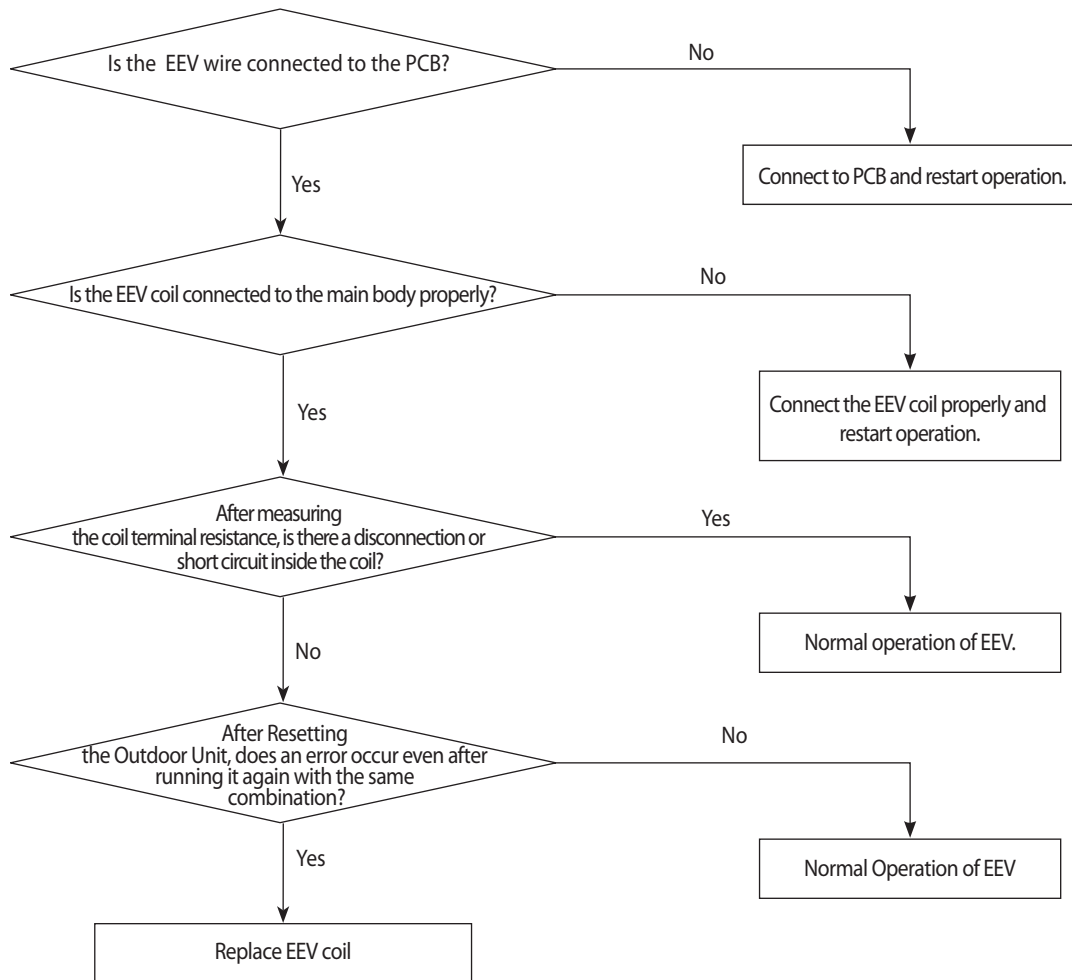

*** How to turn off the Hydro Unit E151**

- Hydro Unit PCB k1, k2 switch : At the same time push for more than 4 seconds.
- After resolving the cause of the error, restart operation.
- (Excessive reset operation, can cause damage to the Heat Exchanger.)

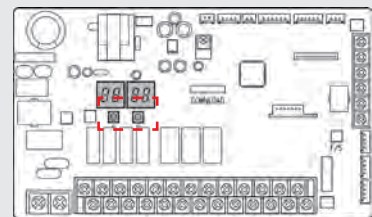

4-4-10 Breakdown of EEV (2nd)

1. How to diagnose

Detect only on cooling operation. (No detection during heating operation.)

During cooling operation, the temperature of the inlet or outlet ducts of heat exchanger is kept below 0°C for more than 20 minutes without cessation

2. How to check

1) Check if the wire of electronic expansion valve is correctly connected to the PCB of indoor unit.

2) Check if the coil of an electronic expansion valve is correctly plugged into the main body.

3) Check if there is any rust on the surface of the electronic expansion valve with naked eyes then check the resistance between each terminal to find any wire breaking or short circuit.

4) Press the RESET KEY (K3) of the outdoor unit then see if the same error occurs.

- In case of closure problem, operate the indoor unit in which the error has occurred.

- In case of opening problem, please do not operate the indoor unit in which the error has occurred.

5) If there is no problem with the above checkup items, replace the electronic expansion valve of the troubled indoor unit.

- As an electronic expansion valve replacement is tricky work that requires collecting refrigerants in all systems, please check the above items before replacement.

4-4-11 Problem with EEV closure (2nd)

1. How to diagnose

1) During Cooling operation(Each of the below conditions have to be met for at least 20 minutes.)

Tcond, out - Tair, out > 3°C	OK
Tair, in - Teva, out > 4°C	NO
Tair, in - Teva, out > 4°C	NO
Compressor in operation & Indoor unit operation & Thermo On	OK
Error details	Electrically operated valve closure breakdown

2) During heating operation (must satisfy all conditions below)

- When more than 2 indoor units are on Thermo On heating operation.
- When average high pressure is over 18kg/cm²
- 5 minutes after finishing Safety Start
- Keep Indoor units' T(Eva_In)<T(Room) +3°C and T(Eva_Out)<T(Room) +3°C condition for more than 5 minutes

2. How to check

- 1) Check if the wire of electronic expansion valve is correctly connected to the PCB of indoor unit.
- 2) Check if the coil of electronic expansion valve is correctly plugged into the main body.
- 3) Check if there is any rust on the surface of the electronic expansion valve with naked eye then check the resistance between each terminal to find any wire breaking or short circuit.
- 4) Press the RESET KEY (K3) of the outdoor unit then see if the same error occurs.
 - In case of closure problem, operate the indoor unit in which the error has occurred.
 - In case of opening problem, please do not operate the indoor unit in which the error has occurred.
- 5) If there is no problem with the above checkup items, replace the electronic expansion valve of the troubled indoor unit.
 - As electronic expansion valve replacement is tricky work that requires collecting refrigerants in all systems, please check the above items before replacement.

4-4-12 EEV(Electronic Expansion Valve) opening malfunction (2nd stage)

Outdoor unit display	1st detection : P703 (Outdoor Unit display only) 2nd detection : <i>E 15 1</i> ↔ <i>A</i> ^{x x x} (x x x : The address of the error occurred indoor unit)																
Indoor unit display	Duct, Cassette (1 way / 2 way / Mini-4 way)			4 Way Cassette Type			Wall mounted Type			Circular Cassette Type							
	Display LED																
	1 way Blue Yellow-Green		or or	or	Start /Stop	Defroster	Reser- -vation	Filter -clean	18 °C	21 °C	Reser- -vation	24 °C	27 °C	Sky- -Blue	Yellow- -Green	Blue	Red
	2 way Green Red																
×	×	●	●	●	×	●	●	●	×	×	●	●	×	×	●	×	
Criteria	• Refer to the judgment method below.																
Cause of problem	• Faulty Indoor Unit EEV action. (Refrigerant will leak into the stopped Indoor Unit.)																

- How to diagnose
Detect only on cooling operation. (No detection during heating operation.)
During Cooling operation, the temperature of the inlet or outlet of stopped Heat Exchanger is kept lower than 0°C for more than 20 minutes without cessation.
- How to check

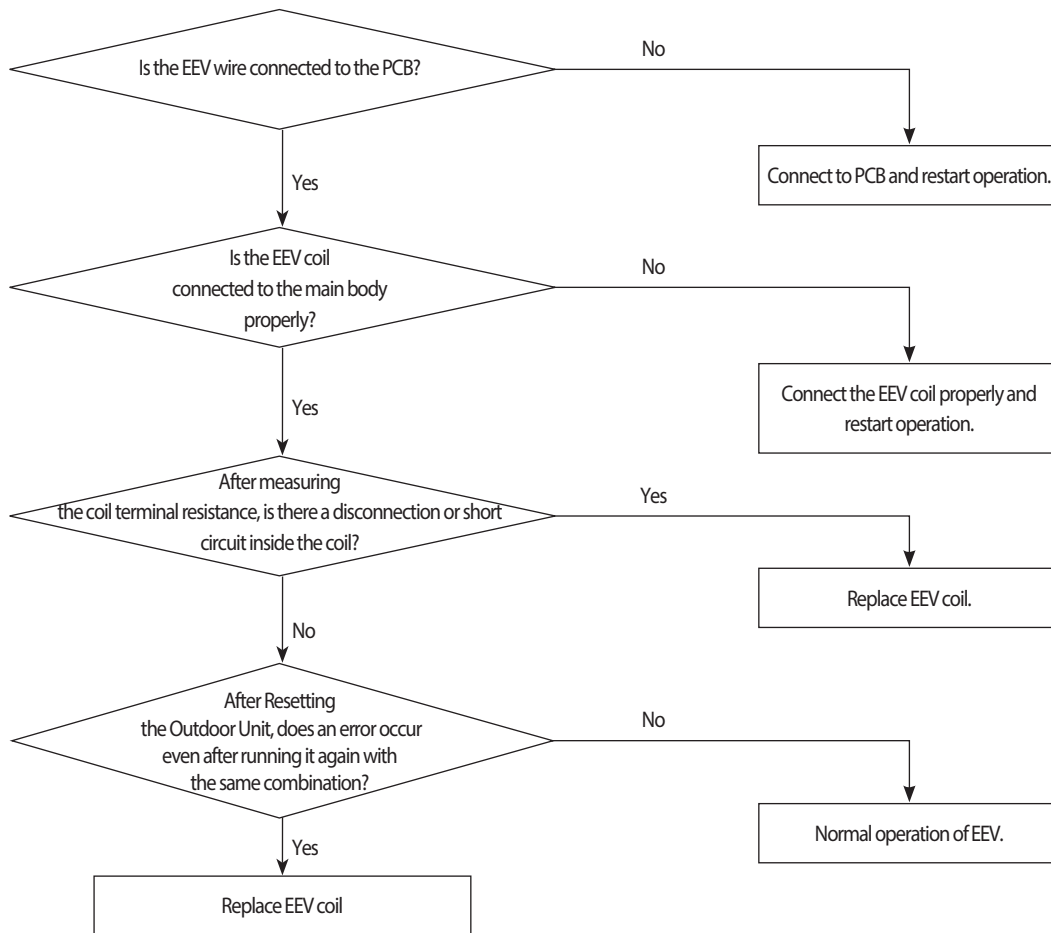

• How to turn off the Hydro Unit E151

- Hydro Unit PCB k1, k2 switch : At the same time push for more than 4 seconds.
- After resolving the cause of the error, restart operation. (Excessive reset operation, can cause damage to the Heat Exchanger.)

4-4-13 E 152 : EEV(Electronic Expansion Valve) closure malfunction (2nd stage)

Outdoor unit display	1st detection : P702 (Outdoor Unit display only) 2nd detection : E 152 ↔ A × × × (× × × : The address of the error occurred indoor unit)																
Indoor unit display	Duct, Cassette (1 way / 2 way / Mini-4 way)				4 Way Cassette Type				Wall mounted Type				Circular Cassette Type				
	Display LED																
	1 way	Blue	Yellow-Green	Green	Red	Start/Stop	Defroster	Reser- -vation	Filter -clean	18 °C	21 °C	Reser- -vation	24 °C	27 °C	Sky- -Blue	Yellow- -Green	Blue
2 way	×	×	○	○	×	○	○	○	×	×	○	○	○	×	×	○	×
Criteria	• Refer to the judgment method below.																
Cause of problem	• Faulty Indoor Unit EEV action. (EEV does not open.)																

1. How to diagnose

1) During Cooling operation. (Each of the below conditions have to be met for at least 20 minutes.)

$T_{cond,out} - T_{air,out} > 3^{\circ}C$	OK
$T_{air,in} - T_{eva,in} > 4^{\circ}C$	NO
$T_{air,in} - T_{eva,out} > 4^{\circ}C$	NO
Compressor in operation & Indoor unit operation & Thermo ON	OK
Error details	Indoor Unit EEV closure breakdown

2) During heating operation (must satisfy all conditions below)

- When more than 2 indoor units are on Thermo ON heating operation.
- When average high pressure is over 18kg/cm².
- 5 minutes after finishing Safety Start .
- Keep Indoor Unit $T(Eva_In) < T(Room) + 3^{\circ}C$ and $T(Eva_Out) < T(Room) + 3^{\circ}C$ condition for more than 5 minutes.

2. How to check

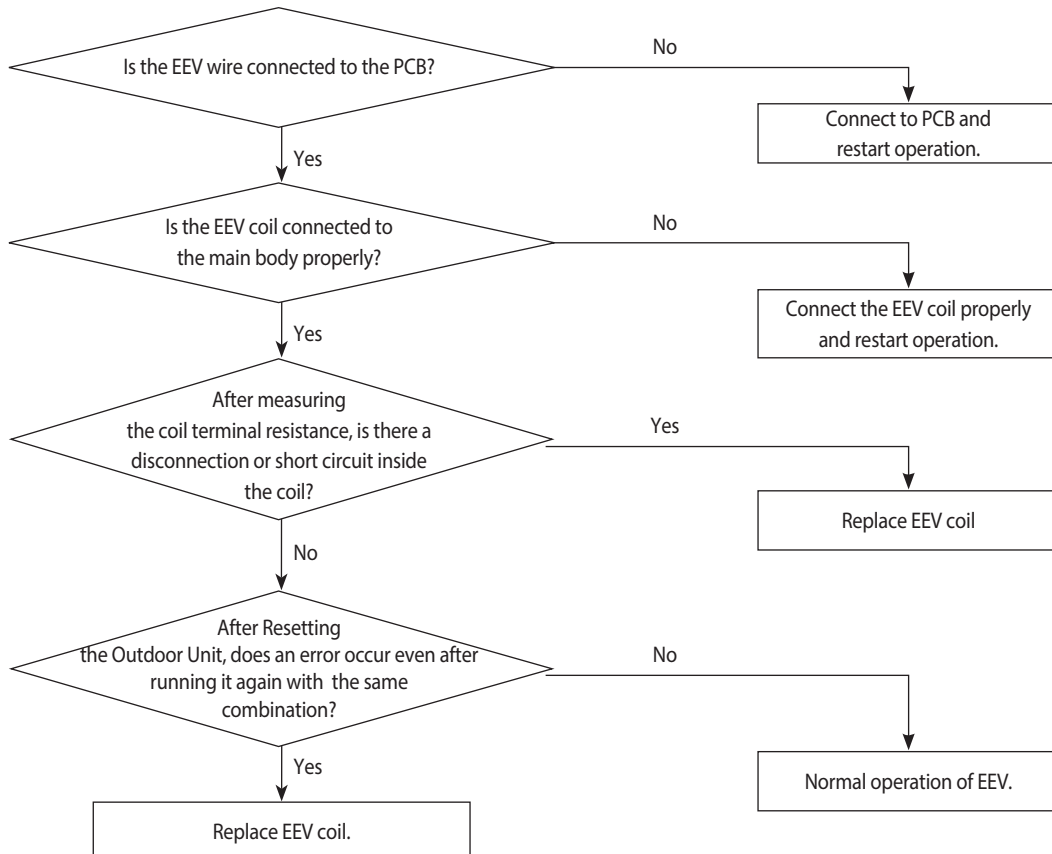

4-4-14 E 153 : Detection of Floating Switch of Indoor Unit's Drain Pump

Outdoor unit display	E 153 ← A x x x(x x x : The address of the error occurred indoor unit)												
Indoor unit display	Duct, Cassette (1 way / 2 way / Mini-4 way)			4 Way Cassette Type				Circular Cassette Type					
	Display LED												
	1 way	Blue	Yellow-Green	or	or	Start /Stop	Defroster	Reser- -vation	Filter -clean	Sky -Blue	Yellow -Green	Blue	Red
	2 way					Green	Red	Start /Stop	Defroster				
×	×	×	●	●	×	×	●	●	×	●	●	×	
Criteria	• Refer to the judgment method below.												
Cause of problem	• Due to the breakdown of a drain pump of the indoor unit, an increase in the water level in the drainage plate or defective detection sensor												

* To release E153 error, you must reset the power of the indoor unit.

1. How to check

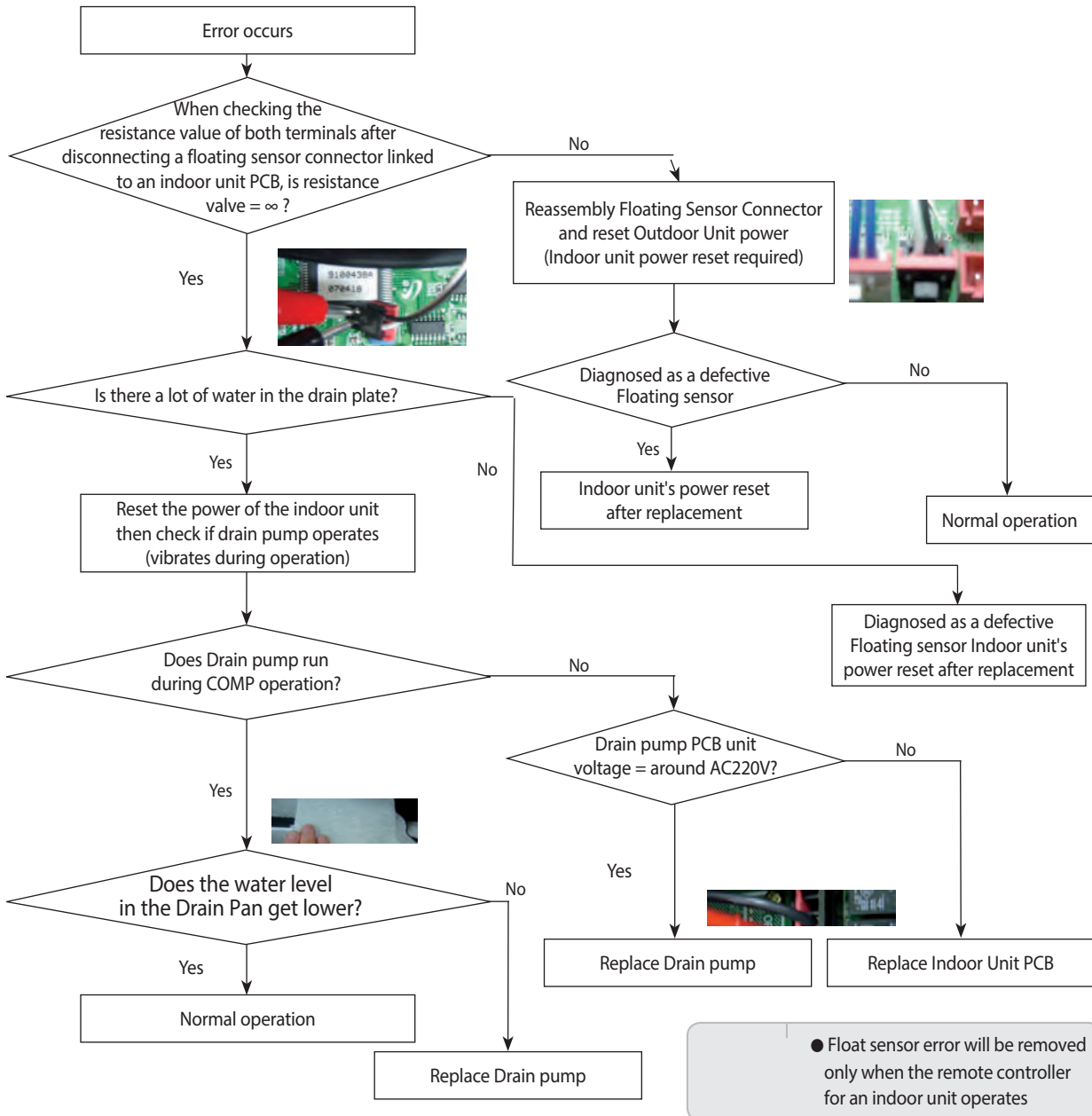

4-4-15 The operational error of Indoor Unit's Fan Motor

Outdoor unit display	E 154 ↔ A x x x(x x x : The address of the error occurred indoor unit)																	
Indoor unit display	Duct, Cassette (1 way / 2 way / Mini-4 way)				4 Way Cassette Type				Wall mounted Type				Circular Cassette Type					
	Display LED																	
	1 way		⌚	⌀ or ⌀	⌚ or ⌚	Start /Stop	Defroster	Reser- vation	Filter -clean	18 °C	21 °C	Reser- vation	24 °C	27 °C	Sky- Blue	Yellow- Green	Blue	Red
	Blue	Yellow- Green																
	2 way		⌚	⌀ or ⌀	⌚ or ⌚	Start /Stop	Defroster	Reser- vation	Filter -clean	18 °C	21 °C	Reser- vation	24 °C	27 °C	Sky- Blue	Yellow- Green	Blue	Red
Green	Red																	
x	x	x	x	⬤	x	x	⬤	x	x	x	x	x	x	x	x	⬤	⬤	
Criteria	• Refer to the judgment method below.																	
Cause of problem	• The operational error of the fan motor of No. XXX indoor unit																	

1. How to diagnose
 - 1) Occurs when RPM valve fails to feedback to MICOM at a PID control-type fan motor

2. How to check
 - 1) Check HALL IC connector that carries out feedback of RPM value.
 - 2) If a fan motor operation capacitor is a PCB separating type, check the connection terminal.
 - 3) Check the operational status of the fan motor.
 - 4) If there is no problem with the above checkup items, replace the PCB.

4-4-16 Mixed operation Error (Only applicable to Heat Pump Model/Not to HR model)

- Mixed operation error is applicable only to Heat Pump Model and not to HR model.
- Mixed operation error is not due to a product problem but is displayed when the operational mode input in an indoor unit is different from current operational status (other indoor unit's operational mode).
- Check the operational mode of outdoor unit or other indoor unit then re-enter or stop the operational mode of the relevant unit.
- If it is necessary to apply a different operational mode to an indoor unit from others, please stop other indoor units then operate the indoor unit.

4-4-17 EEPROM error

Outdoor unit display	E 162																	
Indoor unit display	Duct, Cassette (1 way / 2 way / Mini-4 way)				4 Way Cassette Type				Wall mounted Type				Circular Cassette Type					
	Display LED																	
	1 way	Blue	Yellow-Green	or	or	Start /Stop	Defroster	Reser- -vation	Filter -clean	18 °C	21 °C	Reser- -vation	24 °C	27 °C	Sky -Blue	Yellow -Green	Blue	Red
	2 way	Green	Red	or	or	Start /Stop	Defroster	Reser- -vation	Filter -clean	18 °C	21 °C	Reser- -vation	24 °C	27 °C	Sky -Blue	Yellow -Green	Blue	Red
Criteria	• Communication failure between EEPROM and MICOM																	
Cause of problem	• PCB replacement due to defective EEPROM																	

1. How to check

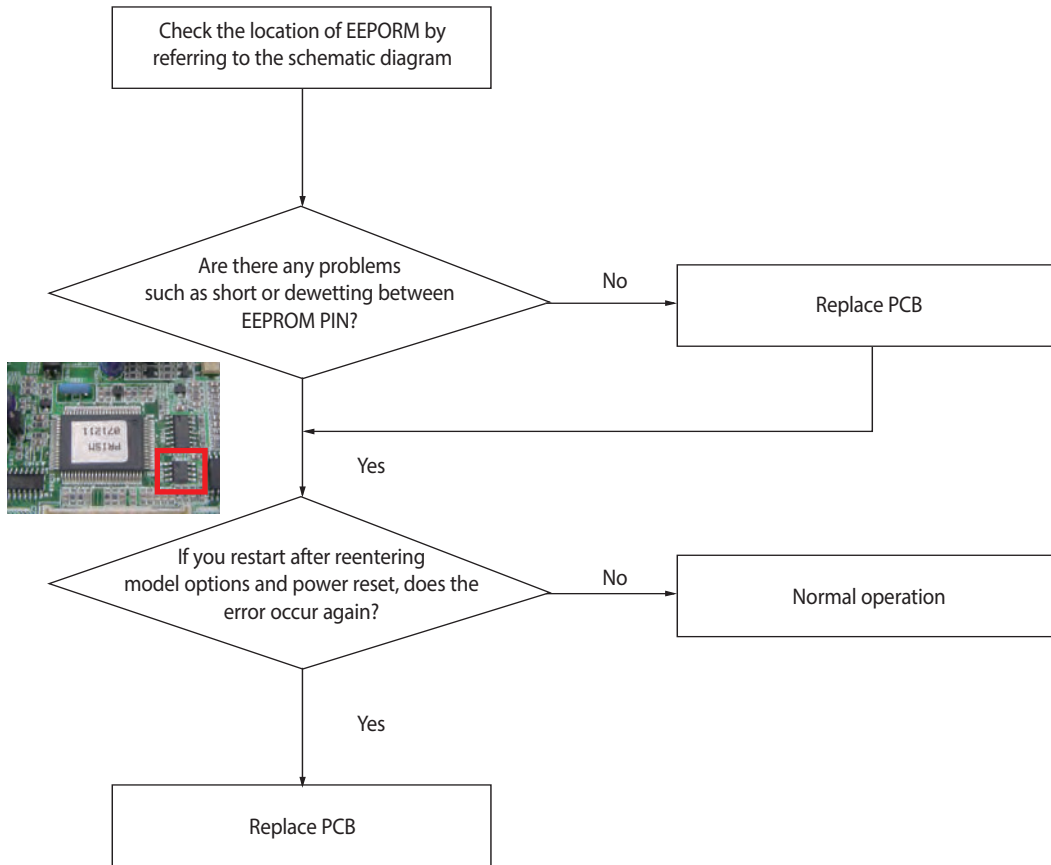

4-4-18 Option error of the Remote Controller for an Indoor Unit

Outdoor unit display	E 163																	
Indoor unit display	Duct, Cassette (1 way / 2 way / Mini-4 way)				4 Way Cassette Type				Wall mounted Type				Circular Cassette Type					
	Display LED																	
	1 way		⌚	🌀 or 🌀	📱 or 📱	Start /Stop	Defroster	Reser- -vation	Filter -clean	18 °C	21 °C	Reser- -vation	24 °C	27 °C	Sky- -Blue	Yellow- -Green	Blue	Red
	Blue	Yellow- -Green																
	2 way		⌚	🌀 or 🌀	📱 or 📱	Start /Stop	Defroster	Reser- -vation	Filter -clean	18 °C	21 °C	Reser- -vation	24 °C	27 °C	Sky- -Blue	Yellow- -Green	Blue	Red
Green	Red																	
●	●	●	●	●	●	●	●	●	●	●	●	●	●	●	●	×	●	
Criteria	• Display number type of indoor unit – E163 occurs, Lamp type – all lamps flash																	
Cause of problem	• Missed or erroneous input of remote controller options																	

- Check relevant remote controller options for each model then enter correct options

4-4-19 Error due to confused use of Fahrenheit and Celsius

Outdoor unit display	E 170					
Indoor unit display	×(Operation) ●(Timer) ●(Fan) ●(Filter) ×(Defrost)					
Criteria	• Display number type of indoor unit – E170 occurs, Lamp type – all lamps flash • Occurs in an indoor unit with Celsius setting					
Cause of problem	• Missed input of remote controller options					

- Check relevant remote controller options for each model then enter correct options
- As this happens only in a Celsius setting model, it is necessary to reenter option codes for error-free models in a region where Celsius is used.

4-4-20 Simultaneous opening of Cooling/heating MCU SOL Valves 1st/2nd

- During the first detection, as the system restarts after making an automatic stop to check a problem with the system
- During the second detection, please refer to the following check-up methods.

1. How to check

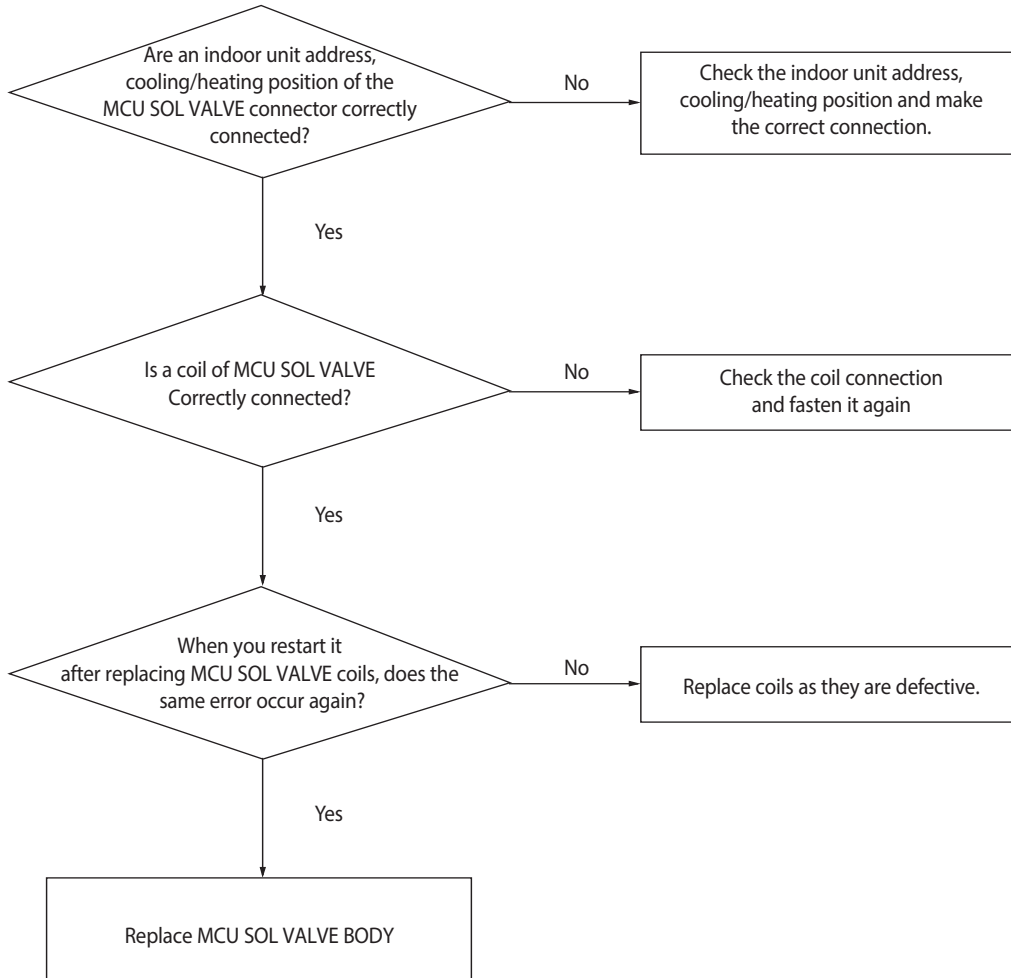

4-4-21 Error due to incorrect Indoor Unit Power/Communication Cable Connection

Outdoor unit display	<i>E 185</i>				
Indoor unit display	Wall mount				
	LED Displays				
	18 °C	21 °C	Reservation	24 °C	27 °C
	x	x	●	●	x
Criteria	• Check for Power input(220V) for the Terminal block(F1/F2).				
Cause of problem	• Apply power (220V) to the terminal of the indoor unit communication block (F1/F2)				

- Check for disconnected line after turning off the Main power.

4-4-22 SPI Feedback Error

Outdoor unit display	<i>E 186</i>
Indoor unit display	●(Operation) ●(Timer) ×(Fan) ●(Filter) ×(Defrost)
Criteria	• Check if the output of SPI Feedback is 12V
Cause of problem	• SPI defect

1. How to check

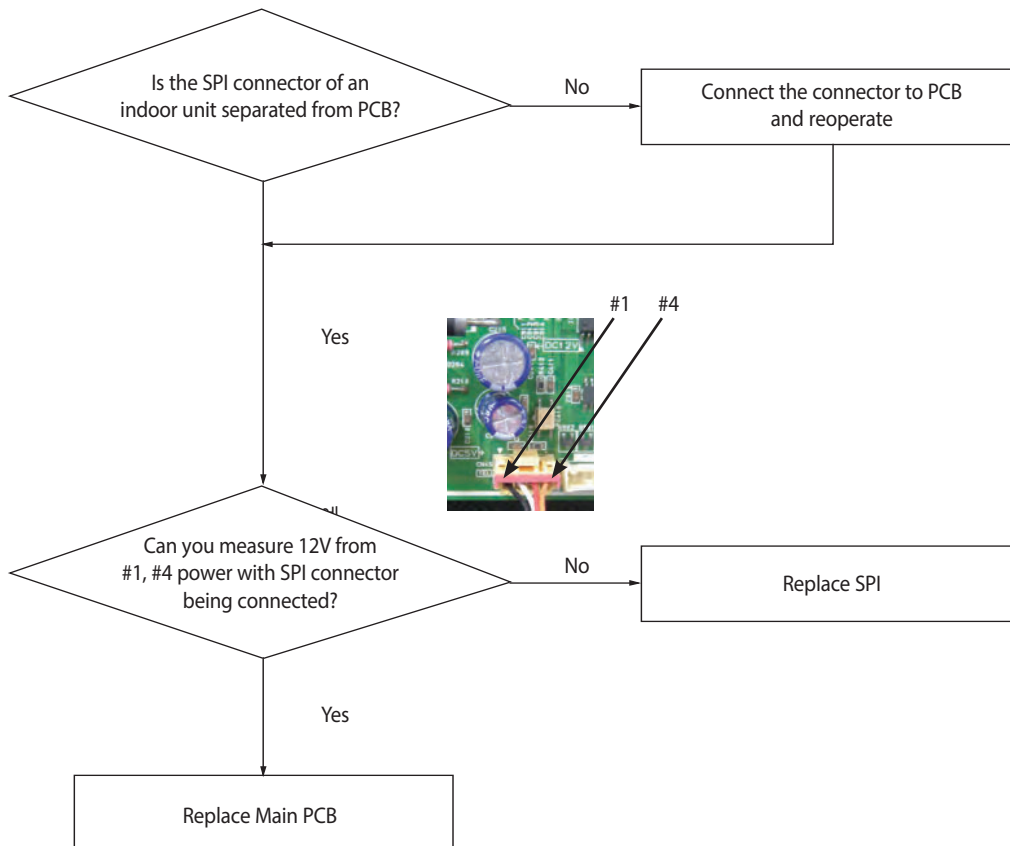

4-4-23 Outdoor Unit Pipe Inspection Error

Outdoor unit display	<i>E 190</i> : No change of EVA IN or wrong EVAN IN change during pipe inspection. <i>E 191</i> : No change of EVA OUT or wrong EVA OUT change during pipe inspection.
Indoor unit display	-
Criteria	• Refer to the judgment method below
Cause of problem	• The liquid pipe/gas pipe of the indoor unit is not correctly connected to the port set in MCU.

1. Judgment Method

- Check if the indoor address settings are the same for the address of the indoor units connected to each port of the MCU and the address of the indoor units of the relevant MCU ports.
- Check if the indoor unit usage setup switch is turned on for the MCU port connected to the indoor unit.

4-4-24 Communication Error between Indoor and Outdoor Units during Tracking

Outdoor unit display	E201																	
Indoor unit display	Duct, Cassette (1 way / 2 way / Mini-4 way)				4 Way Cassette Type				Wall mounted Type				Circular Cassette Type					
	Display LED																	
	1 way		or	or	or	Start /Stop	Defroster	Reser- -vation	Filter -clean	18 °C	21 °C	Reser- -vation	24 °C	27 °C	Sky- -Blue	Yellow- -Green	Blue	Red
	Blue	Yellow- -Green																
2 way		or	or	or	Start /Stop	Defroster	Reser- -vation	Filter -clean	18 °C	21 °C	Reser- -vation	24 °C	27 °C	Sky- -Blue	Yellow- -Green	Blue	Red	
Green	Red																	
Criteria	· Communication error between indoor and outdoor units.																	
Cause of problem	· Refer to the judgment method below.																	

1. Cause of problem

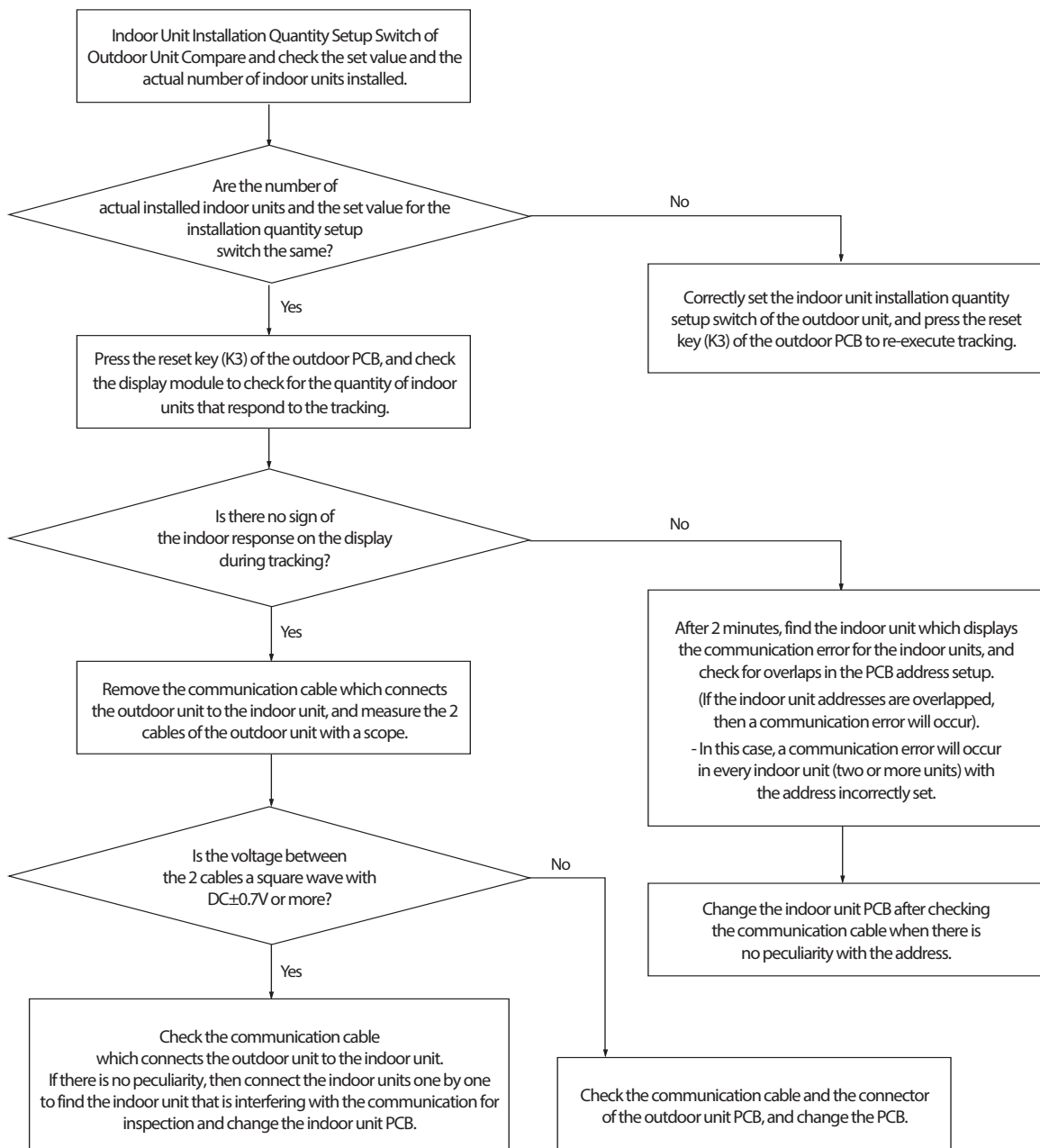

4-4-25 Communication Error between Indoor and Outdoor Units after Tracking

Outdoor unit display	E202																	
Indoor unit display	Duct, Cassette (1 way / 2 way / Mini-4 way)			4 Way Cassette Type				Wall mounted Type				Circular Cassette Type						
	Display LED																	
	1 way	Blue	Yellow-Green	or	or	Start /Stop	Defroster	Reser- -vation	Filter -clean	18 °C	21 °C	Reser- -vation	24 °C	27 °C	Sky -Blue	Yellow -Green	Blue	Red
	2 way	Green	Red															
Criteria	· Outdoor unit is unable to communicate for two minutes during operation. (no reception of relocation)																	
Cause of problem	· Communication error between indoor and outdoor units and setup error of indoor unit installation quantity setup switch.																	

1. Cause of problem

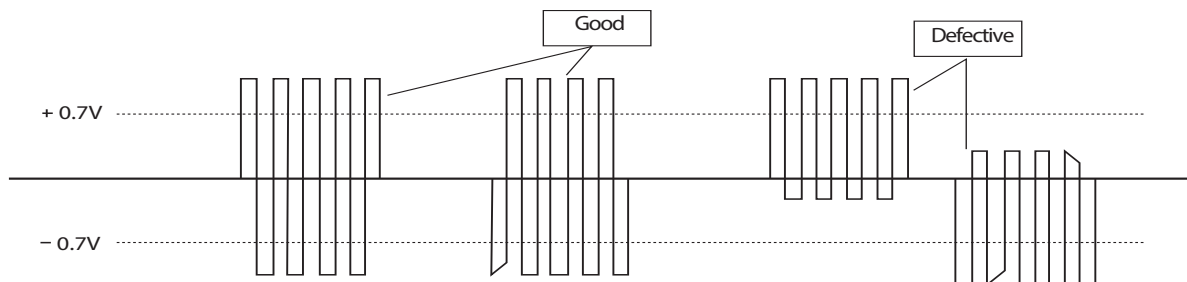
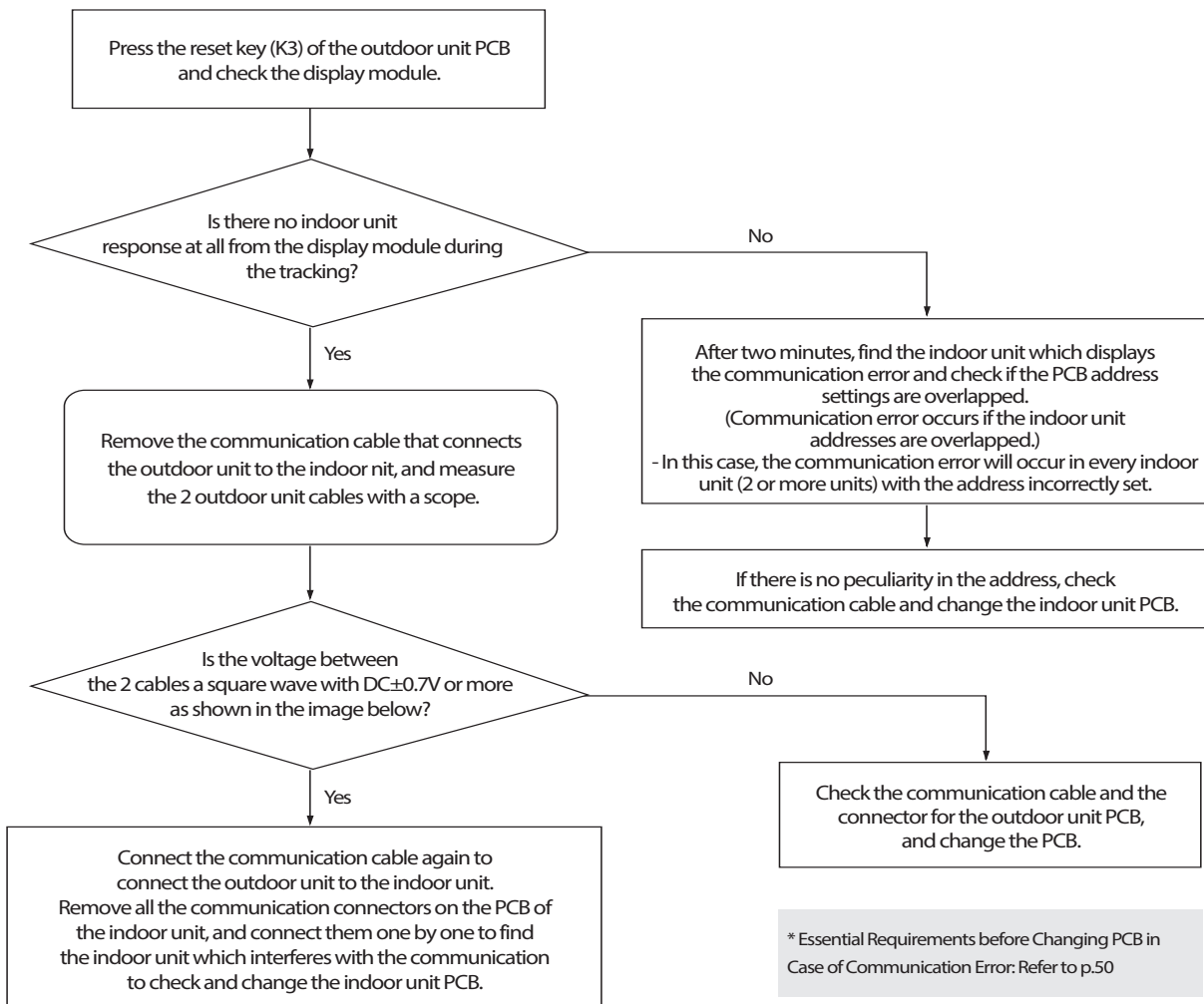

4-4-26 Communication error between main and sub Unit of outdoor unit or between outdoor units

Outdoor unit display	E203																	
Indoor unit display	Duct, Cassette (1 way / 2 way / Mini-4 way)				4 Way Cassette Type				Wall mounted Type				Circular Cassette Type					
	Display LED																	
	1 way Blue Yellow-Green		or ⌚	or ⌚		Start /Stop	Defroster	Reser- -vation	Filter -clean	18 °C	21 °C	Reser- -vation	24 °C	27 °C	Sky- -Blue	Yellow- -Green	Blue	Red
	2 way Green Red			⌚	⌚	⌚	⌚	⌚	⌚	⌚	⌚	⌚	⌚	⌚	⌚	⌚	⌚	⌚
×	×	○	○	×	×	○	○	×	×	×	○	○	×	×	○	×	×	

Criteria · Refer to the judgment method below.

Cause of problem · Communication error between outdoor units.

1. Cause of problem

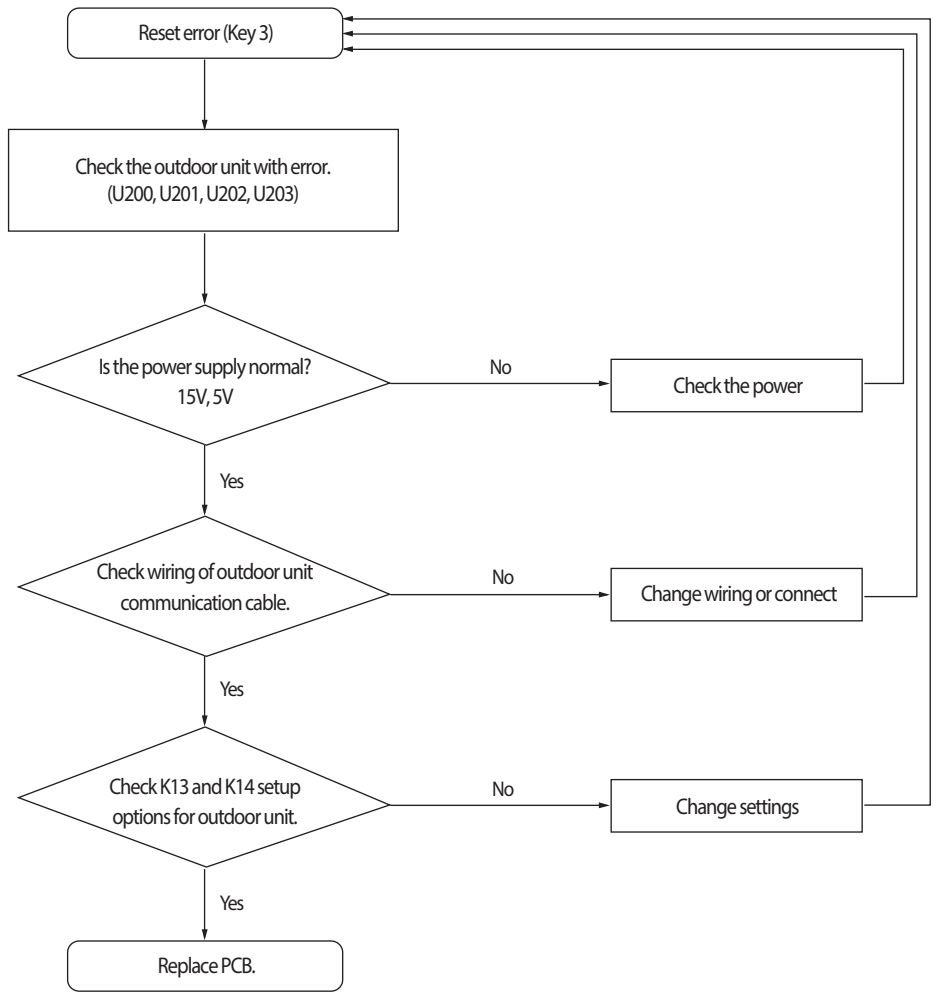

Essential Requirements before Changing PCB in Case of Communication Error: Refer to p.59

4-4-27 Communication Error between MCU and Outdoor Unit

Outdoor unit display	E204
Indoor unit display	
Criteria	• Communication Error between MCU and outdoor unit
Cause of problem	• Reference below

1. Inspection Method

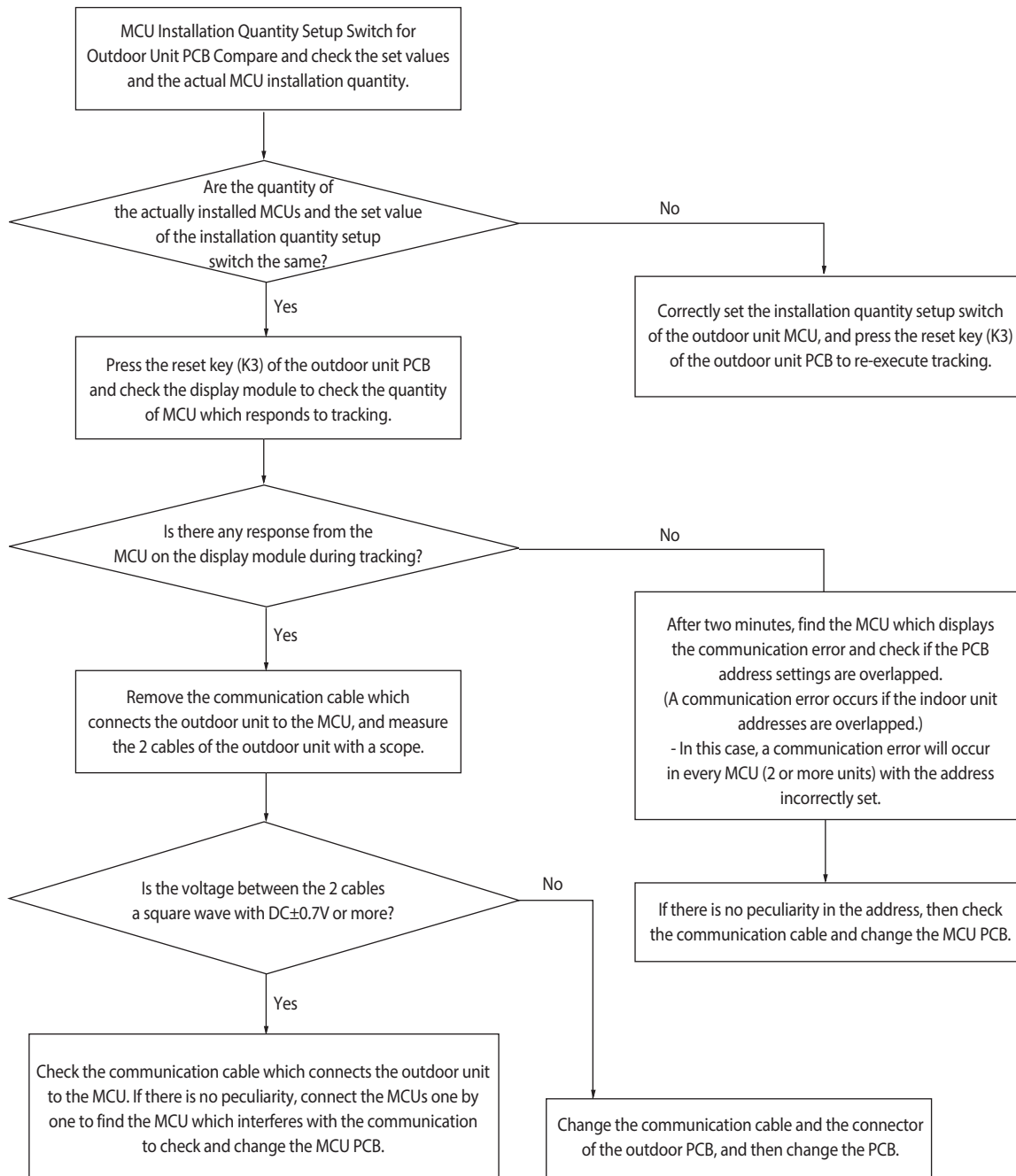

* Essential Requirements before Changing PCB in Case of Communication Error: Refer to p.4-80

4-4-28 Internal Communication error of the Outdoor Unit C-Box

Outdoor unit display	E205																		
Indoor unit display	Duct, Cassette (1 way / 2 way / Mini-4 way)				4 Way Cassette Type				Wall mounted Type				Circular Cassette Type						
	Display LED																		
	1 way	Blue	Yellow-Green	2 way	Green	Red	Start /Stop	Defroster	Reser- -vation	Filter -clean	18 °C	21 °C	Reser- -vation	24 °C	27 °C	Sky -Blue	Yellow -Green	Blue	Red
	×	×	●	●	×	×	●	●	×	×	×	×	●	●	×	×	●	×	×
Criteria	· Communication error between the C-Box PCB																		
Cause of problem	· Communication wire inside the C-Box is unconnected · Main PCB defective																		

1. Cause of problem

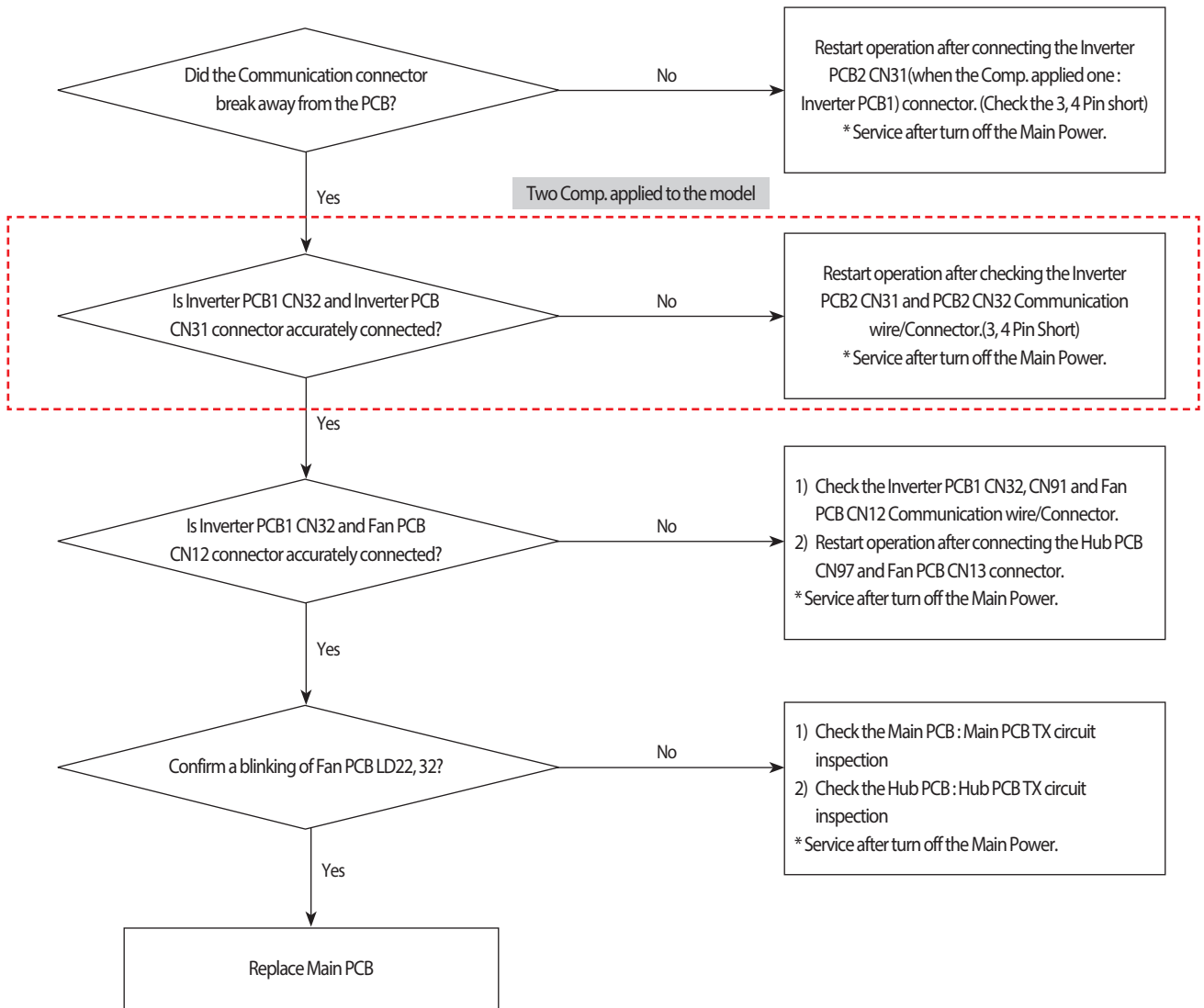

4-4-29 Internal PCB Communication error of the Outdoor Unit C-Box

Outdoor unit display	E206																	
Indoor unit display	Duct, Cassette (1 way / 2 way / Mini-4 way)				4 Way Cassette Type				Wall mounted Type				Circular Cassette Type					
	Display LED																	
	1 way		or	or	or	Start /Stop	Defroster	Reser- -vation	Filter -clean	18 °C	21 °C	Reser- -vation	24 °C	27 °C	Sky -Blue	Yellow -Green	Blue	Red
	Blue	Yellow- Green																
2 way		or	or	or	Start /Stop	Defroster	Reser- -vation	Filter -clean	18 °C	21 °C	Reser- -vation	24 °C	27 °C	Sky -Blue	Yellow -Green	Blue	Red	
Green	Red																	
Criteria	· PCB does not respond to the invoked Main PCB																	
Cause of problem	· C-Box internal Inverter PCB, Fan PCB, Hub PCB defective																	

1. Cause of problem

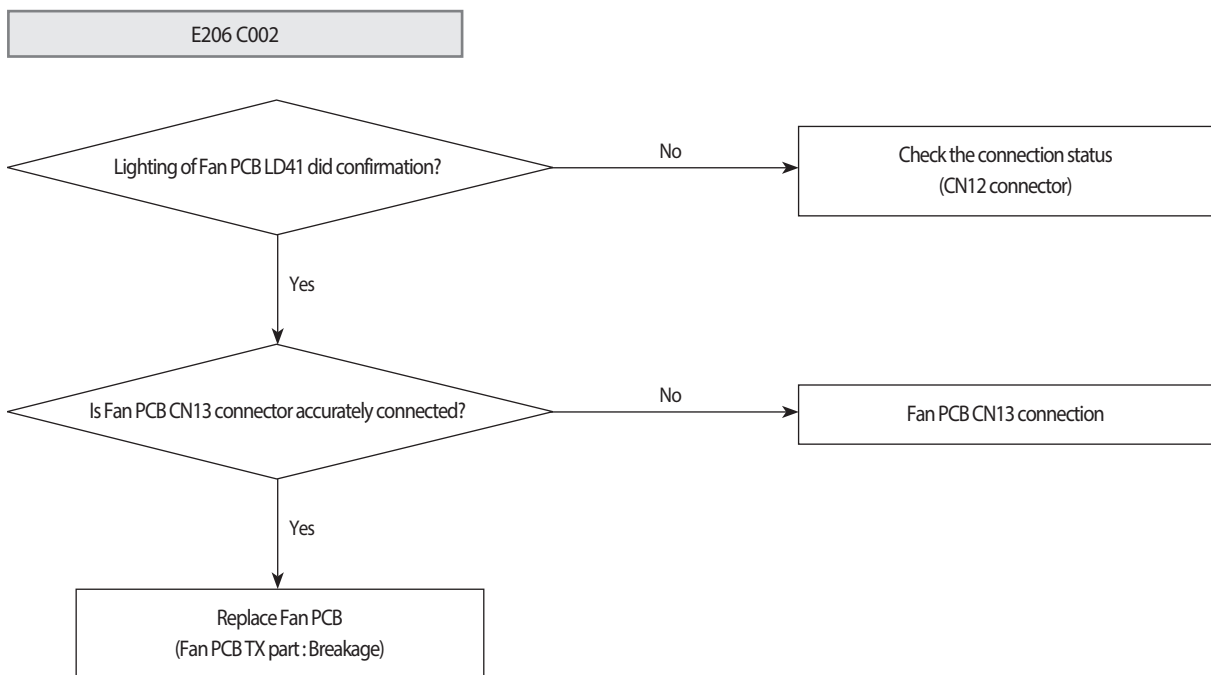
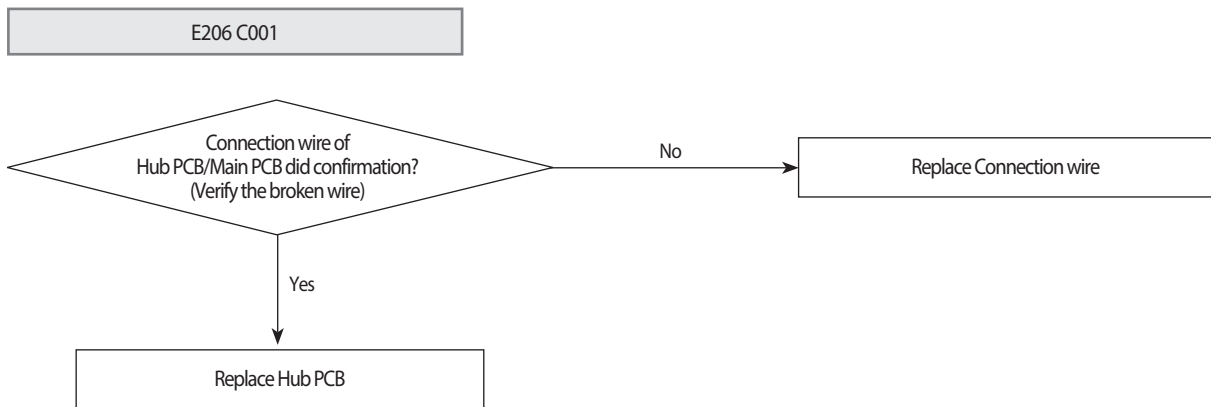

4-4-30 Communication Error between MCU and Outdoor Unit after Tracking is Completed

Outdoor unit display	E2 10
Indoor unit display	
Criteria	• Outdoor unit is unable to communicate for two or more minutes during operation (no reception of relocation)
Cause of problem	• Communication error between indoor and outdoor units and setup error of indoor unit installation quantity setup switch

1. Inspection Method

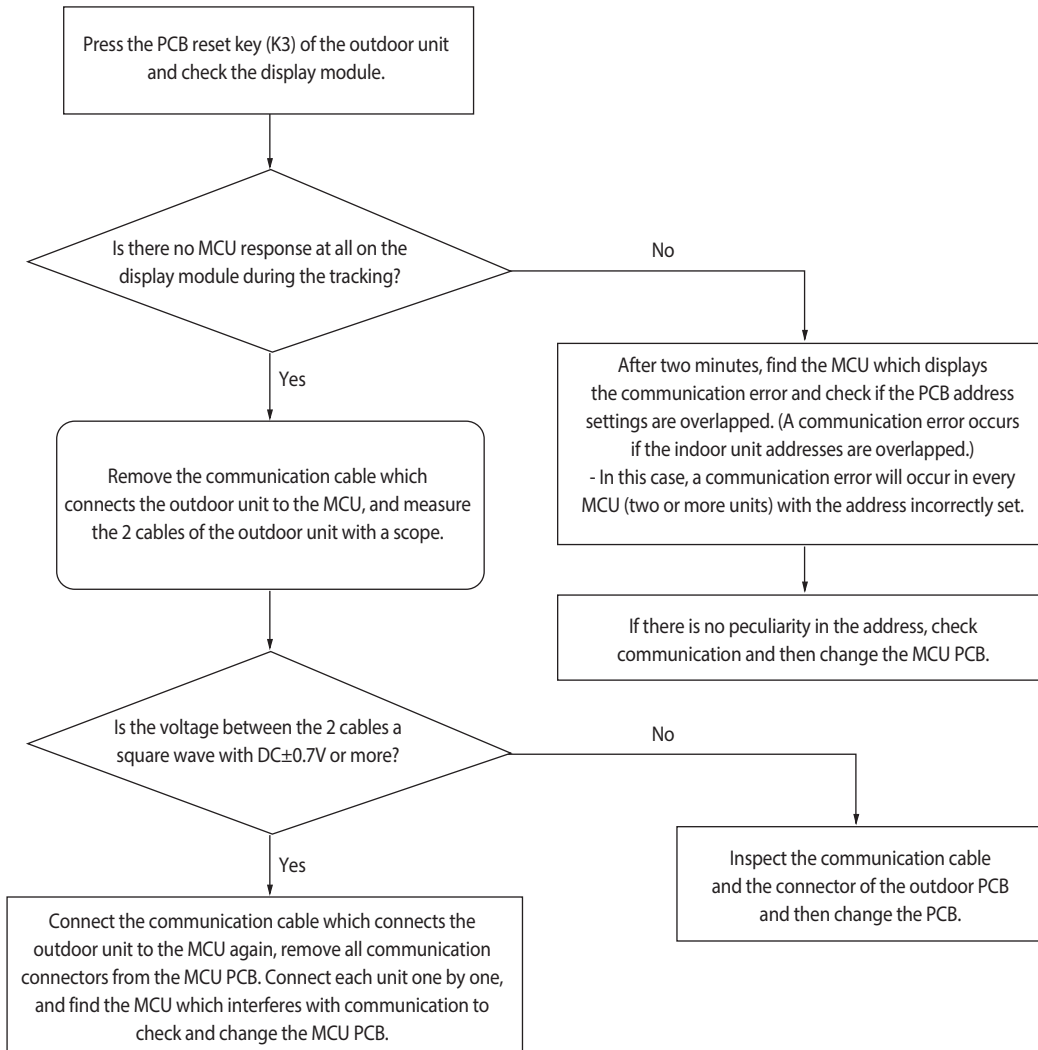

※ Essential Requirements before Changing PCB in Case of Communication Error: Refer to p.4-80

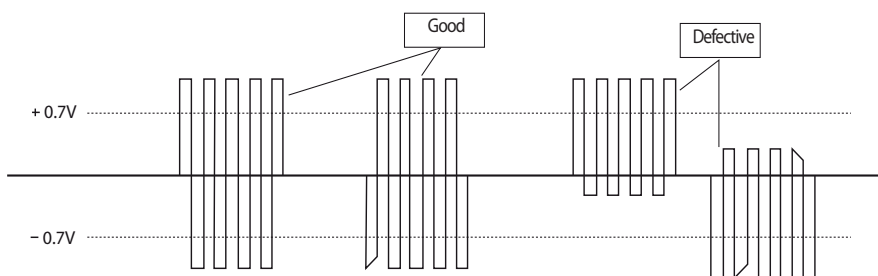

4-4-31 MCU branch part setup error – inconsecutive connection with the use of 2 branch parts

Outdoor unit display	E211																	
Indoor unit display	Duct, Cassette (1 way / 2 way / Mini-4 way)				4 Way Cassette Type				Wall mounted Type				Circular Cassette Type					
	Display LED																	
	1 way	Blue	Yellow-Green	or	or	Start /Stop	Defroster	Reser- -vation	Filter -clean	18 °C	21 °C	Reser- -vation	24 °C	27 °C	Sky- -Blue	Yellow- -Green	Blue	Red
	2 way	Green	Red															
	X	X	●	●	X	X	●	●	X	X	●	●	X	X	●	X	X	
Criteria	• When 2 branch parts are used for one indoor unit without connecting them consecutively.																	
Cause of problem	• Branch part assembly error																	

1. How to check

Find an MCU that is composed as the following picture to carry out assembly of branch part again. After completing the re-setting, press K3 button on the button to reset or turn it off to restart.

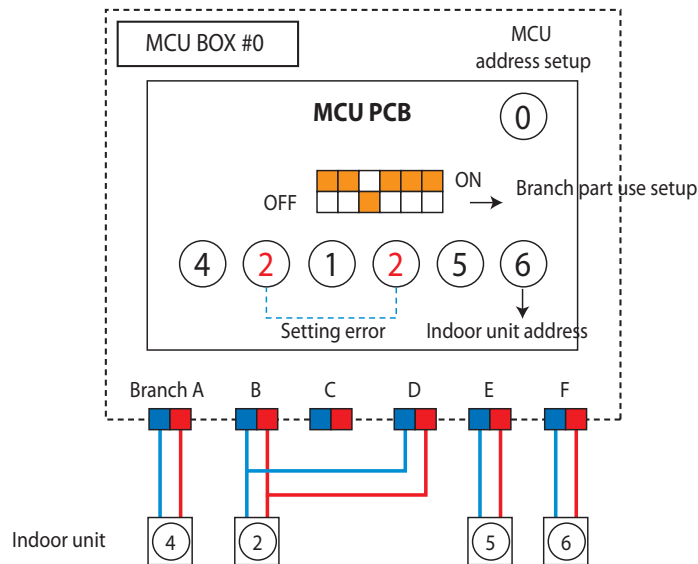

4-4-32 MCU branch part setup error – Repeated setup for the same address over 3 times

Outdoor unit display	E2 12																	
Indoor unit display	Duct, Cassette (1 way / 2 way / Mini-4 way)				4 Way Cassette Type				Wall mounted Type				Circular Cassette Type					
	Display LED																	
	1 way	Blue	Yellow-Green	or	or	Start /Stop	Defroster	Reser- -vation	Filter -clean	18 °C	21 °C	Reser- -vation	24 °C	27 °C	Sky- -Blue	Yellow- -Green	Blue	Red
	2 way																	
	X	X	●	●	X	X	●	●	X	X	●	●	X	X	●	X	X	
Criteria	• The same indoor unit address was setup more than 3 times in MCU.																	
Cause of problem	• MCU indoor unit address setting error.																	

1. How to check

Find an MCU that is composed as the following picture to carry out assembly of branch part again. After completing the re-setting, press K3 button on the button to reset or turn it off to restart.

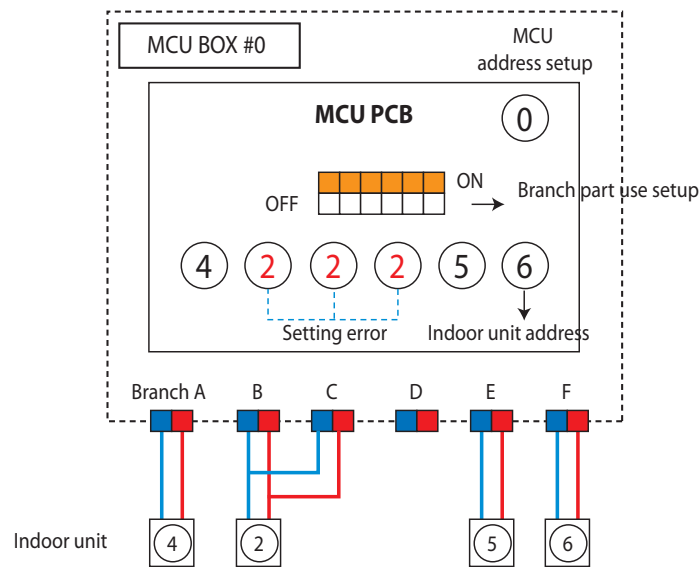

4-4-33 MCU branch part setup error – non-installed address setup

Outdoor unit display	E2 13																				
Indoor unit display	Duct, Cassette (1 way / 2 way / Mini-4 way)				4 Way Cassette Type				Wall mounted Type				Circular Cassette Type								
	Display LED																				
	1 way	Blue	Yellow-Green	2 way	Green	Red	or	or	Start /Stop	Defroster	Reser- -vation	Filter -clean	18 °C	21 °C	Reser- -vation	24 °C	27 °C	Sky- -Blue	Yellow- -Green	Blue	Red
	X	X	X	X	X	X	X	X	X	X	X	X	X	X	X	X	X	X	X	X	X
Criteria	• If there is an indoor unit that is not installed among MCU registered indoor units																				
Cause of problem	• Indoor unit, with the assigned address on MCU, not installed.																				

1. How to check

Find an MCU that is composed as the following picture to carry out assembly of branch part again. After completing the re-setting, press K3 button on the button to reset or turn it off to restart.

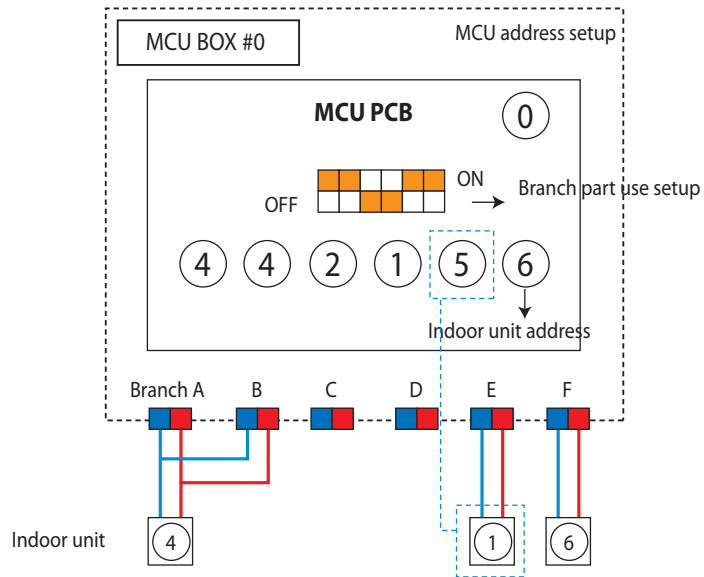

4-4-34 Setup Error for MCU Branch part – Setup Error for MCU Quantity Used

Outdoor unit display	E2 14																		
Indoor unit display	Duct, Cassette (1 way / 2 way / Mini-4 way)				4 Way Cassette Type				Wall mounted Type				Circular Cassette Type						
	Display LED																		
	1 way	Blue	Yellow-Green	2 way	Green	Red	Start /Stop	Defroster	Reser- -vation	Filter -clean	18 °C	21 °C	Reser- -vation	24 °C	27 °C	Sky- -Blue	Yellow- -Green	Blue	Red
	X	X	●	●	X	X	●	●	X	X	X	X	●	●	X	X	●	X	X
Criteria	<ul style="list-style-type: none"> Occurs when the quantity of MCU is incorrectly set by the outdoor unit. Occurs when same addresses are found when two or more MCU are connected. 																		
Cause of problem	<ul style="list-style-type: none"> Outdoor unit MCU setup and same address errors when connecting two or more MCUs . 																		

- Inspection Method : Re-check the MCU quantity setup switch from the outdoor unit.
 Check for overlaps in each MCU address setup switch.
 To use, reset by pressing the K3 button of the outdoor unit after the reset is completed, or reset after turning off the power and then turn it on again.

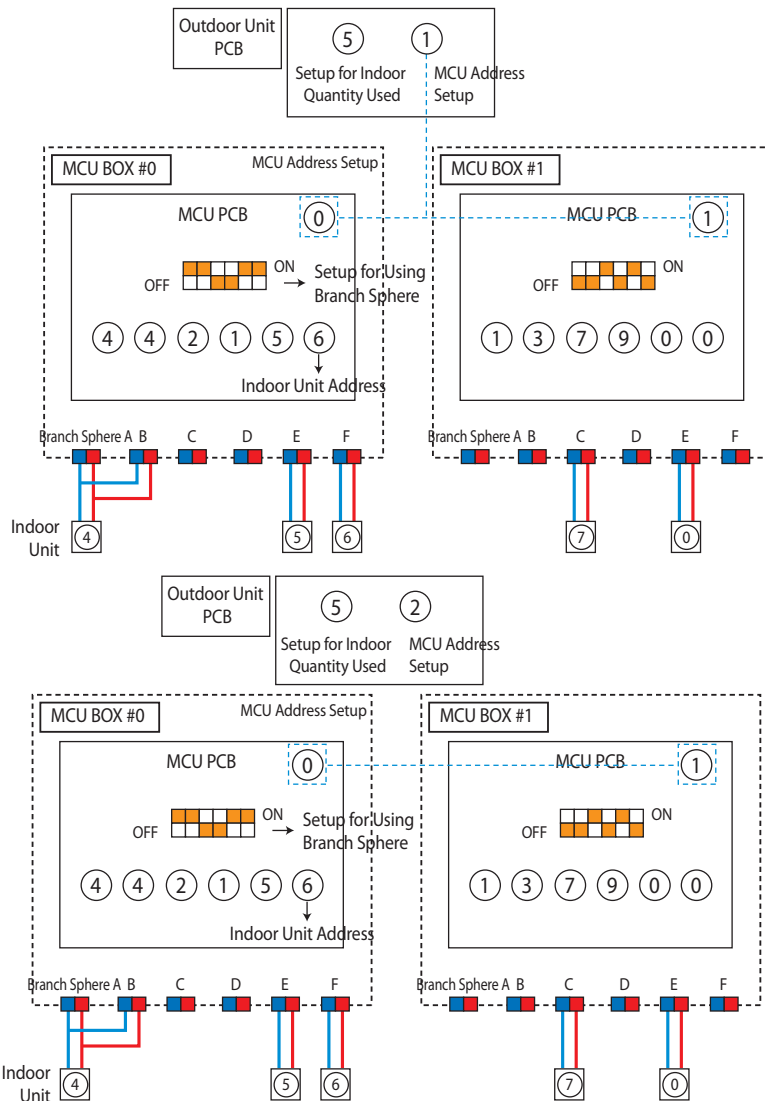

4-4-35 MCU branch part setup error – Overlapping Indoor unit Address setup

Outdoor unit display	E2 15																		
Indoor unit display	Duct, Cassette (1 way / 2 way / Mini-4 way)				4 Way Cassette Type				Wall mounted Type				Circular Cassette Type						
	Display LED																		
	1 way	Blue	Yellow-Green	2 way	Green	Red	Start /Stop	Defroster	Reser- -vation	Filter -clean	18 °C	21 °C	Reser- -vation	24 °C	27 °C	Sky- -Blue	Yellow- -Green	Blue	Red
	×	×	○	×	×	×	○	○	×	×	×	×	○	○	×	×	○	×	×
Criteria	• Occurs when an indoor unit address setup switch in MCU has been overlapped																		
Cause of problem	• Repeated indoor unit address																		

1. How to check

Check the setup switch for the number of indoor units in MCU

After completing resetting, press the outdoor unit's K3 button to reset or turn off to restart.

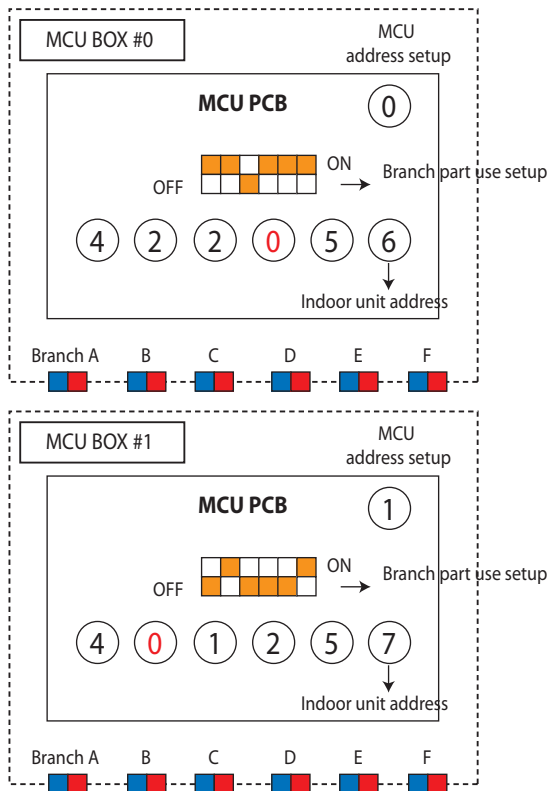

4-4-36 MCU branch part setup error – Set as being used without connection to an Indoor unit

Outdoor unit display	E2 16																		
Indoor unit display	Duct, Cassette (1 way / 2 way / Mini-4 way)				4 Way Cassette Type				Wall mounted Type				Circular Cassette Type						
	Display LED																		
	1 way	Blue	Yellow-Green	2 way	Green	Red	Start/Stop	Defroster	Reser-vation	Filter-clean	18 °C	21 °C	Reser-vation	24 °C	27 °C	Sky-Blue	Yellow-Green	Blue	Red
	○	○	○	○	○	○	○	○	○	○	○	○	○	○	○	○	○	○	○
×	×	○	○	×	×	○	○	×	×	×	×	○	○	×	×	○	×	×	×
Criteria	• Occurs when MCU PIPE is set as being used, yet not connected to an indoor unit																		
Cause of problem	• Pipe is not installed to the indoor unit with assigned address on MCU																		

1. How to check

Adjust the Dip switch that sets up the use of MCU branch part to 'Not-Used'. After completing resetting, press the outdoor unit's K3 button to reset or turn off to restart.

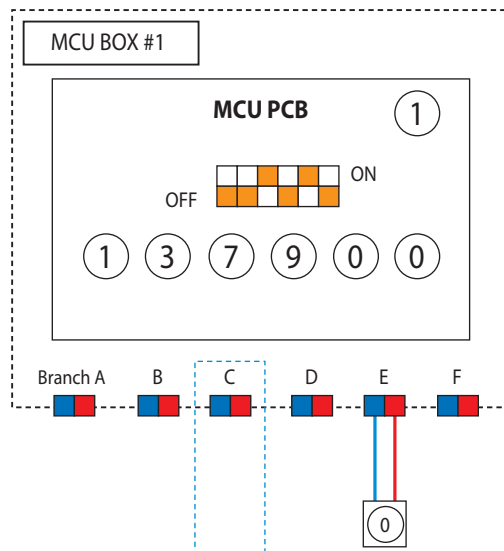

4-4-37 MCU branch part setup error – Connect an Indoor unit to a branch part not being used

Outdoor unit display	E2 17																
Indoor unit display	Duct, Cassette (1 way / 2 way / Mini-4 way)				4 Way Cassette Type				Wall mounted Type				Circular Cassette Type				
	Display LED																
	1 way		or	or	Start /Stop	Defroster	Reser- -vation	Filter -clean	18 °C	21 °C	Reser- -vation	24 °C	27 °C	Sky -Blue	Yellow -Green	Blue	Red
	Blue	Yellow- Green			Power	Water	Timer	Grid	18 °C	21 °C	Reser- -vation	24 °C	27 °C	Sky -Blue	Yellow -Green	Blue	Red
2 way		or	or	Start /Stop	Defroster	Reser- -vation	Filter -clean	18 °C	21 °C	Reser- -vation	24 °C	27 °C	Sky -Blue	Yellow -Green	Blue	Red	
Green	Red			Power	Water	Timer	Grid	18 °C	21 °C	Reser- -vation	24 °C	27 °C	Sky -Blue	Yellow -Green	Blue	Red	
Criteria	• Occurs when MCU PIPE is set as being used, yet not connected to an indoor unit																
Cause of problem	• Pipe is not installed to the indoor unit with assigned address on MCU																

1. How to check

Check the actual use of the branch part. If it is used, turn on the Dip switch for branch part setup. After completing resetting, press the outdoor unit's K3 button to reset or turn off to restart.

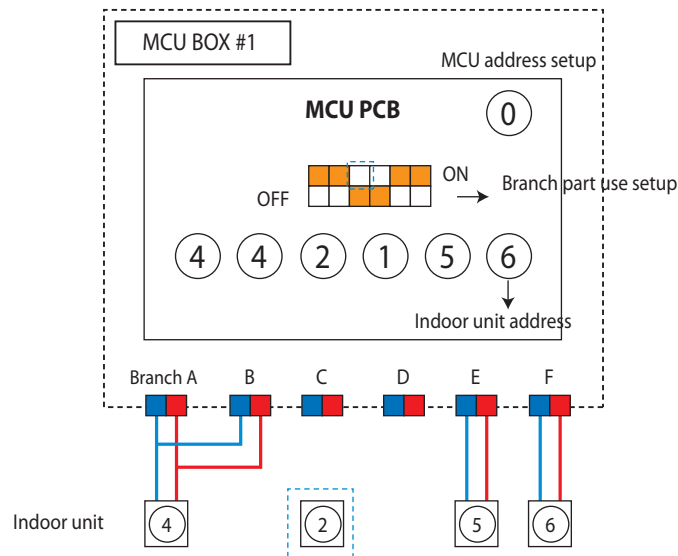

4-4-38 MCU branch part setup error – Connect more Indoor units than what is actually set up in MCU

Outdoor unit display	E2 18																				
Indoor unit display	Duct, Cassette (1 way / 2 way / Mini-4 way)				4 Way Cassette Type				Wall mounted Type				Circular Cassette Type								
	Display LED																				
	1 way	Blue	Yellow-Green	2 way	Green	Red	or	or	Start /Stop	Defroster	Reser- -vation	Filter -clean	18 °C	21 °C	Reser- -vation	24 °C	27 °C	Sky- -Blue	Yellow- -Green	Blue	Red
	×	×	○	○	×	×	○	○	×	×	○	○	×	×	○	○	×	×	○	×	×
Criteria	• Occurs when the number of indoor units installed exceeds that registered in MCU																				
Cause of problem	• Number of indoor units exceeds number of indoor units entered on MCU setting.																				

1. How to check

Check the number of indoor units connected to MCU then readjust the switch for the number of units
After completing resetting, press the outdoor unit's K3 button to reset or turn off to restart.

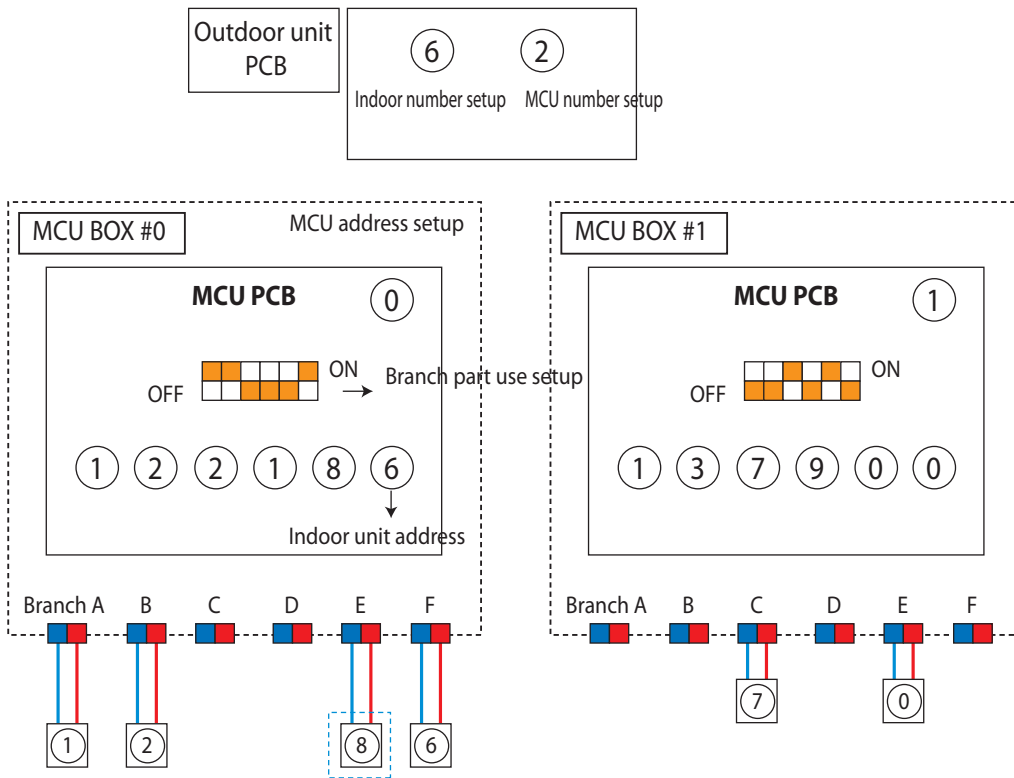

4-4-39 Outdoor Temperature Sensor Error

Outdoor unit display	E221																	
Indoor unit display	Duct, Cassette (1 way / 2 way / Mini-4 way)				4 Way Cassette Type				Wall mounted Type				Circular Cassette Type					
	Display LED																	
	1 way	Blue	Yellow-Green	or	or	Start /Stop	Defroster	Reser- -vation	Filter -clean	18 °C	21 °C	Reser- -vation	24 °C	27 °C	Sky -Blue	Yellow -Green	Blue	Red
	2 way	Green	Red	or	or	Start /Stop	Defroster	Reser- -vation	Filter -clean	18 °C	21 °C	Reser- -vation	24 °C	27 °C	Sky -Blue	Yellow -Green	Blue	Red
Criteria	· Refer to the judgment method below.																	
Cause of problem	· Outdoor temperature sensor Open/Short is defective.																	

1. Cause of problem

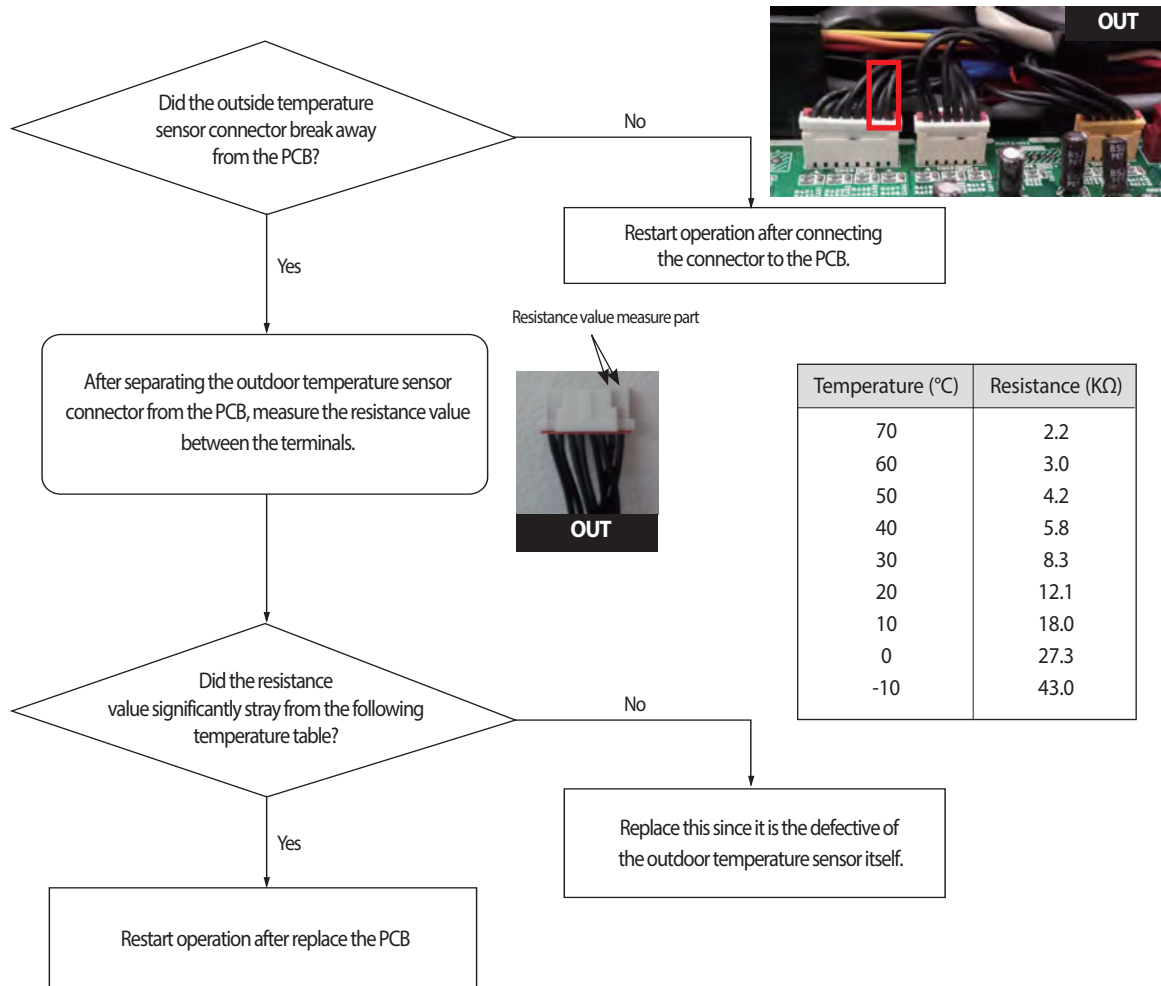

4-4-40 Outdoor Temperature dislocation error

1. How to check

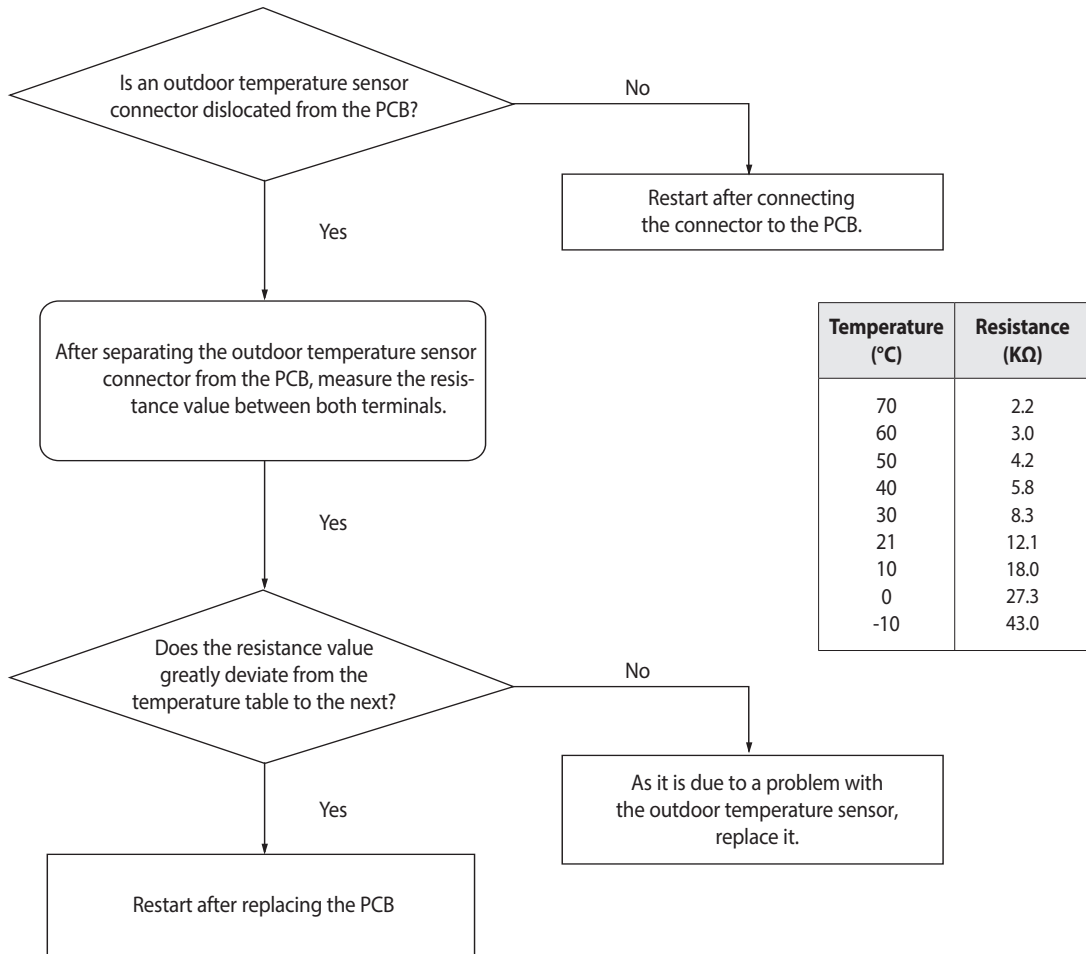

4-4-41 Cond Out Temperature Sensor Error (Open/Short)

Outdoor unit display	E231																
Indoor unit display	Duct, Cassette (1 way / 2 way / Mini-4 way)				4 Way Cassette Type				Wall mounted Type				Circular Cassette Type				
	Display LED																
	1 way		or	or	Start /Stop	Defroster	Reser- -vation	Filter -clean	18 °C	21 °C	Reser- -vation	24 °C	27 °C	Sky -Blue	Yellow- -Green	Blue	Red
	Blue	Yellow- -Green															
2 way		or	or	Start /Stop	Defroster	Reser- -vation	Filter -clean	18 °C	21 °C	Reser- -vation	24 °C	27 °C	Sky -Blue	Yellow- -Green	Blue	Red	
Green	Red																
Criteria	· Refer to the judgment method below.																
Cause of problem	· Disconnection or breakdown of relevant sensor.																

1. Cause of problem

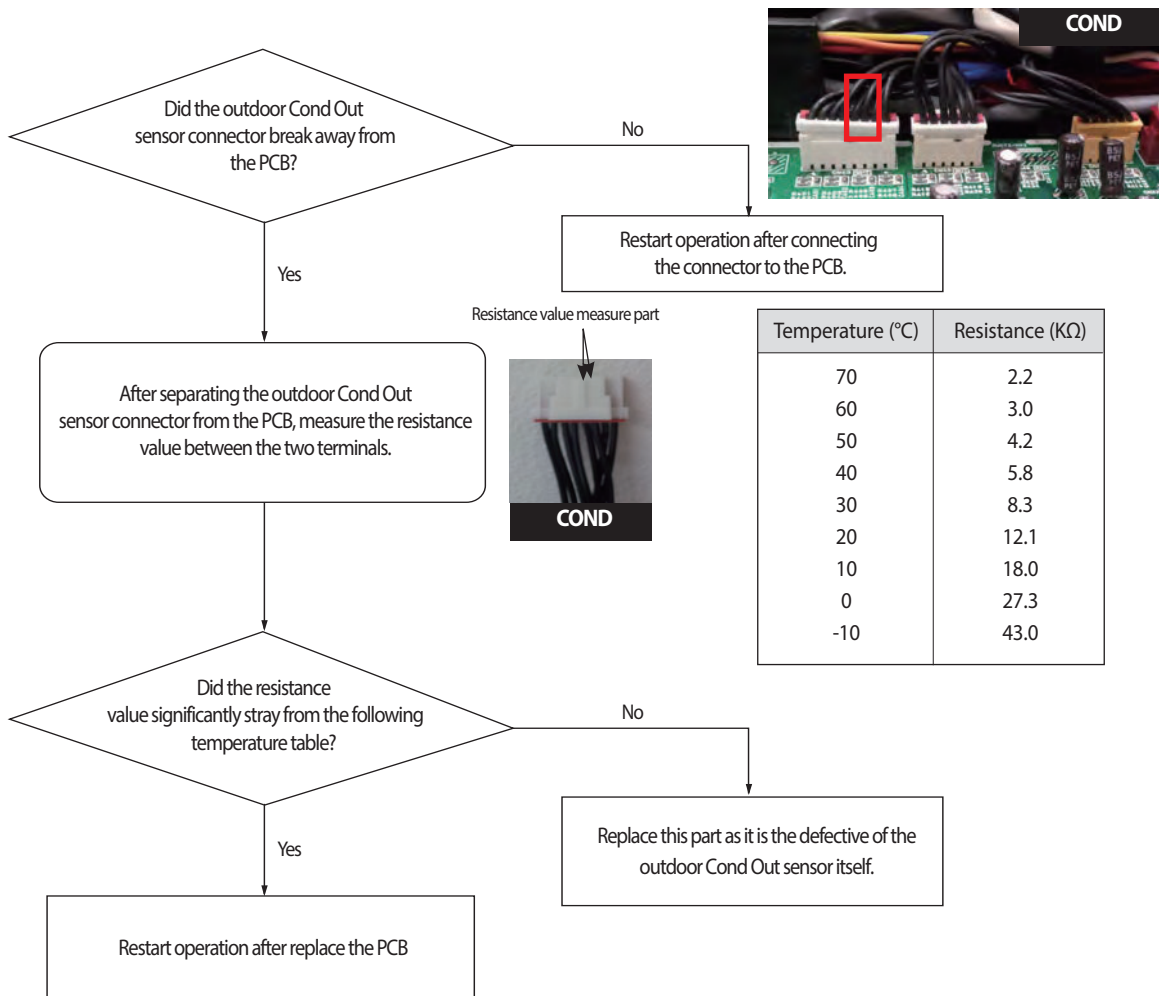

4-4-42 Outdoor Cond Out sensor breakaway error

Outdoor unit display	E241																		
Indoor unit display	Duct, Cassette (1 way / 2 way / Mini-4 way)				4 Way Cassette Type				Wall mounted Type				Circular Cassette Type						
	Display LED																		
	1 way	Blue	Yellow-Green	2 way	Green	Red	Start/Stop	Defroster	Reser- -vation	Filter -clean	18 °C	21 °C	Reser- -vation	24 °C	27 °C	Sky- -Blue	Yellow- -Green	Blue	Red
	×	×	○	○	○	○	×	○	○	○	×	×	○	○	○	×	×	○	×
Criteria	· Refer to the judgment method below.																		
Cause of problem	· Outdoor Cond Out sensor breakaway/defective/ relevant path blocked.																		

1. Judgment Method

- 1) No inspection for Cooling operation.
- 2) For heating operation (Each of the conditions below needs to be satisfied for more than 20 minutes.)

High pressure average > 25kg/cm ²	OK
Low pressure average < 8.5kg/cm ²	OK
Teva, out - Tair, in ≥ 3°C	OK
Teva, in - Tair, in ≥ 2°C	OK
Tcond, out - Tair, out ≤ 0°C	NO
Every compressor is in operation & indoor unit operation and Thermo On	OK
Error Content	Outdoor Cond Out sensor breakaway error

2. Cause of problem

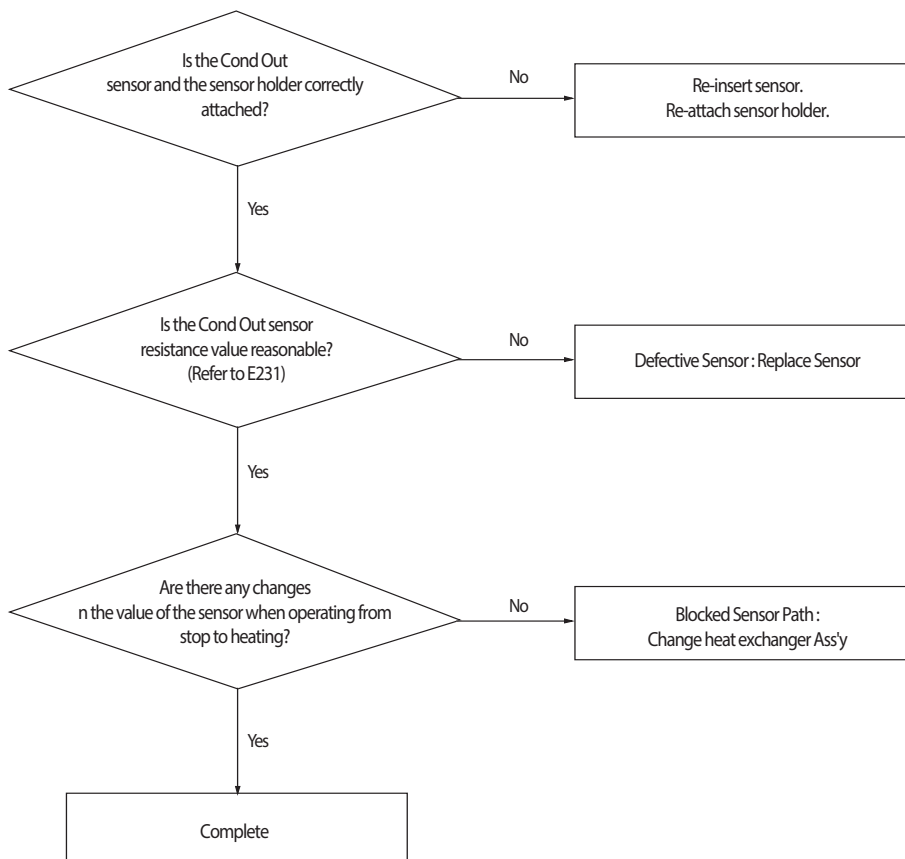

4-4-43 Digital Compressor Discharge Temperature Sensor Error (OPEN/SHORT)

Outdoor unit display	E25 1																
Indoor unit display	Duct, Cassette (1 way / 2 way / Mini-4 way)				4 Way Cassette Type				Wall mounted Type				Circular Cassette Type				
	Display LED																
	1 way		or	or	Start /Stop	Defroster	Reser- -vation	Filter -clean	18 °C	21 °C	Reser- -vation	24 °C	27 °C	Sky- -Blue	Yellow- -Green	Blue	Red
	Blue	Yellow- -Green															
2 way		or	or	Start /Stop	Defroster	Reser- -vation	Filter -clean	18 °C	21 °C	Reser- -vation	24 °C	27 °C	Sky- -Blue	Yellow- -Green	Blue	Red	
Green	Red																
Criteria	• Refer to the inspection method below,																
Cause of problem	• Digital compressor discharge temperature sensor OPEN/SHORT problem																

1. Inspection Method

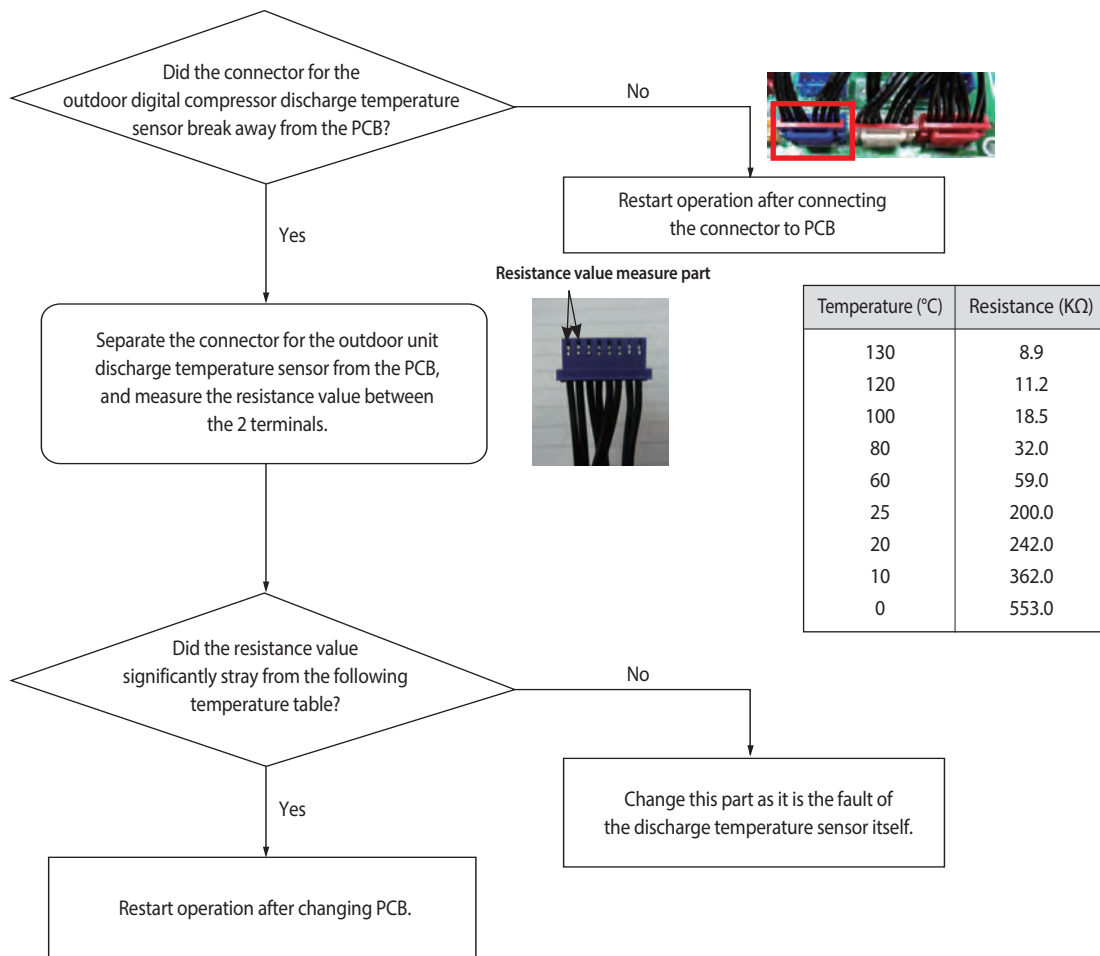

4-4-44 Constant Rate Compressor Discharge Temperature Sensor Error (OPEN/SHORT)

Outdoor unit display	E257, E258 (Compressor 2, Compressor 3)																	
Indoor unit display	Duct, Cassette (1 way / 2 way / Mini-4 way)				4 Way Cassette Type				Wall mounted Type				Circular Cassette Type					
	Display LED																	
	1 way	Blue	Yellow-Green	or	or	Start /Stop	Defroster	Reser- -vation	Filter -clean	18 °C	21 °C	Reser- -vation	24 °C	27 °C	Sky -Blue	Yellow -Green	Blue	Red
	2 way	Green	Red	or	or	Start /Stop	Defroster	Reser- -vation	Filter -clean	18 °C	21 °C	Reser- -vation	24 °C	27 °C	Sky -Blue	Yellow -Green	Blue	Red
Criteria	• Refer to the inspection method below.																	
Cause of problem	• Constant rate compressor discharge temperature sensor OPEN/SHORT problem																	

1. Inspection Method

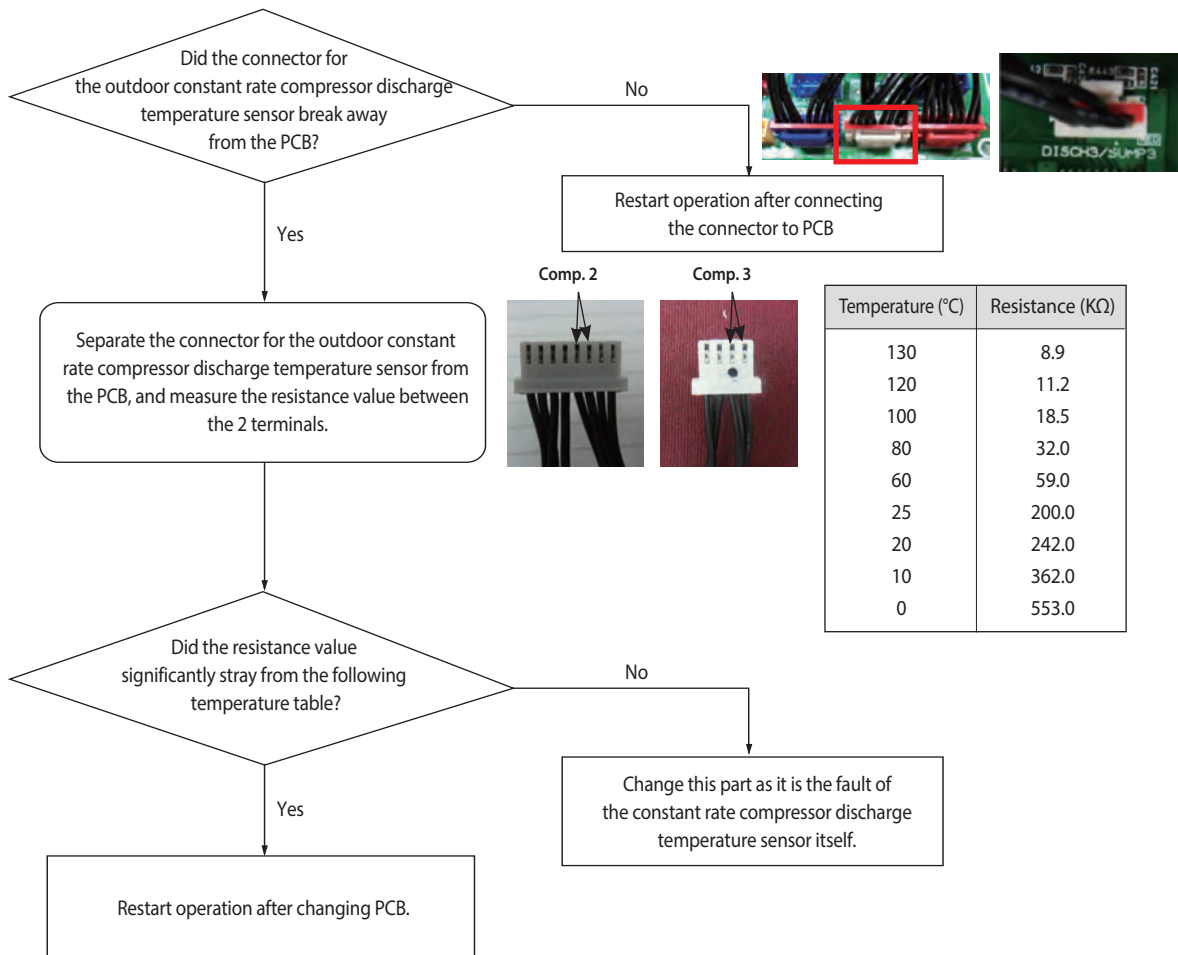

4-4-45 Compressor Discharge or Top 1/2 Temperature sensor error

Outdoor unit display	<i>E262</i> (Compressor 1 Discharge) <i>E263</i> (Compressor 2 Discharge)				
	<i>E266</i> (Compressor 1 Top) <i>E267</i> (Compressor 2 Top)				
Indoor unit display	Duct, Cassette (1 way / 2 way / Mini-4 way)	4 Way Cassette Type	Wall mounted Type	Circular Cassette Type	
	Display LED				
	1 way Blue Yellow-Green	or or	Start/Stop Defroster Reser- -vation	Filter -clean	18 °C 21 °C Reser- -vation 24 °C 27 °C Sky- -Blue Yellow- -Green Blue Red
	2 way Green Red				× × × ○ ○ ○ × ○ ○ ○ × ○ ○ × × ○ ×
Criteria	· Refer to the judgment method below.				
Cause of problem	· Compressor Discharge or Top Temperature sensor defective. (Open/Short)				

1. Cause of problem

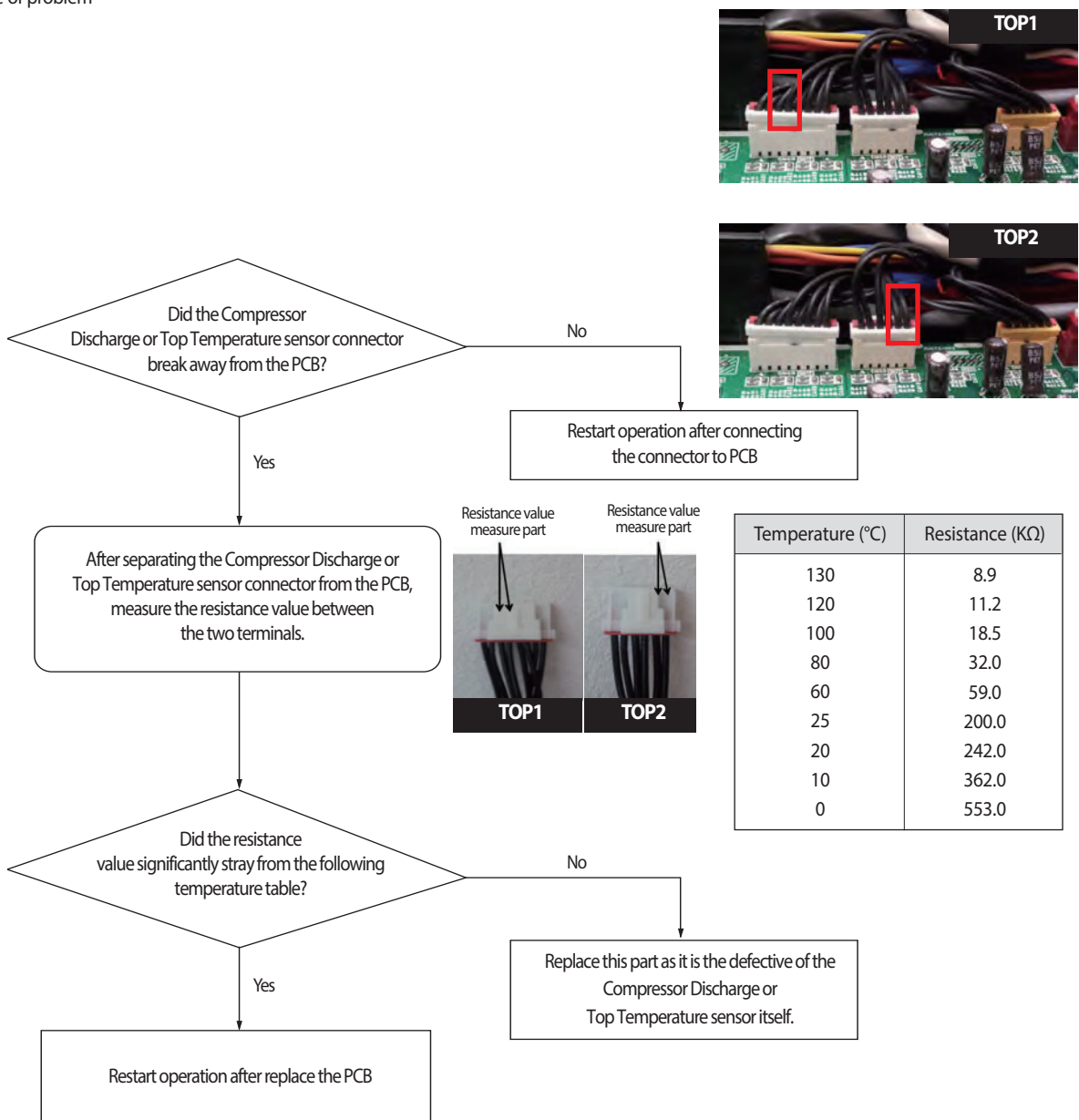

4-4-46 *E265* : Dislocation error of Compressor SUMP Temperature (oil temperature) Sensor

Outdoor unit display	<i>E265</i> (digital compressor or fixed compressor 1)
Indoor unit display	×(Operation) ●(Timer) ●(Fan) ●(Filter) ×(Defrost)
Criteria	• Refer to how to determine below
Cause of problem	• Sump (oil) temperature sensor dislocation error

1. How to diagnose

- 1) If the Sump temperature right before the start of compressor = $T_{\text{sump.ini}}$, current compressor's SUMP temp = $T_{\text{sump.real}}$,
 When the difference between $T_{\text{sump.ini}}$ and $T_{\text{sump.real}}$ is an absolute value so that it cannot be more than 2°C,
 In other words, the condition of $T_{\text{sump.real}} - T_{\text{sump.ini}} < 2^{\circ}\text{C}$ has been satisfied for 60 minutes since a compressor started, it is diagnosed as an error.
 After 60 minutes of compressor operation, there will be no Sump sensor dislocation detection.

2. How to check

- 1) Check if a sensor of the relevant compressor has been dislocated in accordance with error code, assemble and correct the error.

4-4-47 E269 : Suction Temperature sensor breakaway error

Outdoor unit display	E269																	
Indoor unit display	Duct, Cassette (1 way / 2 way / Mini-4 way)				4 Way Cassette Type				Wall mounted Type				Circular Cassette Type					
	Display LED																	
	1 way	Blue	Yellow-Green	or	or	Start /Stop	Defroster	Reser- -vation	Filter -clean	18 °C	21 °C	Reser- -vation	24 °C	27 °C	Sky -Blue	Yellow -Green	Blue	Red
	2 way	Green	Red															
	X	X	●	●	●	X	●	●	●	X	X	●	●	●	X	X	●	X
Criteria	· If the suction temperature right before operating the Comp, when the operating order is highest, is set at $T_{suc, ini}$, and the suction temperature of the current Comp is set at $T_{suc, real}$, it is considered to have an error if the condition of $T_{suc, real} < T_{suc, ini} < 2^{\circ}C$ is maintained for 30 minutes.																	
Cause of problem	· Suction temperature sensor breakaway/defective.																	

1. Cause of problem

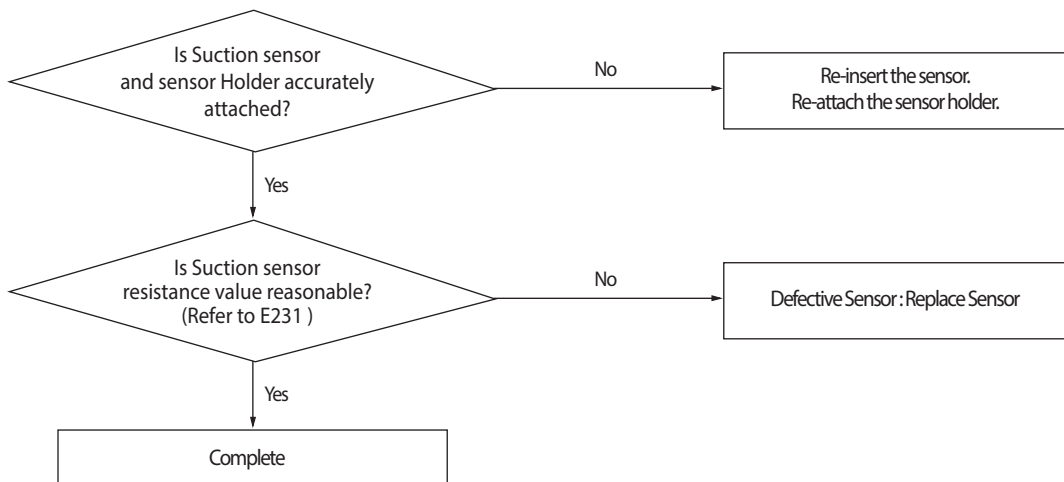

4-4-48 SUMP Temperature Sensor Error (OPEN/SHORT)

Outdoor unit display	E271
Indoor unit display	●(Operation) ×(Reservation) ●(Blast) ×(Filter) ×(Defrost)
Criteria	• Refer to the judgment method below.
Cause of problem	• Disconnection or breakdown of relevant sensor

1. Inspection Method

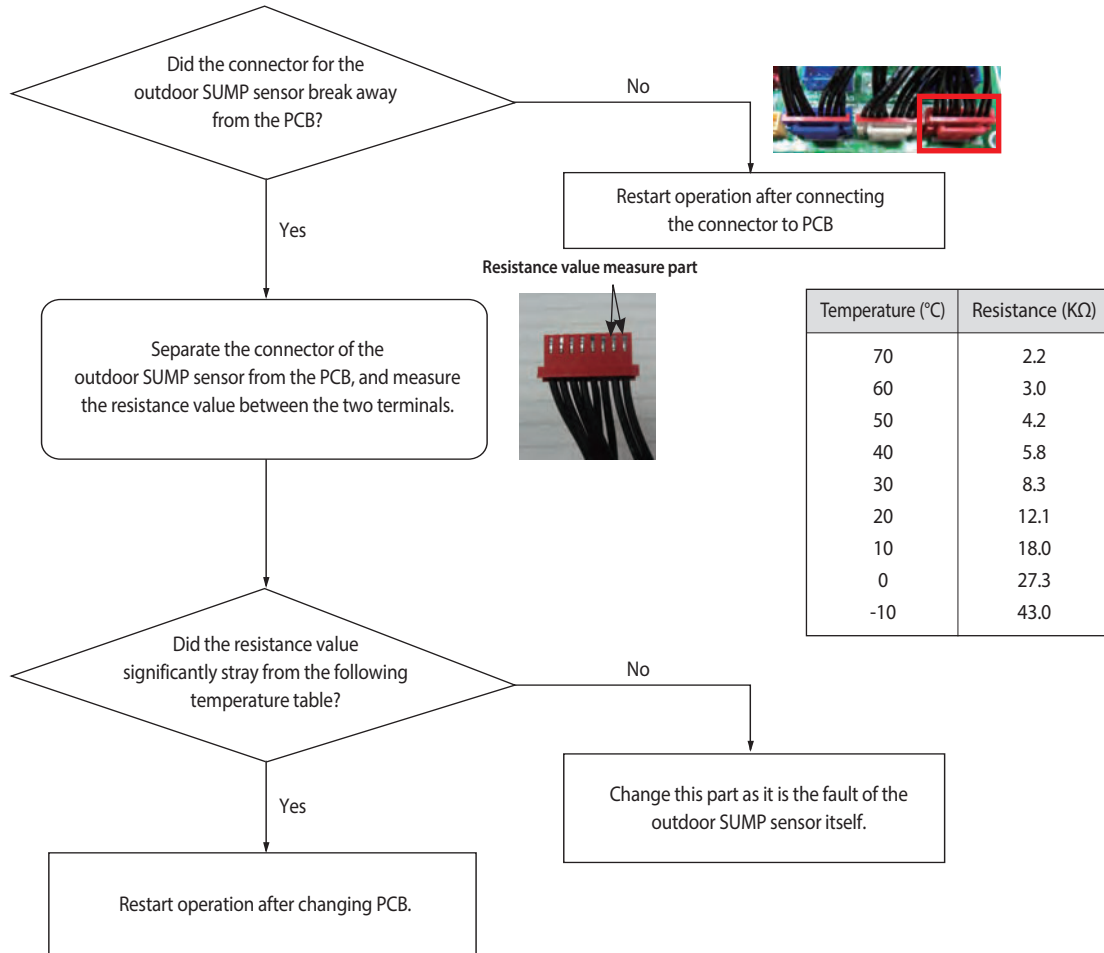

4-4-49 High Pressure sensor error (Open/Short)

Outdoor unit display	E291																				
Indoor unit display	Duct, Cassette (1 way / 2 way / Mini-4 way)				4 Way Cassette Type				Wall mounted Type				Circular Cassette Type								
	Display LED																				
	1 way	Blue	Yellow-Green	2 way	Green	Red	or	or	Start /Stop	Defroster	Reser- -vation	Filter -clean	18 °C	21 °C	Reser- -vation	24 °C	27 °C	Sky -Blue	Yellow- -Green	Blue	Red
	○	×	×	○	×	×	○	×	○	×	○	×	○	×	×	○	×	×	×	○	×
Criteria	· Refer to the judgment method below.																				
Cause of problem	· Disconnection or breakdown of relevant sensor.																				

- High Pressure sensor Open/Short error determination method
 - Identifies from when power is supplied or 2 minutes after RESET, and only when set is stopped.
 - An Open/Short error will occur if the input voltage standard range of 0.5V ~ 4.95V is exceeded.

2. Inspection Method

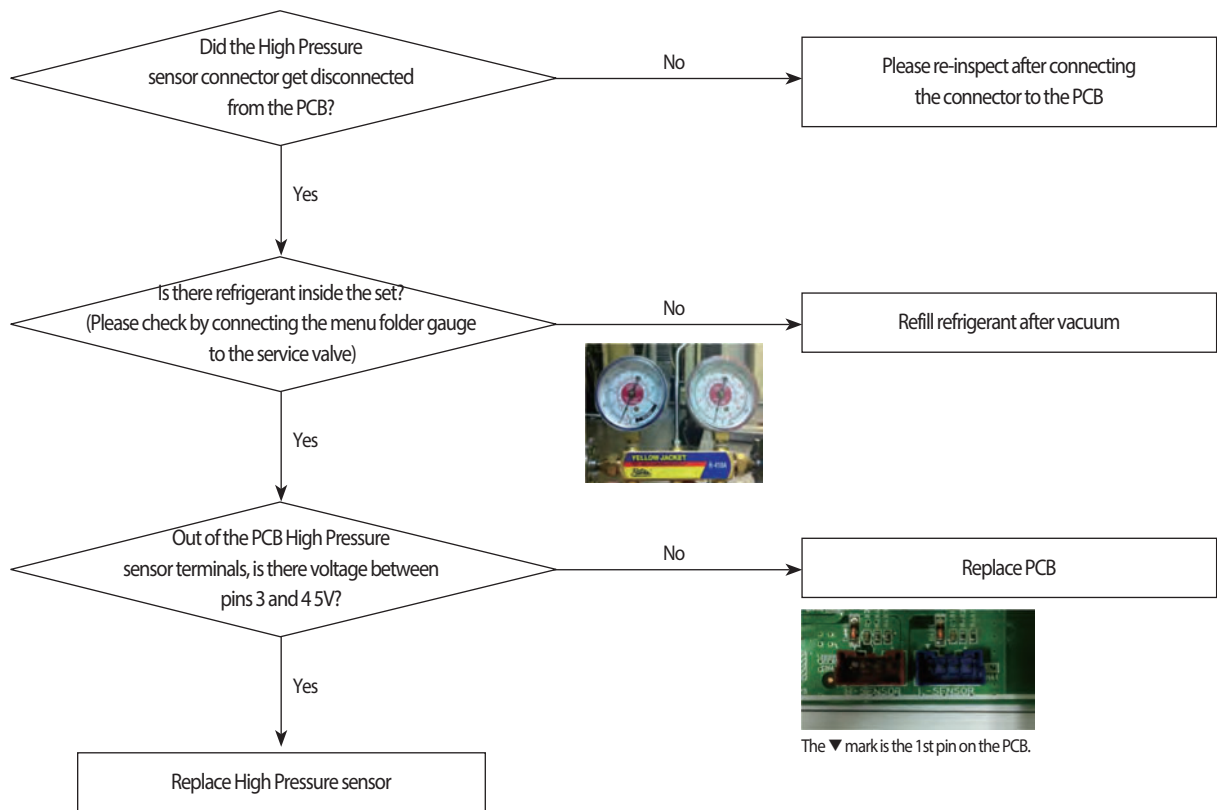

4-4-50 Low Pressure sensor error (Open/Short)

Outdoor unit display	E296																				
Indoor unit display	Duct, Cassette (1 way / 2 way / Mini-4 way)				4 Way Cassette Type				Wall mounted Type				Circular Cassette Type								
	Display LED																				
	1 way	Blue	Yellow-Green	2 way	Green	Red	or	or	Start /Stop	Defroster	Reser- -vation	Filter -clean	18 °C	21 °C	Reser- -vation	24 °C	27 °C	Sky -Blue	Yellow -Green	Blue	Red
	○	×	×	○	×	×	○	×	○	×	○	×	○	×	×	○	×	×	×	○	×
Criteria	· Refer to the judgment method below.																				
Cause of problem	· Disconnection or breakdown of relevant sensor.																				

1. Low Pressure sensor Open/Short error determination method
 - 1) Identifies from when power is supplied or 2 minutes after RESET, and only when set is stopped.
 - 2) An Open/Short error will occur if the input voltage standard range of 0.5V ~ 4.95V is exceeded.

2. Inspection Method

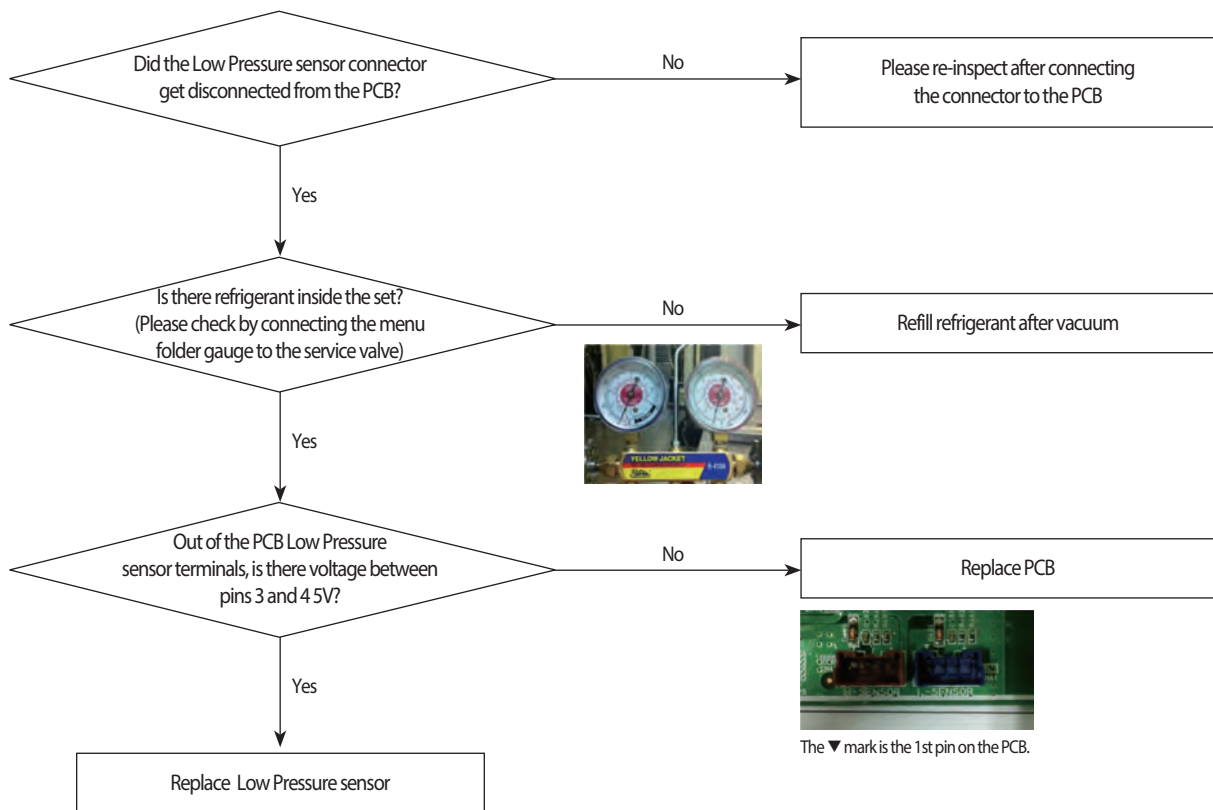

4-4-51 Suction Temperature sensor error (Open/Short)

Outdoor unit display	E308																	
Indoor unit display	Duct, Cassette (1 way / 2 way / Mini-4 way)				4 Way Cassette Type				Wall mounted Type				Circular Cassette Type					
	Display LED																	
	1 way	Blue	Yellow-Green	or	or	Start /Stop	Defroster	Reser- -vation	Filter -clean	18 °C	21 °C	Reser- -vation	24 °C	27 °C	Sky -Blue	Yellow -Green	Blue	Red
	2 way	Green	Red	or	or	Start /Stop	Defroster	Reser- -vation	Filter -clean	18 °C	21 °C	Reser- -vation	24 °C	27 °C	Sky -Blue	Yellow -Green	Blue	Red
	●	×	×	●	×	●	×	●	×	●	×	×	●	×	×	●	×	
Criteria	· Refer to the judgment method below.																	
Cause of problem	· Disconnection or breakdown of relevant sensor.																	

1. Cause of problem

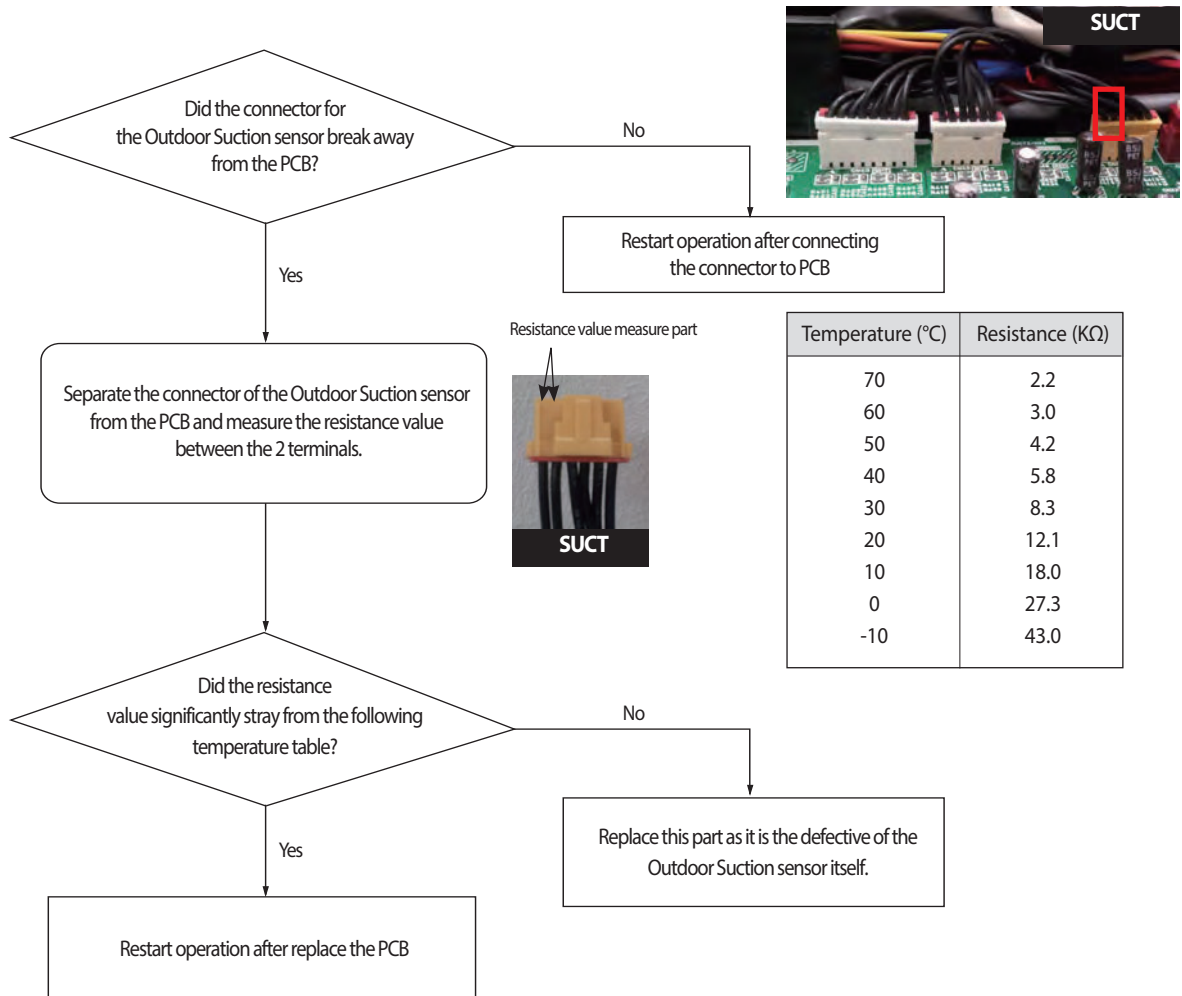

4-4-52 Liquid Pipe Temperature sensor error (Open/Short)

Outdoor unit display	E311																	
Indoor unit display	Duct, Cassette (1 way / 2 way / Mini-4 way)				4 Way Cassette Type				Wall mounted Type				Circular Cassette Type					
	Display LED																	
	1 way	Blue	Yellow-Green	or	or	Start /Stop	Defroster	Reser- -vation	Filter -clean	18 °C	21 °C	Reser- -vation	24 °C	27 °C	Sky -Blue	Yellow -Green	Blue	Red
	2 way	Green	Red	or	or	or	or	or	or	or	or	or	or	or	or	or	or	or
	●	×	×	●	×	●	×	●	×	●	×	×	●	×	×	×	●	×
Criteria	· Refer to the judgment method below.																	
Cause of problem	· Disconnection or breakdown of relevant sensor.																	

1. Cause of problem

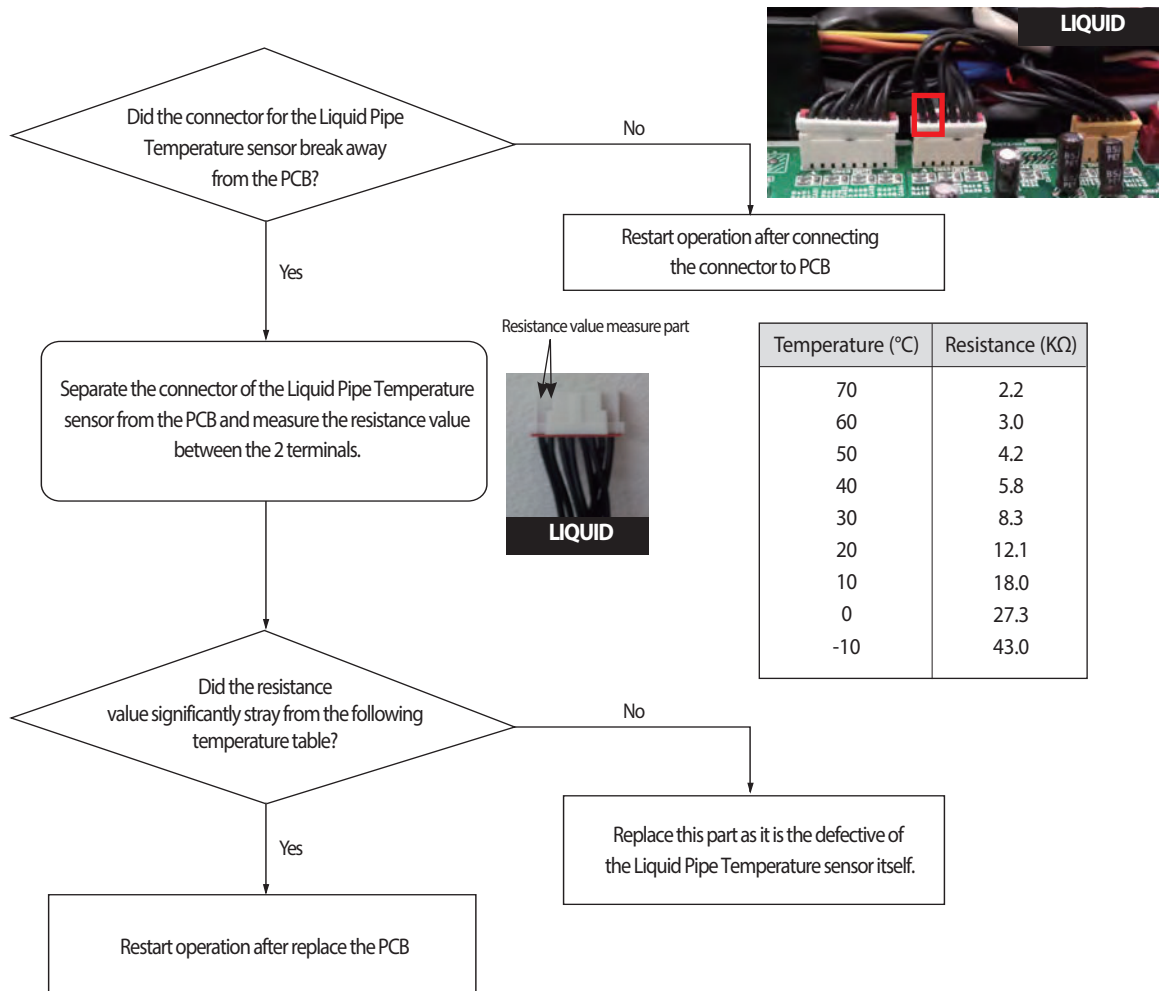

4-4-53 EVI In Temperature sensor error (Open/Short)

Outdoor unit display	E321																	
Indoor unit display	Duct, Cassette (1 way / 2 way / Mini-4 way)				4 Way Cassette Type				Wall mounted Type				Circular Cassette Type					
	Display LED																	
	1 way		or	or	or	Start /Stop	Defroster	Reser- -vation	Filter -clean	18 °C	21 °C	Reser- -vation	24 °C	27 °C	Sky -Blue	Yellow -Green	Blue	Red
	Blue	Yellow-Green																
2 way		or	or	or	Start /Stop	Defroster	Reser- -vation	Filter -clean	18 °C	21 °C	Reser- -vation	24 °C	27 °C	Sky -Blue	Yellow -Green	Blue	Red	
Green	Red																	
Criteria	· Refer to the judgment method below.																	
Cause of problem	· Disconnection or breakdown of relevant sensor.																	

1. Cause of problem

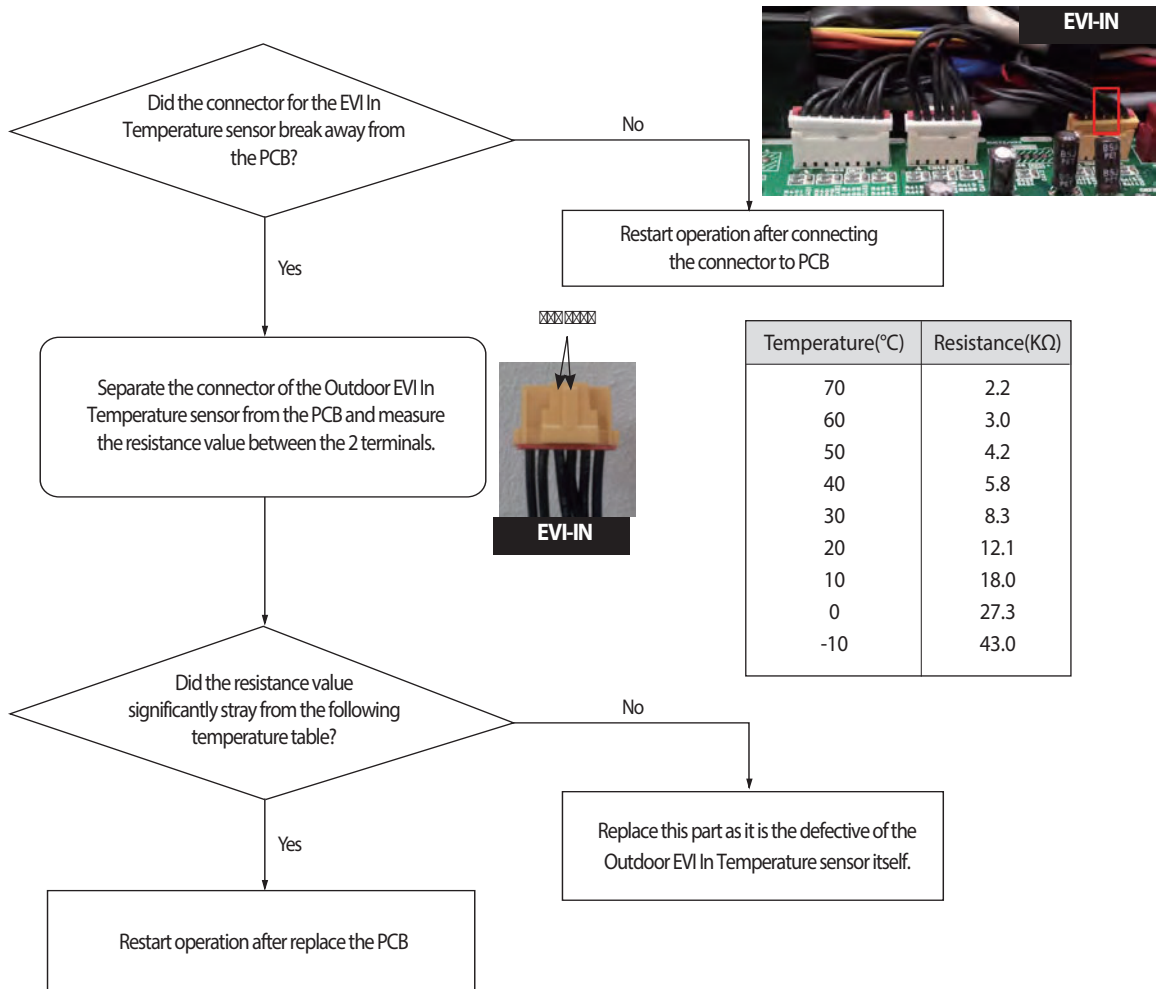

4-4-54 EVI Out Temperature sensor error (Open/Short)

Outdoor unit display	E322																	
Indoor unit display	Duct, Cassette (1 way / 2 way / Mini-4 way)				4 Way Cassette Type				Wall mounted Type				Circular Cassette Type					
	Display LED																	
	1 way		or	or	or	Start /Stop	Defroster	Reser- -vation	Filter -clean	18 °C	21 °C	Reser- -vation	24 °C	27 °C	Sky -Blue	Yellow -Green	Blue	Red
	Blue	Yellow- Green																
2 way		or	or	or	Start /Stop	Defroster	Reser- -vation	Filter -clean	18 °C	21 °C	Reser- -vation	24 °C	27 °C	Sky -Blue	Yellow -Green	Blue	Red	
Green	Red																	
Criteria	· Refer to the judgment method below.																	
Cause of problem	· Disconnection or breakdown of relevant sensor.																	

1. Cause of problem

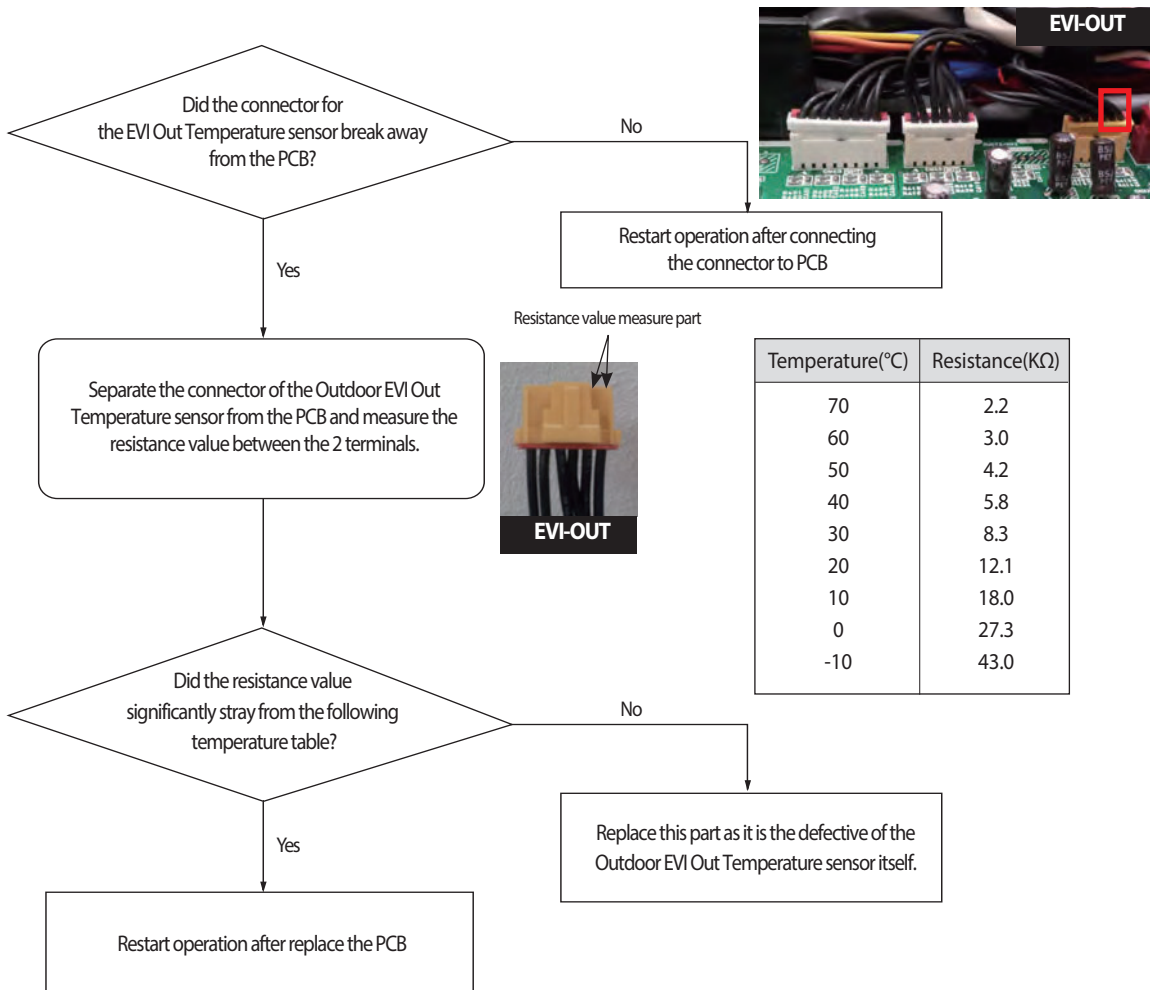

4-4-55 Suction-2 Temperature Sensor Error (OPEN/SHORT)

Outdoor unit display	E323																	
Indoor unit display	Duct, Cassette (1 way / 2 way / Mini-4 way)				4 Way Cassette Type				Wall mounted Type				Circular Cassette Type					
	Display LED																	
	1 way	Blue	Yellow-Green	or	or	Start /Stop	Defroster	Reser- -vation	Filter -clean	18 °C	21 °C	Reser- -vation	24 °C	27 °C	Sky -Blue	Yellow -Green	Blue	Red
	2 way	Green	Red	or	or	Start /Stop	Defroster	Reser- -vation	Filter -clean	18 °C	21 °C	Reser- -vation	24 °C	27 °C	Sky -Blue	Yellow -Green	Blue	Red
Criteria	• Refer to the judgment method below.																	
Cause of problem	• Disconnection or breakdown of relevant sensor																	

1. Inspection Method

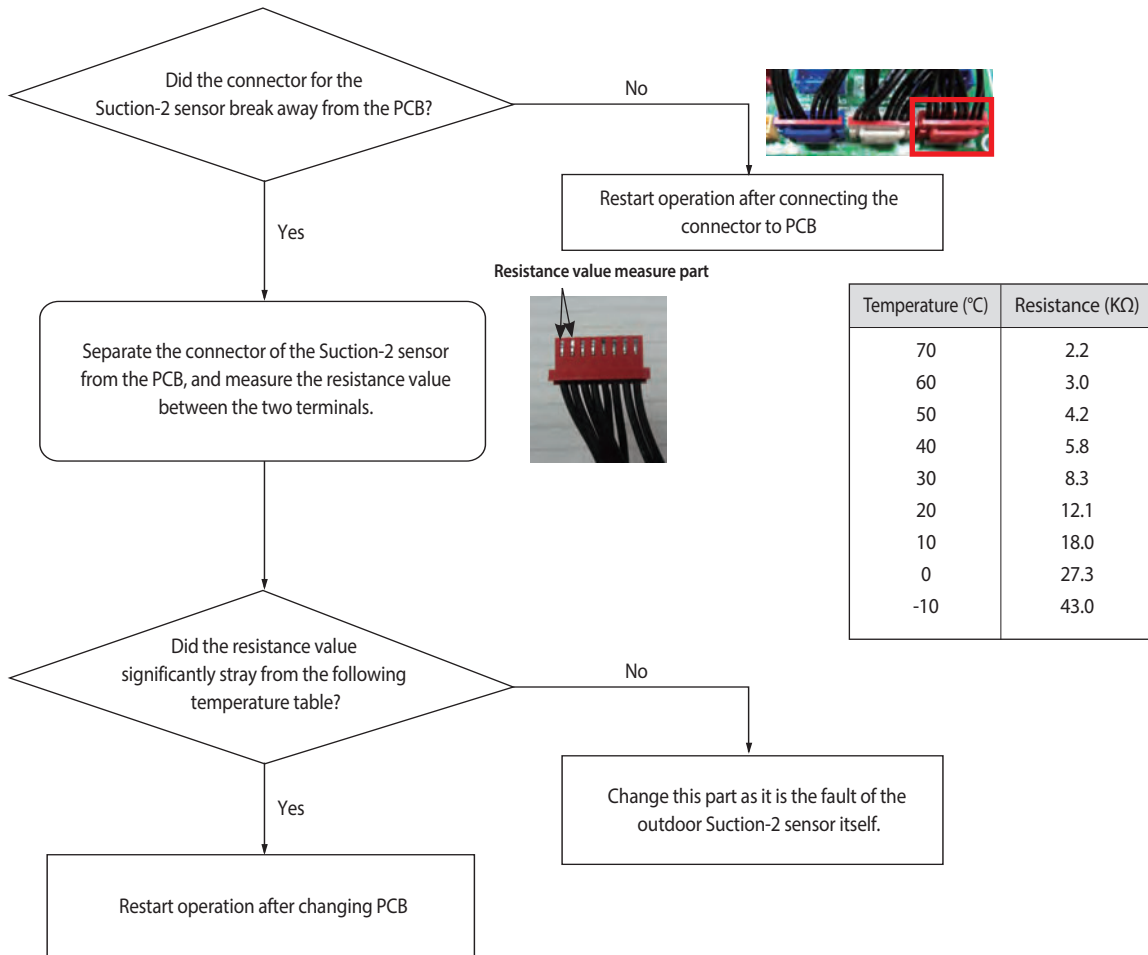

4-4-56 E407 : Comp. Down due to High Pressure Protection Control

Outdoor unit display	E407																		
Indoor unit display	Duct, Cassette (1 way / 2 way / Mini-4 way)				4 Way Cassette Type				Wall mounted Type				Circular Cassette Type						
	Display LED																		
	1 way	Blue	Yellow-Green	2 way	Green	Red	Start /Stop	Defroster	Reser- -vation	Filter -clean	18 °C	21 °C	Reser- -vation	24 °C	27 °C	Sky -Blue	Yellow -Green	Blue	Red
	○	○	○	○	○	○	○	○	○	○	○	○	○	○	○	○	○	○	○
×	×	○	○	○	○	×	○	○	○	×	×	○	○	○	×	×	○	×	

Criteria · Value of the high pressure sensor is detected at 40kg/cm² or more .

- Cause of problem
- <Cooling Operation>
 - Outdoor unit fan motor problem (constrained, defective)
 - Motor driver defective or wire is cut
 - Outdoor heat exchanger is contaminated.
 - Service valve locked/Fill refrigerant
 - <Heating Operation>
 - Outdoor unit fan motor problem (constrained, defective)
 - Motor driver defective or wire is cut
 - Service valve locked/Excessive refrigerant

1. Cause of problem

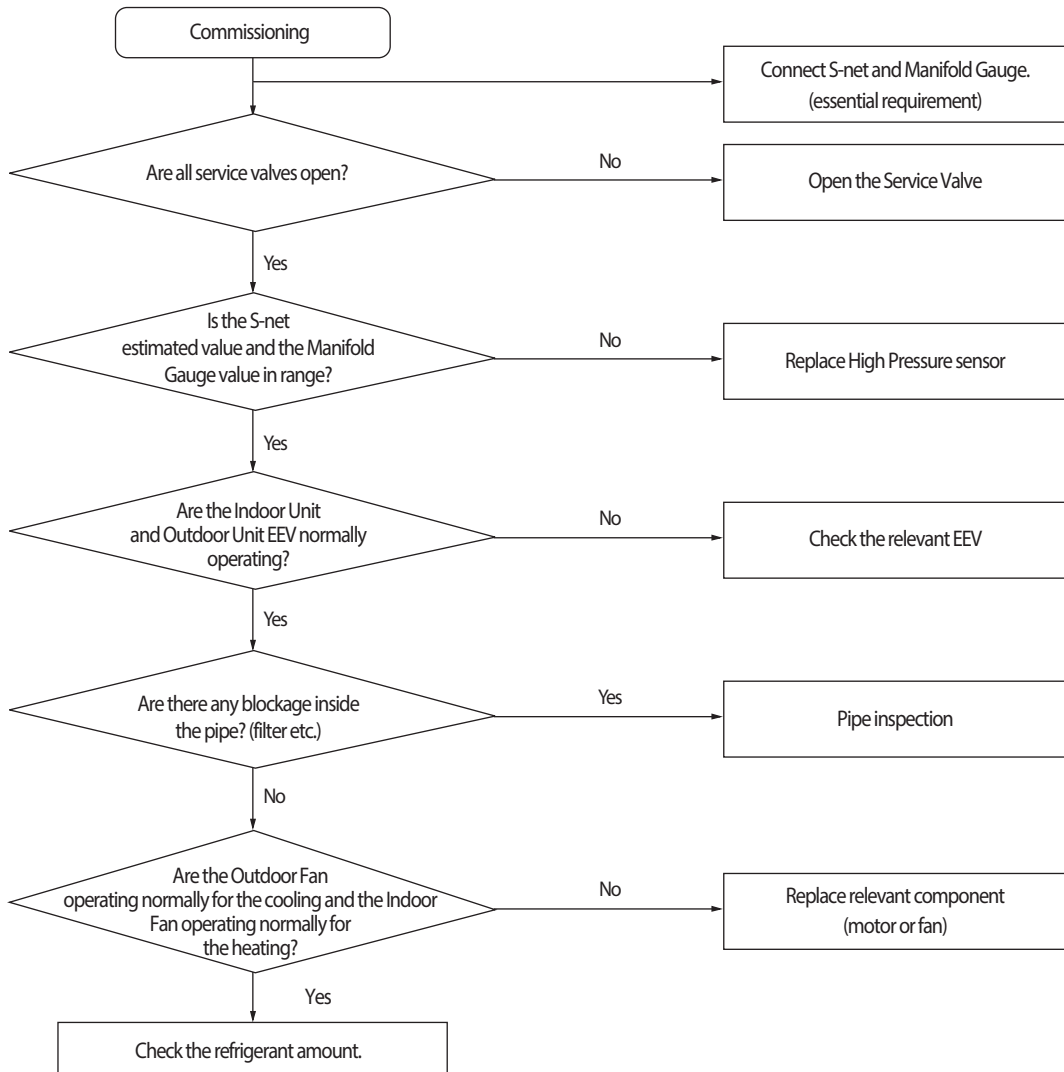

4-4-57 E4 10 : Comp. Down due to Low Pressure Protection Control

Outdoor unit display	E4 10																		
Indoor unit display	Duct, Cassette (1 way / 2 way / Mini-4 way)				4 Way Cassette Type				Wall mounted Type				Circular Cassette Type						
	Display LED																		
	1 way	Blue	Yellow-Green	2 way	Green	Red	Start /Stop	Defroster	Reser- -vation	Filter -clean	18 °C	21 °C	Reser- -vation	24 °C	27 °C	Sky -Blue	Yellow -Green	Blue	Red
	×	×	○	○	○	○	×	○	○	○	×	×	○	○	○	×	×	○	×
Criteria	· Inspection when the value of low pressure sensor is 0.8kg/cm ² , or less for air conditioning and 0.6kg/cm ² for heating.																		
Cause of problem	<ul style="list-style-type: none"> · Refrigerant shortage · Electronic expansion valve blocked · Service valve blocked · Low pressure sensor defective · Leakage of compressor discharge check valve of not-go-end outdoor unit · Error may be found when used in temperature range outside the conditions of use (Operating outside temperature at -20°C or less for heating and operating outside temperature at -5°C or less for Cooling) 																		

1. Cause of problem

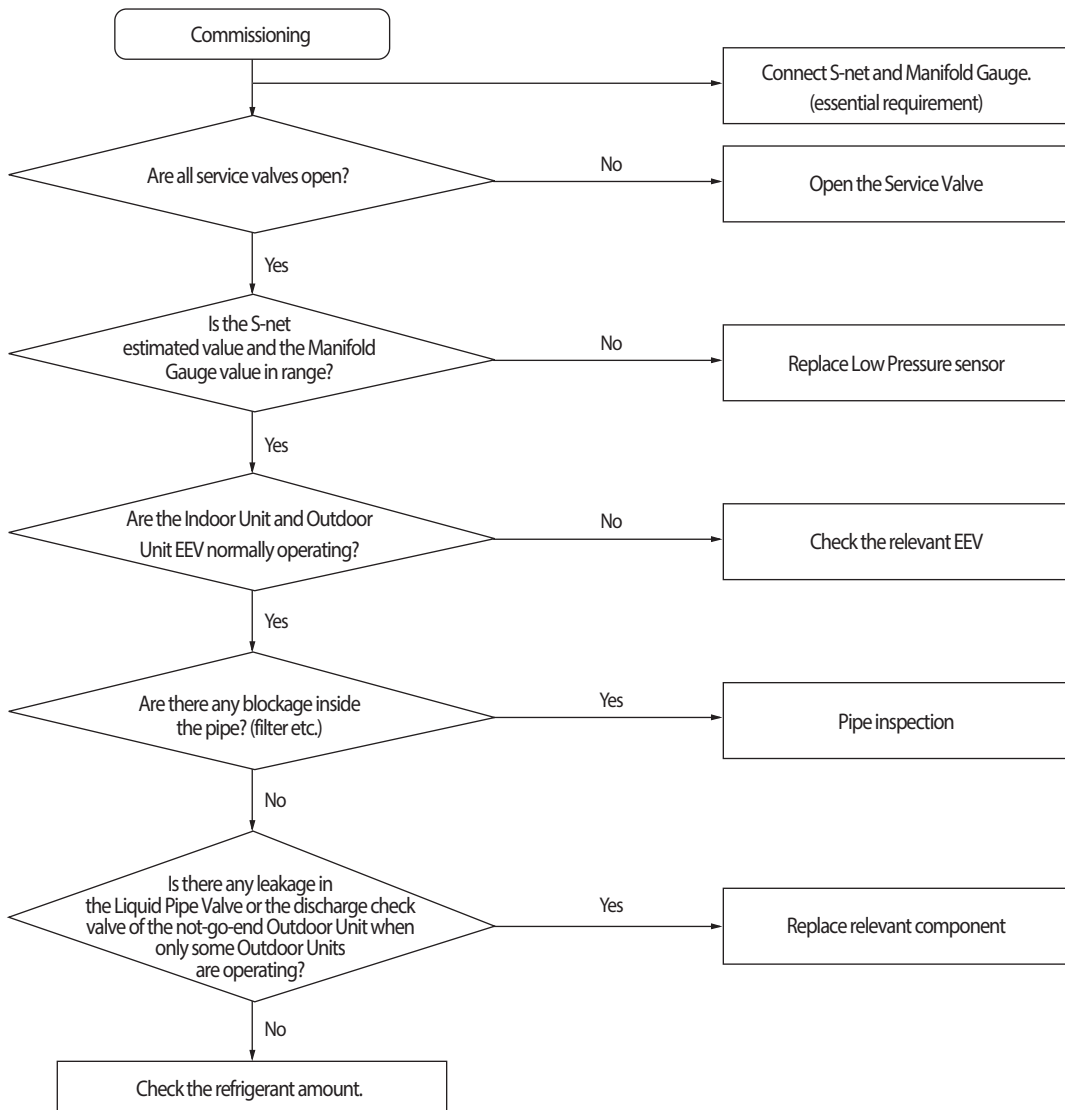

4-4-58 Sump Sensor Error Due to Protection Control

Outdoor unit display	E413
Indoor unit display	×(Operation) ●(Reservation) ●(Blast) ●(Filter) ×(Defrost)
Criteria	• Maintain sump temperature of 95°C or more for five minutes
Cause of problem	• Compressor loading faulty/sump temperature sensor faulty

1. Inspection Method

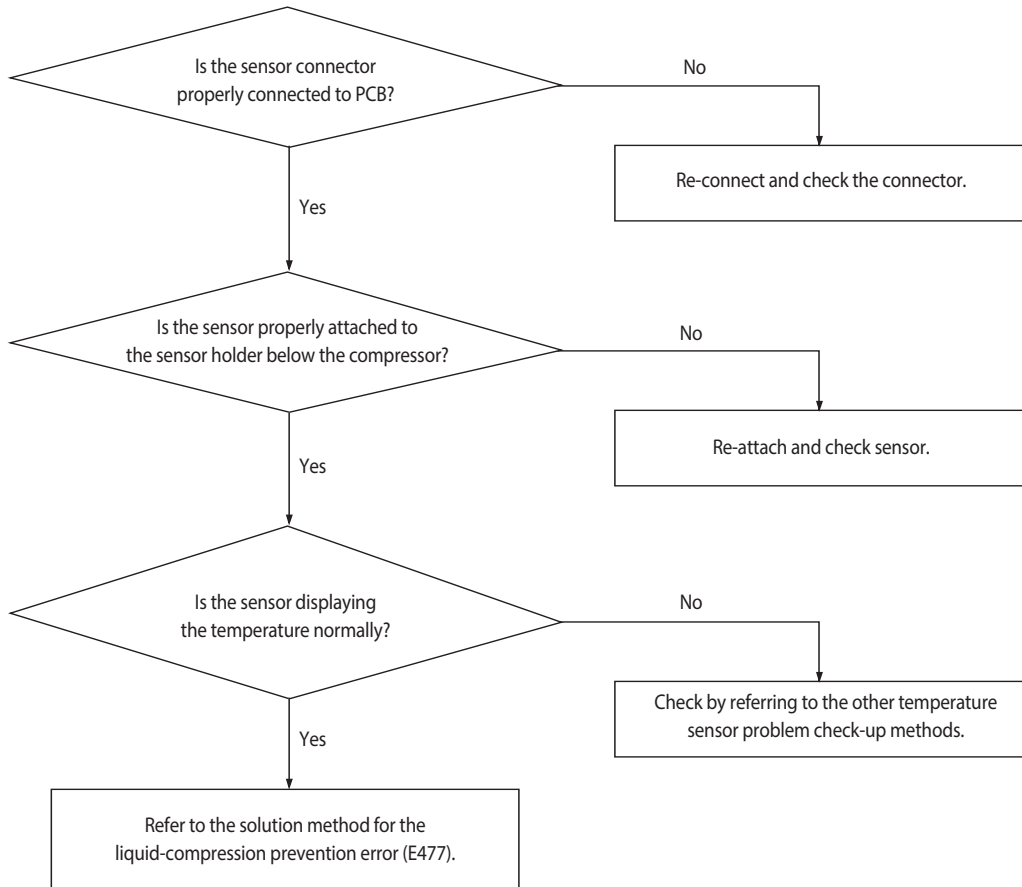

4-4-59 E4 16 : Comp. Down due to Compressor Discharge Temperature sensor

Outdoor unit display	E4 16																		
Indoor unit display	Duct, Cassette (1 way / 2 way / Mini-4 way)				4 Way Cassette Type				Wall mounted Type				Circular Cassette Type						
	Display LED																		
	1 way		Blue	Yellow-Green	or	or	Start /Stop	Defroster	Reser- -vation	Filter -clean	18 °C	21 °C	Reser- -vation	24 °C	27 °C	Sky- -Blue	Yellow- -Green	Blue	Red
	2 way																		
x		x	●	●	●	x	●	●	●	x	x	●	●	●	x	x	●	x	
Criteria	· When value of compressor discharge temperature sensor is checked at 120°C or more																		
Cause of problem	<ul style="list-style-type: none"> · Refrigerant shortage · Electronic expansion valve is blocked. · Service valve blocked · Defective discharge temperature sensor · Blocked pipe and defective · Leakage of compressor discharge check valve of not-go-end outdoor unit 																		

1. Cause of problem

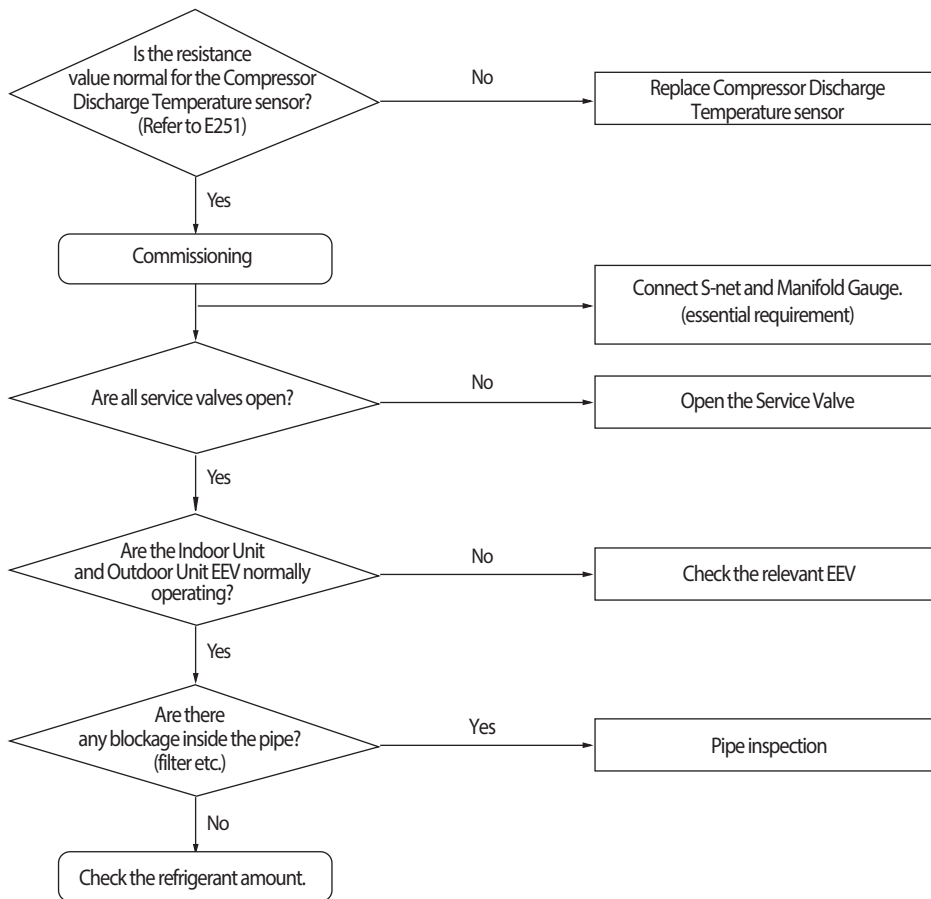

4-4-60 3-phase Input Wiring error

Outdoor unit display	E425																		
Indoor unit display	Duct, Cassette (1 way / 2 way / Mini-4 way)				4 Way Cassette Type				Wall mounted Type				Circular Cassette Type						
	Display LED																		
	1 way	Blue	Yellow-Green	2 way	Green	Red	Start/Stop	Defroster	Reser- -vation	Filter -clean	18 °C	21 °C	Reser- -vation	24 °C	27 °C	Sky- -Blue	Yellow- -Green	Blue	Red
	×	×	○	○	○	○	×	○	○	○	×	×	○	○	○	×	×	○	×
Criteria	<ul style="list-style-type: none"> When turn on the power and check the status of the power from the inverter. If the phase does not connect the power(no phase) : E425 or E466 (E366) is displayed (Air conditioner to maintain the normal state.) However) N-phase must be properly connected. 																		
Cause of problem	<ul style="list-style-type: none"> Check the input wiring EMI Fuse short 																		

1. Cause of problem

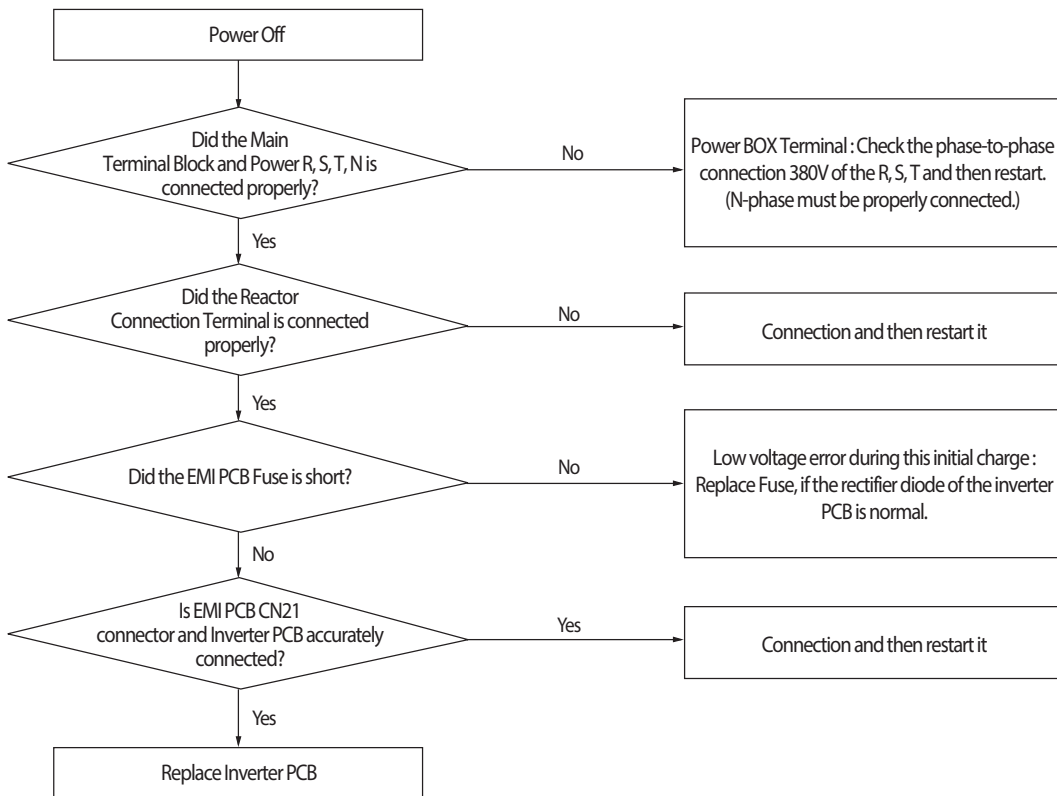

4-4-61 E428 : Comp. Down by Compression Ratio Control

Outdoor unit display	E428																	
Indoor unit display	Duct, Cassette (1 way / 2 way / Mini-4 way)				4 Way Cassette Type				Wall mounted Type				Circular Cassette Type					
	Display LED																	
	1 way	Blue	Yellow-Green	or	or	Start /Stop	Defroster	Reser- -vation	Filter -clean	18 °C	21 °C	Reser- -vation	24 °C	27 °C	Sky -Blue	Yellow -Green	Blue	Red
	2 way	Green	Red															
	×	×	●	●	●	×	●	●	●	×	×	●	●	●	×	×	●	×
Criteria	<ul style="list-style-type: none"> When compression ratio (high pressure+1)/(low pressure+1) less than 1.5 and lasts for 10 minutes or more Differential pressure (high pressure - low pressure) less than 0.4 MPa.g and lasts for 10 minutes or more 																	
Cause of problem	<ul style="list-style-type: none"> Indoor and Outdoor EEV breakdown 4Way Valve breakdown High and Low pressure sensor defective Refrigerant shortage 																	

1. Cause of problem

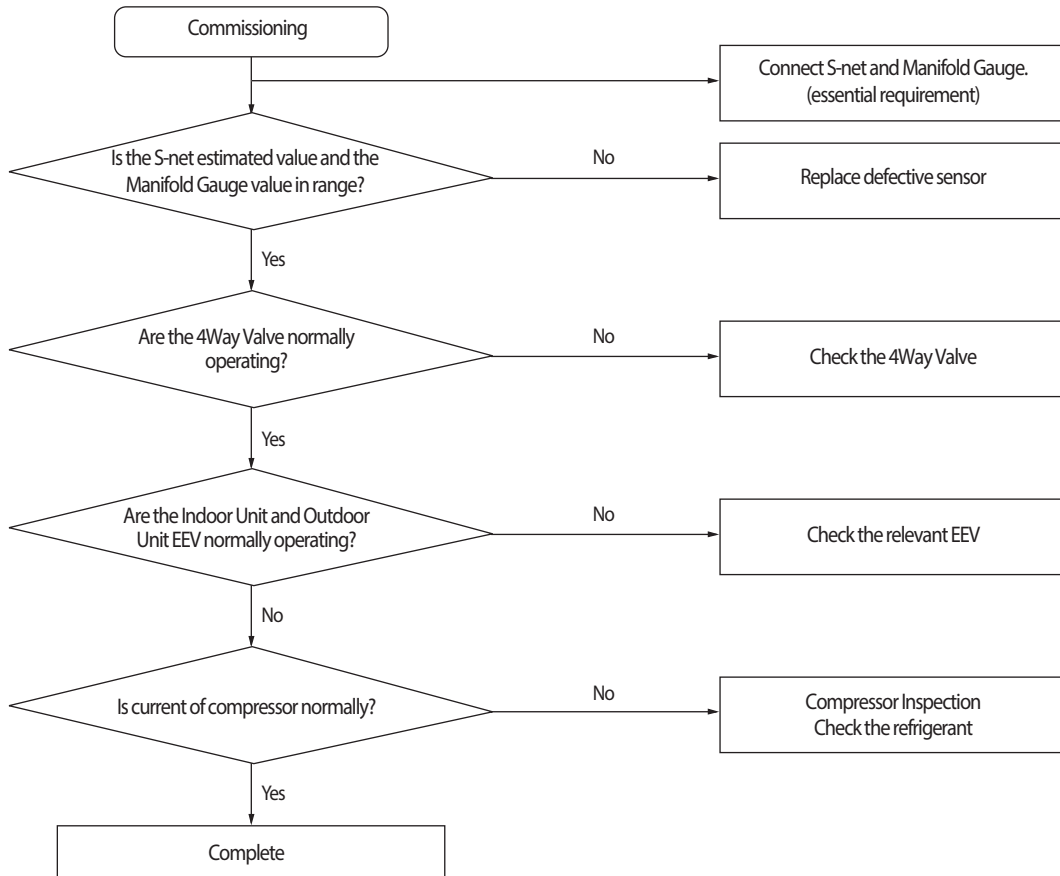

4-4-62 EVI EEV Open error

Outdoor unit display	E438
Indoor unit display	-
Criteria	. DSH <10 °C, EVI Out-in <= 0°C & frequency> 65Hz 40 minutes maintaining
Cause of problem	. EVI EEV and Intercooler leakage, excessive refrigerant amount, Outdoor Check Valve inserted opposite. . Indoor Unit EEV leakage, direct connection between Indoor Liquid Pipe and the Gas Pipe.

※ Indoor EEV leakage can be easily checked during the operation of cooling operation and during the not-go-end blast operation.
(In case it is normal, the EVA In and Out temperatures for the blast may rise.)

※ If cooling operation is operated for low temperature with excessive refrigerant amount, then the DSH may descend.

1. Cause of problem

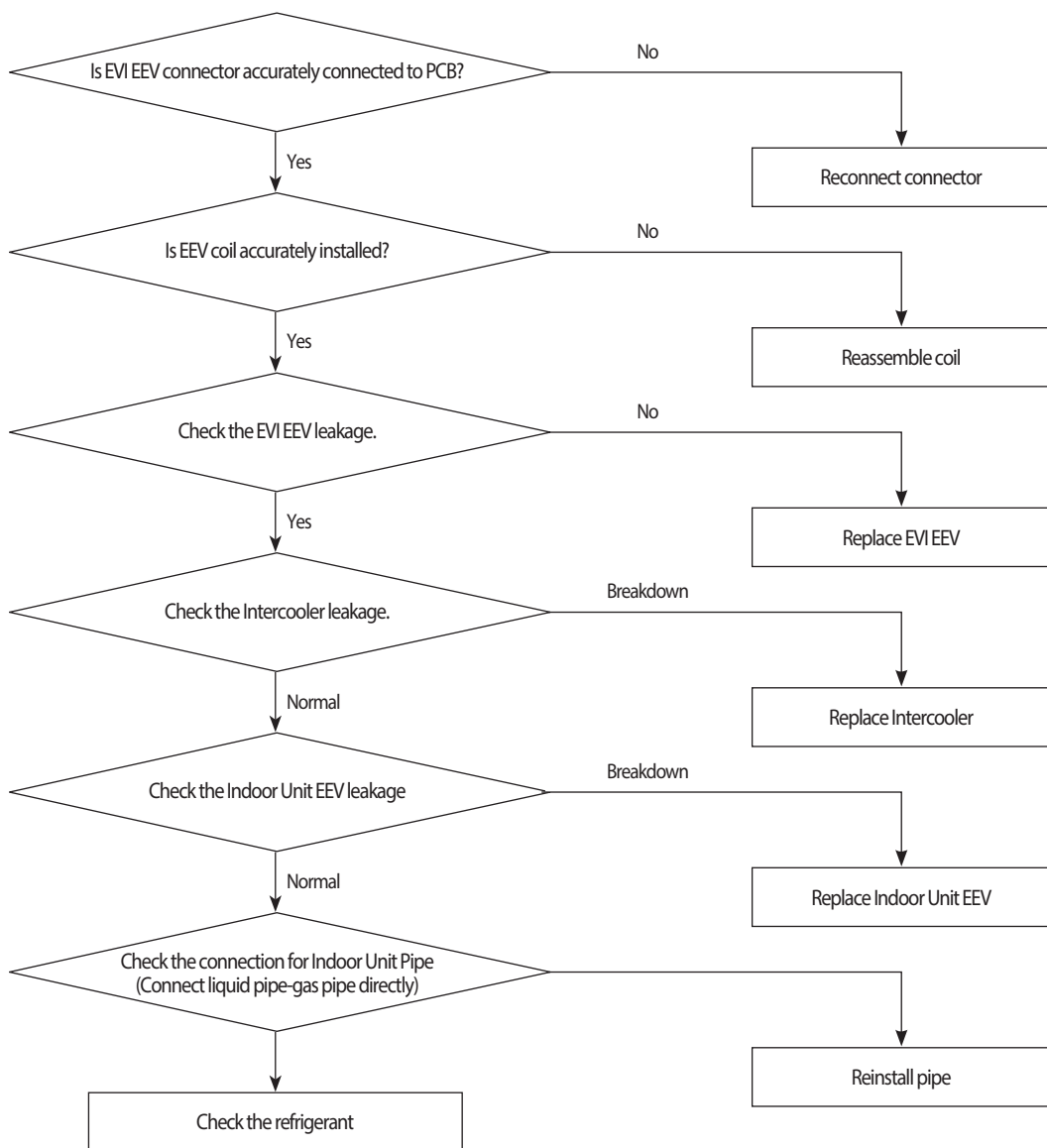

4-4-63 Refrigerant Leakage Error

Outdoor unit display	E439
Indoor unit display	-
Criteria	• Refer to the judgment method below
Cause of problem	• Leakage of refrigerant, simultaneous malfunction of pressure sensor

■ Low-pressure sensor OPEN/SHORT error determination method

1. Identifies from when power is supplied or 2 minutes after RESET, and only when set is stopped.
2. An E439 error will occur if the input voltage standard ranges of 0.5V ~ 4.95V of both the high- and low-pressure sensors are exceeded.
3. Will occur if the measured value of both high- and low-pressure sensors is 1kgf/cm²G

1. Inspection method

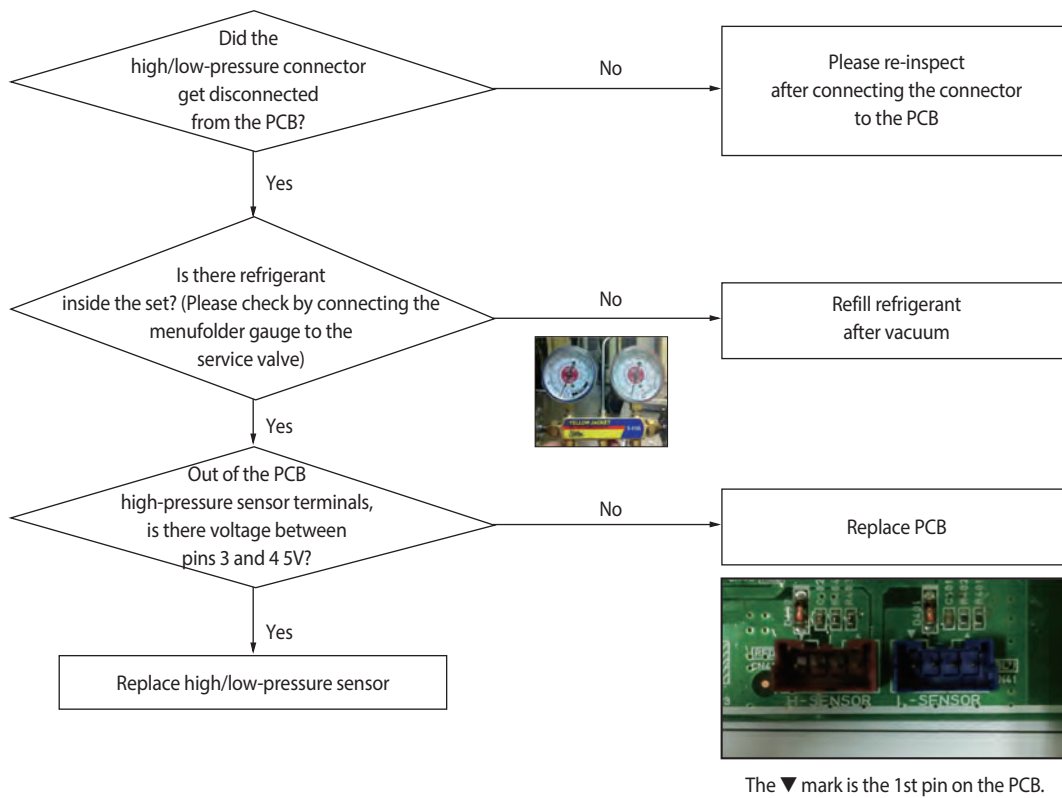

4-4-64 E440, E442 : Prohibition of the operation of Compressor due to Outdoor Temperature

Outdoor unit display	E440 (prohibit heating operation in outdoor temperature over 30°C) E442 (prohibit heat filling operation in outdoor temperature over 15°C)
Indoor unit display	No sign
Criteria	E440 : Right before an outdoor unit starts heating operation by On signal of an indoor Remocon, the error occurs and prohibits the operation in outdoor temperature over 30°C E442 : Right before operating heat refrigerant filling mode by the K1 switch of an outdoor PCB, the error occurs and prohibits the operation in outdoor temperature over 15°C
Cause of problem	• Operation Prohibition mode by the indoor temperature limit

1. How to check

The above error code is not caused by a product's problem but a function to protect the product by limiting the available temperature range so please refer to the usable temperature range in the product manual.

If the error code is displayed despite a condition that does not belong to any of the above diagnosis methods, read the temperature sensor value of the outdoor inlet air with View Mode or S-net, and if the actual outdoor temperature is different, please replace the temperature sensor.

4-4-65 High Pressure Standard Not Met before Air Conditioning (Inability to Re-operate)

Outdoor unit display	E443
Indoorunit display	×(Operation) ● (Reservation) ● (Blast) ● (Filter) ×(Defrost)
Judgment Method	· Operation should be forbidden if High Pressure sensor value of the Main Unit before the pump down is started at 2.2kg/cm ² g or below for air-conditioning and 1.0kg/cm ² G or less for heating for three consecutive seconds. (Restarting operation is not possible, and an error displayed on the indoor unit.)
Cause of problem	· Refrigerant leakage/fault in High Pressure sensor .

1. Cause of problem

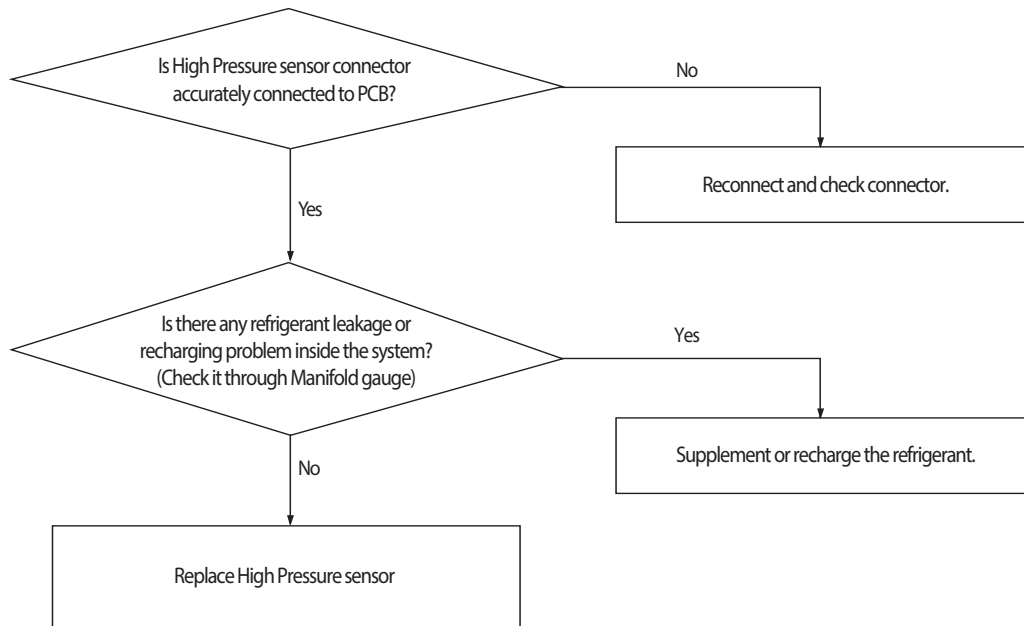

4-4-66 CCH Malfunction and Sump Sensor Miswiring Error

Outdoor Unit Display	E445
Indoor Unit Display	-
Judgment Method	• Refer to the judgment method below
Special Cause	• CCH Connector PCB is not connected / Sump sensor compressor separated / Own problem of CCH

1. Judgment Method

Tini = Sump temperature when entering the CH operation delay condition

Tlast= Sump temperature when maintaining CH operation delay for two hours

Outside Air Temperature Sensor Value: Outside air temperature when maintaining CH operation delay for two hours

① Tlast - Tini < 2°C

② Tlast < Outside Air Temperature Sensor Value + 2°C

③ Outside Air Temperature Sensor Value < 30°C

If ①, ② and ③ are satisfied at the same time, then display E445.

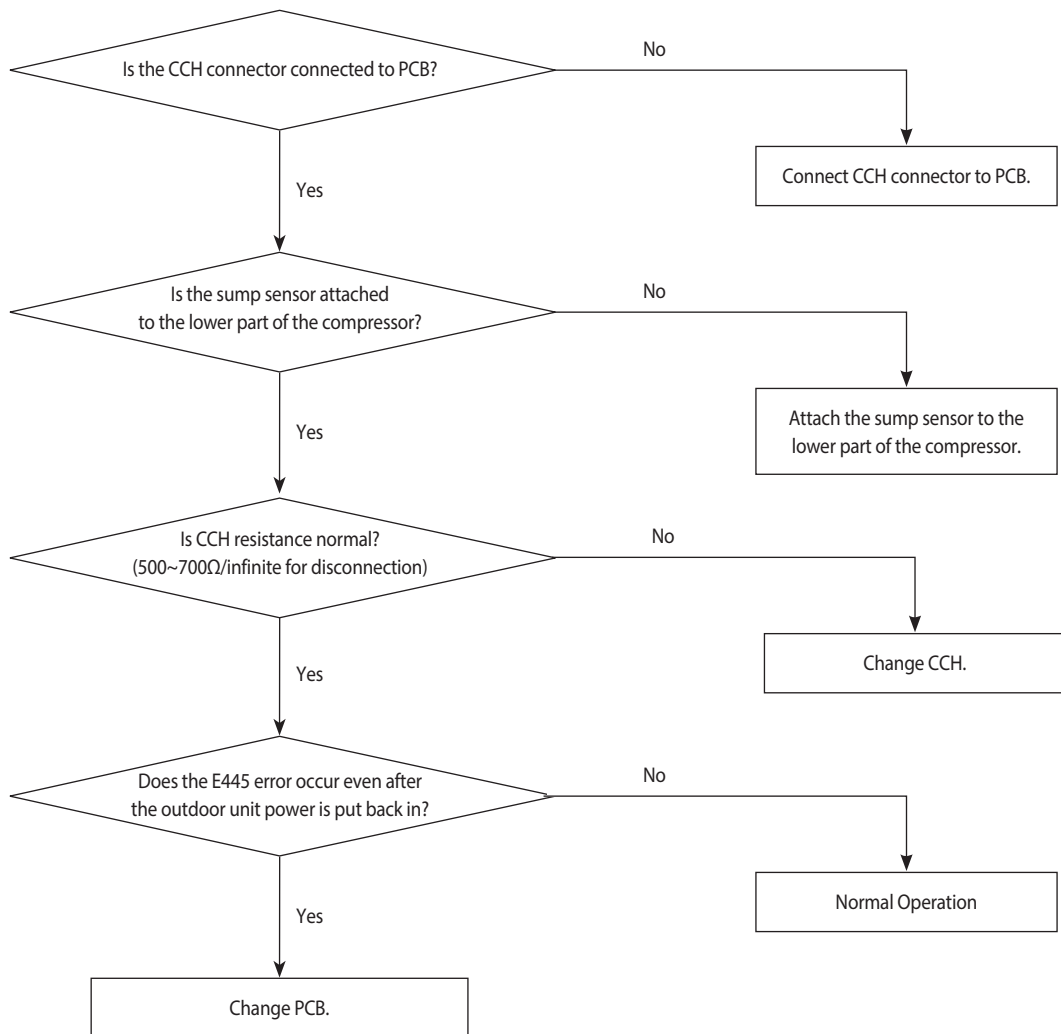

4-4-67 Fan starting error

Outdoor unit display	E446 (FAN PCB(FAN1)) E346 (FAN PCB(FAN2))
Judgment Method	<ul style="list-style-type: none"> · Startup, and then if the speed increase is not normally. · Detected by H/W or S/W
Cause of problem	<ul style="list-style-type: none"> · Compressor connection error · Defective Compressor · Defective PCB

1. Cause of problem

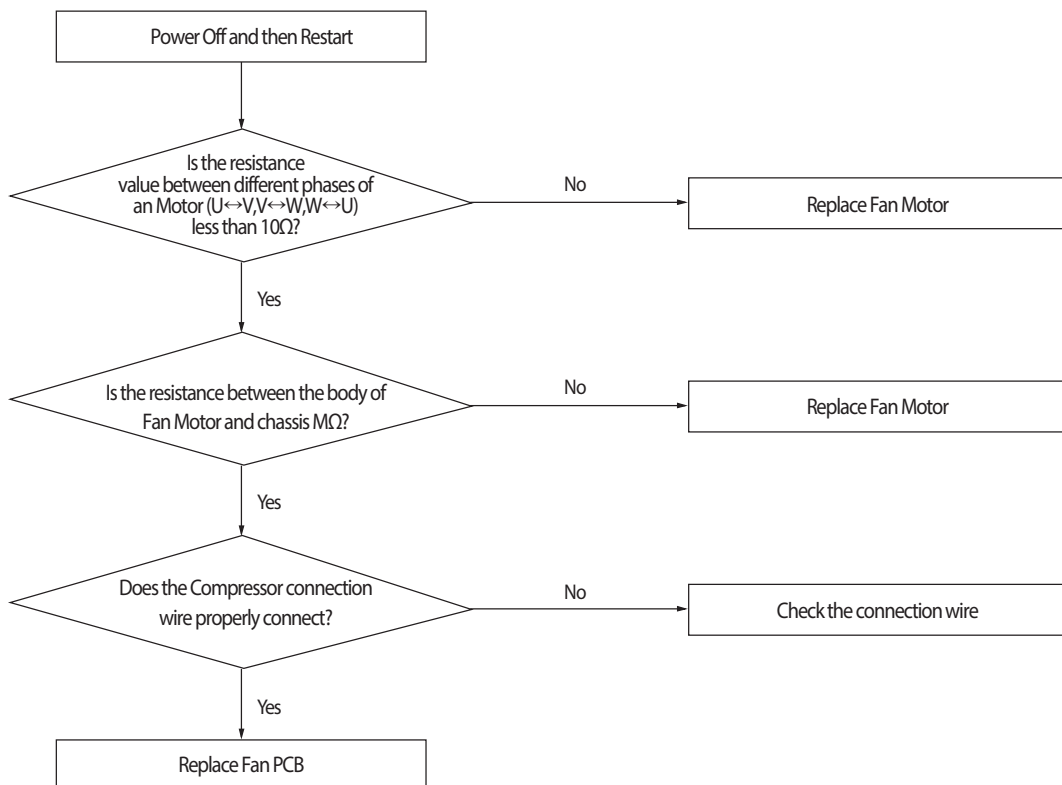

4-4-68 Fan lock error

Outdoor unit display	E448 (FAN PCB(FAN1)) E348 (FAN PCB(FAN2))
Indoor unit display	-
Criteria	· Is checked symptoms by phase current of Fan Motor.
Cause of problem	· Fan Motor connection error. · Defective Fan · Defective PCB

1. Cause of problem

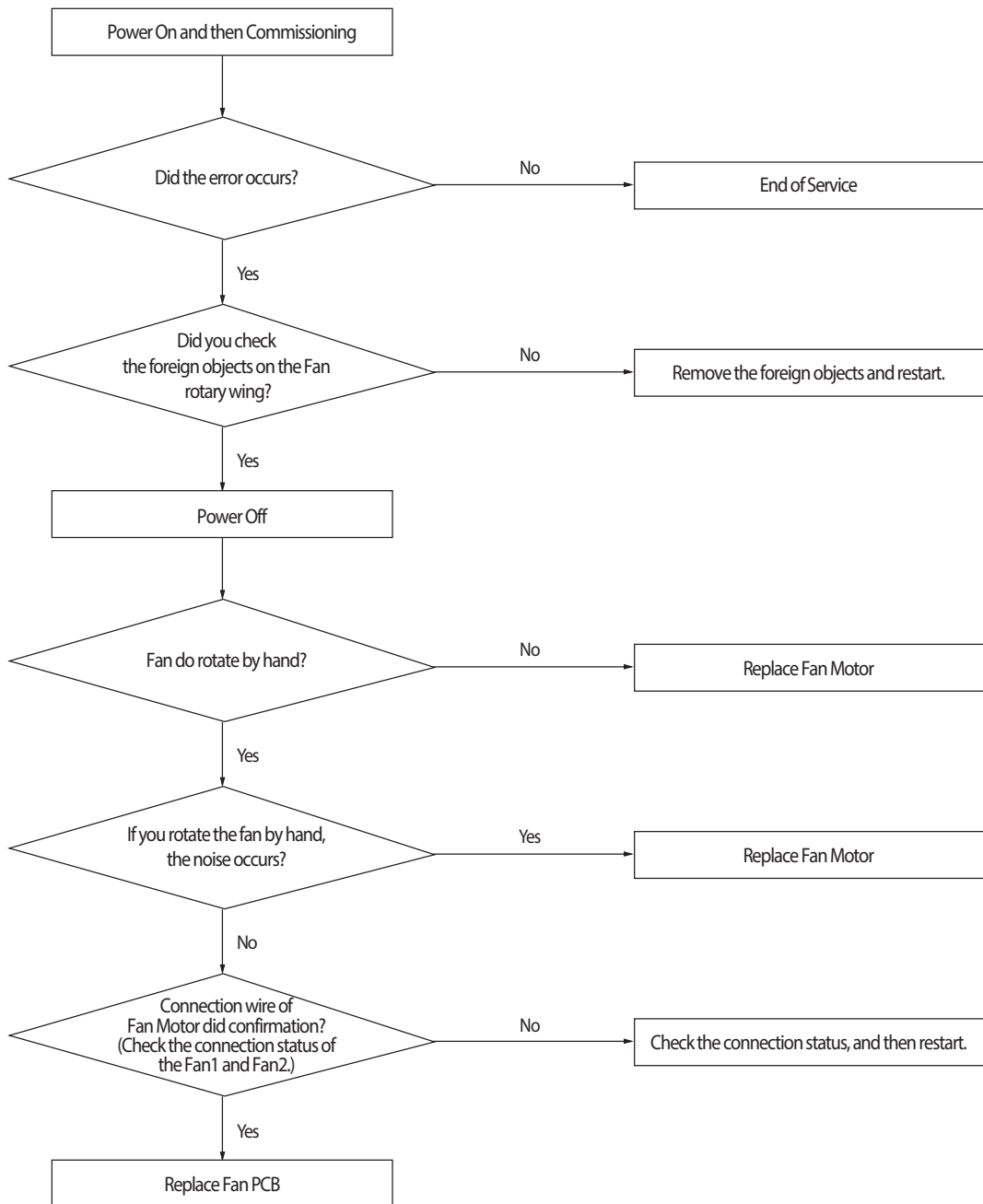

4-4-69 Momentary Blackout error

Outdoor unit display	E452																	
Indoor unit display	Duct, Cassette (1 way / 2 way / Mini-4 way)				4 Way Cassette Type				Wall mounted Type				Circular Cassette Type					
	Display LED																	
	1 way		⌚	🌀 or 🌀	📱 or 📱	Start /Stop	Defroster	Reser- -vation	Filter -clean	18 °C	21 °C	Reser- -vation	24 °C	27 °C	Sky- -Blue	Yellow- -Green	Blue	Red
	Blue	Yellow- -Green				🔌	💧	⌚	📱									
	2 way		🔌	🌀	📱	🔌	💧	⌚	📱	×	×	🔌	🔌	🔌	×	×	🔌	×
Green	Red																	
Criteria	· Momentary stop of compressor due to momentary blackout.																	
Cause of problem	· Momentary stop of compressor due to momentary blackout.																	

1. Precautions : Replace Hub PCB or Main Hub Connection wire.

4-4-70 Outdoor Fan Motor overheating

Outdoor unit display	<i>E453</i> (FAN PCB(FAN1)) <i>E353</i> (FAN PCB(FAN2))
Indoor unit display	· Overheating due to the internal sensor of the Fan Motor.
Criteria	· Defective connection wire · Defective Fan Motor · Defective PCB · Defective installation conditions
Cause of problem	· Fan Motor connection error. · Defective Fan · Defective PCB

1. Cause of problem

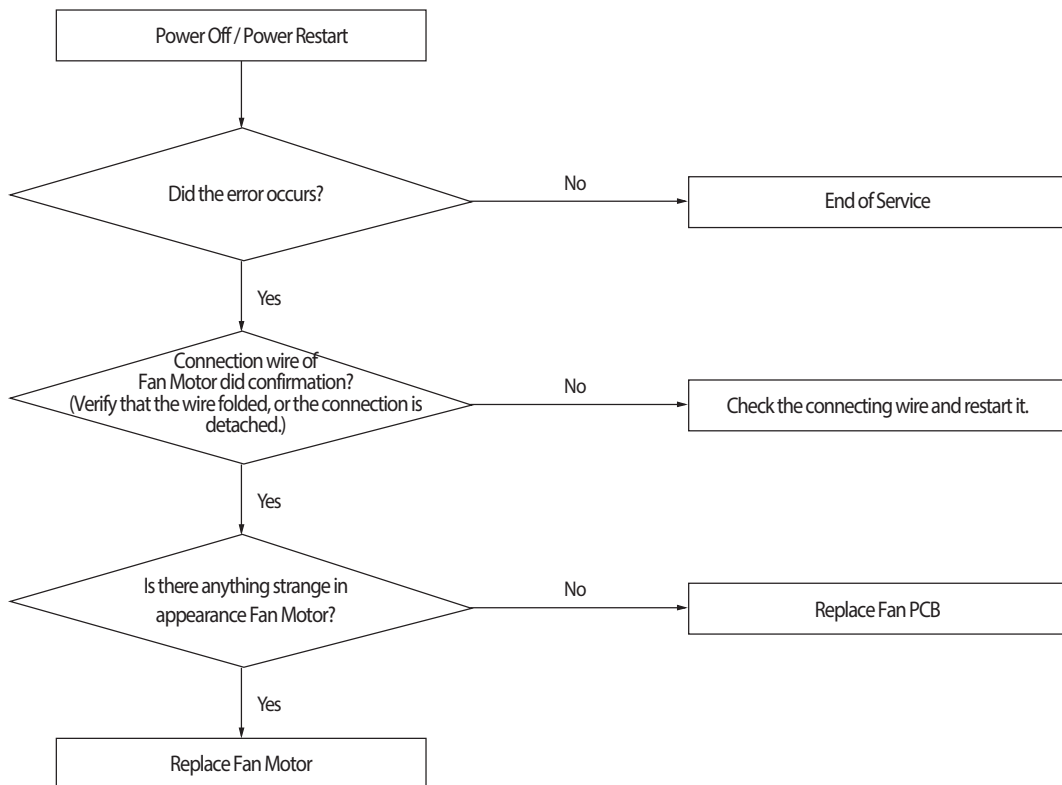

4-4-71 Outdoor Unit Fan Motor RPM Error

Outdoor unit display	E454
Indoor unit display	-
Criteria	• In case the number of the revolutions of the outdoor unit fan motor in motion is different by 100 rpm or more compared to the instructed value.
Cause of problem	• Outdoor unit fan motor constrained or faulty of operation

1. Inspection Method

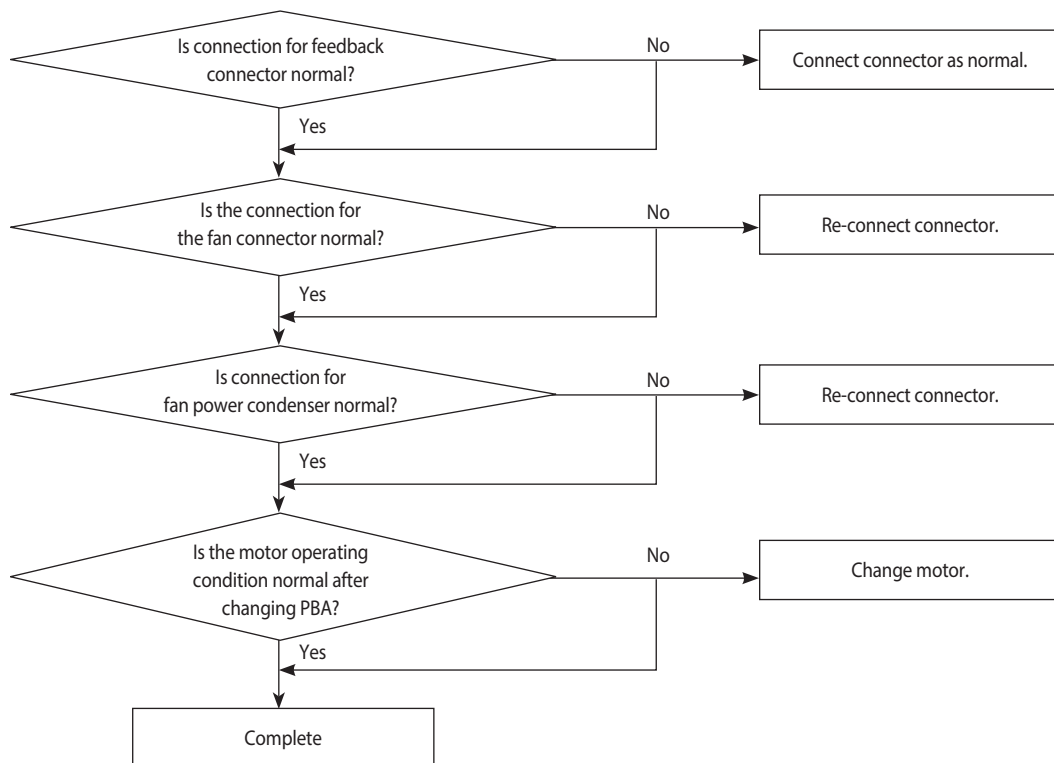

4-4-72 Fan IPM Overheat error

Outdoor unit display	E455 (FAN1 PCB) E355 (FAN2 PCB)
Criteria	· IPM internal temperature more than 85°C (E455, E355)
Cause of problem	· Heat sink and IPM assembly defective. · Defective heat sink cooling

1. Cause of problem

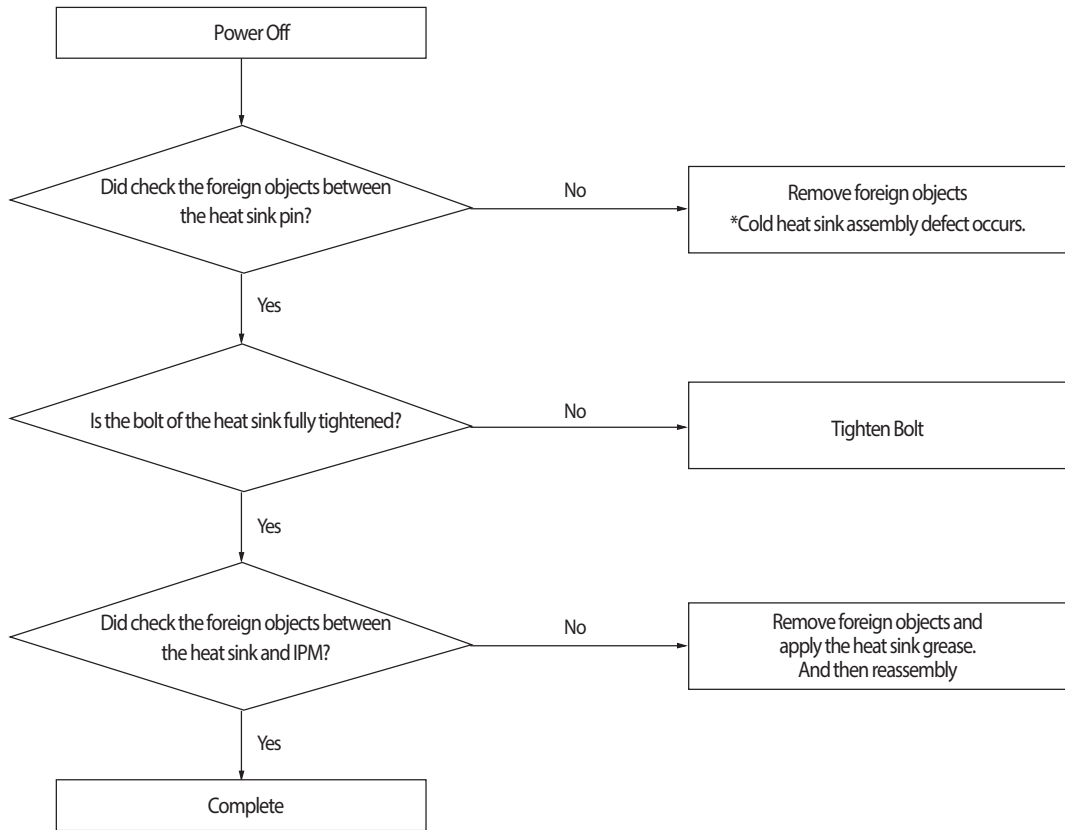

4-4-73 Over-Voltage Error of an Outdoor Fan Motor

Outdoor unit display	E456
Indoor unit display	-
Criteria	• When the current of an operating outdoor fan motor is more than 7A for 1 minute
Cause of problem	• Outdoor fan motor lock or defect • Occurs by abrupt start or overload

1. How to check
 - 1) Check if outdoor fan motor rotates or is locked
 - 2) If it is not locked, the above error occurs due to overload and signals by abnormal operation, and it indicates the overload status. Thus, it is not breakdown.
 - 3) Need to check if there is a problem with fan load status

4-4-74 Counter-Rotation Error of an Outdoor Fan Motor

Outdoor unit display	E457
Indoor unit display	-
Criteria	• When the rotational direction of an outdoor fan motor is counter-clockwise before operating
Cause of problem	• Due to wind that can run the fan counter-wise

1. How to diagnose
 - 1) Check if the start instruction of outdoor unit's fan is counter-clockwise
2. How to check
 - 1) It is a signal to protect a motor by checking the operational condition of the outdoor unit's fan motor without power so as not to operate it in counter-clockwise condition.
 - 2) Check if there is wind strong enough to force a fan to rotate counter-clockwise where the outdoor unit is installed.

4-4-75 E45B : Compressor Excess Current Error

Outdoor Unit Display	E45B
Indoor Unit Display	×(Operation) ●(Reservation) ●(Blast) ●(Filter) ×(Defrost)
Judgment Method	• Error displayed if the CT sensor value of the relevant compressor is 20A or more and is maintained for more than 3 seconds.
Special Cause	• Breakdown of compressor/Faulty CT sensor

1. Cause of problem

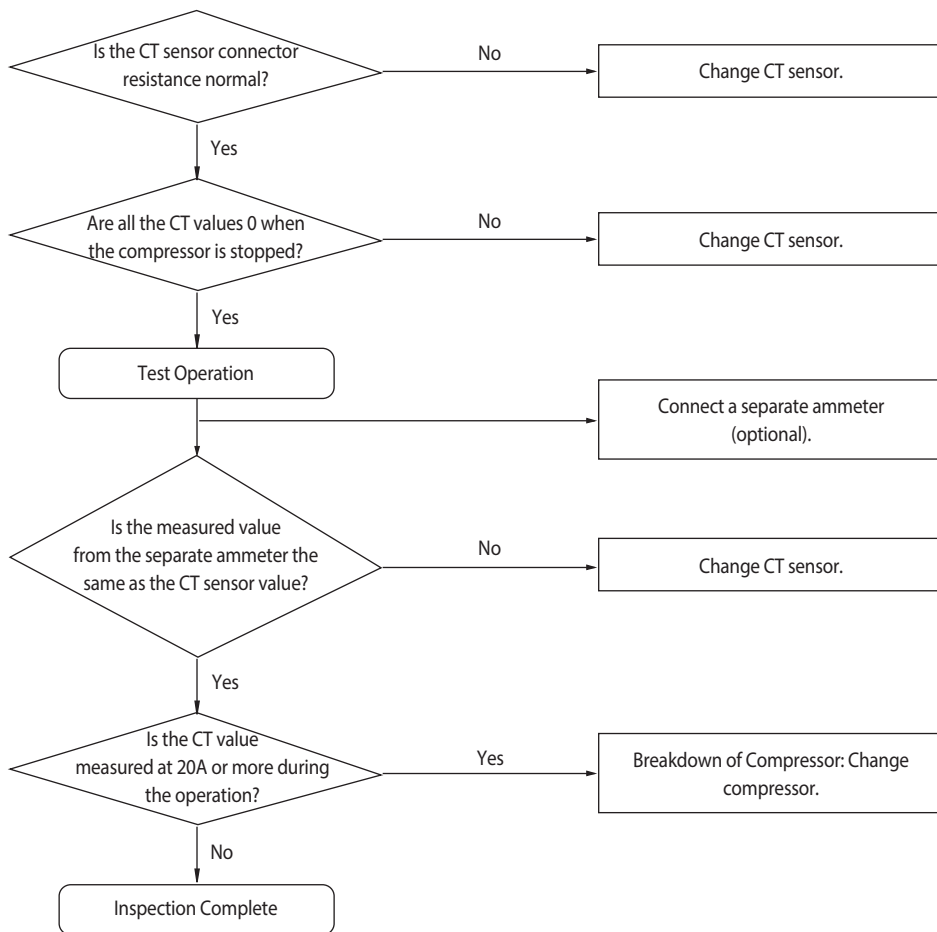

4-4-76 Compressor starting error

Outdoor unit display	E46 1 (INVERTER1 PCB) E36 1 (INVERTER2 PCB)
Judgment Method	<ul style="list-style-type: none"> Startup, and then if the speed increase is not normally. Detected by H/W or S/W.
Cause of problem	<ul style="list-style-type: none"> Compressor connection error Defective Compressor Defective PCB

1. Cause of problem

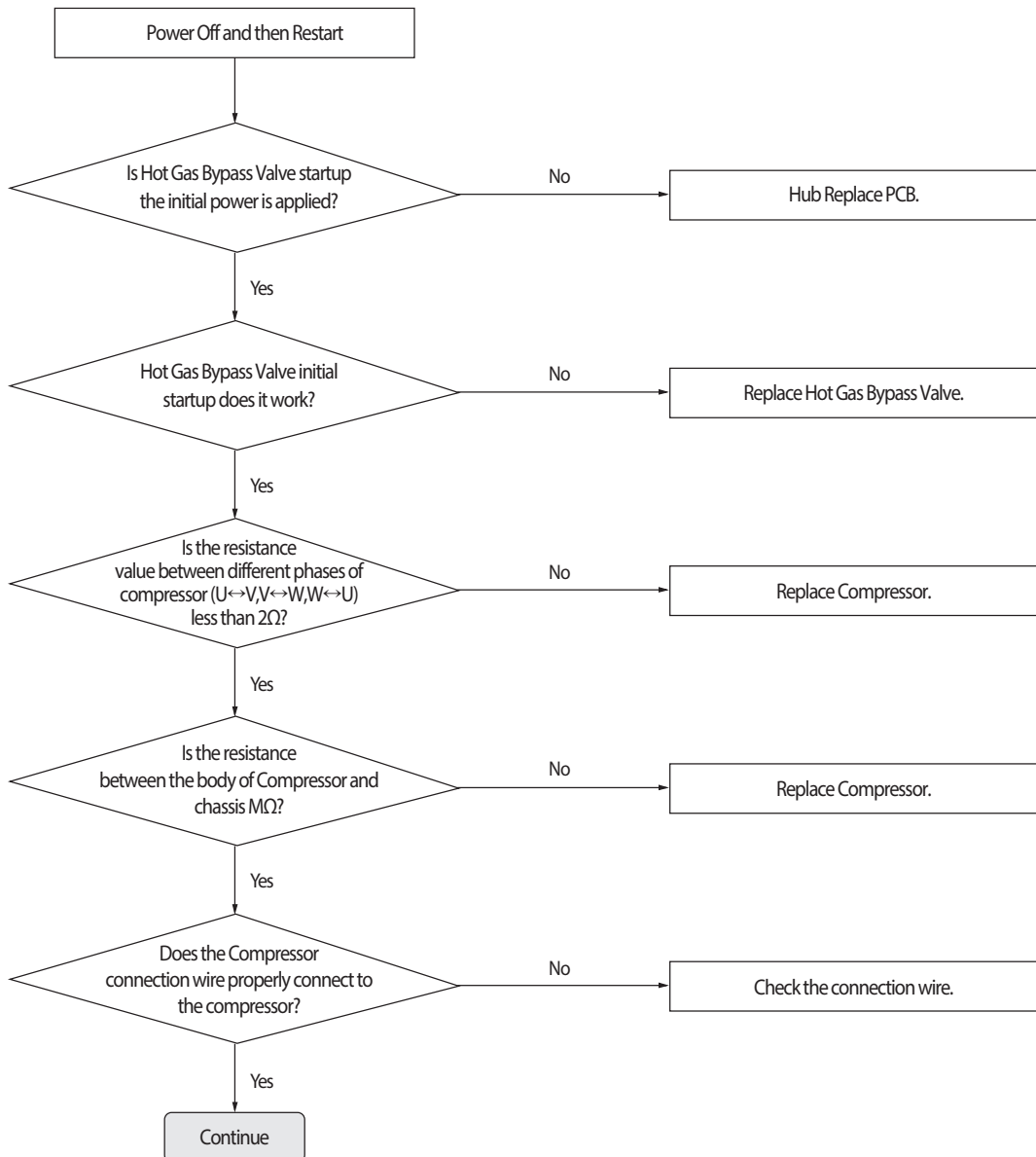

4-4-77 Inverter Overcurrent error

Outdoor unit display	<i>E464/E465</i> (INVERTER1 PCB) <i>E364/E365</i> (INVERTER2 PCB)	
Judgment Method	<ul style="list-style-type: none"> · Will occur if the overcurrent flowing in the IPM. · Detected by H/W or S/W 	
Cause of problem	<ul style="list-style-type: none"> · Installation defective · Comp. defective · PCB defective 	<ul style="list-style-type: none"> · Connection wire error · Motor defective

1. Cause of problem

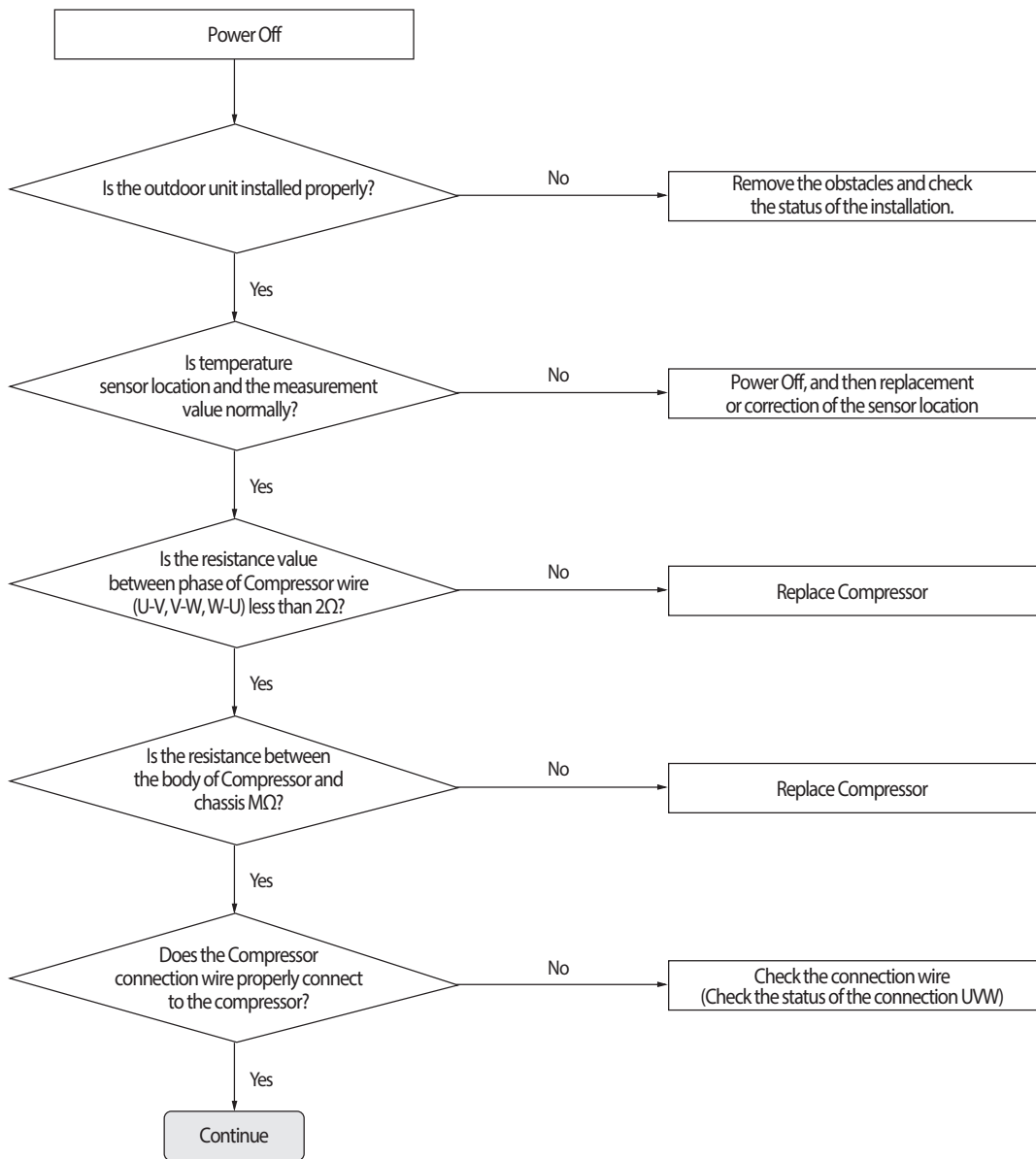

4-4-78 Overvoltage / Low voltage error

Outdoor unit display	E466 (INVERTER1 PCB) E366 (INVERTER2 PCB)
Judgment Method	<ul style="list-style-type: none"> · N-phase wiring error and EMI Fuse short. · DC-Link Overvoltage / Low voltage occurs.
Cause of problem	<ul style="list-style-type: none"> · Check the input wiring · EMI Fuse short

1. Cause of problem

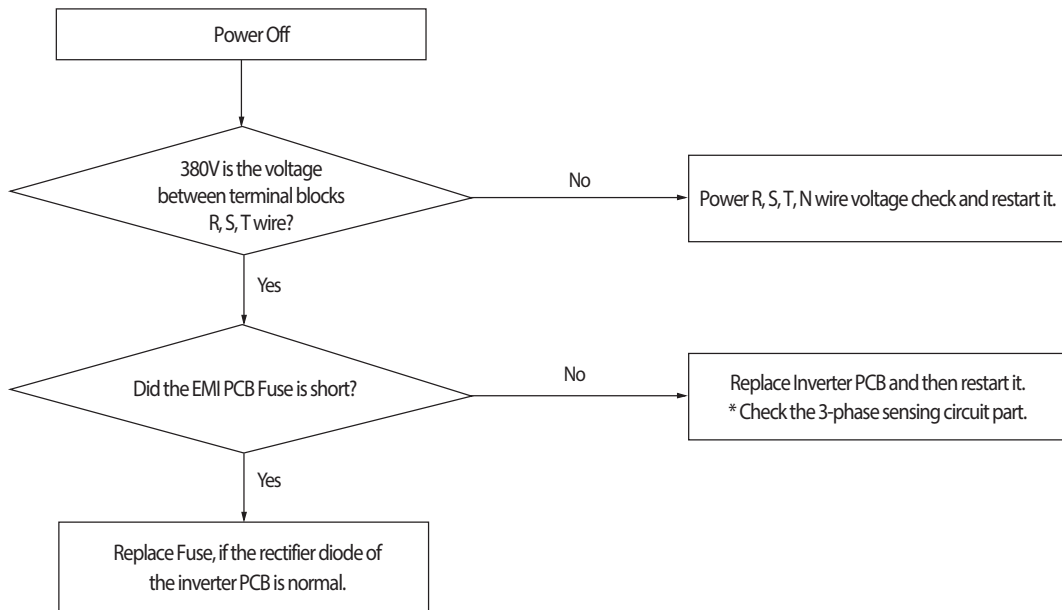

4-4-79 DC Link voltage sensor error

Outdoor unit display	<i>E469</i> (INVERTER1 PCB) <i>E369</i> (INVERTER2 PCB) <i>E496</i> (OUTDOOR FAN 1 PCB) <i>E396</i> (OUTDOOR FAN 2 PCB)
Judgment Method	· DC voltage detection : Judged as an error if the detected value is more than 2.8V or 0.2V less than
Cause of problem	· Input voltage defective · AC Power wiring error · Momentary Overvoltage / Low voltage occurs · PCB voltage sensing circuit defective

1. Cause of problem

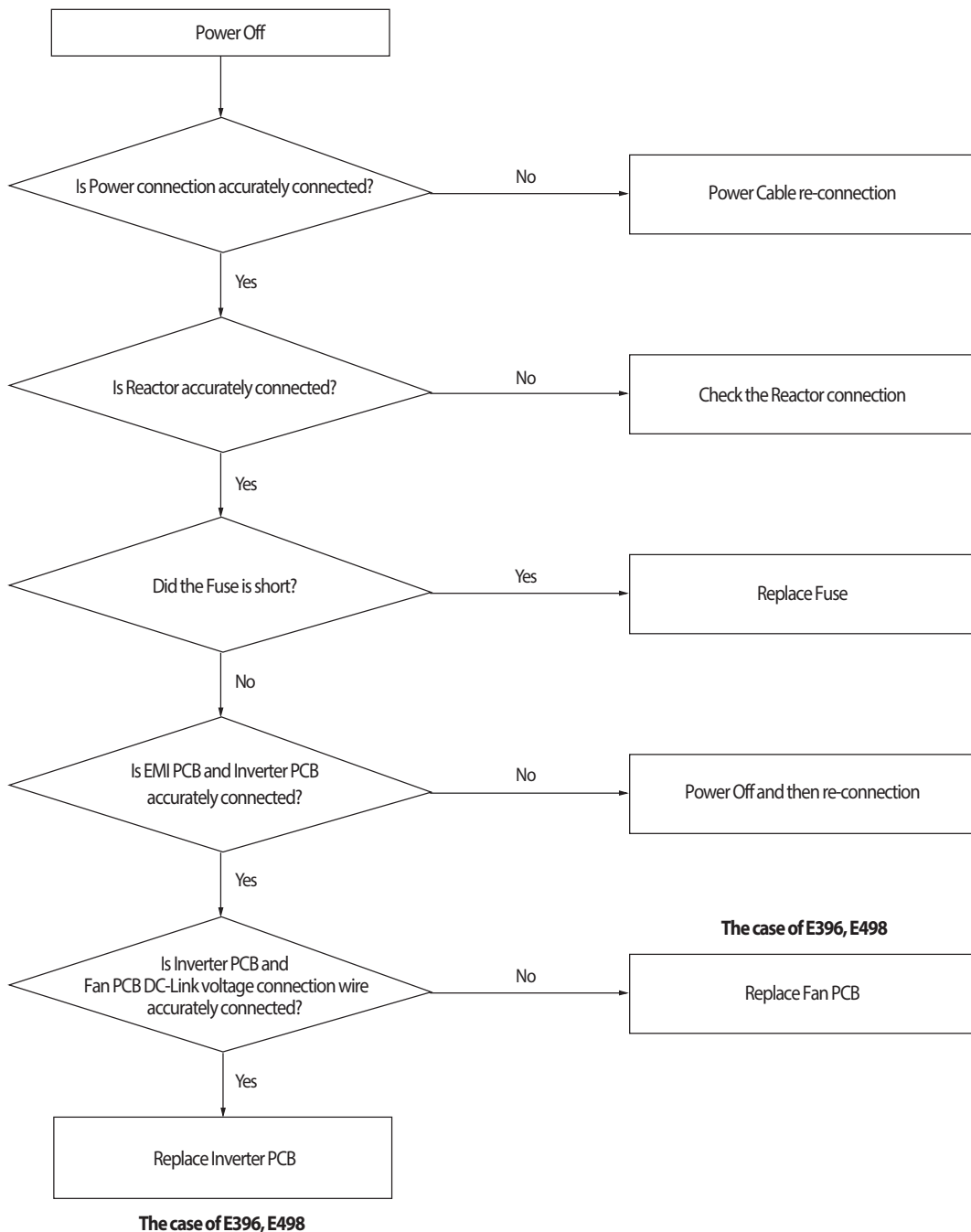

4-4-80 Liquid Compression Prevention Control

Outdoor Unit Display	E477
Indoor Unit Display	-
Judgment Method	• SUMP temperature decrease & DSH < 5°C 25 min.
Special Cause	• EVI EEV and super cooler, liquid bypass valve leakage, refrigerant overcharge, indoor unit EEV leakage, direct connection between indoor liquid pipe-gas pipe, faulty main EEV, and failure to operate compressor

1. Inspection Method

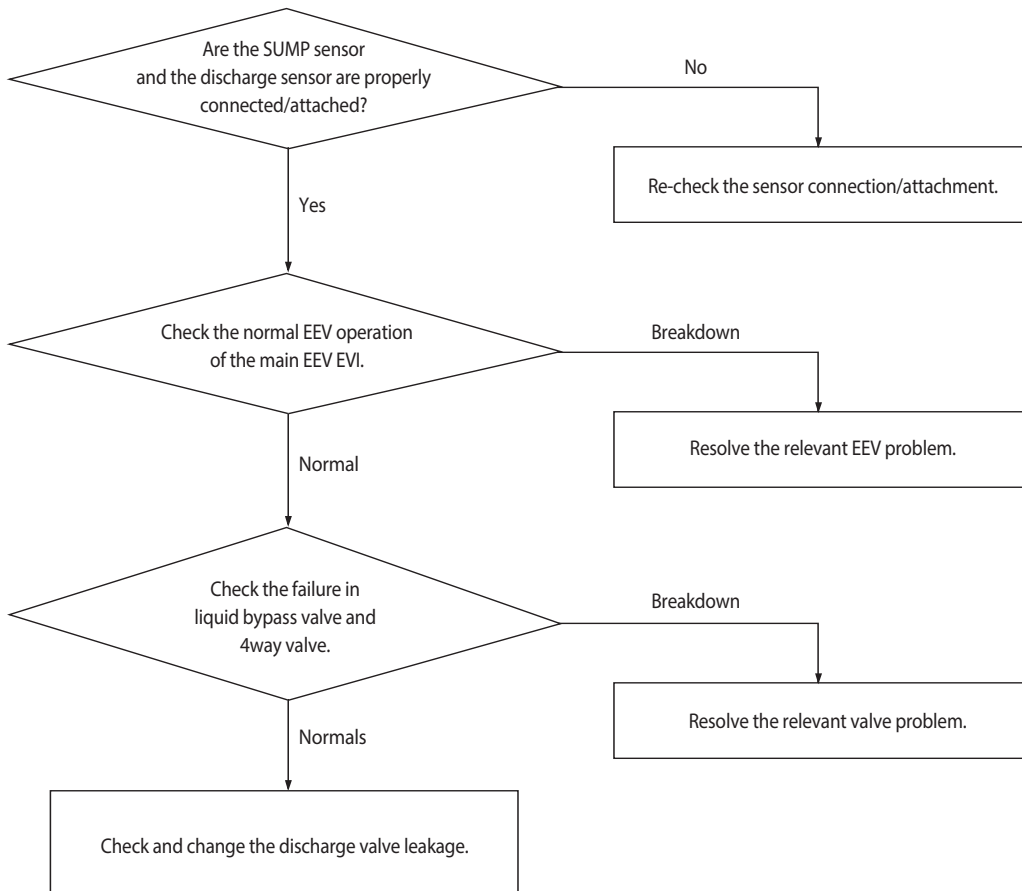

4-4-81 Fan Motor Overcurrent error

Outdoor unit display	<i>E478/E489</i> (FAN PCB(FAN1)) <i>E378/E389</i> (FAN PCB(FAN2))	
Judgment Method	<ul style="list-style-type: none"> · Occurs when overcurrent flows in the IPM. · Detected by H/W or S/W 	
Cause of problem	<ul style="list-style-type: none"> · Installation error · Defective Comp · Defective PCB 	<ul style="list-style-type: none"> · Connector error · Defective Motor

1. Cause of problem

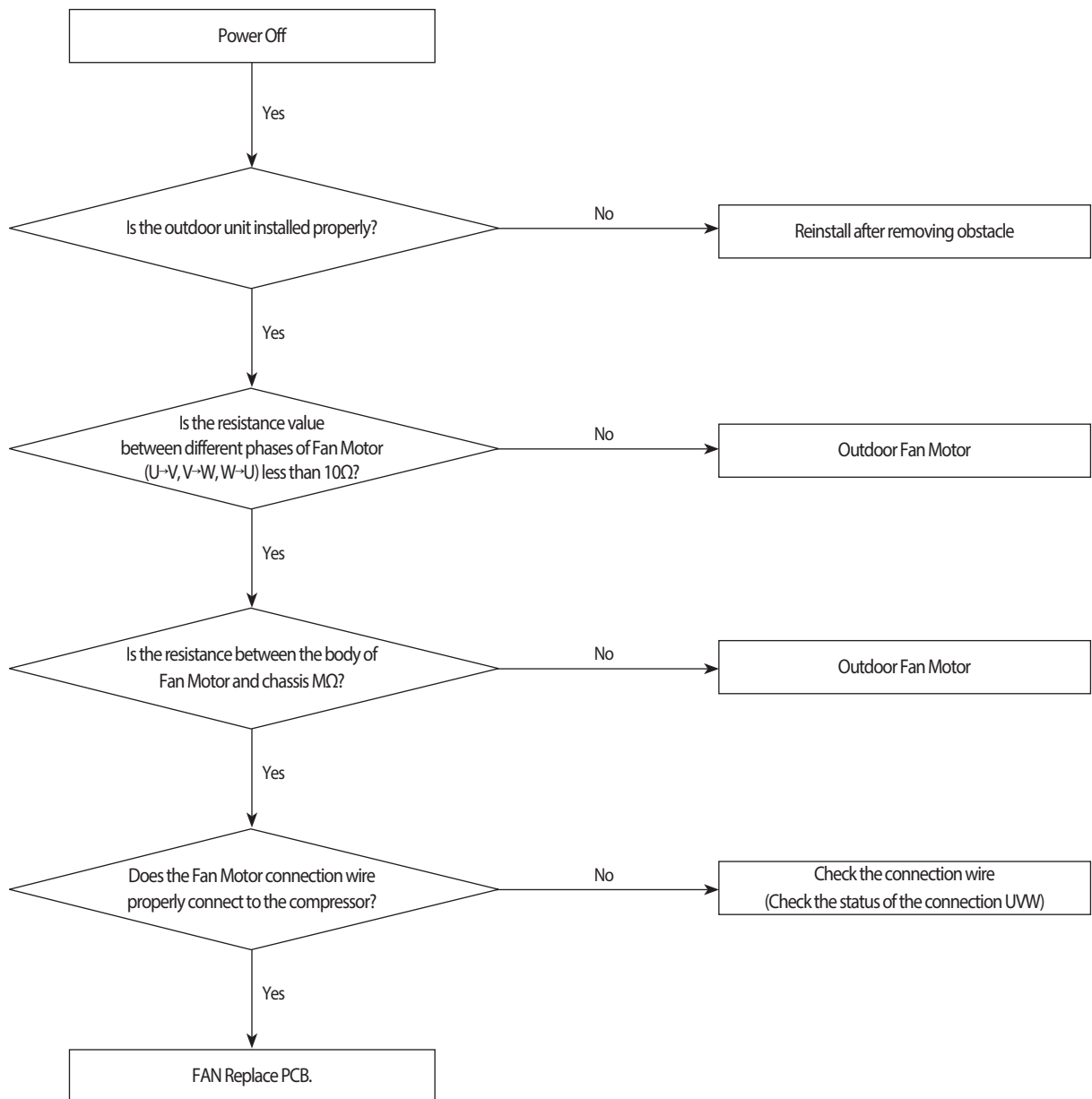

4-4-82 Input / Output Current sensor error

Outdoor unit display	<p><i>E485</i> INVERTER1 PCB(Input Current sensor)</p> <p><i>E385</i> INVERTER2 PCB(Input Current sensor)</p> <p><i>E468</i> INVERTER1 PCB(Output Current sensor)</p> <p><i>E368</i> INVERTER 2 PCB(Output Current sensor)</p> <p><i>E493</i> OUTDOOR FAN PCB (FAN1 Output Current sensor)</p> <p><i>E393</i> OUTDOOR FAN PCB (FAN2 Output Current sensor)</p>
Judgment Method	<ul style="list-style-type: none"> · Sensor Output detection : Judged as an error if the detected value is more than 2.8V or 0.2V less than
Cause of problem	<ul style="list-style-type: none"> · Input voltage defective · PCB voltage sensing circuit defective

1. Cause of problem

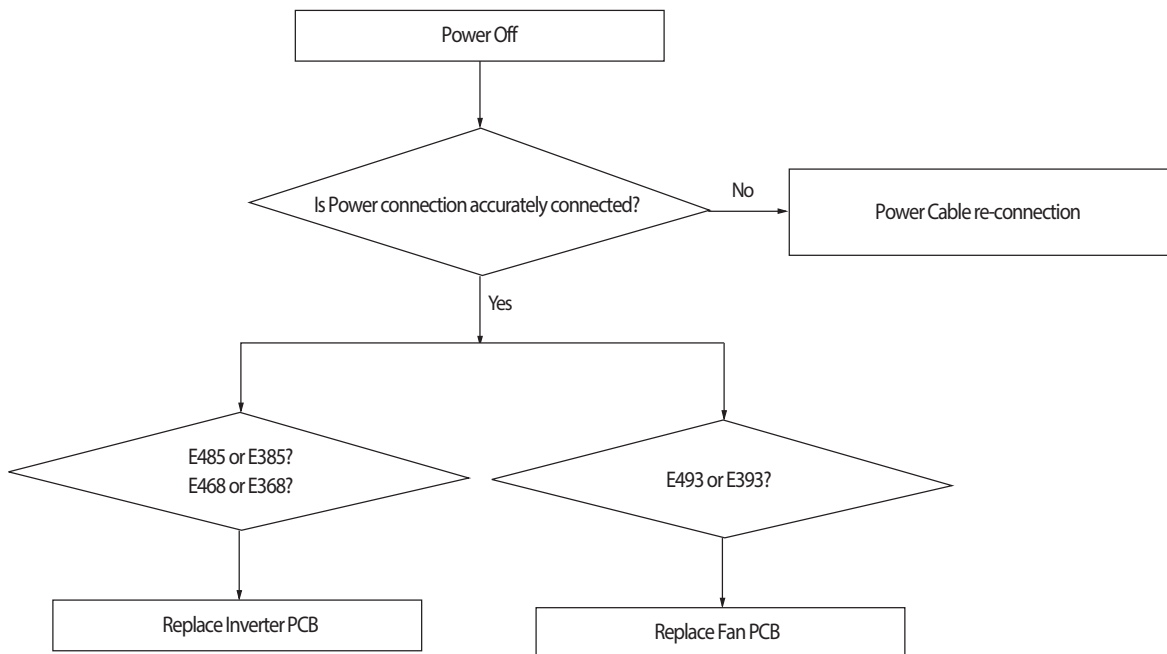

4-4-83 Outdoor Fan PCB Overvoltage / Low voltage error

Outdoor unit display	E486
Judgment Method	<ul style="list-style-type: none"> · N-phase wiring error and EMI Fuse short. · DC-Link Overvoltage / Low voltage occurs.
Cause of problem	<ul style="list-style-type: none"> · Check the input wiring · EMI Fuse short

1. Cause of problem

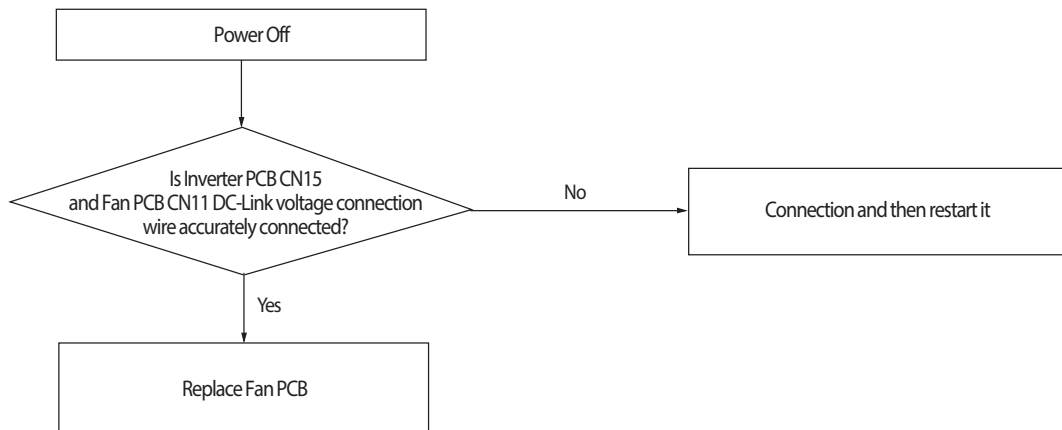

4-4-84 Hall IC(Fan) error

Outdoor Unit Display	E407 (FAN PCB(FAN1)) E307 (FAN PCB(FAN2))
Indoor Unit Display	-
Judgment Method	<ul style="list-style-type: none"> · Connection status error. · Hall IC wire disconnection. · Defective circuit parts and defective manufacturing. · Fan Motor defective.
Special Cause	<ul style="list-style-type: none"> · EVI EEV and super cooler, liquid bypass valve leakage, refrigerant overcharge, indoor unit EEV leakage, direct connection between indoor liquid pipe-gas pipe, faulty main EEV, and failure to operate compressor

1. Cause of problem

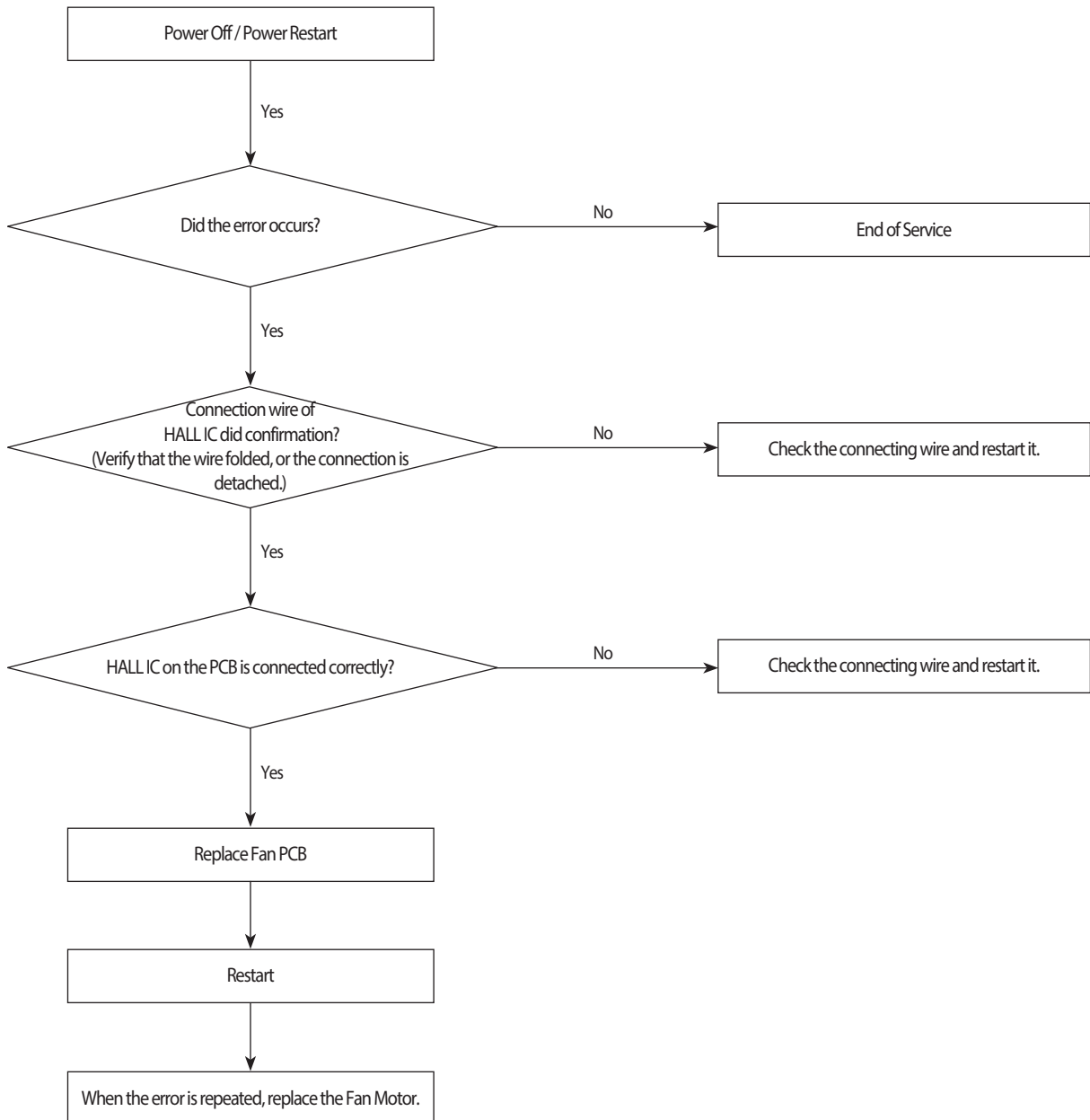

4-4-85 Inverter Overheat error

Outdoor unit display	E500 (INVERTER1 PCB) E400 (INVERTER2 PCB)
Judgment Method	· IGBT module internal temperature : 105°C more than (E500, E400)
Cause of problem	· Cooling Pin and the IGBT junction part assembly defective. · Refrigerant cooling heat sink and refrigerant piping assembly defective. · Assembled bolt defective.

Both end resistance values of IGBT module pin(8, 9 pin)

Temperature [°C]	NTC [ohm]	AD [V]	Temperature [°C]	NTC [ohm]	AD [V]
10	9000	2.58	100	500	0.55
20	6000	2.33	105	450	0.51
30	4000	2.03	110	380	0.44
40	3000	1.80	120	300	0.35
50	2000	1.47	130	250	0.30
60	1600	1.29	140	200	0.25
70	1200	1.07			
80	750	0.76			
90	650	0.68			

1. Cause of problem

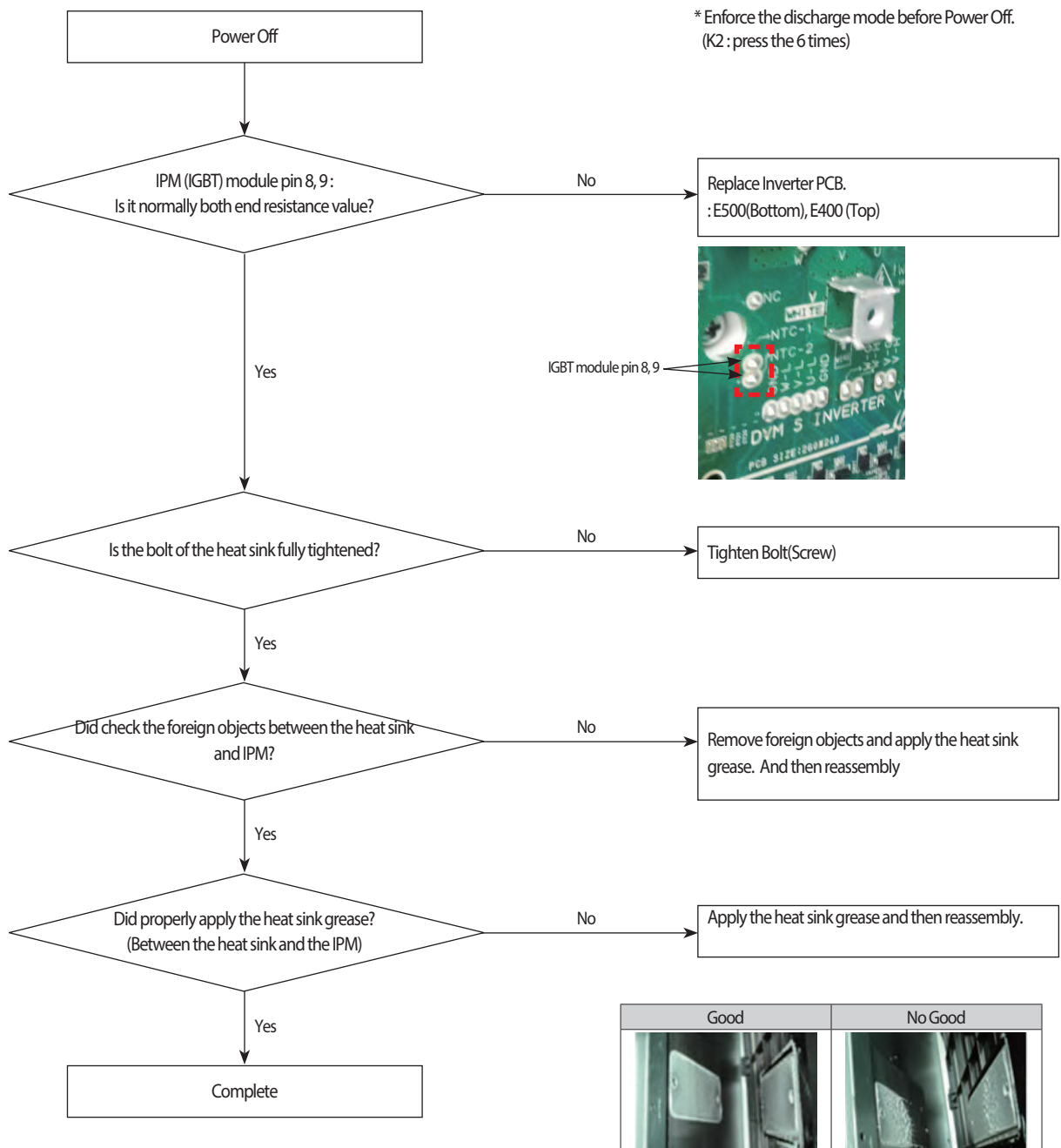

4-4-86 Model mismatching of Indoor unit.

Outdoor unit display	<i>E563</i>
Judgment Method	<ul style="list-style-type: none"> · Prior to July 2011, if the software version of the indoor unit. · Prior to July 2011, if the software version of the indoor unit.
Cause of problem	<ul style="list-style-type: none"> · Check the software version of the indoor unit. · Check whether the support of the indoor unit.

1. Cause of problem

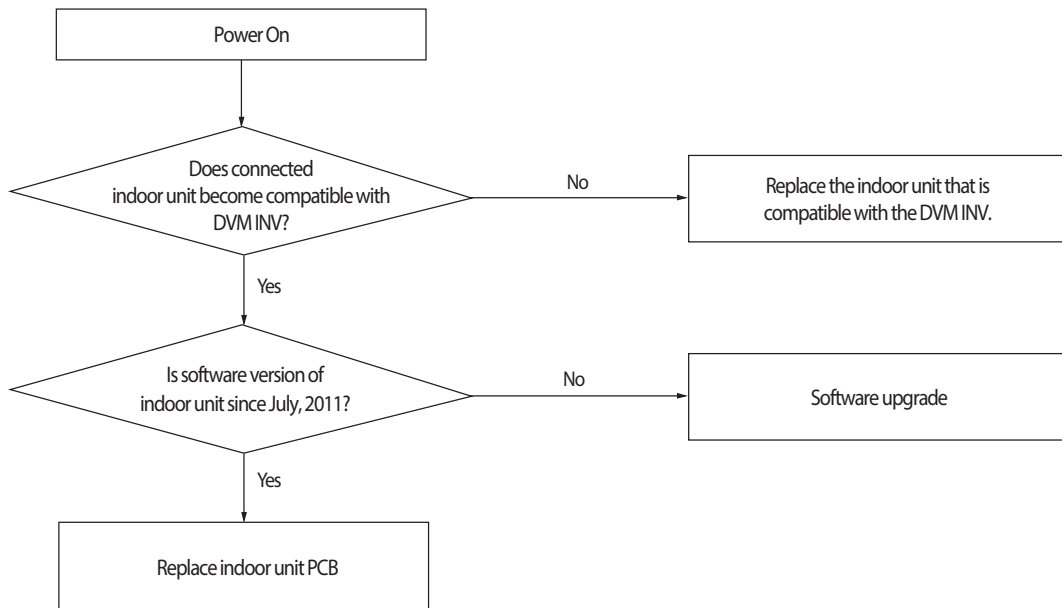

4-4-87 Breakdown of an EEV(1st)

1. How to diagnose

Detect only on cooling operation. (No detection during heating operation.)

During cooling operation, the temperature of the inlet or outlet ducts of heat exchanger is kept lower than 0°C for more than 20 minutes without cessation

2. How to check

1) Check if the wire of an electronic expansion valve is correctly connected to the PCB of indoor unit.

2) Check if the coil of an electronic expansion valve is correctly plugged into the main body.

3) Check if there is any rust on the surface of the coil of an electronic expansion valve with the naked eye, and then check the resistance between each terminal to find any wire breaking or short circuit.

4) Press the RESET KEY (K3) of the outdoor unit then see if the same error occurs.

- In case of closure problem, operate the indoor unit in which the error has occurred.

- In case of opening problem, please do not operate the indoor unit in which the error has occurred.

5) If there is no problem with the above checkup items, replace the electronic expansion valve of the troubled indoor unit.

- As an electronic expansion valve replacement is tricky work that requires collecting refrigerants in all systems, please make sure to check the above items before replacement.

4-4-87 Breakdown of an EEV closure

1. How to diagnose

1) During cooling operation (It must satisfy each of the following conditions for over 20minutes.)

Tair in - Teva in in $\geq 4^{\circ}\text{C}$	OK
Tair in - Teva out in $\geq 4^{\circ}\text{C}$	OK
Tcond, out - Tair, out $> 3^{\circ}\text{C}$	NO
Compressor in operation & Indoor unit operation & Thermo On	OK
Error details	EEV closure breakdown

2) During heating operation (It must satisfy each of the following conditions for over 20minutes.)

- When more than 2 indoor units are on Thermo On heating operating.
- When average high pressure is over 25 kg/cm²G
- 5 minutes after finishing Safety Start.
- Keep indoor units' $T(\text{Eva_IN}) < T(\text{Room}) + 3^{\circ}\text{C}$ and $T(\text{Eva_Out}) < T(\text{Room}) + 3^{\circ}\text{C}$ condition for more than five minutes.

2. How to check

- 1) Check if the wire of an electronic expansion valve is correctly connected to the PCB of indoor unit.
- 2) Check if the coil of an electronic expansion valve is correctly plugged into the main body.
- 3) Check if there is any rust on the surface of the coil of an electronic expansion valve with the naked eye, and then check the resistance between each terminal to find any wire breaking or short circuit.
- 4) Press the RESET KEY (K3) of the outdoor unit then see if the same error occurs.
 - In case of closure problem, operate the indoor unit in which the error has occurred.
 - In case of opening problem, please do not operate the indoor unit in which the error has occurred.
- 5) If there is no problem with the above checkup items, replace the electronic expansion valve of the troubled indoor unit.
 - As an electronic expansion valve replacement is tricky work that requires collecting refrigerant in all systems, please make sure to check the above items before replacement.

4-4-88 Electronic expansion valve closing malfunction (2nd stage)

Outdoor unit display	1 st stage inspection: <i>P702</i> (only displays on outdoor unit) 2 nd stage inspection: <i>E 152</i> ↔ <i>A</i> ^{x x x} (x x x: error occurred)
Indoor unit display	×(Operation) ●(Reservation) ●(Blast) ●(Filter) ×(Defrost)
Criteria	• Please refer to determining method below
Cause of problem	• Faulty indoor unit electronic expansion valve action (valve will not open) • Address setup error in indoor unit (RAC) using EEV KIT

1. Inspection Method

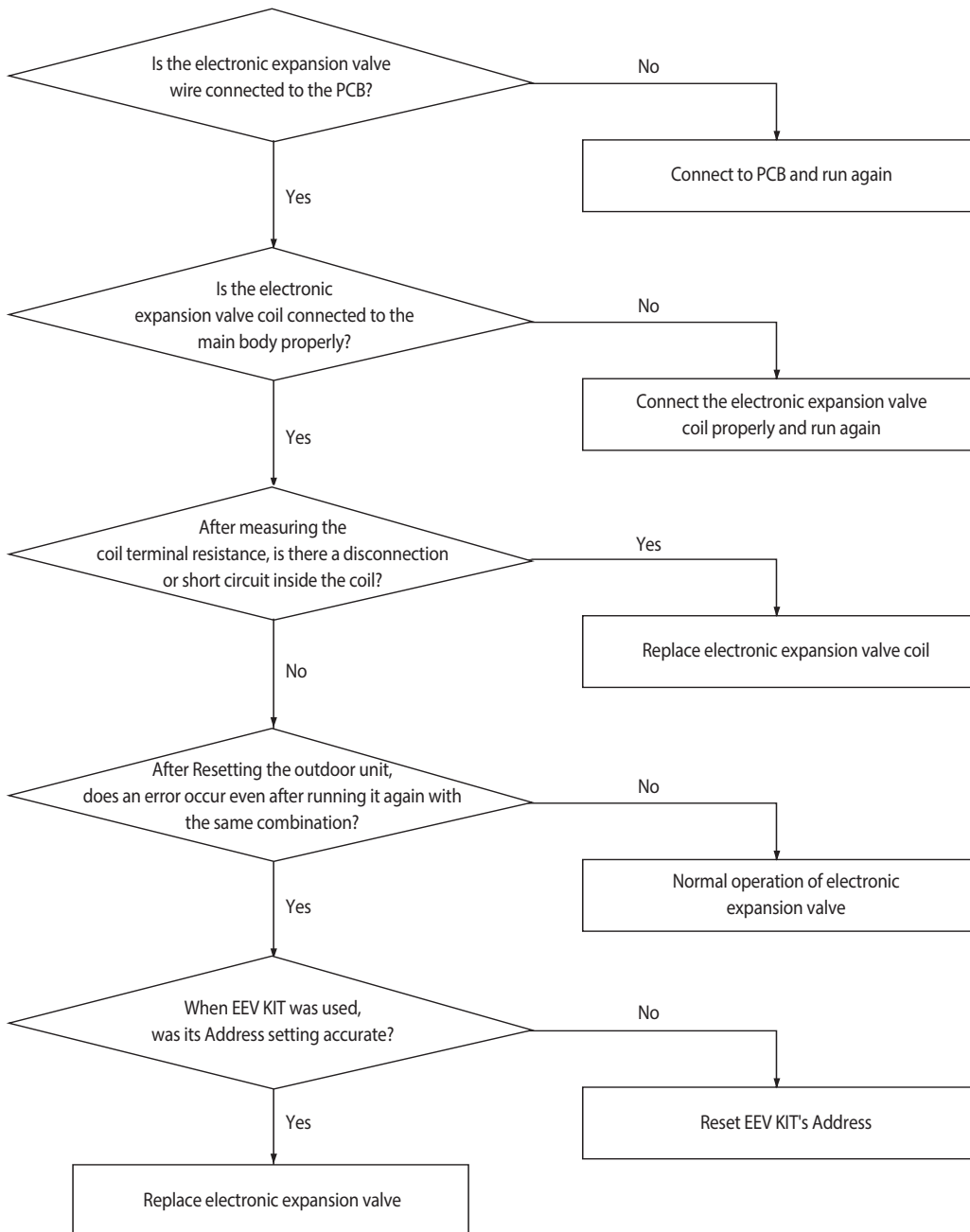

4-4-89 Electronic expansion valve opening malfunction (2nd stage)

Outdoor unit display	1 st stage inspection: <i>P703</i> (only displays on outdoor unit) 2 nd stage inspection: <i>E151</i> ↔ <i>A</i> ^{x x x} (x x x: indoor unit address of where error occurred)
Indoor unit display	×(Operation) ●(Reservation) ●(Blast) ●(Filter) ×(Defrost)
Criteria	• Please refer to determining method below
Cause of problem	• Faulty indoor unit electronic expansion valve action (refrigerant will leak into the stopped indoor unit) • Address setup error in indoor unit (RAC) using EEV KIT

1. Inspection Method

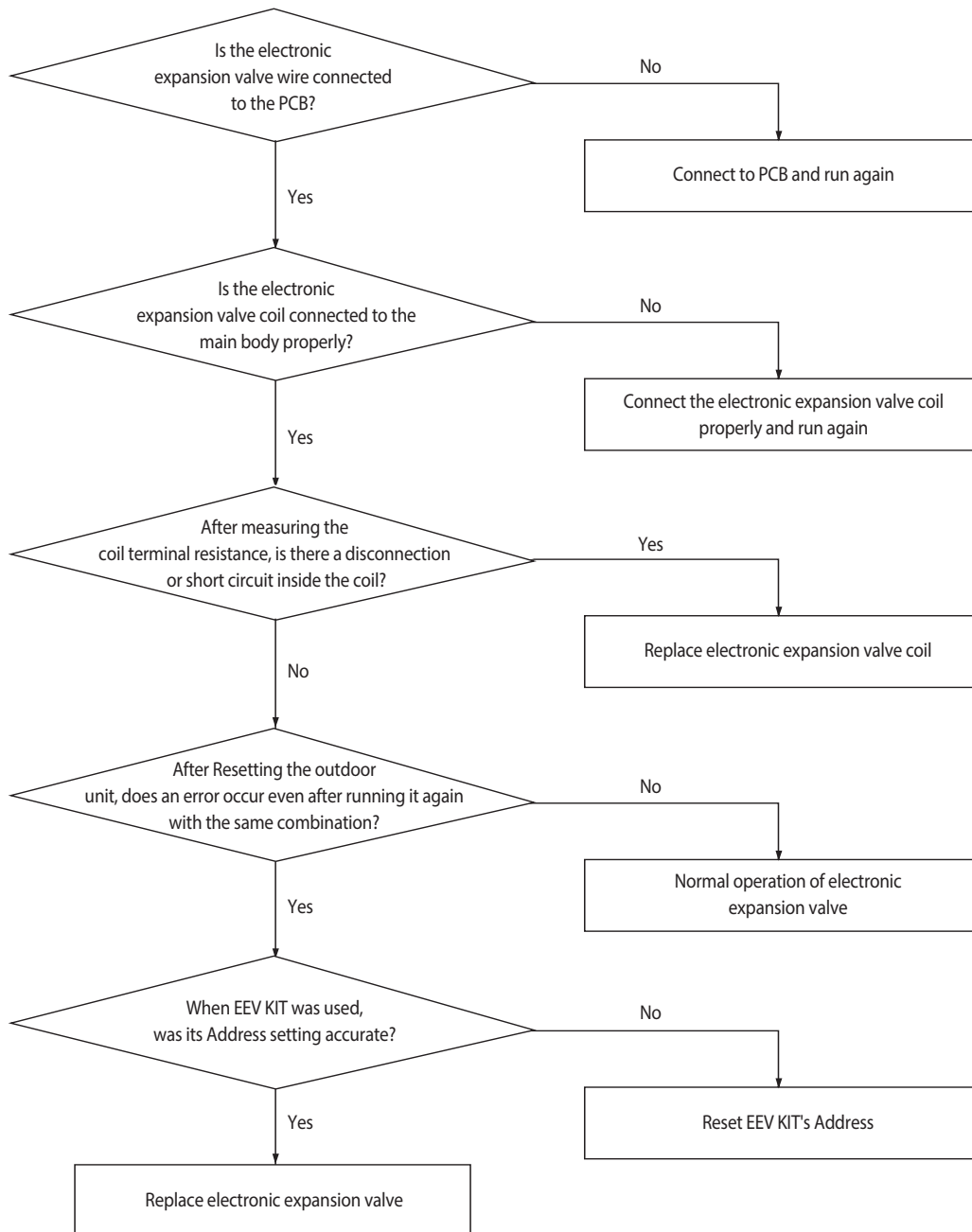

4-4-90 Hydro Unit Water In Temperature Sensor Error (Open/Short)

Outdoor unit display	<i>E901</i> → <i>A</i> XXX (xxx : Address of Indoor Unit that error occurred)
Indoor unit display	<i>E901</i>
Criteria	• Refer to the judgment method below.
Cause of problem	• Hydro Unit Water In Temperature Sensor Open/Short error of xxx

1. Inspection Method

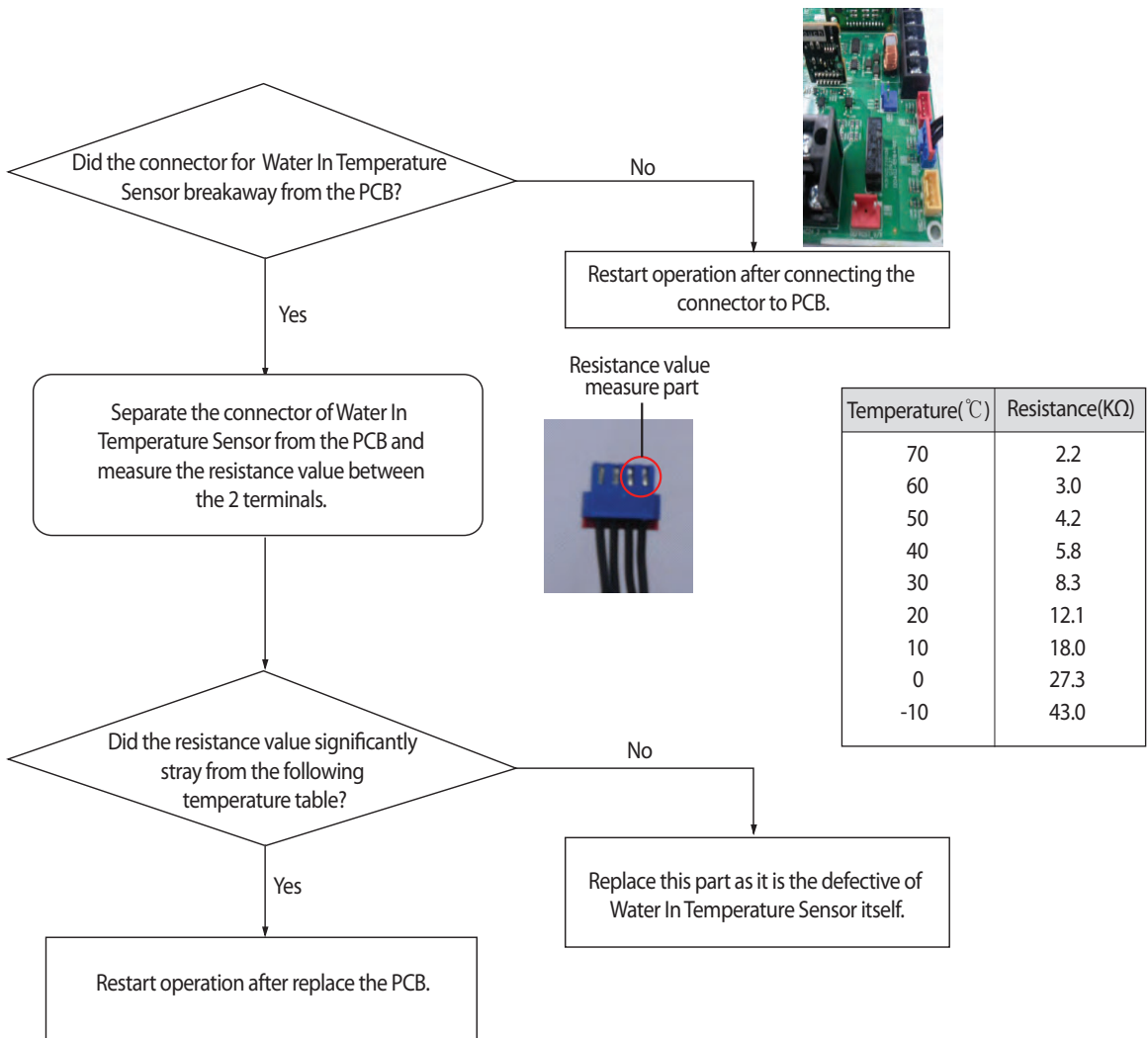

4-4-91 Hydro Unit Water Out Temperature Sensor Error (Open/Short)

Outdoor unit display	<i>E902</i> → <i>A</i> XXX (xxx : Address of Indoor Unit that error occurred)
Indoor unit display	<i>E902</i>
Criteria	• Refer to the judgment method below.
Cause of problem	• Hydro Unit Water Out Temperature Sensor Open/Short error of xxx

1. Inspection Method

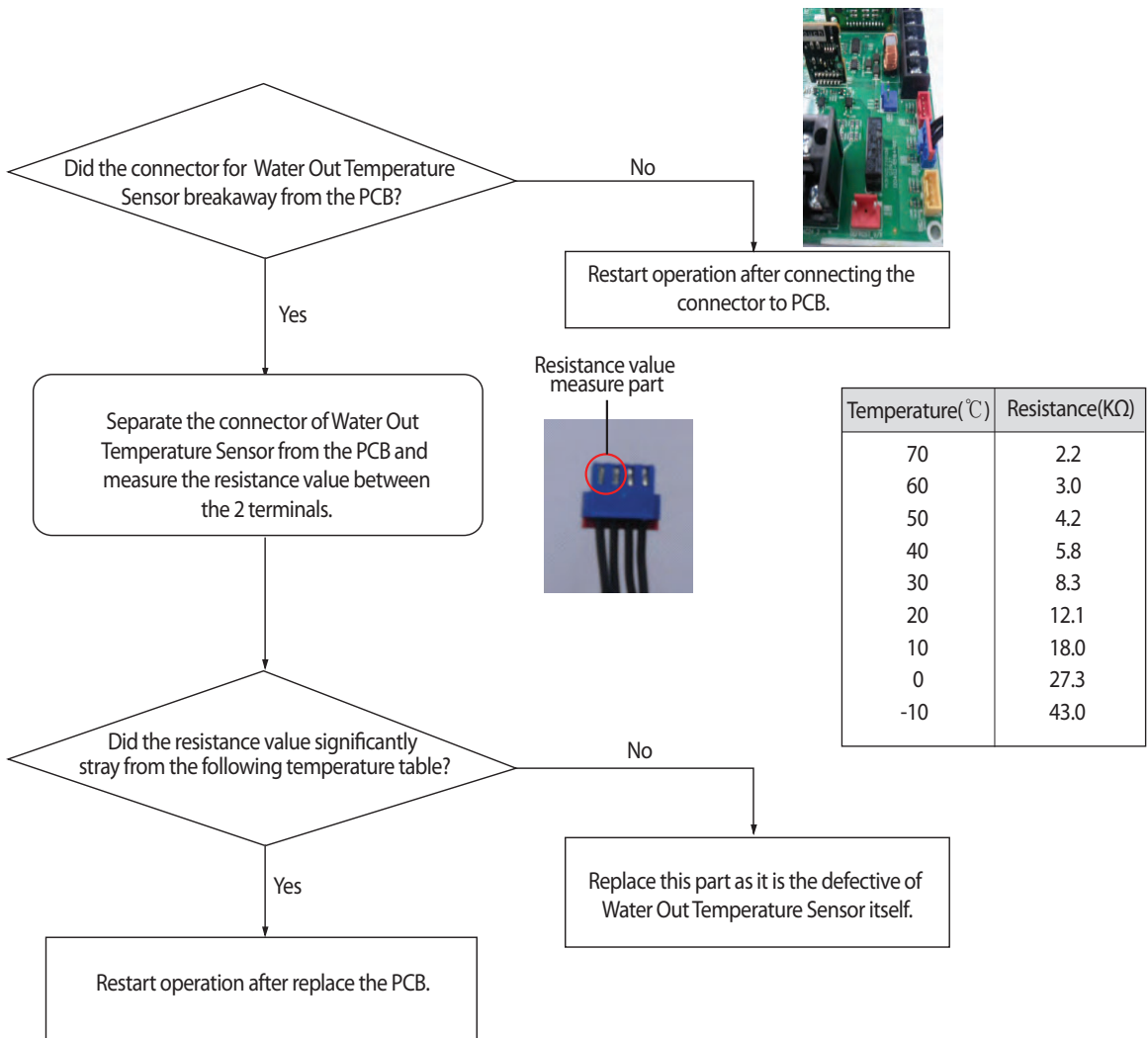

4-4-92 Hydro Unit Water Tank Temperature Sensor Error (Open/Short)

Outdoor unit display	E904 → A XXX (xxx : Address of Indoor Unit that error occurred)
Indoor unit display	E904
Criteria	• Refer to the judgment method below.
Cause of problem	• Hydro Unit Water Tank Temperature Sensor Open/Short error of xxx

1. Inspection Method

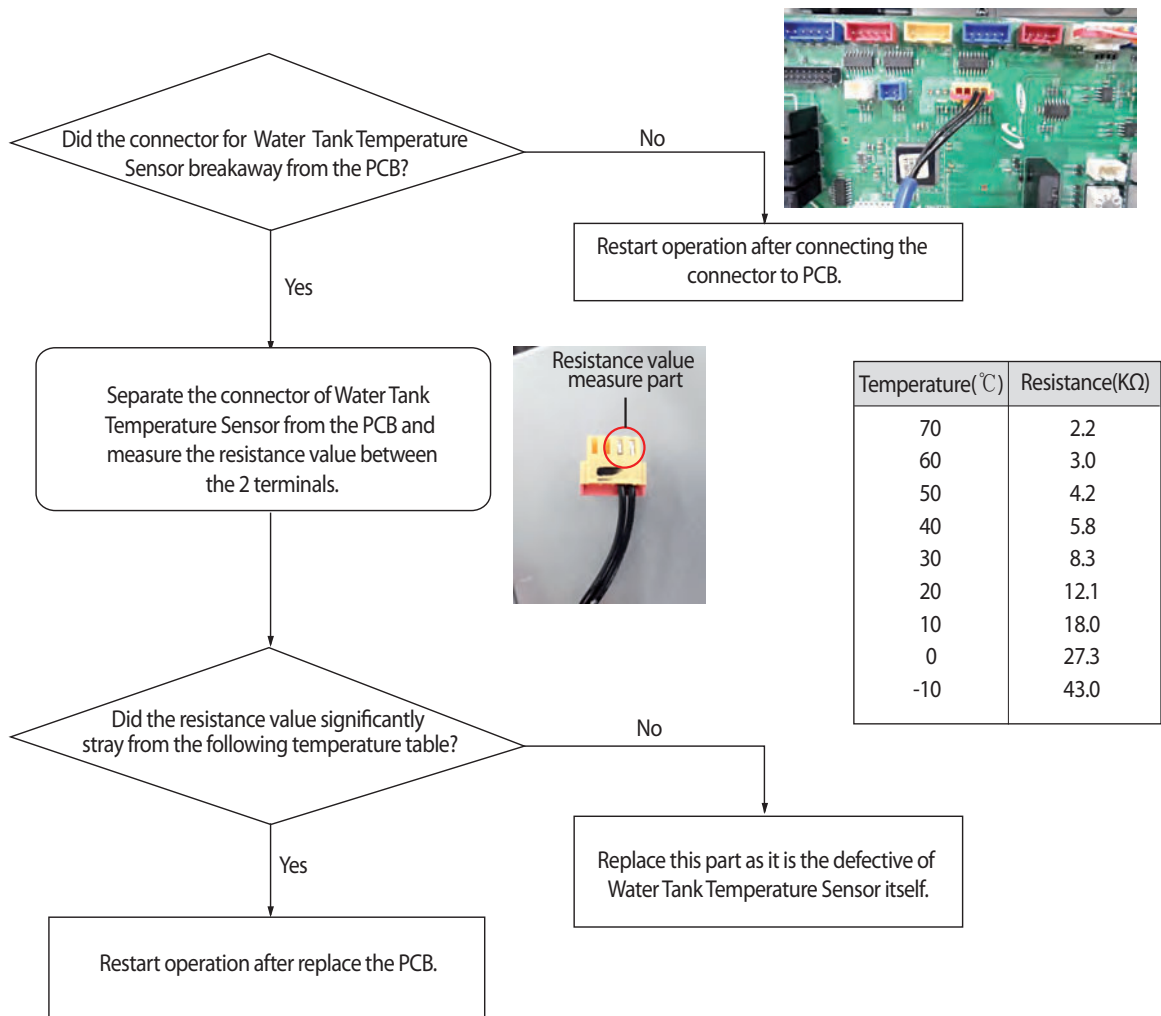

4-4-93 Emergency Error (Check the Water Piping Equipment)

Outdoor unit display	<i>E907</i> → <i>A</i> XXX (xxx : Address of Indoor Unit that error occurred)
Indoor unit display	<i>E907</i>
Criteria	• More than 2 hours Heating / Hot water operation : Water In temperature does not change more than 5 °C .
Cause of problem	• Heating / Hot water operation of xxx Hydro Unit : There is no change in the water temperature.

1. Inspection Method

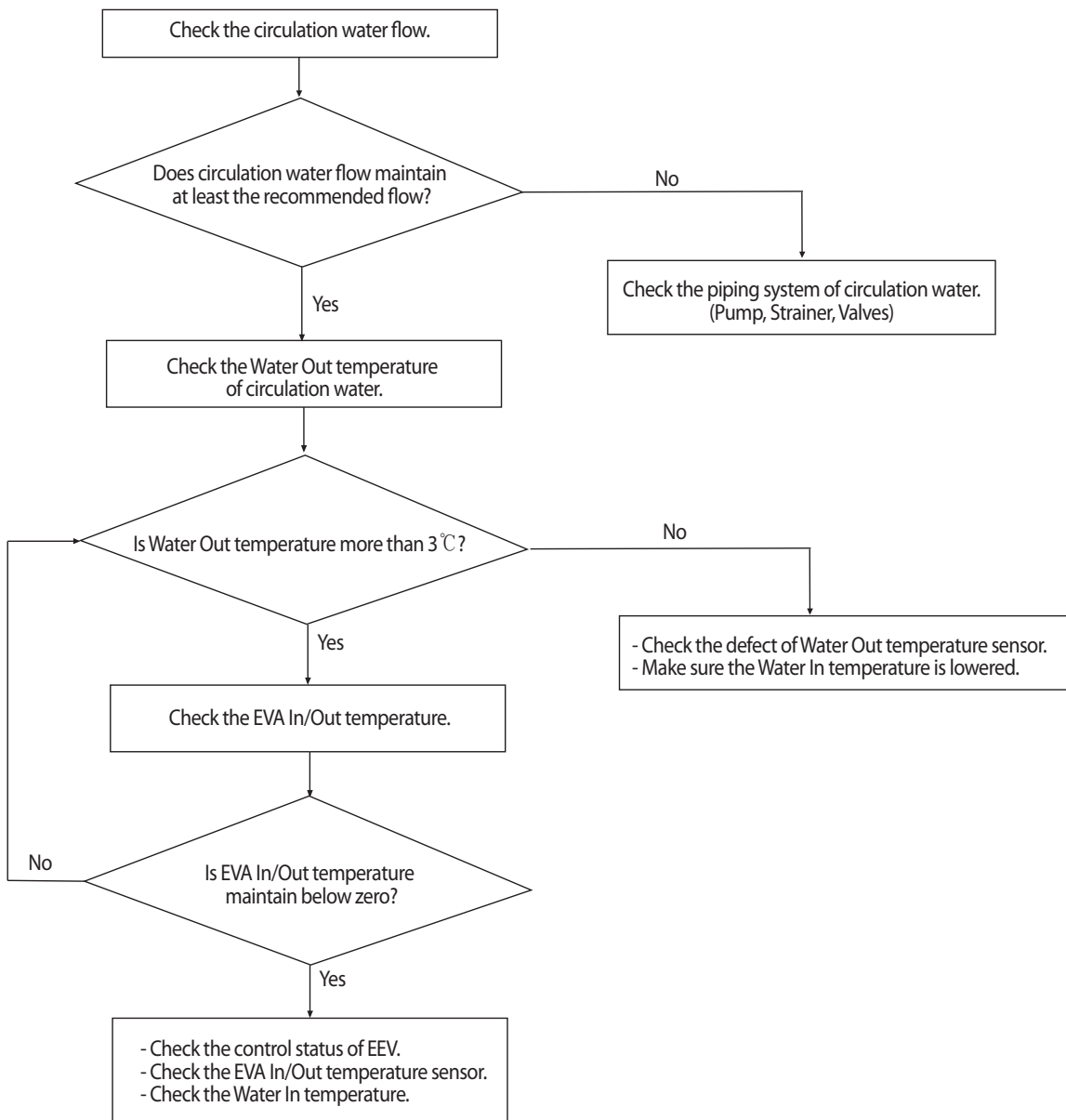

4-4-94 Error to prevention from freezing and bursting of Heat Exchanger

Outdoor unit display	<i>E908/E909</i> → <i>A</i> XXX (xxx : Address of Indoor Unit that error occurred))
Indoor unit display	<i>E908/E909</i> (Repeats six times)
Criteria	. Water Out temperature is less than 3 °C . . EVA In/Out maintains the temperature below zero. (* During the cooling operation, can be detected)
Cause of problem	• Low Heat Exchanger internal temperature of xxx Hydro Unit. (Low flow / Low water temperature)

1. Inspection Method

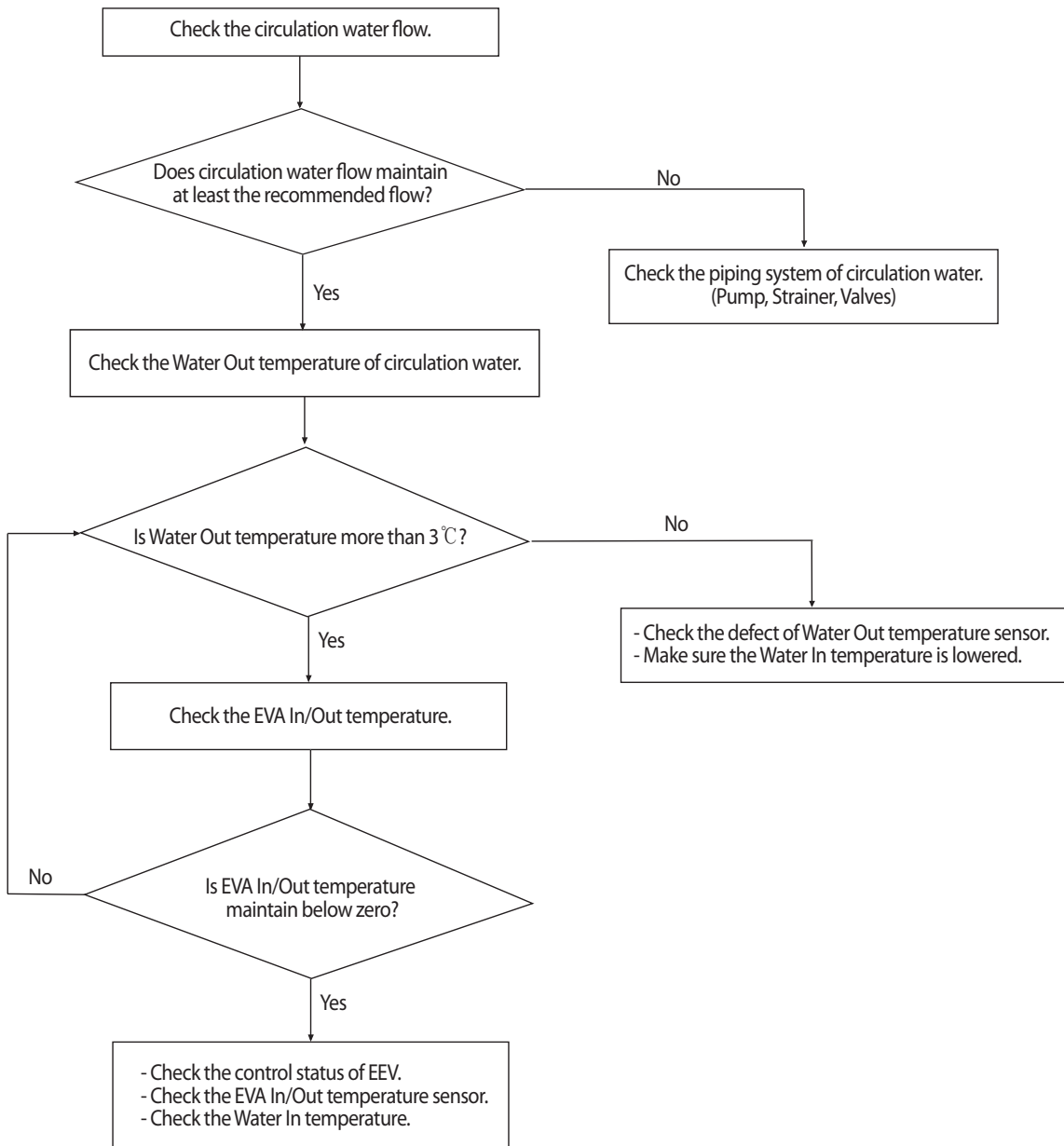

4-4-95 Breakaway of Water Out temperature sensor

Outdoor unit display	<i>E9 10</i> → <i>A</i> XXX (xxx : Address of Indoor Unit that error occurred)
Indoor unit display	<i>E9 10</i>
Criteria	. Water Out temperature before and after the operation : Temperature difference is less than 2 °C .
Cause of problem	• Water Out temperature sensor breakaway of xxx Hydro Unit.

1. Inspection Method

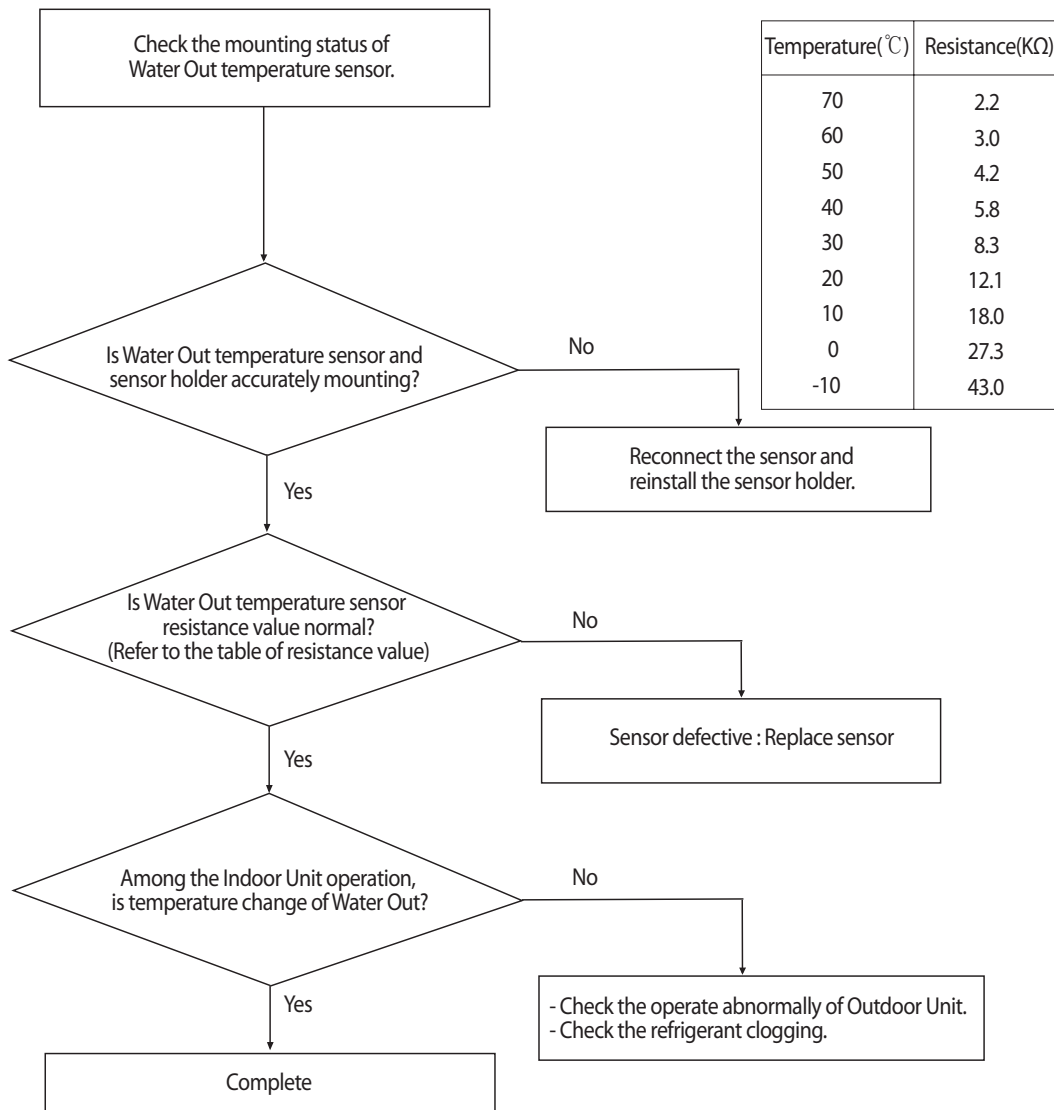

4-4-96 Breakaway of Flow switch

Outdoor unit display	E9 11/E9 13 → A XXX (xxx : Address of Indoor Unit that error occurred)
Indoor unit display	E9 11/E9 13 (Repeats six times)
Criteria	. Output status from Pump signal : Does not detect the signal of Flow Switch, more than 5 seconds.
Cause of problem	• Does not detect the signal of xxx Hydro Unit Flow Switch. (Flow shortage of Water piping system)

1. Inspection Method

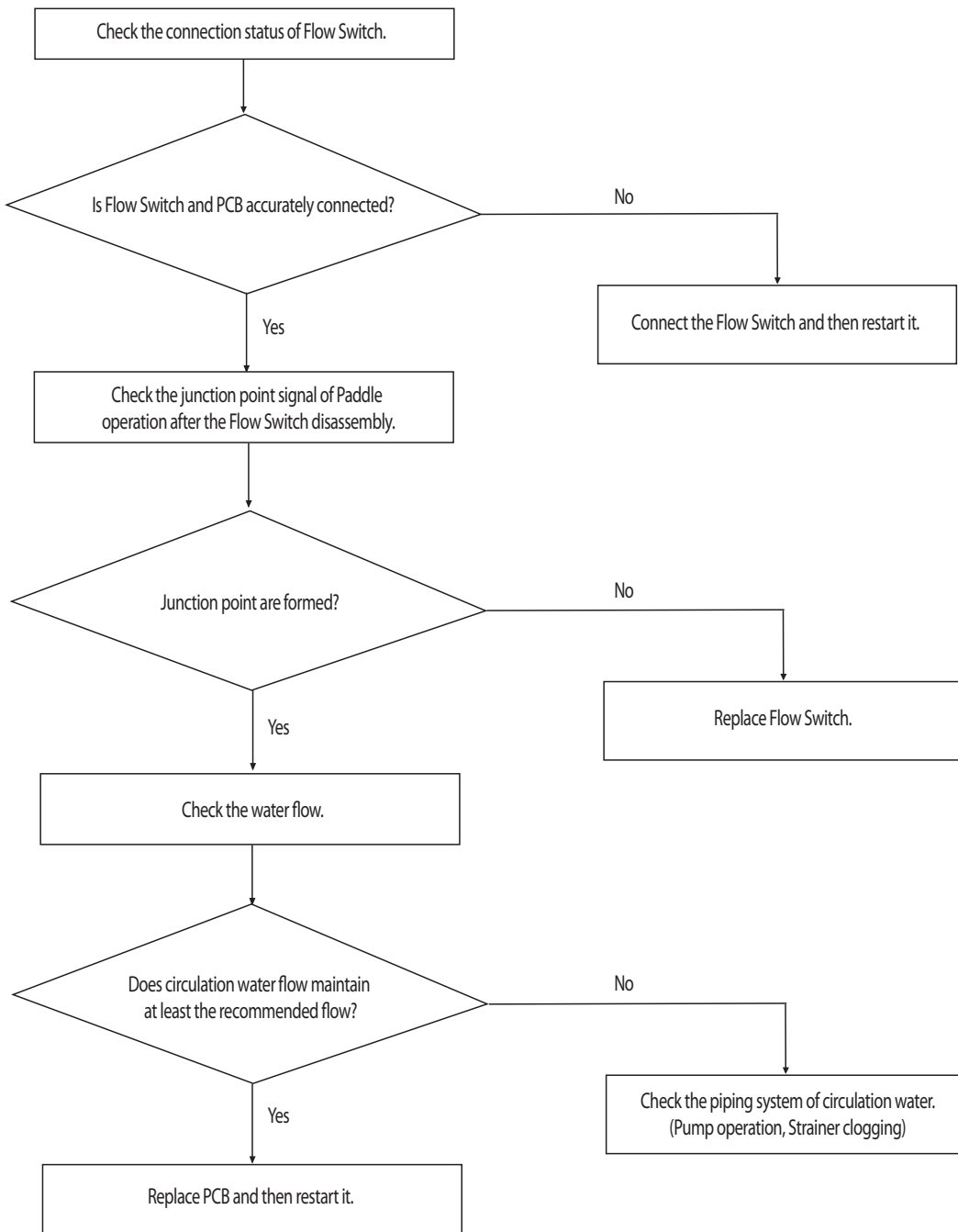

4-4-97 Thermostat Wiring Error

Outdoor unit display	E9 14 → A XXX (xxx : Address of Indoor Unit that error occurred)
Indoor unit display	E9 14
Criteria	• Heating / Cooling signal of Thermostat at the same time input.
Cause of problem	• Thermostat wiring error of xxx Hydro Unit.

1. Inspection Method

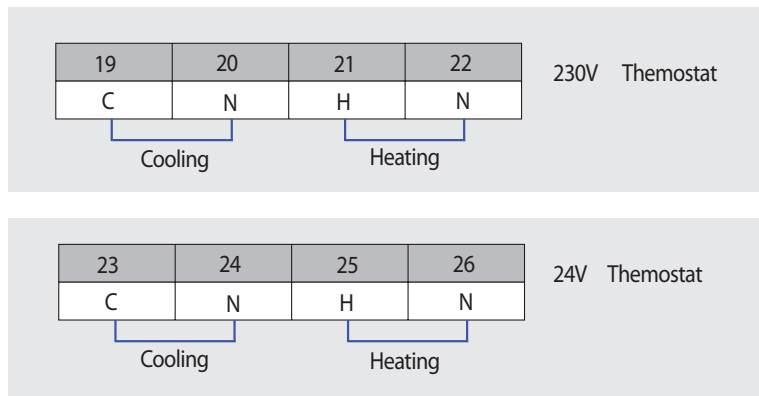
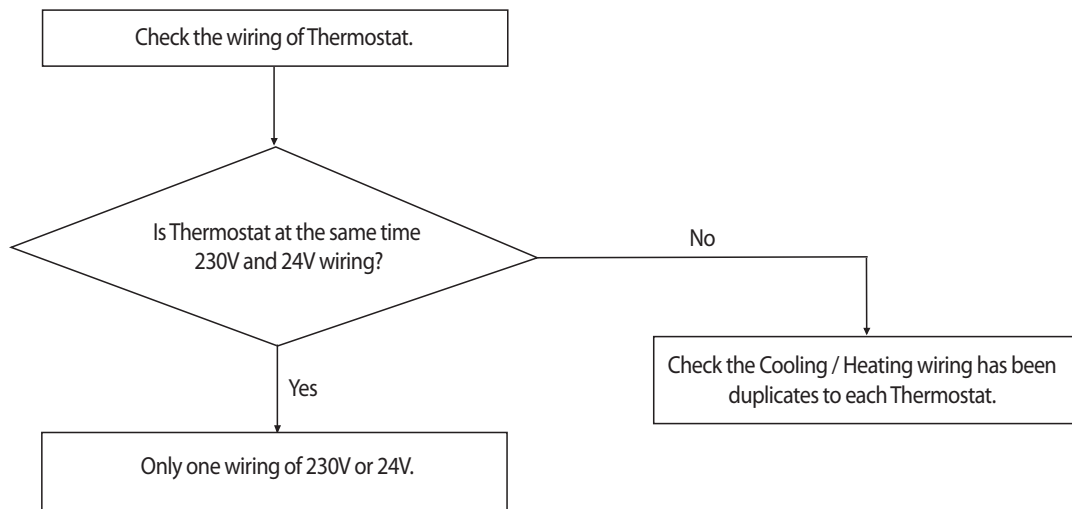

4-4-98 DC FAN Motor Feedback Error

Outdoor unit display	E9 15 → A XXX (xxx : Address of Indoor Unit that error occurred)
Indoor unit display	E9 15
Criteria	<ul style="list-style-type: none"> Refer to the judgment method below.
Cause of problem	<ul style="list-style-type: none"> DC FAN connector defects and connection is not DC FAN motor defective. Control kit PBA defective.

1. Inspection Method

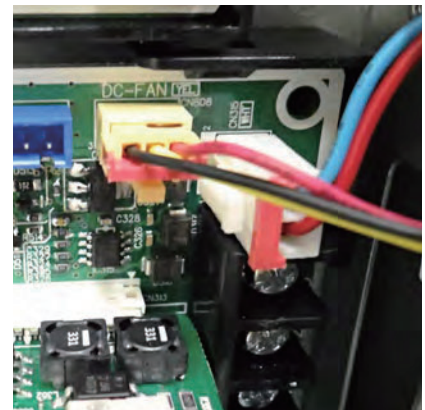
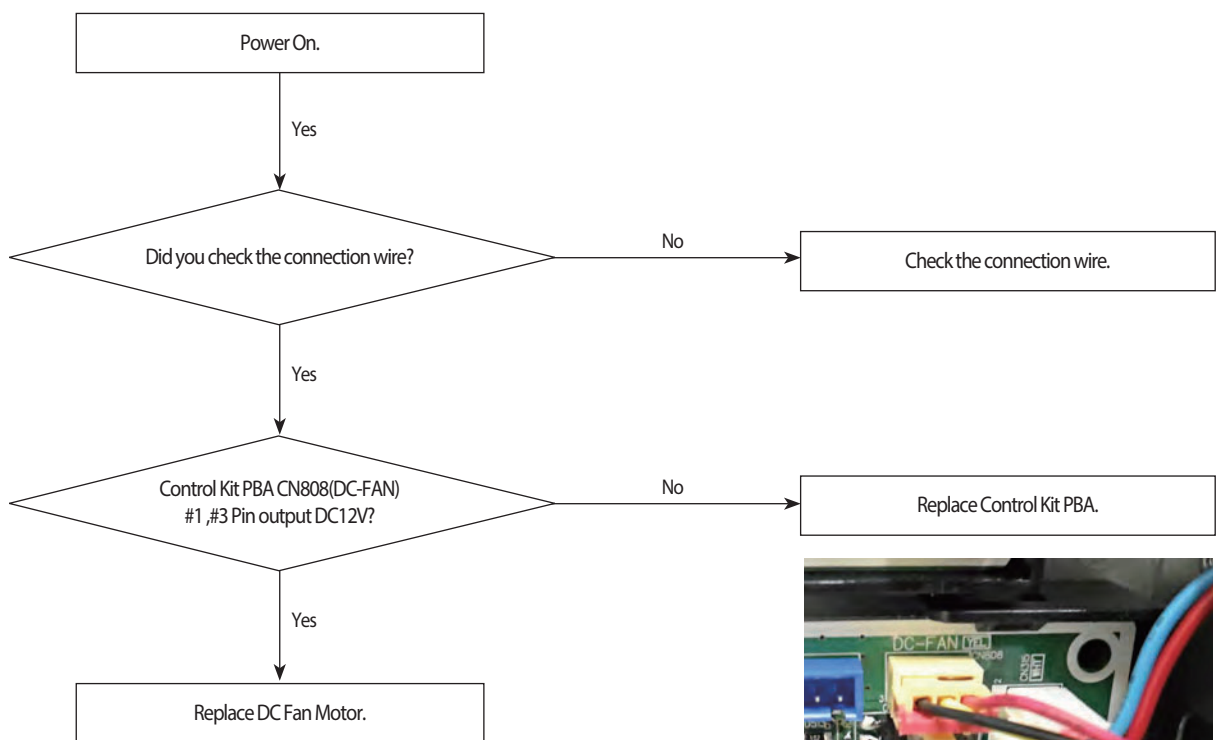

4-4-99 Water Tank Sensor defective

Outdoor unit display	E9 17 → A XXX (xxx : Address of Indoor Unit that error occurred)
Indoor unit display	E9 17
Criteria	<ul style="list-style-type: none"> Refer to the judgement method below.
Cause of problem	<ul style="list-style-type: none"> Water Tank Sensor defective

1. Inspection Method

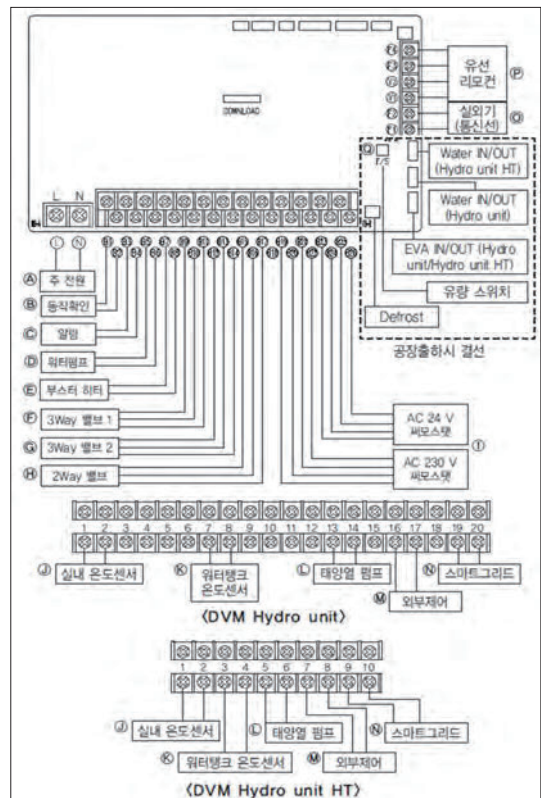
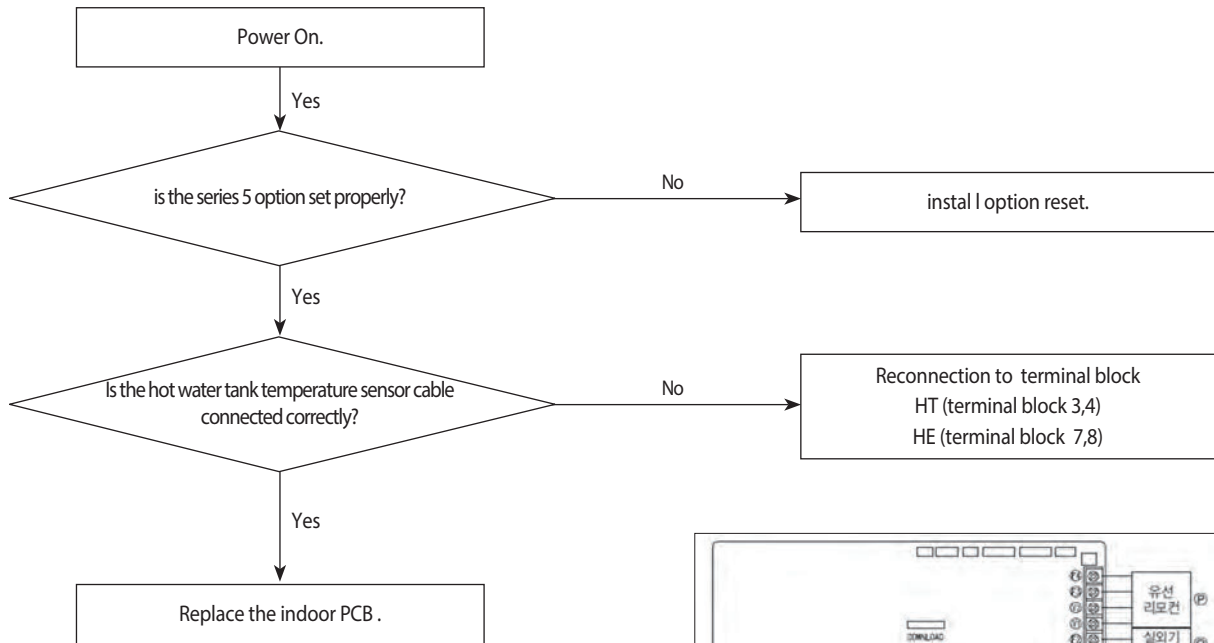

5. PCB Diagram and Parts List

5-1 Indoor Unit

5-1-1 Slim 1 way cassette type (medium)

- MAIN PCB (AM***FN1DEH*)

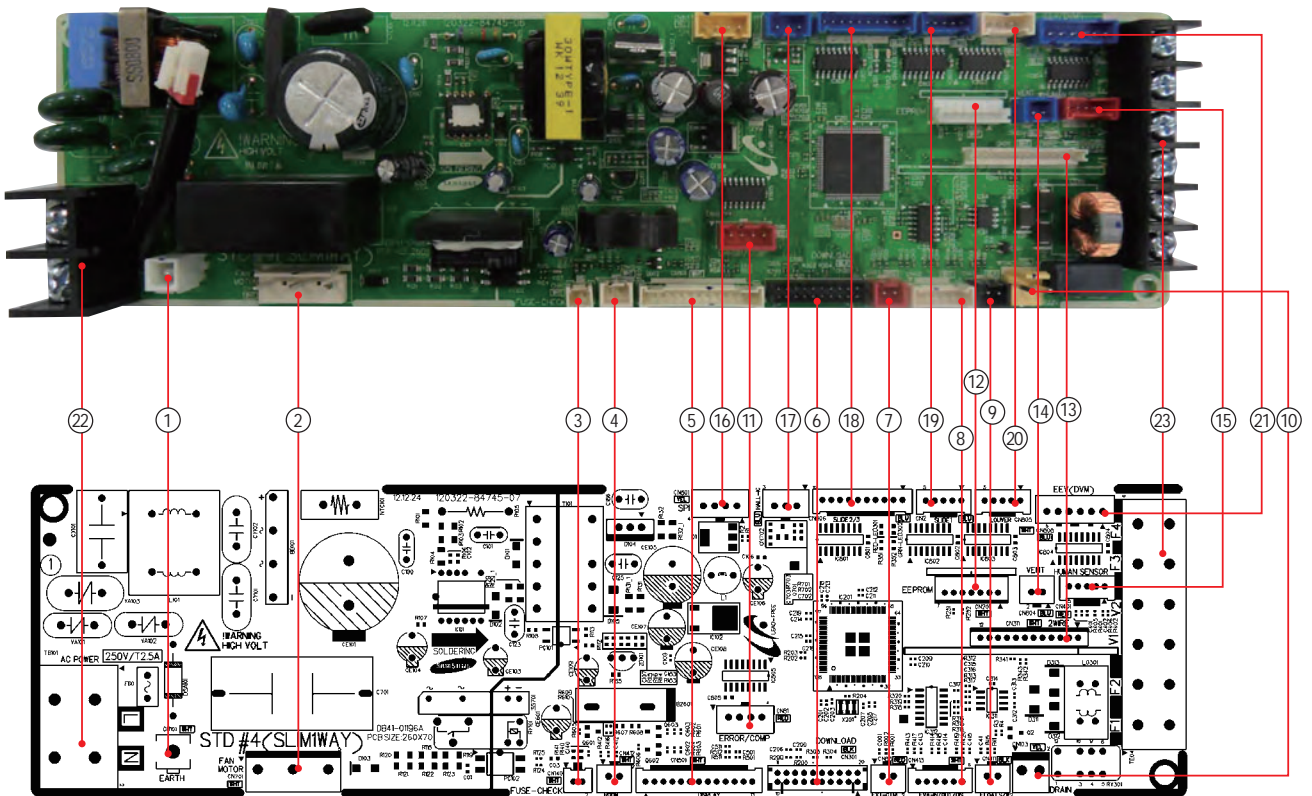

Slim 1 way cassette type (medium) (cont.)

– MAIN PCB (AM***FN1DEH*) (cont.)

① CN101-GND #1: GND	② CN701-FAN MOTOR #1: POWER(N) #3 : SSR MOTOR POWER(L) #5 : POWER(N)	③ CN140-FUSE CHECK #1: FUSE CHECK SIGNAL #2: GND	④ CN412-ROOM THERMISTOR #1 : ROOM THERMISTOR #2 : GND
⑤ CN501-DISPLAY #1: DC12V #2: LED_0 #3: LED_1 #4: LED_2 #5: LED_3 #6: LED_4 #8: REMOCON_OUTPUT_SIGNAL #9 : AUTO SWITCH #10: REMOCON_INPUT_SIGNAL #11: GND #12: DC5V #13: GND	⑥ CN301-DOWNLOAD #1: DC12V #2: GND	⑦ CN83-EXT CTRL #1: GND #2: EXT-CTRL SIGNAL	⑧ CN413:THERMISTOR #1 : EVA-IN THERMISTOR #2 : GND #3 : EVA-OUT THERMISTOR #4 : GND #5 : DISCHARGE THERMISTOR #6 : GND
⑨ CN411-FLOAT SWITCH #1: F/S SIGNAL #2: GND	⑩ CN103-DRAIN PUMP #1: D/ P POWER(DC12V) #2: GND	⑪ CN81-ERROR/COMP CHECK #1: DC12V #2: ERROR SIGNAL OUTPUT(GND) #3: DC12V #4: COMP/OPER. SIGNAL OUTPUT(GND)	⑫ CN201-EEPROM #1: GND #3: DC5V #4: EEPROM_SELECT #5: EEPROM_SO #6: EEPROM_SI #7: EEPROM_CLK
⑬ CN311-2WIRED REMOCON	⑭ CN804-VENTILATOR #1: DC12V #2: VENT SIGNAL OUTPUT(GND)	⑮ CN401-HUMAN SENSING #1: DC12V #2: HUMAN SENSOR COMM(TXD) #3: HUMAN SENSOR COMM(RXD) #4: GND	⑯ CN801-SPI #1: GND #2: GND #3: SPI POWER OUTPUT(DC12V)
⑰ CN702-HALL IC #1 : DC5V #2 : GND #3 : MOTOR FEEDBACK	⑱ CN806-SLIDE 2/3 #1 : DC12V #2~#5: LOUVER SIGNAL OUTPUT #6 : DC12V #7~#10: LOUVER SIGNAL OUTPUT	⑲ CN2-SLIDE 1 #1 : DC12V #2~#5: LOUVER SIGNAL OUTPUT	⑳ CN805-LOUVER #1 : DC12V #2~#5: LOUVER SIGNAL OUTPUT
㉑ CN808-EEV #1~#4: EEV SIGNAL OUTPUT #5 : DC12V #6 : DC12V	㉒ TB101-AC POWER #1: POWER(L) #2: POWER(N)	㉓ TE04-COMMUNICATION #1: COM1(F1) #2: COM1(F2) #3: V1(DC12V) #4: V2(GND) #5: COM2(F3) #6: COM2(F4)	

5-1-2 2 way cassette type
 – MAIN PCB (AM***FN2DEH*)

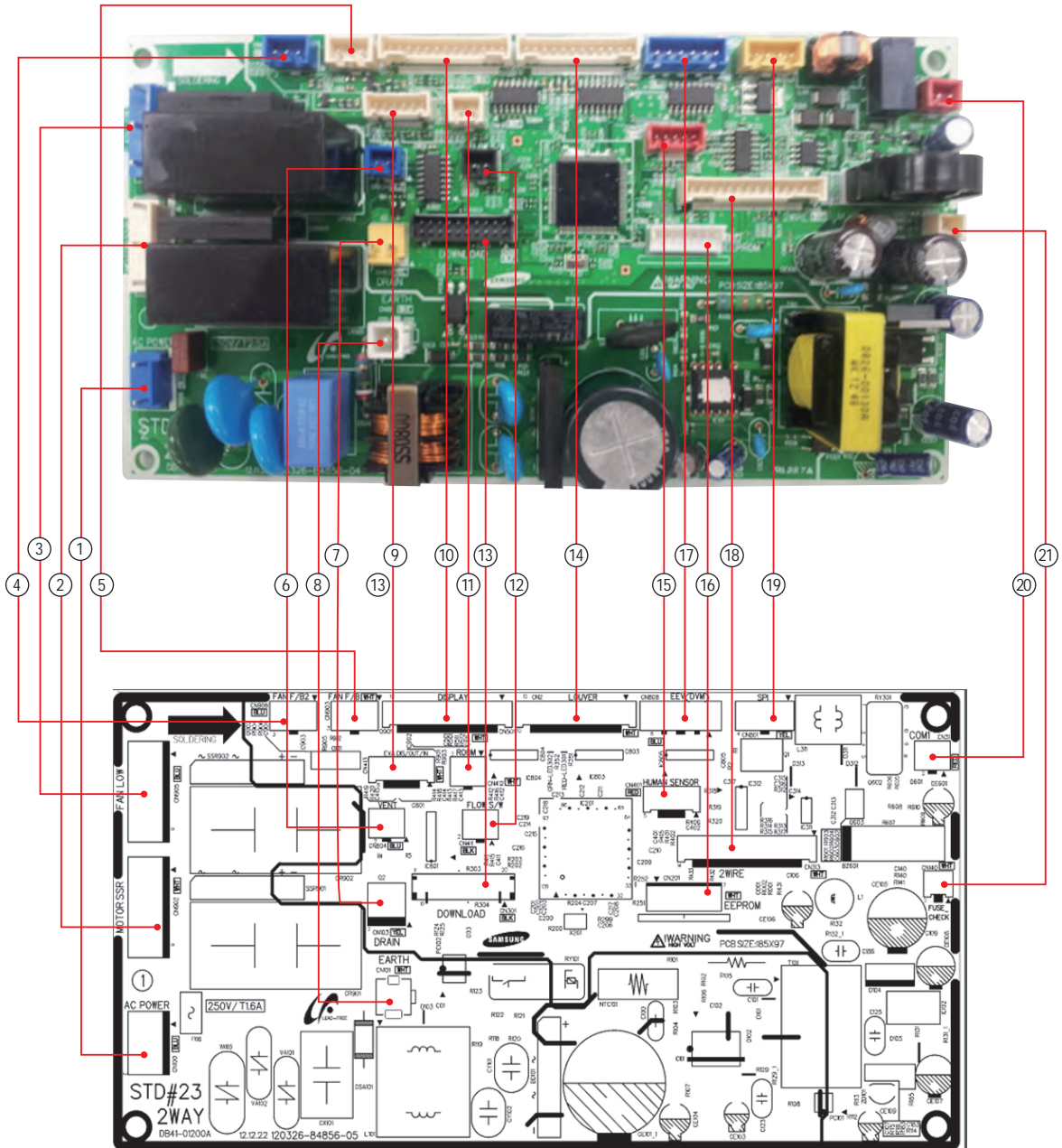

2 way cassette type (cont.)**– MAIN PCB (AM***FN2DEH*) (cont.)**

① CN100-AC INPUT #1: L #2: N	② CN902-SSR MOTOR1 #1: N #2: L #3: N	③ CN905-SSR MOTOR2 #1: N #2: L #3: N	④ CN905-SSR FAN FEED BACK #1: VCC #2: FEEDBACK #3: GND
⑤ CN903-FAN FEED BACK #1: VCC #2: FEEDBACK #3: GND	⑥ CN804-VENT #1: 12V #2: VENT OUT	⑦ CN103-DRAIN PUMP #1: 12V #2: GND	⑧ CN101-EARTH
⑨ CN413- THERMO. #1: EVA IN TEMP #2,4,6: GND #3: EVA OUT TEMP #5: DISCHARGE TEMP	⑩ CN901-DISPLAY #1: 12V #2~7: LED #8: REMOCON OUT #9: AUTO SW #10: REMOCON INT #11: GND #12: VCC	⑪ CN412-ROOM THERMO. #1: THERMOR INPUT #2: GND	⑫ CN411-FLOW SW #1: Flow SW INPUT #2: GND
⑬ CN301-MICOM DOWNLOAD	⑭ CN2-BLADE #1,2: 12V #3~6: BLADE CONTROL #7,8: 12V #9~12: BALDE CONTROL	⑮ CN401-HUMAN SENSOR #1: 12V #2,3: COM #5: GND	⑯ CN201-E2P MODULE
⑰ CN808-EEV VALVE #1~4: EEV CONTROL #5,6: 12V	⑱ CN311-COMM	⑲ CN801-SPI #1,2: GND #3: SPI CONTROL	⑳ CN31-IN-OUT COMM.
㉑ CN140-FUSE CHECK #1: FUSE CHECK #2: GND			

5-1-3 4way cassette , Global 4Way Cassette type(600x600), Slim 1way cassette (small/large)
 – MAIN PCB (AM***FN4DEH*, AM***FNNDEH*, AM***HNNDEH* , AM***HN1DEH*, AM***JN1DEH*)

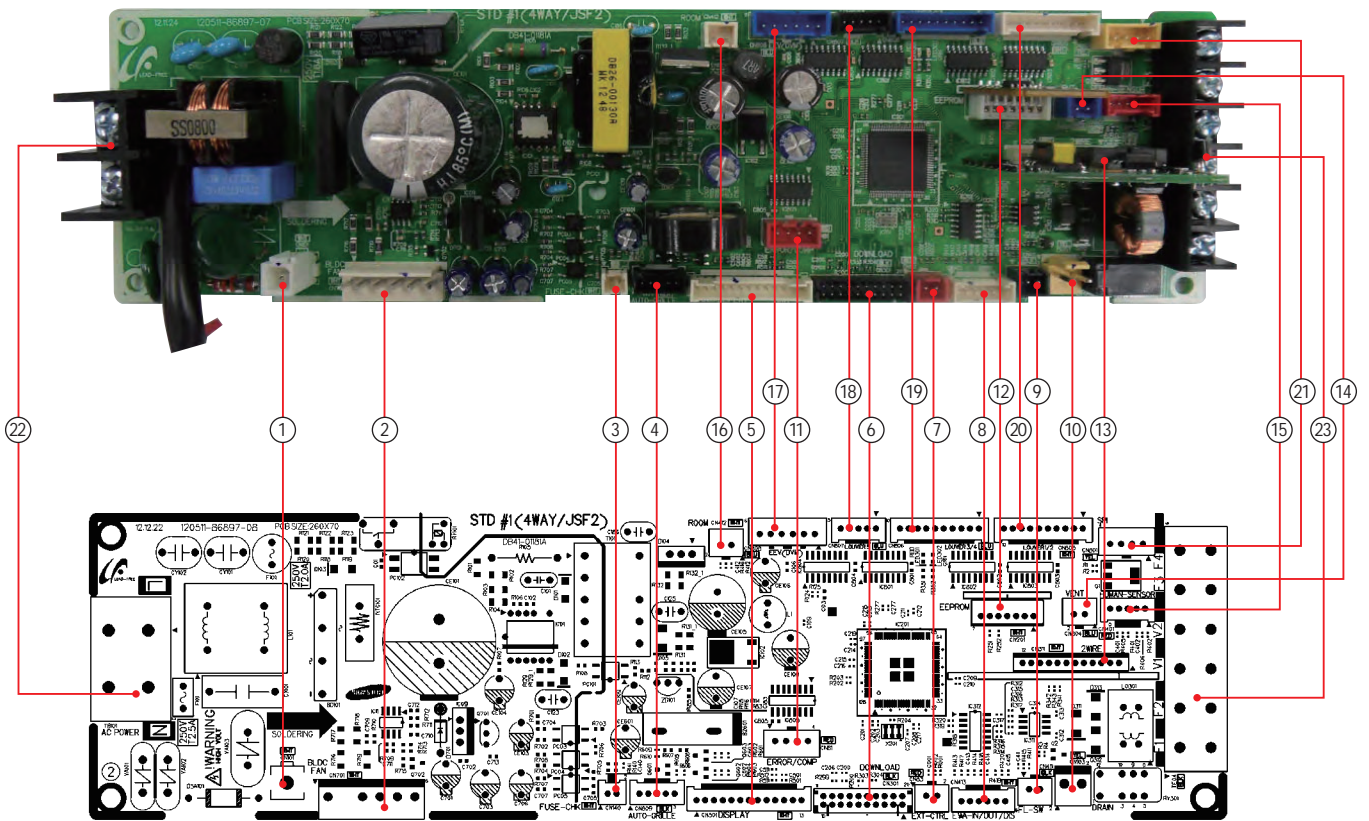

4way cassette , Global 4Way Cassette type(600x600), Slim 1way cassette (small/large) (cont.)

– MAIN PCB (AM***FN4DEH*, AM***FNNDEH*, AM***HNNDEH*, AM***HN1DEH*, AM***JN1DEH*) (cont.)

① CN101-GND #1: GND	② CN701-BLDC MOTOR #1: DC310V #3 : GND #4 : DC15V #5 : FAN RPM #6 : RPM FEEDBACK	③ CN140-FUSE CHECK #1: FUSE CHECK SIGNAL #2: GND	④ CN809-AUTO GRILL #1 : DC12V #4 : REMOCON SIGNAL #5 : GND
⑤ CN501-DISPLAY #1: DC12V #2: LED_0 #3: LED_1 #4: LED_2 #5: LED_3 #6: LED_4 #7: LED_5 #8: REMOCON_OUTPUT_SIGNAL #9 : AUTO SWITCH #10: REMOCON_INPUT_SIGNAL #11: GND #12: DC5V #13: GND	⑥ CN301-DOWNLOAD	⑦ CN83-EXT CTRL #1: GND #2: EXT-CTRL SIGNAL	⑧ CN413:THERMISTOR #1 : EVA-IN THERMISTOR #2 : GND #3 : EVA-OUT THERMISTOR #4 : GND #5 : DISCHARGE THERMISTOR #6 : GND
⑨ CN411-FLOAT SWITCH #1: F/S SIGNAL #2: GND	⑩ CN103-DRAIN PUMP #1: D/ P POWER(DC12V) #2: GND	⑪ CN81-ERROR/COMP CHECK #1: DC12V #2: ERROR SIGNAL OUTPUT(GND) #3: DC12V #4: COMP/OPER. SIGNAL OUTPUT(GND)	⑫ CN201-EEPROM #1: GND #3: DC5V #4: EEPROM_SELECT #5: EEPROM_SO #6: EEPROM_SI #7: EEPROM_CLK
⑬ CN311-2WIRED REMOCON	⑭ CN804-VENTILATOR #1: DC12V #2: VENT SIGNAL OUTPUT(GND)	⑮ CN401-HUMAN SENSING #1: DC12V #2: HUMAN SENSOR COMM(TXD) #3: HUMAN SENSOR COMM(RXD) #4: GND	⑯ CN412-ROOM THERMISTOR #1 : ROOM THERMISTOR #2 : GND
⑰ CN808-EEV #1~#4: EEV SIGNAL OUTPUT #5: DC12V #6: DC12V	⑱ CN807-LOUVERS #1 : DC12V #2~#5: LOUVER SIGNAL OUTPUT	⑲ CN806-LOUVER3/4 #1 : DC12V #2~#5: LOUVER SIGNAL OUTPUT #6 : DC12V #7~#10: LOUVER SIGNAL OUTPUT	⑳ CN805-LOUVER1/2 #1 : DC12V #2~#5: LOUVER SIGNAL OUTPUT
㉑ CN801-SPI #1: GND #2: GND #3: SPI POWER OUTPUT(DC12V)	㉒ TB101-AC POWER #1: POWER(L) #2: POWER(N)	㉓ TE04-COMMUNICATION #1: COM1(F1) #2: COM1(F2) #3: V1(DC12V) #4: V2(GND) #5: COM2(F3) #6: COM2(F4)	

5-1-4 360 cassette – MAIN PCB

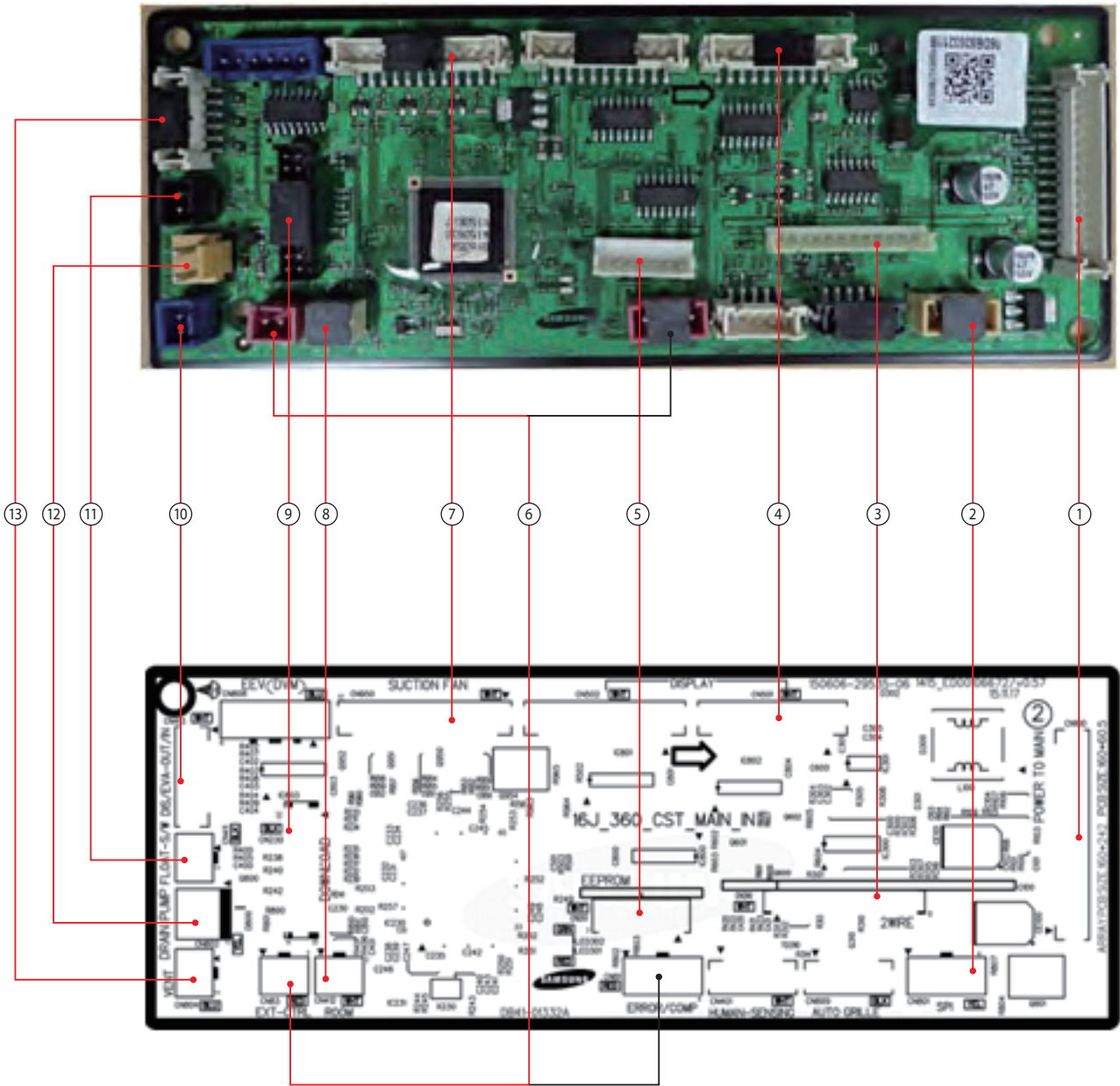

360 cassette**– MAIN PCB**

<p>① CN100 – POWER TO MAINCONNECTOR</p> <p>#1,2:12V #3,4:SGND #5:5V #6:FUSE SHORT/OPEN CHK #7:15V OUTPUT ON/OFF #8:ZEROCROSSING SIGNAL #9:ZC STANDBY MODE ON/OFF #10:MAIN FAN MOTOR PWM #11:MAIN FAN MOTOR F/B #12:F3 - WIRED REMOTE CONTROL COMMUNICATION #13:F4 - WIRED REMOTE CONTROL COMMUNICATION #14:F1 - INDOOR/OUTDOOR COMMUNICATION #15:F2 - INDOOR/OUTDOOR COMMUNICATION</p>	<p>② CN801 – SPI</p> <p>#1:SGND #3:12V #2,4:NC</p>	<p>③ CN310 – 2WIRE SUB</p> <p>#1:12V #2:COM2_PCTRL_MICOM #3:COM2_VCHECK_A #4:COM2_VCHECK_B #5:COM2_MICOM_AD #6:VCC STANDBY MODE ON/OFF #7:COM2_ENABLE #8:COM2_C #9:COM2_D #10:COM2_TX #11:COM2_RX #12:SGND</p>	<p>④ CN501,502</p> <p>[CN501] #1,2:BUZZER #3:CENTER 3 COLOR LED - BLUE #4:CENTER 3 COLOR LED - GREEN #5:CENTER 3 COLOR LED - RED #6:CENTER LED - ICE BLUE #7~10: CENTER LED [CN502] #1:12V #2~6:VISUALIZATION LED #7~11: REMOTE CONTROL RECEIVER PBA CONNECTION</p>
<p>⑤ CN201 – EEPROM</p> <p>#1:SGND #2:NC #3:5V #4:EEPROM_SELECT #5:EEPROM_SO #6:EEPROM_SI #7:EEPROM_CLK</p>	<p>⑥ CN81,83 – AIM-B14</p> <p>[CN81] #1,3:12V #2:ERROR CHK (12V JUNCTION) #4:COMP CHK (12V JUNCTION) [CN83] #1:EXT_CTRL (5V) #2:SGND</p>	<p>⑦ CN950 – SUCTION FAN</p> <p>#1,5,9:SUCTION VCC (12V) #2,6,10:SUCTION FAN F/B #3,7,11:SGND #4,8,12:SUCTION PWM</p>	<p>⑧ CN412 – INDOOR TEMPERATURE SENSOR</p> <p>#1:ROOM TEMP #2:SGND</p>
<p>⑨ CN230 – DOWNLOAD</p> <p>#1~20:DOWNLOAD</p>	<p>⑩ CN413 – EVA TEMPERATURE SENSOR</p> <p>#1:EVA INTEMP #3:EVA OUTTEMP #5:DISCHARGE TEMP #2,4,6:SGND</p>	<p>⑪ CN411 – FLOAT SW</p> <p>#1:FLOAT SW #2:SGND</p>	<p>⑫ CN802 – DRAIN PUMP</p> <p>#1:DRAIN PUMP (12V) #2:SGND</p>
<p>⑬ CN804 – VENTILATOR</p> <p>#1:VENT (MICOM OUTPUT) #2:BUFFER OUTPUT(HIGH/LOW)</p>			

5-1-5 Indoor Unit Power PCB

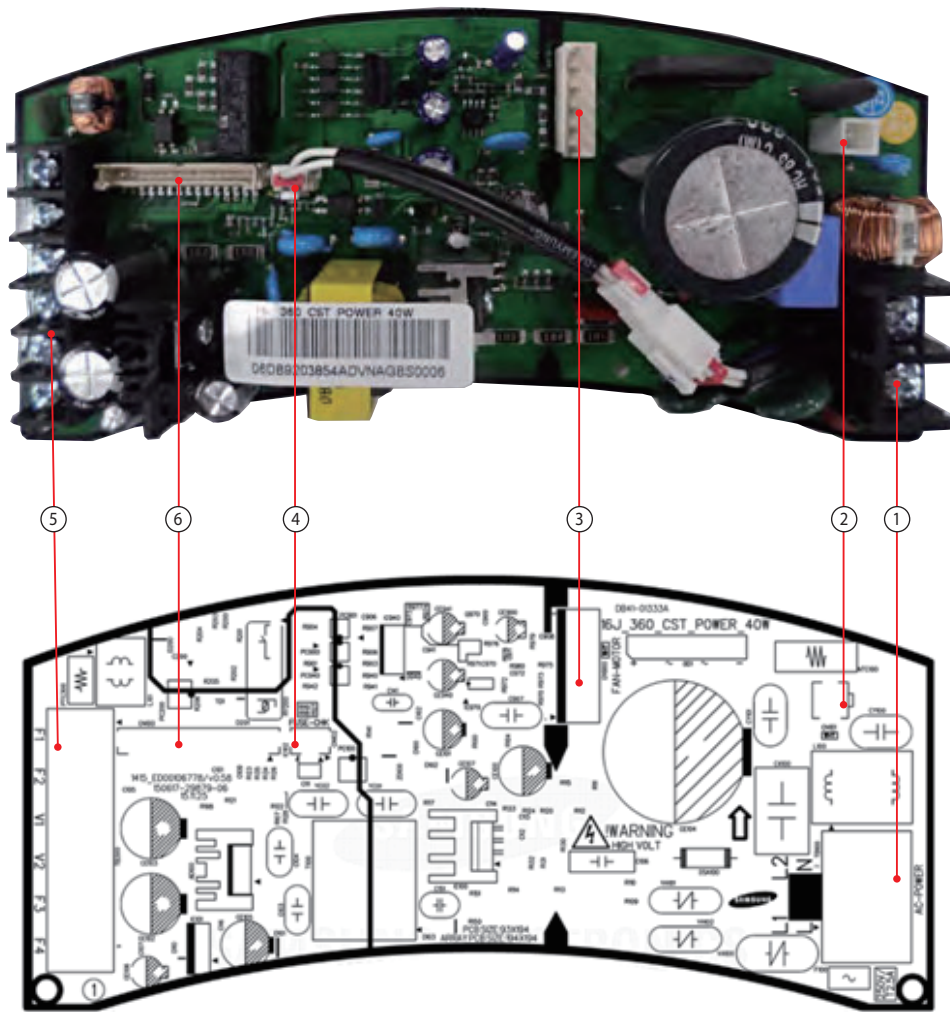

<p>① TB100 - POWER T/B</p> <p>#1 : POWER CORD CONNECTION - L (L1) #2 : POWER CORD CONNECTION - N (L2)</p>	<p>② CN101 - EARTH</p> <p>#1 : EARTH (PBA - SET GND)</p>	<p>③ CN900 - MAIN FAN MOTOR</p> <p>[CN81] #1 : 310V (DC LINK) #2 : NC #3 : PGND #4 : 15V (VCC) #5 : MAIN FAN MOTOR PWM #6 : MAIN FAN MOTOR F/B</p>	<p>④ CN102 - THERMAL FUSE</p> <p>#1 : FUSE SHORT/OPEN CHK #2 : SGND</p>
<p>⑤ TB300 - COMM. T/B</p> <p>#1 : F1 - INDOOR/OUTDOOR COMM. #2 : F2 - INDOOR/OUTDOOR COMM. #3 : V1 - 12V #4 : V2 - SGND #5 : F3 - WIRED REMOTE CONTROL COMM. #6 : F4 - WIRED REMOTE CONTROL COMM.</p>	<p>⑥ CN100 - POWER TO MAIN CONNECTOR</p> <p>[CN81] #1, 3 : 12V #2 : ERROR CHK (12V JUNCTION) #4 : COMP CHK (12V JUNCTION) [CN83] #1 : EXT_CTRL (5V) #2 : SGND</p>		

5-1-6 Display PCB - 360 Cassette

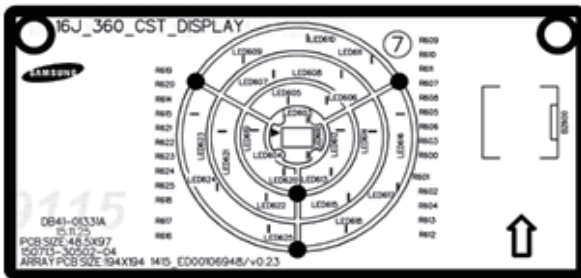

①	CN401 – DISPLAY 1
#1 :	12V
#2 :	VISUALIZATION LED_SECTION2, LAYER2
#3 :	VISUALIZATION LED_SECTION2, LAYER3
#4 :	VISUALIZATION LED_SECTION3, LAYER1
#5 :	VISUALIZATION LED_SECTION3, LAYER2
#6 :	VISUALIZATION LED_SECTION3, LAYER3
②	CN501 – DISPLAY 2
#1 :	BUZZER1
#2 :	BUZZER2
#3 :	CENTER 3 COLOR LED - BLUE
#4 :	CENTER 3 COLOR LED - GREEN
#5 :	CENTER 3 COLOR LED - RED
#6 :	CENTER LED – ICE BLUE
#7 :	VISUALIZATION LED_SECTION1, LAYER1
#8 :	VISUALIZATION LED_SECTION1, LAYER2
#9 :	VISUALIZATION LED_SECTION1, LAYER3
#10 :	VISUALIZATION LED_SECTION2, LAYER1

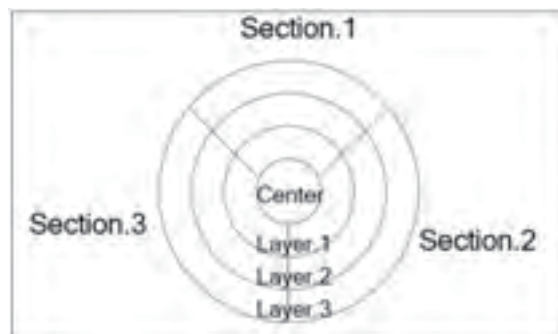

5-1-7 Duct type (Slim Duct 2)

- MAIN PCB (AM017/022/028/036/045/056/071FNLDEH*)
- MAIN PCB (AE022/028/036/056MNLDEH/EU)

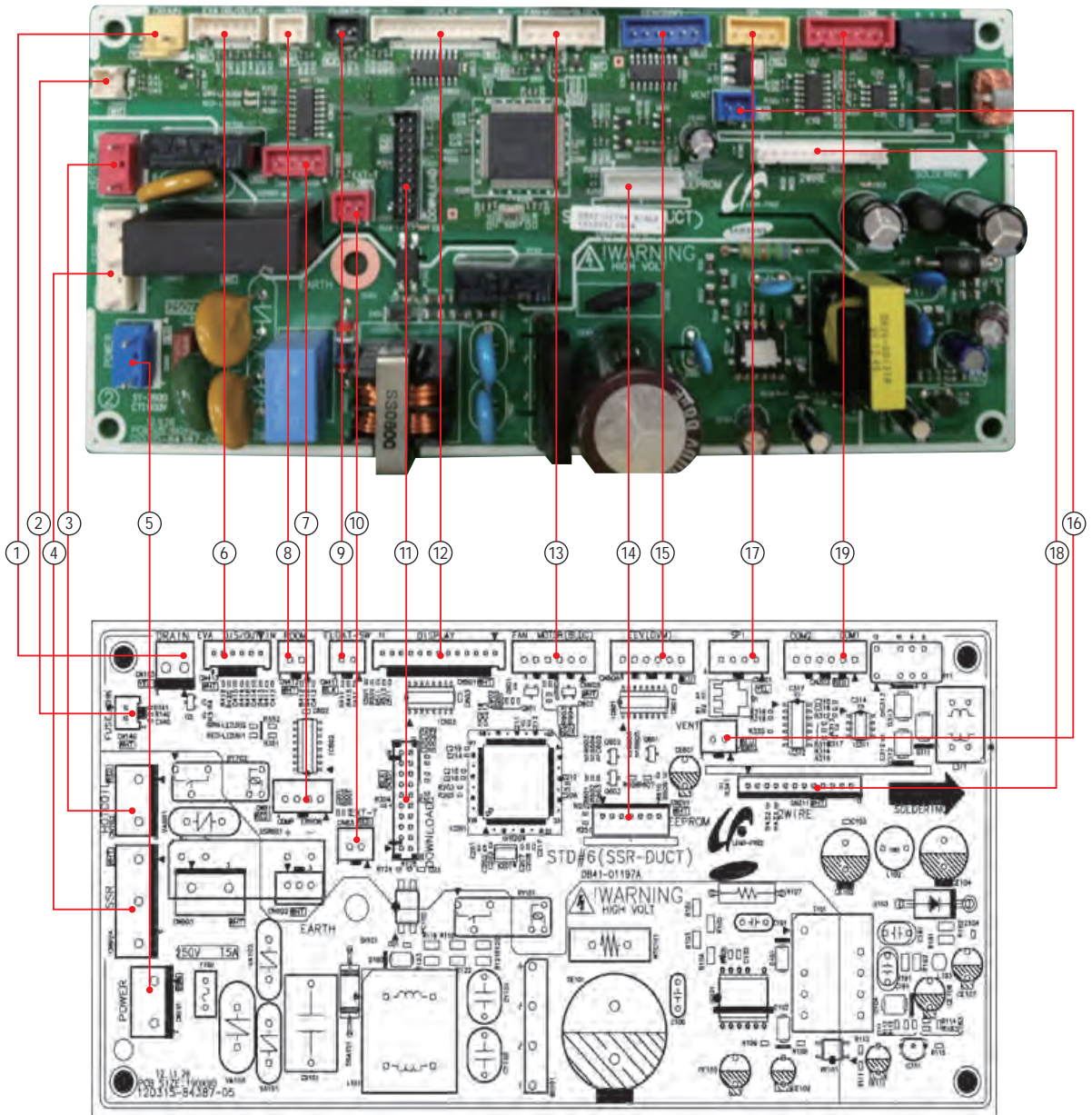

Duct type (Slim Duct 2) (cont.)

– MAIN PCB (AM017/022/028/036/045/056/071FNLDEH* (cont.))

– MAIN PCB (AE022/028/036/056MNLDEH/EU(cont.))

① CN103-DRAIN #1:POWER #2:GND	② CN140-FUSE CHK #1:POWER #2:GND	③ CN702-HOTCOIL #1:N #3:L	④ CN904-SSR #1,#5:N #3:L #2,#4:NO USED
⑤ CN101-POWER #1:L #3:N	⑥ CN413-EVA DIS/OUT/IN #1:EVA-IN #3:EVA-OUT #5:DISCHARGE #2,#4,#6:GND	⑦ CN81-COMP ERROR #1,#3:12V #2:ERROR_CHK_OUT #4:COMP_CHK_OUT	⑧ CN412-ROOM #1:ROOM #2:GND
⑨ CN411-FLOAT SW #1:FLOAT SW #2:GND	⑩ CN83-EXT T #1:GND #2:EXT_CTRL	⑪ CN301-DOWNLOAD - For Developer only,Not available in Actual Site - 20 Pin Down Loader	⑫ CN501-DISPLAY 12.CN501-DISPLAY #1:12V #2~#6:DISPLAY LED CONTROL #7:BZ_1 #8:REMOCON SIGNAL OUT #9:AUTO_SW #10:REMOCON_INT #11:GND #12:VCC #13:BZ_2
⑬ CN905-FAN MOTOR #1:12V #2:GND #3:VCC #4:MOTOR SIGNAL PWM1 OUT #5:R903 CONTROL SIGNAL #6:INRUSH OUT	⑭ CN201-EEPROM #1:GND #2:NO USED #3:VCC #4:EEPROM_SELECT #5:EEPROM_SO #6:EEPROM_SI #7:EEPROM_CLK	⑮ CN808-EEV(DVM) #1~4:CONTROL SIGNAL #5~6:12V	⑯ CN804-VENT #1:12V #2:VENT_OUT
⑰ CN801-SPI #1:GND #2:GND #3:CONTROL SIGNAL #4:NOT USED	⑱ CN311-2WIRE #1:12V #2:COM2_PCTRL_MICOM #3:COM2_VCHECK_A #4:COM2_VCHECK_B #5:COM2_MICOM_AD #6:VCC #7:COM2_ENABLE #8:COM2_C #9:COM2_D #10:COM2_Tx #11:COM2_Rx #12:GND	⑲ CN302-COM1 COM2 #1~2:COM1 #3:12V #4:GND #5~6:COM2	

Duct type (Slim Duct 2) (cont.)

- Sub PCB (AM017/022/028/036/045/056/071FNLDEH*)
- Sub PCB (AE022/028/036/056MNLDEH/EU)

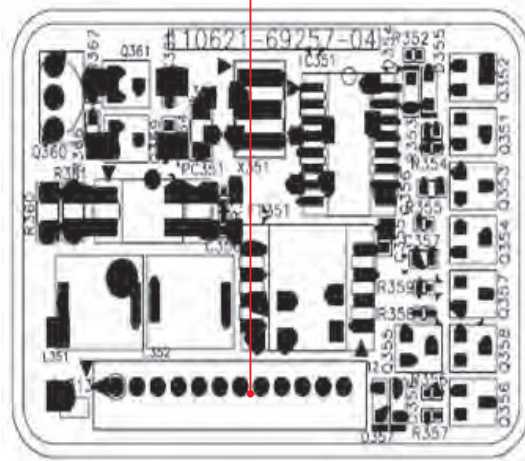
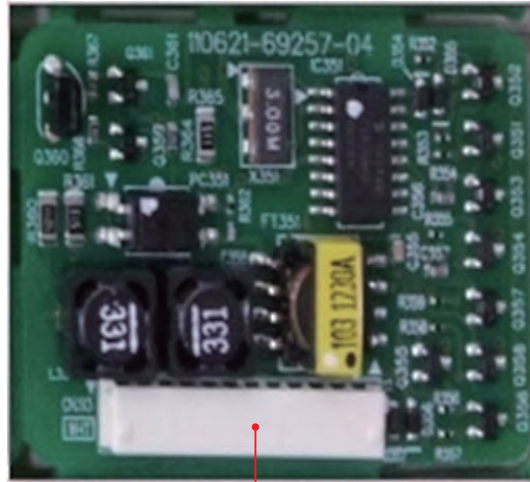

① CN313-2WIRES COMM.

- #1:12V
- #2:COM2_PCTRL_MICOM
- #3:COM2_VCHECK_A
- #4:COM2_VCHECK_B
- #5:COM2_MICOM_AD
- #6:VCC
- #7:NO UESD
- #8:COM2_C
- #9:COM2_D
- #10:COM2_TXD
- #11:COM2_RXD
- #12:GND

5-1-8 Duct type (Slim Duct 3)

– MAIN PCB (AM090/112/128/140FNLDEH*)

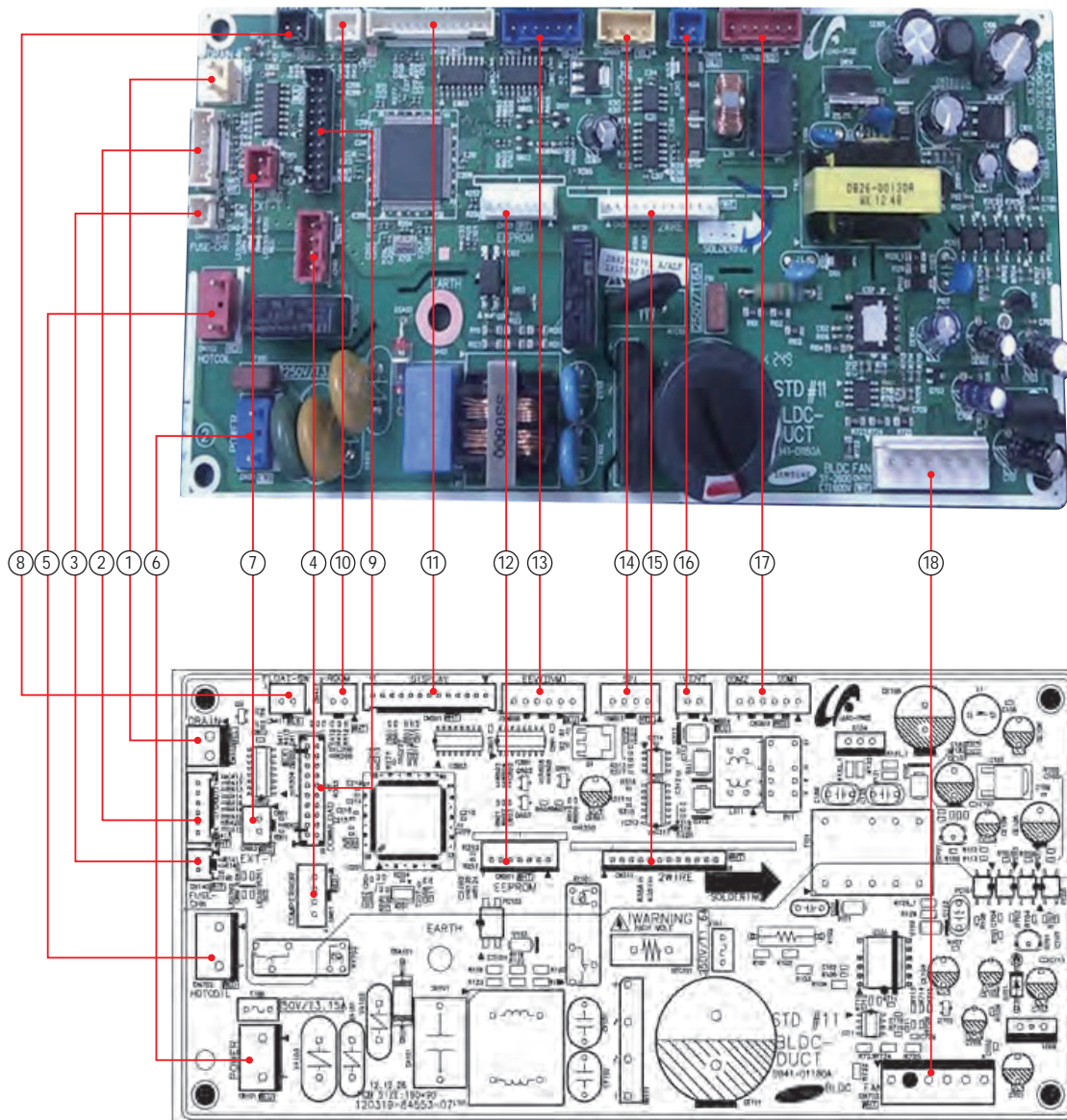

Duct type (Slim Duct 3) (cont.)

- MAIN PCB (AM090/112/128/140FNLDEH* (cont.))

<p>① CN103-DRAIN #1: GND #2: GND</p>	<p>② CN413-EVA DIS/OUT/IN #1: GND #3: EVA-OUT #5: DISCHARGE #2,#4,#6: GND</p>	<p>③ CN140-FUSE CHK #1: GND #2: GND</p>	<p>④ CN81-COMP ERROR #1: GND #2: ERROR_CHK_OUT #4: COMP_CHK_OUT</p>
<p>⑤ CN702-HOTCOIL #1: GND #3: L</p>	<p>⑥ CN101-POWER #1: GND #3: N</p>	<p>⑦ CN83-EXT T #1: GND #2: EXT_CTRL</p>	<p>⑧ CN411-FLOAT SW #1: GND #2: GND</p>
<p>⑨ CN301-DOWNLOAD → For Developer Only, Not available in Actual Site → 20 Pin Down Loader</p>	<p>⑩ CN412-ROOM #1: GND #2: GND</p>	<p>⑪ CN501-DISPLAY #1: 12V #2~#6: DISPLAY LED CONTROL #7: BZ_1 #8: REMOCON SIGNAL OUT #9: AUTO_SW #10: REMOCON_INT #11: GND #12: VCC #13: BZ_2</p>	<p>⑫ CN201-EEPROM #1: GND #2: NO USED #3: VCC #4: EEPROM_SELECT #5: EEPROM_SO #6: EEPROM_SI #7: EEPROM_CLK</p>
<p>⑬ CN808-EEV(DVM) #1: GND #5~6: 12V</p>	<p>⑭ CN801-SPI #1: GND #2: GND #3: CONTROL SIGNAL #4: NOT USED</p>	<p>⑮ CN311-2WIRE #1: GND #2: COM2_PCTRL_MICOM #3: COM2_VCHECK_A #4: COM2_VCHECK_B #5: COM2_MICOM_AD #6: VCC #7: COM2_ENABLE #8: COM2_C #9: COM2_D #10: COM2_Tx #11: COM2_Rx #12: GND</p>	<p>⑯ CN804-VENT #1: GND #2: VENT_OUT</p>
<p>⑰ CN302-COM1 COM2 #1~2: COM1 #3: 12V #4: GND #5~6: COM2</p>	<p>⑱ CN703-BLDC FAN #1: DC5V #2: NOT USED #3: AGND #4: DC15V #5: PC04 OUTPUT #6: RPM OUTPUT</p>		

Duct type (Slim Duct 3) (cont.)

– Sub PCB (AM090/112/128/140FNLDEH*) (cont.)

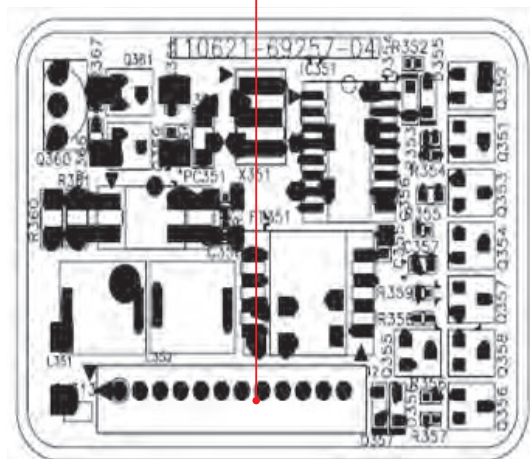
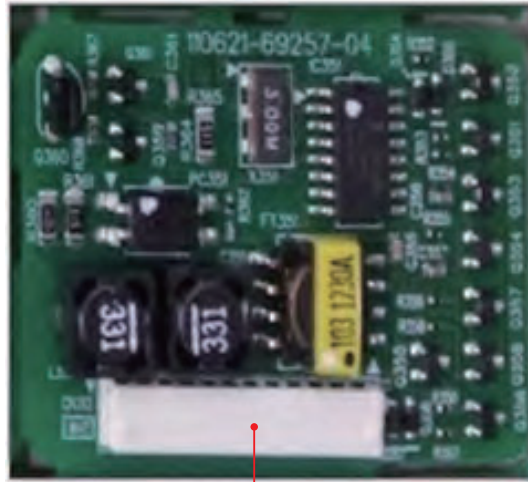
① **CN313-2WIRES COMM.**

#1:12V
 #2:COM2_PCTRL_MICOM
 #3:COM2_VCHECK_A
 #4:COM2_VCHECK_B
 #5:COM2_MICOM_AD
 #6:VCC
 #7:NO UESD
 #8:COM2_C
 #9:COM2_D
 #10:COM2_TXD
 #11:COM2_RXD
 #12:GND

5-1-9 Slim Home Duct

- MAIN PCB (AM017/022/028/036KNLDEH*)

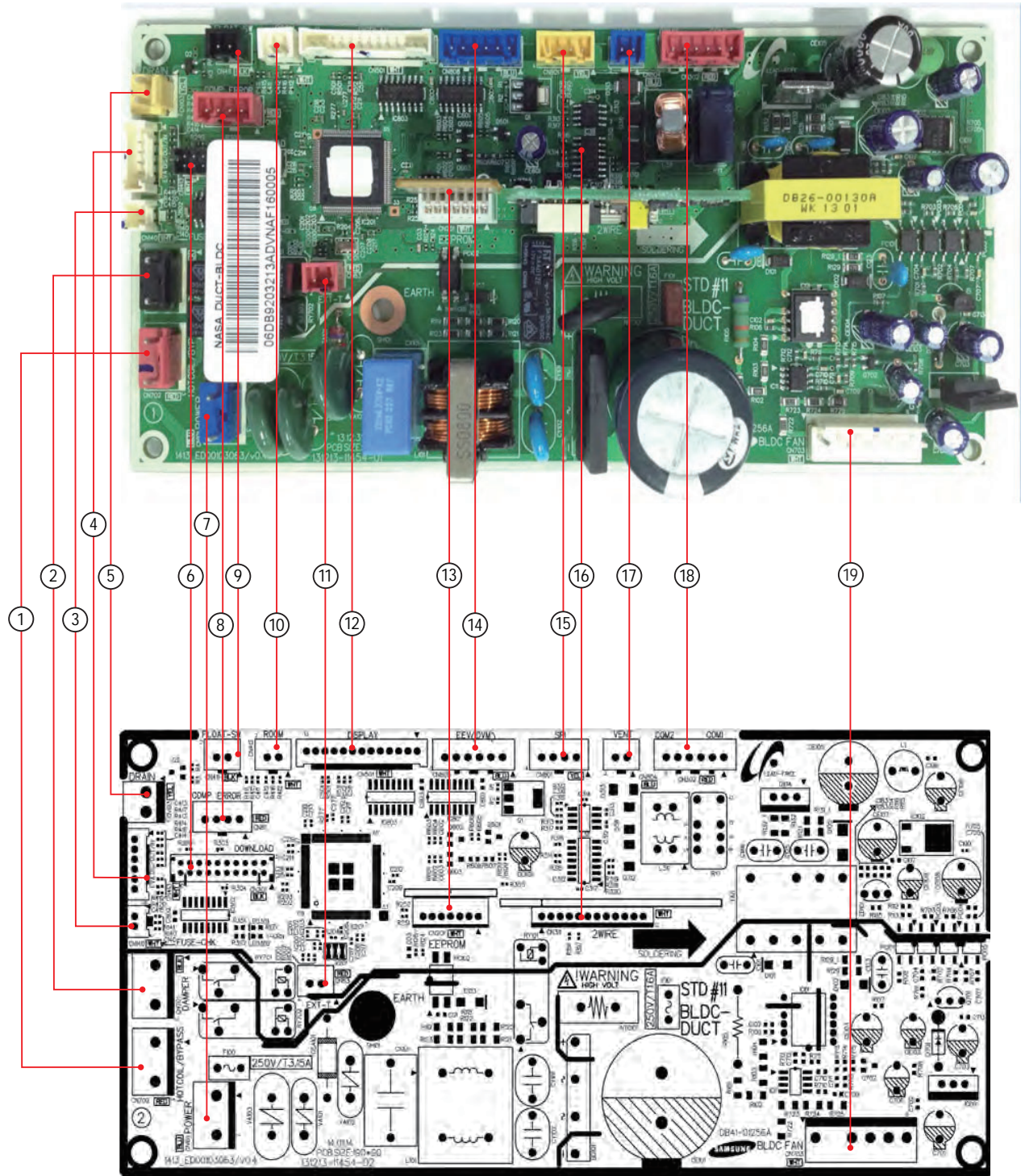

Slim Home Duct (Cont.)

- MAIN PCB (AM017/022/028/036KNLDEH*)

① CN702-HOT COIL #1: L #2: N	② CN701-DAMPER #1: L #2: N	③ CN140-FUSE CHECK #1:FUSE CHECK #2:GND	④ CN413-Temperature Sensor #1 : EVA IN TEMP #2,4,6: GND #3 : EVA OUT TEMP #5 : DISCHARGE TEMP
⑤ CN103-DRAIN PUMP #1: 12V #2 : GND	⑥ CN301-MICOM DOWNLOAD	⑦ CN101-AC INPUT #1: L #2: N	⑧ CN81-EXTERNAL CONTROL OUT #1,3: 12V #2: ERROR CHECK OUT #4: COM CHK OUT#4 : GND
⑨ CN411-FLOAT S/W #1: FLOAT SW Input #2: GND	⑩ CN412-ROOM Temperature Sensor #1: Temperature Input #2: GND	⑪ CN83-EXTERNAL CONTROL #1: GND #2: EXTERNAL INPUT	⑫ CN501-DISPLAY #1:12V #2~6:LED Control #7: BZ1 #8: Remote control signal output #9: AUTO SW #10: REMOCON INT #11:GND #12:VCC #13:BZ2
⑬ CN201-E2P Modules	⑭ CN808-Electric sides #1~4: EEV #5,6: 12V	⑮ CN801-SPI #1,2:GND #3:SPI Control	⑯ CN311-2 Communication
⑰ CN702-HALL IC #1: 12V #2: VENT OUT	⑱ CN806-SLIDE 2/3 #1,2 : Indoor and outdoor group communication #3 :12V #4 : GND #5 : Wired	⑲ CN2-SLIDE 1 #1: 310V #2: N.C #3: AGND #4: 15V #5: MOTOR SIGNAL PWM #6: MOTOR FEEDBACK	

5-1-10 Duct type(MSP, HSP, Big Duct)

- MAIN PCB (AM***FNMDEH*, AM***FNHDEH*)

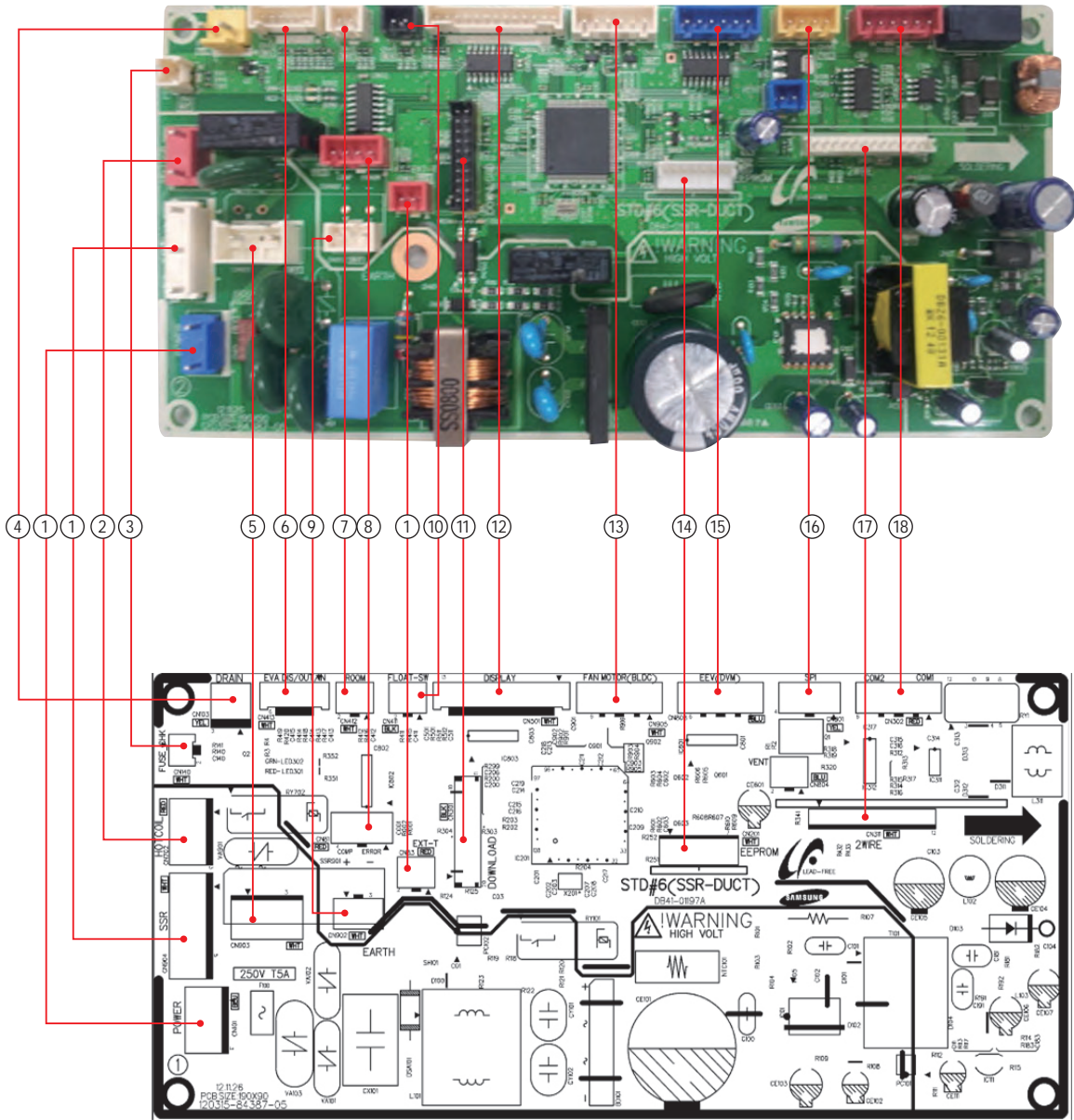

Duct type(MSP, HSP, Big Duct) (cont.)

– MAIN PCB (AM***FNMDEH*, AM***FNHDEH*) (cont.)

① CN904-SSR MOTOR #1: N #2: L #3: N	② CN702-HOT COIL #1: L #2: N	③ CN140-FUSE CHECK #1:FUSE CHECK #2:GND	④ CN103-DRAIN PUMP #1: 12V #2 : GND
⑤ CN903-SSR AC CONTROL #1: L INPUT #2: L OUTPUT	⑥ CN413-TEMP SENSOR #1 : EVA IN TEMP #2,4,6: GND #3 : EVA OUT TEMP #5 : DISCHARGE TEMP	⑦ CN412-ROOM TEMP Sensor #1: INPUT TEMP #2: GND	⑧ CN81-EXTERNAL CONTROL OUT #1,3: 12V #2: ERROR CHECK OUT #4: COM CHK OUT
⑨ CN902- SSR DC OUTPUT #1: 12V #2: MOTOR SSR OUT	⑩ CN83-EXTERNAL CONTROL #1: GND #2: EXT CTRL	⑪ CN301-MICOM DOWNLOAD	⑫ CN501-DISPLAY #1:12V #2~6:CONTROL LED #7: BZ1 #8: OUTPUT SIGNAL REMOCON #9: AUTO SW #10: REMOCON INT #11:GND #12:VCC #13:BZ2
⑬ CN905-BLDC MOTOR #1:12V #2: GND #3: VCC #4: MOTOR SIGNAL PWM #5: MOTOR FEEDBACK #6:INRUSH OUT #12:VCC	⑭ CN201-E2P MODULE	⑮ CN808-EEV #1~4:EEV CONTROL #5,6:12V	⑯ CN801-SPI #1,2:GND #3:SPI CONTROL
⑰ CN311-2 WIRE COMM	⑱ CN302-INDOOR UNIT & OUTDOOR UNIT COMM/CABLE #1,2: INDOOR UNIT & OUTDOOR UNIT COMM #3:12V #4:GND #5: WIRED REMOCON COMM	⑲ CN101-AC INPUT #1: L #2: N	

5-1-11 Duct type(HSP)

- BLDC PCB (AM112/128/140FNHDEH*)

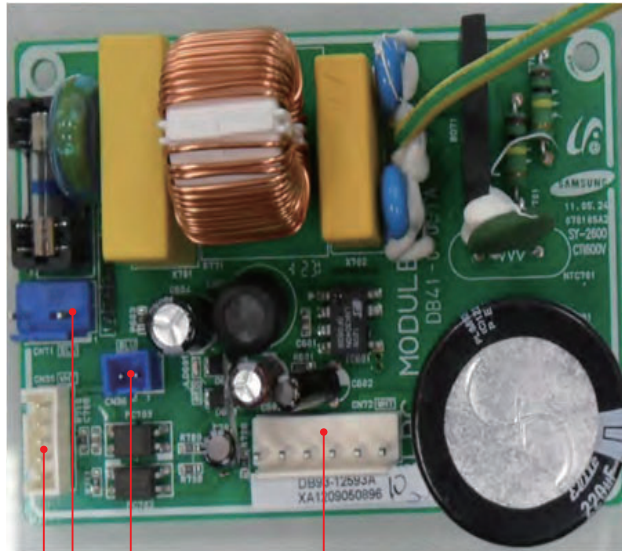

- ①
- ②
- ③
- ④

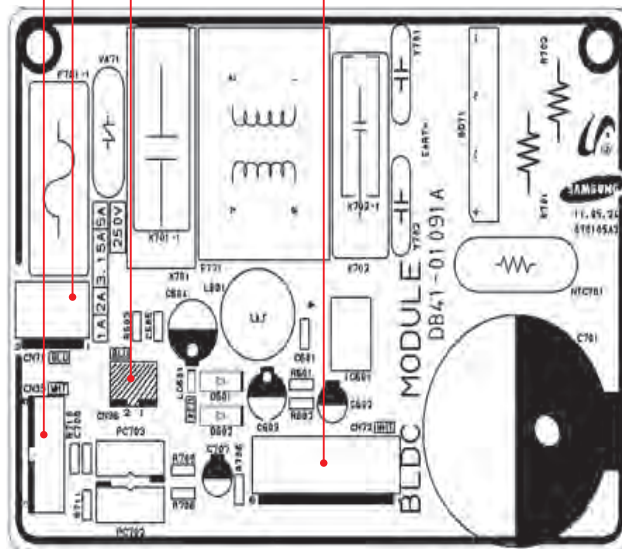

Duct type(HSP) (cont.)**– BLDC PCB (AM112/128/140FNHDEH*) (cont.)**

① CN35-Main PCB Connection #1: DC12V #2: Fan Signal #3: DC5V #4: Fan feedback signal #5: GND	② CN71-AC Power #1: AC power L #2: AC power N	③ CN36-BLDC PCB Connection #1: DC12V #2: Fan signal	④ CN12-Motor Connector #1: DC310V #3: GND #4: DC15V #5: Fan signal #6: Fan feedback signal
--	--	--	--

Duct type (Super) (cont.)**– MAIN PCB (AM***FNFDEH*) (cont.)**

① CN100-POWER #1: LIVE #2: - #3: NEUTRAL	② CN703-FAN STEP #1: NEUTRAL #2: - #3: FAN_LOW_OUT #4: - #5: FAN_MID_OUT #6: - #7: FAN_HUGH_OUT #8: - #9: FAN_TURBO_OUT	③ CN702-HOT COIL #1: NEUTRAL #2: LIVE	④ CN140-FUSE CHECKER
⑤ CN81-ERROR/COMP CHECK #1: 12V #2: ERROR_CHK_OUT #3: 12V #4: COMP_CHK_OUT	⑥ CN413-EVA IN/EVA OUT/ DISCHARGE TEMP #1: EVA-IN #2: EVA-IN #3: EVA-OUT #4: EVA-OUT #5: DISCHARGE #6: DISCHARGE	⑦ CN301-DOWNLOAD	⑧ CN412-ROOM TEMP #1: ROOM TEMP #2: ROOM TEMP
⑨ CN103-DC DRAIN PUMP #1: DRAIN_PUMP_OUT #2: GND	⑩ CN83-EXT_CONTROL	⑪ CN501-DISPLAY #1: 12V #2: LED_0_OUT #3: LED_1_OUT #4: LED_2_OUT #5: LED_3_OUT #6: LED_4_OUT #7: BZ_1 #8: REMOCON_SIGN_OUT #9: AUTO_SW #10: REMOCON_INT #11: GND #12: 5V #13: BZ_2	⑫ CN808-EEV(DVM) #1: EEV'_B_OUT #2: EEV'_A_OUT #3: EEV_B_OUT #4: EEV_A_OUT #5: 12V #6: 12V
⑬ CN804-VENTILATOR #1: 12V #2: VENT_OUT	⑭ CN201-EEPROM	⑮ CN801-SPI #1: GND #2: GND #3: SPI_CTRL_OUT_1 #4: -	⑯ CN302-COM1/COM2 #1: COM1_A #2: COM1_B #3: 12V #4: GND #5: COM2_C #6: COM2_D

5-1-13 Duct type (Global Duct)

- Main PCB (AM***HNMPKH*)
- Main PCB (AE071/090MNMPEH/EU)

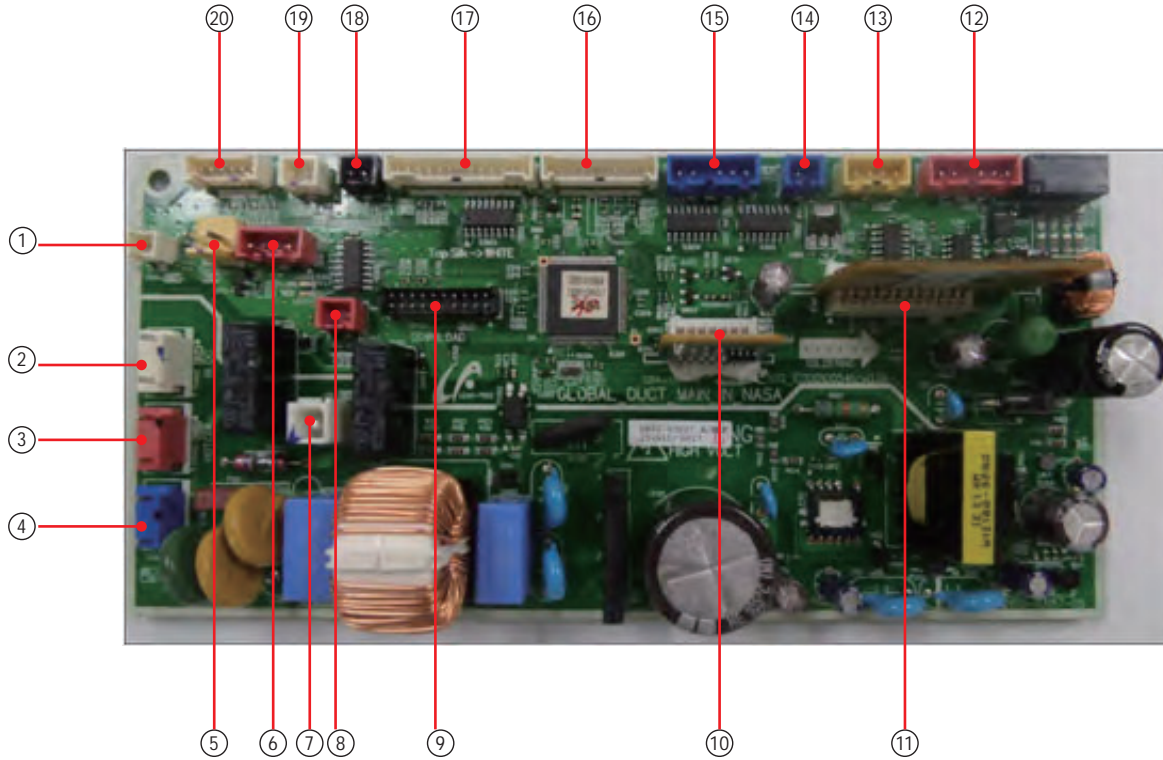

No	Part Code	Local	Function	Description
1	3711-003942	CN140	Fuse Check	SMW200-02P WHT #1 - FUSE CHECK, #2 - GND
2	3711-000203	CN906	BLDC POWER	YW396-03AV WHT #1 - N, #3 - L
3	3711-003407	CN702	HOTCOIL	YW396-03AV RED #1 - N, #3 - L
4	3711-003404	CN101	MAIN POWER	YW396-03AV BLU #1 - L, #3 - N
5	3711-000179	CN701	DRAIN	YW396-02V YEL #1 - DRAIN PUMP OUT, #2 - GND
6	3711-000939	CN81	ERROR CHECK COMP CHECK	SMW250-04 RED #1,2 - ERROR CHECK SIGNAL #3 - 12V, #4 - COMP CHECK SIGNAL
7	3711-000744	CN1	EARTH	YDW236-01WHT
8	3711-000796	CN83	EXT-T	SMW250-02 RED #1,2 - EXT SIGNAL
9	3711-002001	CN301	DOWNLOAD	YDW200-20 #1,2 - COM SIGNAL #3~8,12~16,18~20 - DOWNLOAD SIGNAL #9,17 - GND, #10,11 - 5V
10	3711-007817	CN201	EPPROM	B7P-MQ WHT #1 - GND, #2 - NC, #3 - 5V #4,5,6,7 - EEPROM SIGNAL
11	3711-004773	CN311	2 WIRE	BMW200-12 WHT #1 - 12V, #6 - 5V, #12 - GND #2~5,7~11 - COM2 SIGNAL
12	3711-001037	CN302	COMM	SMW250-06 RED #1,2,5,6 - COM SIGNAL #3 - 12V, #4 - GND
13	3711-000941	CN801	SPI	SMW250-04 YEL #1,#2 - GND, #3 - SPI CTRL, #4 - NC

Duct type (Global Duct) (cont.)

– MAIN PCB (AM***HNMPKH*) (cont.)

– MAIN PCB (AE071/090MNMPEH/EU) (cont.)

No	Part Code	Local	Function	Description
14	3711-000795	CN804	VENT	SMW250-02 BLU #1 - 12V, #2 - VENT OUT
15	3711-001036	CN808	EEV	SMW250-06 BLU #1~4 - EEV SIGNAL, #5,6 - 12V
16	3711-004182	CN905	FAN MOTOR COMM	SMW200-10P WHT #1 - 12V, #2 - GND #3 - 5V, #4 - BLDC POWER RELAY SIGNAL #5 - OVER TEMP, #6 IPM_FO #7 - REV OUT, #8 - FAN FEEDBACK #9 - INRUSH RELAY SIGNAL, #10 - FAN PWM
17	3711-003895	CN501	DISPLAY	SMW200-13P WHT #1 - 12V, #2~6 - LED OUT #7 - Buz1, #8 - REMOCON OUT #9 - AUTO S/W, #10 - REMOCON-INT #11 - GND, #12 - 5V, #13 - Buz2
18	3711-000794	CN411	FLOAT-SW	SMW250-02 BLK #1 - FLOAT S/W SIGNAL, #2 - GND
19	3711-000015	CN412	ROOM SENSOR	SMW250-02 WHT #1 - ROOM SENSOR SIGNAL, #2 - GND
20	3711-004236	CN413	EVA DIS/OUT SENSOR	SMW200-06P WHT #1 - EVA IN SIGNAL #3 - EVA OUT SIGNAL #5 - DISCHARGE SIGNAL #2,4,6 - GND #1 - L, #3 - N

Duct type (Global Duct) (Cont.)

- SUB PCB (AM***HNMPKH*) (cont.)

- SUB PCB (AE071/090MMPEH/EU) (cont.)

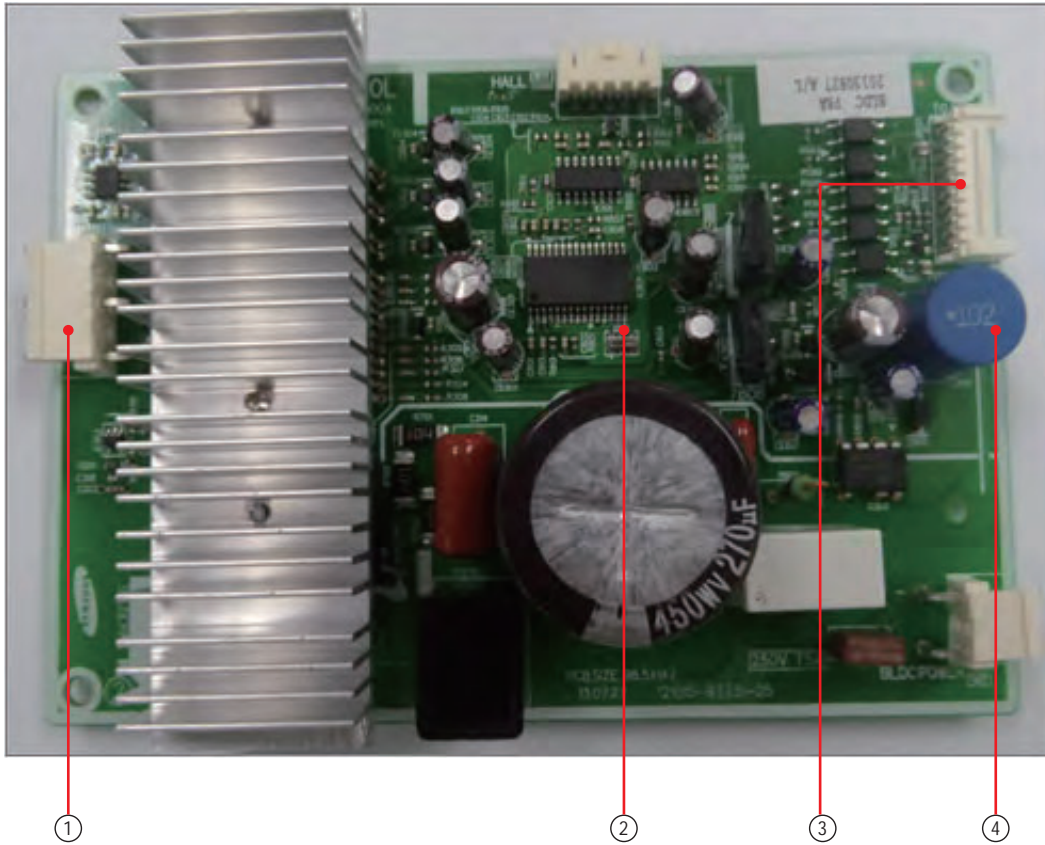

No	Part Code	Local	Function	Description
1	3711-003381	CN301	FAN MOTOR	YAW396-05AV WHT #1 - U, #2 - V, #3 - W
2	3711-000992	CN101	HALL	SMAW250-05 WHT #1 - 5V, #2-4 - HALL, #5 - GND
3	3711-004531	CN501	FAN MOTOR COMM	SMAW200-10P WHT #1 - 12V, #2 - GND #3 - 5V, #4 - BLDC POWER RELAY #5 - OVER TEMP #6 - RST #7 - REV OUT, #8 - FAN FEEDBACK #9 - INRUSH RELAY, #10 - FAN PWM
4	3711-003380	CN701	POWER	YAW396-03AV WHT #1 - L, #2 - N

5-1-14 Duct type (Global Duct_HSP)

– SUB PCB (AM***HNHPKH*)

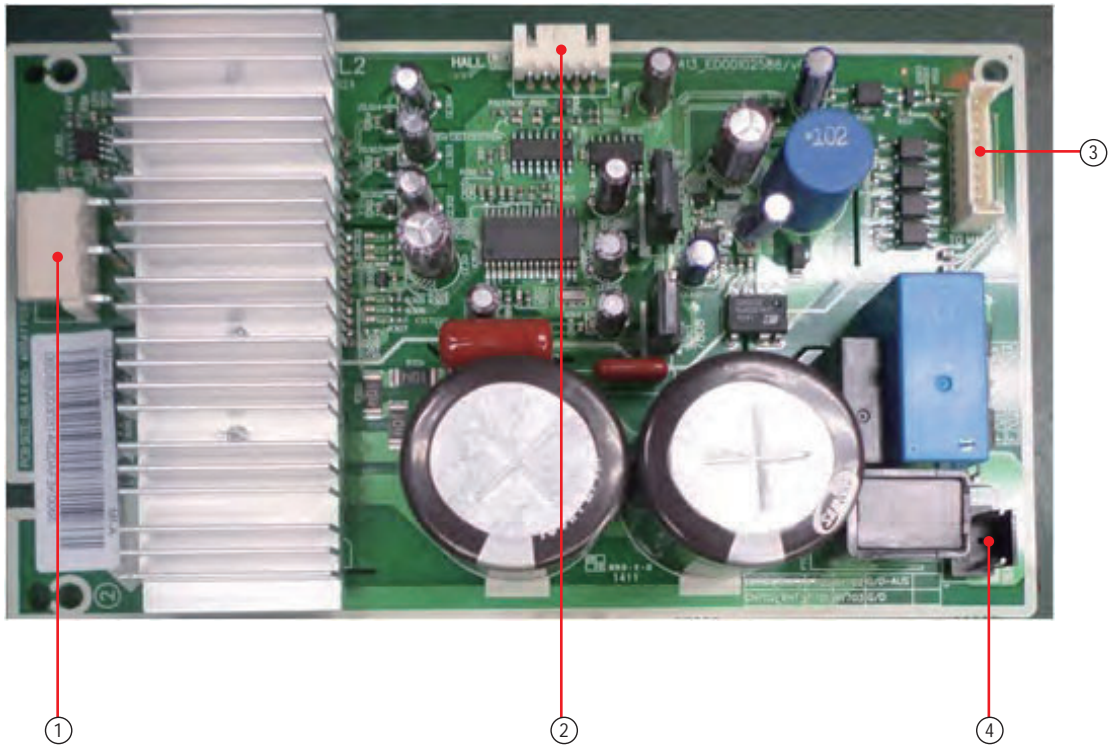

No	Part Code	Local	Function	Description
1	3711-003381	CN301	FAN MOTOR	1WALL,5P,1R,3,96mm,ANGLE,SN,WHT #1 - U, #2 - V, #3 - W
2	3711-000992	CN101	HALL	BOX,5P,1R,2,5MM,ANGLE,SN,WHT #1 - 5V, #2~4 - HALL, #5 - GND
3	3711-004182	CN501	FAN MOTOR COMM	BOX,10P,1R,2mm,STRAIGHT,SN,WHT #1 - 12V, #2 - GND #3 - 5V, #4 - BLDC POWER RELAY #5 - OVER TEMP #6 - RST #7 - REV OUT, #8 - FAN FEEDBACK #9 - INRUSH RELAY, #10 - FAN PWM
4	3711-003405	CN701	POWER	1WALL,2P,1R,7,92mm,STRAIGHT,SN,BLK #1 - N, #2 - L

Duct type (Global Duct_HSP)(Cont.)

- SUB PCB (AM***HNHPKH*) (cont.)

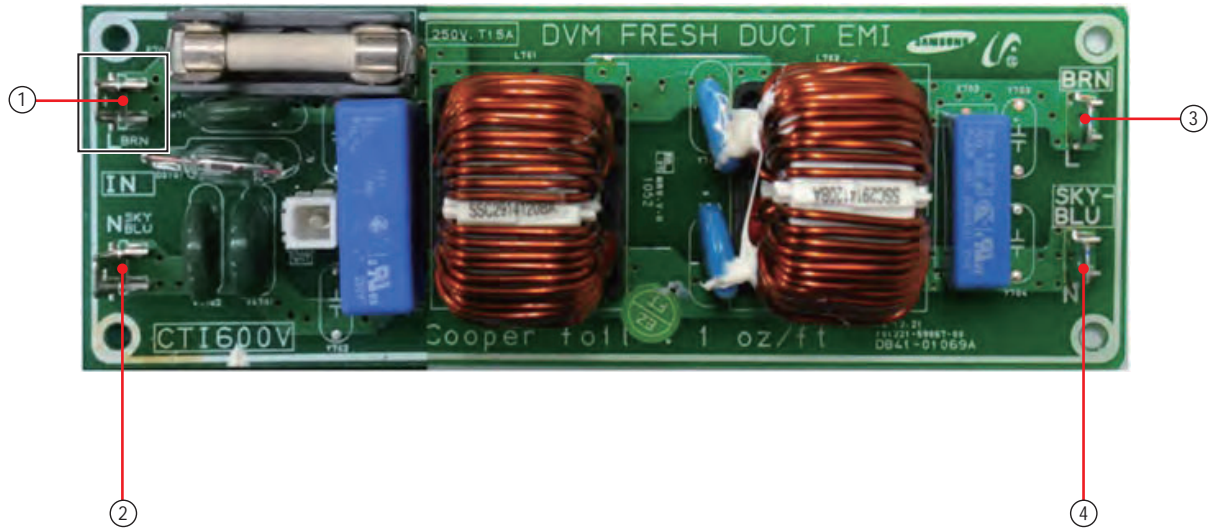

No.	part code	location No.	Function	Description
1	3712-001139	L	IN-L	TAB,MALE,6.35x0.8mm
2	3712-001139	N	IN-N	TAB,MALE,6.35x0.8mm
3	3712-001139	L	OUT-L	TAB,MALE,6.35x0.8mm
4	3712-001139	N	OUT-N	TAB,MALE,6.35x0.8mm

Duct type (Global Duct_HSP) (Cont.)

– SUB PCB (AM***HHPKH*) (cont.)

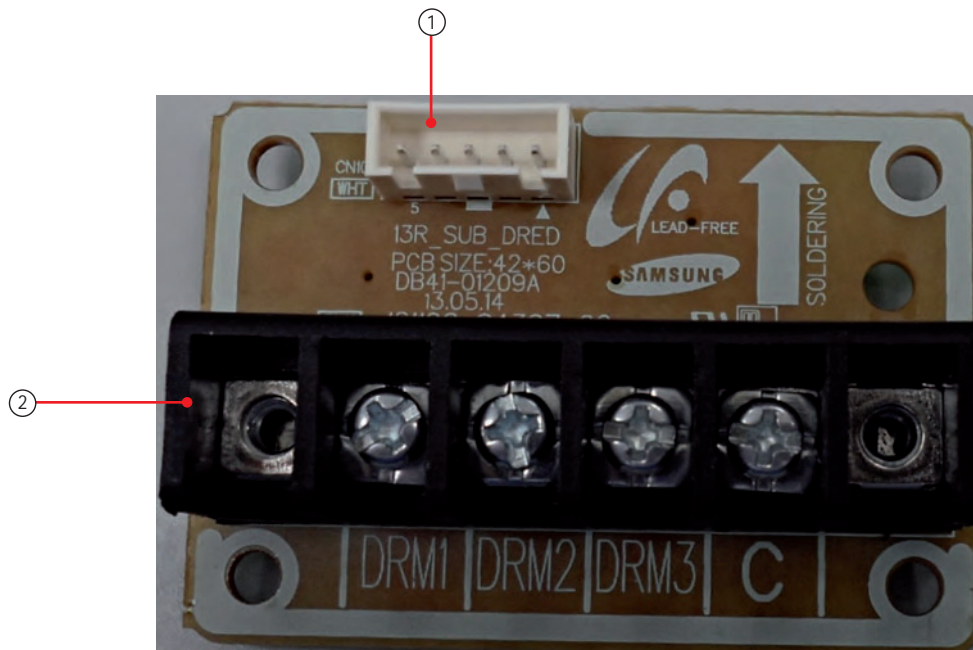

No.	part code	location No.	Function	Description
1	3711-000999	CN101	DRED COMM	BOX,5P,1R,2.5mm,STRAIGHT,SN,WHT #1~3 - DRED SIGNAL, #4 - GND, #5 - VCC
2	DB65-00320A	CN102	DRED T/B	DAPC-2009,BRASS,6P,55.5*6.5*14,BLK
4	3712-001139	N	OUT-N	TAB,MALE,6.35x0.8mm

5-1-15 Big Duct

- Main PBA (AM***JNHFKH*)

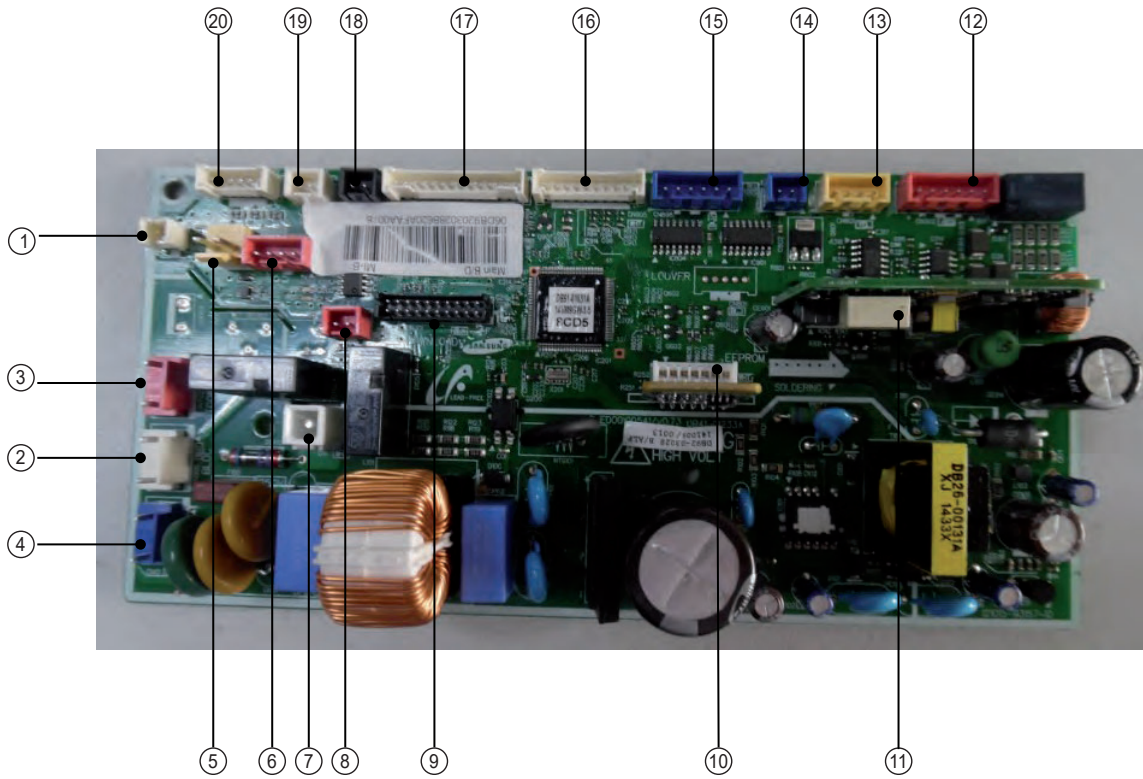

No	part code	location No.	Function	Description
1	3711-003942	CN140	Fuse Check	SMW200-02P WHT
2	3711-000203	CN906	BLDC POWER	YW396-03AV WHT
3	3711-003407	CN702	Comp Signal	YW396-03AV RED
4	3711-003404	CN101	MAIN POWER	YW396-03AV BLU
5	3711-000179	CN701	DRAIN	YW396-02V YEL
6	3711-000939	CN81	COMP ERROR	SMW250-04 RED
7	3711-000744	CN1	EARTH	YDW236-01WHT
8	3711-000796	CN83	EXT-T	SMW250-02 RED
9	3711-002001	CN301	DOWNLOAD	YDW200-20
10	3711-007817	CN201	EPPROM	B7P-MQ WHT
11	3711-004773	CN311	2 WIRE	BMW200-12 WHT
12	3711-001037	CN302	COMM	SMW250-06 RED
13	3711-000941	CN801	SPI	SMW250-04 YEL
14	3711-000795	CN804	VEN	SMW250-02 BLU
15	3711-001036	CN808	EEV	SMW250-06 BLU
16	3711-004182	CN905	FAN MOTOR COMM	SMW200-10P WHT
17	3711-003895	CN501	DISPLAY	SMW200-13P WHT
18	3711-000794	CN411	FLOAT-SW	SMW250-02 BLK
19	3711-000015	CN412	ROOM SENSOR	SMW250-02 WHT
20	3711-004236	CN413	EVA DIS/OUT SENSOR	SMW200-06P WHT

Big Duct (cont.)

- EMI PBA (AM***JNHFKH*)

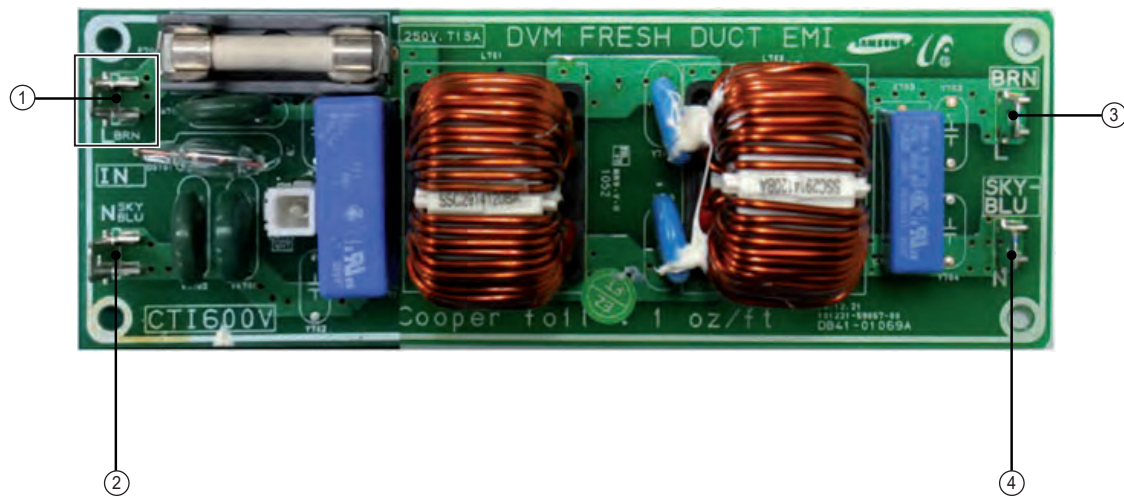

No	part code	location No.	Function	Description
1	3712-001139	L	IN-L	TAB,MALE,6.35x0.8mm
2	3712-001139	N	IN-N	TAB,MALE,6.35x0.8mm
3	3712-001139	L	OUT-L	TAB,MALE,6.35x0.8mm
4	3712-001139	N	OUT-N	TAB,MALE,6.35x0.8mm

Big Duct (cont.)

- BLDC PBA (AM***JNHFKH*) (cont.)

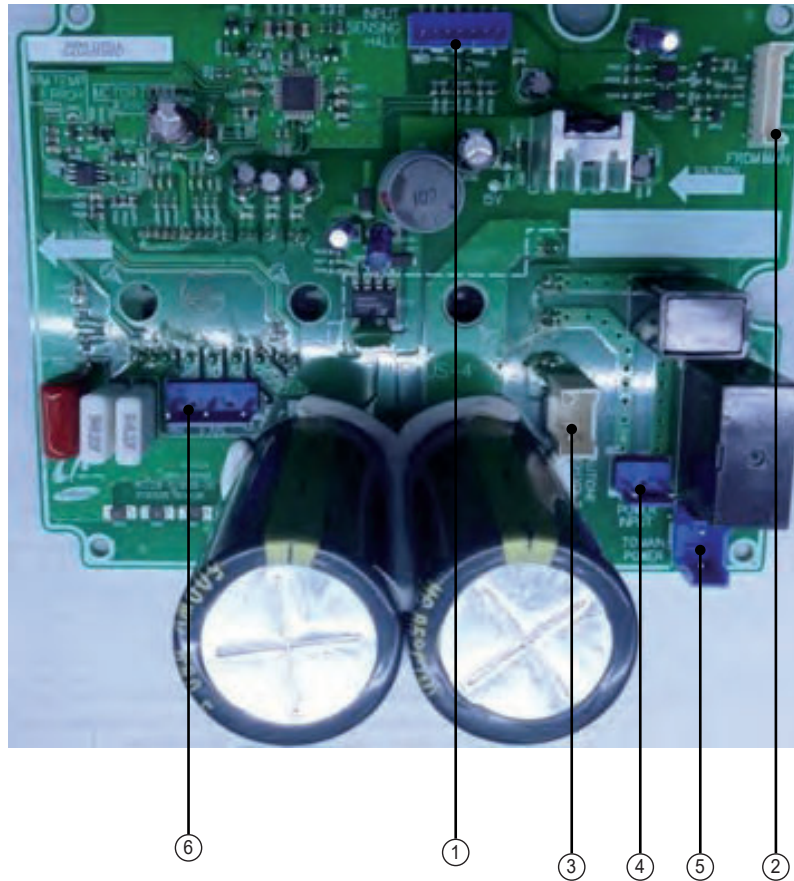

No	part code	location No.	Description
1	3711-001080	CN12	Motor signal
2	3711-004712	CN11	Main to BLDC signal
3	3711-005852	CN15	Reactor connect
4	3711-003404	CN10	BLDC PBA power
5	3711-006048	CN14	Main PBA power
6	3711-000260	CN13	Motor power

5-1-16 Ceiling type

- MAIN PCB (AM***FNCDEH*)

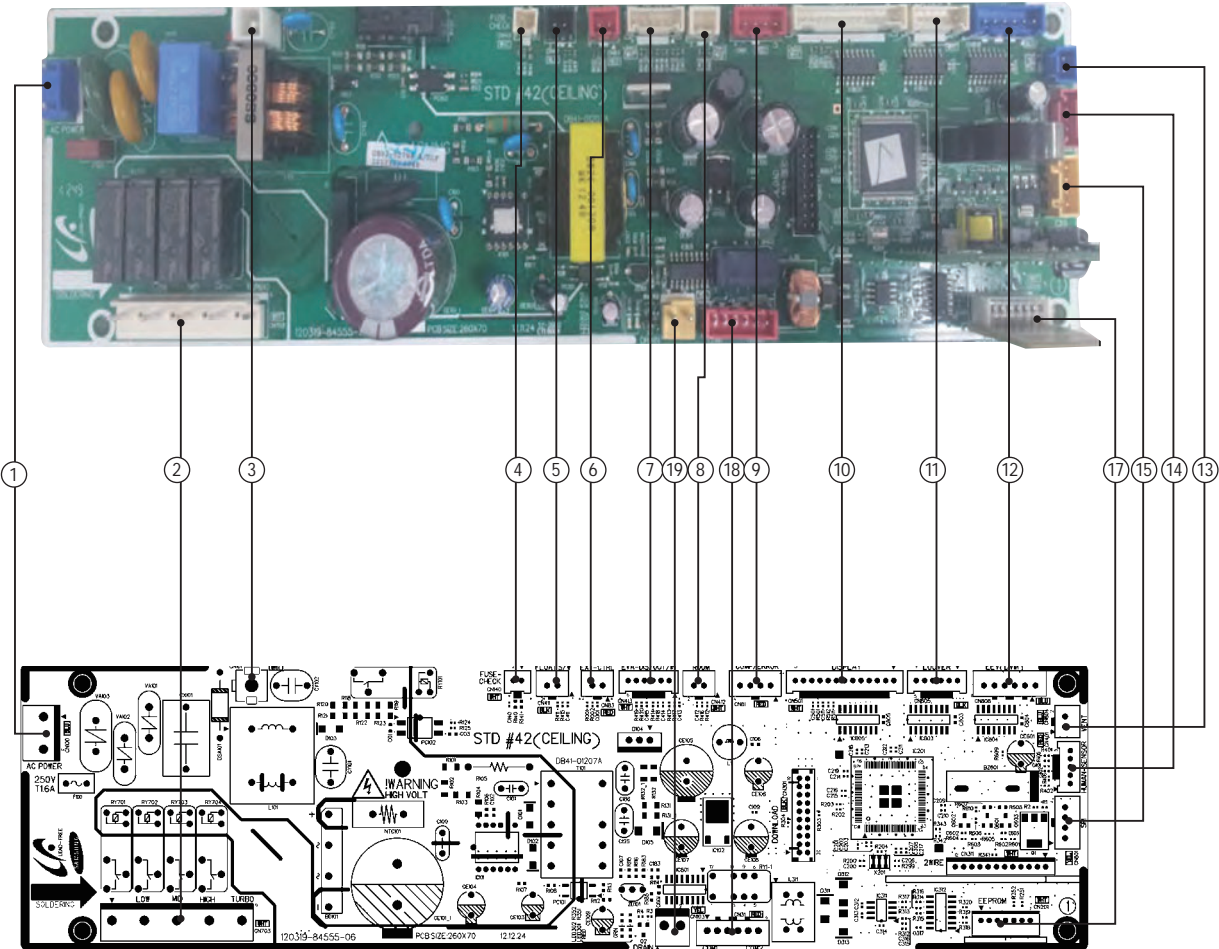

Celiling type (cont.)**- MAIN PCB (AM***FNCDEH*) (cont.)**

① CN100-VENTILATOR #1: L #3: N	② CN703-FAN MOTOR #1: N #3: RY701 OUTPUT #5: RY702 OUTPUT #7: RY703 OUTPUT #9: RY704 OUTPUT	③ CN101-GND #1: GND	④ CN140-FUSE CHECK #1: FUSE CHECK #2: GND
⑤ CN411-FLOAT S/W #1: FLOAT_SW #2: GND	⑥ CN83-EXT CTRL #1: GND #2: EXT_CTRL	⑦ CN413-EVA-DIS/OUT/IN #1: VEA_IN_MID_TEMP #2: GND #3: EVA_OUT_TEMP #4: GND #5: EVA_DIS_TEMP #6: GND	⑧ CN412-ROOM #1: ROOM_TEMP #2: GND
⑨ CN81-COMP/ERROR #1: DC 12V #2: ERROR_CHK_OUT #3: DC 12V #4: COMP_CHK_OUT	⑩ CN501-DISPLAY #1: DC 12V #2~#7: LED SIGNAL #8: REMOCON_SIGN_OUT #9: AUTO_SW #10: REMOCON_INT #11: GND #12: DC 5V #13: NOT USED	⑪ CN805-LOUVER #1: DC 12V #2: DC 12V #3~#6: LVR SIGNAL	⑫ CN808-EEV(DVM) #1~#4: EEV SIGNAL #5: DC 12V #6: DC 12V
⑬ CN804-VENT #1: DC 12V #2: VENT_OUT	⑭ CN401-HUMAN_SENSOR #1: DC 12V #2: COM4_TXD #3: COM4_RXD #4: NOT USED #5: GND	⑮ CN801-SPI #1: GND #2: GND #3: Q1_OUT #4: NOT USED	⑯ CN311-2WIRE OPTION #1:DC12V #2~#5:COMM. SIGNAL #6:VCC(DC5V) #7~#11:COMM. SIGNAL #12:GND
⑰ CN201-EEPROM #1:GND #2:NOT USED #3:VCC(DC5V) #4~#7:EEPROM SIGNAL	⑱ CN31-HUMAN_SENSOR #1~#2: COM1 SIGNAL #3: DC12V #4: GND #5~#6: COM2 SIGNAL	⑲ CN103-DRAIN #1: DRAIN SIGNAL #2: GND	

5-1-17 Big Ceiling

- MAIN PBA (AM***JNCDKH*)

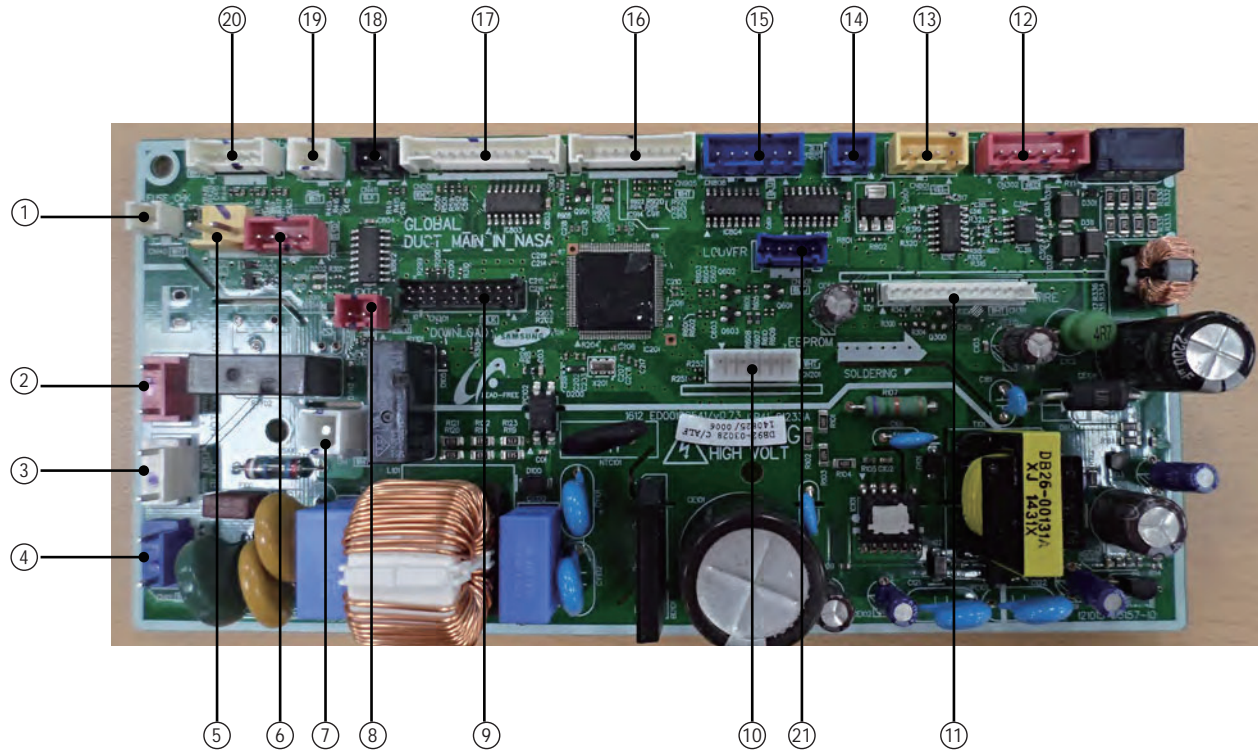

No	part code	location No.	Function	Description
1	3711-003942	CN140	Fuse Check	SMW200-02P WHT
2	3711-000203	CN906	BLDC POWER	YW396-03AV WHT
3	3711-003407	CN702	Comp Signal	YW396-03AV RED
4	3711-003404	CN101	MAIN POWER	YW396-03AV BLU
5	3711-000179	CN701	DRAIN	YW396-02V YEL
6	3711-000939	CN81	COMP ERROR	SMW250-04 RED
7	3711-000744	CN1	EARTH	YDW236-01WHT
8	3711-000796	CN83	EXT-T	SMW250-02 RED
9	3711-002001	CN301	DOWNLOAD	YDW200-20
10	3711-007817	CN201	EPPROM	B7P-MQ WHT
11	3711-004773	CN311	2 WIRE	BMW200-12 WHT
12	3711-001037	CN302	COMM	SMW250-06 RED
13	3711-000941	CN801	SPI	SMW250-04 YEL
14	3711-000795	CN804	VEN	SMW250-02 BLU
15	3711-001036	CN808	EEV	SMW250-06 BLU
16	3711-004182	CN905	FAN MOTOR COMM	SMW200-10P WHT
17	3711-003895	CN501	DISPLAY	SMW200-13P WHT
18	3711-000794	CN411	FLOAT-SW	SMW250-02 BLK
19	3711-000015	CN412	ROOM SENSOR	SMW250-02 WHT
20	3711-004236	CN413	EVA DIS/OUT SENSOR	SMW200-06P WHT
21	3711-005097	CN601	LOUVER	SMW200-5P BLU

Big Ceiling (cont.)

- SUB PCB DIAGRAM (AM***JNCDKH*) (cont.)

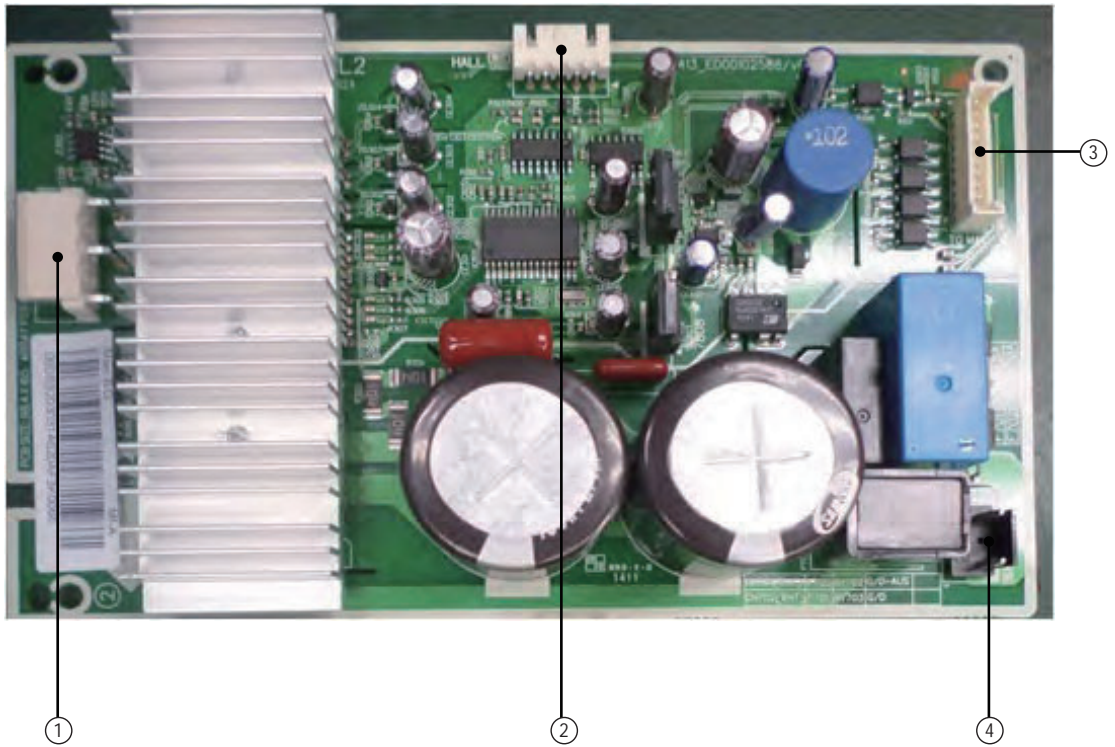

No	Part Code	Local	Function	Description
1	3711-003381	CN301	FAN MOTOR	1WALL,5P,1R,3.96mm,ANGLE,SN,WHT #1 - U, #2 - V, #3- W
2	3711-000992	CN101	HALL	BOX,5P,1R,2.5MM,ANGLE,SN,WHT #1 - 5V, #2~4 - HALL, #5 - GND
3	3711-004182	CN501	FAN MOTOR COMM	BOX,10P,1R,2mm,STRAIGHT,SN,WHT #1 - 12V, #2 - GND #3 - 5V, #4 - BLDC POWER RELAY #5 - OVER TEMP #6 - RST #7 - REV OUT, #8 - FAN FEEDBACK #9 - INRUSH RELAY, #10 - FAN PWM
4	3711-003405	CN701	POWER	1WALL,2P,1R,7.92mm,STRAIGHT,SN,BLK #1 - N, #2- L

5-1-18 Console

- MAIN PCB (AM***FNJDEH*, AM***KNJDEH*)
- MAIN PCB (AE022/028/036/056MNJDEH/EU)

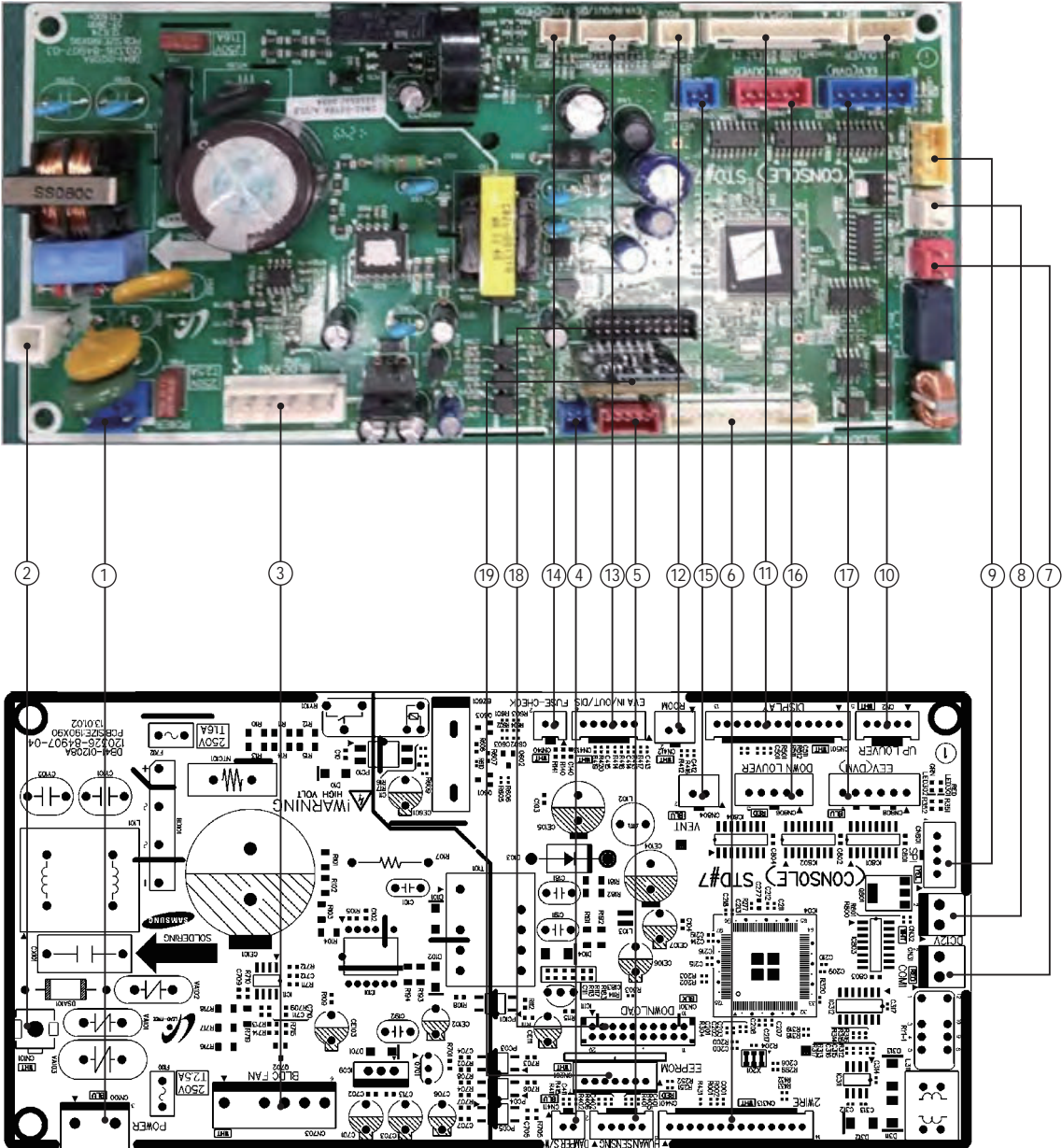

Console (cont.)**- MAIN PCB (AM***FNJDEH*, AM***KNJDEH*) (cont.)****- MAIN PCB (AE022/028/036/056MNJDEH/EU) (cont.)**

① CN100-AC POWER #1: L #3: N	② CN101-GND #1: GND	③ CN703-FAN MOTOR #1:DC310V #2:NOT USED #3:AGND #4:DC15V #5:PC04 OUTPUT #6:RPM OUTPUT	④ CN411-FLOAT S/W #1:FLOAT S/W #2:GND
⑤ CN401-HUMAN SENSING #1:DC12V #2,#3:COMM. SIGNAL #4:NOT USED #5:GND	⑥ CN313-2WIRES COMM. #1~#4:COMM. SIGNAL #5:EXTERNAL CONTROL #6:COMP CHECK #7:ERROR CHECK #8:VCC(DC5V) #9:GND #10:DC12V #11~#14:COMM. SIGNAL	⑦ CN31-COMM.1 #1:COMM. SIGNAL F1 #2:COMM. SIGNAL F2	⑧ CN32-DC12V #1:DC12V #2:GND
⑨ CN801-SPI #1:GND #2:GND #3:CONTROL SIGNAL #4:NOT USED	⑩ CN2-UP LOUVER #1:DC12V #2~#5:CONTROL SIGNAL	⑪ CN501-DISPLAY #1:DC12V #2~#6:DISPLAY LED CONTROL #7:VCC(DC5V) #8:REMOCON SIGNAL OUT #9:TOUCH SWITCH SIGNAL #10:REMOCON SIGNAL IN #11:GND #12:VCC(DC5V) #13:NOT USED	⑫ CN412-ROOM SENSOR #1:ROOM TEMP. SENSOR #2:GND
⑬ CN413-EVA IN/OUT #1:EVA IN/OUT TEMP. SENSOR #2:GND	⑭ CN140-FUSE CHECK #1:FUSE CHECK SIGNAL #2:GND	⑮ CN804-VENT #1:DC12V #2:VENT SIGNAL	⑯ CN806-DOWN LOUVER #2~#5:CONTROL SIGNAL
⑰ CN808-EEV #1~#4:EEV CONTROL SIGNAL #5,#6:DC12V	⑱ CN301-DOWNLOAD →For Developer only,Not available in Actual Site →20 Pin Down Loader	⑲ CN201-EEPROM PBA CONNECTOR #1:GND #2:NOT USED #3~#7:EEPROM SIGNAL	

Console (cont.)

– SUB PCB (AM***FJNJEH*, AM***KNJEH*) (cont.)

– SUB PCB (AE022/028/036/056MNJEH/EU) (cont.)

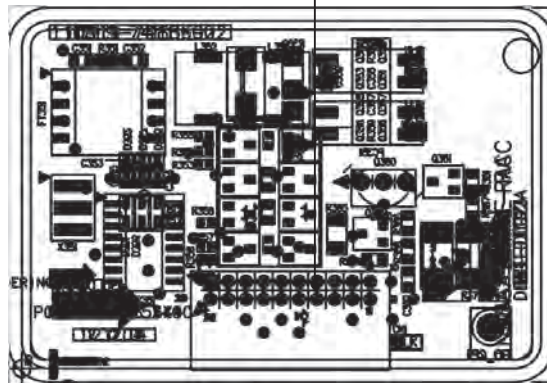
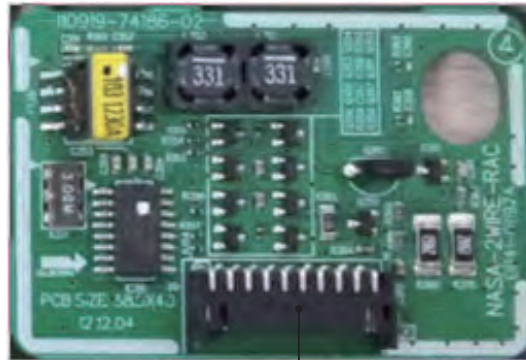

① **CN1-2WIRES COMM.**

#1,#2,#19,#20:COMM. SIGNAL
 #3,#18:EXTERNAL CONTROL
 #4,#17:COMP CHECK
 #5,#16:ERROR CHECK
 #6:VCC(DC5V)
 #7,#14:GND
 #8,#13,#15:DC12V
 #9~#12:COMM. SIGNAL

Console(cont.)

- DISPLAY (AM***FJNJEH*, AM***KNJEH*) (cont.)

- DISPLAY (AE022/028/036/056MNJEH/EU) (cont.)

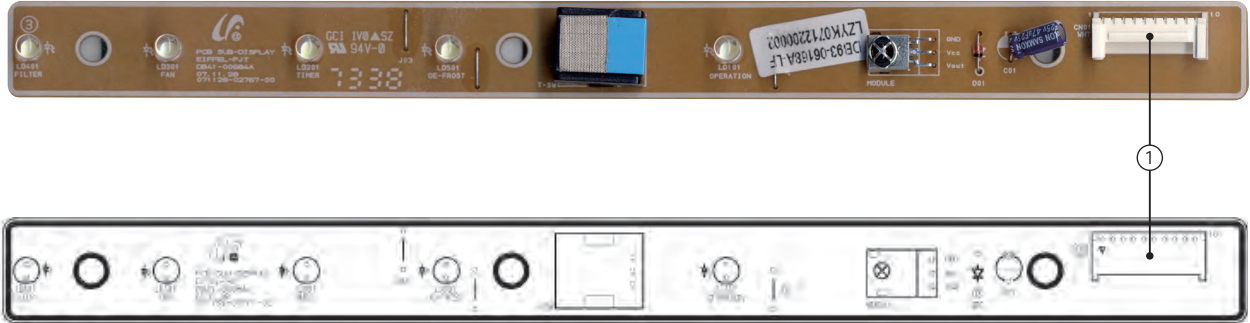

	<p>① CN01-Panel Display</p> <p>#1,#2,#3,#4,#5: Display LED Control</p> <p>#6: TOUCH S/W Reset(DC5V)</p> <p>#7: TOUCH S/W out(DC5V)</p> <p>#8: Receive REMOCON Signal</p> <p>#9: GND</p> <p>#10: VCC(DC5V)</p>
DC Connector	

■ **DAMPER**

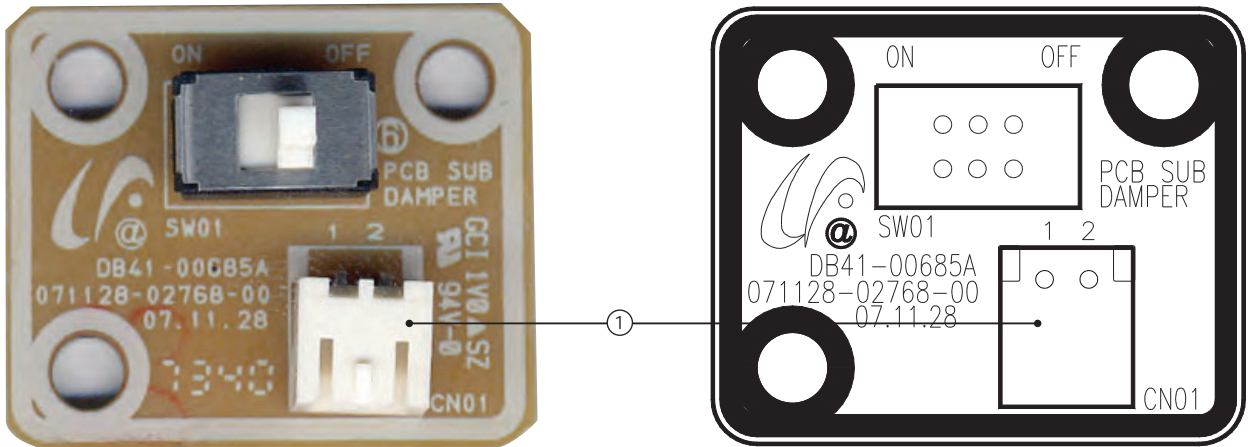

	<p>① CN01-Damper S/W</p> <p>#1: DC5V</p> <p>#2: GND</p>
DC Connector	

5-1-19 Wall-Mounted type (Neo Forte)

– MAIN (AM***FNTDEH*, AM***HNTDEH*, AM***FNQDEH*, AM***HNTDEH*)

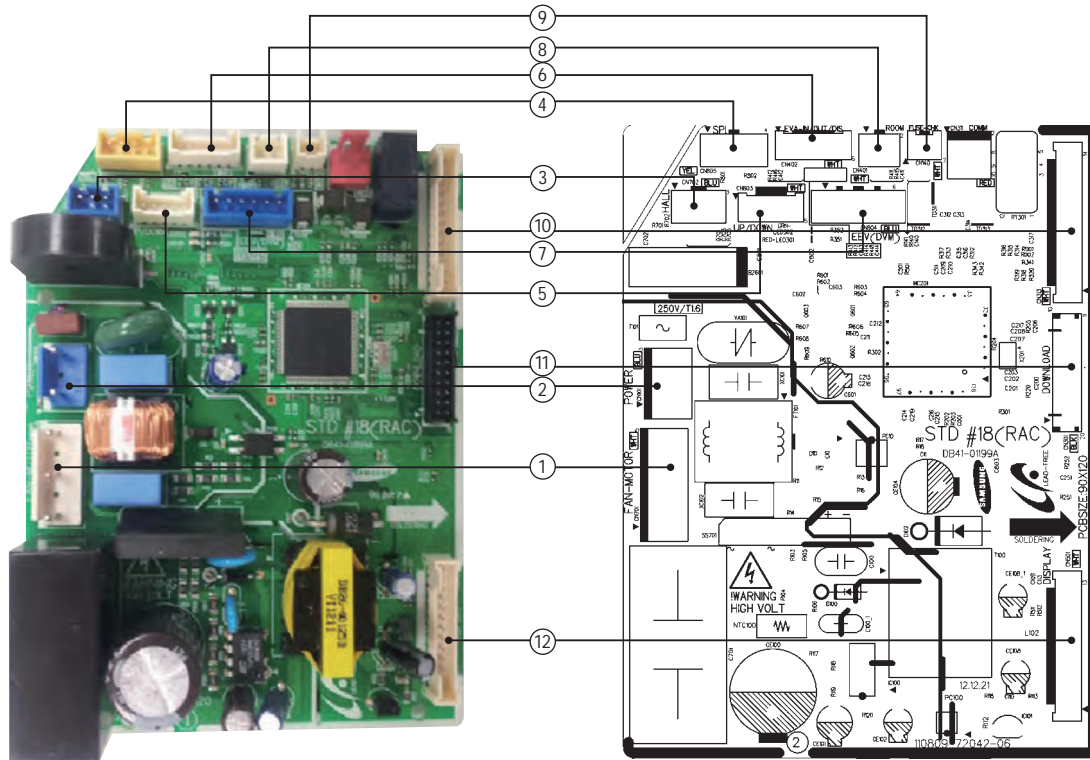

<p>① CN701-SSR MOTOR #1: 12V #2: MOTOR SSR OUT</p>	<p>② CN101-AC INPUT #1: L #2: N</p>	<p>③ CN702-HALL IC INPUT #1: VCC #2: GND #3: INPUT HALL SENSOR VALUE</p>	<p>④ CN805-SPI #1~2: GND #3: SPI CONTROL</p>
<p>⑤ CN803-UP/DOWN BLADE #1: VCC #2~5: BLADE CONTROL</p>	<p>⑥ CN402-TEMP SENSOR #1 : EVA IN TEMP #2,4,6: GND #3 : EVA OUT TEMP #5 : DISCHARGE TEMP</p>	<p>⑦ CN804-EEV #1~4: EEV CONTROL #5,6: 12V</p>	<p>⑧ CN401-ROOM TEMP SENSOR #1: INPUT TEMP #2: GND</p>
<p>⑨ CN140 - FUSE CHECK #1:FUSE CHECK #2:GND</p>	<p>⑩ CN313-2 WIRE COMM</p>	<p>⑪ CN301-MICOM DOWNLOAD</p>	<p>⑫ CN501-DISPLAY #1: 12V #2~7: LED CONTROL #8: OUTPUT SIGNAL REMOCON #9: AUTO SW #10: REMOCON INT #11:GND #12:VCC</p>

Wall-Mounted type (Neo Forte)(cont.)

- SUB SWITCH (AM***FNTDEH*, AM***HNTDEH*, AM***FNQDEH, AM***HNTDEH*) (cont.)

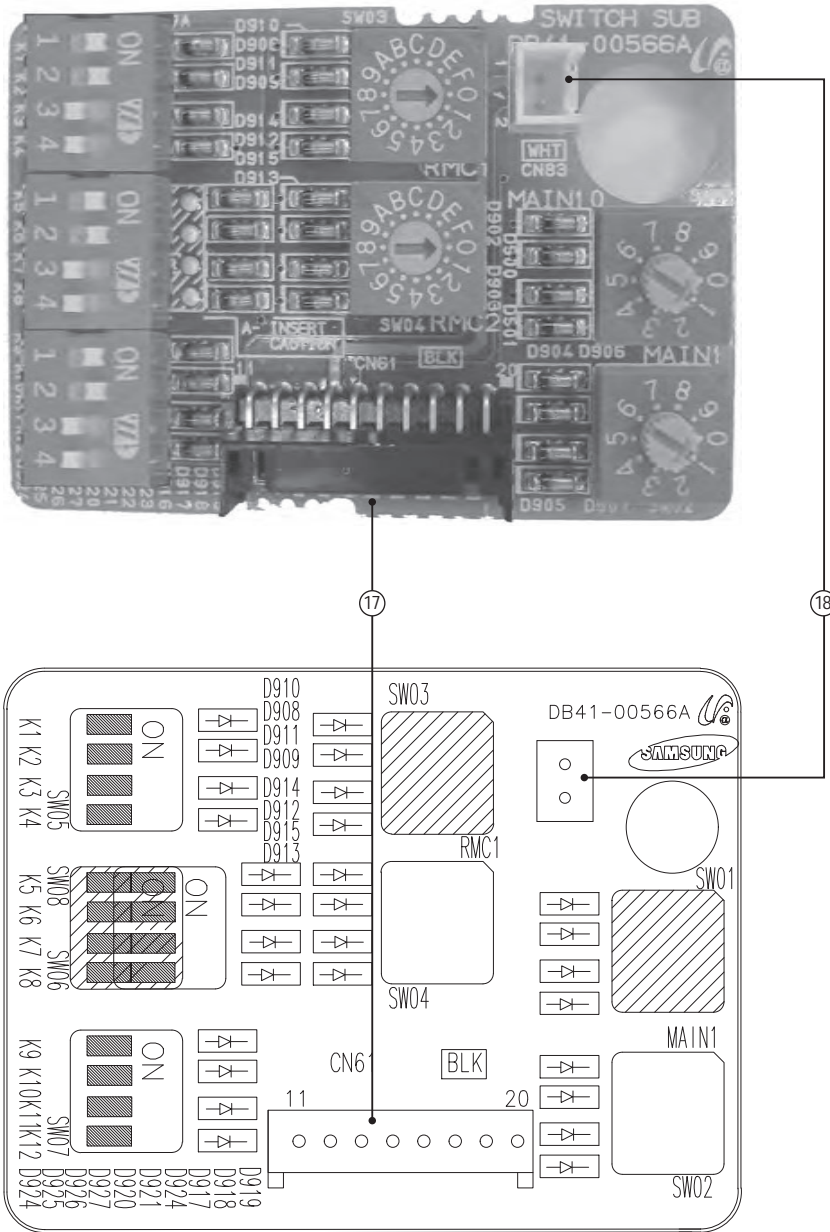

No.	CN #	COLOR	FUNCTION
⑰	CN61	Black	Main-Sub PCB Connector
⑱	CN83	White	External Contact Control

5-1-20 Wall-Mounted type (Boracay)

– Main (AM***KNQDEH*, AM***KNTDEH*)

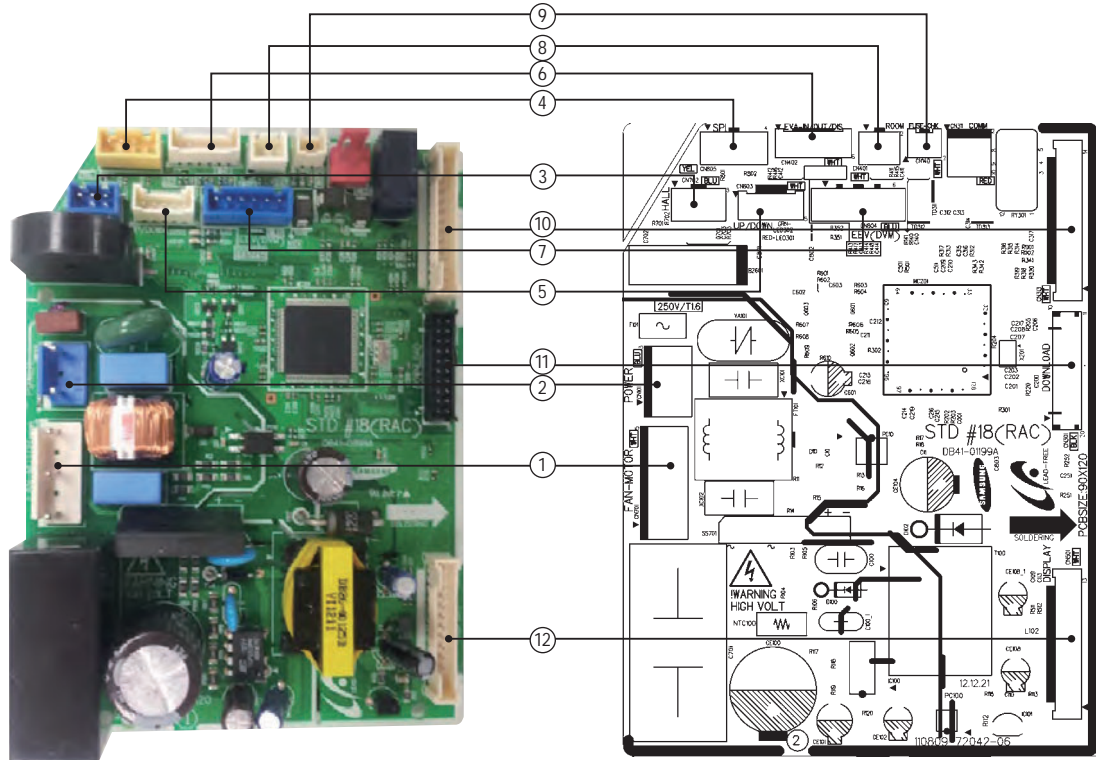

<p>① CN701-SSR MOTOR</p> <p>#1: 12V #2: MOTOR SSR OUT</p>	<p>② CN101-AC INPUT</p> <p>#1: L #2: N</p>	<p>③ CN702-HALL IC INPUT</p> <p>#1: VCC #2: GND #3: INPUT HALL SENSOR VALUE</p>	<p>④ CN805-SPI</p> <p>#1~2: GND #3: SPI CONTROL</p>
<p>⑤ CN803-UP/DOWN BLADE</p> <p>#1: VCC #2~5: BLADE CONTROL</p>	<p>⑥ CN402-TEMP SENSOR</p> <p>#1 : EVA IN TEMP #2,4,6: GND #3 : EVA OUT TEMP #5 : DISCHARGE TEMP</p>	<p>⑦ CN804-EEV</p> <p>#1~4: EEV CONTROL #5,6: 12V</p>	<p>⑧ CN401-ROOM TEMP SENSOR</p> <p>#1: INPUT TEMP #2: GND</p>
<p>⑨ CN140 - FUSE CHECK</p> <p>#1:FUSE CHECK #2:GND</p>	<p>⑩ CN313-2 WIRE COMM</p>	<p>⑪ CN301-MICOM DOWNLOAD</p>	<p>⑫ CN501-DISPLAY</p> <p>#1: 12V #2~7: LED CONTROL #8: OUTPUT SIGNAL REMOCON #9: AUTO SW #10: REMOCON INT #11:GND #12:VCC</p>

Wall-Mounted type (Boracay)(cont.)

- Sub (AM***KNQDEH*, AM***KNTDEH*)(cont.)

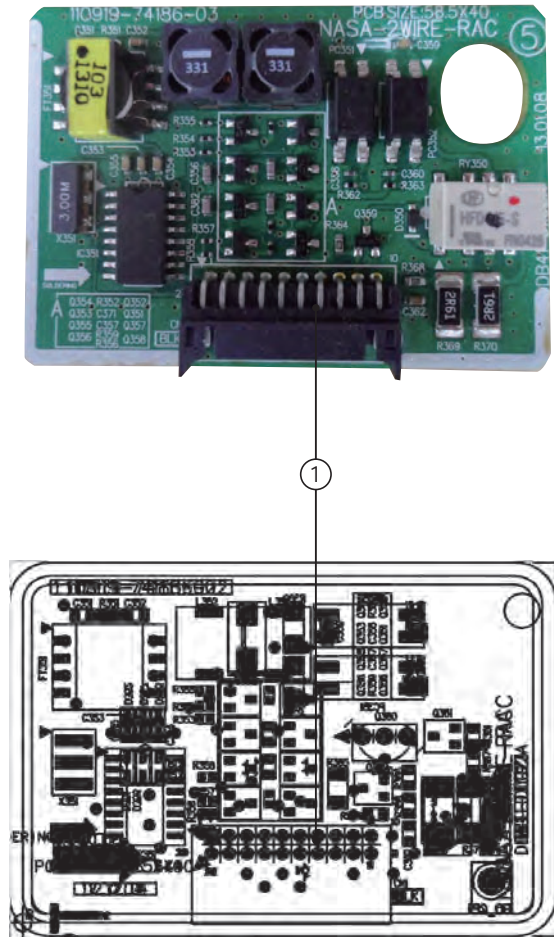

① CN1-2WIRES COMM.

- #1,#2,#19,#20:COMM. SIGNAL
- #3,#18:EXTERNAL CONTROL
- #4,#17:COMP CHECK
- #5,#16:ERROR CHECK
- #6:VCC(DC5V)
- #7,#14:GND
- #8,#13,#15:DC12V
- #9~#12:COMM. SIGNAL

ERV Plus (cont.)**- MAIN PCB (AM***FNKDEH*) (cont.)**

① TB_POWER-AC POWER #1: POWER(L) #2: POWER(N)	② CN102-GND #1 : GND	③ TB_DAMPER #1: DEMPER AC(L) #2: DEMPER AC(N)	④ CN73-BLDC MOTER1 #1: DC310V #3 : GND #4 : DC15V #5 : FAN RPM #6 : RPM FEEDBACK
⑤ CN74-BLDC MOTER2 #1: DC310V #3 : GND #4 : DC15V #5 : FAN RPM #6 : RPM FEEDBACK	⑥ CN72-INNER DAMPER #1: INNER DEMPER AC(L) #2: INNER DEMPER AC(N)	⑦ CN71-HUMID #1: HUMID AC(L) #2: HUMID AC(N)	⑧ CN140-FUSE CHECK #1: FUSE CHECK SIGNAL #2: GND
⑨ TB_COM-COMMUNICATION #1: COM1(F1) #2: COM1(F2) #3: V1(DC12V) #4: V2(GND) #5: COM2(F3) #6: COM2(F4)	⑩ CN201-EEPROM #1: GND #3: DC5V #4: EEPROM_SELECT #5: EEPROM_SO #6: EEPROM_SI #7: EEPROM_CLK	⑪ CN311-2WIRED REMOCON	⑫ CN301-DOWNLOAD
⑬ HUMID_STATE-HUMID STATE #1 : HUMID STEAT signal #2 : GND	⑭ TB_EXT1-EXT CONTROL #1 : EXT CONTROL signal #2 : GND	⑮ CN42-COND,EVA_IN/OUT SENSOR #1 : COND SENSOR #2 : GND #3 : EVA IN SENSOR #4 : GND #5 : EVA OUT SENSOR #6 : GND	⑯ CN41-IN/OUT_SIDE SENSOR #1 : IN SIDE SENSOR #2 : GND #3 : OUT SIDE SENSOR #4 : GND
⑰ CN43-CO2 SENSOR #1 : DC 12V #2 : CO2 SENSOR #3 : GND	⑱ CN62-EEV #1~#4: EEV signal #5 : DC12V #6 : DC12V	⑲ CN801-SPI #1: GND #2: GND #3: SPI POWER OUTPUT(DC12V)	⑳ CN51-FLOAT SWITCH #1: FLOAT SWITCH signal #2: GND
㉑ CN52-DAMPER SWITCH #1 : DAMPER SWITCH signal #3 : GND	㉒ TB_HOOD-HOOD #1 : HOOD signal #2 : GND		

5-1-22 Hydro unit/Hydro unit HT
- Control kit PBA (AM***FNBDEH*)

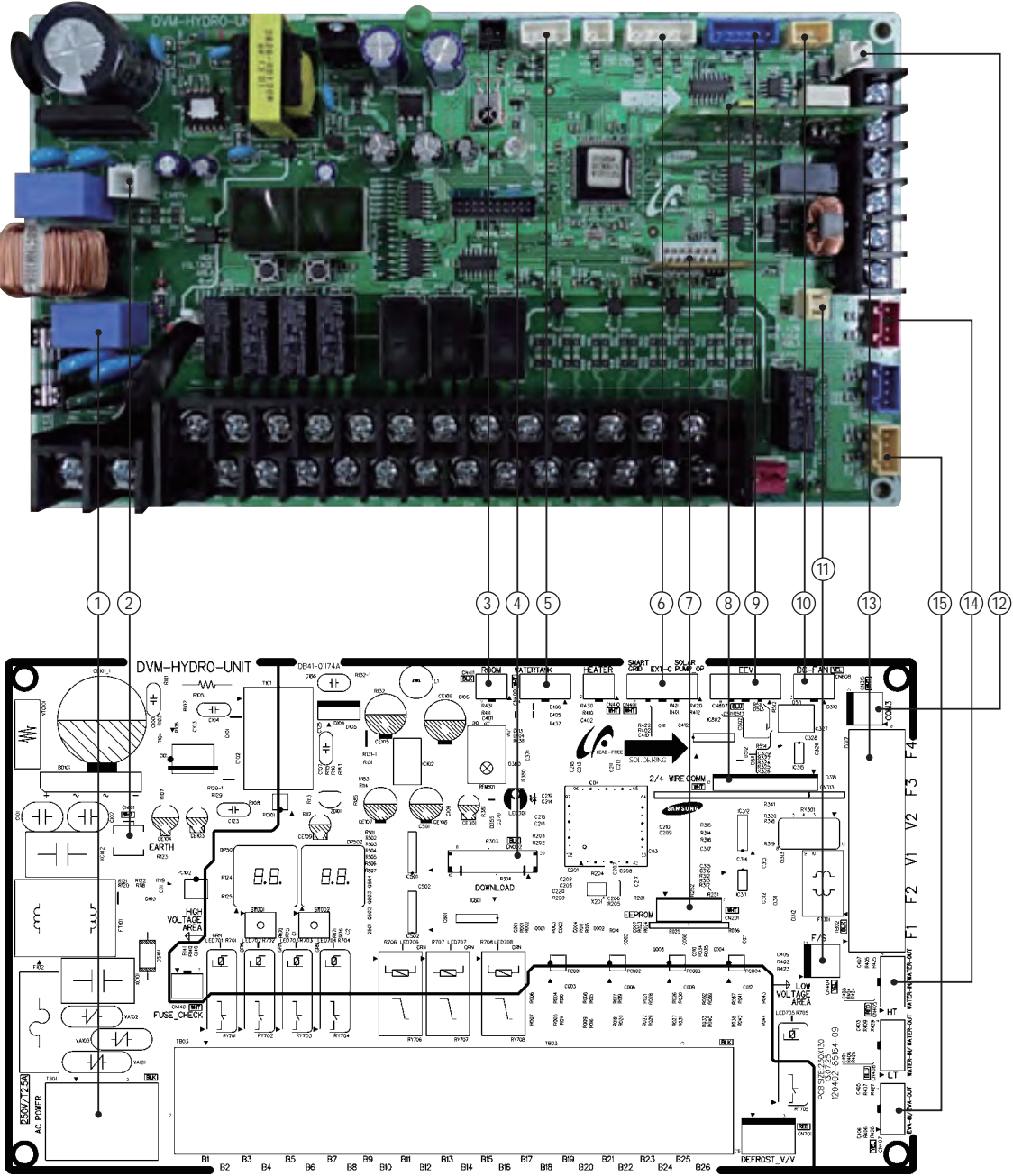

Hydro unit/Hydro unit HT(Cont.)**- Control kit PBA (AM***FNBDEH*) (cont.)**

① TB01 - AC POWER #1 : L #2 : N	② CN101 - EARTH #1 : EARTH	③ CN411 - ROOM #1 : ROOM TEMP #2 : GND	④ CN002 - DOWNLOAD #1 ~ #20 : DOWNLOAD
⑤ CN409 - WATERTANK #1 : N.C #2 : N.C #3 : WATERTANK TEMP #4 : GND	⑥ CN401 - SOLAR/EXT/GRID #1 : SOLAR PUMP OPTION #2 : GND #3 : EXT CTRL #4 : GND #5 : SMART GRID #6 : GND	⑦ CN201 - EEPROM #1 ~ #7 : EEPROM	⑧ CN313 - 2/4-WIRE COMM #1 ~ #12 : 2-WIRE COMM
⑨ CN809 - EEV #1 ~ #4 : EEV SIGNAL #5,#6 : DC 12V	⑩ CN808 - DC FAN #1 : DC12V #2 : DC FAN FEEDBACK #3 : GND	⑪ CN404 - FLOW SWITCH #1 : FLOW SWITCH #2 : GND	⑫ CN315 - COM3 #1 ~ #2 : COM3 COMM
⑬ TB02 - 6P T/B #1 : COM1 COMM #2 : COM1 COMM #3 : DC12V #4 : GND #5 : COM2 COMM #6 : COM2 COMM	⑭ CN405 - SENSOR #1 : WATER IN TEMP #2 : GND #3 : WATER OUT TEMP #4 : GND	⑮ CN407 - SENSOR #1 : EVA IN TEMP #2 : GND #3 : EVA OUT TEMP #4 : GND	

Hydro unit HT(Cont.)

- MAIN PCB (AM***FNBFE*, AM***FNBFG*) (cont.)

<p>① CN101 - POWER</p> <p>#1 : L #2 : N.C #3 : N</p>	<p>② CN702 - 4WAY</p> <p>#1 : N #2 : N.C #3 : 4WAY V/V SIGNAL</p>	<p>③ CN403 - SENSOR</p> <p>#1 : OUT TEMP #2 : GND #3 : COND TEMP #4 : GND #5 : DISCHARGE TEMP #6 : GND #7 : OLP TEMP #8 : GND</p>	<p>④ CN306 - DOWNLOAD</p> <p>#1 ~ #20 : DOWNLOAD</p>
<p>⑤ CN802 - EEV</p> <p>#1 ~ #4 : EEV SIGNAL #5,#6 : DC 12V</p>	<p>⑥ CN806 - EEPROM</p> <p>#1 ~ #7 : EEPROM</p>	<p>⑦ CN406 - SENSOR</p> <p>#1 : SUCTION TEMP #2 : GND #3 : N.C #4 : N.C</p>	<p>⑧ CN305 - COMM INV</p> <p>#1 : COMM SIGNAL #2 : COMM SIGNAL #3 : GND #4 : DC 5V #5 : DC 12V #6 : COMM SIGNAL</p>
<p>⑨ CN401 - LOW PRESSURE</p> <p>#1 : N.C #2 : SENSOR SIGNAL #3 : GND #4 : DC 5V</p>	<p>⑩ CN402 - HIGH PREWSSURE</p> <p>#1 : SENSOR SIGNAL #2 : N.C #3 : GND #4 : DC 5V</p>	<p>⑪ CN303 - COMM INDOOR</p> <p>#1 ~ # 2: COMM SIGNAL</p>	<p>⑫ CN103 - EARTH</p> <p>#1 : EARTH</p>

Hydro unit HT(Cont.)

- ASSY PCB SUB-EMI (1 PHASE) (AM***FNBFE*) (cont.)

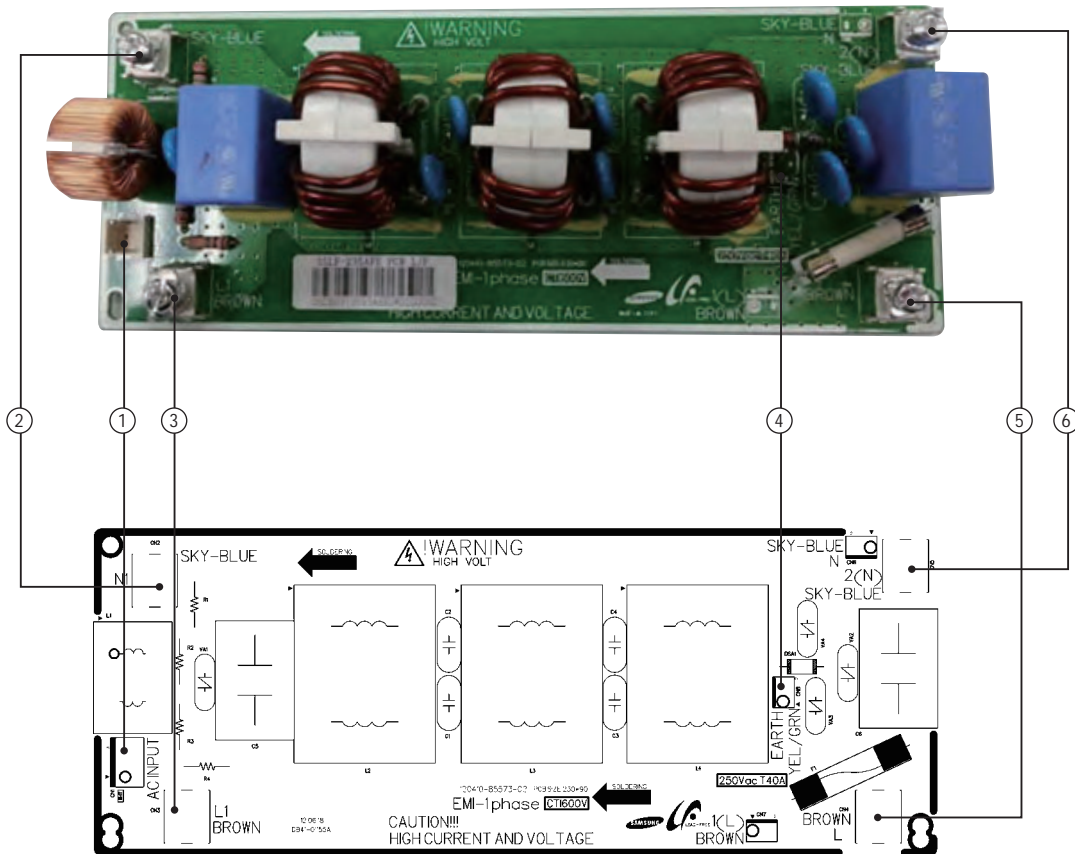

<p>① CN1 - AC POWER</p> <p>#1 : L #2 : N.C #3 : N</p>	<p>② CN2 - N1</p> <p>#1 : N</p>	<p>③ CN3 - L1</p> <p>#1 : L</p>	<p>④ CN8 - EARTH</p> <p>#1,#2 : EARTH</p>
<p>⑤ CN4 - L</p> <p>#1 : L</p>	<p>⑥ CN5 - N</p> <p>#1 : N</p>		

Hydro unit HT (Cont.)

- ASSY PCB MAIN-INVERTER (1 PHASE) (AM***FNBFE*) (cont.)

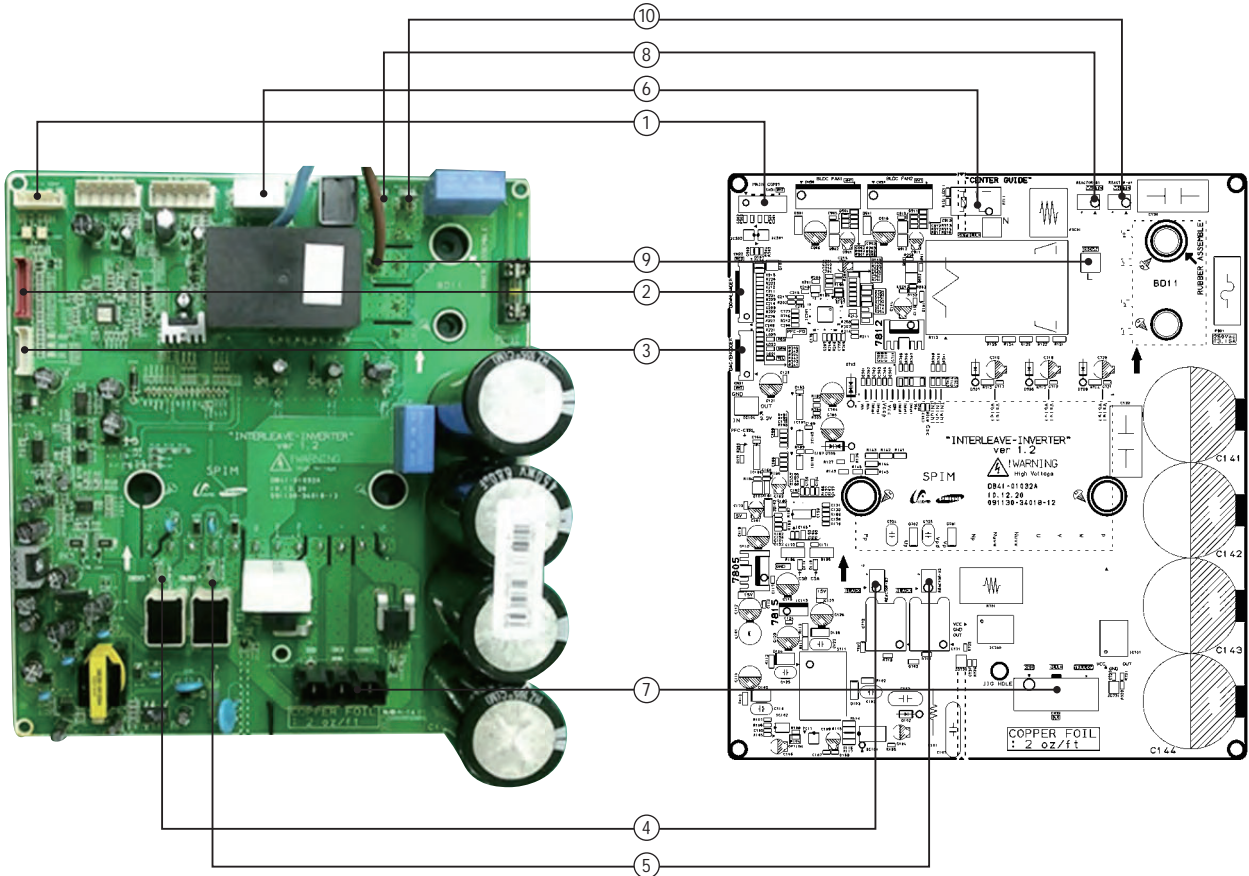

<p>① CN31 - MAIN COMM #1 : COMM SIGNAL #2 : COMM SIGNAL #3 : GND #4 : DC 5V #5 : DC 12V #6 : COMM SIGNAL</p>	<p>② CN22 - DOWNLOADER #1 ~ #10 : DOWNLOAD</p>	<p>③ CN21 - DAC/ENCODER #1 ~ #8 : DOWNLOAD</p>	<p>④ REACTOR-B2 #1,#2 : REACTOR BLACK</p>
<p>⑤ REACTOR-A2 #1,#2 : REACTOR BLACK</p>	<p>⑥ N - SKYBLUE WIRE #1 : N</p>	<p>⑦ CN32 - COMP #1 : RED #2 : BLUE #3 : YELLOW</p>	<p>⑧ REACTOR-B1 #1,#2 : REACTOR WHITE</p>
<p>⑨ L - BROWN WIRE #1 : L</p>	<p>⑩ REACTOR-A1 #1,#2 : REACTOR WHITE</p>		

Hydro unit HT (Cont.)

- ASSY PCB SUB-EMI (3 PHASE) (AM***FNBFGB*) (cont.)

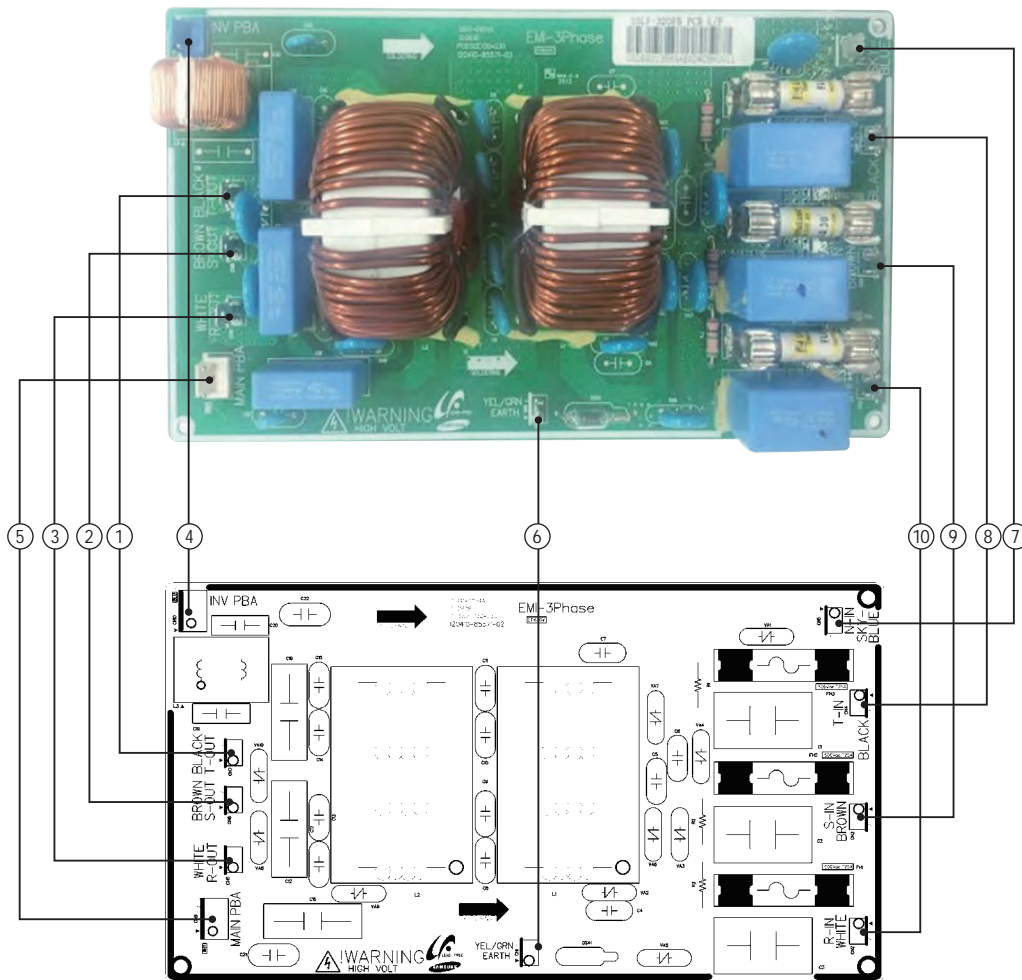

<p>① CN31 - MAIN COMM #1 : COMM SIGNAL #2 : COMM SIGNAL #3 : GND #4 : DC 5V #5 : DC 12V #6 : COMM SIGNAL</p>	<p>② CN22 - DOWNLOADER #1 ~ #10 : DOWNLOAD</p>	<p>③ CN21 - DAC/ENCODER #1 ~ #8 : DOWNLOAD</p>	<p>④ REACTOR-B2 #1,#2 : REACTOR BLACK</p>
<p>⑤ REACTOR-A2 #1,#2 : REACTOR BLACK</p>	<p>⑥ N - SKYBLUE WIRE #1 : N</p>	<p>⑦ CN32 - COMP #1 : RED #2 : BLUE #3 : YELLOW</p>	<p>⑧ REACTOR-B1 #1,#2 : REACTOR WHITE</p>
<p>⑨ L - BROWN WIRE #1 : L</p>	<p>⑩ REACTOR-A1 #1,#2 : REACTOR WHITE</p>		

Hydro unit HT (Cont.)

- ASSY PCB MAIN-INVERTER (3 PHASE) (AM***FNBFGB*) (cont.)

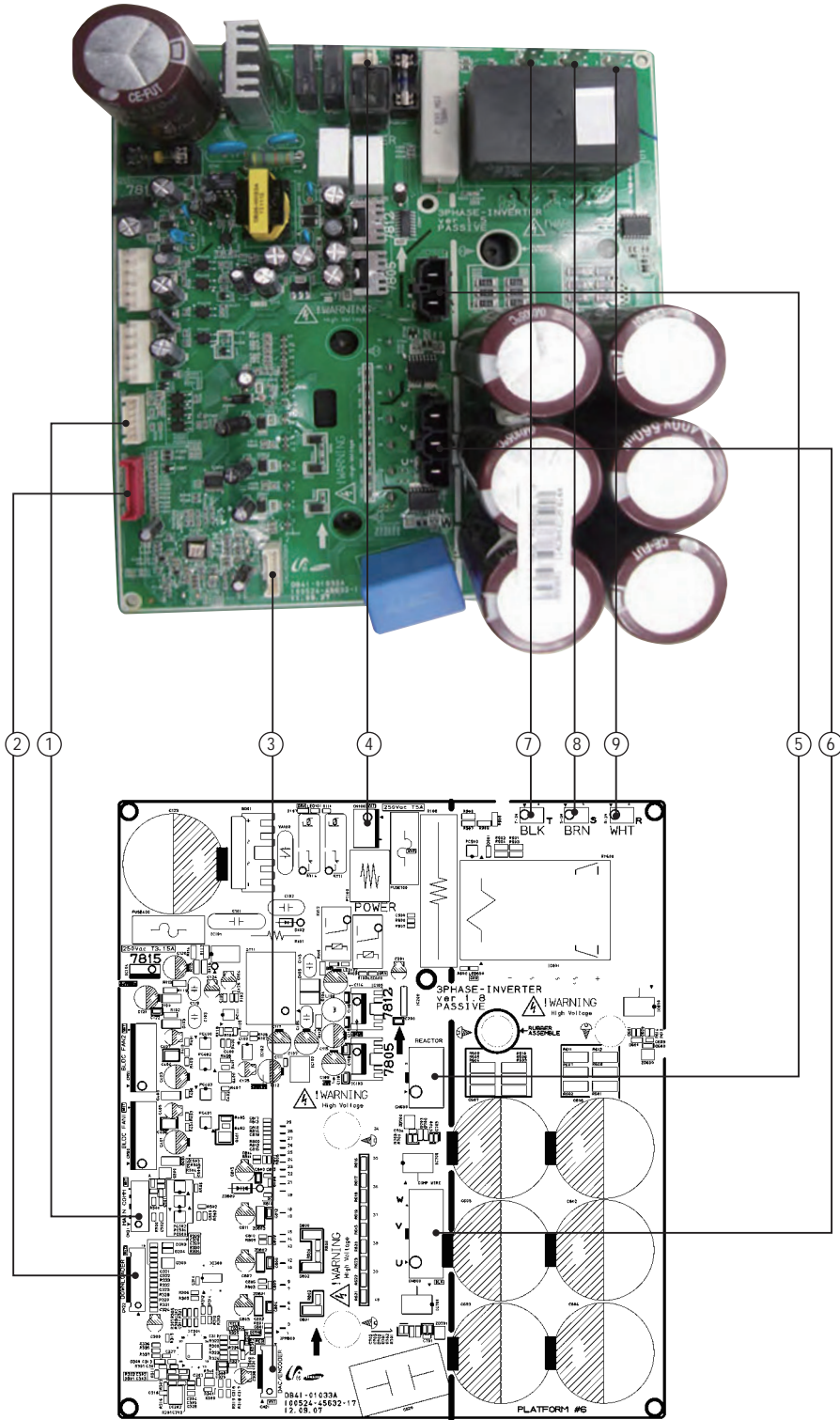

Hydro unit HT (Cont.)**- ASSY PCB MAIN-INVERTER (3 PHASE) (AM***FNBFGB*) (cont.)**

① CN31 - MAIN COMM #1 : COMM SIGNAL #2 : COMM SIGNAL #3 : GND #4 : DC 5V #5 : DC 12V #6 : COMM SIGNAL	② CN22 - DOWNLOADER #1 ~ #10 : DOWNLOAD	③ CN21 - DAC/ENCODER #1 ~ #8 : DOWNLOAD	④ CN100 - AC POWER #1 : T #2 : N.C #3 : N
⑤ CN600 - REACTOR #1,#2 : REACTOR BLACK	⑥ CN800 - COMP #1 : U #2 : V #3 : W	⑦ T-IN #1,#2 : T	⑧ S-IN #1,#2 : S
⑨ R-IN #1,#2 : R			

5-1-24 Wall Mounted type(A3050)

- Main PBA (AM***JNVDKH*, AM***JNADKH*)
- Main PBA (AE022/028/036/056/071MNADEH/EU)

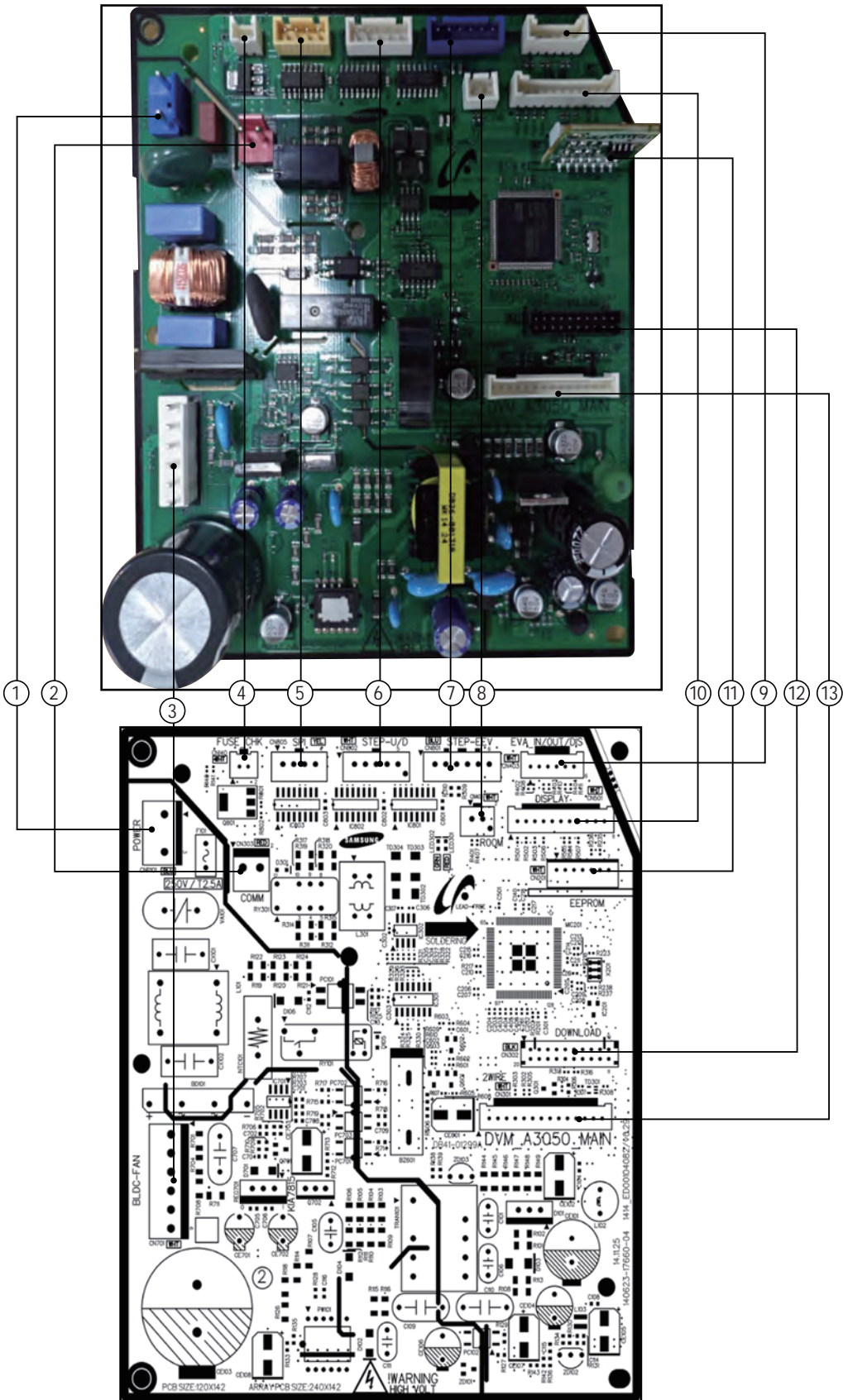

Wall Mounted type(A3050)(Cont.)

– Main PBA (AM***JNVDKH*, AM***JNADKH*) (cont.)

– Main PBA (AE022/028/036/056/071MNADEH/EU) (cont.)

① CNP101-POWER #1 : L #2 : NOT USED #3 : N	② CN303-COM1 #1~2 : COMMUNICATION SIGNAL	③ CN701-BLDC FAN #1 : DC 310V #2 : NOT USED #3 : GND #4 : PWM SIGNAL #5 : FEEDBACK SIGNAL	④ CN140-FUSE CHECK #1 : THERMAL FUSE SIGNAL #2 : GND
⑤ CN805-SPI #1~2 : GND #3 : SPI CONTROL SIGNAL #4 : NOT USED	⑥ CN802-STEP UP/DOWN #1 : DC 12V #2~5 : LOUVER SIGNAL	⑦ CN801-EEV #1~4 : EEV SIGNAL #5~6 : DC 12V	⑧ CN401-ROOM #1 : OOM TEMPERATURE SENSOR SIGNAL #2 : GND
⑨ CN403-EVA IN/OUT/DIS #1 : EVA IN TEMPERATURE SENSOR SIGNAL #2 : GND #3 : EVA OUT TEMPERATURE SENSOR SIGNAL #4 : GND #5 : DISCHARGE TEMPERATURE SENSOR SIGNAL #6 : GND	⑩ CN501-DISPLAY #1~3 : LED SIGNAL #4 : REMOCON SIGNAL #5 : GND #6 : DC 5V #7~8 : REMOCON SIGNAL #9~11 : NOT USED	⑪ CN201-EEPROM #1 : GND #2 : NOT USED #3 : DC 5V #4~7 : EEPROM SIGNAL	⑫ CN302-DOWNLOAD #1~8 : DOWNLOAD SIGNAL #9 : GND #10~11 : DC 5V #12~16 : DOWNLOAD SIGNAL #17 : GND #18~20 : DOWNLOAD SIGNAL
⑬ CN301-to 2WIRE SUB #1~2 : COMMUNICATION SIGNAL #3~4 : SUB PBA SIGNAL #5 : EXTERNAL CONTROL SIGNAL #6 : COMP CHECK SIGNAL #7 : ERROR CHECK SIGNAL #8 : DC 5V #9 : GND #10 : DC 12V #11~14 : COMMUNICATION SIGNAL			

Wall Mounted type(A3050)(Cont.)

- Sub PCB (AM***JNVDKH*, AM***JNADKH*) (cont.)

- Sub PCB (AE022/028/036/056/071MNADEH/EU) (cont.)

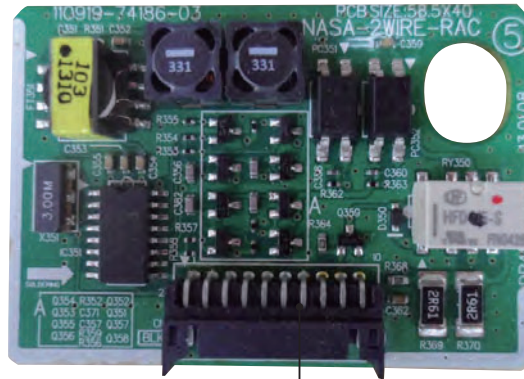

①

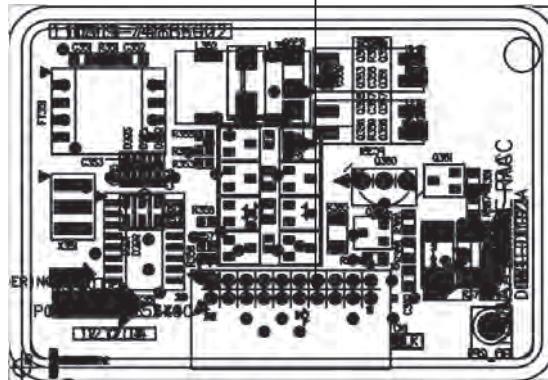

① CN1-2WIRES COMM.

- #1,#2,#19,#20:COMM. SIGNAL
- #3,#18:EXTERNAL CONTROL
- #4,#17:COMP CHECK
- #5,#16:ERROR CHECK
- #6:VCC(DC5V)
- #7,#14:GND
- #8,#13,#15:DC12V
- #9~#12:COMM. SIGNAL

5-1-25 OAP DUCT

- MAIN PCB (AM140JNEPEH*)

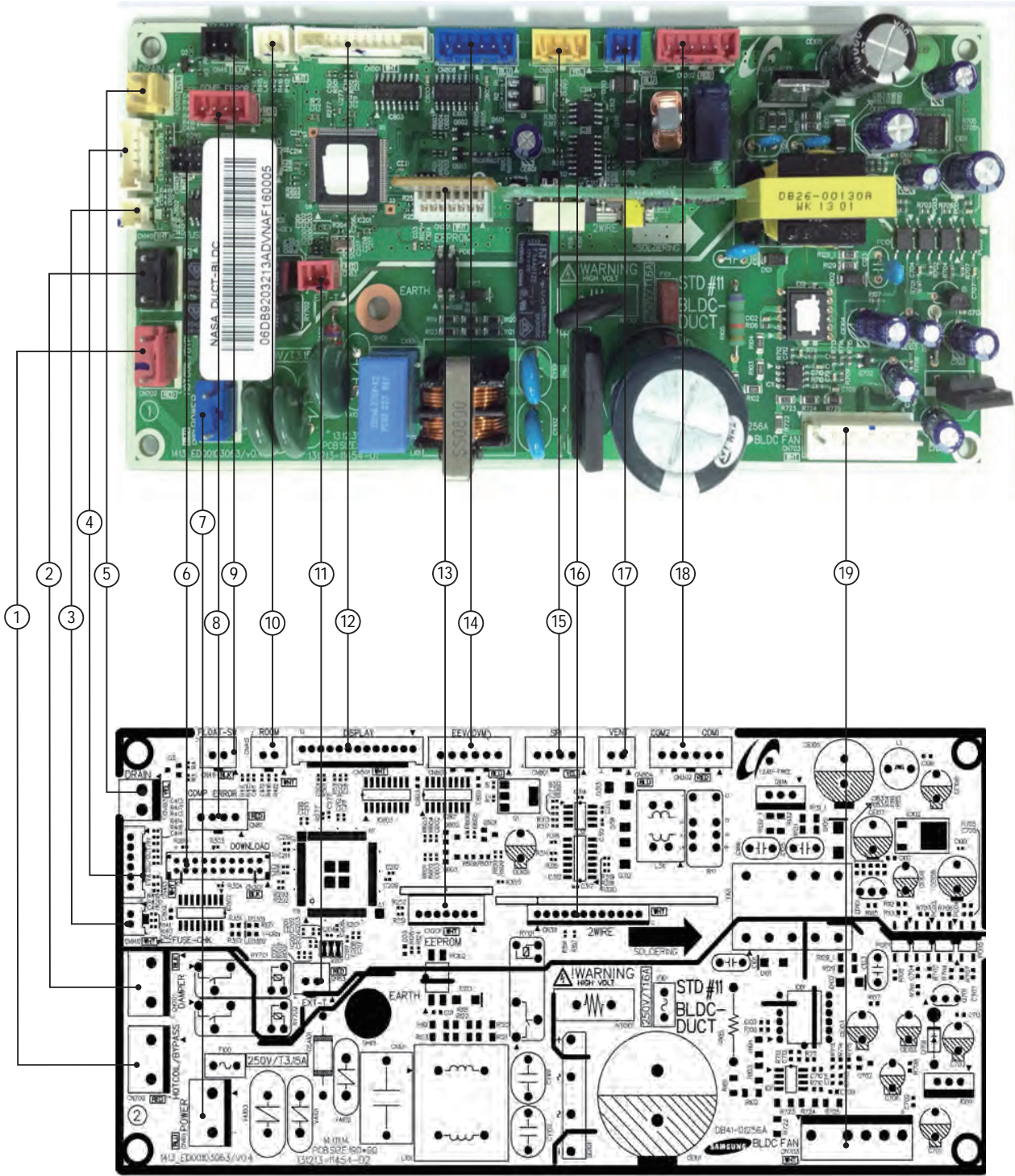

OAP DUCT (Cont.)

- MAIN PCB (AM140JNEPEH*) (cont.)

<p>① CN702-HOT COIL #1: L #2: N</p>	<p>② CN701-DAMPER #1: L #2: N</p>	<p>③ CN140-FUSE CHECK #1:FUSE CHECK #2:GND</p>	<p>④ CN413-Temperature Sensor #1 : EVA IN TEMP #2,4,6: GND #3 : EVA OUT TEMP #5 : DISCHARGE TEMP</p>
<p>⑤ CN103-DRAIN PUMP #1: 12V #2 : GND</p>	<p>⑥ CN301-MICOM DOWNLOAD</p>	<p>⑦ CN101-AC INPUT #1: L #2: N</p>	<p>⑧ CN81-EXTERNAL CONTROL OUT #1,3: 12V #2: ERROR CHECK OUT #4: COM CHK OUT#4 : GND</p>
<p>⑨ CN411-FLOAT S/W #1: FLOAT SW Input #2: GND</p>	<p>⑩ CN412-ROOM Temperature Sensor #1: Temperature Input #2: GND</p>	<p>⑪ CN83-EXTERNAL CONTROL #1: GND #2: EXTERNAL INPUT</p>	<p>⑫ CN501-DISPLAY #1:12V #2~6:LED Control #7: BZ1 #8: Remote control signal output #9: AUTO SW #10: REMOCON INT #11:GND #12:VCC #13:BZ2</p>
<p>⑬ CN201-E2P Modules</p>	<p>⑭ CN808-Electric sides #1~4: EEV #5,6: 12V</p>	<p>⑮ CN801-SPI #1,2:GND #3:SPI Control</p>	<p>⑯ CN311-2 Communication</p>
<p>⑰ CN702-HALL IC #1: 12V #2: VENT OUT</p>	<p>⑱ CN806-SLIDE 2/3 #1,2 : Indoor and outdoor group communication #3 : 12V #4 : GND #5 : Wired</p>	<p>⑲ CN2-SLIDE 1 #1: 310V #2: N.C #3: AGND #4: 15V #5: MOTOR SIGNAL PWM #6: MOTOR FEEDBACK</p>	

5-1-26 OAP DUCT

- MAIN PCB (AM220/280JNEPEH*)

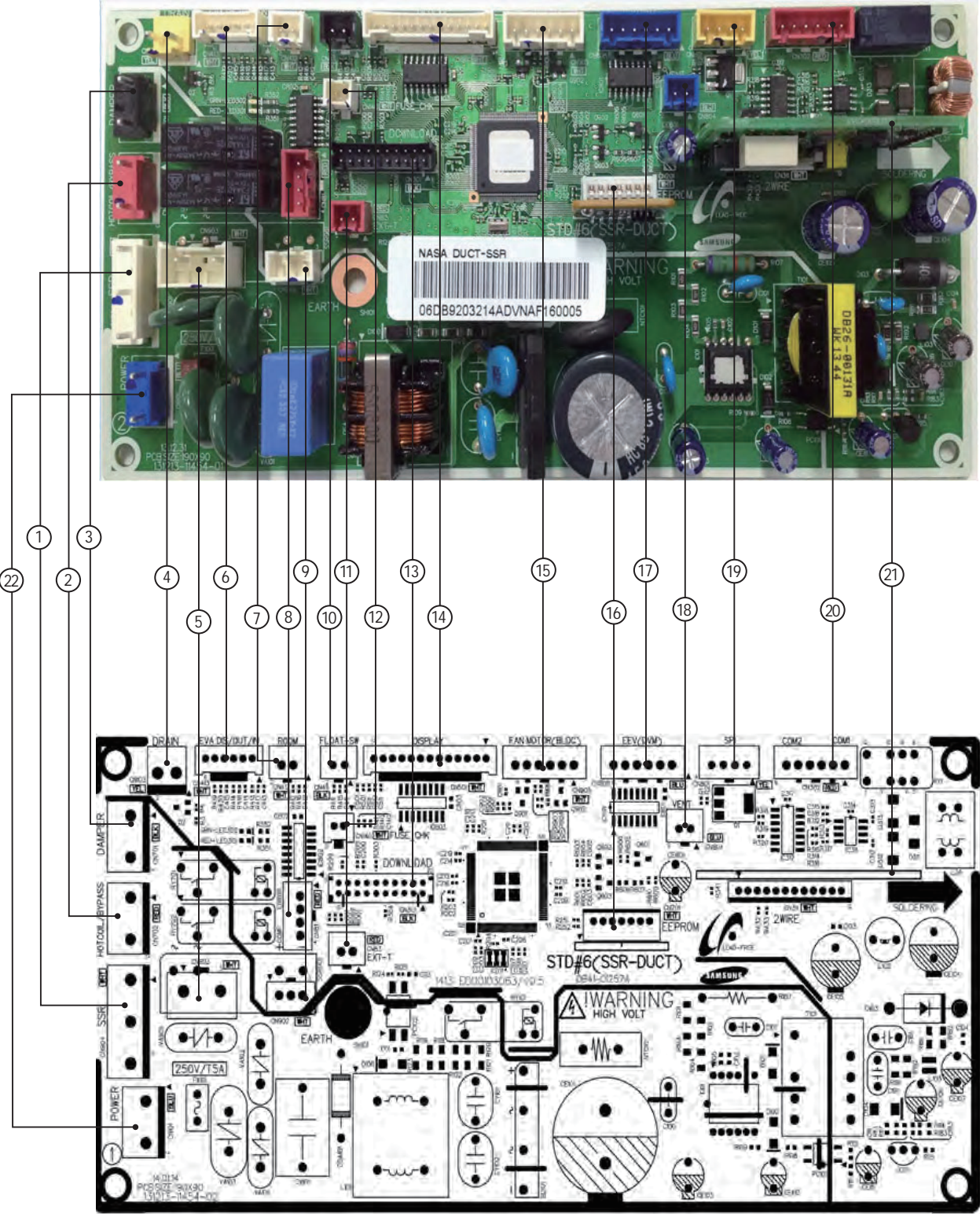

OAP DUCT(AM220/280*NEPEH/EU) (Cont.)

- MAIN PCB(cont.)

<p>① CN100-AC INPUT #1:N #2:L #3:N</p>	<p>② CN702-HOT COIL #1:L #2:N</p>	<p>③ CN701-DAMPER #1:L #2:N</p>	<p>④ CN103-DRAIN PUMP #1: 12V #2: GND</p>
<p>⑤ CN903-SSR AC Control #1:L Input #2:L Output</p>	<p>⑥ CN413-Temperature Sensor #1 : EVA IN TEMP #2,4,6: GND #3 : EVA OUT TEMP #5 : DISCHARGE TEMP</p>	<p>⑦ CN412-ROOM Temperature Sensor #1: Temperature Input #2: GND</p>	<p>⑧ CN81-EXTERNAL CONTROL OUT #1,3: 12V #2: ERROR CHECK OUT #4: COM CHK OUT</p>
<p>⑨ CN902- SSR DC Output #1: 12V #2: MOTOR SSR OUT</p>	<p>⑩ CN411-FLOAT S/W #1:FLOAT SW Input #2: GND</p>	<p>⑪ CN83-EXTERNAL CONTROL #1: GND #2: EXTERNAL INPUT</p>	<p>⑫ CN140-FUSE CHECK #1:FUSE CHECK #2:GND</p>
<p>⑬ CN301-MICOM DOWNLOAD</p>	<p>⑭ CN501-DISPLAY #1:12V #2~6:LED Control #7: BZ1 #8: Remote control signal output #9: AUTO SW #10: REMOCON INT #11:GND #12:VCC #13:BZ2</p>	<p>⑮ CN905-BLDC MOTOR #1:12V #2: GND #3: VCC #4: MOTOR SIGNAL PWM #5: MOTOR FEEDBACK #6:INRUSH OUT</p>	<p>⑯ CN201-E2P Modules</p>
<p>⑰ CN808- Electric sides #1~4: EEV #5,6: 12V</p>	<p>⑱ CN804-VENTILATOR #1: 12V #2: VENT OUT</p>	<p>⑲ CN801-SPI #1,2:GND #3:SPI Control</p>	<p>⑳ CN302- Indoor/outdoor communication / wired remote communications #1,2: Indoor and outdoor group communication #3:12V #4:GND #5: Wired remote communication</p>
<p>㉑ CN311-2 Communication</p>	<p>㉒ CN101-AC INPUT #1: L #2: N</p>		

OAP DUCT(AM220/280*NEPEH/EU) (Cont.)
 – MAIN PCB(cont.)

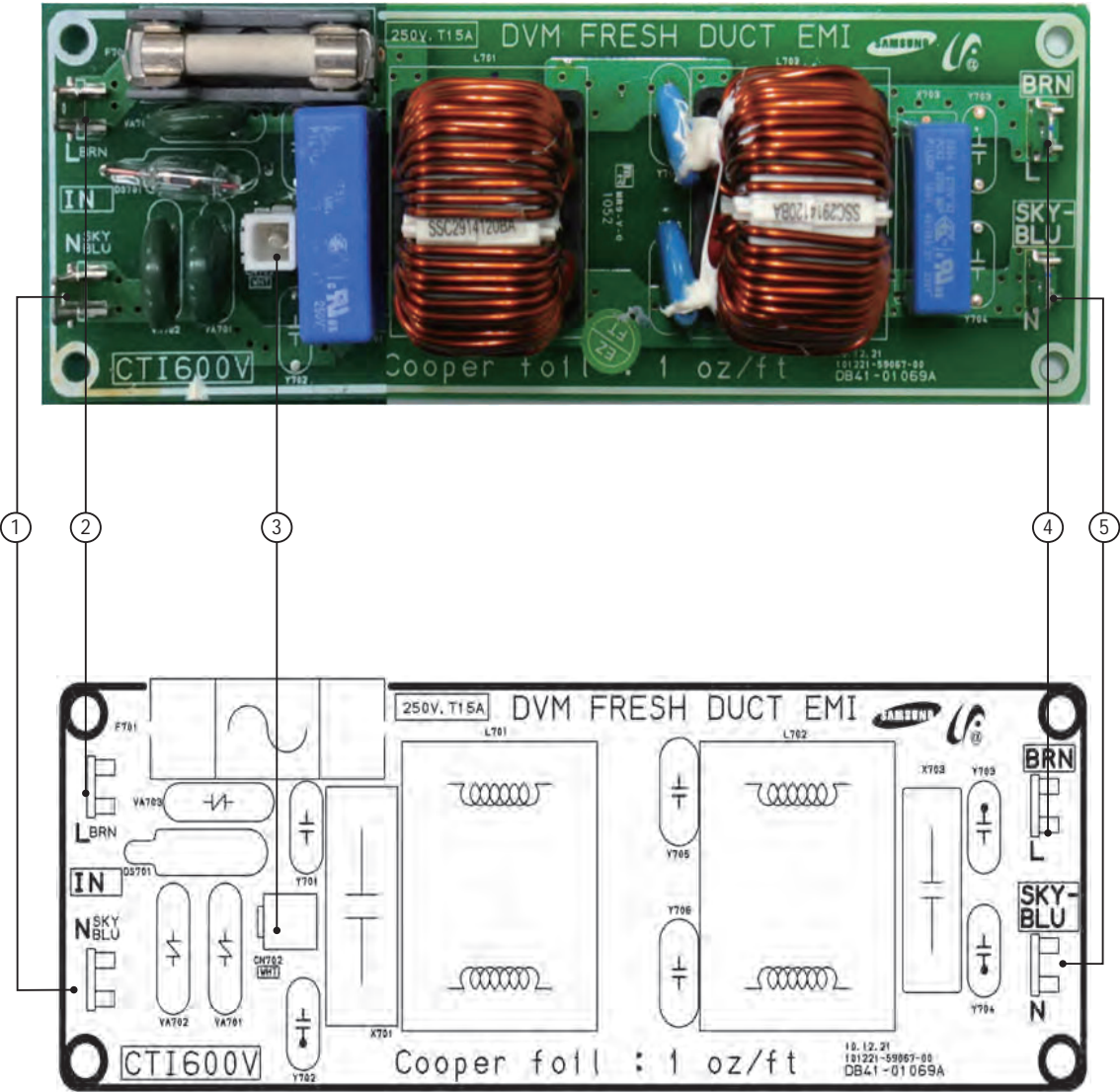

① N-N TOP	② L-L TOP	③ CN702-Earth	④ L-L TOP
⑤ N-N TOP			

OAP DUCT(AM220/280*NEPEH/EU) (Cont.)

– BLDC Driver PCB (cont.)

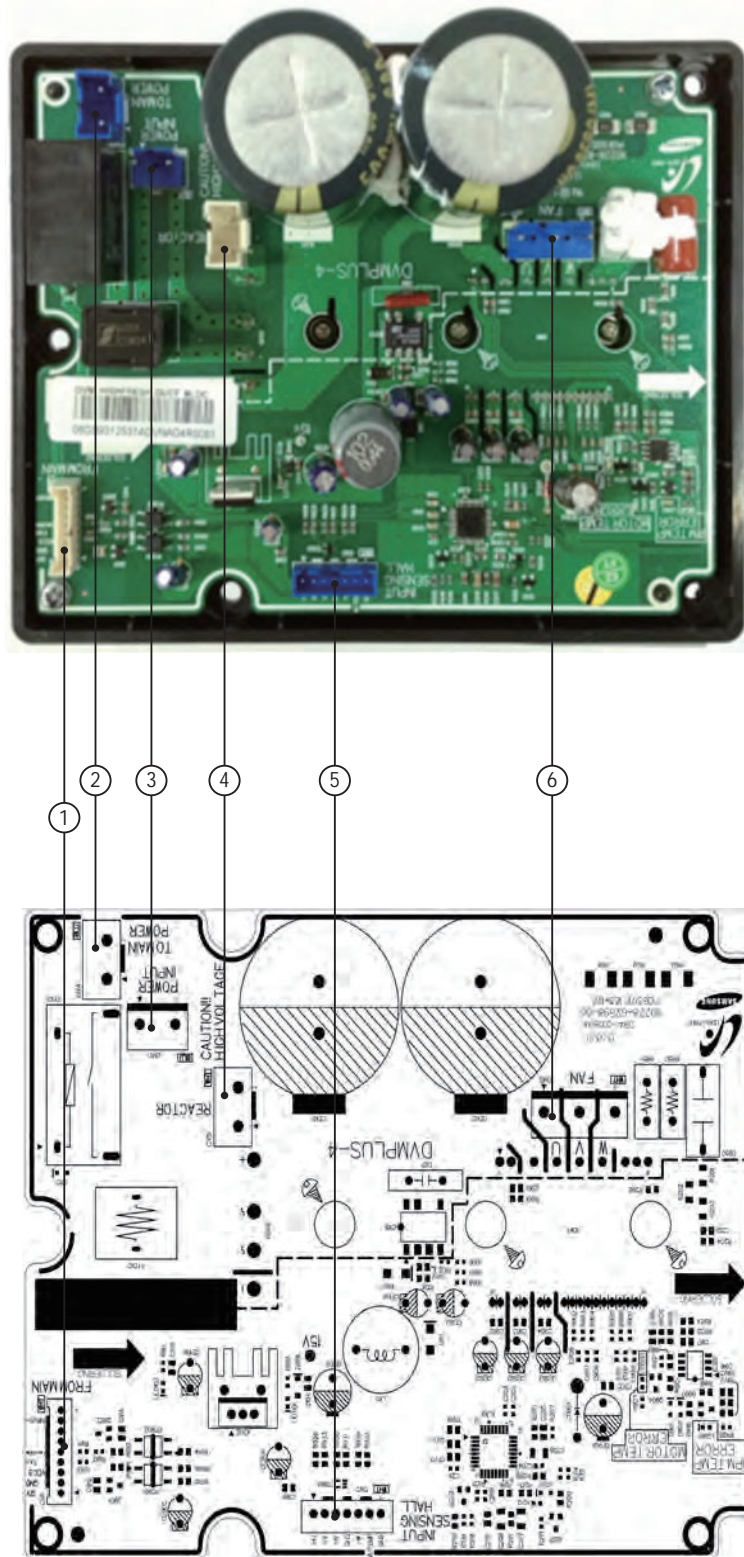

OAP DUCT(AM220/280*NEPEH/EU) (Cont.)**– BLDC Driver PCB (cont.)**

① CN11- Main-BLDC COMM #1:12V #2:GND #3:VCC #4: FAN RPM #5: Fan Feedback #8: INRUSH	② CN14-MAIN POWER #1: L #2: N	③ CN10-POWER INPUT #1:N #2: N	④ CN15-REACTOR
⑤ CN12-BLDC-MOTOR COMM #1: HU #2 : 5V #3: HW #4: GND #5: HV #6: MOTOR TEMP #7: GND	⑥ CN13-MOTOR #1: U #2 : V #3: W		

OAP Duct(AM140MNEPEH/EU) (Cont.)

① CN100-AC POWER #1 : L #3 : N	② CN702-HOT COIL or BYPASS #1 : N #3 : HOT COIL or BYPASS CONTROL SIGANL	③ CN703-DAMPER #1 : N #3 : DAMPER CONTROL SIGANL	④ CN140-THERMAL FUSE #1 : THERMAL FUSE SIGNAL #2 : GND
⑤ CN413-EVA IN/OUT/DIS TEMP. SENSOR #1 : EVI IN TEMP. SENSOR #3 : EVI OUT TEMP. SENSOR #5 : DISCHARGE TEMP. SENSOR #2,4,6 : GND	⑥ CN103-DRAIN PUMP #1 : DRAIN PUMP CONTROL SIGNAL #2 : GND	⑦ CN301-DOWNLOAD #1~8 : DOWNLOAD SIGNAL #9 : GND #10~11 : DC 5V #12~16 : DOWNLOAD SIGNAL #17 : GND #18~20 : DOWNLOAD SIGNAL	⑧ CN411-FLOAT SWITCH #1 : FLOAT SWITCH SIGNAL #2 : GND
⑨ CN81-ERROR/COMP CHECK #1 : DC 12V #2 : ERROR CHECK SIGNAL #3 : DC 12V #4 : COMP CHECK SIGNAL	⑩ CN412-ROOM TEMP. SENSOR #1 : ROOM TEMP. SENSOR #2 : GND	⑪ CN83-EXTERNAL CONTROL #1 : GND #2 : EXTERNAL CONTROL SIGNAL	⑫ SH101-EARTH #1 : EARTH
⑬ CN501-DISPLAY #1 : DC 12V #3~10,13 : PANEL SIGNAL #11 : GND #12 : DC 5V	⑭ CN201-EEPROM #1 : GND #2 : NOT USED #3 : DC 5V #4~7 : EEPROM SIGNAL	⑮ CN808-EEV(DVM) #1~4 : EEV CONTROL SIGNAL #5~6 : DC 12V	⑯ CN801-SPI #1~2 : GND #3 : SPI CONTROL SIGNAL #4 : NOT USED
⑰ CN311-2WIRE SUB #1 : DC 12V #2~5 : COMMUNICATION SIGNAL #6 : DC 5V #7~12 : COMMUNICATION SIGNAL	⑱ CN804-VENTILATOR #1 : DC 12V #2 : VENTILATOR CONTROL SIGNAL	⑲ CN302-COMMUNICATION #1~2 : COM1 COMMUNICATION SIGNAL #3 : DC 12V #4 : GND #4~6 : COM2 COMMUNICATION SIGNAL	⑳ CN703-BLDC MOTOR #1 : DC 310V #3~6 : FAN MOTOR CONTROL SIGNAL

5-1-27 V-AHU

- MAIN PCB (AM***JNZDCH*)

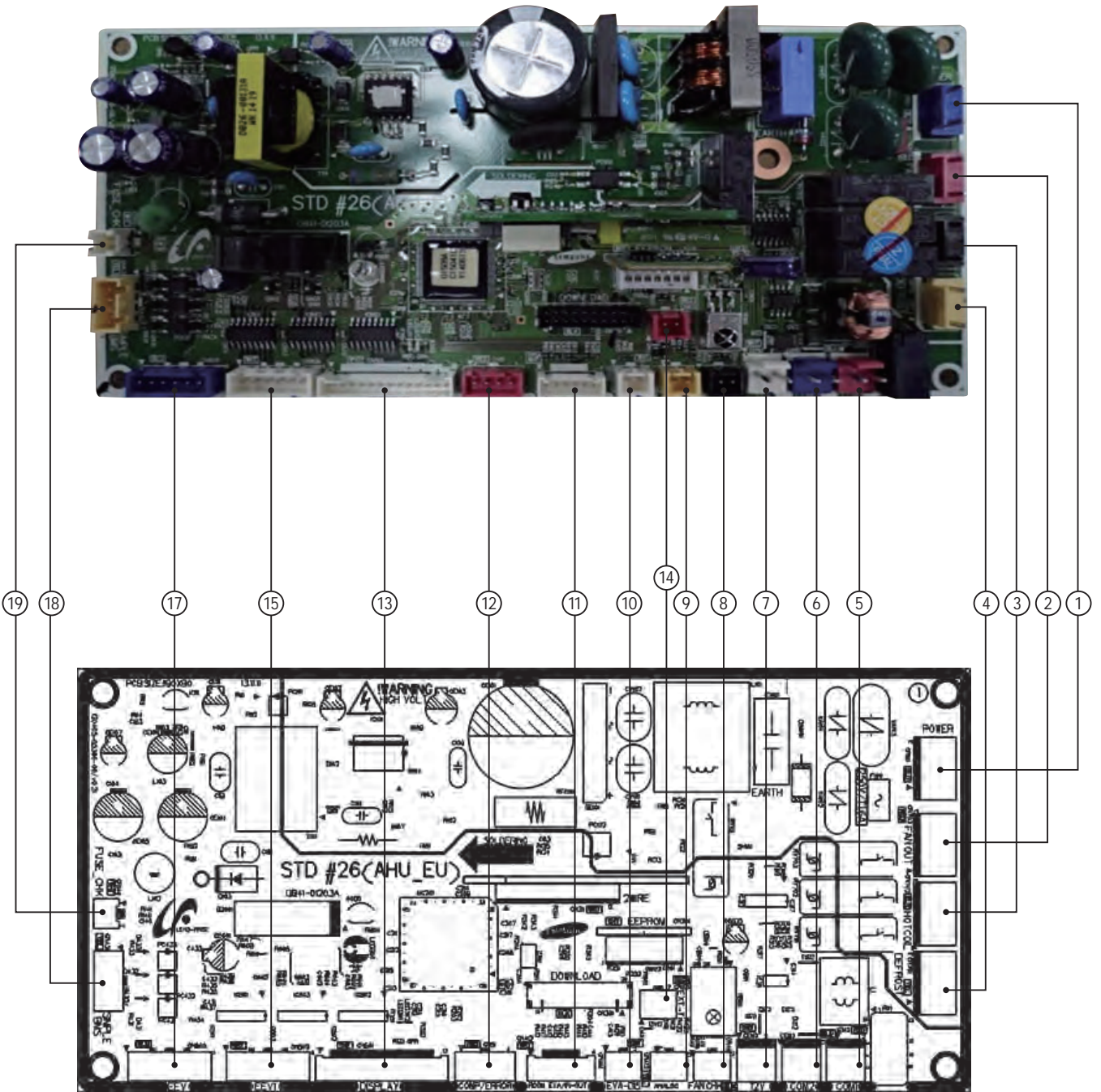

V-AHU (Cont.)

- MAIN PCB (AM***JNZDCH*) (cont.)

① CN101-POWER #1: LIVE #2: #3: NEUTRAL	② CN703-FAN OUT #1: NEUTRAL #2: #3: FANOUT_OUT	③ CN702-HOT COIL #1: NEUTRAL #2: #3: HOT_COIL_OUT	④ CN701-DEFROS #1: NEUTRAL #2: #3: DEFROST_OUT
⑤ CN31-COM1 #1: COM1_A #2: COM1_B	⑥ CN33-COM2 #1: COM2_C #2: COM2_D	⑦ CN32-12V #1: 12V #2: GND	⑧ CN411-FAN CHK #1: FAN_CHECK #2: GND
⑨ CN415-ANALOG #1: ANALOG_SET_TEMP #2: GND	⑩ CN414-EVA-DIS #1: EVA_DIS_TEMP #2: GND	⑪ CN412-ROOM EVA/IN-OUT #1: ROOM_TEMP #2: GND #3: EVA_IN_MID_TEMP #4: GND #5: EVA_OUT_TEMP #6: GND	⑫ CN81-COMP/ERROR #1: 12V #2: ERROR_CHK_OUT #3: 12V #4: COMP_CHK_OUT
⑬ CN501-DISPLAY #1: 12V #2: LED_0_OUT #3: LED_1_OUT #4: LED_2_OUT #5: LED_3_OUT #6: LED_4_OUT #7: - #8: - #9: - #10: - #11: GND #12: VCC #13: -	⑭ CN83-EXT-T #1: GND #2: EXT_CTRL	⑮ CN809-EEV1 #1: EEV1_B_bar_OUT #2: EEV1_A_bar_OUT #3: EEV1_B_OUT #4: EEV1_A_OUT #5: 12V #6: 12V	⑯ CN301-DOWNLOAD #1: COM1_RXD #2: COM1_TXD #3: nTRST #4: TDO #5: TCK #6: TDI #7: TMS #8: TRACE_CLK #9: GND #10: VCC #11: VCC #12: MODE0 #13: RESET #14: TRACE_3 #15: LVR3_B_bar #16: LVR3_A_bar #17: GND #18: TRACE_2 #19: TRACE_1 #20: TRACE_0
⑰ CN808-EEV #1: EEV_B_bar_OUT #2: EEV_A_bar_OUT #3: EEV_B_OUT #4: EEV_A_OUT	⑱ CN431-SIMPLE BMS #1: GND #2: BMS_AUTO #3: BMS_HEATING #4: BMS_COOLING	⑲ CN140-FUSE_CHK #1: FUSE_CHECK #2: GND	

5-1-28 STAND

■ Main PCB (AM280JNPDKH/TK)

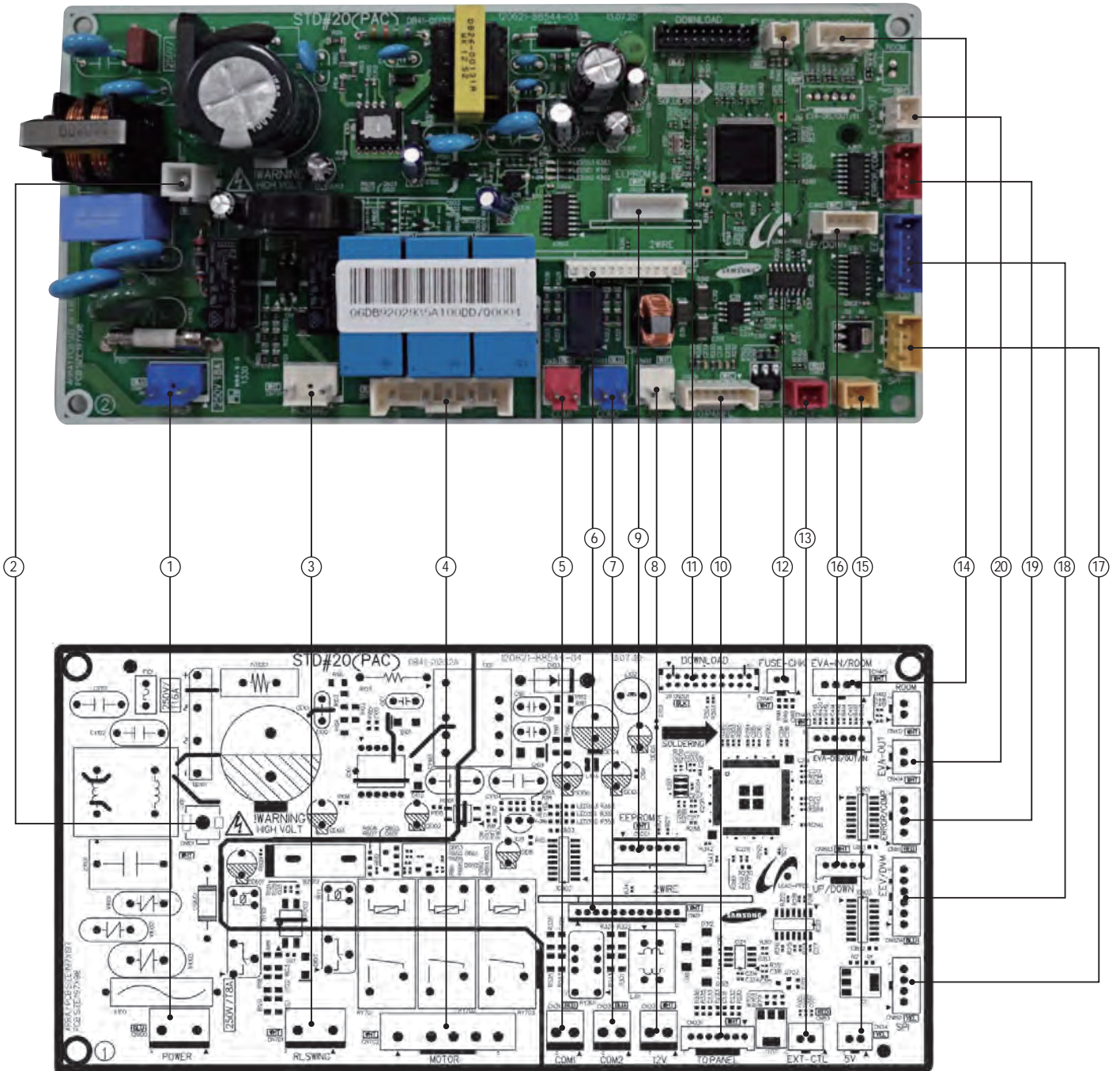

STAND (Cont.)**■ Main PCB (AM280JNPDKH/TK)**

① CN100-AC POWER #1 : L #3 : N	② CN101-GND #1 : GND	③ CN701-LEFT/RIGHT SWIHG #1 : N #3 : MOTOR OUTPUT SIGNAL	④ CN702-MOTOR #1 : N #2 : UNUSED #3-5 : FAN OUTPUT SIGNAL
⑤ CN31-COM1 COMM #1 : OUTDOOR UNIT COMM F1 #2 : OUTDOOR UNIT COMM F2	⑥ CN311-2 WIRED BOARD COMM #1 : 12V #2~5 : 2 WIRED BOARD COMM #6 : Vcc #7~12 : 2 WIRED BOARD COMM	⑦ CN33-COM2 COMM #1 : SOLUTION COMM F3 #2 : SOLUTION COMM F4	⑧ CN32-12V #1 : 12V #2 : GND
⑨ CN201-EEPROM #1 : GND #2 : UNUSED #3 : Vcc #4-7 : EEPROM SIGNAL	⑩ CN231-PANEL #1 : 12V #2 : GND #3~7 : PANEL SIGNAL	⑪ CN21-DOWNLOAD #1-8 : DOWNLOAD SIGNAL #9 : GND #10~11 : Vcc #12-16 : DOWNLOAD SIGNAL #17 : GND #18-20 : DOWNLOAD SIGNAL	⑫ CN140-FUSE CHECK #1-2 : FUSE SIGNAL
⑬ CN83-EXT CTRL #1 : GND #2 : EXT CTRL	⑭ CN415-ROOM,EVA IN SENSOR #1 : ROOM TEMP SENSOR #2 : GND #3 : EVI IN TEMP SENSOR #4 : GND	⑮ CN34-5V #1 : 5V #2 : GND	⑯ CN803-UP/DOWN SWING #1 : 12V #2-5 : MOTOR SIGNAL
⑰ CN801-SPI #1~2 : GND #3 : SPI SIGNAL #4 : UNUSED	⑱ CN804-EEV #1-4 : EEV SIGNAL #5~6 : 12V	⑲ CN81-EXT LOAD SIGNAL #1 : 12V #2 : ERROR CHECK SIGNAL #3 : 12V #4 : COMP CHECK SIGANL	⑳ CN414-EVA OUT SENSOR #1 : EVI OUT TEMP SENSOR #2 : GND

STAND (Cont.)

■ Panel PCB (AM280JNPDKH/TK)

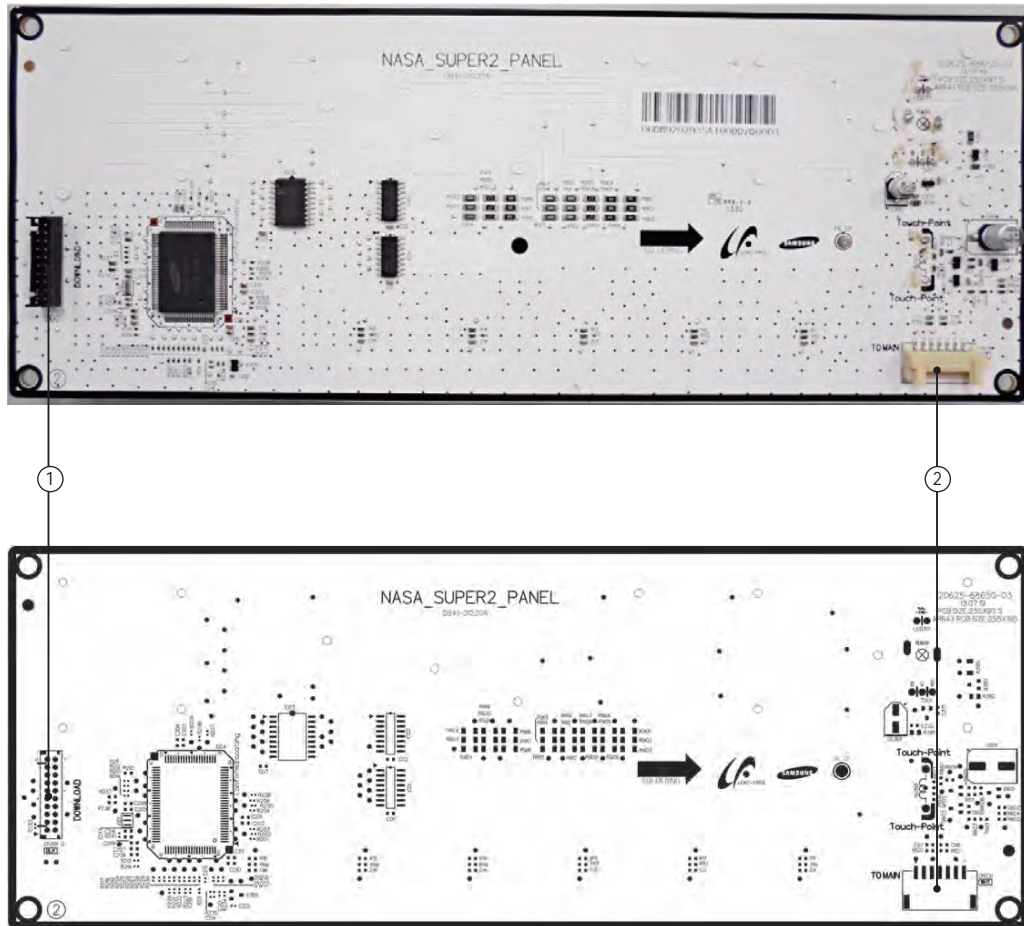

① CN233-DOWNLOAD	② CN231-PANEL
#1-8 : DOWNLOAD SIGNAL #9 : GND #10~11 : Vcc #12-16 : DOWNLOAD SIGNAL #17 : GND #18-20 : DOWNLOAD SIGNAL	#1 : 12V #2 : GND #3~7 : PANEL SIGNAL

STAND (Cont.)

■ Main PCB (AM140JNPDKH/TK)

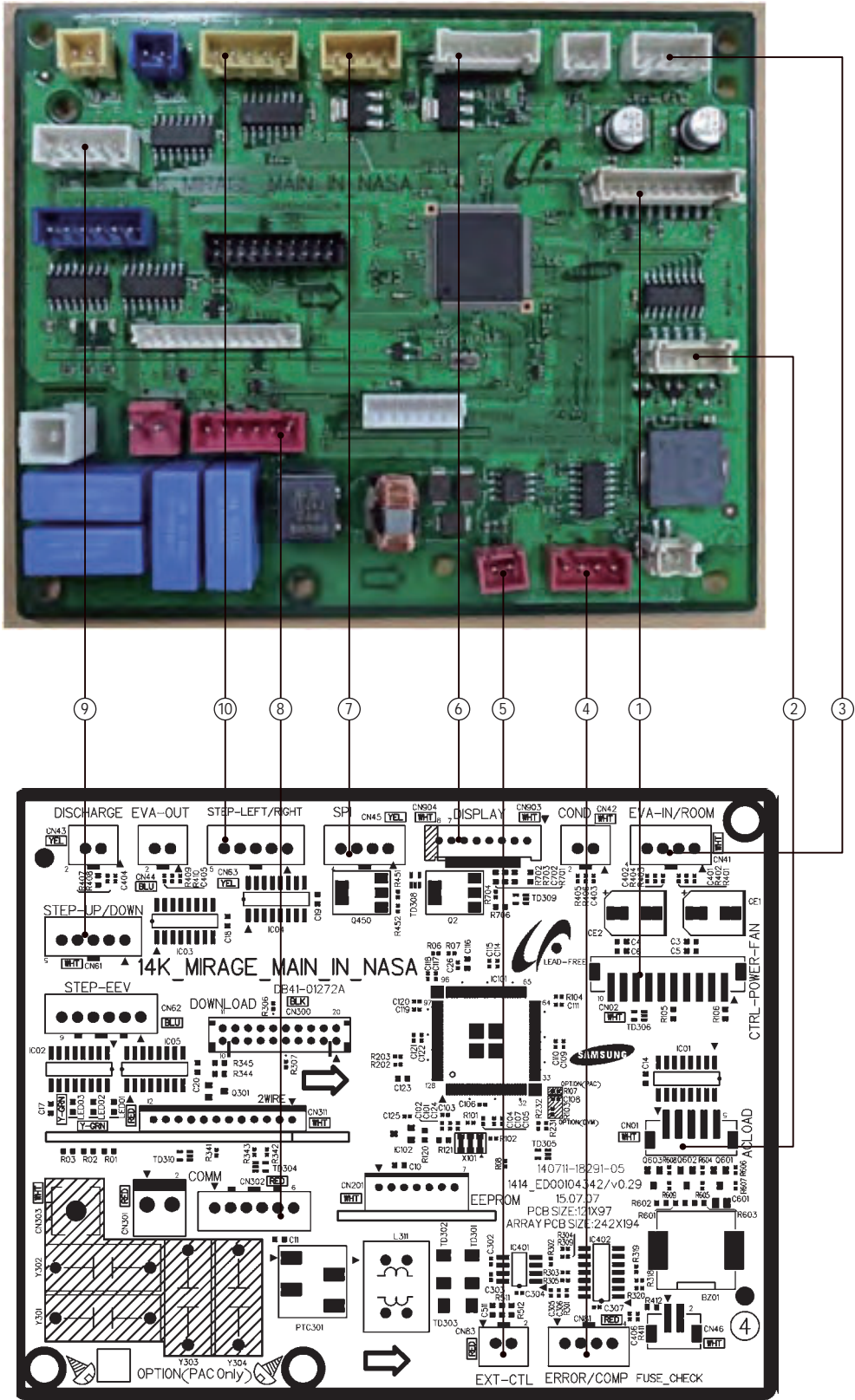

STAND (Cont.)**■ Main PCB (Cont.) (AM140JNPDKH/TK)**

① CN02-CTRL-POWER-FAN #1 : DETECT_OV_UV #2 : INRUSH_RY #3 : PWR_RY #4 : Zerocrossing #5 : RPM_Feedback #6 : FAN_PWM #7 : BLDC_PS #8 : DC 5V #9 : GND #10 : DC 12V	② CN01-AC LOAD #1 : - #2 : - #3 : FAN LOW_COMP #4 : FAN HIGH_FAN #5 : FAN TURBO_4WA	③ CN41-EVA IN/ROOM #1 : ROOM-TH #2 : GND #3 : EVA IN-TH #4 : GND	④ CN81-ERROR/COMP #1 : DC 12V #2 : ERROR_Check #3 : DC 12V #4 : Comp_Chec
⑤ CN83-EXT_CTRL #1 : GND #2 : External control	⑥ CN903-DISPLAY #1 : DC 12V #2 : GND #3 : PANEL_TXD #4 : PANEL_RXD #5 : REMOCON_RXD #6 : DC 5V #7 : KEY_INT	⑦ CN45-SPI #1 : GND #2 : GND #3 : SPI_Control #4 : -	⑧ CN302-COMM #1 : F1 #2 : F2 #3 : DC 12V #4 : GND #5 : F3 #6 : F4
⑨ CN61-STEP UP/DOWN #1 : DC 12V #2 : UB_12B' #3 : UB_12A' #4 : UB_12B #5 : UB_12A	⑩ CN63-STEP LEFT/RIGH #1 : DC 12V #2 : UB_12B' #3 : UB_12A' #4 : UB_12B #5 : UB_12A		

STAND (Cont.)

■ Power PCB (AM140JNPKH/TK)

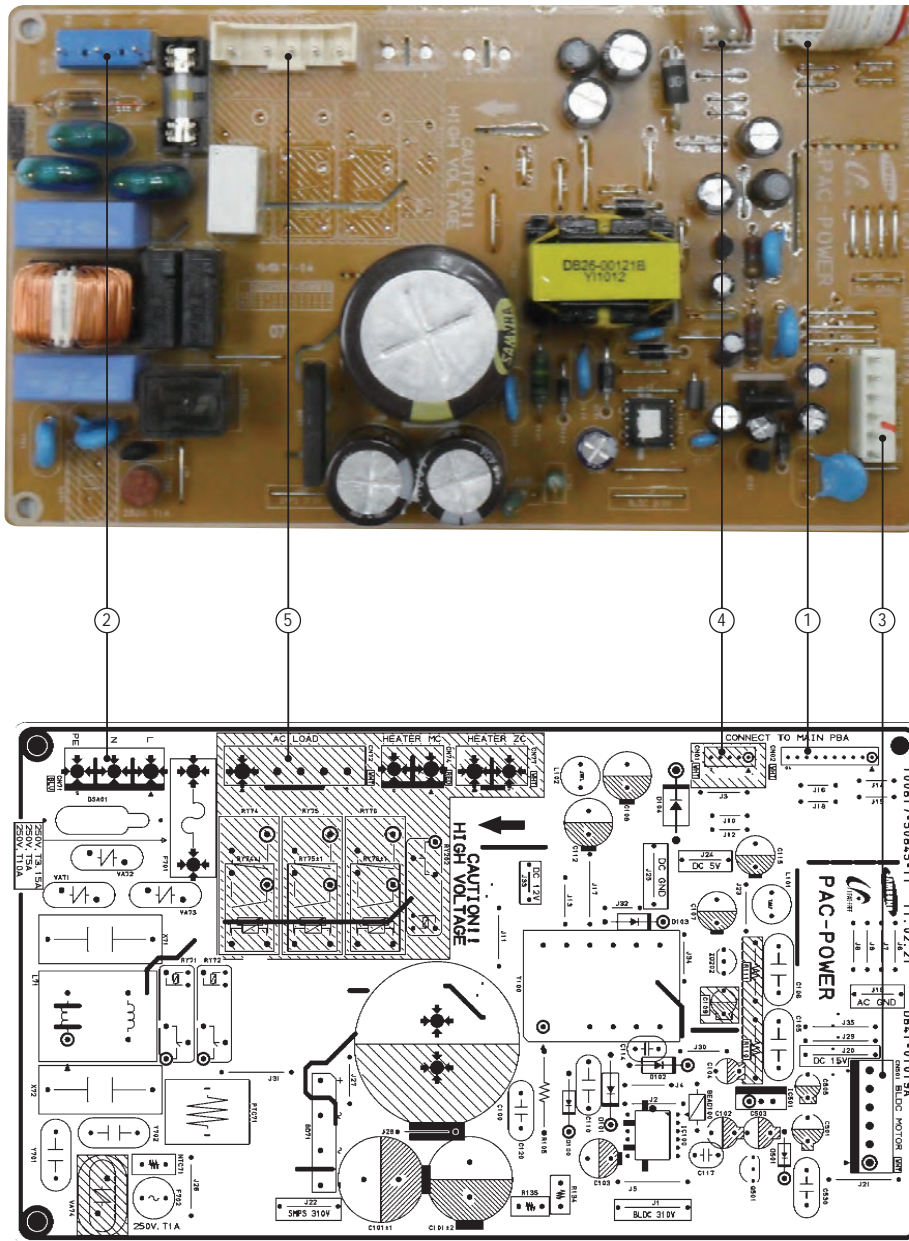

<p>① CN02-MAIN PBA</p> <ul style="list-style-type: none"> #1: DC12V #2: GND #3: DC5V #4: BLDC_PS #5: FAN_PWM #6: RPM_FEEDBACK #7: ZERO_CROSS #8: PWR_RY_12 #9: INRUSH_RY_12 #10: DETECT_OV/LV 	<p>② CN71-POWER</p> <ul style="list-style-type: none"> #1: L #2: NC #3: N #4: NC #5: EARTH 	<p>③ CN501-BLDC MOTOR</p> <ul style="list-style-type: none"> #1: DC310V #2: NC #3: AGND #4: DC15V #5: Vsp #6: RPM_FEEDBACK 	<p>④ CN01-MAIN PBA</p> <ul style="list-style-type: none"> #1: FAN_TURBO_4WAY_V12 #2: FAN_HIGH_FAN_12 #3: FAN_LOW_COMP_12 #4: HEATER_CTRL_12A #5: HEATER_ZC 	<p>⑤ CN72-AC LOAD</p> <ul style="list-style-type: none"> #1: N #2: NC #3: COMPRESSOR #4: OUTDOOR FAN MOTOR #5: OUTDOOR 4WAY/VV
--	--	---	--	--

STAND (Cont.)

■ Panel (AM140JNPKH/TK)

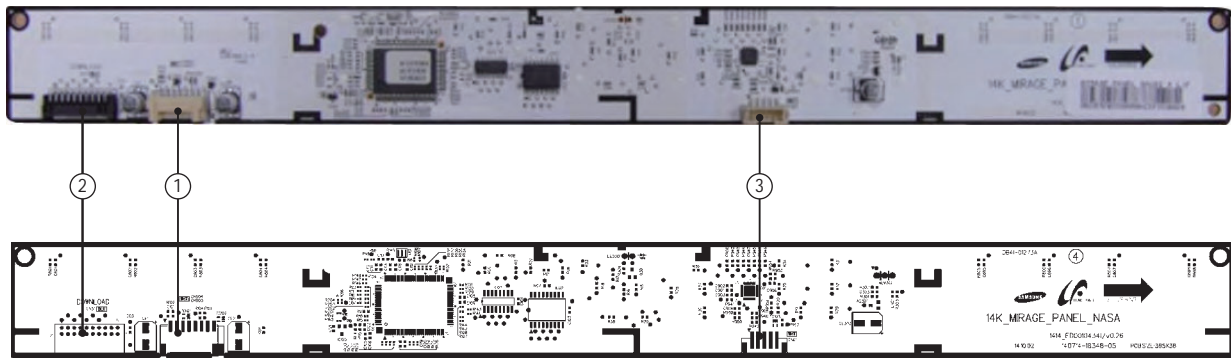

<p>① CN903-DISPLAY</p> <p>#1: DC 12V #2: GND #3: PANEL_TXD #4: PANEL_RXD #5: REMOCON_RXD #6: DC 5V #7: KEY_INT</p>	<p>② CN31-DOWNLOAD(MICOM)</p> <p>#1~#20: Download</p>	<p>③ CN01-DOWNLOAD(Touch-IC)</p> <p>#1: DC 5V #2: GND #3: - #4: I2C #5: I2C</p>
---	--	--

Floor Standing (Cont.)

■ Main PCB (AM***FNFDEH*)

① CN100-AC POWER #1 : L #3 : N	② CN703-MOTOR #1 : N #3,5,7,9 : FAN MOTOR CONTROL SIGNAL	③ CN702-HOT COIL #1 : N #3 : HOT COIL CONTROL SIGNAL	④ CN140-THERMAL FUSE #1 : THERMAL FUSE SIGNAL #2 : GND
⑤ SH01-EARTH #1 : EARTH	⑥ CN81-ERROR/COMP CHECK #1 : DC 12V #2 : ERROR CHECK SIGNAL #3 : DC 12V #4 : COMP CHECK SIGNAL	⑦ CN413-EVA IN/OUT/DIS TEMP. SENSOR #1 : EVI IN TEMP. SENSOR #3 : EVI OUT TEMP. SENSOR #5 : DISCHARGE TEMP. SENSOR #2,4,6 : GND	⑧ CN103-DRAIN PUMP #1 : DRAIN PUMP CONTROL SIGNAL #2 : GND
⑨ CN412-ROOM TEMP. SENSOR #1 : ROOM TEMP. SENSOR #2 : GND	⑩ CN301-DOWNLOAD #1~8 : DOWNLOAD SIGNAL #9 : GND #10~11 : DC 5V #12~16 : DOWNLOAD SIGNAL #17 : GND #18~20 : DOWNLOAD SIGNAL	⑪ CN83-EXTERNAL CONTROL #1 : GND #2 : EXTERNAL CONTROL SIGNAL	⑫ CN501-DISPLAY #1 : DC 12V #3~10,13 : PANEL SIGNAL #11 : GND #12 : DC 5V
⑬ CN808-EEV(DVM) #1~4 : EEV CONTROL SIGNAL #5~6 : DC 12V	⑭ CN804-VENTILATOR #1 : DC 12V #2 : VENTILATOR CONTROL SIGNAL	⑮ CN311-2WIRE SUB #1 : DC 12V #2~5 : COMMUNICATION SIGNAL #6 : DC 5V #7~12 : COMMUNICATION SIGNAL	⑯ CN201-EEPROM #1 : GND #2 : NOT USED #3 : DC 5V #4~7 : EEPROM SIGNAL
⑰ CN302-COM1 COM2 #1~2 : GND #3 : SPI CONTROL SIGNAL #4 : NOT USED	⑱ CN302-COMMUNICATION #1~2 : COM1 COMMUNICATION SIGNAL #3 : DC 12V #4 : GND #4~6 : COM2 COMMUNICATION SIGNAL	⑲ CN411-FLOAT SWITCH #1 : FLOAT SWITCH SIGNAL #2 : GND	

Floor Standing Type

■ Main PCB (AM***MNFDH*)

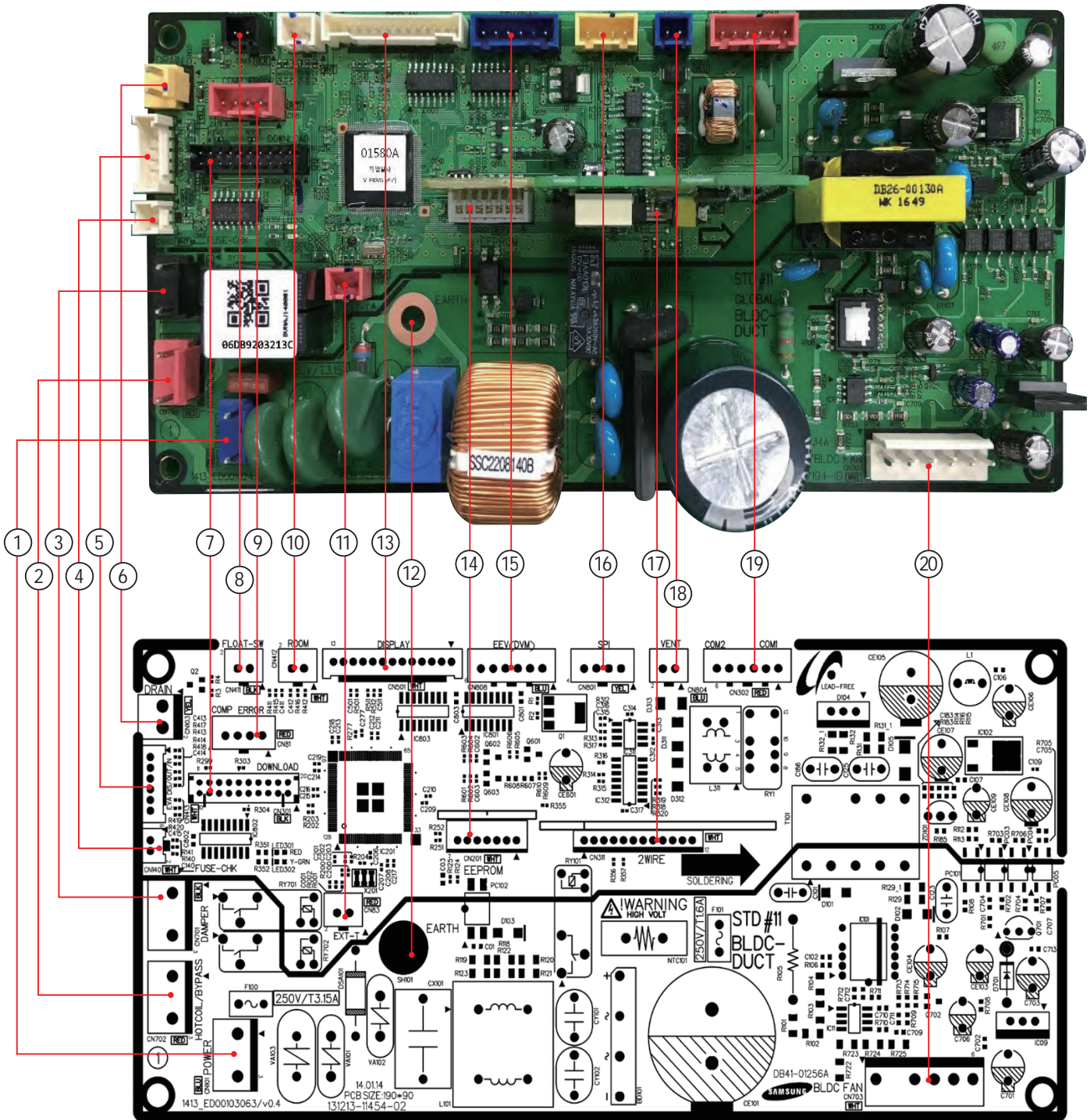

Floor Standing (Cont.)

■ Main PCB (AM***MNFDEH*) (Cont.)

<p>① #1 CN100-AC POWER #3: IN</p>	<p>② #1 CN702-HOT COIL or BYPASS #3: HOT COIL or BYPASS CONTROL SIGNAL</p>	<p>③ #1 CN703-DAMPER #3: DAMPER CONTROL SIGNAL</p>	<p>④ #1 CN140-THERMAL FUSE #2: GND</p>
<p>⑤ #1 CN413-EVA IN/OUT/DIS TEMP. SENSORS #3: EVA OUT TEMP. SENSOR #5: DISCHARGE TEMP. SENSOR #2,4,6: GND</p>	<p>⑥ #1 CN103-DRAIN PUMP #2: GND</p>	<p>⑦ #1 CN301-DOWNLOAD #9: GND #10~11: DC 5V #12~16: DOWNLOAD SIGNAL #17: GND #18~20: DOWNLOAD SIGNAL</p>	<p>⑧ #1 CN411-FLOAT SWITCH #2: GND</p>
<p>⑨ #1 CN81-ERROR/COMP CHECK #2: ERROR CHECK SIGNAL #3: DC 12V #4: COMP CHECK SIGNAL</p>	<p>⑩ #1 CN412-ROOM TEMP. SENSOR #2: GND</p>	<p>⑪ #1 CN83-EXTERNAL CONTROL #2: EXTERNAL CONTROL SIGNAL</p>	<p>⑫ #1 SH101-EARTH</p>
<p>⑬ #1 CN501-DISPLAY #3~10,13: PANEL SIGNAL #11: GND #12: DC 5V</p>	<p>⑭ #1 CN201-EEPROM #2: NOT USED #3: DC 5V #4~7: EEPROM SIGNAL</p>	<p>⑮ #1 CN808-EEV(DVM) #5~6: DC 12V</p>	<p>⑯ #1 CN801-SPI #3: SPI CONTROL SIGNAL #4: NOT USED</p>
<p>⑰ #1 CN311-2WIRE SUB #2~5: COMMUNICATION SIGNAL #6: DC 5V #7~12: COMMUNICATION SIGNAL</p>	<p>⑱ #1 CN804-VENTILATOR #2: VENTILATOR CONTROL SIGNAL</p>	<p>⑲ #1 CN302-COMMUNICATION #3: DC 12V #4: GND #4~6: COM2 COMMUNICATION SIGNAL</p>	<p>⑳ #1 CN703-BLDC MOTOR #3~6: FAN MOTOR CONTROL SIGNAL</p>

5-1-30 Wall Mounted type(MAX)
- Main PBA (AM*MNQDEH*)**

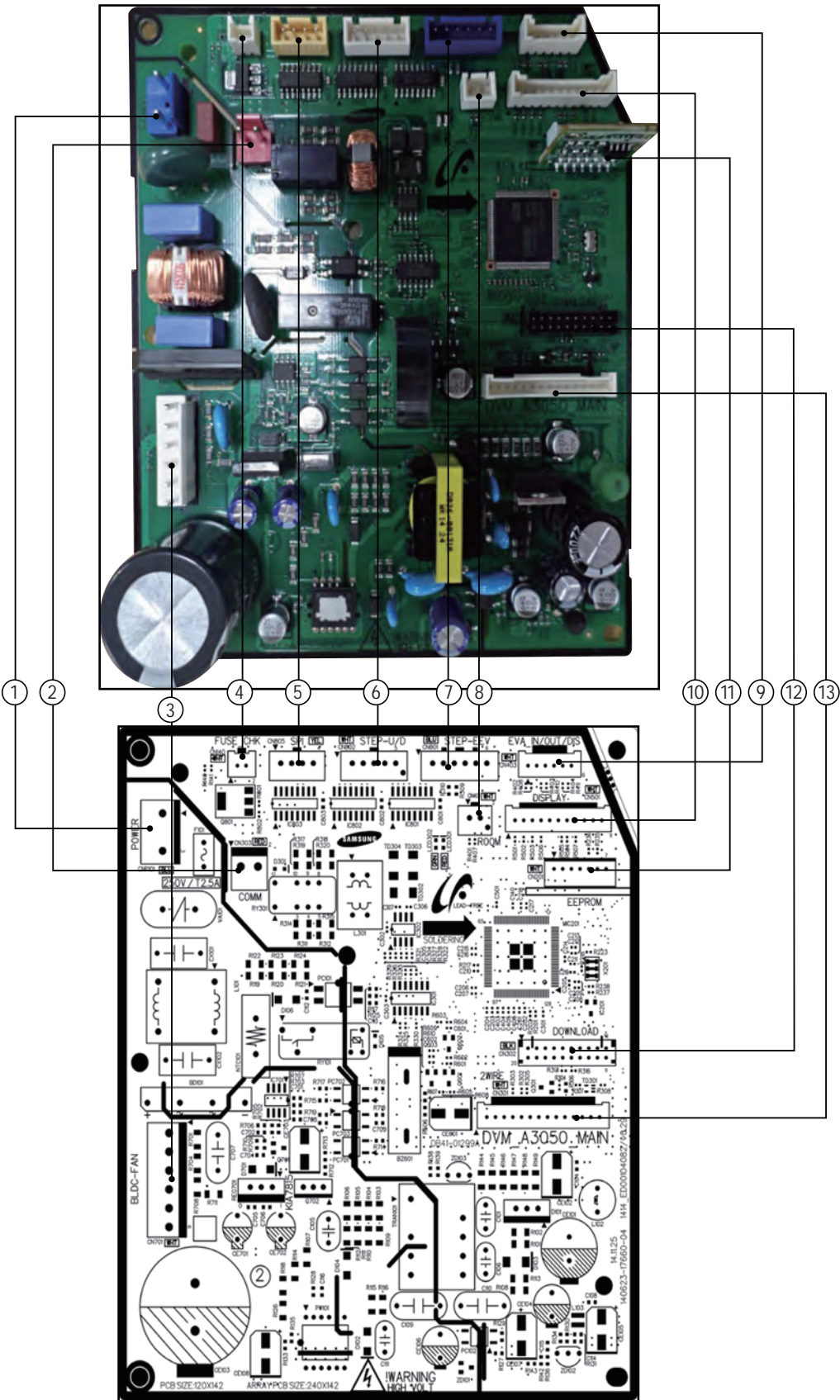

Wall Mounted type(MAX) (Cont.)

- Main PBA (AM***MNQDEH*) (cont.)

<p>① CNP101-POWER</p> <p>#1 : L #2 : NOT USED #3 : N</p>	<p>② CN303-COM1</p> <p>#1~2 : COMMUNICATION SIGNAL</p>	<p>③ CN701-BLDC FAN</p> <p>#1 : DC 310V #2 : NOT USED #3 : GND #4 : PWM SIGNAL #5 : FEEDBACK SIGNAL</p>	<p>④ CN140-FUSE CHECK</p> <p>#1 : THERMAL FUSE SIGNAL #2 : GND</p>
<p>⑤ CN805-SPI</p> <p>#1~2 : GND #3 : SPI CONTROL SIGNAL #4 : NOT USED</p>	<p>⑥ CN802-STEP UP/DOWN</p> <p>#1 : DC 12V #2~5 : LOUVER SIGNAL</p>	<p>⑦ CN801-EEV</p> <p>#1~4 : EEV SIGNAL #5~6 : DC 12V</p>	<p>⑧ CN401-ROOM</p> <p>#1 : OOM TEMPERATURE SENSOR SIGNAL #2 : GND</p>
<p>⑨ CN403-EVA IN/OUT/DIS</p> <p>#1 : EVA IN TEMPERATURE SENSOR SIGNAL #2 : GND #3 : EVA OUT TEMPERATURE SENSOR SIGNAL #4 : GND #5 : DISCHARGE TEMPERATURE SENSOR SIGNAL #6 : GND</p>	<p>⑩ CN501-DISPLAY</p> <p>#1~3 : LED SIGNAL #4 : REMOCON SIGNAL #5 : GND #6 : DC 5V #7~8 : REMOCON SIGNAL #9~11 : NOT USED</p>	<p>⑪ CN201-EEPROM</p> <p>#1 : GND #2 : NOT USED #3 : DC 5V #4~7 : EEPROM SIGNAL</p>	<p>⑫ CN302-DOWNLOAD</p> <p>#1~8 : DOWNLOAD SIGNAL #9 : GND #10~11 : DC 5V #12~16 : DOWNLOAD SIGNAL #17 : GND #18~20 : DOWNLOAD SIGNAL</p>
<p>⑬ CN301-to 2WIRE SUB</p> <p>#1~2 : COMMUNICATION SIGNAL #3~4 : SUB PBA SIGNAL #5 : EXTERNAL CONTROL SIGNAL #6 : COMP CHECK SIGNAL #7 : ERROR CHECK SIGNAL #8 : DC 5V #9 : GND #10 : DC 12V #11~14 : COMMUNICATION SIGNAL</p>			

Wall Mounted type(MAX) (Cont.)
- Sub PCB (AM*MNQDEH*) (Cont.)**

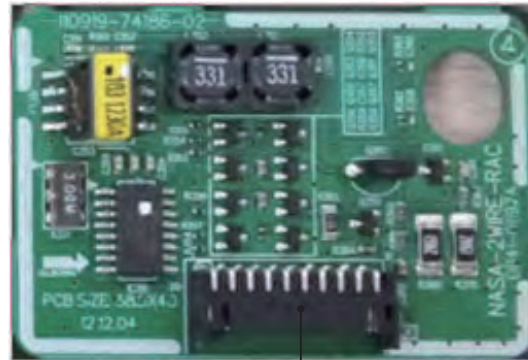

①

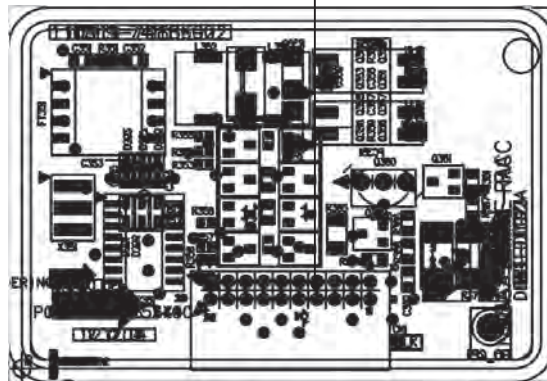

① **CN1-2WIRES COMM.**

#1,#2,#19,#20:COMM. SIGNAL
 #3,#18:EXTERNAL CONTROL
 #4,#17:COMP CHECK
 #5,#16:ERROR CHECK
 #6:VCC(DC5V)
 #7,#14:GND
 #8,#13,#15:DC12V
 #9~#12:COMM. SIGNAL

5-1-30 Wall Mounted type(MAX) - Main PBA (AM***MNQDEH*)

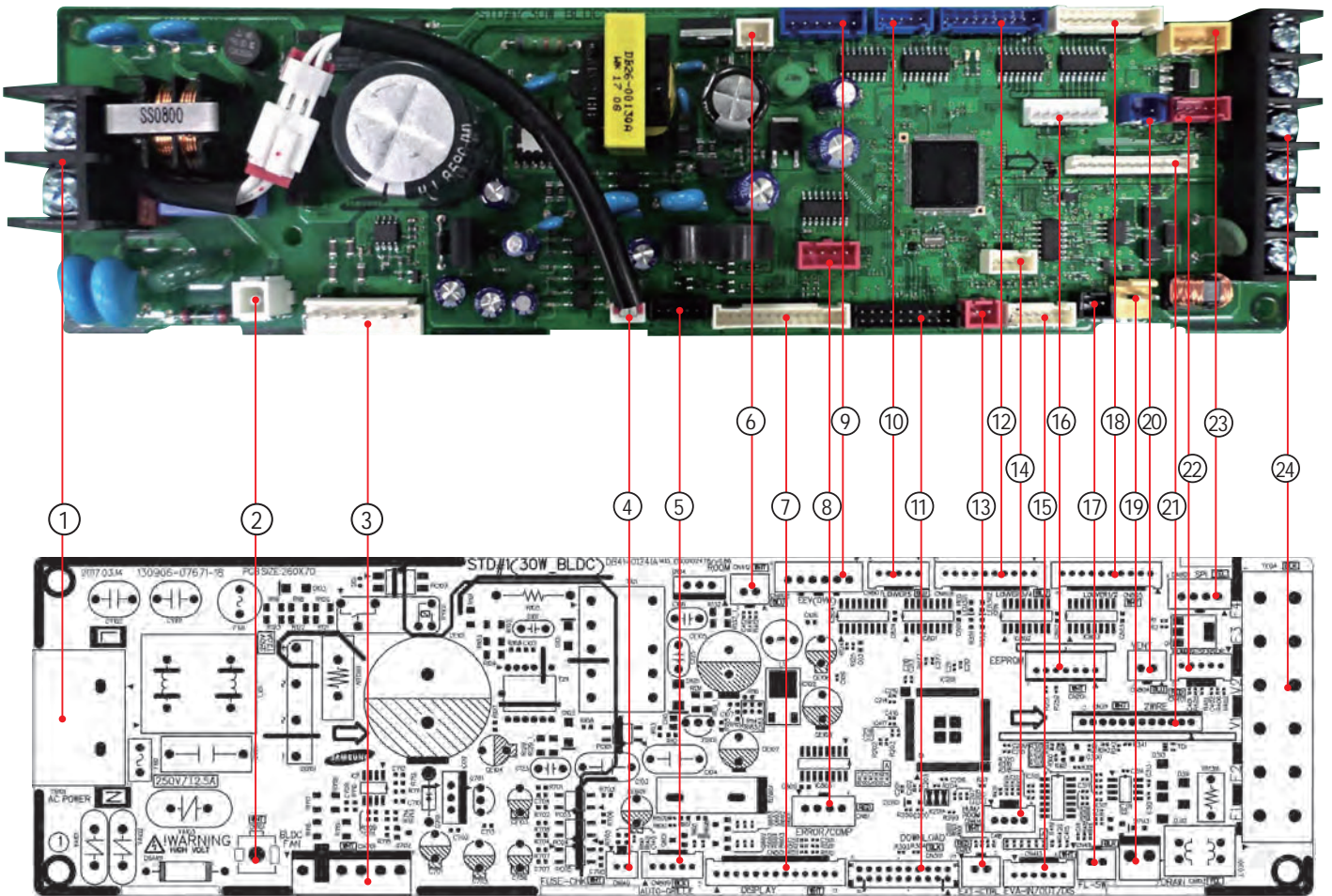

Wall Mounted type(MAX) (Cont.)**- Main PBA (AM***MNQDEH*) (cont.)**

① TB101-AC POWER #1: POWER(L) #2: POWER(N)	② CN101-GND #1: GND	③ CN701-BLDC MOTOR #1: DC310V #3 : GND #4 : DC15V #5 : FAN RPM #6 : RPM FEEDBACK	④ CN140-FUSE CHECK #1: FUSE CHECK SIGNAL #2: GND
⑤ CN809- AUTO GRILLE #1 : DC12V #4 : REMOCON CONTROL SIGNAL #5 : GND	⑥ CN412-THERMISTOR #1 : THERMISTOR #2 : GND	⑦ CN501-DISPLAY #1: DC12V #2: LED_0 #3: LED_1 #4: LED_2 #5: LED_3 #6: LED_4 #7: LED_5 #8: REMOCON OUTPUT SIGNAL #9 : AUTO SWITCH #10: REMOCON INPUT SIGNAL #11: GND #12: DC5V #13: GND	⑧ CN81-ERROR/COMP CHECK #1: DC12V #2: ERROR CHECK(GND) #3: DC12V #4: COMP/OPER. CHECK(GND)
⑨ CN808-EEV #1~#4: EEV CHECK #5 : DC12V #6 : DC12V	⑩ CN807-LOUVERS #1 : DC12V #2~#5: LOUVER CONTROL SIGNAL	⑪ CN301- DOWNLOAD	⑫ CN806-LOUVER3/4 #1 : DC12V #2~#5: LOUVER CONTROL SIGNAL #6 : DC12V #7~#10: LOUVER CONTROL SIGNAL
⑬ CN83-EXTERNAL CONTROL #1: GND #2: EXTERNAL CONTROL SIGNAL	⑭ CN414-HUMIDITY SENSOR #1 : DC5V #2 : GND #3 : TEMPERATURE SENSOR #4 : HUMIDITY SENSOR	⑮ CN413:THERMISTOR #1 : EVA-IN TEMPERATURE SENSOR #2 : GND #3 : EVA-OUT TEMPERATURE SENSOR #4 : GND #5 : DISCHARGE TEMPERATURE SENSOR #6 : GND	⑯ CN201-EEPROM #1: GND #3: DC5V #4: EEPROM_SELECT #5: EEPROM_SO #6: EEPROM_SI #7: EEPROM_CLK
⑰ CN411-FLOAT SWITCH #1: FLOAT SWITCH SIGNAL INPUT #2: GND	⑱ CN805-LOUVER1/2 #1 : DC12V #2~#5: LOUVER CONTROL SIGNAL	⑲ CN103-DRAIN PUMP #1: DRAIN PUMP CONTROL SIGNAL #2: GN	⑳ CN804-VENTILATOR #1: DC12V #2: VENT CONTROL SIGNAL
㉑ CN311-2WIRE SUB PBA	㉒ CN401- CLEAN PANEL COMMUNICAITON #1: DC12V #2: CLEAN PANEL COMMUNICAITON (TXD) #3: CLEAN PANEL COMMUNICAITON (RXD) #4: GND	㉓ CN801-SPI #1: GND #2: GND #3: SPI CONTORL SIGNAL	㉔ TE04-COMMUNICATION #1: COM1(F1) #2: COM1(F2) #3: V1(DC12V) #4: V2(GND) #5: COM2(F3) #6: COM2(F4)

5-1-31 Wind-free 1way cassette type

- Main PBA (AM017/022NN1PEH*, AM056/071NN1DEH*)

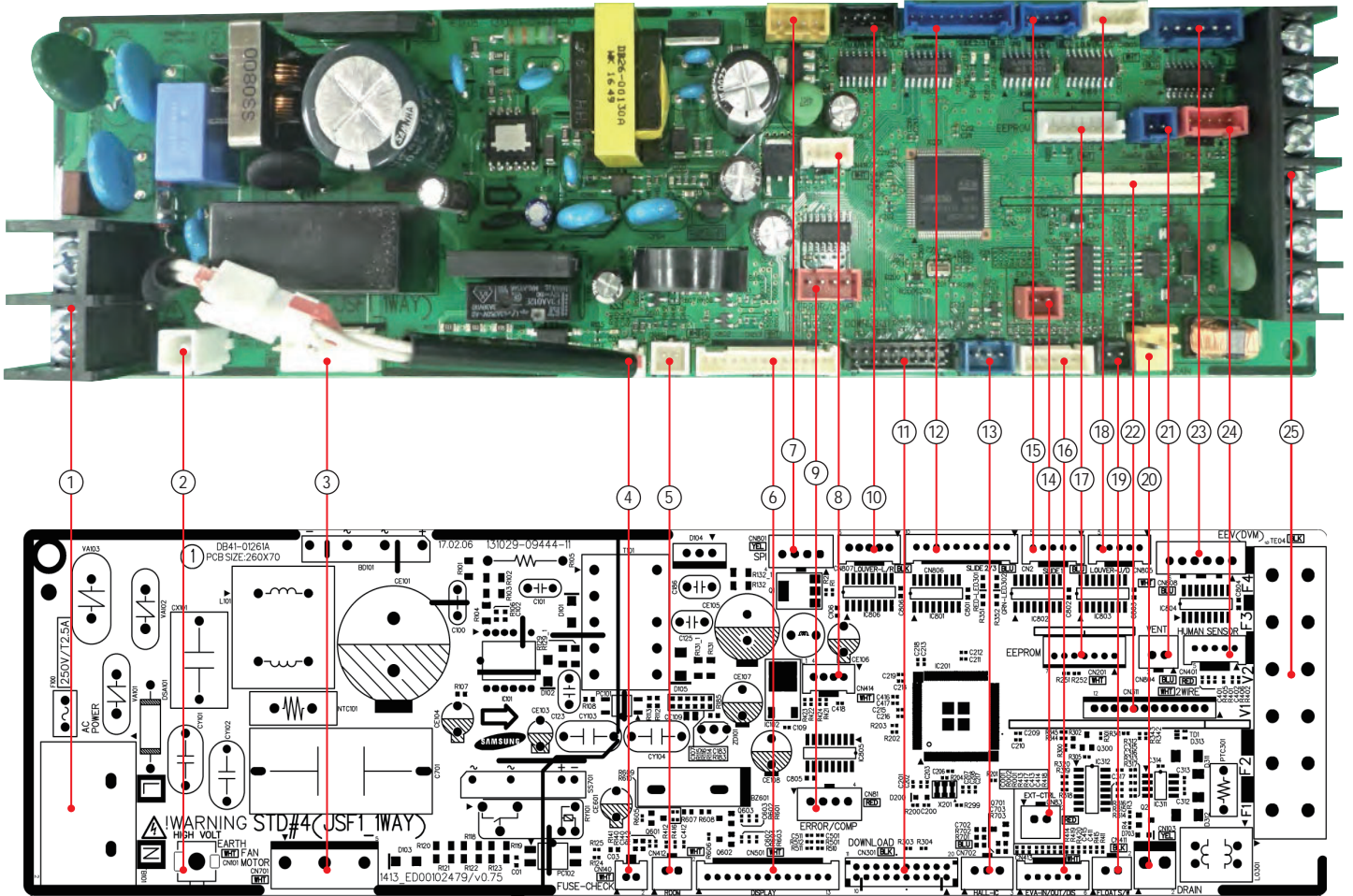

Wind-free 1way cassette type (Cont.)

- Main PBA (AM022/028/036NN1DEH*) (Cont.)

① TB101-AC POWER #1: AC POWER(L) #2: AC POWER(N)	② CN101-GND #1: GND	③ CN701-BLDC MOTOR #1: POWER(N) #3 : SSR MOTOR POWER(L) #5 : POWER(N)	④ CN140-FUSE CHECK #1: FUSE CHECK SIGNAL #2: GND
⑤ CN412-THERMISTOR #1 : ROOM TEMPERATURE SENSOR #2 : GND	⑥ CN501- 디스플레이부 #1: DC12V #2: LED_0 #3: LED_1 #4: LED_2 #5: LED_3 #6: LED_4 #7: LED_5 #8: REMOCON OUTUPUT SIGNAL #9 : AUTO SWITCH #10: REMOCON INPUT SIGNAL #11: GND #12: DC5V #13: GND	⑦ CN801-SPI #1: GND #2: GND #3: SPI CONTROL SIGNAL	⑧ CN414-HUMIDITY SENSOR #1 : DC5V #2 : GND #3 : TEMPERATURE SENSOR #4 : HUMIDITY SENSOR
⑨ CN81- ERROR/COMP CHECK #1: DC12V #2: ERROR CHECK(GND) #3: DC12V #4: COMP/OPER. CHECK(GND)	⑩ CN807-LOUVER L/R #1 : DC12V #2~#5: LOUVER CHECK	⑪ CN301- DOWNLOAD	⑫ CN807-LOUVERS #1 : DC12V #2~#5: LOUVER CHECK #6 : DC12V #7~#10: LOUVER CHECK
⑬ CN702-HALL IC #1 : DC5V #2 : GND #3 : MOTOR FEEDBACK SIGNAL	⑭ CN83- EXTERNAL CONTROL #1: GND #2: EXTERNAL CONTROL SIGNAL	⑮ CN806-LOUVER3/4 #1 : DC12V #2~#5: LOUVER CHECK	⑯ CN413:THERMISTOR #1 : EVA-IN TEMPERATURE SNESOR #2 : GND #3 : EVA-OUT TEMPERATURE SNESOR #4 : GND #5 : DISCHARGE TEMPERATURE SNESOR #6 : GND
⑰ CN201-EEPROM #1: GND #3: DC5V #4: EEPROM_SELECT #5: EEPROM_SO #6: EEPROM_SI #7: EEPROM_CLK	⑱ CN805-LOUVER1/2 #1 : DC12V #2~#5: LOUVER CHECK	⑲ CN411-FLOAT SWITCH #1: F/S SIGNAL #2: GND	⑳ CN103-DRAIN PUMP #1: D/ P POWER(DC12V) #2: GND
㉑ CN804-VENTILATOR #1: DC12V #2: VENT CONTROL SIGNAL	㉒ CN311-2 선리모컨	㉓ CN808-EEV #1~#4: EEV CHECK #5 : DC12V #6 : DC12V	㉔ CN401- CLEAN PANEL COMMUNICATION #1: DC12V #2: CLEAN PANEL COMMUNICAITON(TXD) #3: CLEAN PANEL COMMUNICAITON(RXD) #4: GND
㉕ TE04-COMMUNICATION #1: COM1(F1) #2: COM1(F2) #3: V1(DC12V) #4: V2(GND) #5: COM2(F3) #6: COM2(F4)			

5-1-32 4Way Cassette(600x600) - MAIN PBA(AM***HNNDEH/TL)

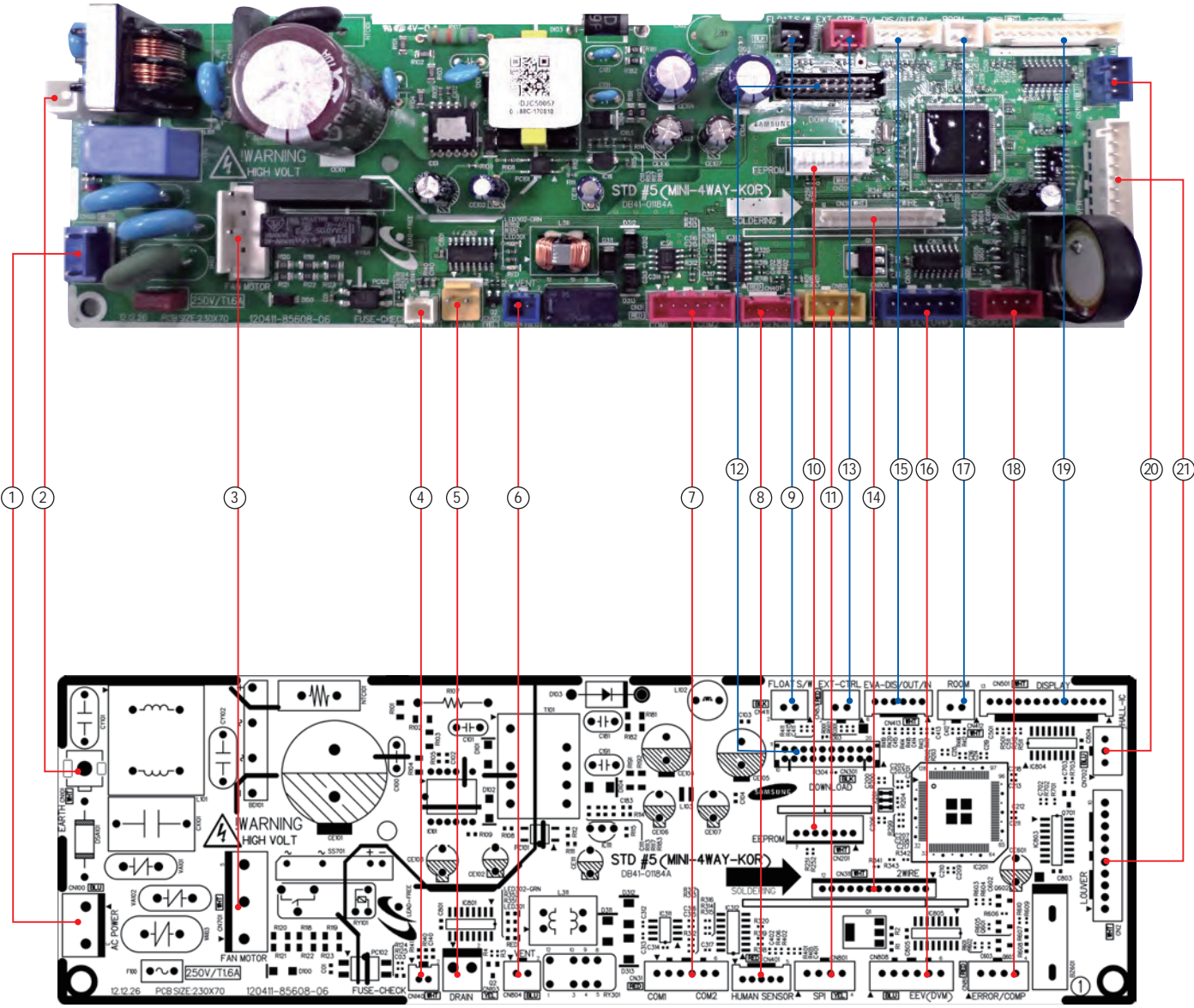

4Way Cassette(600x600) (Cont.)

- MAIN PBA(AM*HNNDEH/TL) (Cont.)**

<p>① CN100-AC POWER #1: AC POWER(L) #2: AC POWER(N)</p>	<p>② CN101-GND #1: GND</p>	<p>③ CN701-FAN MOTOR #3 : SSR MOTOR POWER(L) #5 : POWER(N)</p>	<p>④ CN140-FUSE CHECK #1: FUSE CHECK SIGNAL #2: GND</p>
<p>⑤ CN103-DRAIN PUMP #1: DRAIN PUMP CONTROL SIGNAL #2: GND</p>	<p>⑥ CN804-VENTILATOR #1: DC12V #2: VENT CONTROL SIGNAL</p>	<p>⑦ CN31-COMMUNICATION #1: COM1(F1) #2: COM1(F2) #3: V1(DC12V) #4: V2(GND) #5: COM2(F3) #6: COM2(F4)</p>	<p>⑧ CN401-MOTION DETECTING SENSOR COMMUNICATION #1: DC12V #2: MDS COMMUNICAITON(TXD) #3: MDS PANEL COMMUNICAITON(RXD) #4: GND</p>
<p>⑨ CN411-FLOAT SWITCH #1: FLOAT SWITCH SIGNAL INPUT #2: GND</p>	<p>⑩ CN201-EEPROM #1: GND #3: DC5V #4: EEPROM_SELECT #5: EEPROM_SO #6: EEPROM_SI #7: EEPROM_CLK</p>	<p>⑪ CN801-SPI #1: GND #2: GND #3: SPI CONTROL SIGNAL</p>	<p>⑫ CN301-DOWNLOAD</p>
<p>⑬ CN83-EXTERNAL CONTROL #1: GND #2: EXTERNAL CONTROL SIGNAL</p>	<p>⑭ CN311-2WIRE SUB PBA</p>	<p>⑮ CN411-FLOAT SWITCH #1 : EVA-IN TEMPERATURE SNESOR #2 : GND #3 : EVA-OUT TEMPERATURE SNESOR #4 : GND #5 : DISCHARGE TEMPERATURE SNESOR #6 : GND</p>	<p>⑯ CN808-EEV #1~#4: EEV CONTORL SIGNAL #5 : DC12V #6 : DC12V</p>
<p>⑰ CN412-THERMISTOR #1 : ROOM TEMPERATURE SENSOR #2 : GND</p>	<p>⑱ CN81-ERROR/COMP CHECK #1: DC12V #2: ERROR CHECK(GND) #3: DC12V #4: COMP/OPER. CHECK(GND)</p>	<p>⑲ CN501-DISPLAY #1: DC12V #2: LED_0 #3: LED_1 #4: LED_2 #5: LED_3 #6: LED_4 #7: LED_5 #8: REMOCON OUTUPUT SIGNAL #9 : AUTO SWITCH #10: REMOCON INPUT SIGNAL #11: GND #12: DC5V #13: GND</p>	<p>⑳ CN702-HALL IC #1 : DC5V #2 : GND #3 : MOTOR FEEDBACK SIGNAL</p>
<p>㉑ CN82-LOUVER #1 : DC12V #2~#5: LOUVER CONTROL SIGNAL #6 : DC12V #7~#10: LOUVER CONTROL SIGNAL</p>			

5-1-33 4Way Cassette(600x600)
- DISPLAY PBA(AM*HNNDEH/TL)**

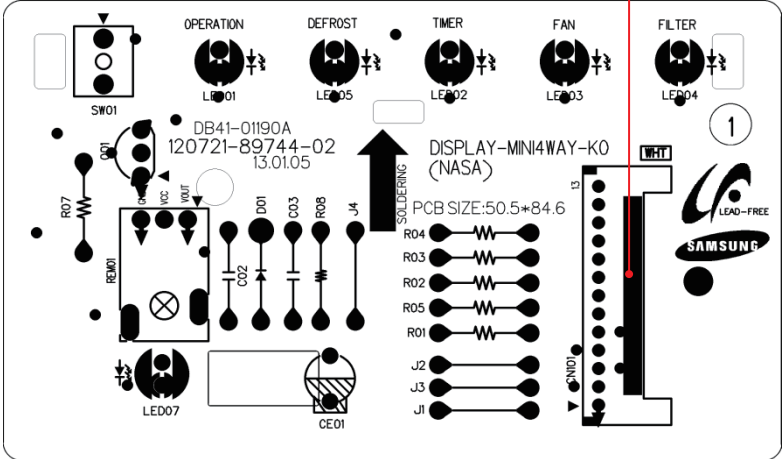
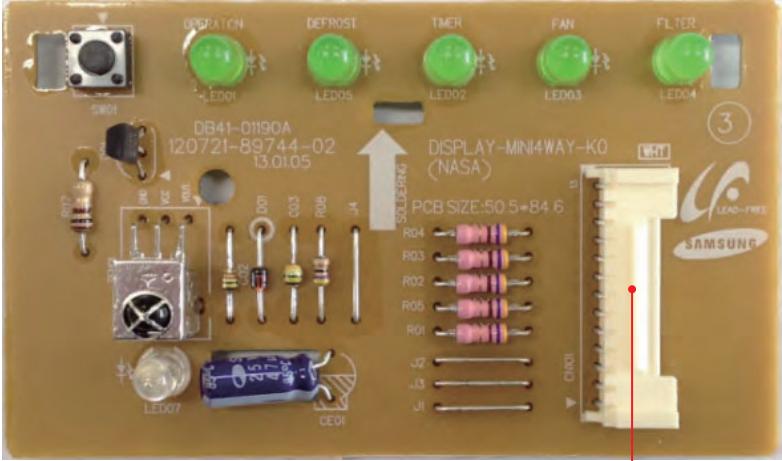

①	CN101-DISPLAY
#1:	DC12V
#2:	LED_0
#3:	LED_1
#4:	LED_2
#5:	LED_3
#6:	LED_4
#7:	-
#8:	REMOCON OUTPUT SIGNAL
#9 :	AUTO SWITCH
#10:	REMOCON INPUT SIGNAL
#11:	GND
#12:	DC5V
#13:	-

6. Wiring Diagram

6-1 Indoor

6-1-1 Global 4Way (Global 4Way(600x600)) cassette type, Slim 1way cassette (small/large)

■ AM***FN4DEH*, AM***FNNDEH*, AM***HNNDEH*, AM***HN1DEH*, AM***JN1DEH*

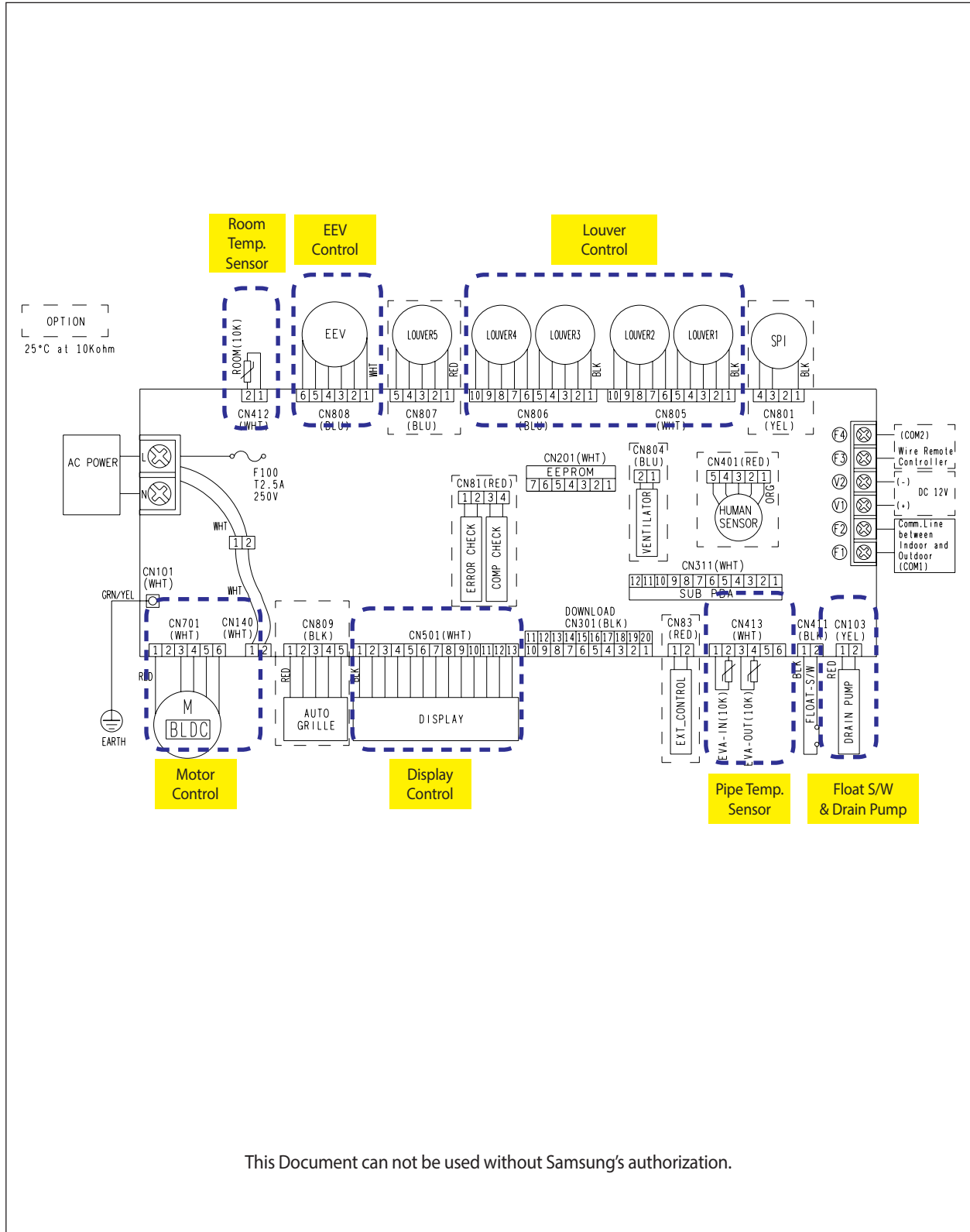

6-1-2 Slim 1 way cassette type (medium)

■ AM***FN1DEH*

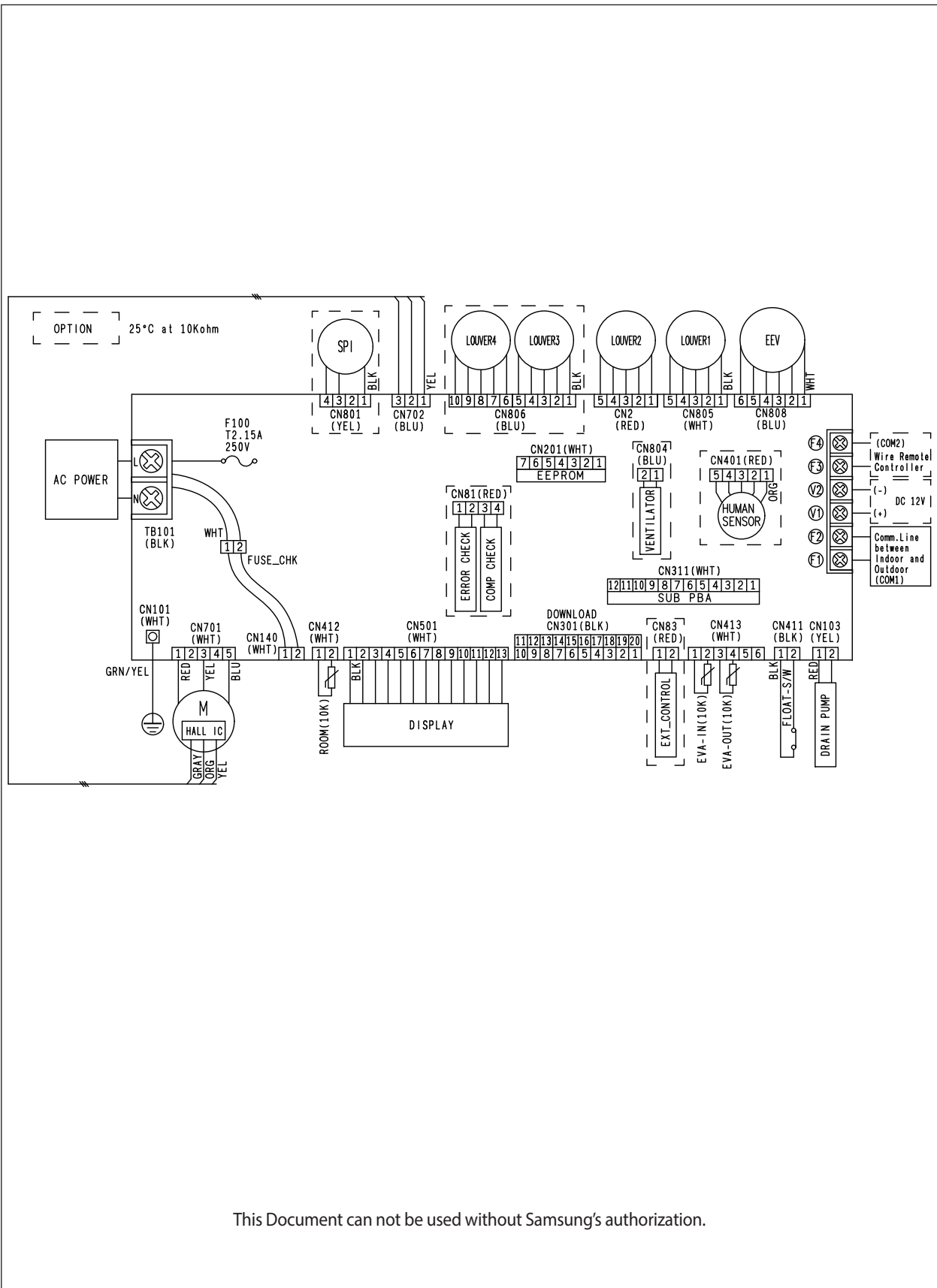

6-1-3 360 cassette

■ AM045/056/071/090/112/128/140KN4DEH*

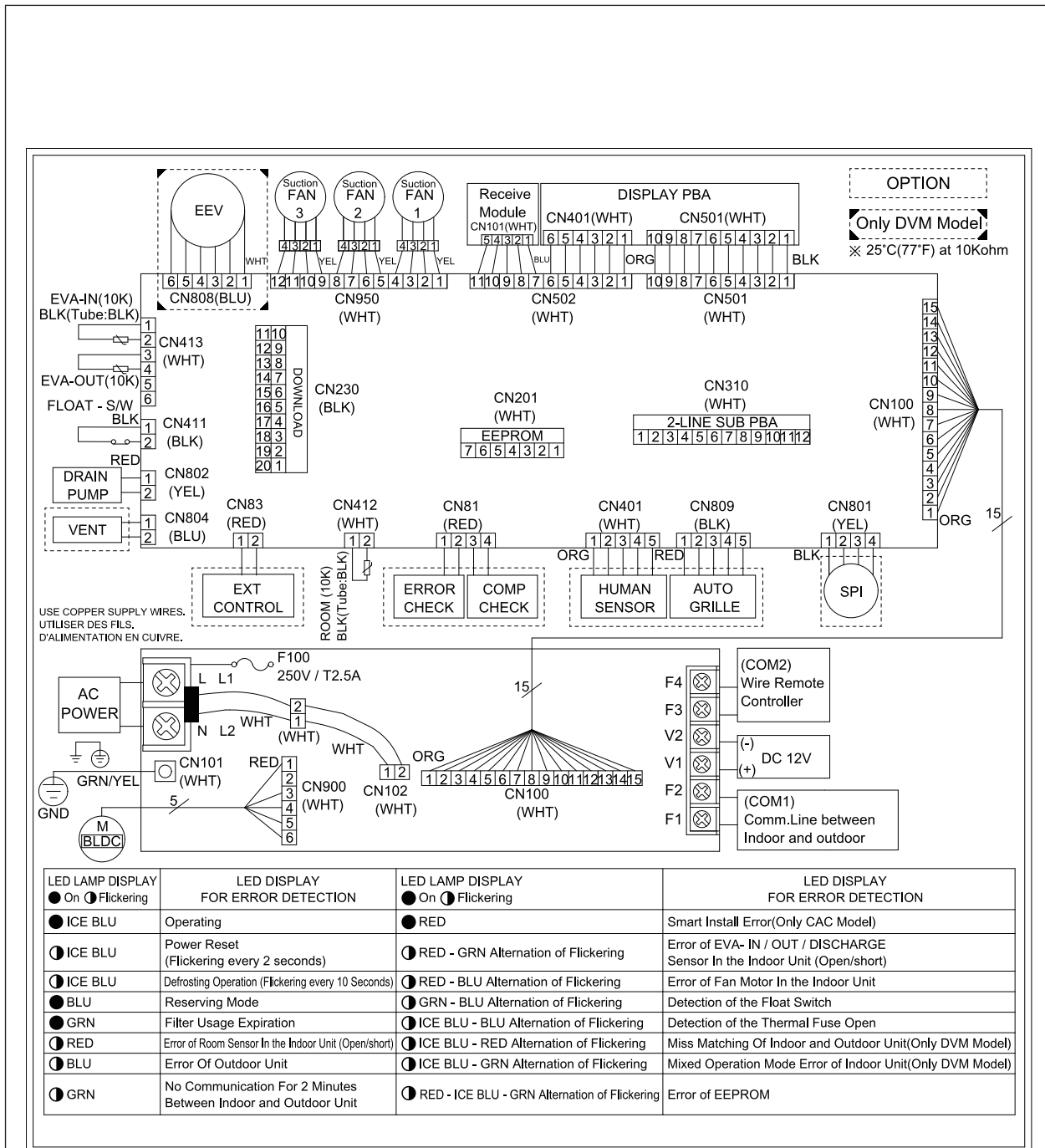

This Document can not be used without Samsung's authorization.

6-1-4 BIG Duct

■ AM220/280FNHDEH*

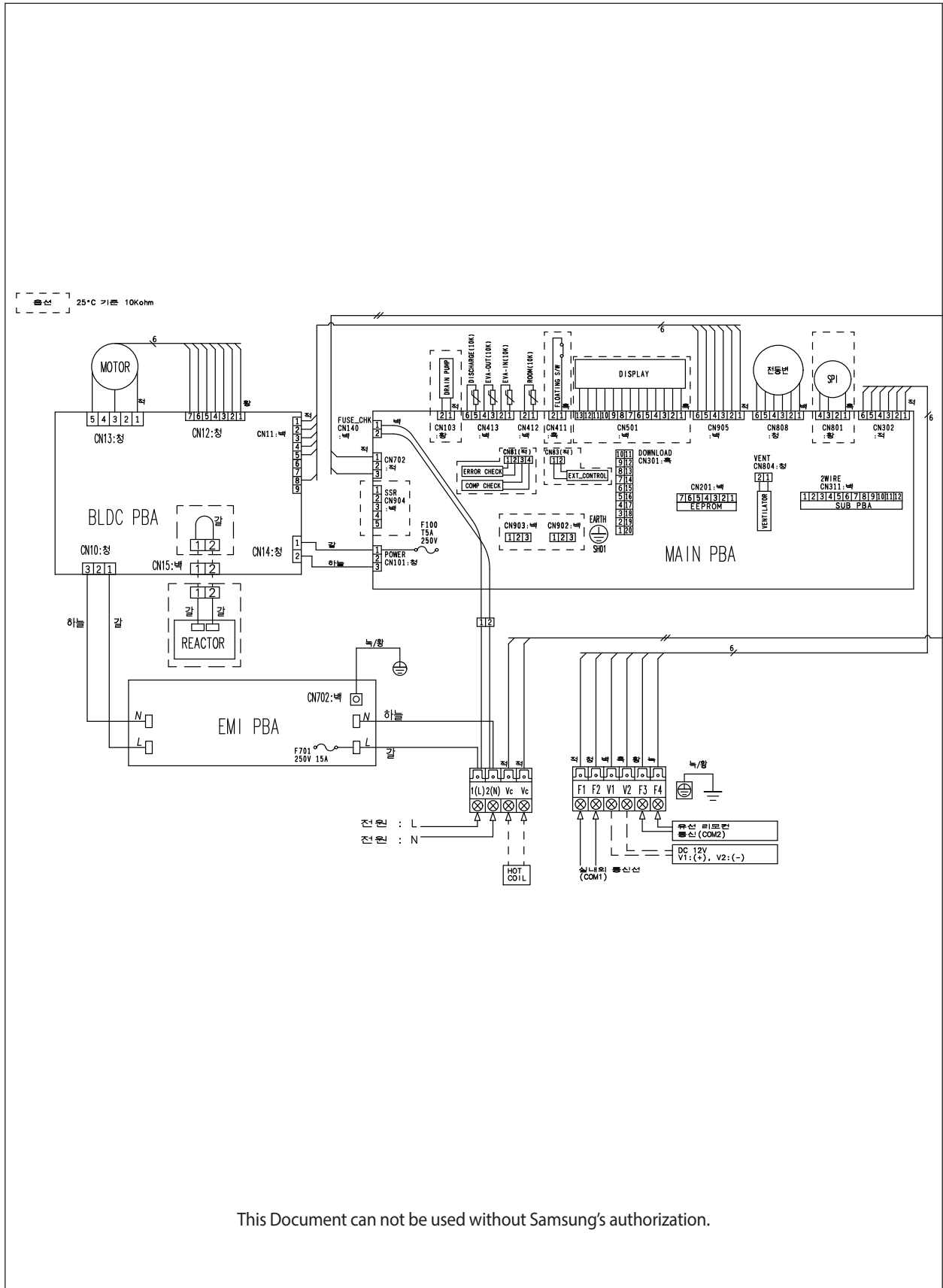

6-1-5 GD-S(Big Duct)

■ AM180JNHFKH/AM224JNHFKH

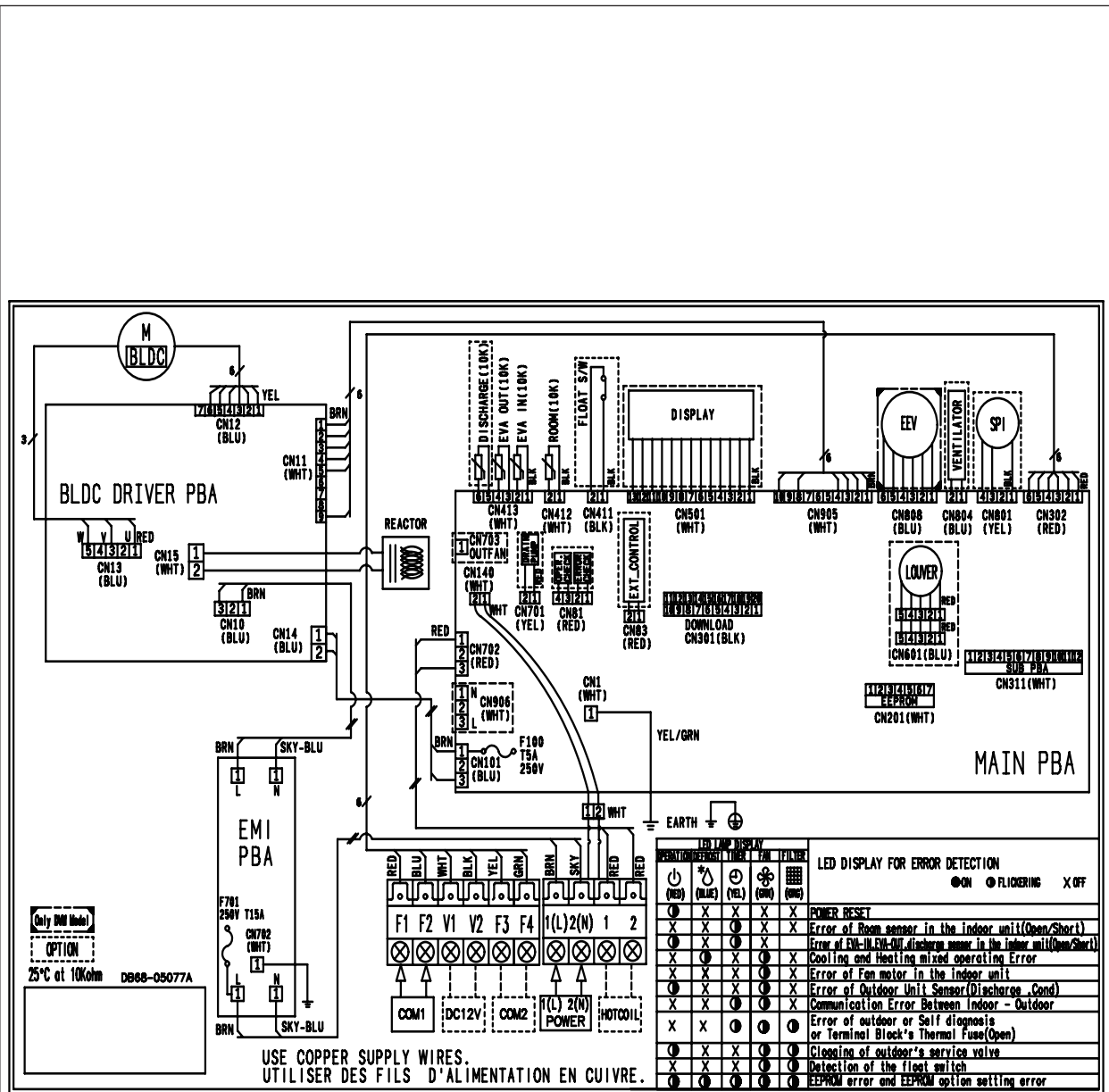

This Document can not be used without Samsung's authorization.

6-1-6 Ceiling

■ AM***FNCDEH*

New_job (Current screen) Scale=0.77 Wed Jan 02 21:38:45 2013

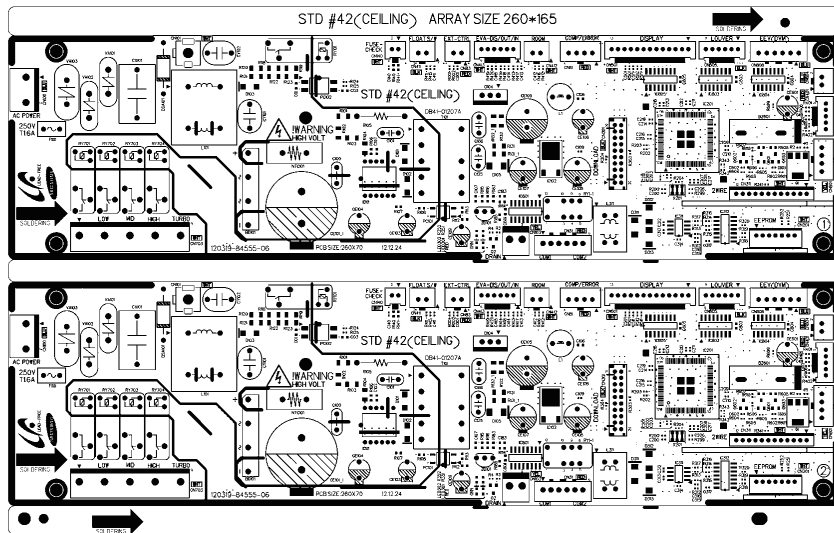

This Document can not be used without Samsung's authorization.

6-1-8 Console

- AM***FNJDEH*, AM***KNJDEH*
- AE022/028/036/056MNJDEH/EU

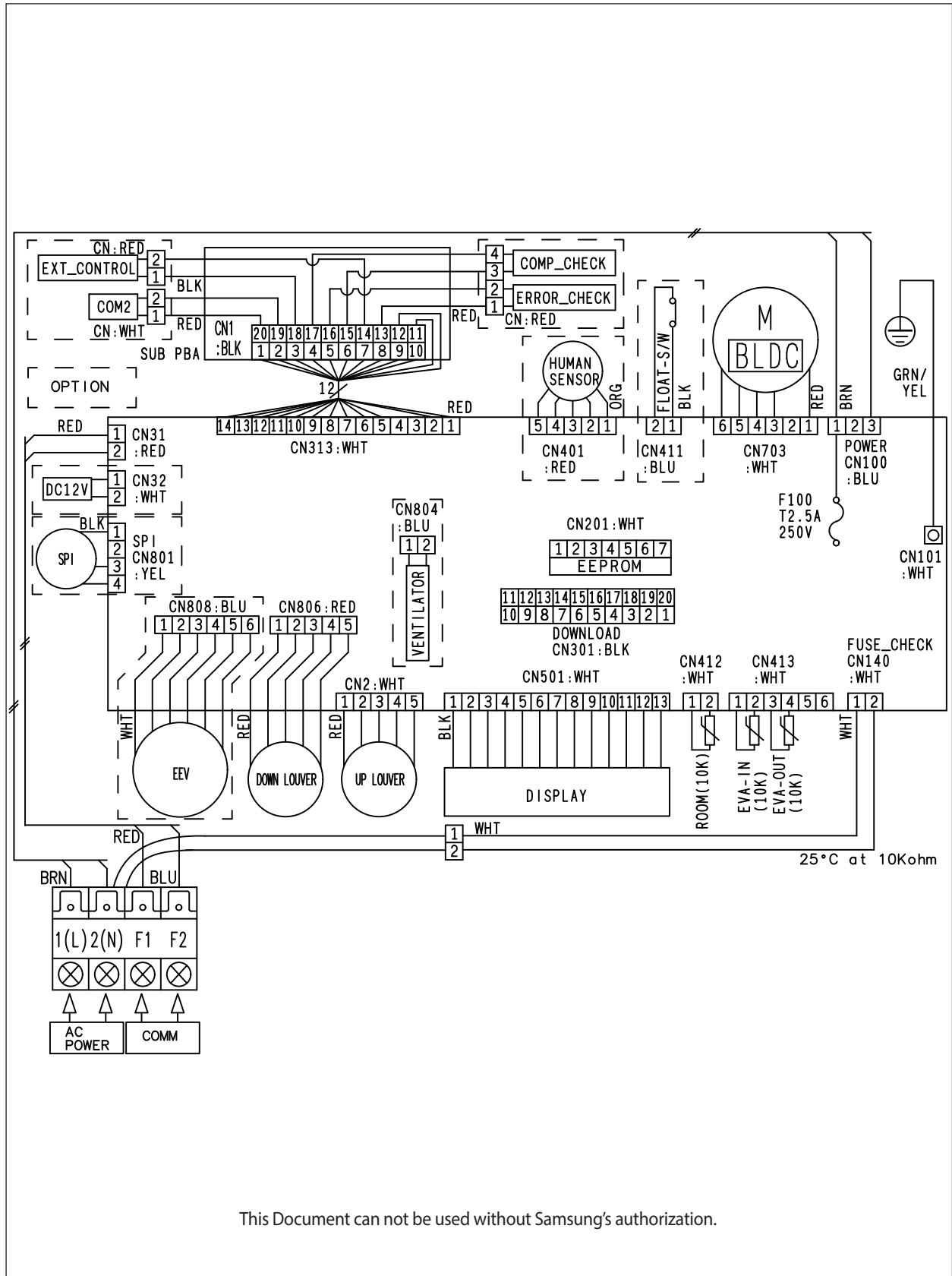

This Document can not be used without Samsung's authorization.

6-1-9 RAC(Neo Forte)

■ AM***FNTDEH*, AM***HNTDEH*, AM***FNQDEH*, AM***HNTDEH*

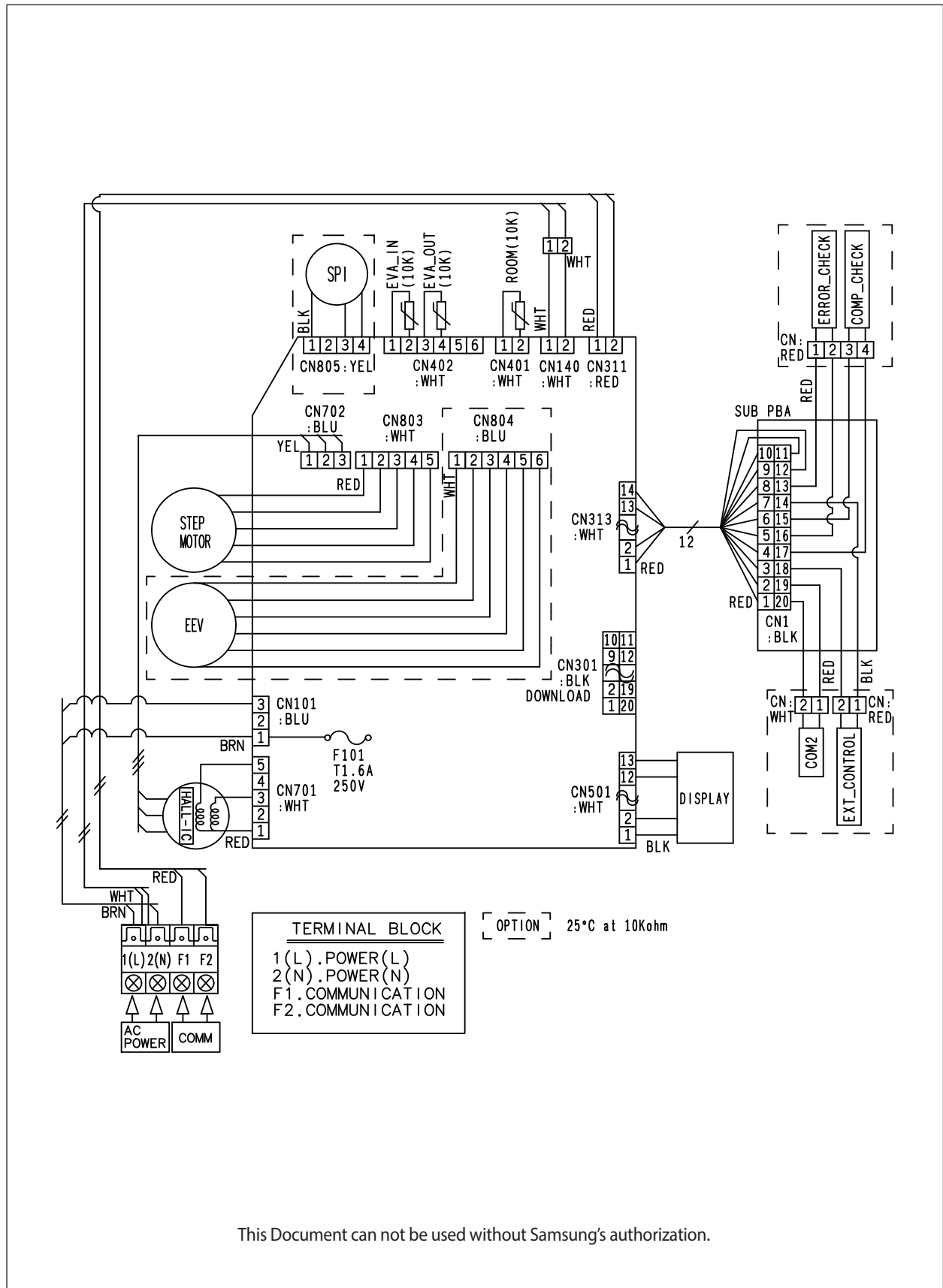

This Document can not be used without Samsung's authorization.

6-1-10 Wall-Mounted type (Boracay)

■ AM***KNQDEH*, AM***KNTDEH*

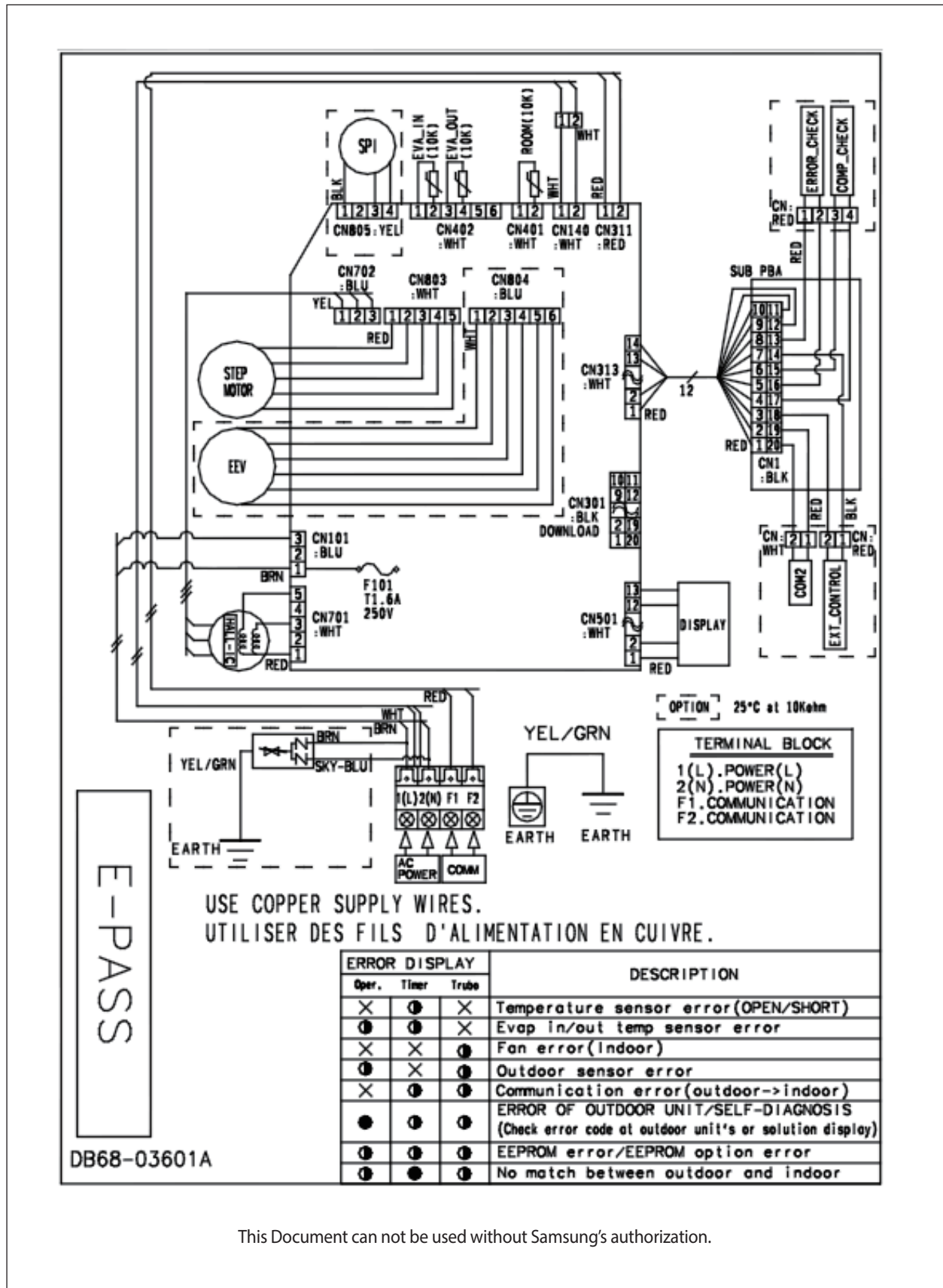

This Document can not be used without Samsung's authorization.

6-1-11 2way cassette type

■ AM***FN2DEH*

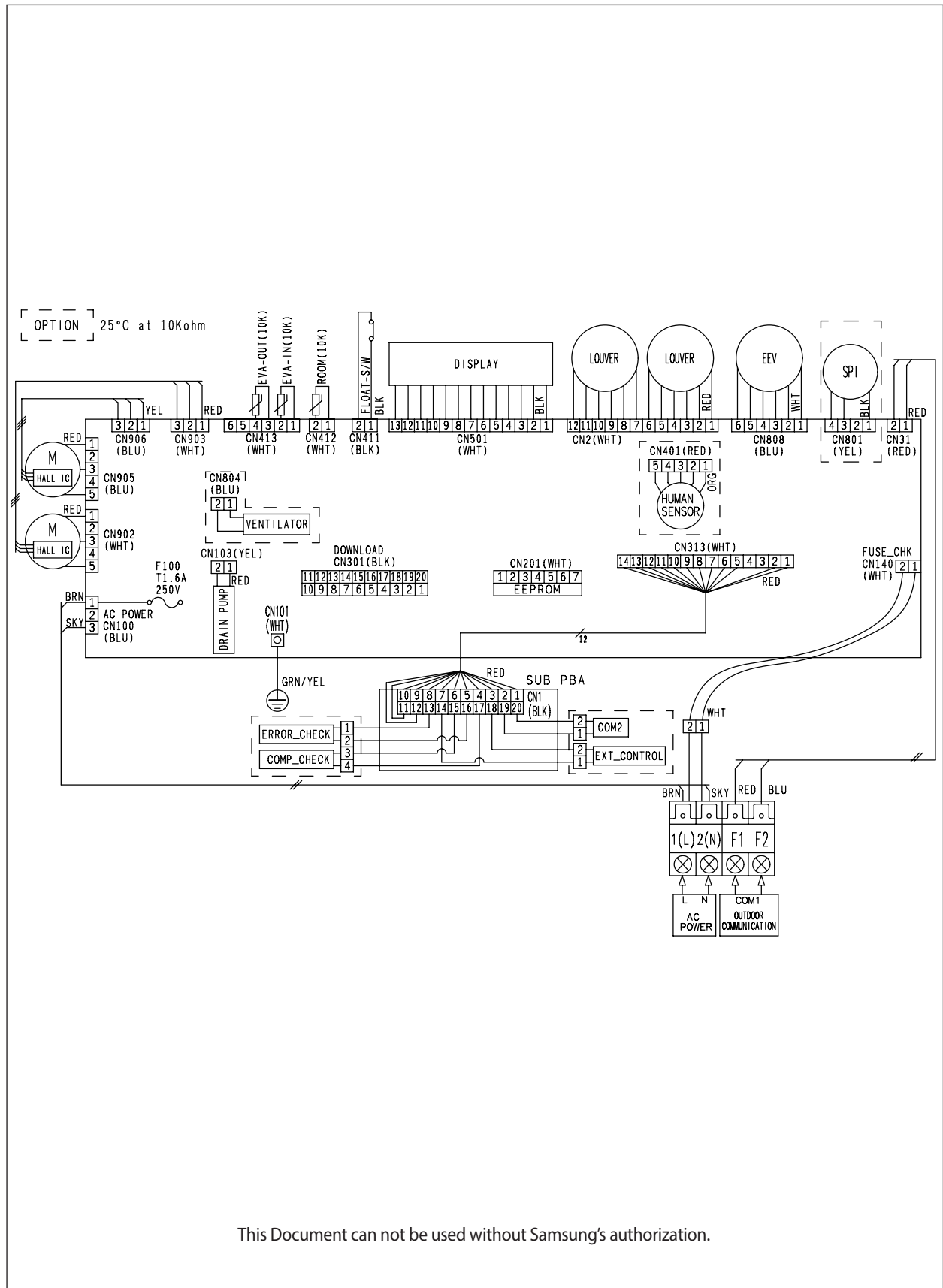

This Document can not be used without Samsung's authorization.

6-1-12 DUCT type (Slim III)

■ AM090/112/128/140FNLDEH*

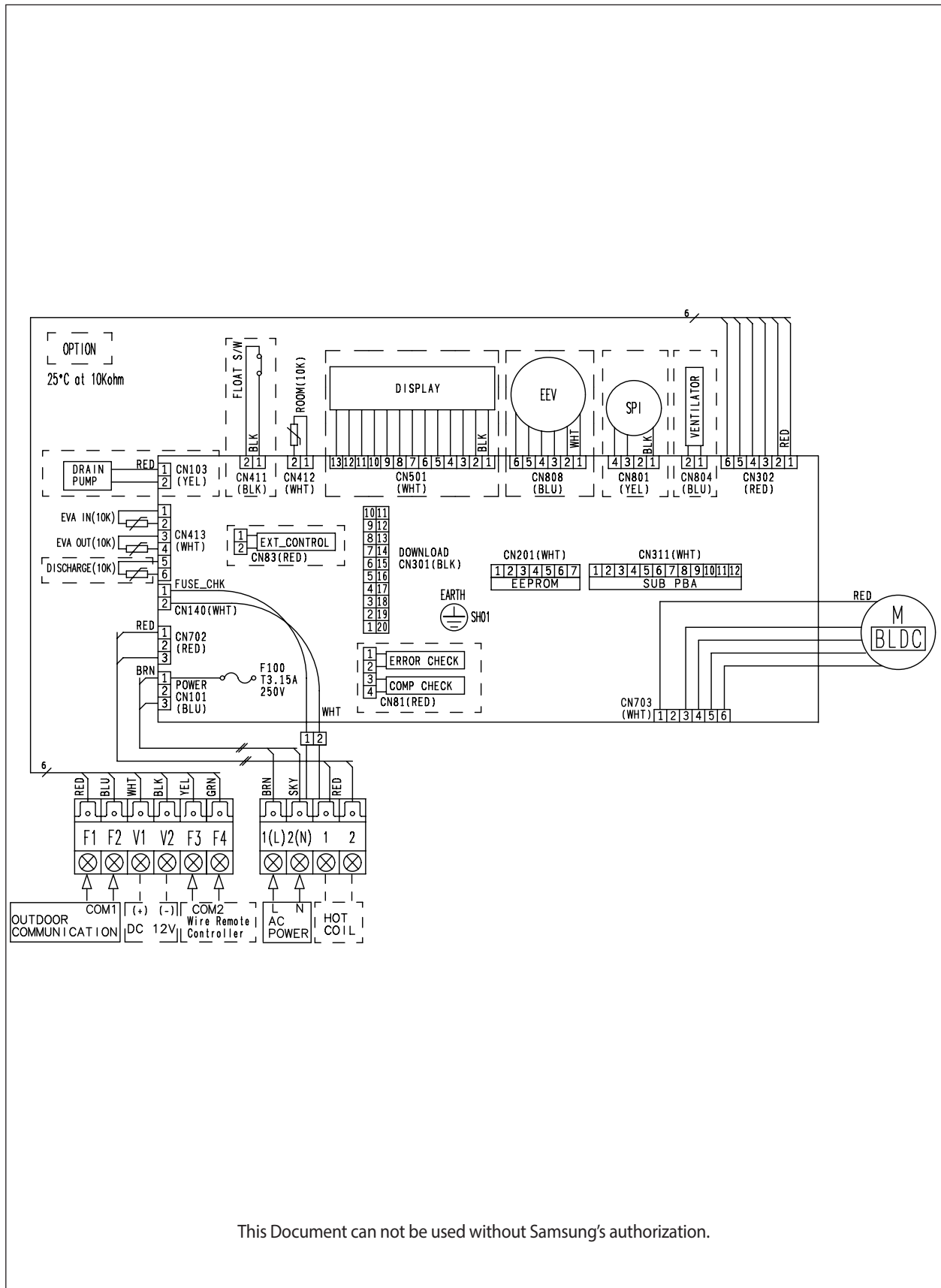

6-1-13 DUCT type (Slim I, II, MSP)

- AM***FNMD*EH*, AM017/022/028/036/045/056/071FNLDEH*
- AE022/028/036/056MNLDEH/EU

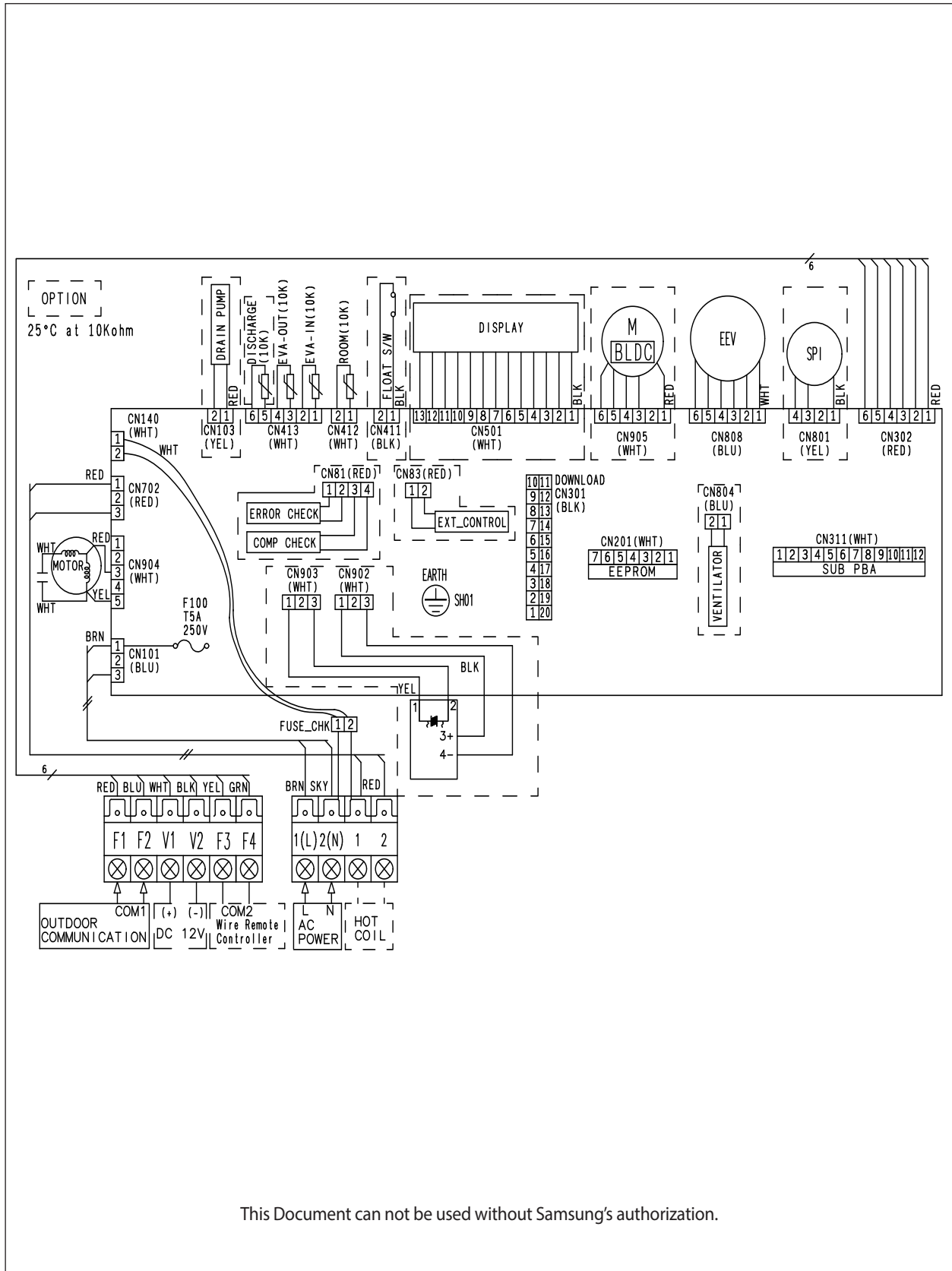

This Document can not be used without Samsung's authorization.

6-1-14 Slim Home Duct

■AM017/022/028/036KNLDEH*

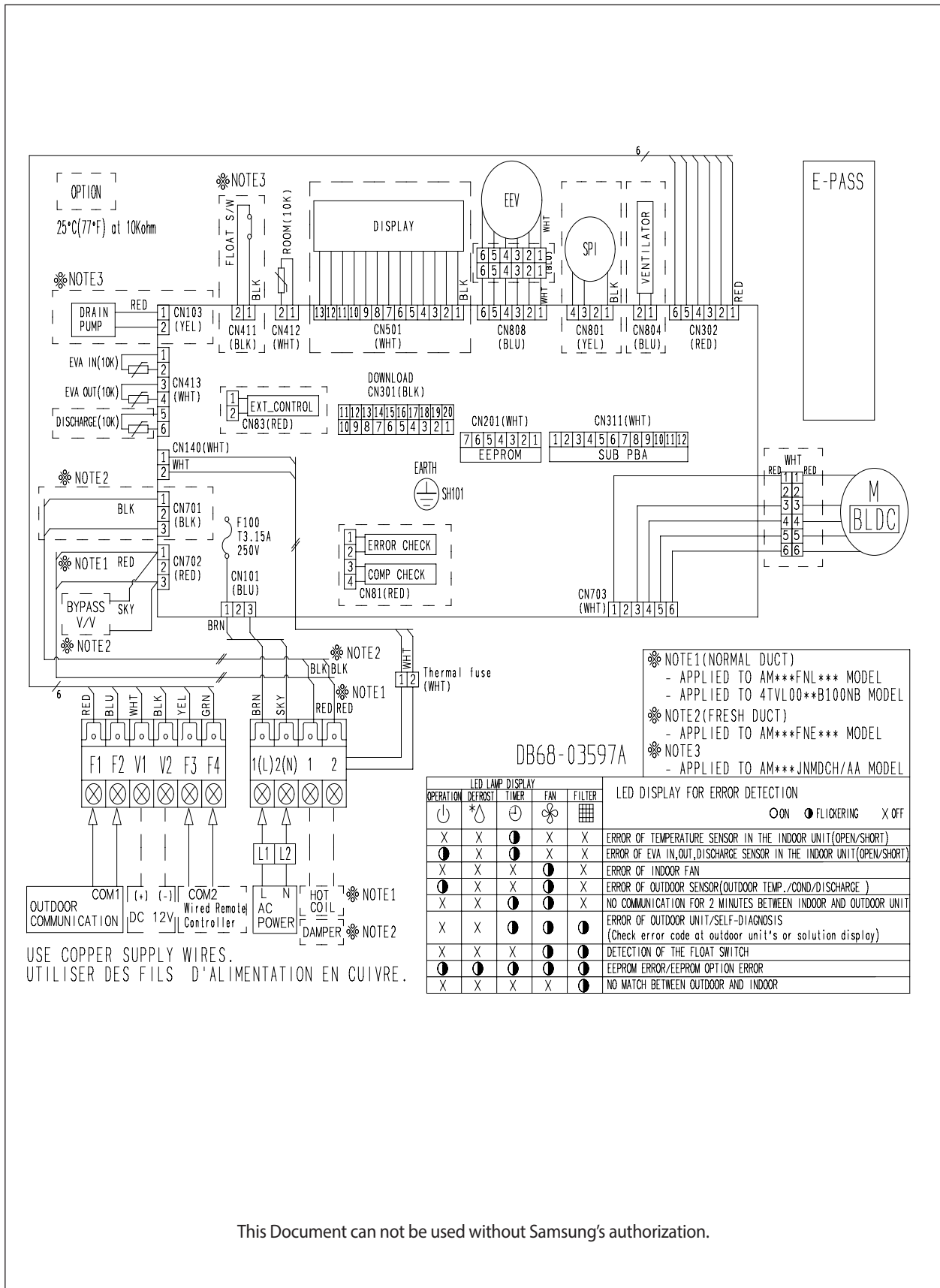

This Document can not be used without Samsung's authorization.

6-1-15 Duct type (HSP)

■ AM112/128/140FNHDEH*

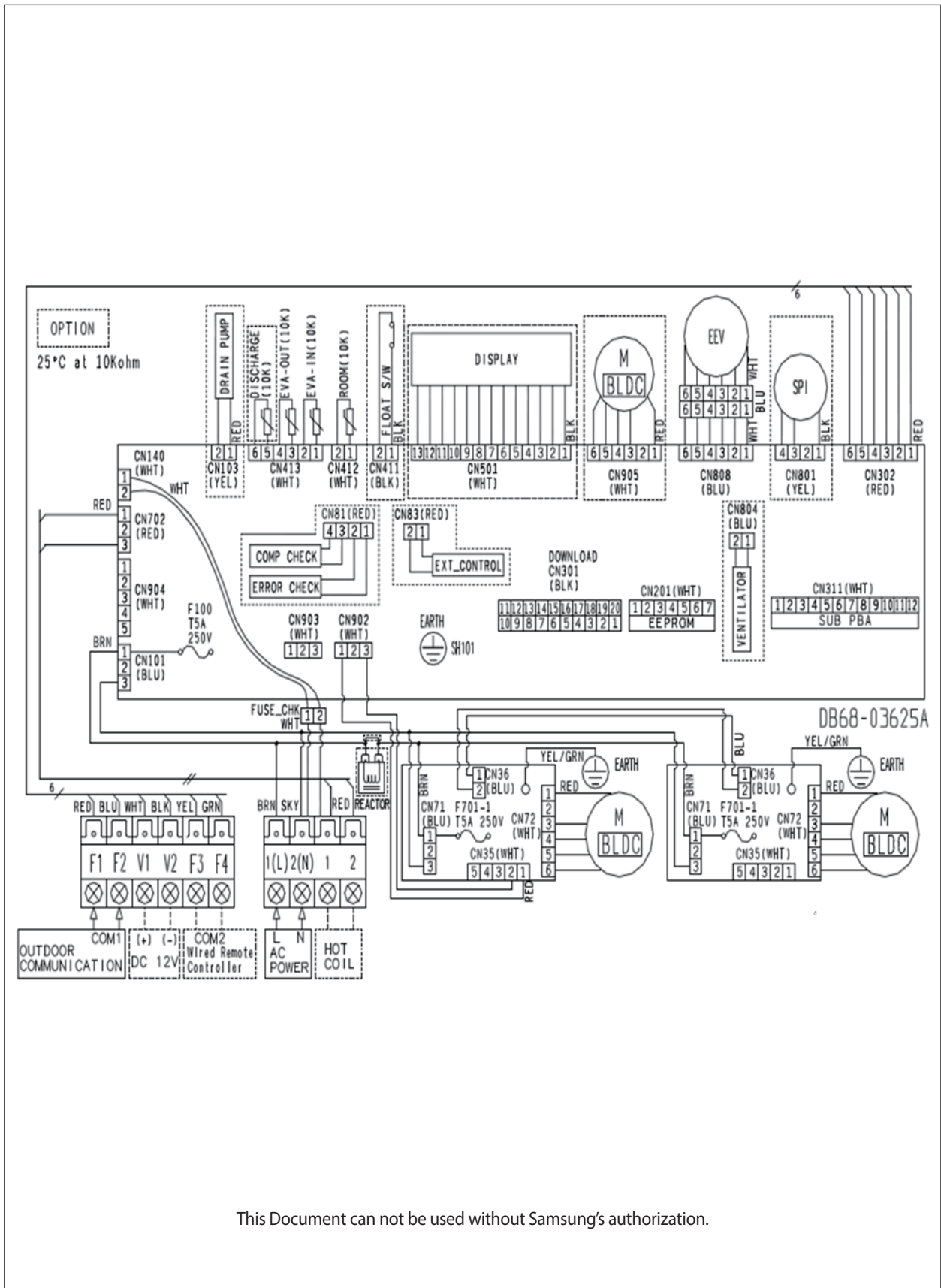

This Document can not be used without Samsung's authorization.

6-1-17 Duct type (Global Duct, HSP)

■ AM***HHPKH*

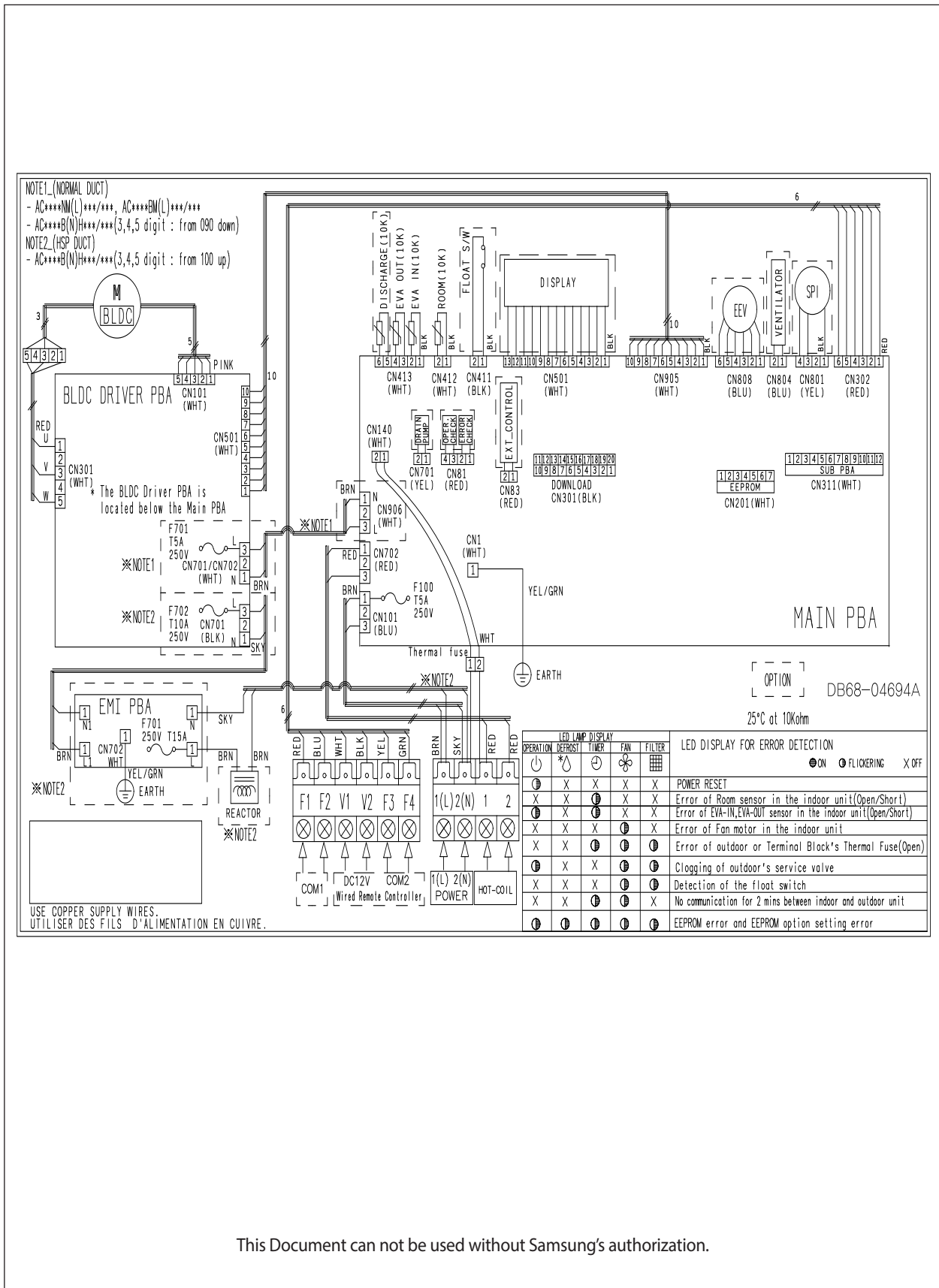

This Document can not be used without Samsung's authorization.

■ AM***MNFDEH*

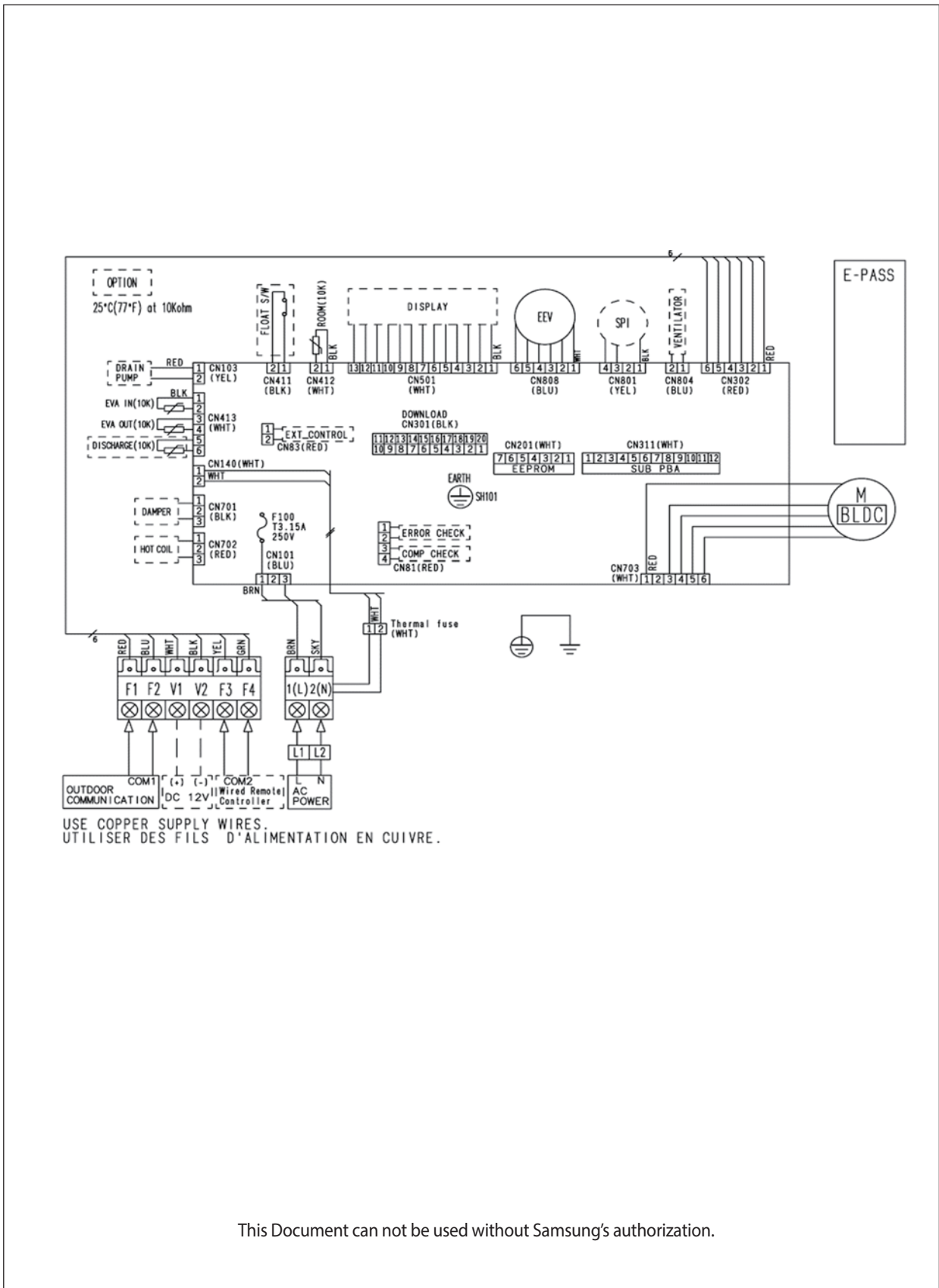

This Document can not be used without Samsung's authorization.

6-1-19 ERV Plus

■ AM***FNKDEH*

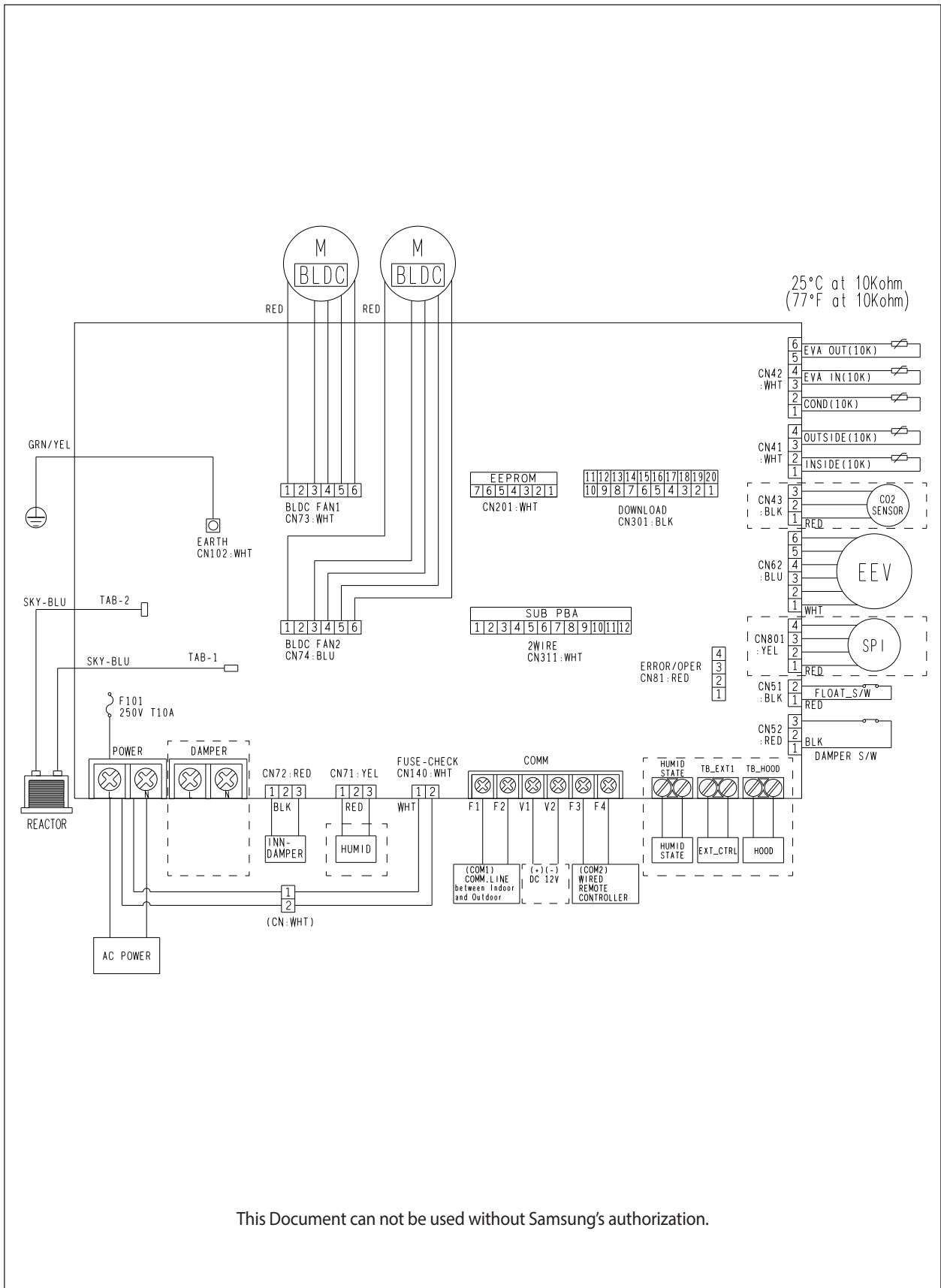

This Document can not be used without Samsung's authorization.

6-1-20 Hydro unit

■ AM160/320/500FNBDH*

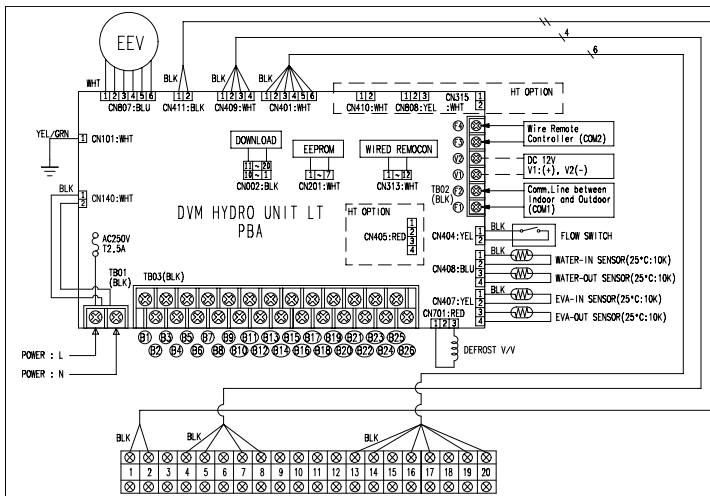

Terminal No.	External contact	Operation status/inspection checklist	Remarks
B1 - B2	OPERATION CHECK	Check on/off status for operation lamp of the control panel on the site	Optional
B3 - B4	ALARM	Check on/off status for alarm lamp of the panel on the site	Optional
B5 - B6	MAIN PUMP	Check the status of the pump operation signal and on/off status of operation at the control panel on the site	Mandatory
B7 - B8	HEATER	Check the status of the heater operation signal output at the control panel on the site	Optional
B9 - B10 - B11	SWAY 1 V/V	Check the status of signal output and on/off status of valve operation (direction switch of the indoor hot water tank)	Optional
B12 - B13 - B14	SWAY 2 V/V	Check the status of signal output and on/off status of valve operation (interlocked with solar energy pump signal)	Optional
B15 - B16 - B17	2WAY V/V	Check the status of signal output or operation status of the valve	Optional
B19 - B20	AC230, THERMOSTAT 1	Check the connection status of the thermostat and operation status of the product (cooling)	Optional
B21 - B22	AC230, THERMOSTAT 2	Check the connection status of the thermostat and operation status of the product (heating)	Optional
B23 - B24	AC24, THERMOSTAT 1	Check the connection status of the thermostat and operation status of the product (cooling)	Optional
B25 - B26	AC24, THERMOSTAT 2	Check the connection status of the thermostat and operation status of the product (heating)	Optional
1 - 2	ROOM TEMP	Check the temperature display on the wired remote controller after appropriately installing the indoor temperature sensor (Refer to option setting of the wired remote controller)	Optional
7 - 8	WATER TANK TEMP	Check the temperature display on the wired remote controller after installing the 4.20mA temperature sensor	Optional (for water supply)
13 - 14	SOLAR PUMP	Check the solar pump contact signal input and status of the operation	Optional
16 - 17	EXT. CONTROL	Check the contact signal input and status of the operation	Optional
19 - 20	SMART GRID	Check the Smart Grid contact input and the signal	Optional

Display	Explanation
E101	Communication error between DVM Hydro unit and outdoor unit (When DVM Hydro unit is having trouble with receiving data from outdoor unit)
E102	Communication error on outdoor unit
E121	Error on room temperature sensor of DVM Hydro unit (Short or Open)
E122	Error on EVA IN sensor of DVM Hydro unit (Short or Open)
E123	Error on EVA OUT sensor of DVM Hydro unit (Short or Open)
E128	EVA IN sensor of DVM Hydro unit is detached
E129	EVA OUT sensor of DVM Hydro unit is detached
E130	EVA IN and EVA OUT sensor of DVM Hydro unit is detached
E151	Error due to opened EEV of DVM Hydro unit (2nd detection)
E152	Error due to closed EEV of DVM Hydro unit (2nd detection)
E161	Mixed operation mode error
E162	EEPROM error
E163	EEPROM option setting error
E177	Check the water circulating
E185	Cross wiring error (When power line is connected to communication line of DVM Hydro unit)
E198	Error due to disconnected Thermal Fuse (When the temperature of terminal block is increases)
E901	Error on the sensor of water inlet pipe (Short or Open)
E902	Error on the sensor of water outlet pipe (Short or Open)
E907	Error due to pipe rupture protection
E908	Error due to freeze prevention
E909	Error due to freeze prevention
E910	Water temperature sensor on water outlet pipe is detached
E911	Error due to turned off Flow switch
E913	(when switch turns off within 10 seconds after pump starts to operate)
E914	Error due to incorrect thermostat connection
E917	Water Tank Sensor Configuration Error

CODE NO : DB68-03522A

This Document can not be used without Samsung's authorization.

6-1-21 Hydro unit HT 3 phase

■ AM160/250FNBFGB*

에러코드 Error No	PBA - 에러 설명 Error Description	원인 Cause	복합 점검 사항 Operation status/operation check list	비고 Remarks
E 110	Control panel error (Control Kit error)	제어판 오작동	제어판 오작동 점검	제어판 오작동
E 121	Room sensor error (Open/Short)	방온 센서 오작동	방온 센서 오작동 점검	방온 센서 오작동
E 122	Low in sensor error (Open/Short)	저온 센서 오작동	저온 센서 오작동 점검	저온 센서 오작동
E 123	Low limit sensor error (Open/Short)	저온 한도 센서 오작동	저온 한도 센서 오작동 점검	저온 한도 센서 오작동
E 198	Thermal fuse cut off error	열융합 차단	열융합 차단 점검	열융합 차단
E 201	Communication error (The connected water of hydro unit)	수위 센서 오작동	수위 센서 오작동 점검	수위 센서 오작동
E 203	Water unit connection error between main room and in. room	수위 센서 오작동	수위 센서 오작동 점검	수위 센서 오작동
E 221	Outside air temperature sensor error (Short/Open)	외기 온도 센서 오작동	외기 온도 센서 오작동 점검	외기 온도 센서 오작동
E 231	Compressor outlet sensor error (Open/Short)	압축기 출구 온도 센서 오작동	압축기 출구 온도 센서 오작동 점검	압축기 출구 온도 센서 오작동
E 251	Compl discharge temperature sensor error (Open/Short)	압축기 배기구 온도 센서 오작동	압축기 배기구 온도 센서 오작동 점검	압축기 배기구 온도 센서 오작동
E 291	Refrigerant leakage or error on high pressure sensor (Short or Open)	냉매 누출 또는 고압 센서 오작동	냉매 누출 또는 고압 센서 오작동 점검	냉매 누출 또는 고압 센서 오작동
E 296	Refrigerant leakage or error on low pressure sensor (Short or Open)	냉매 누출 또는 저압 센서 오작동	냉매 누출 또는 저압 센서 오작동 점검	냉매 누출 또는 저압 센서 오작동
E 308	Suction pressure sensor error (Open/Short)	흡입 압력 센서 오작동	흡입 압력 센서 오작동 점검	흡입 압력 센서 오작동
E 320	High pressure sensor error (Short/Open)	고압 센서 오작동	고압 센서 오작동 점검	고압 센서 오작동
E 407	High pressure error	고압 오작동	고압 오작동 점검	고압 오작동
E 410	Compressor operation stop due to low pressure protection control or refrigerant leakage	저압 보호 또는 냉매 누출	저압 보호 또는 냉매 누출 점검	저압 보호 또는 냉매 누출
E 416	Discharge over temperature error when compressor stop	압축기 정지 후 배기구 온도 상승	압축기 정지 후 배기구 온도 상승 점검	압축기 정지 후 배기구 온도 상승
E 428	Compressor operation stop due to abnormal compression ratio	비정상 압축비	비정상 압축비 점검	비정상 압축비
E 439	Error due to refrigerant leakage	냉매 누출	냉매 누출 점검	냉매 누출
E 440	High pressure error (High pressure sensor error)	고압 오작동	고압 오작동 점검	고압 오작동
E 443	Operation prohibited due to low pressure	저압 보호	저압 보호 점검	저압 보호
E 461	Camp rotation starting error	회전 시작 오작동	회전 시작 오작동 점검	회전 시작 오작동
E 462	High limit current over load error	전류 과부하	전류 과부하 점검	전류 과부하
E 463	High pressure error (High pressure sensor error)	고압 오작동	고압 오작동 점검	고압 오작동
E 464	High pressure error (High pressure sensor error)	고압 오작동	고압 오작동 점검	고압 오작동
E 465	High pressure error	고압 오작동	고압 오작동 점검	고압 오작동
E 466	High pressure error	고압 오작동	고압 오작동 점검	고압 오작동
E 467	High pressure error	고압 오작동	고압 오작동 점검	고압 오작동
E 468	High pressure error	고압 오작동	고압 오작동 점검	고압 오작동
E 469	High pressure error	고압 오작동	고압 오작동 점검	고압 오작동
E 470	High pressure error	고압 오작동	고압 오작동 점검	고압 오작동
E 471	High pressure error	고압 오작동	고압 오작동 점검	고압 오작동
E 472	High pressure error	고압 오작동	고압 오작동 점검	고압 오작동
E 473	High pressure error	고압 오작동	고압 오작동 점검	고압 오작동
E 474	High pressure error	고압 오작동	고압 오작동 점검	고압 오작동
E 484	High pressure error	고압 오작동	고압 오작동 점검	고압 오작동
E 485	High pressure error	고압 오작동	고압 오작동 점검	고압 오작동
E 500	High pressure error	고압 오작동	고압 오작동 점검	고압 오작동
E 901	Water inlet temperature sensor error (Short/Open)	수위 온도 센서 오작동	수위 온도 센서 오작동 점검	수위 온도 센서 오작동
E 902	Water inlet temperature sensor error (Short/Open)	수위 온도 센서 오작동	수위 온도 센서 오작동 점검	수위 온도 센서 오작동
E 904	Water inlet temperature sensor error (Short/Open)	수위 온도 센서 오작동	수위 온도 센서 오작동 점검	수위 온도 센서 오작동
E 907	Water inlet temperature sensor error (Short/Open)	수위 온도 센서 오작동	수위 온도 센서 오작동 점검	수위 온도 센서 오작동

This Document can not be used without Samsung's authorization.

6-1-23 Wall Mounted type(A3050)

- AM***JNVDKH*, AM***JNADKH*
- AE022/028/036/056/071MNADEH/EU

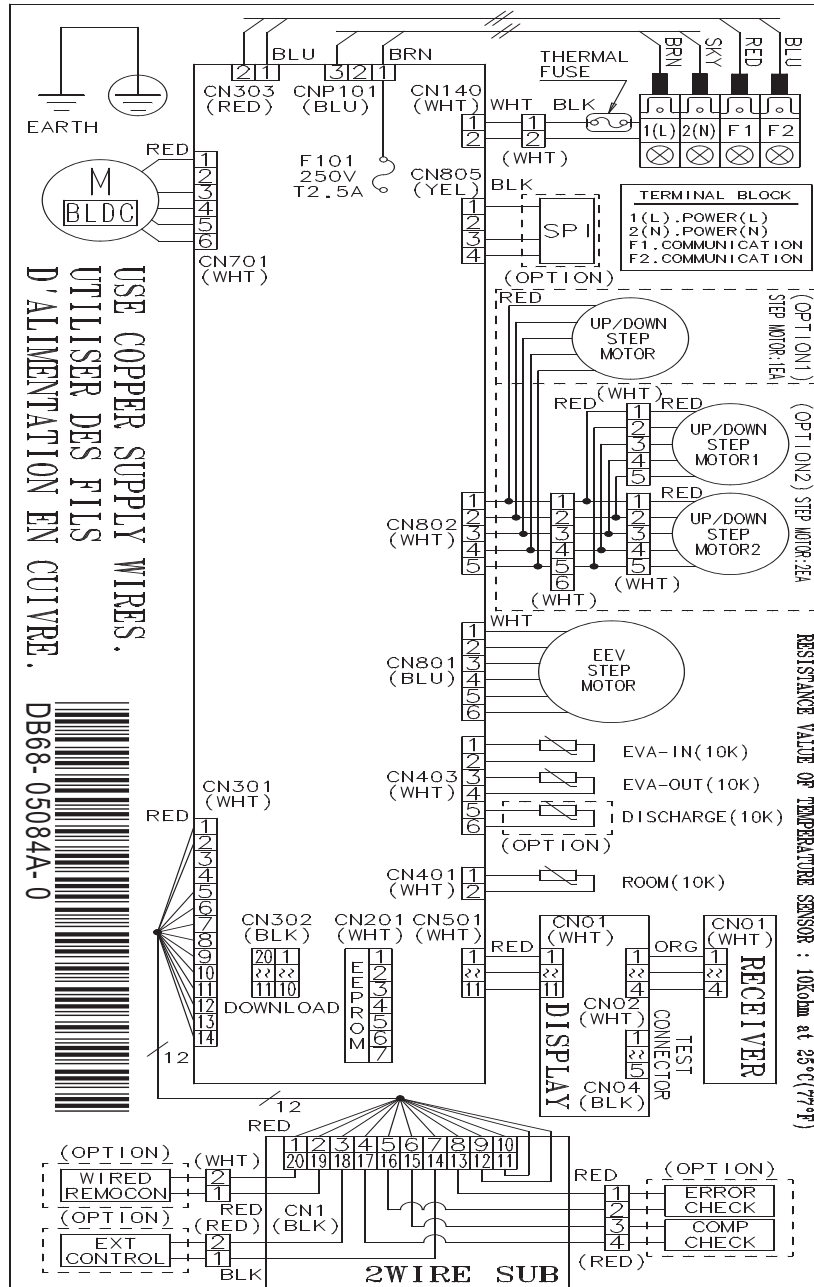

LED LAMP DISPLAY			DESCRIPTION
OPERATION	TIMER	TURBO	
●	●	●	ROOM TEMPERATURE SENSOR ERROR(OPEN/SHORT)
●	●	●	EVA-IN/OUT TEMPERATURE SENSOR ERROR(OPEN/SHORT)
●	●	●	FAN RPM FEEDBACK ERROR(INDOOR UNIT)
●	●	●	TEMPERATURE SENSOR ERROR(OUTDOOR UNIT)
●	●	●	COMMUNICATION ERROR(OUTDOOR UNIT ↔ INDOOR UNIT)
●	●	●	SELF-DIAGNOSIS/ERROR OF OUTDOOR UNIT (CHECK ERROR CODE AT OUTDOOR UNIT'S OR SOLUTION DISPLAY)
●	●	●	EEPROM ERROR/EEPROM OPTION ERROR(INDOOR UNIT)
●	●	●	NO MATCH BETWEEN OUTDOOR UNIT AND INDOOR UNIT

This Document can not be used without Samsung's authorization.

6-1-24 Wall Mounted type(MAX)

■ AM***MNQDEH*

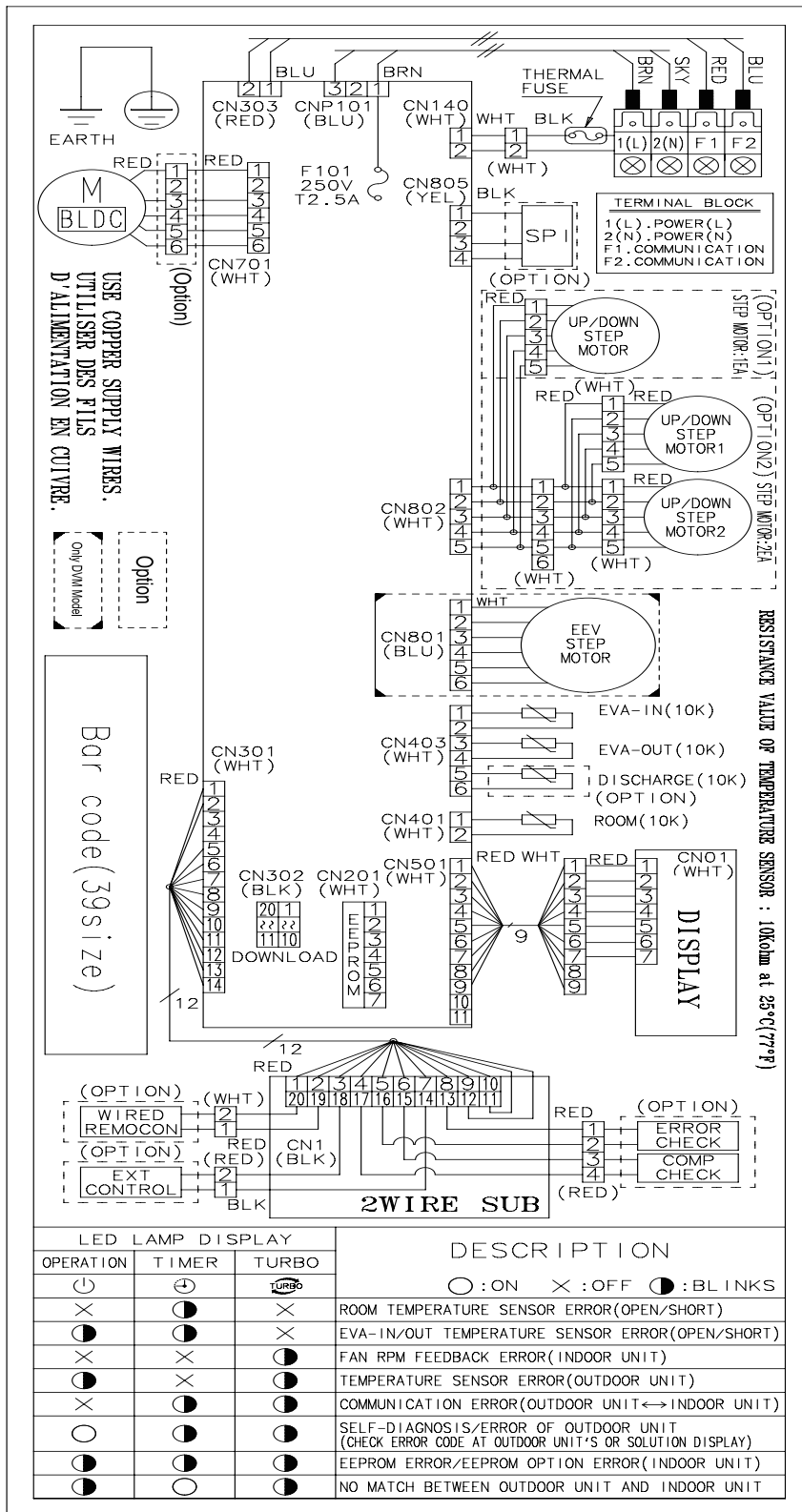

This Document can not be used without Samsung's authorization.

6-1-26 OAP Duct (AM140MNEPEH/EU)

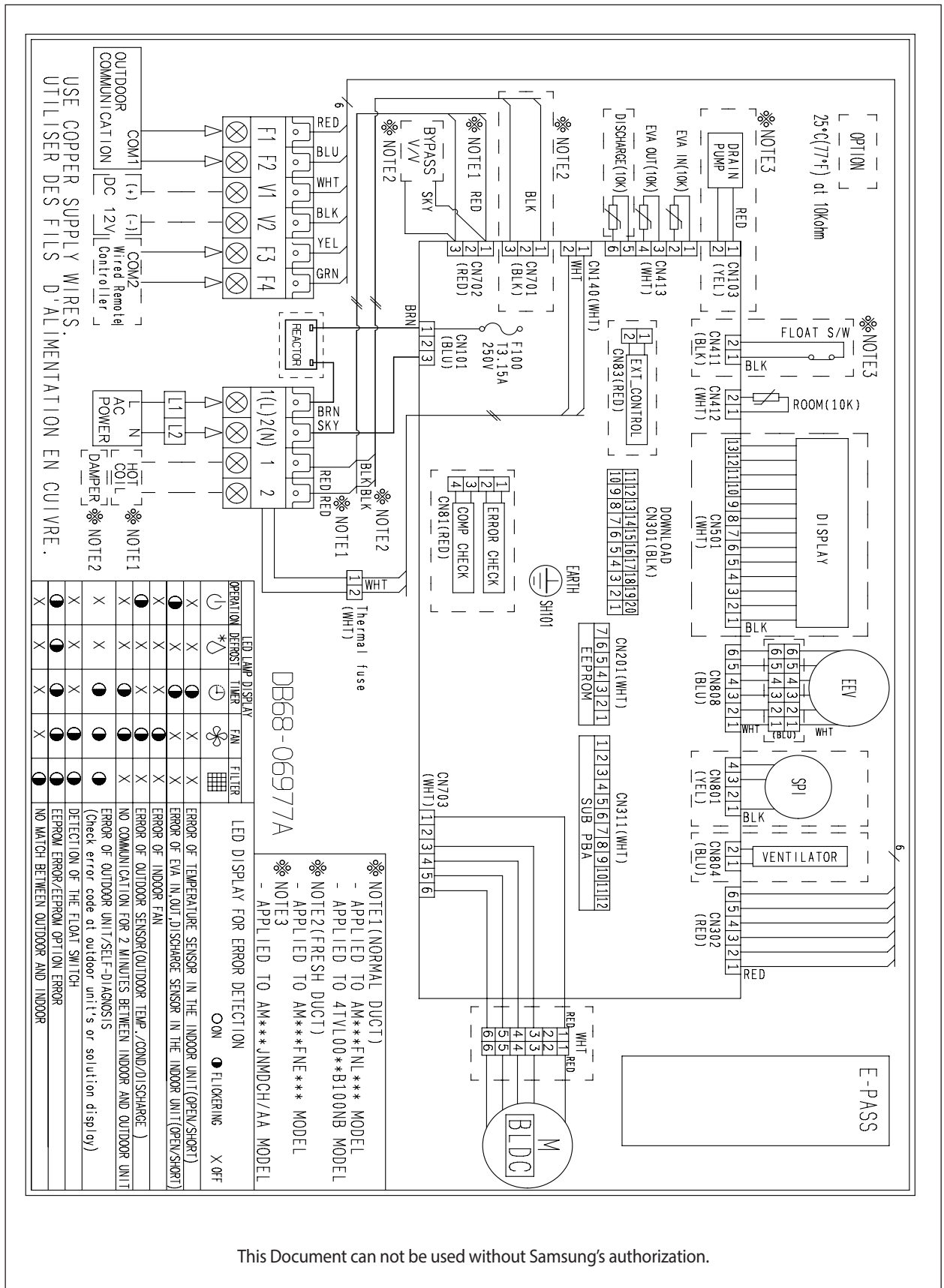

This Document can not be used without Samsung's authorization.

6-1-29 V-AHU

■ AM***JNZDCH*

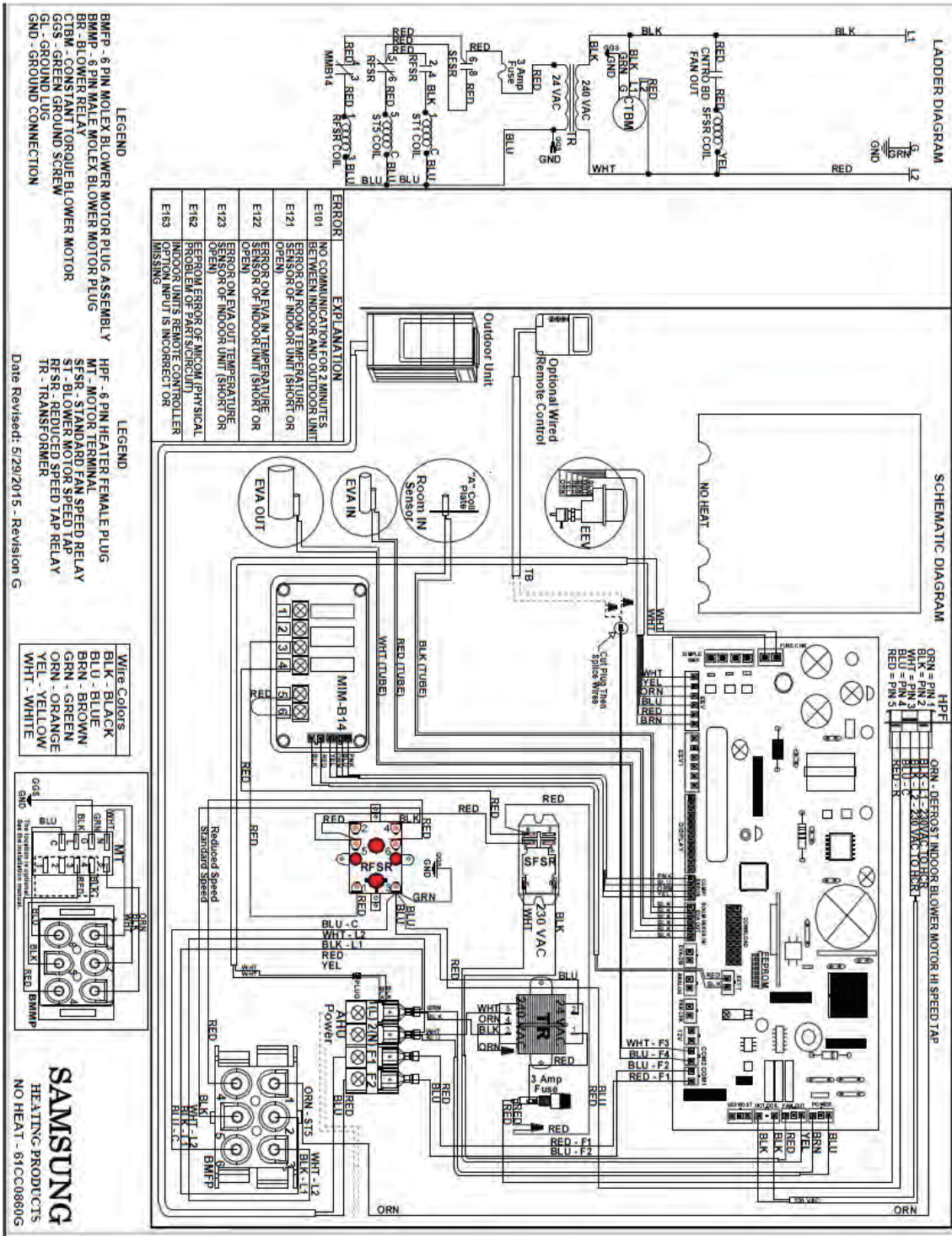

This Document can not be used without Samsung's authorization.

6-1-30 Stand

■ AM280JNPKH/TK

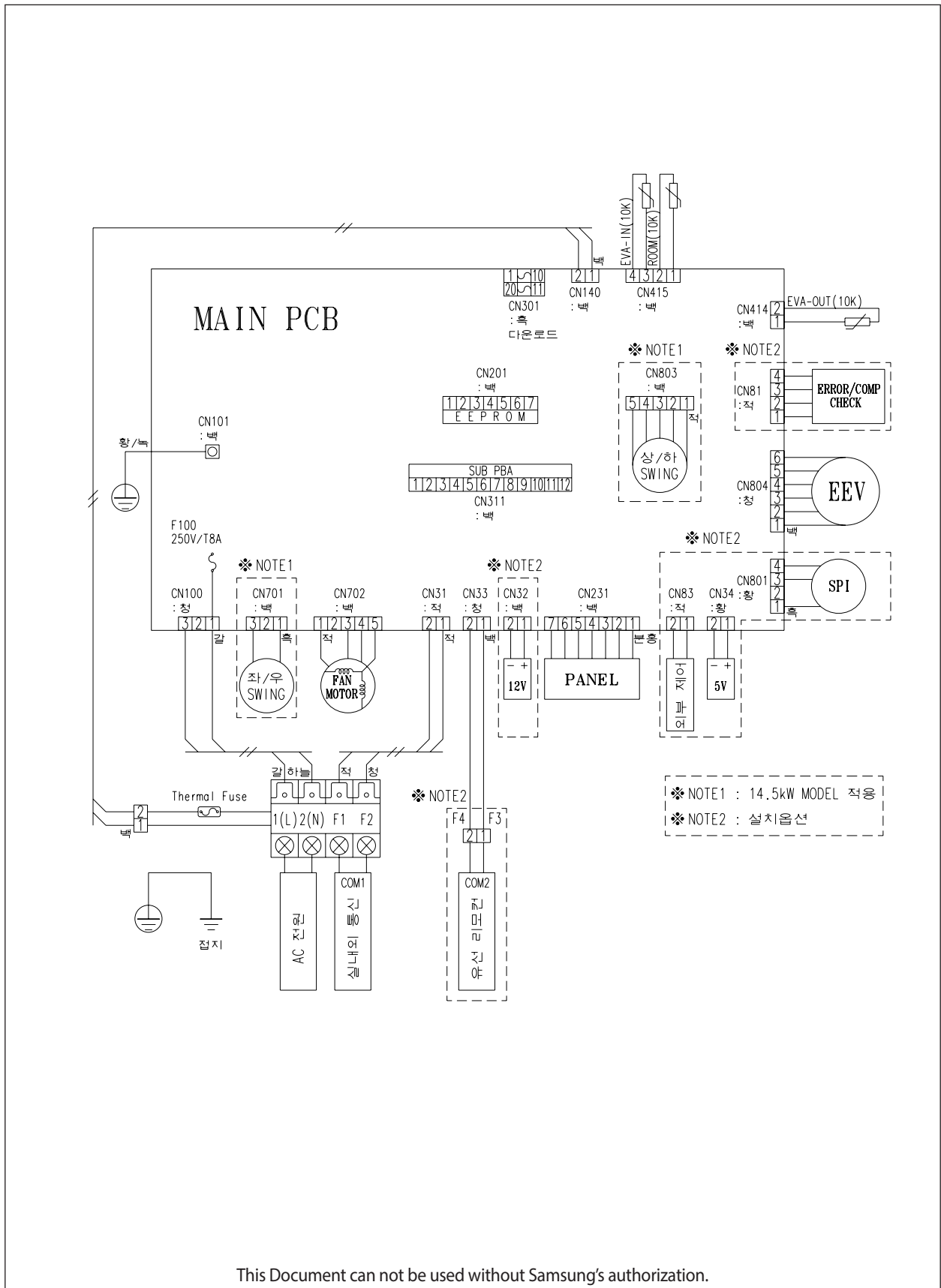

This Document can not be used without Samsung's authorization.

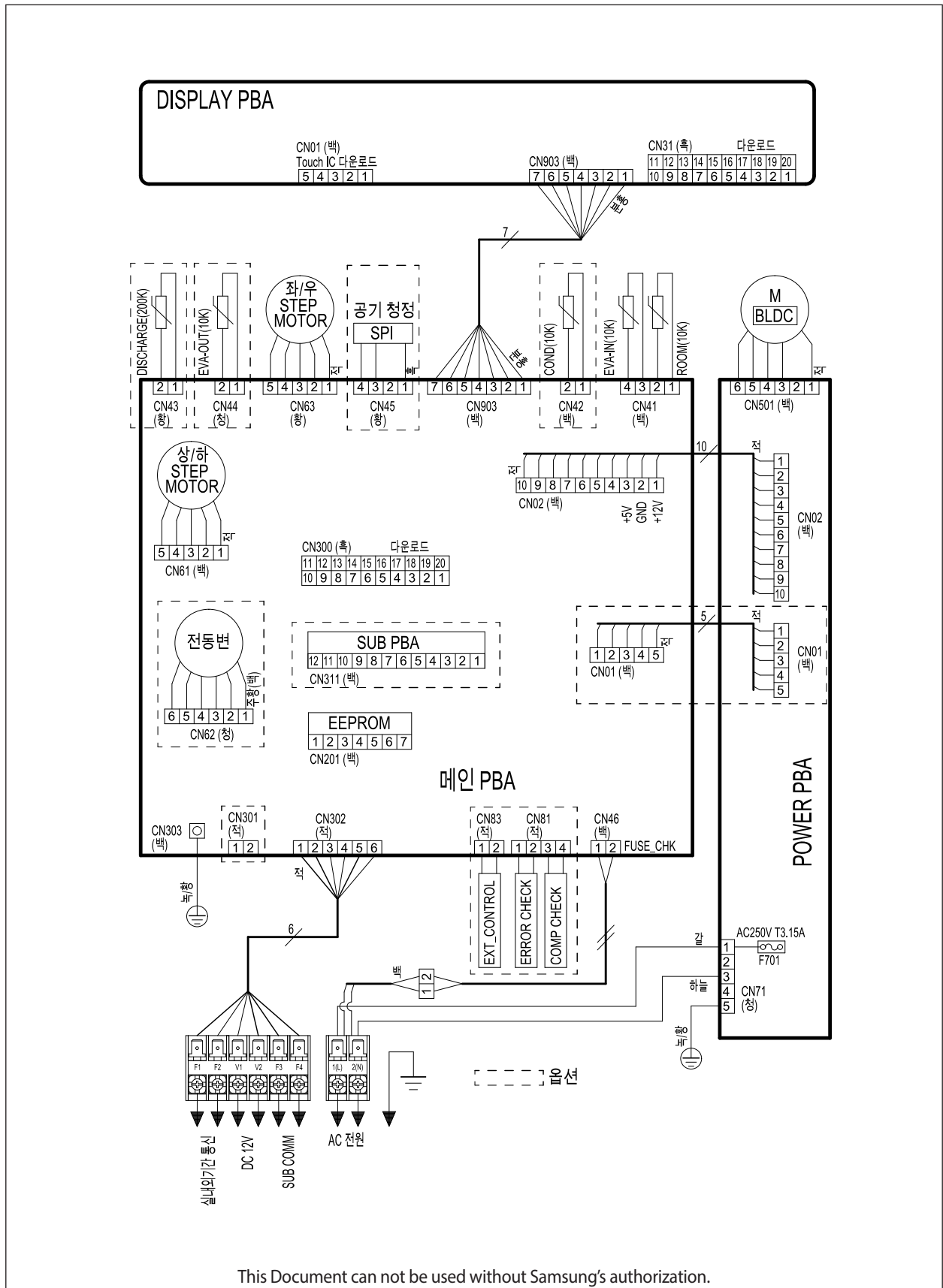

This Document can not be used without Samsung's authorization.

■ AM017/022NN1PEH/EU, AM056/071NN1DEH/EU

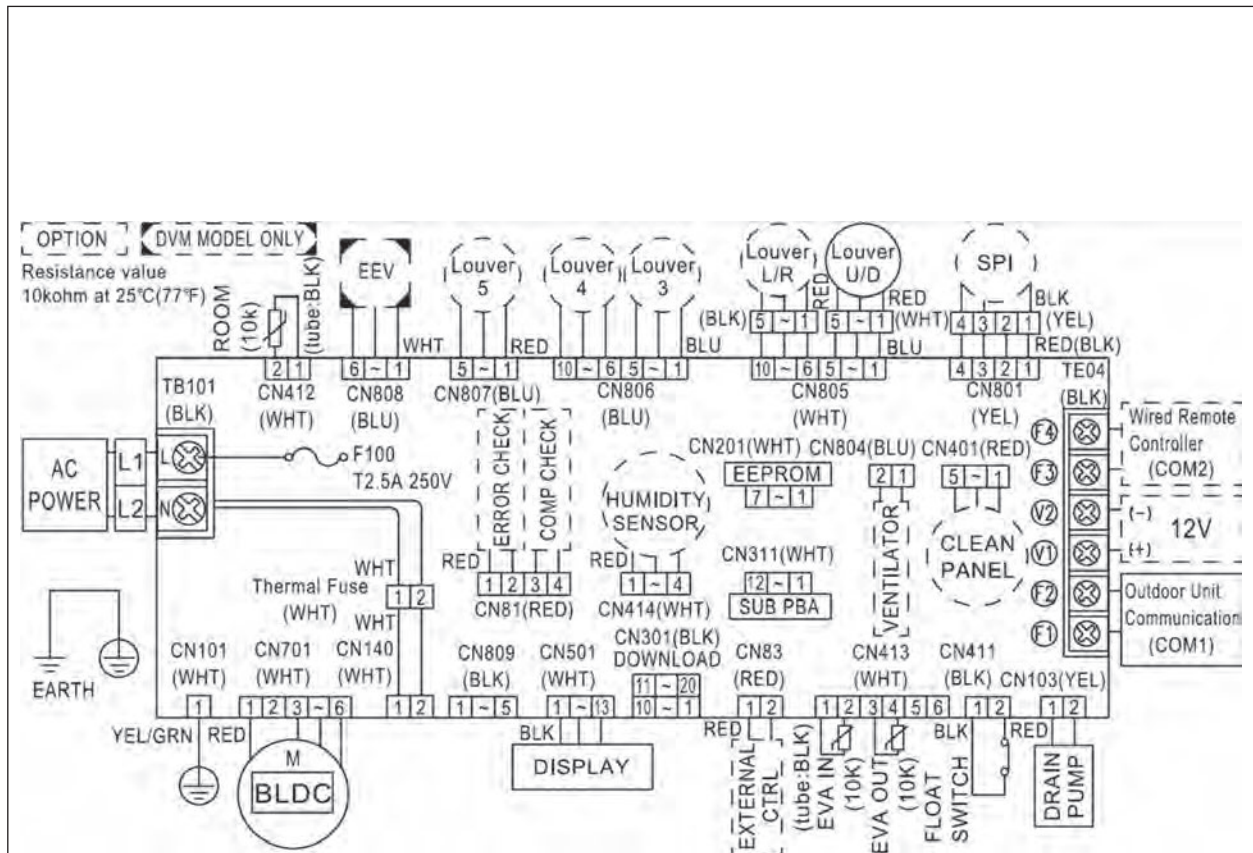

F100	FUSE	EEV	Electronic expansion valve	EVA-IN(10K)	Thermistor EVA IN(10K)
M [BLDC]	Motor (IDU fan)	SPI	S-Plasma ion	EVA-OUT(10K)	Thermistor EVA OUT(10K)
Thermal Fuse	Terminal Block thermal fuse	ROOM(10K)	Thermistor ROOM(10K)		

NOTES

1. This wiring diagram applies only to the indoor unit.
2. Symbols show as follow :
BLK : black, RED : red, BLU : blue, WHT : white, YEL : yellow, BRN : brown, SKY : sky blue, GRN : green
3. For connection wiring indoor-outdoor transmissioin F1-F2, indoor-wired remote controller transmission F3-F4.
4. Protective earth (SCREW).

This Document can not be used without Samsung's authorization.

■ AM022/028/036NN1DEH/EU

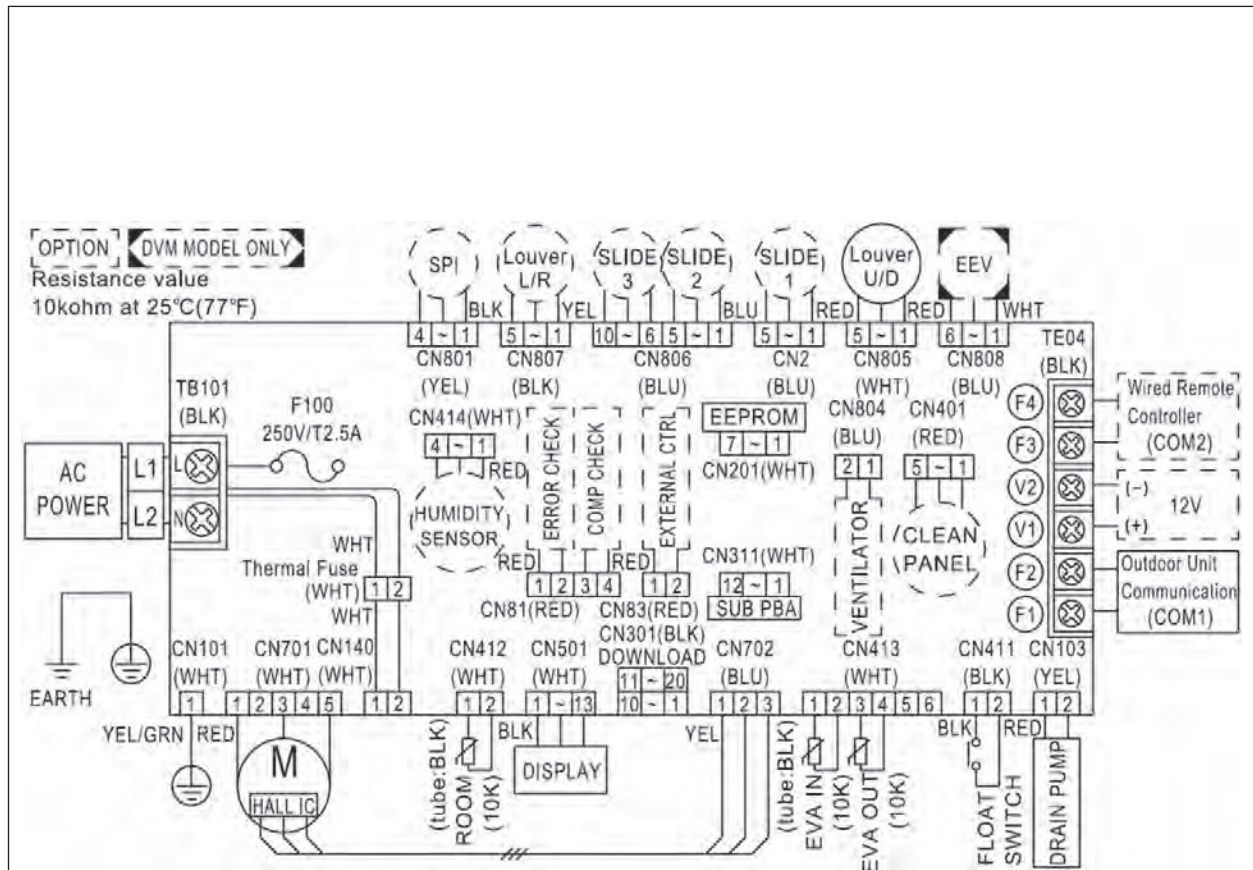

F100	FUSE	EEV	Electronic expansion valve	EVA-IN(10K)	Thermistor EVA IN(10K)
M [HALL IC]	Motor (IDU fan)	SPI	S-Plasma ion	EVA-OUT(10K)	Thermistor EVA OUT(10K)
Thermal Fuse	Terminal Block thermal fuse	ROOM(10K)	Thermistor ROOM(10K)		

NOTES

1. This wiring diagram applies only to the indoor unit.
2. Symbols show as follow :
BLK : black, RED : red, BLU : blue, WHT : white, YEL : yellow, BRN : brown, SKY : sky blue, GRN : green
3. For connection wiring indoor-outdoor transmission F1-F2, indoor-wired remote controller transmission F3-F4.
4. Protective earth (SCREW).

This Document can not be used without Samsung's authorization.

6-1-31 4Way Cassette type(600x600)

■ AM***HNNDEH/TL

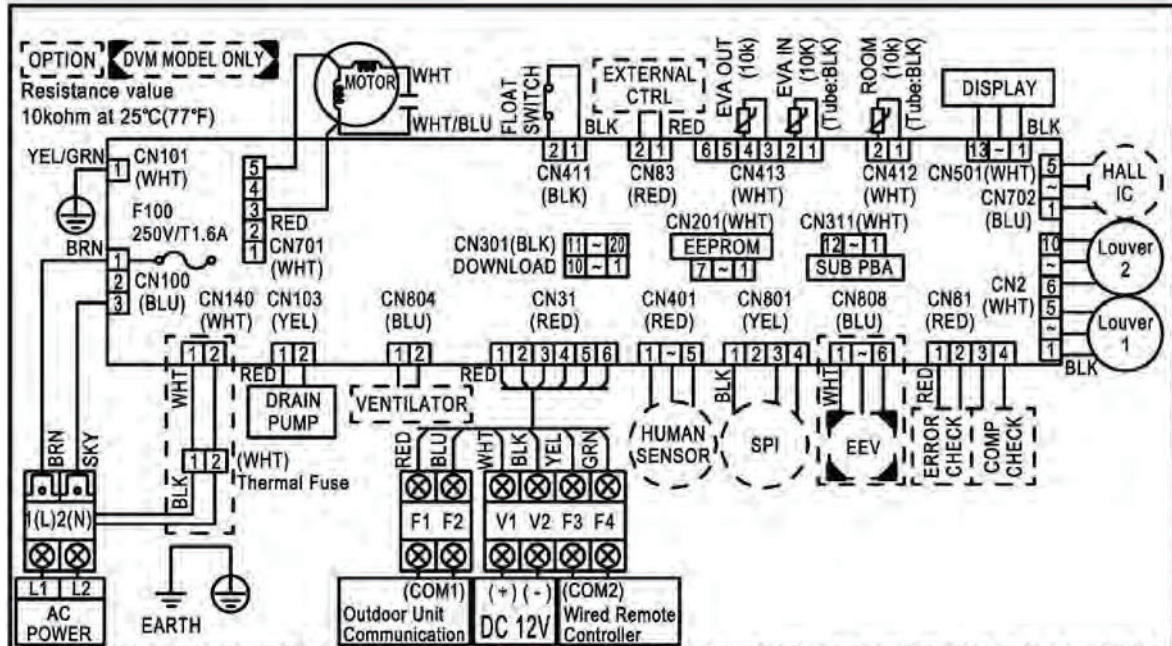

USE COPPER SUPPLY WIRES. UTILISER DES FILS D'ALIMENTATION EN CUIVRE.

LED LAMP DISPLAY					LED DISPLAY FOR ERROR DETECTION
OPERATION	DEFROST	TIMER	FAN	FILTER	
					● ON ○ FLICKERING ✕ OFF
✕	✕	○	✕	✕	Error of room temperature sensor in the indoor unit(open/short)
○	✕	○	✕	✕	Error of eva in,out temperature sensor in the indoor unit(open/short)
✕	✕	✕	○	✕	Error of fan motor in the indoor unit
○	✕	✕	○	✕	Error of outdoor sensor(Outdoor temperature/cond/discharge)
✕	✕	○	○	✕	No communication for 2 minutes between indoor and outdoor unit
✕	✕	○	○	○	Error of outdoor unit/Self-diagnosis (Check error code at outdoor unit's or solution display)
✕	✕	✕	○	○	Detection of the float switch
○	○	○	○	○	EEPROM error/EEPROM option error
✕	✕	✕	✕	○	No match between outdoor and indoor unit

This Document can not be used without Samsung's authorization.

7. Reference Sheet

7-1 Index for Model Name

7-1-1 Indoor Unit

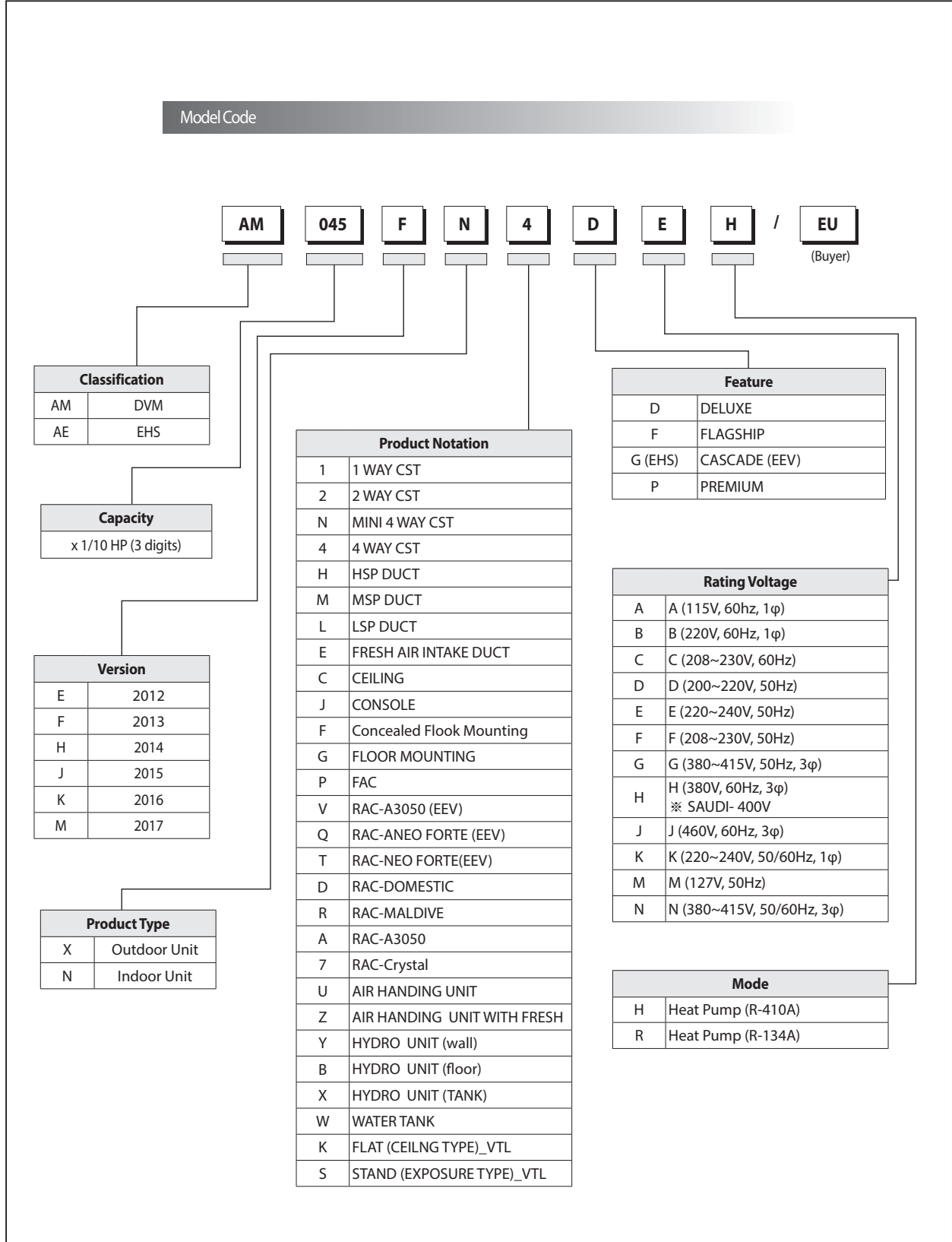

Index for Model Name(cont.)

7-1-2 Panel

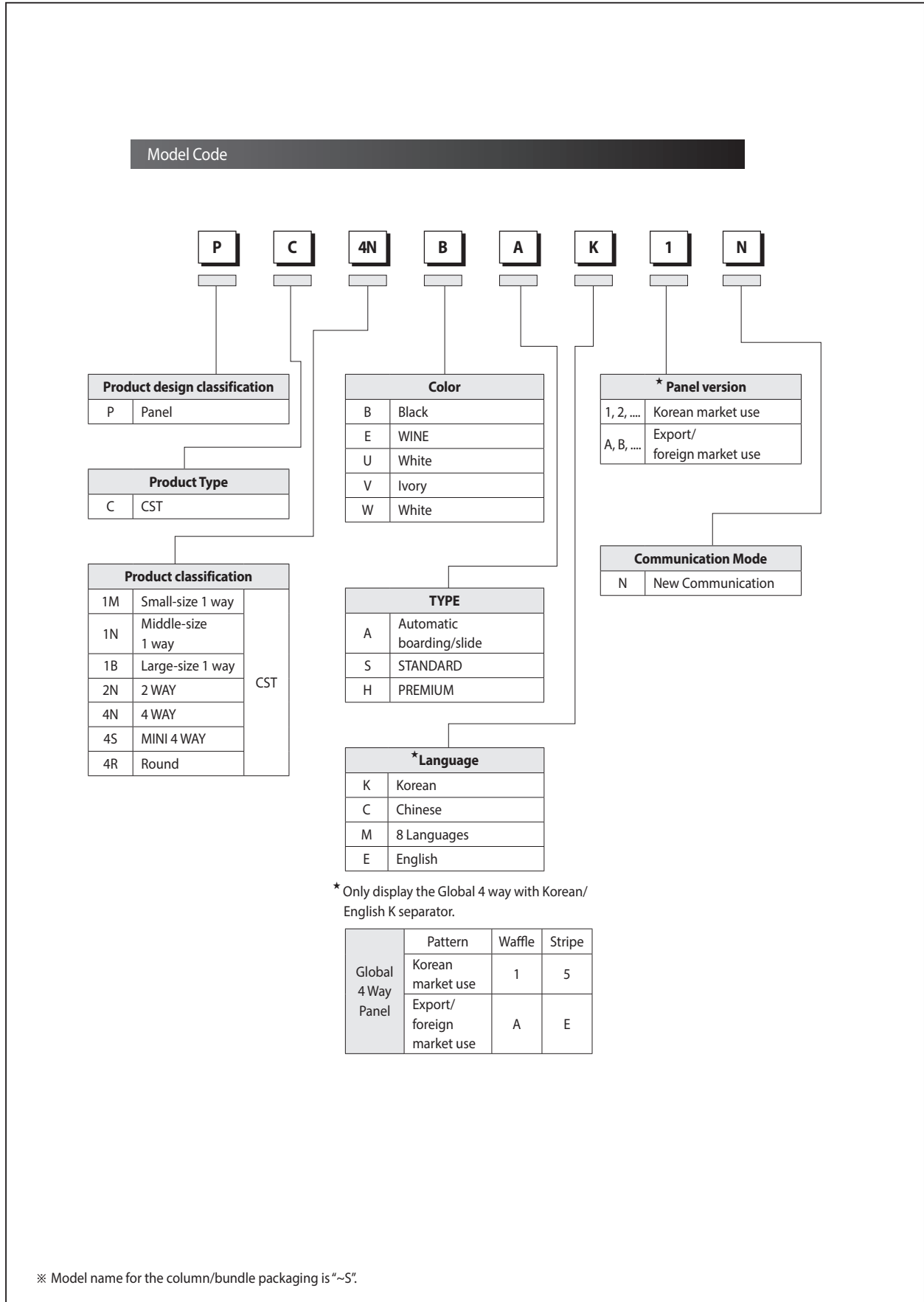

7-2 Pump-down Method

7-2-1 Precautions for Pump-down

1. If the pressure is kept low for a long time to completely replenish the refrigerant of the pipe during the pump-down, then the compressor may be damaged. Therefore, close the valve immediately if the pressure goes below $2\text{kg}/\text{cm}^2\text{g}$.
2. If the length of the pipe is too long or the outside temperature is too high, then it may not be able to pump down all of the refrigerant. In this case, use an empty refrigerant container which can be used for recharge to place some of the system refrigerant inside the container. The pump down can be easily carried out if only the remaining refrigerant is pumped down.



- Please use a rechargeable container for exclusive use when putting the refrigerant in the container. Accidents such as explosions can happen and result in damage if normal refrigerant containers are used after illegal modification.

7-2-2 For Single Installation of Outdoor Unit (Only One Outdoor Unit Installed)

1. Close the liquid pipe SVC valve.
2. Press the K2 Button on the PCB of the main outdoor unit. ("K7" mark displayed on the outdoor unit PCB LED.)
3. Observe for low pressure by using the K4 button's view mode once the compressor starts operating.
(If the first number of the LED is "4," then the following three digits represent the low pressure, expressed up to the first decimal point.)
Example: 41 22 → 4 means the value of the low pressure, and 122 means that the low pressure is $12.2\text{kg}/\text{cm}^2\text{g}$.
4. If the low pressure goes below around $2\text{kg}/\text{cm}^2\text{g}$, then immediately close the SVC valve for the gas and finish the pump-down operation.
(Finish the pump-down operation, press K2 button two more times, or reset the operation by pressing the K3 button once more.)

7-2-3 When Two or More Outdoor Units are Installed

1. Close the gas valves of each sub unit.
2. Press the K2 button of the outdoor unit PCB three times. At this time, K7 will be displayed on the PCB LED. After pressing the button, wait for about 20~30 minutes once the main unit compressor starts operating.
3. Close the liquid pipe valves of each sub unit.
4. Close the liquid pipe valves of the main unit, and observe for low pressure as in the case of a single outdoor unit.
5. Close the gas valve of the main unit if the pressure drops down, and then finish the pump-down operation mode.

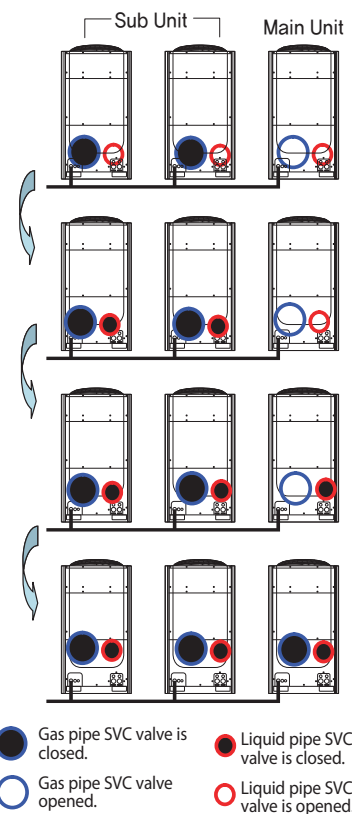

7-3 How to Put Refrigerant in Refrigerant Container

7-3-1 How to put refrigerant in container before pump-down

1. Prepare a rechargeable exclusive refrigerant container, a scale, and a Manifold gauge.
2. Check the amount of refrigerant remaining in the overall system at the time.
3. Connect the refrigerant container to the outdoor unit as shown in the following figure, and operate only about 50% of the total indoor units in air conditioning mode.
4. Check the high pressure from the Manifold gauge 10 minutes after the air conditioning begins operation.
Reduce the number of indoor units in operation if the high pressure goes above $30\text{kg}/\text{cm}^2\text{g}$. to lower the high pressure below $30\text{kg}/\text{cm}^2\text{g}$.
5. Check that the high pressure goes below $30\text{kg}/\text{cm}^2\text{g}$, and open the Manifold gauge connected to the liquid pipe, as well as the refrigerant container valve, so that the refrigerant flows from the liquid pipe to the refrigerant container.
6. Check the changes in the weight of the container using the scale. Once the desired amount of refrigerant is filled up inside the container, close the valves, and then remove the Manifold gauge.
7. The amount of refrigerant that can be contained inside the container is about 50% of the amount of refrigerant inside the overall system.
8. Please take extra caution by precisely determining the amount of the refrigerant that can be put in each container so that too much refrigerant is not contained in the container.
The weight must be measured by using a scale to avoid putting more refrigerant than the amount originally contained in the container.

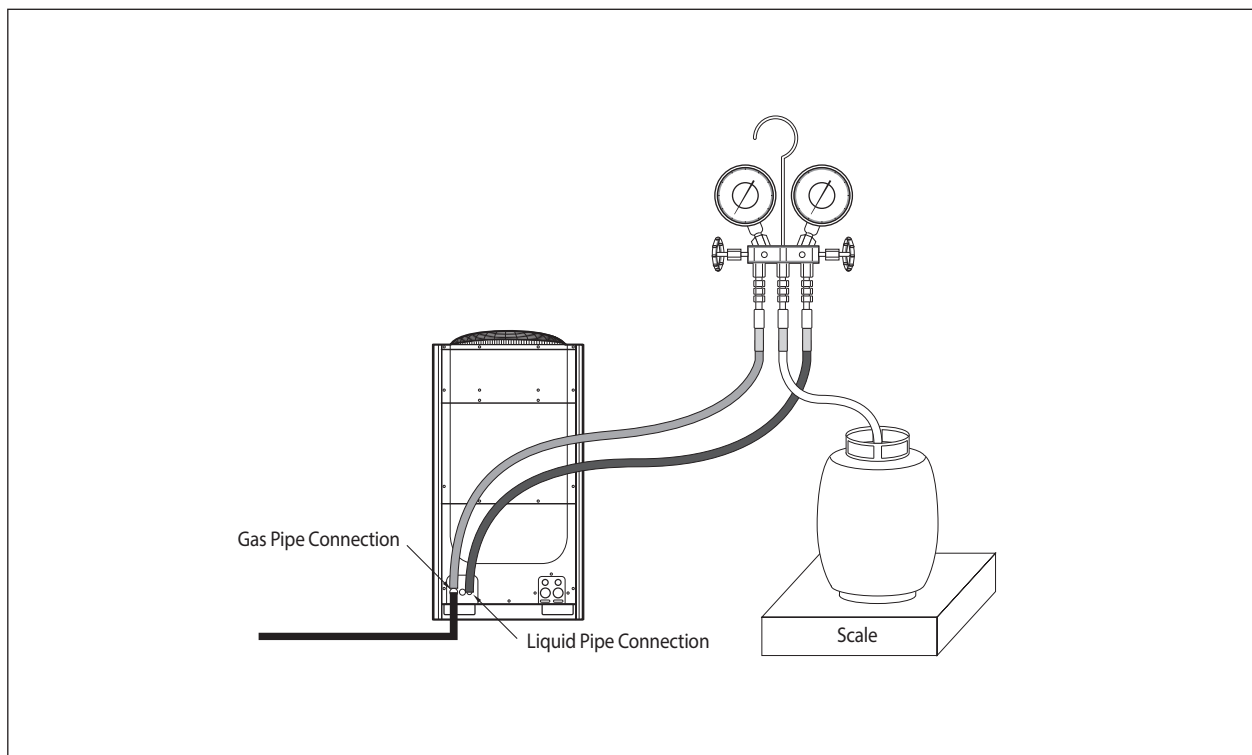

SAMSUNG

This Service Manual is a property of Samsung Electronics Co., Ltd.
Any unauthorized use of Manual can be punished under applicable
International and/or domestic law.

© Samsung Electronics Co., Ltd. September. 2018.
Printed in Korea.
Code No. AC-00005E_13