



# Air Conditioner user manual

imagine the possibilities

Thank you for purchasing this Samsung product.



DB68-05683A-02

**SAMSUNG**

# Contents

---

## Preparation

Features of your new air conditioner .....	2
Safety precautions .....	3
Checking before use .....	14

## Basic function

Name of the parts .....	16
Basic operation .....	18

## Others

Cleaning and maintenance .....	21
Troubleshooting .....	23
Product specification .....	27



### ***Correct Disposal of This Product (Waste Electrical & Electronic Equipment)***

#### ***(Applicable in countries with separate collection systems)***

This marking on the product, accessories or literature indicates that the product and its electronic accessories (e.g. charger, headset, USB cable) should not be disposed of with other household waste at the end of their working life. To prevent possible harm to the environment or human health from uncontrolled waste disposal, please separate these items from other types of waste and recycle them responsibly to promote the sustainable reuse of material resources. Household users should contact either the retailer where they purchased this product, or their local government office, for details of where and how they can take these items for environmentally safe recycling. Business users should contact their supplier and check the terms and conditions of the purchase contract. This product and its electronic accessories should not be mixed with other commercial wastes for disposal.







## Safety precautions

Before using your new air conditioner, please read this manual thoroughly to ensure that you know how to safely and efficiently operate the extensive features and functions of your new appliance.

Because the following operating instructions cover various models, the characteristics of your air conditioner may differ slightly from those described in this manual. If you have any questions, call your nearest contact center or find help and information online at [www.samsung.com](http://www.samsung.com).

These warning signs are here to prevent injury to you and others. Please follow them carefully.

### Important safety symbols and precautions :

 <b>WARNING</b>	Hazards or unsafe practices that may result in <b>severe personal injury or death.</b>
 <b>CAUTION</b>	Hazards or unsafe practices that may result in <b>minor personal injury or property damage.</b>
	Follow directions.
	Do NOT attempt.
	Make sure the machine is grounded to prevent electric shock.
	Cut-off the power supply.
	Do NOT disassemble.

# Safety precautions

---

FOR INSTALLATION



WARNING

---

**!** Use the power line with the power specifications of the product or higher and use the power line for this appliance only. In addition, do not use an extension line.

- ▶ Extending the power line may result in electric shock or fire.
- ▶ Do not use an electric transformer. It may result in electric shock or fire.
- ▶ If the voltage/frequency/rated current condition is different, it may cause fire.

**The installation of this appliance must be performed by a qualified technician or service company.**

- ▶ Failing to do so may result in electric shock, fire, explosion, problems with the product, or injury and may also void warranty on the installed product.

**Install a switch and circuit breaker dedicated to the air conditioner.**

- ▶ Failing to do so may result in electric shock or fire.

**Fix the outdoor unit firmly so that the electric part of the outdoor unit is not exposed.**

- ▶ Failing to do so may result in electric shock, fire, explosion, problems with the product.



- ⊘ **Do not install this appliance near a heater, inflammable material. Do not install this appliance in a humid, oily or dusty location, in a location exposed to direct sunlight and water (rain drops). Do not install this appliance in a location where gas may leak.**

- ▶ This may result in electric shock or fire.

**Never install the outdoor unit in a location such as on a high external wall where it could fall.**

- ▶ If the outdoor unit falls, it may result in injury, death or property damage.

- ⚡ **This appliance must be properly grounded. Do not ground the appliance to a gas pipe, plastic water pipe, or telephone line.**

- ▶ Failure to do so may result in electric shock, fire, an explosion, or other problems with the product.

- ▶ Never plug the power cord into a socket that is not grounded correctly and make sure that it is in accordance with local and national codes.

# Safety precautions

---

## FOR INSTALLATION



## CAUTION

---

- ❗ **Install your appliance on a level and hard floor that can support its weight.**
  - ▶ Failing to do so may result in abnormal vibrations, noise, or problems with the product.

**When installing the indoor unit, make sure to install the draining hose properly, so that water is drained correctly.**

- ▶ Failing to do so may result in water overflowing and property damage.

**When installing the outdoor unit, make sure to connect the draining hose so that draining is performed correctly.**

- ▶ The water generated during the heating operation by the outdoor unit may overflow and result in property damage. In particular, in winter, if a block of ice falls, it may result in injury, death or property damage.

## FOR POWER SUPPLY



## WARNING

---

- ❗ **When the circuit breaker is damaged, contact your nearest service center.**
- ⊘ **Do not pull or excessively bend the power line. Do not twist or tie the power line. Do not hook the power line over a metal object, place a heavy object on the power line, insert the power line between objects, or push the power line into the space behind the appliance.**
  - ▶ This may result in electric shock or fire.

## FOR POWER SUPPLY | CAUTION

---

 When not using the air conditioner for a long period of time or during a thunder/lightning storm, cut the power at the circuit breaker.

▶ Failing to do so may result in electric shock or fire.

## FOR USING | WARNING

---

 If the appliance is flooded, please contact your nearest service center.

▶ Failing to do so may result in electric shock or fire.

**If the appliance generates a strange noise, a burning smell or smoke, cut-off the power supply immediately and contact the nearest service center.**

▶ Failing to do so may result in electric shock or fire.

**In the event of a gas leak (such as propane gas, LP gas, etc.), ventilate immediately without touching the power line. Do not touch the appliance or power line.**

▶ Do not use a ventilating fan.

▶ A spark may result in an explosion or fire.

# Safety precautions

---

FOR USING



WARNING

---

**To reinstall the air conditioner, please contact your nearest service center.**

- ▶ Failing to do so may result in problems with the product, water leakage, electric shock, or fire.
- ▶ A delivery service for the product is not provided. If you reinstall the product in another location, additional construction expenses and an installation fee will be charged.
- ▶ Especially, when you wish to install the product in an unusual location such as in an industrial area or near the seaside where it is exposed to the salt in the air, please contact your nearest service center.

**⊘ Do not touch the circuit breaker with wet hands.**

- ▶ This may result in electric shock.

**Do not strike or pull the air conditioner with excessive force.**

- ▶ This may result in fire, injury, or problems with the product.

**Do not place an object near the outdoor unit that allows children to climb onto the machine.**

- ▶ This may result in children seriously injuring themselves.

**Do not turn the air conditioner off with the circuit breaker while it is operating.**

- ▶ Turning the air conditioner off and then on again with the circuit breaker may cause a spark and result in electric shock or fire.





**After unpacking the air conditioner, keep all packaging materials well out of the reach of children, as packaging materials can be dangerous to children.**

▶ If a child places a bag over its head, it may result in suffocation.

**Do not insert your fingers or foreign substances into the outlet when the air conditioner is operating or the air flow blade is closing.**

▶ Take special care that children do not injure themselves by inserting their fingers into the product.

**Do not touch the air flow blade with your hands or fingers during the heating operation.**

▶ This may result in electric shock or burns.

**Do not insert your fingers or foreign substances into the air inlet/outlet of the air conditioner.**

▶ Take special care that children do not injure themselves by inserting their fingers into the product.

**Do not use this air conditioner for long periods of time in badly ventilated locations or near infirm people.**

▶ Since this may be dangerous due to a lack of oxygen, Open a window at least once an hour.

# Safety precautions

---

## FOR USING



## WARNING

---



**If any foreign substance such as water has entered the appliance, cut-off the power supply and contact the nearest service center.**

▶ Failing to do so may result in electric shock or fire.



**Do not attempt to repair, disassemble, or modify the appliance yourself.**

▶ Do not use any fuse (such as copper, steel wire, etc.) other than the standard fuse.

▶ Failing to do so may result in electric shock, fire, problems with the product, or injury.

## FOR USING



## CAUTION

---



**Do not place objects or devices under the indoor unit.**

▶ Water dripping from the indoor unit may result in fire or property damage. (example electrical appliances)

**Check that the installation frame of the outdoor unit is not broken at least once a year.**

▶ Failing to do so may result in injury, death or property damage.

**Max current is measured according to IEC standard for safety and current is measured according to ISO standard for energy efficiency.**



⊘ **Do not stand on top of the appliance or place objects (such as laundry, lighted candles, lighted cigarettes, dishes, chemicals, metal objects, etc.) on the appliance.**

▶ This may result in electric shock, fire, problems with the product, or injury.

**Do not operate the appliance with wet hands.**

▶ This may result in electric shock.

⊘ **Do not spray volatile material such as insecticide onto the surface of the appliance.**

▶ As well as being harmful to humans, it may also result in electric shock, fire or problems with the product.

**Do not drink the water from the air conditioner.**

▶ The water may be harmful to humans.

**Do not apply a strong impact to the remote controller and do not disassemble the remote controller.**

**Do not touch the pipes connected with the product.**

▶ This may result in burns or injury.

**Do not use this air conditioner to preserve precision equipment, food, animals, plants or cosmetics, or for any other unusual purposes.**

▶ This may result in property damage.

# Safety precautions

---

FOR USING



CAUTION

---

Avoid directly exposing humans, animals or plants from the air flow from the air conditioner for long periods of time.

► This may result in harm to humans, animals or plants.

This appliance is not intended for use by persons (including children) with reduced physical, sensory or mental capabilities, or lack of experience and knowledge, unless they have been given supervision or instruction concerning use of the appliance by a person responsible for their safety. Children should be supervised to ensure that they do not play with the appliance.

**For use in Europe: This appliance can be used by children aged from 8 years and above and persons with reduced physical, sensory or mental capabilities or lack of experience and knowledge if they have been given supervision or instruction concerning use of the appliance in a safe way and understand the hazards involved. Children shall not play with the appliance. Cleaning and user maintenance shall not be made by children without supervision.**

## FOR CLEANING



## WARNING

- ⊘ **Do not clean the appliance by spraying water directly onto it. Do not use benzene, thinner, alcohol or acetone to clean the appliance.**
  - ▶ This may result in discoloration, deformation, damage, electric shock or fire.

**Before cleaning or performing maintenance, cut-off the power supply and wait until the fan stops.**

- ▶ Failing to do so may result in electric shock or fire.

## FOR CLEANING



## CAUTION

- ⓘ **Take care when cleaning the surface of the heat exchanger of the outdoor unit since it has sharp edges.**
  - ▶ To avoid cutting your fingers, wear thick cotton gloves when cleaning it.
- ⊘ **Do not clean the inside of the air conditioner by yourself.**
  - ▶ For cleaning inside the appliance, contact your nearest service center.
  - ▶ When cleaning the internal filter, refer to the descriptions in the 'Cleaning and maintenance' section.
  - ▶ Failure to do may result in damage, electric shock or fire.

# Checking before use

## For indoor unit operation

Make sure air inlet of the product is not blocked by any obstacles (such as curtain).

- ▶ Air circulation will be disturbed and cooling performance may decrease.

Set the desired temperature appropriately in cool mode.

- ▶ If the set temperature is too low, it is harmful to human and spends more electricity. Use the product in temperature lower than about 5 °C compared to outdoor temperature.

Use electric fan together for energy saving in cool mode.

- ▶ If you use the product with electric fan, cooling and energy saving efficiency becomes higher.

Use extra heating apparatus during heat mode.

- ▶ Heating performance of the air conditioner may decrease when the indoor and outdoor temperature drops. Therefore, use extra heating apparatus.

Please close the windows and doors when operating the product.

- ▶ If the product operates with the window or door open, effectiveness of cooling/heating will decrease.
- ▶ Ventilate the room about once in an hour when using the product for a long time.

Avoid sunlight or heating devices when installing the product.

- ▶ Close the curtains to avoid direct sunlight.
- ▶ Do not use any other heating apparatus with the product in cool mode. Cooling performance will decrease.

## For indoor unit storage

- ▶ Dry inside of the indoor unit by operating in fan mode or purification mode for about 3~4 hours after cleaning.



- Do not move the product on your own. Pipe connection may be loosened or damaged, and refrigerant may leak.

## For outdoor unit operation

If there are covers and obstacles, put them away.

- ▶ It may cause breakdown, and effectiveness of cooling/heating will decrease.

## Outdoor unit installation

- ▶ Install the outdoor unit in well ventilated area avoiding direct sunlight, and install sunlight cover if there is sunlight.

## Checking auxiliary power switch

Turn on auxiliary power switch which is installed separately.

1 Phase Circuit breaker



3 Phase 4 Wires Circuit breaker

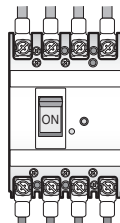

NOTE

### Auxiliary power switch (ELCB, ELB)

- Auxiliary power switch (ELCB, ELB) is not included in the package. Purchase and install it separately.
- Auxiliary power switch is to prevent over current or electric leakage. Turn it off when cleaning or not using the product for a long time.
- If there are any over current circuit breaker, such as ELB, in distribution box of building, the switch is not necessary.

## Operating temperature and humidity range

If the product is not operating within the operating temperature and humidity range, operation may stop since protective device will trigger.

Classification	Indoor temperature	Outdoor temperature	Indoor humidity
Cool mode	18 °C ~ 32 °C	-5 °C ~ 48 °C	Relative humidity under 80 %
Dry mode	18 °C ~ 32 °C	-5 °C ~ 48 °C	-
Heat mode	Under 27 °C	-20 °C ~ 24 °C	-

- \* If you operate the product in Cool mode for a longtime when humidity is high, dew may form on the surface of the product.
- \* To use the product as main heating apparatus, another load estimation is necessary. Use low temperature product which the effectiveness of heating is high. (Please contact a service center.)
- \* Outdoor temperature standard for rated heating capacity is 7 °C . If outdoor temperature becomes below 0 °C, it may decrease due to temperature condition.

## Precautions before operation

- ▶ Refrigerant used in air conditioner is non-toxic and non-flammable. However, when the air conditioner is installed in small space, extra ventilation system is required in case of refrigerant leakage.
- ▶ If you are using heat pump model, mixed operation mode is not available when the indoor units are connected to same outdoor unit.
  - \* Mixed operation mode is that two or more indoor units, connected to one outdoor unit, operating in different operation mode simultaneously.

# Name of the parts

Actual looks and supporting function may be different depending on the model.

## Indoor unit

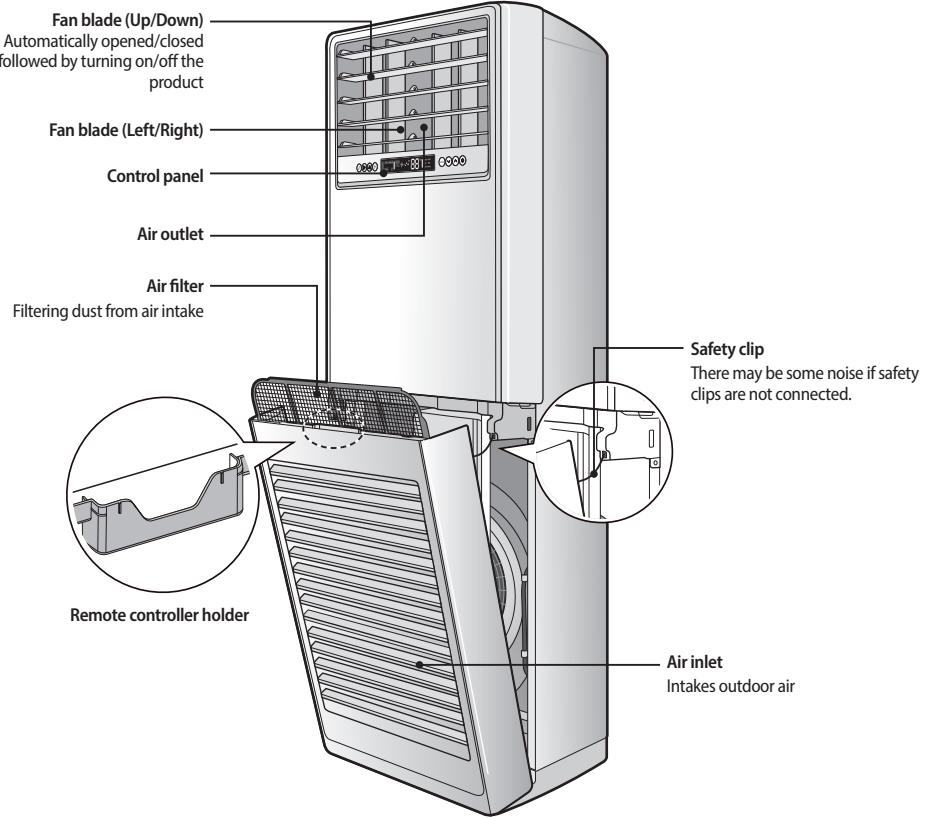

## How to open air inlet cover



Pull the air inlet cover by holding upper left and upper right edges of the cover.

- ▶ Do not open air inlet cover when operating.
- ▶ Potential risk of product damage or electric shock.



NOTE

- Safety clips of air inlet cover should be connected.



## Buttons on the control panel

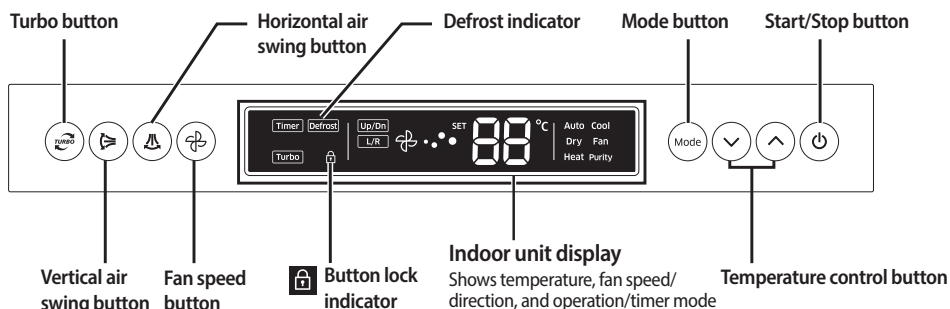

NOTE

- Functions not described in the manual is not selected or operated.

## Button lock function

This function is to lock buttons on control panel when the air conditioner is turned on or off.

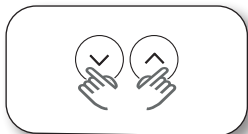

**Press and hold [Temperature Up] and [Temperature Down] button for 3 seconds simultaneously.**

- ▶ Button lock indicator (🔒) will appear on indoor unit display with ringing sound.
- ▶ When button lock function is set, the product cannot be operated by control panel and can be operated only by remote controller.
- ▶ To cancel button lock function, press and hold [Temperature Up] and [Temperature Down] button for 3 seconds simultaneously once again.

# Basic operation

Basic operation is an operation mode that can be selected by pressing the [Mode] button.

## Auto mode

When you set the set temperature for comfortable environment, the product will change the operation mode into Auto(Cool) or Auto(Heat) and fan speed according to the set temperature and current temperature.

## Cool mode

In Cool mode, the indoor temperature, fan speed, and air flow direction can be adjusted at your desire to cool your indoor.

## Dry mode

The air conditioner will act like a dehumidifier by removing moisture from the indoor air.

- ▶ Turning on/off will repeat according to difference between the current temperature and the set temperature.

## Fan mode

Fan mode provides you with a breeze just like a fan to make fresh environment for you.

## Heat mode

In Heat mode, the indoor temperature, fan speed, and air flow direction can be adjusted at your desire to warm your indoor.

- ▶ Indoor unit may not start the operation immediately until indoor heat exchanger is warmed up to a certain temperature (approximately 5 minutes according to current indoor temperature) to prevent generating a cold breeze.
- ▶ Defrost indicator: When removing frost at the outdoor unit in the Heat mode, **Defrost** will be displayed on the indoor unit display and it will be turned off after removing the frost.  
(When removing the frost during the defrost operation in Heat mode, steam may be generated and the warm breeze may not come out from the indoor unit.)



NOTE

- When the outdoor temperature is low and humidity is high, frost may form on outdoor unit's heat exchanger and may decrease the heating performance so the Defrost operation will operate for 5 ~ 12 minutes to get rid of the frost on the outdoor unit heat exchanger. Indoor unit will be off during Defrost operation is on since cold air may come out from it.
  - \* The interval between the defrost operation can decrease depending on the amount of the frost formed on the outdoor unit.
  - \* The interval between defrost operation can also decrease by humidity level with rain or snow.

## Purity function

Purity function is an air sterilization function which eliminates airborne harmful substances to provide healthy and clean surrounding environment. This function can be selected additionally while other operation modes or functions are on.

- ▶ Purity function only operates when SPi is installed. (Optional accessories)

## Timer function

You can set the air conditioner to be turned on or off automatically at desired time.

## Speed mode

You can set the Turbo function to provide fast and powerful cooling/heating.



NOTE

- It operates same function as [Speed] button on remote controller.
- Turbo function is only available in Cool/Heat mode.
- Air flow direction can be adjusted with every direction.
- Temperature and fan speed cannot be adjusted.

# Basic operation

## Operation with control panel

You can operate the product by control panel without remote controller.



1. Press the [Power] button to operate the air conditioner.

▶ The air conditioner turns on with a ringing sound.

**Stop** Press the [Power] button again.







2. Adjust the set temperature by [Temperature Up] and [Temperature Down] button.



▶ You can adjust the temperature between 18 °C ~ 30 °C in cool mode and 16 °C ~ 30 °C in heat mode by 1 °C by pressing the button.



3. Press the [Fan speed] button to adjust the fan speed.

▶ Each time you press [Fan speed] button,  (Low) ▷  (Med) ▷  (High) ▷  (Turbo) will be selected in rotation.

▶ You cannot adjust fan speed in Auto/Dry mode.

▶ In Fan mode,  (Low) ▷  (Med) ▷  (High) will be selected in rotation.

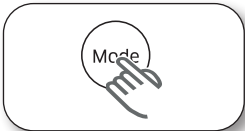

4. Select different mode and function depending when necessary.

▶ Press the [Mode] button to select operation mode. Each time you press [Mode] button, (Auto) ▷ (Cool) ▷ (Dry) ▷ (Fan) ▷ (Heat) will be selected in rotation.

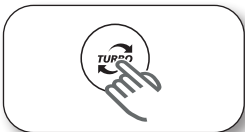

▶ Press the [Turbo] button to set the turbo function.

▶ Turbo function is only available in Cool/Heat mode.

▶ If you select turbo function while using vertical air swing, the air swing will be cancelled.



▶ Press [Vertical air swing] button to control the fan direction in up and down.



▶ Press [Horizontal air swing] button to control the fan direction in left and right.

# Cleaning and maintenance



- Unplug the power plug or turn off the auxiliary power switch when cleaning.

## Cleaning the indoor unit

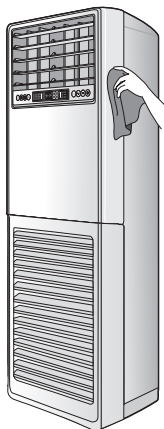

- ▶ Clean the product with a tepid damp cloth.
- ▶ Use the soft brush to remove dust between gaps of the air conditioner.



NOTE

- Call a service center to wash and clean the heat exchanger since the product has to be disassembled.
- There could be odor generated depending on the surrounding environment (such as restaurant, hair shop, etc.) It is recommended to prevent odor generating by operating Fan mode with ventilation and cleaning the air filter. If you have any problem with odor, please contact a service center.



CAUTION

- Do not clean the control panel with an alkali detergent.
- Do not clean the product with sulfuric acid, hydrochloric acid, or organic solvent (thinner, kerosene, acetone, etc.) or do not attach a sticker onto the surface of the product. This may damage the surface of the product.

## Cleaning the heat exchanger

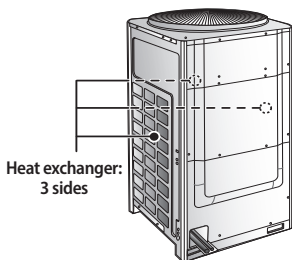

- ▶ Clean periodically. If there are too much dust on the heat exchanger, the effectiveness of cooling/heating will decrease.
- ▶ Clean the dust.



NOTE

- Call a service center to wash and clean the heat exchanger since the product has to be disassembled.



CAUTION

- The surface of heat exchanger is sharp, so be careful when cleaning.

# Cleaning and maintenance

## Cleaning the air filter

Air filter traps dust among the inducted air.

Before cleaning, get rid of fixing tape and pull out the air filter.

- Pull the air filter by gripping the filter handle.

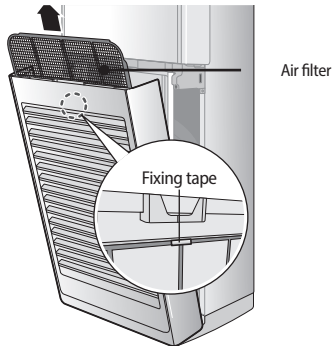

Remove dust by using the vacuum cleaner or washing it on running water.

- If the filter is very dirty, clean the filter with a warm neutral detergent solution. If you rub the filter too hard, air filter may get damaged so be careful when cleaning.

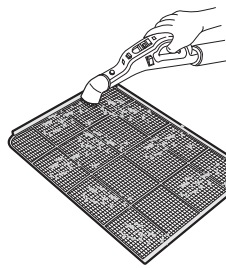

Push the dust filter firmly in directed way so that it can be inserted completely.



When cleaning the filter by water, dry the filter in the shade.

- When drying the air filter, make sure the filter is not exposed to direct sunlight. Otherwise, product malformation may occur.

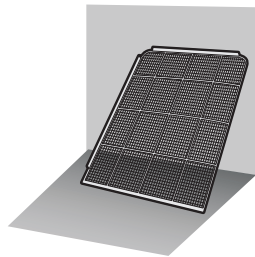

- Clean the air filter every two weeks. However, cleaning term may differ depending on usage and environmental conditions.



# Troubleshooting

Problem	Checkpoint	Solution
The product is not working	Check if the power is supplied.	After checking the power supply status, operate the product again.
	Check if the auxiliary power switch is turned off.	Turn on the auxiliary power switch and operate the product again.
	Check if the product is turned off by Off timer.	Press the  to operate the air conditioner.
Temperature cannot be adjusted.	Check if the product is operating in Fan mode.	The set temperature is set to Auto in Fan mode, therefore you cannot adjust it.
Heat mode is not operating.	Check if the outdoor unit is cooling only product.	Heat mode is not operating even if you select Heat mode when the outdoor unit is cooling only product.
	Check if the remote controller is for cooling only models.	Use the remote controller that is only for heat pump models.
Fan speed cannot be adjusted.	Check if the product is operating in Auto/Dry mode.	The fan speed is set to Auto in Auto/Dry mode, therefore you cannot adjust it.
Wireless remote controller does not work at all.	Check if your batteries are good.	Replace the batteries.
	Check if remote control sensor is blocked by obstacles.	Remove the obstacles.
	Check if there is strong light nearby.	Do not use the remote controller near strong light. There is a possibility that the remote controller will not operate by infrared interference of strong light such as a fluorescent lamp or neon sign.

# Troubleshooting

Problem	Checkpoint	Solution
Cool/Warm air does not come out.	Check if the set temperature is higher (during Cool mode) / lower (during Heat mode) than the current temperature.	In Cool mode, check if the desired temperature is higher than the current temperature. Press the  and  to set the temperature lower than the current temperature.
		In Heat mode, check if the desired temperature is lower than the current temperature. Press the  and  to set the temperature higher than the current temperature. (Only for heat pump model)
	Check if the product is operating in Fan mode.	Cool/Warm air does not come out in Fan mode. Operate in Auto/Cool/Dry/Heat mode.
	Check if the air filter is blocked with dust.	If there are too much dust on air filter, the effectiveness of cooling/heating will decrease. Clean it frequently.
	Check if there are any obstacles near the outdoor unit.	Take the cover off and take the obstacles away. Poor ventilation will decrease effectiveness of cooling/heating.
	Check if there is direct sunlight. (in Cool mode)	Close curtains to avoid direct sunlight.
	Check if windows or doors are opened.	Close windows or doors. Effectiveness of cooling/heating will decrease when they are opened.



Problem	Checkpoint	Solution
Cool/Warm air does not come out.	Check if the product is turned on right after Cool mode operation is stopped.	Cool air does not come out right after the product is turned on to protect the compressor of the outdoor unit. Please wait for 3 minutes. Therefore, do not worry about the product malfunction for this.
	Check if the product is operating in Heat mode.	Warm air does not come out right after the product is turned on to avoid cold air coming out. Please wait for a while. Therefore, do not worry about the product malfunction for this.
	Check if the pipe length is too long.	When the pipe length is exceeds maximum allowable pipe length, effectiveness of cooling/heating may decrease.
Off timer does not work.	Check if the product is turned off.	Set Off timer after turning on the product.
	Check if the Off timer is already set.	Please check timer indicator on the indoor unit display.
Buttons on control panel does not work.	Check if button lock function is set.	Press and hold  and  for 3 seconds. Button lock function will be cancelled.
Strange odor is generated.	Check if you are using the product in a place with smoke or other odor.	Please ventilate the indoor area. If the odor is bad, operate in Fan mode for 3~4 hours. Air conditioner does not use smelly parts.
	Check if the air filter is dirty.	Clean the air filter.

# Troubleshooting

Problem	Checkpoint	Solution
<p>Strange indication is displayed</p>	<p><b>E*</b> ↔ <b>**</b> appeared on indoor unit display. Ex) E1↔01. E1↔21. E1↔52 ...</p>	<p>This indicates that the unit is out of order. Please contact the service center.</p>
	<p><b>Defrost</b> appeared on indoor unit display.</p>	<p>It indicates Defrost operation which removes frost on the outdoor unit when operating Heat mode. Therefore, do not worry about the product malfunction for this.</p>
<p>Strange noise is generated.</p>	<p>Depending on the status of the air conditioner usage (especially the outdoor temperature is below 20 °C), noise can be heard when refrigerant flow movement changes. It is normal.</p>	
<p>Water is dripping from outdoor unit pipe connection.</p>	<p>Water may be generated due to the temperature difference. Therefore, do not worry about the product malfunction for this.</p>	
<p>Steam is generated from the outdoor unit.</p>	<p>When the air conditioner is in heat mode in the winter, steam may generate during the frost removing operation. Therefore, do not worry about fire with this.</p>	

# Product specification

MODEL		AM140JNPDKH	
CLIMATE CLASS		T1	T3
RATED VOLTAGE & FREQUENCY		220 - 240 V ~ 50 Hz	
RATED CURRENT	COOLING	0.9 A	0.9 A
	HEATING(H1)	0.9 A	
RATED POWER INPUT	COOLING	190 W	190 W
	HEATING(H1)	190 W	
EER	COOLING	-	-
	HEATING(H1)	-	
NET WEIGHT		48 kg	
DIMENSIONS OF THE UNIT [WxHxD]		610 x 1850 x 400 mm	
COUNTRY OF ORIGIN		MADE IN KOREA	

# SAMSUNG

QUESTIONS OR COMMENTS?

COUNTRY	CALL	OR VISIT US ONLINE AT
EGYPT	08000-7267864 16580	<a href="http://www.samsung.com/eg/support">www.samsung.com/eg/support</a>
IRAN	021-8255 [CE] 021-42132 [HHP]	<a href="http://www.samsung.com/iran/support">www.samsung.com/iran/support</a>
Israel	*6963	<a href="http://www.samsung.com/il/support/">www.samsung.com/il/support/</a>
SAUDI ARABIA	(+966) 8002474357 (800 24/7 HELP)	<a href="http://www.samsung.com/sa/home">www.samsung.com/sa/home</a> <a href="http://www.samsung.com/sa_en">www.samsung.com/sa_en</a>
PAKISTAN	0800-Samsung (72678)	<a href="http://www.samsung.com/pk/support">www.samsung.com/pk/support</a>
U.A.E	800-SAMSUNG (800 - 726 7864)	<a href="http://www.samsung.com/ae/support">www.samsung.com/ae/support</a> (English) <a href="http://www.samsung.com/ae_ar/support">www.samsung.com/ae_ar/support</a> (Arabic)
OMAN	800-SAMSUNG (800 - 726 7864)	
KUWAIT	183-CALL (183-2255)	
BAHRAIN	8000-GSAM (8000-4726)	
QATAR	800-CALL (800-2255)	
TURKEY	444 77 11	<a href="http://www.samsung.com/tr/support">www.samsung.com/tr/support</a>
JORDAN	0800-22273 06 5777444	<a href="http://www.samsung.com/levant/support">www.samsung.com/levant/support</a>
SYRIA	962 5777444	
Lebanon	961 1484 999 1299	
Iraq	80010080	
ALGERIA	3004	
TUNISIA	80 1000 12	<a href="http://www.samsung.com/n_africa/support">www.samsung.com/n_africa/support</a>
MOROCCO	080 100 22 55	
RUSSIA	8-800-555-55-55 (VIP care 8-800-555-55-88)	<a href="http://www.samsung.com/ru/support">www.samsung.com/ru/support</a>
BELARUS	810-800-500-55-500	<a href="http://www.samsung.com/support">www.samsung.com/support</a>
GEORGIA	0-800-555-555	<a href="http://www.samsung.com/support">www.samsung.com/support</a>
ARMENIA	0-800-05-555	<a href="http://www.samsung.com/support">www.samsung.com/support</a>
AZERBAIJAN	0-88-555-55-55	<a href="http://www.samsung.com/support">www.samsung.com/support</a>
KAZAKHSTAN	8-10-800-500-55-500 (GSM: 7799, VIP care 7700)	<a href="http://www.samsung.com/kz_ru/support">www.samsung.com/kz_ru/support</a>
UZBEKISTAN	00-800-500-55-500 (GSM: 7799)	<a href="http://www.samsung.com/support">www.samsung.com/support</a>
KYRGYZSTAN	00-800-500-55-500 (GSM: 9977)	<a href="http://www.samsung.com/support">www.samsung.com/support</a>
TAJKIKISTAN	8-10-800-500-55-500	<a href="http://www.samsung.com/support">www.samsung.com/support</a>
MONGOLIA	+7-495-363-17-00	<a href="http://www.samsung.com/support">www.samsung.com/support</a>
UKRAINE	0-800-502-000	<a href="http://www.samsung.com/ua/support">www.samsung.com/ua/support</a> (Ukrainian) <a href="http://www.samsung.com/ua_ru/support">www.samsung.com/ua_ru/support</a> (Russian)
MOLDOVA	0-800-614-40	<a href="http://www.samsung.com/support">www.samsung.com/support</a>
INDONESIA	021-56997777 08001128888	<a href="http://www.samsung.com/id/support">www.samsung.com/id/support</a>