

# TOSHIBA

Leading Innovation >>>

## AIR CONDITIONER (MULTI TYPE) Installation Manual



### Outdoor Unit

For commercial use

Model name:

<Heat Pump Model>

**MMY-MAP0804HT8P-E**  
**MMY-MAP1004HT8P-E**  
**MMY-MAP1204HT8P-E**  
**MMY-MAP1404HT8P-E**  
**MMY-MAP1604HT8P-E**

**MMY-MAP0804HT8JP-E**  
**MMY-MAP1004HT8JP-E**  
**MMY-MAP1204HT8JP-E**  
**MMY-MAP1404HT8JP-E**  
**MMY-MAP1604HT8JP-E**

<Cooling Only Model>

**MMY-MAP0804T8P-E**  
**MMY-MAP1004T8P-E**  
**MMY-MAP1204T8P-E**  
**MMY-MAP1404T8P-E**  
**MMY-MAP1604T8P-E**

**MMY-MAP0804T8JP-E**  
**MMY-MAP1004T8JP-E**  
**MMY-MAP1204T8JP-E**  
**MMY-MAP1404T8JP-E**  
**MMY-MAP1604T8JP-E**

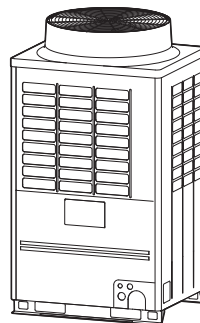

Original instruction

**ADOPTION OF NEW REFRIGERANT**

This Air Conditioner uses R410A an environmentally friendly refrigerant.

# Contents

<b>1</b>	<b>Precautions for safety</b> .....	<b>3</b>
<b>2</b>	<b>Accessory parts</b> .....	<b>4</b>
<b>3</b>	<b>Installation of new refrigerant air conditioner</b> .....	<b>5</b>
<b>4</b>	<b>Selection of installation place</b> .....	<b>5</b>
<b>5</b>	<b>Carrying in the outdoor unit</b> .....	<b>7</b>
<b>6</b>	<b>Installation of the outdoor unit</b> .....	<b>8</b>
<b>7</b>	<b>Refrigerant piping</b> .....	<b>10</b>
<b>8</b>	<b>Electric wiring</b> .....	<b>19</b>
<b>9</b>	<b>Address setting</b> .....	<b>23</b>
<b>10</b>	<b>Test run</b> .....	<b>30</b>
<b>11</b>	<b>Troubleshooting</b> .....	<b>32</b>
<b>12</b>	<b>Machine card and logbook</b> .....	<b>33</b>

Thank you for purchasing this Toshiba air conditioner.

This Installation Manual describes the installation method of the outdoor unit. For installation of indoor units, follow the Installation Manual supplied with the indoor unit.

Moreover, as this installation manual includes the important articles concerning the "Machinery" Directive (Directive 2006/42/EC), please read through the manual and make sure you understand it. After installation, give this Installation Manual, the Owner's Manual and the Installation Manual supplied with the indoor unit to the customer and tell the customer to keep them safe.

Prepare an exclusive power source for indoor units, independent to that for outdoor units.

Y-shaped branching joints or a branching header (separately purchased) are required for connecting pipes between indoor and outdoor units. Choose either of them considering the system capacity concerning piping. For installing branching pipes, refer to the installation manual of the Y-shaped branching unit or branching header (separately purchased).

Outdoor connecting branching joints are required for connecting between outdoor units.

**Generic Denomination: Air Conditioner**

**Definition of Qualified Installer or Qualified Service Person**

The air conditioner must be installed, maintained, repaired and removed by a qualified installer or qualified service person. When any of these jobs is to be done, ask a qualified installer or qualified service person to do them for you.

A qualified installer or qualified service person is an agent who has the qualifications and knowledge described in the table below.

Agent	Qualifications and knowledge which the agent must have
Qualified installer	<ul style="list-style-type: none"> <li>• The qualified installer is a person who installs, maintains, relocates and removes the air conditioners made by Toshiba Carrier Corporation. He or she has been trained to install, maintain, relocate and remove the air conditioners made by Toshiba Carrier Corporation or, alternatively, he or she has been instructed in such operations by an individual or individuals who have been trained and is thus thoroughly acquainted with the knowledge related to these operations.</li> <li>• The qualified installer who is allowed to do the electrical work involved in installation, relocation and removal has the qualifications pertaining to this electrical work as stipulated by the local laws and regulations, and he or she is a person who has been trained in matters relating to electrical work on the air conditioners made by Toshiba Carrier Corporation or, alternatively, he or she has been instructed in such matters by an individual or individuals who have been trained and is thus thoroughly acquainted with the knowledge related to this work.</li> <li>• The qualified installer who is allowed to do the refrigerant handling and piping work involved in installation, relocation and removal has the qualifications pertaining to this refrigerant handling and piping work as stipulated by the local laws and regulations, and he or she is a person who has been trained in matters relating to refrigerant handling and piping work on the air conditioners made by Toshiba Carrier Corporation or, alternatively, he or she has been instructed in such matters by an individual or individuals who have been trained and is thus thoroughly acquainted with the knowledge related to this work.</li> <li>• The qualified installer who is allowed to work at heights has been trained in matters relating to working at heights with the air conditioners made by Toshiba Carrier Corporation or, alternatively, he or she has been instructed in such matters by an individual or individuals who have been trained and is thus thoroughly acquainted with the knowledge related to this work.</li> </ul>
Qualified service person	<ul style="list-style-type: none"> <li>• The qualified service person is a person who installs, repairs, maintains, relocates and removes the air conditioners made by Toshiba Carrier Corporation. He or she has been trained to install, repair, maintain, relocate and remove the air conditioners made by Toshiba Carrier Corporation or, alternatively, he or she has been instructed in such operations by an individual or individuals who have been trained and is thus thoroughly acquainted with the knowledge related to these operations.</li> <li>• The qualified service person who is allowed to do the electrical work involved in installation, repair, relocation and removal has the qualifications pertaining to this electrical work as stipulated by the local laws and regulations, and he or she is a person who has been trained in matters relating to electrical work on the air conditioners made by Toshiba Carrier Corporation or, alternatively, he or she has been instructed in such matters by an individual or individuals who have been trained and is thus thoroughly acquainted with the knowledge related to this work.</li> <li>• The qualified service person who is allowed to do the refrigerant handling and piping work involved in installation, repair, relocation and removal has the qualifications pertaining to this refrigerant handling and piping work as stipulated by the local laws and regulations, and he or she is a person who has been trained in matters relating to refrigerant handling and piping work on the air conditioners made by Toshiba Carrier Corporation or, alternatively, he or she has been instructed in such matters by an individual or individuals who have been trained and is thus thoroughly acquainted with the knowledge related to this work.</li> <li>• The qualified service person who is allowed to work at heights has been trained in matters relating to working at heights with the air conditioners made by Toshiba Carrier Corporation or, alternatively, he or she has been instructed in such matters by an individual or individuals who have been trained and is thus thoroughly acquainted with the knowledge related to this work.</li> </ul>

### Definition of Protective Gear







When the air conditioner is to be transported, installed, maintained, repaired or removed, wear protective gloves and 'safety' work clothing.

In addition to such normal protective gear, wear the protective gear described below when undertaking the special work detailed in the table below.

Failure to wear the proper protective gear is dangerous because you will be more susceptible to injury, burns, electric shocks and other injuries.

Work undertaken	Protective gear worn
All types of work	Protective gloves 'Safety' working clothing
Electrical-related work	Gloves to provide protection for electricians and from heat Insulating shoes Clothing to provide protection from electric shock
Work done at heights (50 cm or more)	Helmets for use in industry
Transportation of heavy objects	Shoes with additional protective toe cap
Repair of outdoor unit	Gloves to provide protection for electricians and from heat

### ■ Warning indications on the air conditioner unit

Warning indication	Description		
 <table border="1"> <tr> <td><b>WARNING</b></td> </tr> <tr> <td><b>ELECTRICAL SHOCK HAZARD</b> Disconnect all remote electric power supplies before servicing.</td> </tr> </table>	<b>WARNING</b>	<b>ELECTRICAL SHOCK HAZARD</b> Disconnect all remote electric power supplies before servicing.	<b>WARNING</b>  <b>ELECTRICAL SHOCK HAZARD</b> Disconnect all remote electric power supplies before servicing.
<b>WARNING</b>			
<b>ELECTRICAL SHOCK HAZARD</b> Disconnect all remote electric power supplies before servicing.			
 <table border="1"> <tr> <td><b>WARNING</b></td> </tr> <tr> <td>Moving parts. Do not operate unit with grille removed. Stop the unit before the servicing.</td> </tr> </table>	<b>WARNING</b>	Moving parts. Do not operate unit with grille removed. Stop the unit before the servicing.	<b>WARNING</b>  Moving parts. Do not operate unit with grille removed. Stop the unit before the servicing.
<b>WARNING</b>			
Moving parts. Do not operate unit with grille removed. Stop the unit before the servicing.			
 <table border="1"> <tr> <td><b>CAUTION</b></td> </tr> <tr> <td>High temperature parts. You might get burned when removing this panel.</td> </tr> </table>	<b>CAUTION</b>	High temperature parts. You might get burned when removing this panel.	<b>CAUTION</b>  High temperature parts. You might get burned when removing this panel.
<b>CAUTION</b>			
High temperature parts. You might get burned when removing this panel.			
 <table border="1"> <tr> <td><b>CAUTION</b></td> </tr> <tr> <td>Do not touch the aluminum fins of the unit. Doing so may result in injury.</td> </tr> </table>	<b>CAUTION</b>	Do not touch the aluminum fins of the unit. Doing so may result in injury.	<b>CAUTION</b>  Do not touch the aluminium fins of the unit. Doing so may result in injury.
<b>CAUTION</b>			
Do not touch the aluminum fins of the unit. Doing so may result in injury.			
 <table border="1"> <tr> <td><b>CAUTION</b></td> </tr> <tr> <td><b>BURST HAZARD</b> Open the service valves before the operation, otherwise there might be the burst.</td> </tr> </table>	<b>CAUTION</b>	<b>BURST HAZARD</b> Open the service valves before the operation, otherwise there might be the burst.	<b>CAUTION</b>  <b>BURST HAZARD</b> Open the service valves before the operation, otherwise there might be the burst.
<b>CAUTION</b>			
<b>BURST HAZARD</b> Open the service valves before the operation, otherwise there might be the burst.			
 <table border="1"> <tr> <td><b>CAUTION</b></td> </tr> <tr> <td><b>Do not climb onto the fan guard.</b> Doing so may result in injury.</td> </tr> </table>	<b>CAUTION</b>	<b>Do not climb onto the fan guard.</b> Doing so may result in injury.	<b>CAUTION</b>  <b>Do not climb onto the fan guard.</b> Doing so may result in injury.
<b>CAUTION</b>			
<b>Do not climb onto the fan guard.</b> Doing so may result in injury.			

# 1 Precautions for safety

The manufacturer shall not assume any liability for the damage caused by not observing the description of this manual.

## WARNING

### General

- Before starting to install the air conditioner, read through the Installation Manual carefully, and follow its instructions to install the air conditioner. Otherwise, falling down of the unit may occur, or the unit may cause noise, vibration or water leakage.
- Only a qualified installer(\*1) or qualified service person(\*1) is allowed to do installation work. If installation is carried out by an unqualified individual, a fire, electric shocks, injury, water leakage, noise and/or vibration may result.
- If using separately sold products, make sure to use Toshiba specified products only. Using unspecified products may cause fire, electric shock, water leak or other failure.
- Do not use any refrigerant different from the one specified for complement or replacement. Otherwise, abnormally high pressure may be generated in the refrigeration cycle, which may result in a failure or explosion of the product or an injury to your body.
- Before opening the service panel of the outdoor unit, set the circuit breaker to the OFF position. Failure to set the circuit breaker to the OFF position may result in electric shocks through contact with the interior parts. Only a qualified installer(\*1) or qualified service person(\*1) is allowed to remove the service panel of the outdoor unit and do the work required.
- Before carrying out the installation, maintenance, repair or removal work, be sure to set the circuit breakers for both the indoor and outdoor units to the OFF position. Otherwise, electric shock may result.
- Place a "Work in progress" sign near the circuit breaker while the installation, maintenance, repair or removal work is being carried out. There is a danger of electric shocks if the circuit breaker is set to ON by mistake.
- Only a qualified installer(\*1) or qualified service person(\*1) is allowed to undertake work at heights using a stand of 50 cm or more or to remove the intake grille of the indoor unit to undertake work.
- Wear protective gloves and safety work clothing during installation, servicing and removal.
- Do not touch the aluminium fin of the outdoor unit. You may injure yourself if you do so. If the fin must be touched for some reason, first put on protective gloves and safety work clothing, and then proceed.
- Do not climb onto or place objects on top of the outdoor unit. You may fall or the objects may fall off of the outdoor unit and result in injury.
- When working at height, put a sign in place so that no-one will approach the work location before proceeding with the work. Parts or other objects may fall from above, possibly injuring a person below. Also, be sure that workers put on helmets.
- When cleaning the filter or other parts of the outdoor unit, set the circuit breaker to OFF without fail, and place a "Work in progress" sign near the circuit breaker before proceeding with the work.
- When working at heights, put a sign in place so that no-one will approach the work location, before proceeding with the work. Parts and other objects may fall from above, possibly injuring a person below.
- The refrigerant used by this air conditioner is the R410A.
- You shall ensure that the air conditioner is transported in stable condition. If you find any part of the product broken, contact your dealer.
- Do not disassemble, modify, repair or move the product yourself. Doing so may cause fire, electric shock, injury or water leaks. Ask a qualified installer or qualified service person to do any repairs or to move the product.

### Selection of installation location

- If you install the unit in a small room, take appropriate measures to prevent the refrigerant from exceeding the limit concentration even if it leaks. Consult the dealer from whom you purchased the air conditioner when you implement the measures. Accumulation of highly concentrated refrigerant may cause an oxygen deficiency accident.
- Do not install in a location where flammable gas may leak or accumulate around the unit, it may ignite and cause a fire.
- When transporting the air conditioner, wear shoes with protective toe caps, protective gloves and other protective clothing.
- When transporting the air conditioner, do not take hold of the bands around the packing carton. You may injure yourself if the bands should break.
- Install the indoor unit at least 2.5 m above the floor level since otherwise the users may injure themselves or receive electric shocks if they poke their fingers or other objects into the indoor unit while the air conditioner is running.
- Do not place any combustion appliance in a place where it is directly exposed to the wind of air conditioner, otherwise it may cause imperfect combustion.
- Places where the operation sound of the outdoor unit may cause a disturbance. (Especially at the boundary line with a neighbour, install the air conditioner while considering the noise.)

### Installation

- Follow the instructions in the Installation Manual to install the air conditioner. Failure to follow these instructions may cause the product to fall down or topple over or give rise to noise, vibration, water leakage or other failure.
- The designated bolts (M12) and nuts (M12) for securing the outdoor unit must be used when installing the unit.
- Install the outdoor unit properly in a location that is durable enough to support the weight of the outdoor unit. Insufficient durability may cause the outdoor unit to fall, which may result in injury.
- Install the unit in the prescribed manner for protection against strong wind and earthquake. Incorrect installation may result in the unit falling down, or other accidents.

- Be sure to fix the screws back which have been removed for installation or other purposes.

### Refrigerant piping

- Install the refrigerant pipe securely during the installation work before operating the air conditioner. If the compressor is operated with the valve open and without refrigerant pipe, the compressor sucks air and the refrigeration cycles is over pressurized, which may cause a injury.
- Tighten the flare nut with a torque wrench in the specified manner. Excessive tighten of the flare nut may cause a crack in the flare nut after a long period, which may result in refrigerant leakage.
- Ventilate the air if the refrigerant gas leaks during installation. If the leaked refrigerant gas comes into contact with fire, toxic gas may be produced.
- After the installation work, confirm that refrigerant gas does not leak. If refrigerant gas leaks into the room and flows near a fire source, such as a cooking range, noxious gas may be generated.
- When the air conditioner has been installed or relocated, follow the instructions in the Installation Manual and purge the air completely so that no gases other than the refrigerant will be mixed in the refrigerating cycle. Failure to purge the air completely may cause the air conditioner to malfunction.
- Nitrogen gas must be used for the airtight test.
- The charge hose must be connected in such a way that it is not slack.
- If refrigerant gas has leaked during the installation work, ventilate the room immediately. If the leaked refrigerant gas comes in contact with fire, noxious gas may be generated.

### Electrical wiring

- Only a qualified installer(\*1) or qualified service person(\*1) is allowed to carry out the electrical work of the air conditioner. Under no circumstances must this work be done by an unqualified individual since failure to carry out the work properly may result in electric shocks and/or electrical leaks.
- When connecting the electrical wires, repairing the electrical parts or undertaking other electrical jobs, wear gloves to provide protection for electricians and from heat, insulating shoes and clothing to provide protection from electric shocks. Failure to wear this protective gear may result in electric shocks.
- When executing address setting, test run, or troubleshooting through the checking window on the electrical control box, put on insulated heat-proof gloves, insulated shoes and other clothing to provide protection from electric shock. Otherwise you may receive an electric shock.
- Use wiring that meets the specifications in the Installation Manual and the stipulations in the local regulations and laws. Use of wiring which does not meet the specifications may give rise to electric shocks, electrical leakage, smoking and/or a fire.
- Check that the product is properly earthed. (grounding work)  
Incomplete earthing may cause electric shock.
- Do not connect the earth line to a gas pipe, water pipe, lightning conductor, or a telephone earth line.
- After completing the repair or relocation work, check that the ground wires are connected properly.
- Install a circuit breaker that meets the specifications in the installation manual and the stipulations in the local regulations and laws.
- Install the circuit breaker where it can be easily accessed by the agent.
- When installing the circuit breaker outdoors, install one which is designed to be used outdoors.
- Under no circumstances must the power cable be extended. Connection trouble in the places where the cable is extended may give rise to smoking and/or a fire.
- Electrical wiring work shall be conducted according to law and regulation in the community and installation manual. Failure to do so may result in electrocution or short circuit.
- Do not supply power from the power terminal block equipped on the outdoor unit to another outdoor unit. Capacity overflow may occur on the terminal block and may result in fire.
- When carrying out electric connection, use the wire specified in the Installation Manual and connect and fix the wires securely to prevent them applying external force to the terminals. Improper connection or fixing may result in fire.

### Test run

- Before operating the air conditioner after having completed the work, check that the electrical parts box cover of the indoor unit and service panel of the outdoor unit are closed, and set the circuit breaker to the ON position. You may receive an electric shock if the power is turned on without first conducting these checks.
- When you have noticed that some kind of trouble (such as when an error display has appeared, there is a smell of burning, abnormal sounds are heard, the air conditioner fails to cool or water is leaking) has occurred in the air conditioner, do not touch the air conditioner yourself but set the circuit breaker to the OFF position, and contact a qualified service person. Take steps to ensure that the power will not be turned on (by marking "out of service" near the circuit breaker, for instance) until qualified service person arrives. Continuing to use the air conditioner in the trouble status may cause mechanical problems to escalate or result in electric shocks or other failure.
- After the work has finished, be sure to use an insulation tester set (500V Megger) to check the resistance is 1 MΩ or more between the charge section and the non-charge metal section (Earth section). If the resistance value is low, a disaster such as a leak or electric shock is caused at user's side.
- Upon completion of the installation work, check for refrigerant leaks and check the insulation resistance and water drainage. Then conduct a test run to check that the air conditioner is operating properly.

### Explanations given to user

- Upon completion of the installation work, tell the user where the circuit breaker is located. If the user does not know where the circuit breaker is, he or she will not be able to turn it off in the event that trouble has occurred in the air conditioner.
- If you have discovered that the fan grille is damaged, do not approach the outdoor unit but set the circuit breaker to the OFF position, and contact a qualified service person(\*1) to have the repairs done. Do not set the circuit breaker to the ON position until the repairs are completed.
- After the installation work, follow the Owner's Manual to explain to the customer how to use and maintain the unit.

### Relocation

- Only a qualified installer(\*1) or qualified service person(\*1) is allowed to relocate the air conditioner. It is dangerous for the air conditioner to be relocated by an unqualified individual since a fire, electric shocks, injury, water leakage, noise and/or vibration may result.
- When carrying out the pump-down work shut down the compressor before disconnecting the refrigerant pipe. Disconnecting the refrigerant pipe with the service valve left open and the compressor still operating will cause air or other gas to be sucked in, raising the pressure inside the refrigeration cycle to an abnormally high level, and possibly resulting in rupture, injury or other trouble.
- Never recover the refrigerant into the outdoor unit. Be sure to use a refrigerant recovery machine to recover the refrigerant when moving or repairing. It is impossible to recover the refrigerant into the outdoor unit. Refrigerant recovery into the outdoor unit may result in serious accidents such as explosion of the unit, injury or other accidents.

(\*1) Refer to the "Definition of Qualified Installer or Qualified Service Person."

### CAUTION

#### New refrigerant air conditioner installation

- **This air conditioner adopts the new HFC refrigerant (R410A) which does not destroy ozone layer.**
- The characteristics of R410A refrigerant are; easy to absorb water, oxidizing membrane or oil, and its pressure is approx. 1.6 times higher than that of refrigerant R22. Accompanied with the new refrigerant, refrigerating oil has also been changed. Therefore, during installation work, be sure that water, dust, former refrigerant, or refrigerating oil does not enter the refrigerating cycle.
- To prevent charging an incorrect refrigerant and refrigerating oil, the sizes of connecting sections of charging port of the main unit and installation tools are changed from those for the conventional refrigerant.
- Accordingly the exclusive tools are required for the new refrigerant (R410A).
- For connecting pipes, use new and clean piping designed for R410A, and please care so that water or dust does not enter.

#### To disconnect the appliance from main power supply.



- This appliance must be connected to the main power supply by means of a switch with a contact separation of at least 3 mm.

#### The installation fuse (all type can be used) must be used for the power supply line of this conditioner.

#### Do not wash air conditioners with pressure washers.

#### Electric leaks may cause electric shocks or fires.

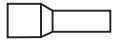
## 2 Accessory parts

Part name	Q'ty	Shape	Usage
Owner's Manual	1	—	(Be sure to hand it to the customers.)
Installation Manual	1	—	(Be sure to hand it to the customers.)
CD-ROM (Owner's manual, Installation manual)	1	—	For other languages that do not appear in this Installation Manual, Please refer to the enclosed CD-ROM.
Attached pipe (for Ø22.2)	1		Connecting pipe for gas side piping (MAP080, MAP100 type)
Attached pipe (for Ø28.6)	1		Connecting pipe for gas side piping (MAP120, MAP140, MAP160 type)
F-GAS label	1		Fill the items on the label after adding refrigerant.

### 3 Installation of new refrigerant air conditioner

This air conditioner adopts the new HFC refrigerant (R410A) which does not deplete the ozone layer.

- R410A refrigerant is vulnerable to impurities such as water, oxidizing membranes, or oils because the pressure of R410A refrigerant is higher than that of the former refrigerant by approximately 1.6 times. As well as the adoption of the new refrigerant, the refrigerating oil has been also changed. Therefore, pay attention so that water, dust, former refrigerant, or refrigerating oil does not enter the refrigerating cycle of the new refrigerant air conditioner during installation.
- To prevent mixing of refrigerant or refrigerating oil, the size of the charge port of the main unit or connecting section of the installation tool differs to that of an air conditioner for the former refrigerant. Accordingly, exclusive tools are required for the new refrigerant (R410A) as shown below.
- For connecting pipes, use new and clean piping materials so that water or dust does not enter.

#### Required tools and cautions on handling

It is necessary to prepare the tools and parts for installation as described below. The tools and parts which will be newly prepared in the following items should be restricted to exclusive use.

##### Explanation of symbols

△: Newly prepared (It is necessary to use it exclusively with R410A, separately from those for R22 or R407C.)

⊙: Former tool is available.

Used tools	Usage	Proper use of tools/parts
Gauge manifold	Vacuuming, charging refrigerant and operation check	△ Exclusive to R410A
Charging hose		△ Exclusive to R410A
Charging cylinder	Charging refrigerant	Unusable (Use the Refrigerant charging balance.)
Gas leak detector	Checking gas leak	△ Exclusive to R410A
Vacuum pump	Vacuum drying	Usable if a counter-flow preventive adapter is attached
Vacuum pump with counterflow	Vacuum drying	⊙ R22 (Existing article)
Flare tool	Flare processing of pipes	⊙ Usable by adjusting size
Bender	Bending processing of pipes	⊙ R22 (Existing article)
Refrigerant recovery device	Recovering refrigerant	△ Exclusive to R410A
Torque wrench	Tightening flare nut	△ Exclusive to Ø12.7mm and Ø15.9mm
Pipe cutter	Cutting pipes	⊙ R22 (Existing article)
Refrigerant canister	Charging refrigerant	△ Exclusive to R410A Enter the refrigerate name for identification
Welding machine/Nitrogen gas cylinder	Welding of pipes	⊙ R22 (Existing article)
Refrigerant charging balance	Charging refrigerant	⊙ R22 (Existing article)

### 4 Selection of installation place

Upon customer's approval, install the air conditioner in a place which satisfies the following conditions:

- Place where it can be installed horizontally.
- Place which can reserve a sufficient service space for safe maintenance or checks.
- Place where there is no problem even if the drained water overflows.

Avoid the following places:

- Salty places (seaside area) or places with much gas sulfide (hot spring area) (If selecting such a place, special maintenance is required.)
- Places where oil (including machine oil), steam, oil smoke or corrosive gas is generated.
- Places where iron or other metal dust is present. If iron or other metal dust adheres to or collects on the interior of the air conditioner, it may spontaneously combust and start a fire.
- Places where an organic solvent is used.
- Chemical plants with a cooling system using liquid carbon dioxide.
- Places where a device generating high frequency (inverter, non-utility generator, medical apparatus, or communication equipment) is set. (Malfunction or abnormal control of the air conditioner, or interference to devices listed above may occur.)
- Places where discharged air from the outdoor unit blows against the windows of a neighbour's house.
- Places unable to bear the weight of the unit.
- Places with poor ventilation.

## ■ Installation space

Leave space necessary for running, installation and servicing.

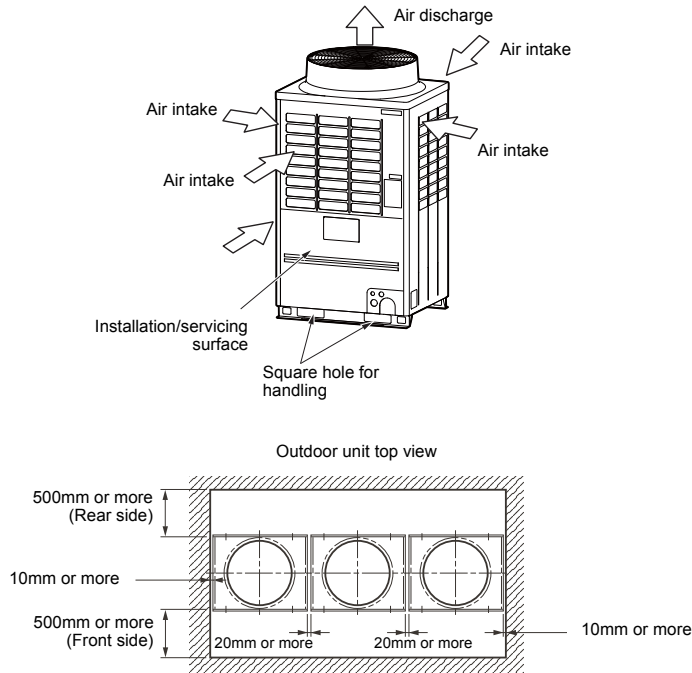

### NOTE

- If there is an obstacle above the outdoor unit, leave a space of 2000mm or more to the top end of the outdoor unit.
- If there is a wall around the outdoor unit, make sure that its height does not exceed 800mm.

## ▼ Combination of outdoor units

Model name (Standard type)	Cooperating outdoor unit		
	Unit 1	Unit 2	Unit 3
MMY-MAP0804*	MMY-MAP0804*	–	–
MMY-MAP1004*	MMY-MAP1004*	–	–
MMY-MAP1204*	MMY-MAP1204*	–	–
MMY-MAP1404*	MMY-MAP1404*	–	–
MMY-MAP1604*	MMY-MAP1604*	–	–
MMY-AP1814*	MMY-MAP1004*	MMY-MAP0804*	–
MMY-AP2014*	MMY-MAP1004*	MMY-MAP1004*	–
MMY-AP2214*	MMY-MAP1204*	MMY-MAP1004*	–
MMY-AP2414*	MMY-MAP1204*	MMY-MAP1204*	–
MMY-AP2614*	MMY-MAP1604*	MMY-MAP1004*	–
MMY-AP2814*	MMY-MAP1604*	MMY-MAP1204*	–
MMY-AP3014*	MMY-MAP1604*	MMY-MAP1404*	–
MMY-AP3214*	MMY-MAP1604*	MMY-MAP1604*	–
MMY-AP3414*	MMY-MAP1204*	MMY-MAP1204*	MMY-MAP1004*
MMY-AP3614*	MMY-MAP1204*	MMY-MAP1204*	MMY-MAP1204*
MMY-AP3814*	MMY-MAP1604*	MMY-MAP1204*	MMY-MAP1004*
MMY-AP4014*	MMY-MAP1604*	MMY-MAP1204*	MMY-MAP1204*
MMY-AP4214*	MMY-MAP1604*	MMY-MAP1404*	MMY-MAP1204*
MMY-AP4414*	MMY-MAP1604*	MMY-MAP1604*	MMY-MAP1204*
MMY-AP4614*	MMY-MAP1604*	MMY-MAP1604*	MMY-MAP1404*
MMY-AP4814*	MMY-MAP1604*	MMY-MAP1604*	MMY-MAP1604*

Model name (High Efficiency Model)	Cooperating outdoor unit			
	Unit 1	Unit 2	Unit 3	Unit 4
MMY-AP1624*	MMY-MAP0804*	MMY-MAP0804*	–	–
MMY-AP2424*	MMY-MAP0804*	MMY-MAP0804*	MMY-MAP0804*	–
MMY-AP2624*	MMY-MAP1004*	MMY-MAP0804*	MMY-MAP0804*	–
MMY-AP2824*	MMY-MAP1004*	MMY-MAP1004*	MMY-MAP0804*	–
MMY-AP3024*	MMY-MAP1004*	MMY-MAP1004*	MMY-MAP1004*	–
MMY-AP3224*	MMY-MAP0804*	MMY-MAP0804*	MMY-MAP0804*	MMY-MAP0804*
MMY-AP3424*	MMY-MAP1004*	MMY-MAP0804*	MMY-MAP0804*	MMY-MAP0804*
MMY-AP3624*	MMY-MAP1004*	MMY-MAP1004*	MMY-MAP0804*	MMY-MAP0804*
MMY-AP3824*	MMY-MAP1004*	MMY-MAP1004*	MMY-MAP1004*	MMY-MAP0804*
MMY-AP4024*	MMY-MAP1004*	MMY-MAP1004*	MMY-MAP1004*	MMY-MAP1004*
MMY-AP4224*	MMY-MAP1204*	MMY-MAP1004*	MMY-MAP1004*	MMY-MAP1004*
MMY-AP4424*	MMY-MAP1204*	MMY-MAP1204*	MMY-MAP1004*	MMY-MAP1004*
MMY-AP4624*	MMY-MAP1204*	MMY-MAP1204*	MMY-MAP1204*	MMY-MAP1004*
MMY-AP4824*	MMY-MAP1204*	MMY-MAP1204*	MMY-MAP1204*	MMY-MAP1204*

# 5 Carrying in the outdoor unit

## ⚠ CAUTION

Handle the outdoor unit carefully, observing the following items.

- When using a forklift or other machinery for loading/unloading in transportation, insert the prongs of the forklift into the rectangular holes for handling as shown below.
- When lifting up the unit, insert a rope able to bear the unit's weight into the rectangular holes for handling, and tie the unit from 4 sides.  
(Apply padding in positions where the rope comes into contact with the outdoor unit so that no damage is caused to the outer surface of the outdoor unit.)  
(There are reinforcing plates on the side surfaces, so the rope cannot be passed through.)

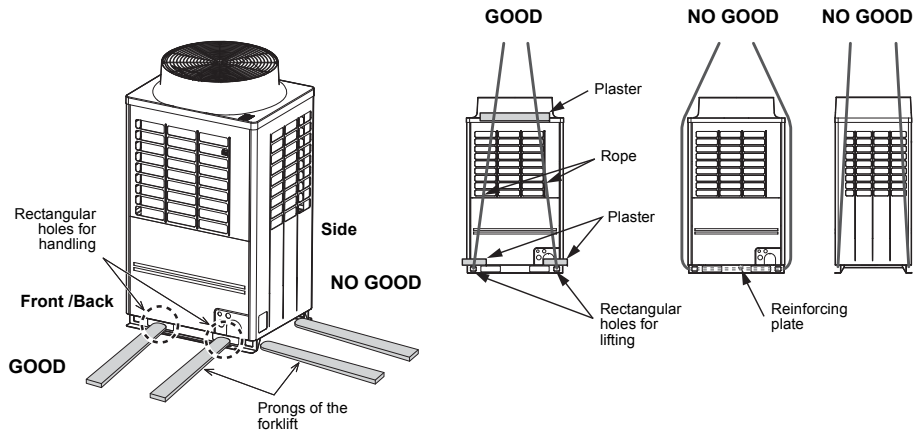

## ■ Weight centre and weight

### ◆ Weight centre of an outdoor unit

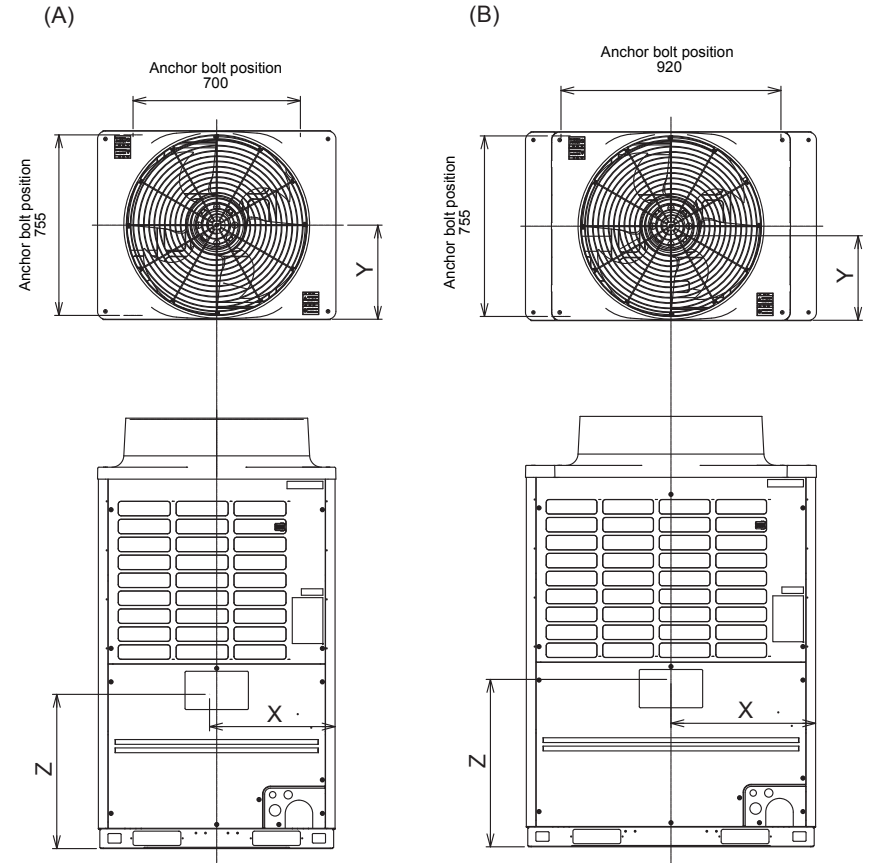

No.	Model type	X (mm)	Y (mm)	Z (mm)	Weight (kg)	
					Heat pump model	Cooling only model
(A)	MAP080	500	390	645	242	241
	MAP100					
	MAP120					
(B)	MAP140	605	350	700	329	329
	MAP160					



# 6 Installation of the outdoor unit

## WARNING

- **Be sure to install the outdoor unit in a place able to bear its weight.**  
If strength is insufficient, the unit may fall down resulting in human injury.
- **Perform specified installation work to protect against strong wind and earthquakes.**  
If the outdoor unit is imperfectly installed, an accident by falling or dropping may be caused.

## CAUTION

- Drain water is discharged from the outdoor unit. (Especially while heating)  
Install the outdoor unit in a place with good drainage.
- For installation, be careful of the strength and level of the foundation so that abnormal sounds (vibration or noise) are not generated.

## REQUIREMENT

### Installation in a snowfall area

1. Install the outdoor unit on a higher foundation than the snowfall or set up a stand to install the unit so that snowfall will not affect the unit.
  - Set up a stand higher than the snowfall.
  - Apply an angled structure to the stand so that drainage will not be prevented. (Avoid using a stand with a flat surface.)
2. Mount a snowfall-hood onto the air intake and the air discharge.
  - Leave enough space for the snowfall-hood so that it will not be an obstacle for the air intake and the air discharge.

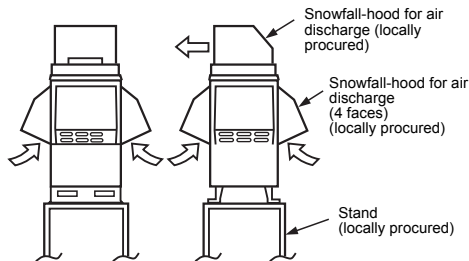

1. To install multiple outdoor units, arrange them with 20mm or more spaces in between. Fix each outdoor unit with M12 anchor bolts at 4 positions. 20mm projection is appropriate for an anchor bolt.

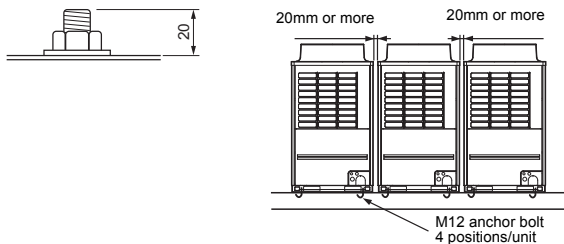

- Anchor bolt positions are as shown below:

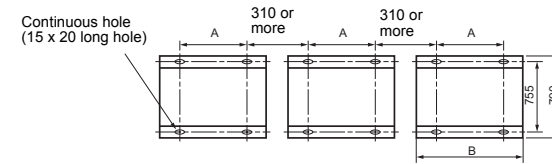

(Unit: mm)

Model type	A	B
MAP0804*, MAP1004*, MAP1204*	700	990
MAP1404*, 1604*	920	1210

2. When drawing out the refrigerant pipe from the underside, set the height of the stand to 500mm or more.

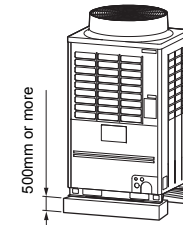

3. Do not use 4 stands on the corner to support the outdoor unit.

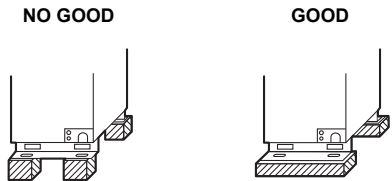

4. Mount the vibration-proof rubber (including vibration-proof blocks) so that it fits under the whole clamping leg.

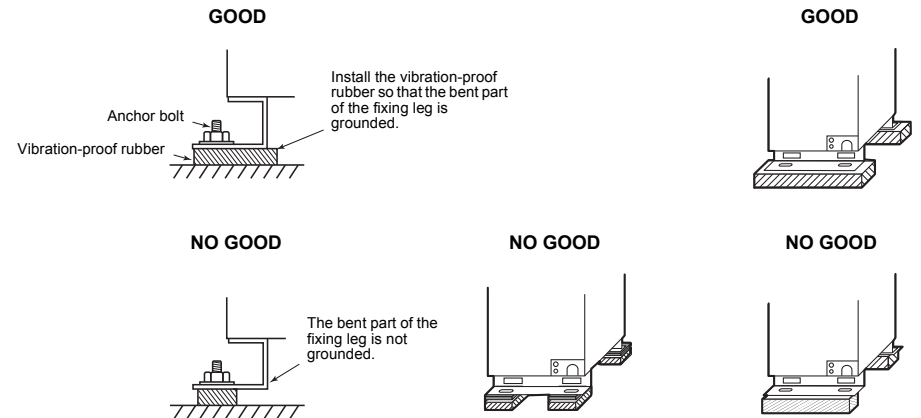

5. Be careful of the connecting arrangement of the header unit and follower units. Set the outdoor units in order of capacity from the one with the largest capacity. (A (Header unit) ≥ B ≥ C ≥ D)

- Be sure to use a header unit for the leading outdoor unit to be connected to the main pipe. (Figure 1 and 3)
- Be sure to use a T-shaped branch joint (RBM-BT14E/RBM-BT24E: separately purchased) to connect each outdoor unit.
- Be careful of the direction of the Outdoor unit connection piping kit for the liquid side. (As shown in Figure 2, a Outdoor unit connection piping kit cannot be attached so that the refrigerant of the main pipe flows directly into the header unit.)

**Liquid piping**

▼ Figure 1

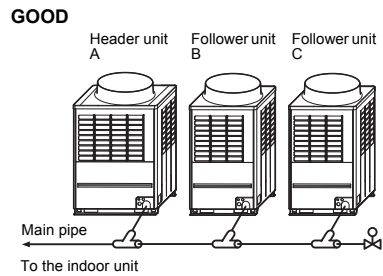

▼ Figure 2

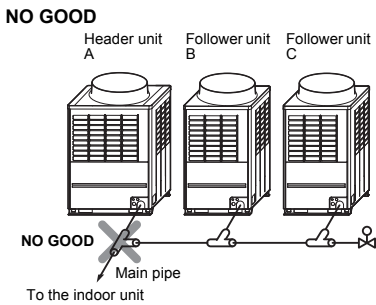

**Gas piping**

▼ Figure 3

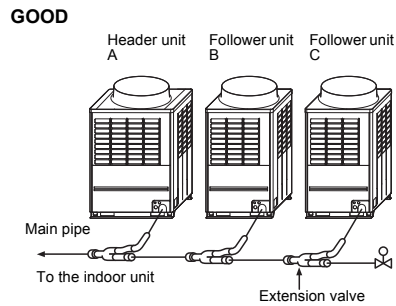

[Inverse connection of a gas-side branch unit]

▼ Figure 4

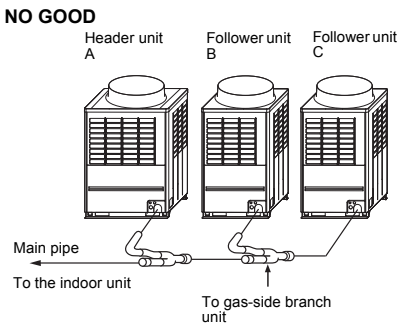

- When attaching a Y-shaped branch unit for the gas side, attach it level with the ground (Be sure not to exceed ±15 degrees.). Regarding a T-shape branch joints for the liquid side, there is no restriction for its angle.

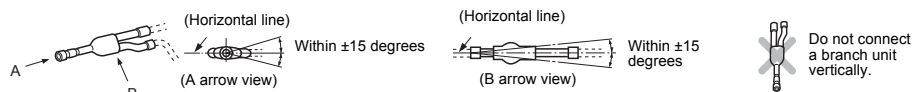

At a level position

**When drawing pipes downward**

▼ Figure 5

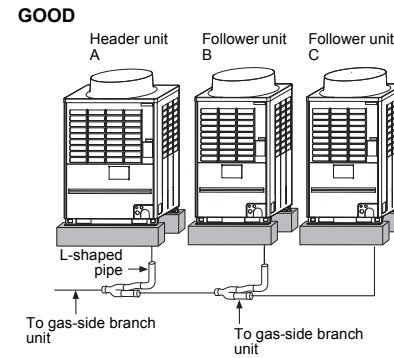

[Vertical connection of branch units]

▼ Figure 6

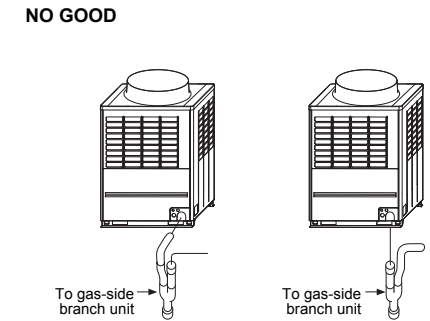

- Adding only one follower unit is possible. Install the additional unit so that its position is opposite to the header unit. Use an extension valve for installation (See the figure above.). Specify the pipe diameter in advance to allow for adding another unit.

# 7 Refrigerant piping

## ⚠ WARNING

- If the refrigerant gas leaks during installation, ventilate the room. If the leaked refrigerant gas comes into contact with fire, noxious gas may be generated.
- After installation, check that the refrigerant gas does not leak. If the refrigerant gas leaks into the room and comes into contact with fire such as a fan heater, stove, or kitchen range, noxious gas may be generated.

## ■ Connection of refrigerant pipe

- The refrigerant pipe connecting section is set in the outdoor unit. Remove the front panel and the piping/wiring panel. (M5: 9 pcs.)
  - As shown in the illustration on the right, the hooks are at the right and left sides of the front panel. Lift up and remove the front panel.
- Pipes can be drawn out forward or downward from the outdoor unit.
- When drawing out the pipe forward, draw it out to the outside via the piping/wiring panel, and leave a space of 500mm or more from the main pipe connecting the outdoor unit with the indoor unit, considering service work or other work on the unit. (For replacing the compressor, 500mm or more space is required.)
- When drawing out the pipe downward, remove the knockouts on the base plate of the outdoor unit, draw the pipes out of the outdoor unit, and perform piping on the right/left or rear side. Downward length of the balance pipe should be 5m or less.

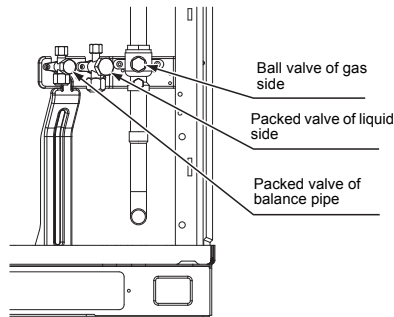
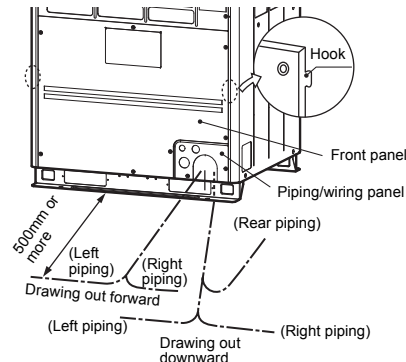

(MAP080, MAP100, MAP120)

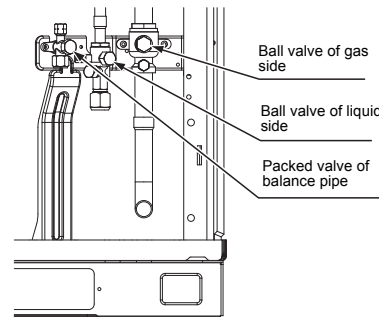

(MAP140, MAP160)

## REQUIREMENT

- For a welding work of the refrigerant pipes, be sure to use nitrogen gas in order to prevent oxidation of the inside of the pipes; otherwise clogging of the refrigerating cycle due to oxidized scale may occur.
- Use clean and new pipes for the refrigerant pipes and perform piping work so that water or dust does not contaminate the refrigerant.
- Be sure to use a double spanner to loosen or tighten the flare nut. If a single spanner is used, the required level of tightening cannot be obtained. Tighten the flare nut with the specified torque. (If it is hard to loosen or tighten the flare nut of the balance pipe or packed valve of the liquid side with a double spanner, loosen or tighten the flare nut while holding the valve mounting plate with a spanner.)

Outer dia. of copper pipe	Tightening torque (N·m)
6.4 mm	14 to 18 (1.4 to 1.8 kgf·m)
9.5 mm	33 to 42 (3.3 to 4.2 kgf·m)
12.7 mm	50 to 62 (5.0 to 6.2 kgf·m)
15.9 mm	63 to 77 (6.3 to 7.7 kgf·m)

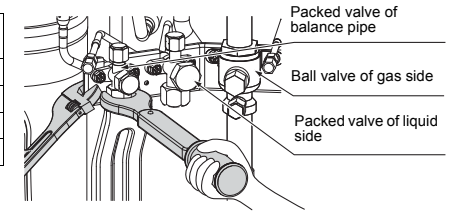

## Pipe connection method of valve at the gas side (Example)

Type	Pipe diameter	Draw-out forward	Draw-out downward
MAP080 MAP100	Ø22.2	<p>Cut the L-shaped pipe at the horizontal straight section, then braise the supplied attachment pipe and the socket and pipe procured locally.</p>	<p>Cut the L-shaped pipe at the vertical straight section, then braise the supplied attachment pipe and the socket and pipe procured locally.</p>
MAP120	Ø28.6	<p>Cut the L-shaped pipe at the horizontal straight section, then braise the supplied attachment pipe and the socket and pipe procured locally.</p>	<p>Cut the L-shaped pipe at the vertical straight section, then braise the supplied attachment pipe and the socket and pipe procured locally.</p>

Type	Pipe diameter	Draw-out forward	Draw-out downward
MAP140 MAP160	Ø28.6	<p>Cut the L-shaped pipe at the horizontal straight section, then braze the supplied attachment pipe, and the socket and pipe procured locally.</p>	<p>Cut the L-shape pipe at the vertical straight section, then braze the supplied attachment pipe, and the socket and pipe procured locally.</p>

**Extruding margin of copper pipe with flare machining: B (Unit: mm)**

Copper pipe outer dia.	When using R410A tool	When using conventional tool
9.5	0 to 0.5	1.0 to 1.5
12.7		
15.9		

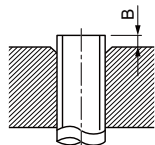

**Extruding margin of copper pipe with flare tools: A (Unit: mm)**

Copper pipe outer dia.	A <sup>+0.4</sup>
9.5	13.2
12.7	16.6
15.9	19.7

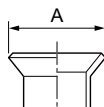

\* When using the conventional flare tool, to connect R410A pipes with flaring, make a margin approx. 0.5mm longer than that of an R22 pipe so that the flare size matches the one specified. It is convenient to use a copper pipe gauge for size adjustment of the extruding margin.

**CAUTION**

Wrap the ball valve in a wet cloth to keep it cool and prevent the heat from the torch from damaging it when connecting the pipe to the ball valve on the gas line.

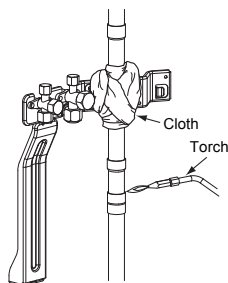

**Coupling size of brazed pipe**

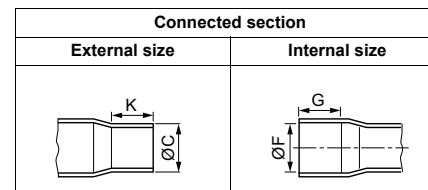

(Unit: mm)

Standard outer dia. of connected copper pipe	Connected section				Oval value	Min. thickness of coupling
	External size	Internal size	Min. depth of insertion			
	C	F	K	G		
6.35	6.35 (±0.03)	6.45 (+0.04/-0.02)	7	6	0.06 or less	0.50
9.52	9.52 (±0.03)	9.62 (+0.04/-0.02)	8	7	0.08 or less	0.60
12.70	12.70 (±0.03)	12.81 (+0.04/-0.02)	9	8	0.10 or less	0.70
15.88	15.88 (±0.03)	16.00 (+0.04/-0.02)	9	8	0.13 or less	0.80
19.05	19.05 (±0.03)	19.19 (+0.03/-0.03)	11	10	0.15 or less	0.80
22.22	22.22 (±0.03)	22.36 (+0.03/-0.03)	11	10	0.16 or less	0.82
28.58	28.58 (±0.04)	28.75 (+0.06/-0.02)	13	12	0.20 or less	1.00
34.92	34.90 (±0.04)	35.11 (+0.04/-0.04)	14	13	0.25 or less	1.20
38.10	38.10 (±0.05)	38.31 (+0.08/-0.02)	15	14	0.27 or less	1.26
41.28	41.28 (±0.05)	41.50 (+0.08/-0.02)	15	14	0.28 or less	1.35

**Selection of pipe size**

**Capacity code of indoor and outdoor units**

**Selection of pipe material**

- For the indoor unit, the capacity code is decided at each capacity rank. (Table 1)
- The capacity codes of the outdoor units are decided at each capacity rank. The maximum number of connectable indoor units and the total value of capacity codes of the indoor units are also decided. (Table 2)

**NOTE**

Compared with the capacity code of the outdoor unit, the total value of capacity codes of the connectable indoor units differs based on the height difference between the indoor units.

- When the height difference between the indoor units is 15m or less: Up to 135% of the capacity code (Equivalent to HP) of the outdoor unit (Equivalent to HP) of the outdoor unit
- When the height difference between the indoor units is over 15m: Up to 105% of the capacity code

**Table 1**

Indoor unit capacity rank	Capacity code	
	Equivalent to HP	Equivalent to capacity
007	0.8	2.2
009	1	2.8
012	1.25	3.6
015	1.7	4.5
018	2	5.6
024	2.5	7.1
027	3	8
030	3.2	9
036	4	11.2
048	5	14
056	6	16
072	8	22.4
096	10	28

**Table 2**

Outdoor unit model name (Standard model)	Capacity code		No. of indoor units	Outdoor unit model name (High Efficiency model)	Capacity code		No. of indoor units
	Equivalent to HP	Equivalent to capacity			Equivalent to HP	Equivalent to capacity	
MMY-MAP0804*	8	22.4	13	—	—	—	—
MMY-MAP1004*	10	28	16	—	—	—	—
MMY-MAP1204*	12	33.5	20	—	—	—	—
MMY-MAP1404*	14	40	23	—	—	—	—
MMY-MAP1604*	16	45	27	MMY-AP1624*	16	45	27
MMY-AP1814*	18	50.4	30	—	—	—	—
MMY-AP2014*	20	56	33	—	—	—	—
MMY-AP2214*	22	61.5	37	—	—	—	—
MMY-AP2414*	24	68	40	MMY-AP2424*	24	68	40
MMY-AP2614*	26	73	43	MMY-AP2624*	26	73	43
MMY-AP2814*	28	78.5	47	MMY-AP2824*	28	78.5	47
MMY-AP3014*	30	85	48	MMY-AP3024*	30	85	48
MMY-AP3214*	32	90	48	MMY-AP3224*	32	90	48
MMY-AP3414*	34	96	48	MMY-AP3424*	34	96	48
MMY-AP3614*	36	101	48	MMY-AP3624*	36	101	48
MMY-AP3814*	38	106.5	48	MMY-AP3824*	38	106.5	48
MMY-AP4014*	40	112	48	MMY-AP4024*	40	112	48
MMY-AP4214*	42	118	48	MMY-AP4224*	42	118	48
MMY-AP4414*	44	123	48	MMY-AP4424*	44	123	48
MMY-AP4614*	46	130	48	MMY-AP4624*	46	130	48
MMY-AP4814*	48	135	48	MMY-AP4824*	48	135	48

\* For combination of the outdoor units, refer to “Combination of outdoor units”.

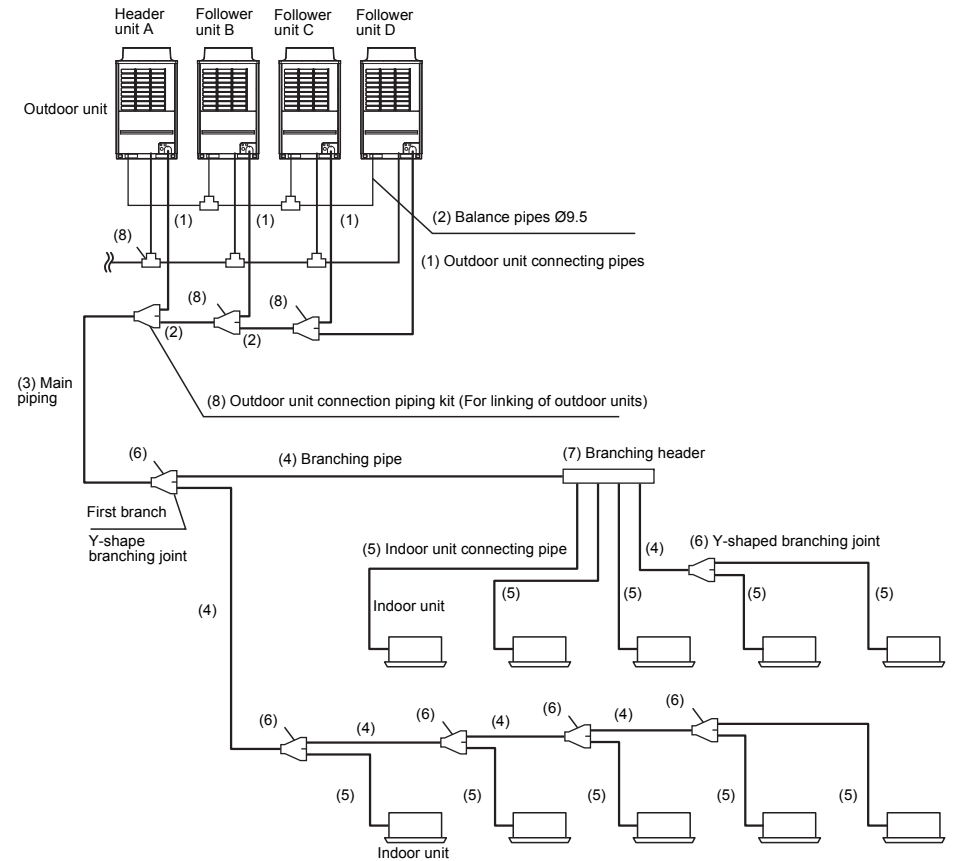

No.	Piping parts	Name	Selection of pipe size				Remarks	
(1)	Outdoor unit ↓ Outdoor unit connection piping kit	Outdoor unit connecting pipe	Connecting pipe size of outdoor unit				Same as connecting pipe size of the outdoor unit.	
			Type	Gas side	Liquid side			
			MAP080	Ø22.2	Ø12.7			
			MAP100	Ø22.2	Ø12.7			
			MAP120	Ø28.6	Ø12.7			
			MAP140	Ø28.6	Ø15.9			
(2)	Between Outdoor unit connection piping kits	Main connecting piping between outdoor units	Pipe size for connecting piping between outdoor units				Pipe size differs based on the total capacity code value of outdoor units at the downstream side. (See Table 2.)	
			Total capacity codes of outdoor units at the downstream side		Gas side	Liquid side		Balance pipe
			Equivalent to HP	Equivalent to capacity				
			16 to below 22	45.0 to below 61.5	Ø28.6	Ø15.9		Ø9.5
			22 to below 26	61.5 to below 73.0	Ø34.9	Ø19.1		
			26 to below 36	73.0 to below 101.0	Ø34.9	Ø19.1		
36 or more	101.0 or more	Ø41.3	Ø22.2					
(3)	Outdoor unit connection piping kit of header unit ↓ First branching section	Main piping	Size of main piping				Pipe size differs based on the capacity code of the outdoor unit. (See Table 2.)	
			Total capacity codes of all outdoor units		Gas side	Liquid side		
			Equivalent to HP	Equivalent to capacity				
			8 to below 12	22.4 to below 33.5	Ø22.2	Ø12.7		
			12 to below 14	33.5 to below 38.4	Ø28.6	Ø12.7		
			14 to below 22	38.4 to below 61.5	Ø28.6	Ø15.9		
(4)	Branching section ↓ Branching section	Branching pipe	Pipe size between branching sections *1				Pipe size differs based on the total capacity code value of indoor units at the downstream side. If the total value exceeds the capacity code of the outdoor unit, apply the capacity code of the outdoor unit. (See Table 1 and 2.)	
			Total capacity codes of indoor units at downstream side		Gas side	Liquid side		
			Equivalent to HP	Equivalent to capacity				
			Below 2.4	Below 6.6	Ø12.7	Ø9.5		
			2.4 to below 6.4	6.6 to below 18.0	Ø15.9	Ø9.5		
			6.4 to below 12.2	18.0 to below 34.0	Ø22.2	Ø12.7		
12.2 to below 20.2	34.0 to below 56.5	Ø28.6	Ø15.9					
20.2 to below 35.2	56.5 to below 98.5	Ø34.9	Ø19.1					
35.2 or more	98.5 or more	Ø41.3	Ø22.2					
*1: If exceeding the main pipe size, set the size to the same as the main pipe size.								

No.	Piping parts	Name	Selection of pipe size			Remarks		
(5)	Branching section ↓ Indoor unit	Indoor unit connecting pipe	Connecting pipe size of indoor unit			Same as connecting pipe size of the outdoor unit.		
			Capacity rank		Gas side		Liquid side	
			007 to 012 type	15m or less real length				Ø9.5
			015 to 018 type	Real length exceeds 15m	Ø12.7		Ø6.4	
			024 to 056 type		Ø15.9		Ø9.5	
			072 to 096 type		Ø22.2		Ø12.7	
(6)	Branching section	Y-shaped branching joint	Selection of branching section (Y-shaped branching joint)			Pipe size differs based on the total capacity code value of outdoor units at the downstream side. (See Table 2.)		
			Total capacity code of indoor units		Model name			
			Equivalent to HP	Equivalent to capacity				
			Y-shape branching joint	Below 6.4	Below 18.0		RBM-BY55E	
				6.4 to below 14.2	18.0 to below 40.0		RBM-BY105E	
				14.2 to below 25.2	40.0 to below 70.5		RBM-BY205E	
25.2 or more	70.5 or more	RBM-BY305E						
(7)	Branching section	Branching header	Selection of branching section (Branching header)			Pipe size differs based on the capacity code of the outdoor unit. (See Table 2.)		
			Total capacity code of indoor units		Model name			
			Equivalent to HP	Equivalent to capacity				
			*2 Branching header	For 4 branches	Below 14.2		Below 40.0	RBM-HY1043E
				For 8 branches	14.2 to below 25.2		40.0 to below 70.5	RBM-HY2043E
					Below 14.2		Below 40.0	RBM-HY1083E
14.2 to below 25.2	40.0 to below 70.5	RBM-HY2083E						
*2: Up to a total of 6.0 maximum equivalent to HP capacity codes is connectable to one line after branching of header. When the total capacity codes of all outdoor units are 12 to below 26 (equivalent to HP) and you use a branching header for the first branching section, use a RBM-HY2043E or RBM-HY2083E regardless of the total capacity codes of outdoor units at downstream side. In addition, you cannot use a branching header for the first branching section when the total capacity codes of all outdoor units are over 26 (equivalent to HP).								
(8)	Branching section	Outdoor unit connection piping kit (For linking of outdoor units)	Outdoor unit connection piping kit (For linking of outdoor units)			Pipe size differs based on the total capacity code value of indoor units at the downstream side. If the total value exceeds the capacity code of the outdoor unit, apply the capacity code of the outdoor unit. (See Table 1 and 2.)		
			Total capacity code of outdoor units *3		Model name			
			Equivalent to HP	Equivalent to capacity				
			Outdoor unit connection piping kit (For linking of outdoor units)	Below 26.0	Below 73.0		RBM-BT14E	
26.0 or more	Above 73.0	RBM-BT24E						
*3: Downstream side when regarding the main piping as the start point								

## ■ Allowable length of refrigerant pipes and allowable height difference between units

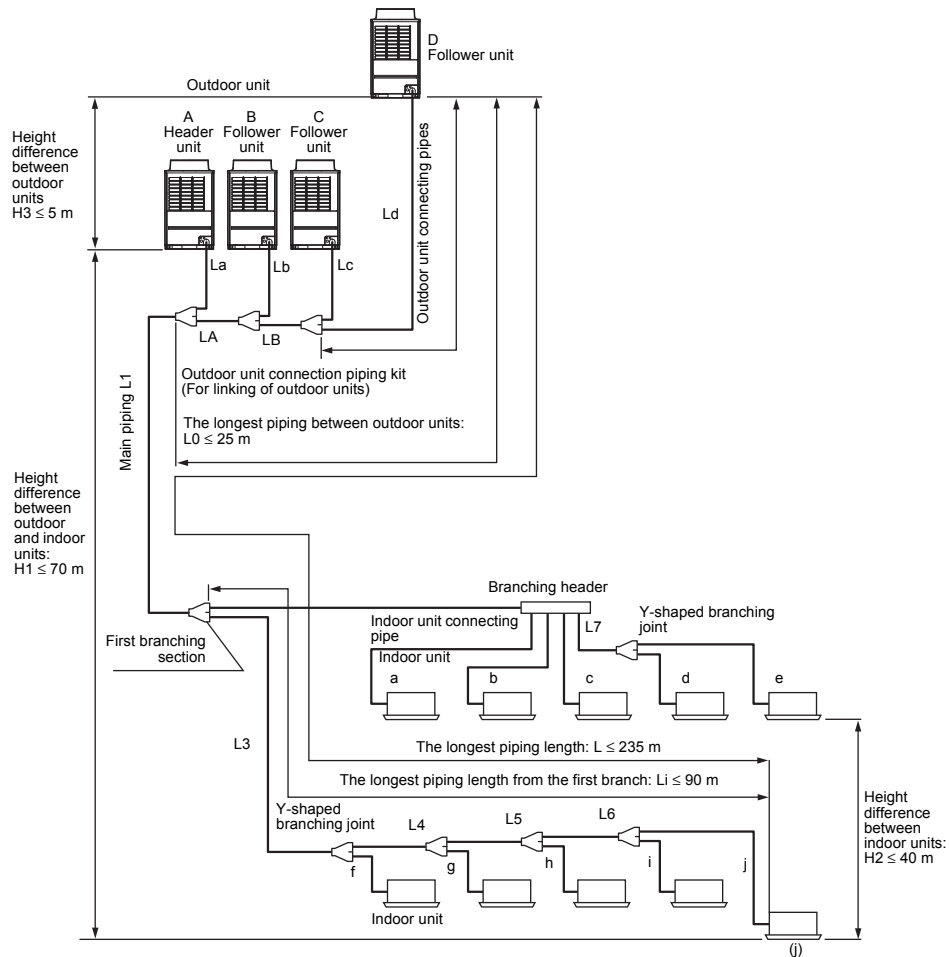

## ◆ System restriction

Outdoor unit combination	Up to 4 units	
Total capacity of outdoor units	Up to 48 HP	
Indoor unit connection	Up to 48 units	
Total capacity of indoor units (varies depending on the height difference between indoor units.)	$H2 \leq 15\text{ m}$	135% of outdoor units' capacity
	$15\text{ m} < H2$	105% of outdoor units' capacity

## ◆ Cautions for installation

- Set the outdoor unit first connected to the bridging pipe to the indoor units as the header unit.
- Install the outdoor units in order of their capacity codes: A (header unit)  $\geq B \geq C \geq D$
- When connecting gas pipes to indoor units, use Y-shaped branching joints to keep pipes level.
- When piping to outdoor units using Outdoor unit connection piping kits, intersect the pipes to the outdoor unit and those to indoor units at a right angle as shown in figure 1 on "6. Installation of the outdoor unit". Do not connect them as in figure 2 on "6. Installation of the outdoor unit".

## ◆ Allowable length and allowable height difference of refrigerant piping

Item		Allowable value	Pipes		
Pipe length	Total extension of pipe (liquid pipe, real length)	Less than 96kW	Less than 34HP or less	300m	$LA + LB + La + Lb + Lc + Ld + L1 + L2 + L3 + L4 + L5 + L6 + L7 + a + b + c + d + e + f + g + h + i + j$
		96kW or more	34HP or more	500m	
	Farthest piping length L (*1)	Equivalent length	235m	$LA + LB + Ld + L1 + L3 + L4 + L5 + L6 + j$	
		Real length	190m		
	Main piping length	Equivalent length	120m (*2)	L1	
		Real length	100m (*2)		
	Farthest equivalent piping length from the first branch $L_i$ (*1)		90m (*3)	$L3 + L4 + L5 + L6 + j$	
	Farthest equivalent piping length between outdoor units $L0$ (*1)		25m	$LA + LB + Ld$ ( $LA + Lb, LA + LB + Lc$ )	
	Maximum equivalent piping length of pipes connected to outdoor units		10m	$La, Lb, Lc, Ld$	
	Maximum real length of pipes connected to indoor units		30m	$a, b, c, d, e, f, g, h, i, j$	
Maximum equivalent length between branching sections		50m	$L2, L3, L4, L5, L6, L7$		
Height difference	Height between outdoor and indoor units $H1$	Upper outdoor units	70m (*4)	-	
		Lower outdoor units	40m (*5)	-	
	Height between indoor units $H2$		40m	-	
	Height between outdoor units $H3$		5m	-	

\*1: Farthest outdoor unit from the first branch: (D), farthest indoor unit: (j)

\*2: If the total capacity of outdoor units is 46HP or more, make the equivalent length 70m (real length 50m) or less.

\*3: Make the difference 65m or less if the height difference between outdoor and indoor units ( $H1$ ) is more than 3m.

\*4: Make the difference 50m or less if the height difference between indoor units ( $H2$ ) is more than 3m.

\*5: Make the difference 30m or less if the height difference between indoor units ( $H2$ ) is more than 3m.

## ■ Airtightness test

After the refrigerant piping has been finished, execute an airtight test.

For an airtight test, connect a nitrogen gas canister as shown in the figure on the next page and apply pressure.

- Be sure to apply pressure from the service ports of the packed valves (or ball valves) at the liquid side, gas side and balance pipe side.
- An airtight test can only be performed at the service ports at the liquid side, gas side and balance pipe side on header unit.
- Close the valves fully at the gas side, liquid side and balance pipe side. As there is a possibility that the nitrogen gas will enter into the cycle of outdoor units, re-tighten the valve rods at the liquid side and balance pipe side before applying pressure.  
(When using MAP140 or MAP160, you do not have to re-tighten the liquid side valve rod as their valves at the liquid side are ball valves.)
- For each refrigerant line, apply pressure gradually in steps at the liquid side, gas side and balance pipe side.  
**Be sure to apply pressure at the gas side, liquid side, and balance pipe side.**

### WARNING

Never use oxygen, flammable gases, or noxious gases in an airtight test.

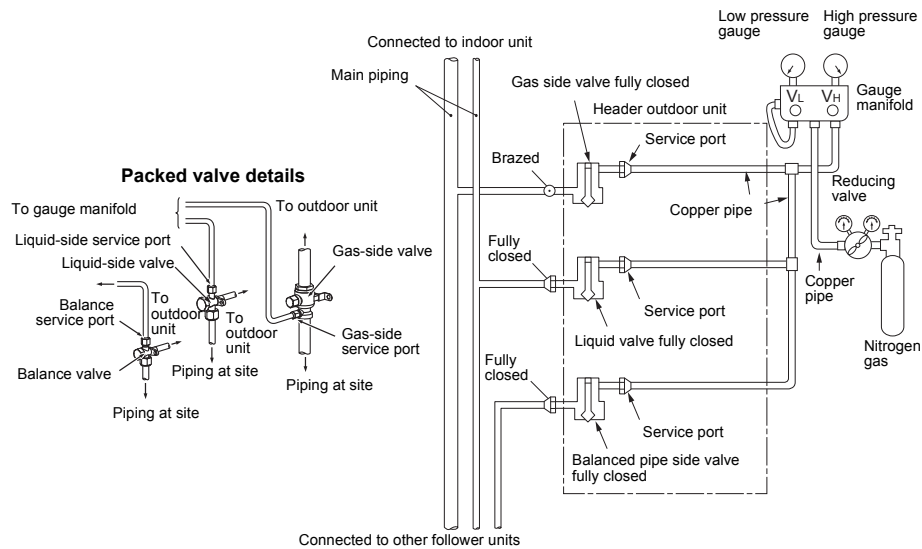

### Able to detect a serious leakage

1. Apply pressure 0.3MPa (3.0kg/cm<sup>2</sup>G) for 5 minutes or more.
2. Apply pressure 1.5MPa (15kg/cm<sup>2</sup>G) for 5 minutes or more.

### Available to detect slow leakage

3. Apply pressure 3.73MPa (38kg/cm<sup>2</sup>G) for approx. 24 hours.

- If there is no pressure decrease after 24 hours, the test is passed.

### NOTE

However, if the environmental temperature changes from the moment of applying pressure to 24 hours after that, the pressure will change by about 0.01MPa (0.1kg/cm<sup>2</sup>G) per 1°C. Consider the pressure change when checking the test result.

### REQUIREMENT

When pressure decrease is detected in steps 1-3, check the leakage at the connecting points. Check the leakage using a foaming agent or other measures and seal the leak with re-brazing, flare retightening or other methods. After sealing, execute an airtight test again.



## ■ Vacuum drying

- Be sure to perform vacuuming from both liquid and gas sides.
- Be sure to use a vacuum pump equipped with the counter-flow prevention function so that oil in the pump will not flow back into piping for air conditioners. (If oil in the vacuum pump enters in the air conditioner with R410A refrigerant, a problem may be caused in the refrigerating cycle.)

After finishing the airtight test and discharging nitrogen gas, connect the gauge manifold to the service ports of the liquid side, gas side, and balance pipe side and connect a vacuum pump as shown in the figure below. Be sure to perform vacuuming for the liquid, gas, and balance pipe sides.

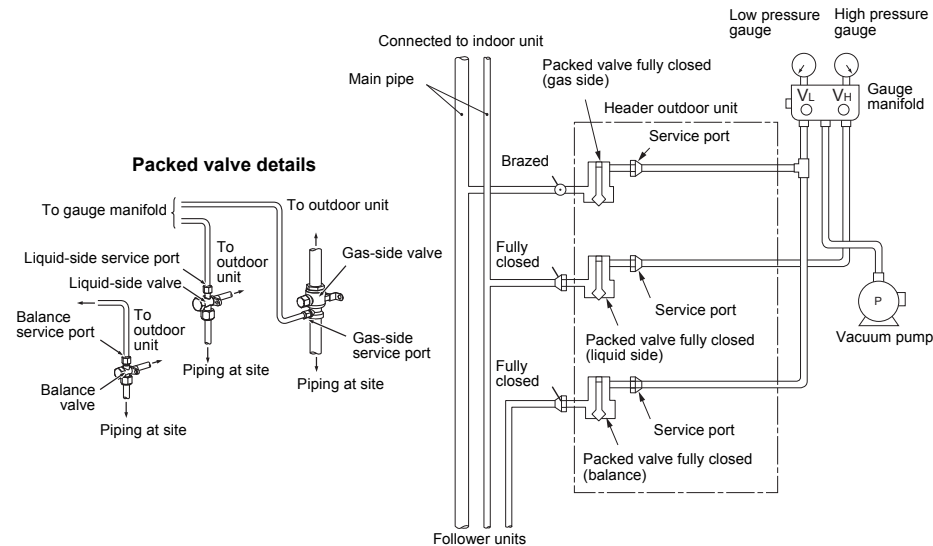

- Use a vacuum pump with a high vacuuming degree [-100.7kPa (5Torr, -755mmHg)] and large exhaust gas amount (40L/minute or larger).
- Perform vacuuming for 2 or 3 hours, though the time differs depending on the pipe length. Check that all the packed valves at the liquid side, gas side, and balance pipe side are fully closed.
- If the pressure does not reach -100.7kPa or less, continue vacuuming for 1 hour or more. If the pressure does not reach -100.7kPa after 3 hours of vacuuming, stop vacuuming and check for air leakage.
- If the pressure reaches -100.7kPa or less after vacuuming for 2 hours or more, close the valves VL and VH on the gauge manifold fully and stop the vacuum pump. Leave it as it is for 1 hour to confirm that the vacuuming degree does not change.  
If the degree of vacuum loss is large, moisture may remain in the pipes. In that case, inject dry nitrogen gas and apply pressure to 0.05MPa and perform vacuuming again.
- After finishing the above procedure of vacuuming, exchange the vacuum pump with a refrigerant canister and advance to the additional charging of refrigerant.

## ■ Adding refrigerant

After finishing vacuuming, exchange the vacuum pump with a refrigerant canister and start additional charging of refrigerant.

### Calculation of additional refrigerant charge amount

Refrigerant charge amount at shipment from the factory does not include the refrigerant for pipes at the local site. For refrigerant to be charged in pipes at the local site, calculate the amount and charge it additionally.

#### NOTE

If the additional refrigerant amount indicates minus as the result of calculation, use the air conditioner without additional refrigerant.

Heat pump type	Outdoor unit type	MAP080	MAP100	MAP120	MAP140	MAP160
	Charging amount (kg)	11.5				

Cooling only type	Outdoor unit type	MAP080	MAP100	MAP120	MAP140	MAP160
	Charging amount (kg)	10.5	10.5	10.5	11.5	11.5

$$\text{Additional refrigerant charge amount at local site} = \text{Real length of liquid pipe} \times \text{Additional refrigerant charge amount per 1m liquid pipe (Table 1)} + \text{Corrective amount of refrigerant depending on HP of co-operating outdoor units (Table 2)}$$

Table 1

Liquid pipe dia. (mm)	6.4	9.5	12.7	15.9	19.1	22.2
Additional refrigerant amount/1m liquid pipe (kg/m)	0.025	0.055	0.105	0.160	0.250	0.350

Table 2

	Combined HP (HP)		Combined outdoor units (HP)			C (Corrective amount of refrigerant) (kg)
Standard type	8	8HP	-	-	-	1.5
	10	10HP	-	-	-	2.5
	12	12HP	-	-	-	3.5
	14	14HP	-	-	-	8.5
	16	16HP	-	-	-	10.5
	18	10HP	8HP	-	-	0.0
	20	10HP	10HP	-	-	3.0
	22	12HP	10HP	-	-	5.0
	24	12HP	12HP	-	-	7.5
	26	16HP	10HP	-	-	8.5
	28	16HP	12HP	-	-	9.5
	30	16HP	14HP	-	-	11.5
	32	16HP	16HP	-	-	12.5
	34	12HP	12HP	10HP	-	3.0
	36	12HP	12HP	12HP	-	4.0
	38	16HP	12HP	10HP	-	6.0
	40	16HP	12HP	12HP	-	7.0
	42	16HP	14HP	12HP	-	8.0
44	16HP	16HP	12HP	-	10.0	
46	16HP	16HP	14HP	-	12.0	
48	16HP	16HP	16HP	-	14.0	
High Efficiency type	16	8HP	8HP	-	-	0.0
	24	8HP	8HP	8HP	-	-4.0
	26	10HP	8HP	8HP	-	-4.0
	28	10HP	10HP	8HP	-	-2.0
	30	10HP	10HP	10HP	-	0.0
	32	8HP	8HP	8HP	8HP	-6.0
	34	10HP	8HP	8HP	8HP	-6.0
	36	10HP	10HP	8HP	8HP	-6.0
	38	10HP	10HP	10HP	8HP	-6.0
	40	10HP	10HP	10HP	10HP	-5.0
	42	12HP	10HP	10HP	10HP	-4.0
	44	12HP	12HP	10HP	10HP	-2.0
46	12HP	12HP	12HP	10HP	0.0	
48	12HP	12HP	12HP	12HP	2.0	

**Charging of refrigerant**

- Keeping the valve of the outdoor unit closed, be sure to charge the liquid refrigerant into the service port at the liquid side.
- If the specified amount of refrigerant cannot be charged, fully open the valves of the outdoor unit at liquid and gas sides, operate the air conditioner in COOL mode, and then charge refrigerant into service port at the gas side. In this time, choke the refrigerant slightly by operating the valve of the canister to charge liquid refrigerant.
- The liquid refrigerant may be charged suddenly, therefore be sure to charge refrigerant gradually.

**Full opening of the valve**

Open the valves of the outdoor unit fully.

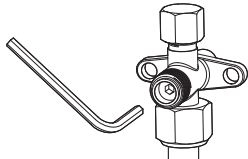
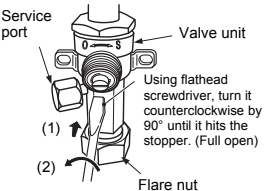
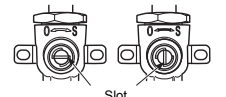
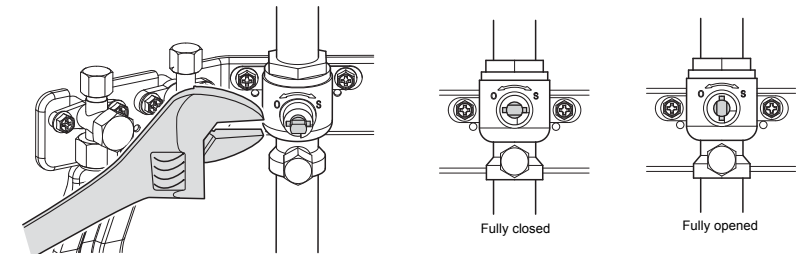
	MAP080 MAP100 MAP120	MAP140 MAP160
Liquid side	<p><b>Packed valve</b> Using a 4mm-hexagonal wrench, fully open the valve rods.</p> 	<p><b>Ball valve</b> Using a flathead screwdriver, turn it counterclockwise by 90° until it hits the stopper. (Full open)</p>  <p><b>Position of screwdriver slot</b> Fully closed    Fully opened</p>  <p>* When opened fully, do not apply excessive torque after the screwdriver hits the stopper; otherwise a problem may be caused on the valve. (5 N·m or less)</p>
Balance pipe	<p><b>Balance packed valve</b> Using a 4mm-hexagonal wrench, fully open the valve rods.</p>	
Gas side	<p><b>Ball valve</b> Using a wrench, turn it counterclockwise by 90° until it hits the stopper. (Full open)</p> 	

## ■ F-GAS label

This product contains fluorinated greenhouse gases covered by the Kyoto Protocol

- Chemical Name of Gas R410A
- Global Warming Potential (GWP) of Gas 1975

### ⚠ CAUTION

1. Stick the enclosed refrigerant label adjacent to the charging and/or recovering location.
2. Clearly write the charged refrigerant quantity on the refrigerant label using indelible ink. Then, place the included transparent protective sheet over the label to prevent the writing from rubbing off.
3. Prevent emission of the contained fluorinated greenhouse gas. Ensure that the fluorinated greenhouse gas is never vented to the atmosphere during installation, service or disposal. When any leakage of the contained fluorinated greenhouse gas is detected, the leak shall be stopped and repaired as soon as possible.
4. Only qualified service personnel are allowed to access and service this product.
5. Any handling of the fluorinated greenhouse gas in this product, such as when moving the product or recharging the gas, shall comply under (EC) Regulation No. 842/2006 on certain fluorinated greenhouse gases and any relevant local legislation.
6. Periodical inspections for refrigerant leaks may be required depending on European or local legislation.
7. Contact dealers, installers, etc., for any questions.

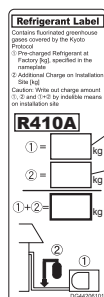

Pre-charged Refrigerant at Factory [kg], specified in the nameplate

Additional Charge on Installation Site [kg]

## ■ Heat insulation for pipe

- Apply heat insulation of pipe separately at the liquid, gas, and balance sides.
- Be sure to use thermal insulator resistant up to 120°C or higher for pipes at the gas side.

## ■ Finishing after connecting pipes

- After piping connection work has been finished, cover the opening of the piping/wiring panel with the piping cover, or fill silicon or putty into the space between the pipes.
- In case of drawing-out the pipes downward or sideward, also close the openings of the base plate and the side plate.
- Under the opened condition, a problem may be caused due to the entering of water or dust.

### When using the piping cover

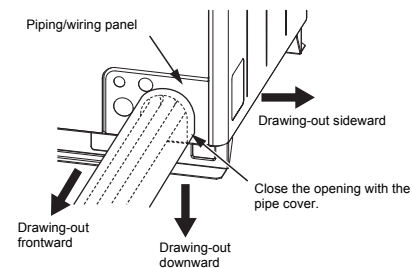

### When not using the piping cover

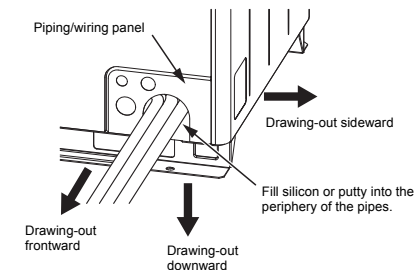

## ◆ Pipe holding bracket

Attach pipe holding brackets following the table below.

Diameter of pipe (mm)	Interval
Ø15.9 - Ø19.1	2m
Ø22.2 - Ø41.3	3m

# 8 Electric wiring

## ⚠ WARNING

The appliance shall be installed in accordance with national wiring regulations. Capacity shortages of the power circuit or an incomplete installation may cause an electric shock or fire.

## ⚠ CAUTION

- Perform wiring of power supply complying with the rules and regulations of the local electric company.
- Do not connect 380V - 415V power to the terminal blocks for control cables (U1, U2, U3, U4, U5, U6); otherwise, the unit may break down.
- Be sure that electric wiring does not come into contact with high-temperature parts of piping; otherwise, the coating of cables may melt and cause an accident.
- After connecting wires to the terminal block, take off the traps and fix the wires with cord clamps.
- Follow the same structure for both the control wiring and refrigerate piping.
- Do not conduct power to indoor units until vacuuming of the refrigerant pipes has finished.
- For the wiring of power to indoor units and that between indoor and outdoor units, follow the instructions in the installation manual of each indoor unit.

## ■ Power supply specifications

Do not bridge the power between outdoor units through the equipped terminal blocks (L1, L2, L3, N).

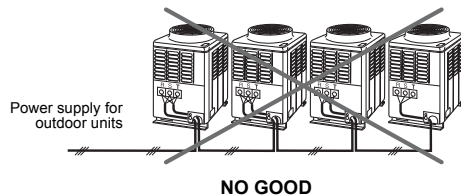

## ◆ Power wiring selection

- Select the power supply cabling of each outdoor unit from the following specifications: Cable 5-core, in conformance with design H07 RN-F or 60245 IEC 66.
- To decide nominal cross sectional area of conductor, refer to following table of Maximum Overcurrent Protection (Amps).

### Standard model

MCA: Minimum Circuit Amps  
MOCP: Maximum Overcurrent Protection (Amps)

Model	Power Supply		MCA (A)	MOCP (A)
	Phase and frequency	Nominal Voltage		
MMY-MAP0804* MMY-MAP1004* MMY-MAP1204* MMY-MAP1404* MMY-MAP1604*	3N~ 50Hz	380-400-415V	23.5 25.5 28.5 33.2 36.5	32 32 40 40 50
MMY-AP1814* MMY-AP2014* MMY-AP2214* MMY-AP2414* MMY-AP2614* MMY-AP2814* MMY-AP3014* MMY-AP3214*	3N~ 50Hz	380-400-415V	49.0 51.0 54.0 57.0 62.0 65.0 69.7 73.0	63 63 63 63 80 80 80 100
MMY-AP3414* MMY-AP3614* MMY-AP3814* MMY-AP4014* MMY-AP4214* MMY-AP4414* MMY-AP4614* MMY-AP4814*	3N~ 50Hz	380-400-415V	82.5 85.5 90.5 93.5 98.2 101.5 106.2 109.5	100 100 100 125 125 125 125 125

### High efficiency model

Model	Phase and frequency	Nominal Voltage	MCA (A)	MOCP (A)
MMY-AP1624*	3N~ 50Hz	380-400-415V	46.9	63
MMY-AP2424* MMY-AP2624* MMY-AP2824* MMY-AP3024*	3N~ 50Hz	380-400-415V	70.4 72.4 74.5 76.5	80 80 100 100
MMY-AP3224* MMY-AP3424* MMY-AP3624* MMY-AP3824* MMY-AP4024* MMY-AP4224* MMY-AP4424* MMY-AP4624* MMY-AP4824*	3N~ 50Hz	380-400-415V	93.8 95.9 97.9 100.0 102.0 105.0 108.0 111.0 114.0	125 125 125 125 125 125 125 125 125

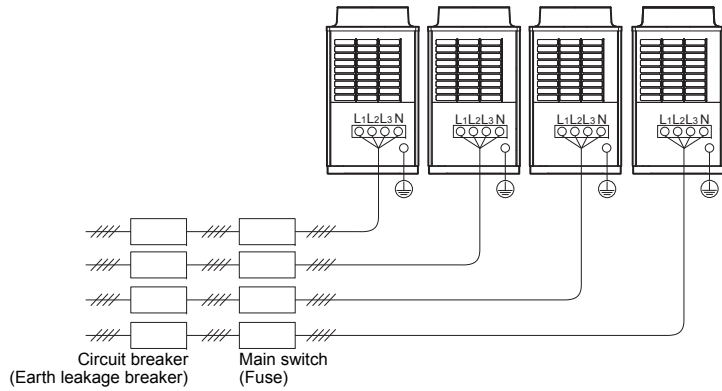

## ■ Specifications for communication wiring

### ◆ Design of communication wiring

#### Summary of communication wiring

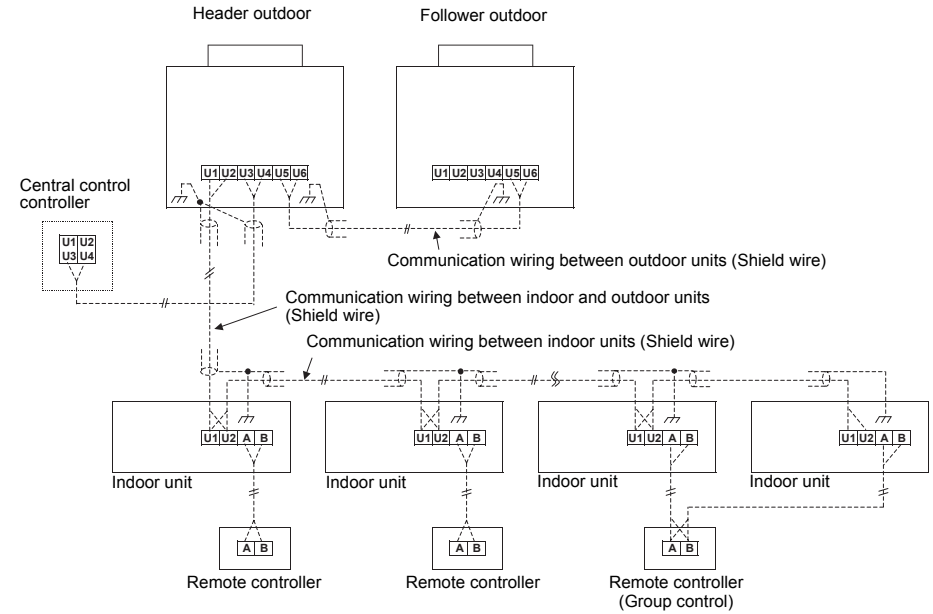

- Communication wiring and central control wiring use 2-core non-polarity wires. Use 2-core shield wires to prevent noise trouble. In this case, both ends of the communication wire must be grounded.
- Use 2-core non-polarity wire for remote controller. (A, B terminals)
- Use 2-core non-polarity wire for wiring of group control. (A, B terminals)

Be sure to keep the rule of below tables about size and length of communication wiring.

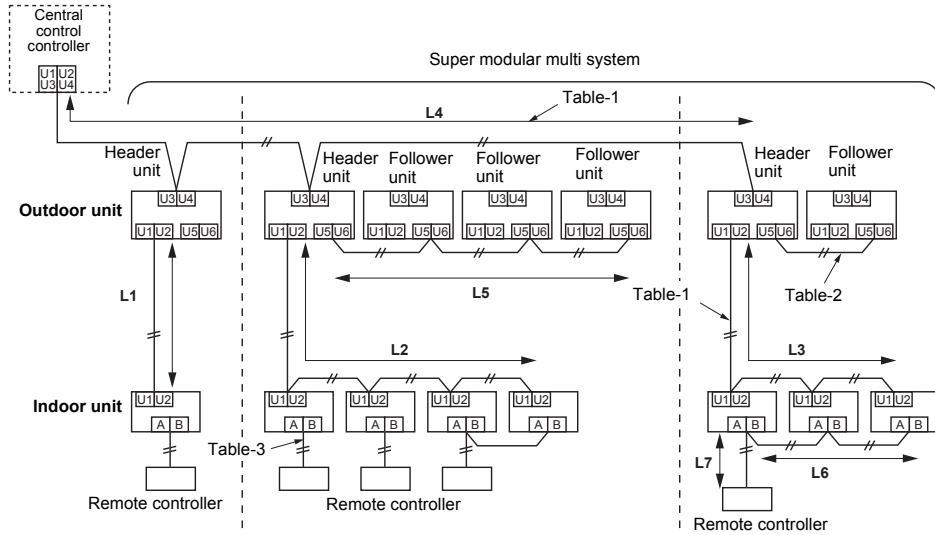

**Table-1 Communication wiring between indoor and outdoor units (L1, L2, L3), Central control wiring (L4)**

Wiring	2-core, non-polarity
Type	Shield wire
Size/Length	1.25 mm <sup>2</sup> : Up to 1000 m/2.0 mm <sup>2</sup> : Up to 2000 m (*1)

(\*1): Total length of Communication wiring length for all refrigerant circuits (L1 + L2 + L3 + L4)

**Table-2 Communication wiring between outdoor units (L5)**

Wiring	2-core, non-polarity
Type	Shield wire
Size/Length	1.25 mm <sup>2</sup> to 2.0 mm <sup>2</sup> /Up to 100 m (L5)

**Table-3 Remote controller wiring (L6, L7)**

Wire	2-core, non-polarity
Size	0.5 mm <sup>2</sup> to 2.0 mm <sup>2</sup>
Length	<ul style="list-style-type: none"> <li>Up to 500 m (L6 + L7)</li> <li>Up to 400 m in case of wireless remote controller in group control.</li> <li>Up to 200 m total length of communication wiring between indoor units (L6)</li> </ul>

### ◆ Group control through a Remote Controller

Group control of multiple indoor units (8 units) through a single remote controller switch

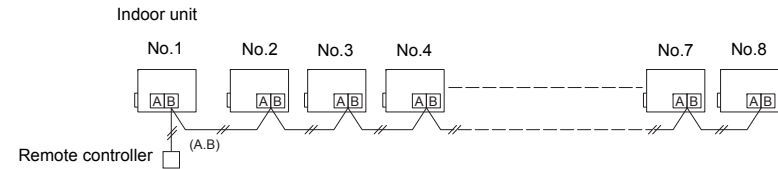

### ■ Connection of power wires and communication wires

Remove knockouts on the piping/wiring panel on the front of the unit and the panel on the bottom to get the power and communication wires through the holes.

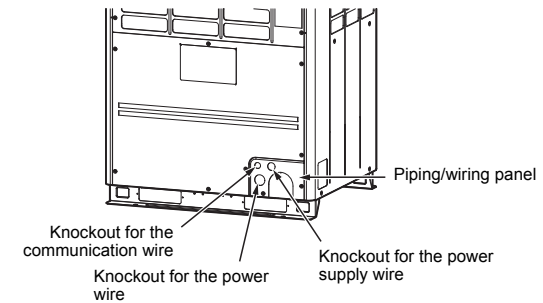

**NOTE**

Be sure to separate the power wire and communication wires.

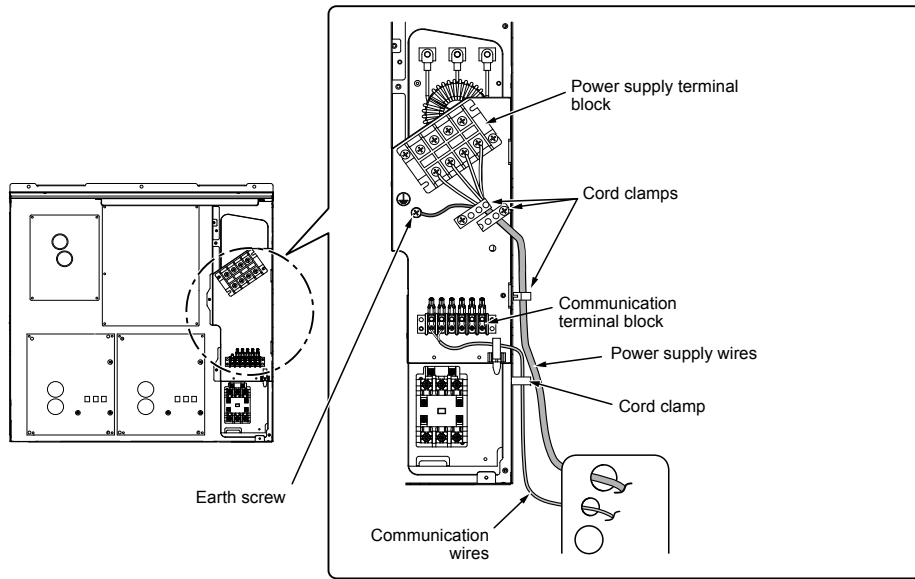

### ◆ Power supply wire connection

1. Insert the power supply wire through the cutout on the side of the electrical control box and connect the power supply wire to the power supply terminal block and the earth line to the earth screw. After that, fix the power supply wire with the 2 cord clamps.
2. Be sure to use round-type crimping terminals for power connection. Also, apply insulating sleeves to the crimping parts. Use a driver of appropriate size to fix the terminal screws.

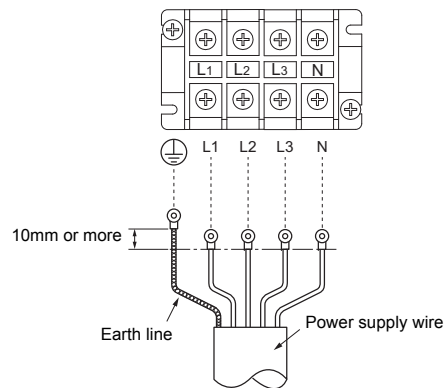

### Screw size and tightening torque

	Screw size	Tightening torque (N•m)
Power supply terminal	M6	2.5 to 3.0
Earth screw	M8	5.5 to 6.6

### ◆ Communication wire connection

Get the communication wire through the cutout on the side of the electrical control box and connect it to the communication wire terminals, then fix it with the communication cable clamp.

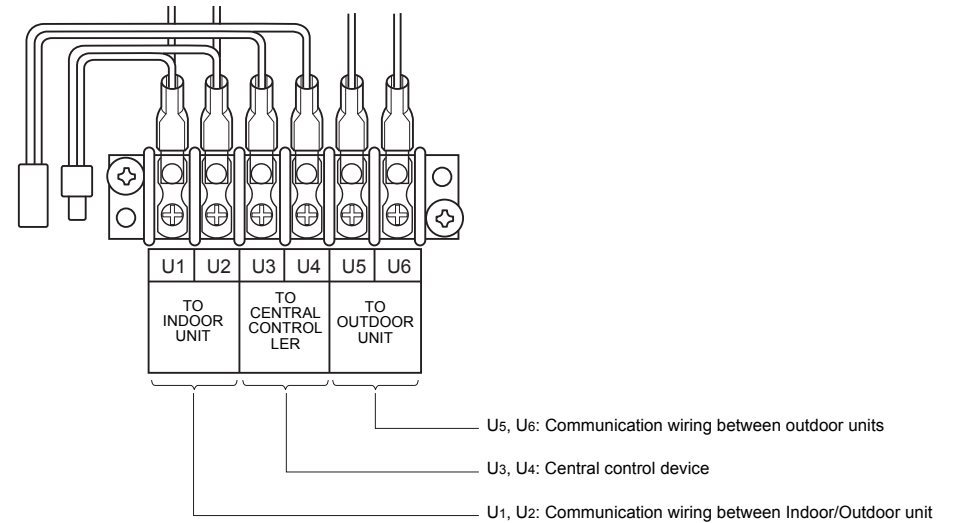

### Screw size and tightening torque

	Screw size	Tightening torque (N•m)
Communication wire terminal	M4	1.2 to 1.4

## ■ Regulation of high frequency wave

This equipment complies with IEC 61000-3-12 provided that the short-circuit power  $S_{sc}$  is greater than or equal to  $S_{sc}^{(*)}$  at the interface point between the user's supply and the public system. It is the responsibility of the installer or user of the equipment to ensure, by consultation with the distribution network operator if necessary, that the equipment is connected only to a supply with a short-circuit power  $S_{sc}$  greater than or equal to  $S_{sc}^{(*)}$

Furthermore, when similar equipment or other equipment which may cause harmonic current emissions are to be connected to the same interface point with this equipment, to reduce the risk of possible problems which may be caused from addition of those harmonic current emissions, it is recommended to make sure that the short-circuit power  $S_{sc}$  at the interface point is greater than the sum of the minimum  $S_{sc}$  required by all the equipment which will be connected to the interface point.

$S_{sc}^{(*)}$

Model	$S_{sc}$ (kVA)
MMY-MAP0804HT8P(JP)-E MMY-MAP0804T8P(JP)-E	1004
MMY-MAP1004HT8P(JP)-E MMY-MAP1004T8P(JP)-E	1290
MMY-MAP1204HT8P(JP)-E MMY-MAP1204T8P(JP)-E	1560
MMY-MAP1404HT8P(JP)-E MMY-MAP1404T8P(JP)-E	1692
MMY-MAP1604HT8P(JP)-E MMY-MAP1604T8P(JP)-E	1942

## 9 Address setting

**On this unit, it is required to set the addresses of the indoor units before starting air conditioning. Set the addresses following the steps below.**

### ⚠ CAUTION

- Be sure to complete the electric wiring before setting the addresses.
- If you turn on the outdoor unit before turning on the indoor units, the CODE No. [E19] is indicated on the 7-segment display on the interface P.C. board of the outdoor unit until the indoor units are turned on. This is not a malfunction.
- It may take up to ten minutes (normally about five minutes) to address one refrigerant line automatically.
- Settings on the outdoor unit are required for automatic addressing. (Address setting is not started simply by turning on the power.)
- Running the unit is not required for address setting.
- The addresses can be set manually.

Automatic addressing: setting addresses using SW15 on the interface P.C. board on the header outdoor unit  
 Manual addressing: setting addresses on the wired remote controller.

\* When setting an address manually, the wired remote controller must temporarily be paired with an indoor unit one-to-one. (when the system is organized for group operation and no Remote controller)

### REQUIREMENT

- High voltage parts exist in the electrical control box. If you set addresses on an outdoor unit, operate the unit through the access door shown on the illustration on the right to avoid electric shock. Do not remove the cover of electrical control box.
- \* After finishing operations, close the access door cover and fix it with the screw.

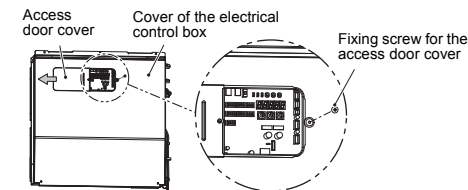

## ■ Automatic address setting

No central control: go to Address setting procedure 1  
 Central control of 2 or more refrigerant lines: go to Address setting procedure 2

(Example)	When controlling a single refrigerant line centrally	When controlling 2 or more refrigerant lines centrally
Address setting procedure	To procedure 1	To procedure 2
System wiring diagram		



### ◆ Address setting procedure 1

- 1 Turn on indoor units first, and then turn on outdoor units.
- 2 About one minute after turning the power on, confirm that the 7-segment display on the interface P.C. board of the header outdoor unit indicates **U. 1. L08 (U. 1. flash)**.
- 3 Press SW 15 to start the automatic address setting.  
(It may take up to 10 minutes (normally about 5 minutes) to complete one line's setting.)
- 4 The 7-segment display indicates **Auto 1 → Auto 2 → Auto 3**.  
After the indication, **U. 1. --- (U. 1. flash)** starts flashing on the display.  
When the flashing stops and **U. 1. --- (U. 1. light)** remain lit on the display, the setting is complete.

#### Interface P.C. board on the header outdoor unit

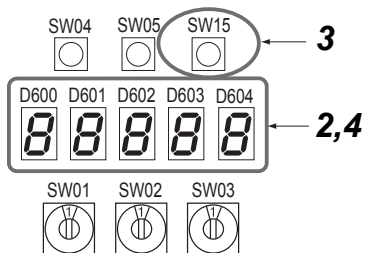

#### REQUIREMENT

- When 2 or more refrigerant lines are controlled as a group, be sure to turn on all the indoor units in the group before setting addresses.
- If you set the unit addresses of each line separately, each line's header indoor unit is set separately. In that case, the CODE No. "L03" (Indoor header unit overlap) is indicated as running starts. Change the group address to make one unit the header unit using wired remote controller.

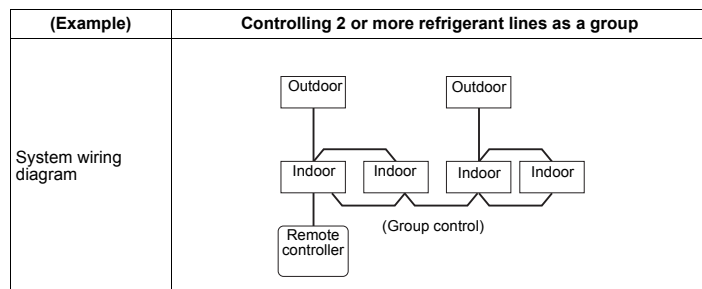

### ◆ Address setting procedure 2

- 1 Set a system address for each system using SW 13 and 14 on the interface P.C. board on the header outdoor unit of each system.  
(Factory default: Address 1)

#### NOTE

Be sure to set a unique address on each system. Do not use a same address as another system (refrigerant line) or a custom side.

#### Interface P.C. board on the header outdoor unit

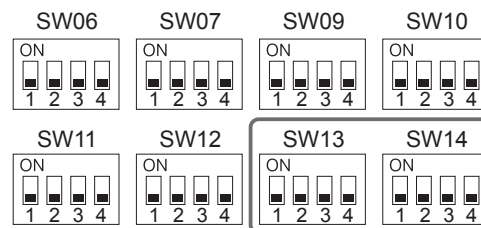

#### Switch settings for a line (system) address on the interface P.C. board on the outdoor unit

(O: switch ON, X: switch OFF)

Line (system) address	SW13				SW14			
	1	2	3	4	1	2	3	4
1	-	-	-	X	X	X	X	X
2	-	-	-	X	O	X	X	X
3	-	-	-	X	X	O	X	X
4	-	-	-	X	O	O	X	X
5	-	-	-	X	X	X	O	X
6	-	-	-	X	O	X	O	X
7	-	-	-	X	X	O	O	X
8	-	-	-	X	O	O	O	X
9	-	-	-	X	X	X	X	O
10	-	-	-	X	O	X	X	O
11	-	-	-	X	X	O	X	O
12	-	-	-	X	O	O	X	O
13	-	-	-	X	X	X	O	O
14	-	-	-	X	O	X	O	O
15	-	-	-	X	X	O	O	O
16	-	-	-	X	O	O	O	O
17	-	-	-	O	X	X	X	X
18	-	-	-	O	O	X	X	X
19	-	-	-	O	X	O	X	X
20	-	-	-	O	O	O	X	X
21	-	-	-	O	X	X	O	X
22	-	-	-	O	O	X	O	X
23	-	-	-	O	X	O	O	X
24	-	-	-	O	O	O	O	X
25	-	-	-	O	X	X	X	O

Line (system) address	SW13				SW14			
	1	2	3	4	1	2	3	4
26	-	-	-	○	○	×	×	○
27	-	-	-	○	×	○	×	○
28	-	-	-	○	○	○	×	○

"-": not used for system address setting (Do not change their positions.)

**2** Be sure to disconnect the relay connectors between the [U1U2] and [U3U4] terminals on all the header outdoor units that will be connected to the central control. (Factory default: disconnected)

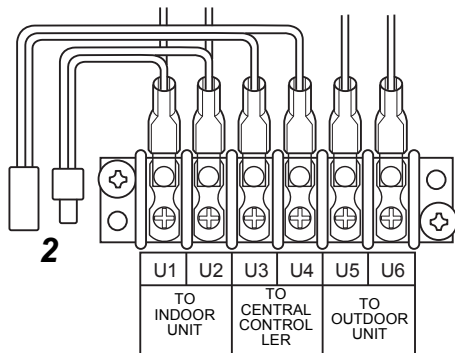

**3** Turn on indoor units first, and then turn on outdoor units.

**4** About 1 minute after turning the power on, confirm that the 7-segment display on the interface P.C. board of the header outdoor unit indicates **U. 1. L08 (U. 1. flash)**.

**5** Press SW 15 to start the automatic address setting.  
(It may take up to 10 minutes (normally about 5 minutes) to complete one line's setting.)

**6** The 7-segment display indicates **Auto 1 → Auto 2 → Auto 3**.

After the indication, **U. 1. --- (U. 1. flash)** starts flashing on the display.

When the flashing stops and **U. 1. --- (U. 1. light)** remains lit on the display, the setting is complete.

**7** Repeat steps 4 to 6 for other refrigerant lines.

**8** After completing address setting of all systems, turn off dip switch 2 of SW30 on the interface P.C. boards of all the header outdoor units connected to the same central control, except the unit that has the lowest address.

(For unifying the termination of the wiring for the central control of indoor and outdoor units)

**9** Connect the relay connectors between the [U1, U2] and [U3, U4] terminals of the header outdoor unit of each refrigerant line.

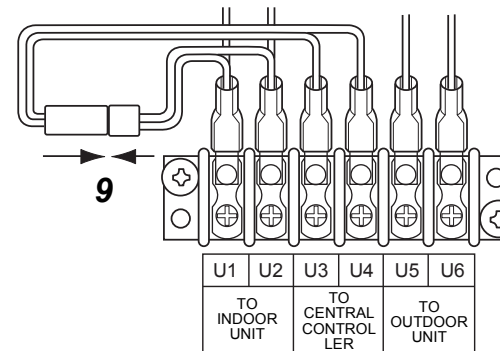

**10** Set the central control address.

(For the setting of the central control address, refer to the installation manuals of the central control devices.)

Header unit interface P.C. board

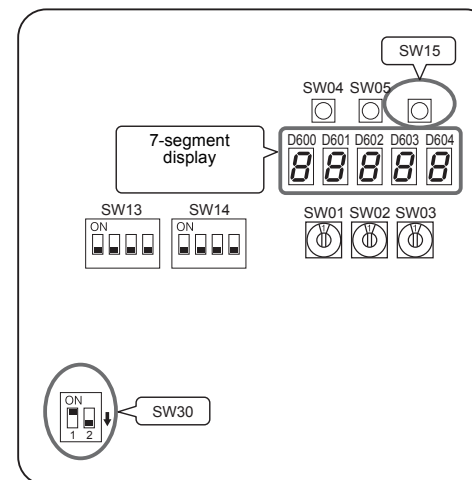

### Switch setting (setting example when controlling 2 or more refrigerant lines centrally)

#### Outdoor units (setting manually)

\*The items in bold font must be set manually.

Outdoor unit's interface P.C. board	Header unit	Follower unit	Header unit	Follower unit	Header unit	Factory default
SW13, 14 (Line (system) address)	1	(No setting required)	<b>2</b>	(No setting required)	<b>3</b>	1
Dip switch 2 of SW30 (Terminator of indoor/outdoor communication line and central control line)	ON	(No setting required)	<b>Set to OFF after setting addresses.</b>	(No setting required)	<b>Set to OFF after setting addresses.</b>	ON
Relay connector	<b>Connect after setting addresses.</b>	Open	<b>Connect after setting addresses.</b>	Open	<b>Connect after setting addresses.</b>	Open

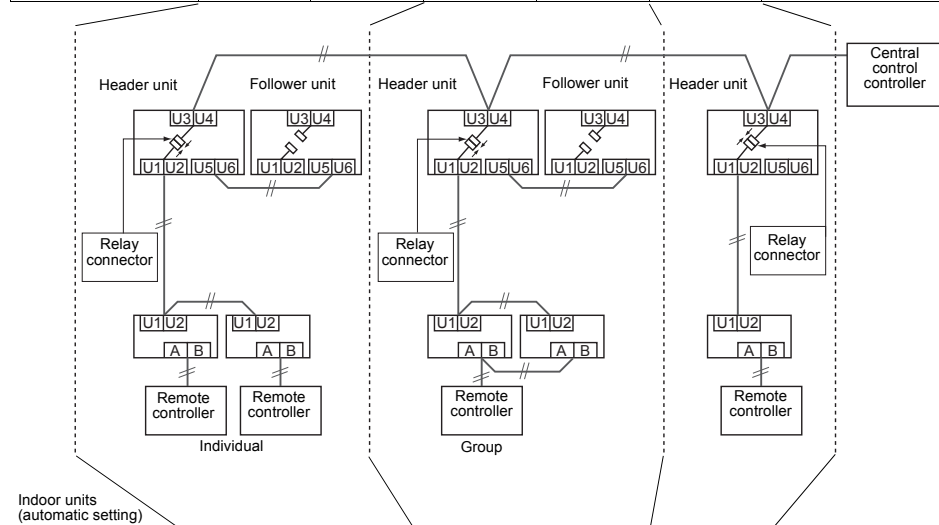

Line (system) address	1	1	2	2	3
Indoor unit address	1	2	1	2	1
Group address	0	0	1	2	0

### CAUTION

#### Relay connector connection

Never connect relay connectors between the [U1, U2] and [U3, U4] terminals before completing address setting of all the refrigerant lines. Otherwise, the addresses cannot be set correctly.

### Manual address setting using the remote controller

Procedure when setting indoor units' addresses first under the condition that indoor wiring has been completed and outdoor wiring has not been started (manual setting using the remote controller)

#### Wiring example of 2 refrigerant lines

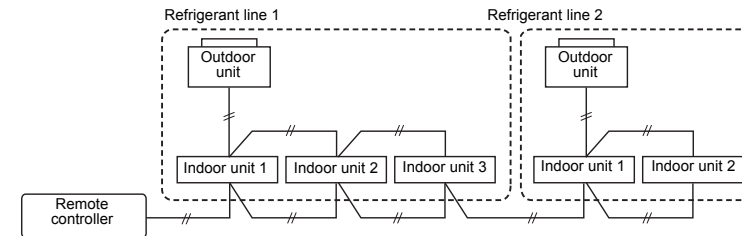

Line (system) address	1	1	1	2	2
Indoor unit address	1	2	3	1	2
Group address	1 Header unit	2 Follower unit	2 Follower unit	2 Follower unit	2 Follower unit

In the example above, disconnect the remote controller connections between the indoor units and connect a wired remote controller to the target unit directly before address setting.

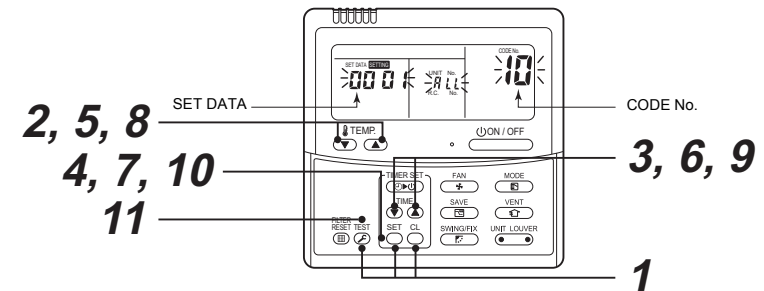

Pair the indoor unit to set and the remote controller one-to-one.

Turn on the power.

- 1 Push and hold the **SET**, **CL**, and **TEST** buttons at the same time for more than 4 seconds. LCD starts flashing.

<Line (system) address>

- 2 Push the TEMP. (▼) / (▲) buttons repeatedly to set the CODE No. to 12.
- 3 Push the TIME (▼) / (▲) buttons repeatedly to set a system address.  
(Match the address with the address on the interface P.C. board of the header outdoor unit in the same refrigerant line.)
- 4 Push the SET button.  
(It is OK if the display turns on.)

<Indoor unit address>

- 5 Push the TEMP. (▼) / (▲) buttons repeatedly to set the CODE No. to 13.
- 6 Push the TIME (▼) / (▲) buttons repeatedly to set an indoor unit address.
- 7 Push the SET button.  
(It is OK if the display turns on.)

<Group address>

- 8 Push the TEMP. (▼) / (▲) buttons repeatedly to set the CODE No. to 14.
- 9 Push the TIME (▼) / (▲) buttons repeatedly to set a group address. If the indoor unit is individual, set the address to 0000; header unit, 0001; follower unit, 0002.

Individual	: 0000	} In case of group control
Header unit	: 0001	
Follower unit	: 0002	

- 10 Push the SET button.  
(It is OK if the display turns on.)
- 11 Push the TEST button.  
The address setting is complete.  
(SETTING flashes. You can control the unit after SETTING has disappeared.)

NOTE

1. Do not use address numbers 29 or 30 when setting system addresses using the remote controller. These 2 address numbers cannot be used on outdoor units and the CODE No. [E04] (Indoor/outdoor communication error) will appear if they are mistakenly used.
2. If you set addresses to indoor units in 2 or more refrigerate lines manually using the remote controller and will control them centrally, set the header outdoor unit of each line as below.
  - Set a system address for the header outdoor unit of each line with SW13 and 14 of their interface P.C. boards.
  - Turn off dip switch 2 of SW30 on the interface P.C. boards of all the header outdoor units connected to the same central control, except the unit that has the lowest address. (For unifying the termination of the wiring for the central control of indoor and outdoor units)
  - Connect the relay connectors between the [U1, U2] and [U3, U4] terminals on the header outdoor unit of each refrigerate line.
  - After finishing all the settings above, set the address of the central control devices. (For the setting of the central control address, refer to the installation manuals of the central control devices.)

■ Confirming the indoor unit addresses and the position of an indoor unit using the remote controller

◆ Confirming the numbers and positions of indoor units

To see the indoor unit address of an indoor unit which you know the position of

- ▼ When the unit is individual (the indoor unit is paired with a wired remote controller one-to-one), or it is a group-controlled one.

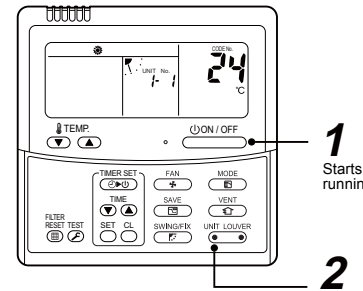

(Execute it while the units are running.)

- 1 Push the (ON/OFF) button if the units stop.
- 2 Push the (UNIT LOUVER) button (left side of the button).  
A unit numbers /- / is indicated on the LCD (it will disappear after a few seconds). The indicated number shows the system address and indoor unit address of the unit.  
When 2 or more indoor units are connected to the remote controller (group-controlled units), a number of other connected units appears each time you push the (UNIT LOUVER) button (left side of the button).

To find an indoor unit's position from its address

- ▼ When checking unit numbers controlled as a group

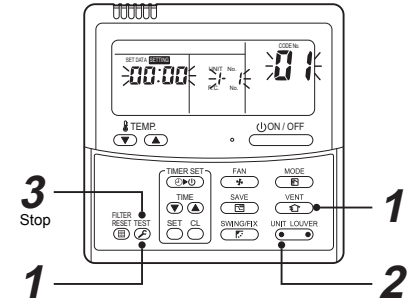

(Execute it while the units are stopped.)

The indoor unit numbers in a group are indicated one after another. The fan and louvers of the indicated units are activated.

- 1 Push and hold the (VENT) and (TEST) buttons at the same time for more than 4 seconds.
    - ALL appears on UNIT No. on the LCD display.
    - The fans and louvers of all the indoor units in the group are activated.
  - 2 Push the (UNIT LOUVER) button (left side of the button). Each time you push the button, the indoor unit numbers are indicated one after another.
    - The first-indicated unit number is the address of the header unit.
    - Only the fan and louvers of the indicated indoor unit are activated.
  - 3 Push the (TEST) button to finish the procedure.  
All the indoor units in the group stop.
- ▼ To check all the indoor unit addresses using an arbitrary wired remote controller.  
(When communication wirings of 2 or more

refrigerant lines are interconnected for central control)

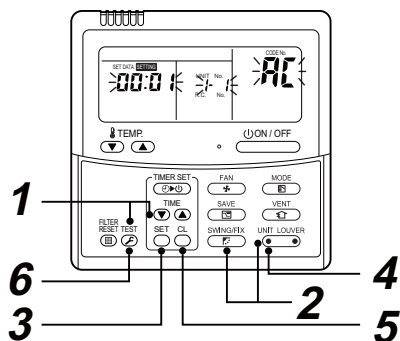

(Execute it while the units are stopped.)

You can check indoor unit addresses and positions of the indoor units in a single refrigerant line.

When an outdoor unit is selected, the indoor unit numbers of the refrigerant line of the selected unit are indicated one after another and the fan and louvers of the indicated indoor units are activated.

- 1 Push and hold the TIME and TEST buttons at the same time for more than 4 seconds. At first, the line 1 and CODE No. *RL* (Address Change) are indicated on the LCD display. (Select an outdoor unit.)
- 2 Push the UNIT LOUVER (left side of the button) and SWING/FIX buttons repeatedly to select a system address.
- 3 Push the SET button to confirm the system address selection.
  - The address of an indoor unit connected to the selected refrigerant line is indicated on the LCD display and its fan and louvers are activated.
- 4 Push the UNIT LOUVER button (left side of the button). Each time you push the button, the indoor unit numbers of the selected refrigerant line are indicated one after another.
  - Only the fan and louvers of the indicated indoor unit are activated.

#### ◆ To select another system address

- 5 Push the CL button to return to step 2.
  - After returning to step 2, select another system address and check the indoor unit addresses of the line.

- 6 Push the TEST button to finish the procedure.

### ■ Changing the indoor unit address using a remote controller

#### To change an indoor unit address using a wired remote controller.

- ▼ The method to change the address of an individual indoor unit (the indoor unit is paired with a wired remote controller one-to-one), or an indoor unit in a group. (The method is available when the addresses have already been set automatically.)

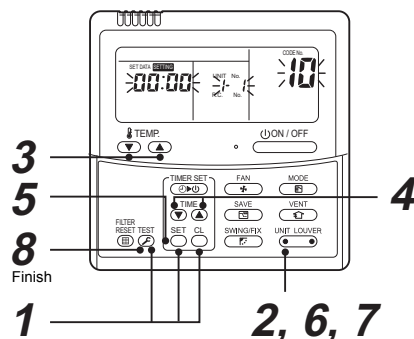

(Execute it while the units are stopped.)

- 1 Push and hold the SET , CL , and TEST buttons at the same time for more than 4 seconds. (If 2 or more indoor units are controlled in a group, the first indicated UNIT No. is that of the head unit.)
- 2 Push the UNIT LOUVER button (left side of the button) repeatedly to select an indoor unit number to change if 2 or more units are controlled in a group. (The fan and louvers of the selected indoor unit are activated.) (The fan of the selected indoor unit is turned on.)
- 3 Push the TEMP. / buttons repeatedly to select 13 for CODE No..
- 4 Push the TIME / buttons repeatedly to change the value indicated in the SET DATA section to that you want.
- 5 Push the SET button.

- 6 Push the UNIT LOUVER button (left side of the button) repeatedly to select another indoor UNIT No. to change. Repeat steps 4 to 6 to change the indoor unit addresses so as to make each of them unique.
- 7 Push the UNIT LOUVER button (left side of the button) to check the changed addresses.
- 8 If the addresses have been changed correctly, push the TEST button to finish the procedure.

▼ To change all the indoor unit addresses using an arbitrary wired remote controller. (The method is available when the addresses have already been set automatically.)

(When communication wirings of 2 or more refrigerant lines are interconnected for central control)

#### NOTE

You can change the addresses of indoor units in each refrigerant line using an arbitrary wired remote controller.

\* Enter the address check/change mode and change the addresses.

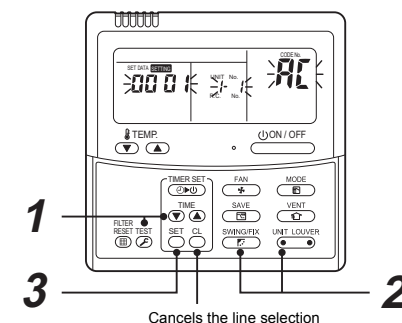

If no number appears on UNIT No., no outdoor unit exists on the line. Push CL button and select another line following step 2.

(Execute it while the units are stopped.)

- 1 Push and hold the TIME and TEST buttons at the same time for more than 4 seconds. At first, the line 1 and CODE No. *RL* (Address Change) are indicated on the LCD display.
- 2 Push the UNIT LOUVER (left side of the button) and SWING/FIX buttons repeatedly to select a system address.

### 3 Push the **SET** button.

- The address of one of the indoor units connected to the selected refrigerant line is indicated on the LCD display and the fan and louvers of the unit are activated.

At first, the current indoor unit address is displayed in SET DATA.  
(No system address is indicated.)

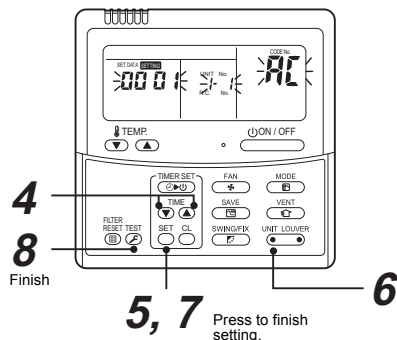

### 4 Push the **TIME** buttons repeatedly to change the value of the indoor unit address in SET DATA. Change the value in SET DATA to that of a new address.

### 5 Push the **SET** button to confirm the new address on SET DATA.

### 6 Push the **UNIT LOUVER** button (left side of the button) repeatedly to select another address to change. Each time you push the button, the indoor unit numbers in a refrigerant line are indicated one after another. Only the fan and louvers of the selected indoor unit are activated.

Repeat steps 4 to 6 to change the indoor unit addresses so as to make each of them unique.

### 7 Push the **SET** button. (All the segments on the LCD display light up.)

### 8 Push the **TEST** button to finish the procedure.

## Resetting the address (Resetting to the factory default (address undecided))

### Method 1

Clearing each address separately using a wired remote controller.  
Set the system address, indoor unit address and group address to "0099" using a wired remote controller. (For the setting procedure, refer to the address setting procedures using the wired remote controller on the previous pages.)

### Method 2

Clearing all the indoor unit addresses on a refrigerant line at once from the outdoor unit.

### 1 Turn off the refrigerant line to reset to the factory default and set the header outdoor unit of the line as below.

- Disconnect the relay connectors between the [U1, U2] and [U3, U4] terminals. (Leave them as they are if they have already been disconnected.)
- Turn on dip switch 2 of SW30 on the interface P.C. board of the header outdoor unit if the switch is OFF. (Leave it as it is if it has already been set to ON.)

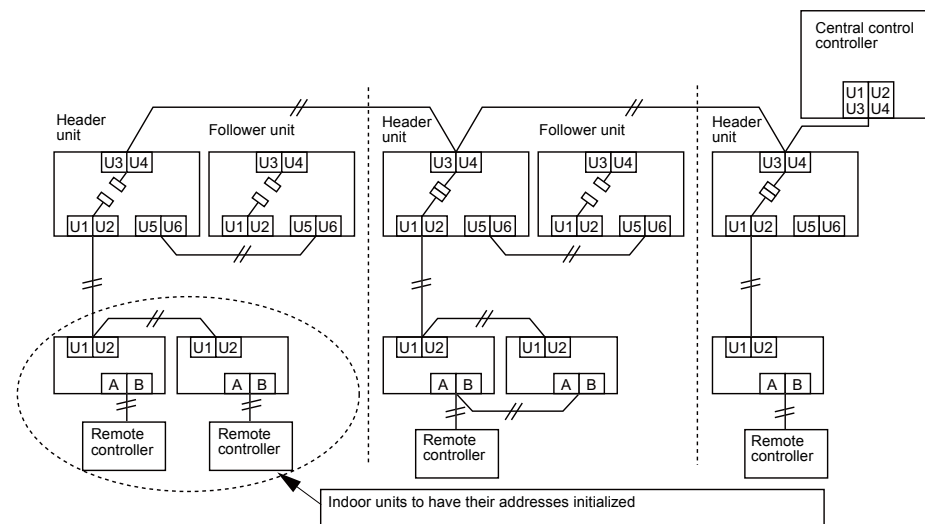

### 2 Turn on the indoor and outdoor units of the refrigerant line for which you want to initialize the addresses. About one minute after turning on the power, confirm that the 7-segment display on the header outdoor unit indicates "U.1. - - -" and operate the interface P.C. board on the header outdoor unit of the refrigerant line as follows.

SW01	SW02	SW03	SW04	Clearable addresses
2	1	2	Confirm that the 7-segment display indicates "A.d.buS" and turn SW04 ON for more than five seconds.	System/indoor unit/group address
2	2	2	Confirm that the 7-segment display indicates "A.d.nEt" and turn SW04 ON for more than five seconds.	Central control address

### 3 Confirm that the 7-segment display indicates "A.d. c.L." and set SW01, SW02 and SW03 to 1, 1, 1 respectively.

### 4 After a time "U.1.L08" appears on the 7-segment display if the address clearing has been completed successfully. If the 7-segment display indicates "A.d. n.G.", the outdoor unit may still be connected with other refrigerant lines. Check the connection of the relay connectors between [U1, U2] and [U3, U4].

#### NOTE

Take care to carry out the procedure above correctly; otherwise, addresses in other refrigerant lines may also be cleared.

### 5 Set the addresses again after finishing the clearance.

# 10 Test run

## Before test run

Confirm that the valve of the refrigerate pipe of the outdoor unit is OPEN.

- Before turning on the power, confirm that the resistance between the terminal block of power supply and the earth is more than 1MΩ using a 500V megohmmeter.  
Do not run the unit if it is less than 1MΩ.

### CAUTION

- Turn on the power and turn on the case heater of the compressor.  
To save the compressor when it is activated, leave the power on for more than 12 hours.

## Methods of test run

### When executing a test run using a remote controller

Operate the system normally to check the running condition using the wired remote controller. Follow the instructions in the supplied owner's manual when operating the unit. If you use a wireless remote controller for operations, follow the instructions in the installation manual supplied with the indoor unit.

To execute a test run forcibly under the condition that the thermostat automatically turns the unit off due to the indoor temperature, follow the procedure below.

The forcible test run will automatically stop after 60 minutes to prevent continuous forcible running and return to normal running.

### CAUTION

Do not use forcible running except for a test run as it overloads the unit.

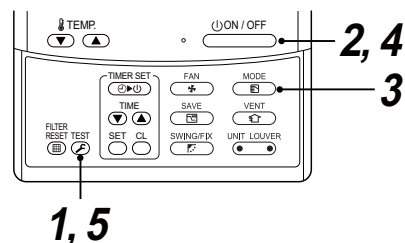

- 1 Push and hold the **TEST** button for more than 4 seconds. **TEST** appears on the LCD display and the unit enters the trial mode. (**TEST** is indicated on the LCD display during the test run.)

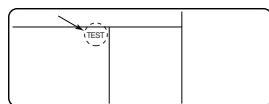

- 2 Push the **ON / OFF** button.
- 3 Push the **MODE** button to switch the running mode to **COOL** or **HEAT**.

### NOTE

- Do not run the unit in any mode other than **COOL** or **HEAT**.
- You cannot change the temperature setting during the test run.
- Errors are detected as usual.

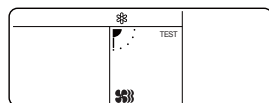

- 4 Push the **ON / OFF** button to stop running after finishing the trial run. The indication on the LCD display returns to the status of procedure 1.
- 5 Push the **TEST** button to exit the trial mode. (**TEST** disappears on the LCD display and the status changes to normal stopped mode.)

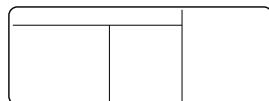

### When executing a test run using the interface P.C. board on the outdoor unit

You can execute a test run by operating switches on the interface P.C. board of the header outdoor unit. "Individual trial", which tests each indoor unit separately, and "corrective trial", which tests all the indoor units connected, are available.

#### <Individual test operation>

##### Starting operation

- 1 Set the running mode to "**COOL**" or "**HEAT**" on the remote controller of the indoor unit to be tested. (The unit will run in the current mode unless you set the mode otherwise.)

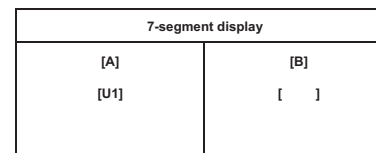

- 2 Set the rotary switches on the interface P.C. board of the header outdoor unit: **SW01 to [16]**, **SW02 and SW03 to the address of the indoor unit to be tested**.

SW02	SW03	Indoor unit address	
1 to 16	1	1 to 16	Set number of SW02
1 to 16	2	17 to 32	Set number of SW02 + 16
1 to 16	3	33 to 48	Set number of SW02 + 32
1 to 16	4	49 to 64	Set number of SW02 + 48

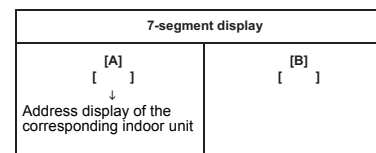

- 3 Push and hold **SW04** for more than 10 seconds.

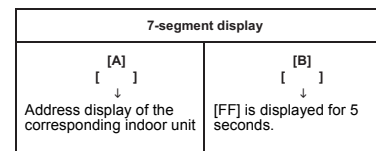

### NOTE

- The running mode follows the mode setting on the remote controller of the target indoor unit.
- You cannot change the temperature setting during the test run.
- Errors are detected as usual.
- The unit does not perform test run for 3 minutes after turning the power on or stopping running.

##### Finishing operation

- 1 Set the rotary switches on the interface P.C. board of the header unit back: **SW01 to [1]**, **SW02 to [1]** and **SW03 to [1]**.

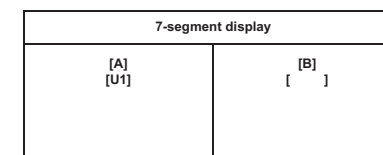

**<Corrective trial>**

**▼ Start operation**

- 1 Set the rotary switches on the interface P.C. board of the header outdoor unit as below.  
 When in "COOL" mode: SW01=[2], SW02=[5], SW03=[1].  
 When in "HEAT" mode: SW01=[2], SW02=[6], SW03=[1].

7-segment display	
[A] [C ] [H ]	[B] [ ] [ ]

- 2 Push and hold SW04 for more than 2 seconds.

**NOTE**

- You cannot change the temperature setting during the test run.
- Errors are detected as usual.
- The unit does not perform test run for 3 minutes after turning the power on or stopping running.

7-segment display	
[A] [C ] [H ]	[B] [ - C ] [ - H ]

**▼ Stop operation**

- 1 Set the rotary switches on the interface P.C. board of the header unit back:  
 SW01 to [1], SW02 to [1] and SW03 to [1].

7-segment display	
[A] [U1]	[B] [ ]

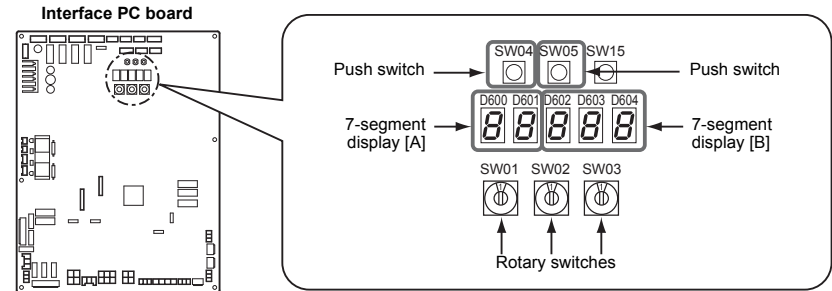



# 11 Troubleshooting

In addition to the CODE No. on the remote controller of an indoor unit, you can diagnose failure type of an outdoor unit by checking the 7-segment display on the interface P.C. board.  
Use the function for various checks.  
Set every dip switch to OFF after checking.

## 7-Segment display and check code

Rotary switch setting value			Indication	LED	
SW01	SW02	SW03			
1	1	1	Outdoor unit check code	A	Outdoor unit number (U <sub>1</sub> to U <sub>4</sub> )
				B	Check code display*

\* If a check code has an auxiliary code, the display indicates the check code for three seconds and the auxiliary code for one second alternately.

### Check code (indicated on the 7-segment display on the outdoor unit)

Indicated when SW01 = [1], SW02 = [1], and SW03 = [1].

Check code		Check code name
Indication on 7-segment display on the outdoor unit	Auxiliary code	
E06	Number of indoor units which received normally	Decrease of number of indoor units
E07	—	Indoor/outdoor communication circuit error
E08	Duplicated indoor addresses	Duplication of indoor addresses.
E12	01: Communication between indoor and outdoor units 02: Communication between outdoor units	Automatic addressing start error
E15	—	No indoor unit during automatic addressing
E16	00: Capacity over 01~: Number of connected units	Capacity over / number of connected indoor units
E19	00: Header is nothing 02: 2 or more header units	Number of header outdoor unit error
E20	01: Other line indoor connected 02: Other line indoor connected	Other lines connected during automatic addressing
E23	—	Sending error between outdoor units communication
E25	—	Duplicated follower outdoor address set up
E26	Number of outdoor units which received normally	Decrease of connected outdoor units
E28	Detected outdoor	Follower outdoor unit error
E31	IPDU quantity information <sup>(*)</sup>	IPDU communication error
F04	—	TD1 sensor error
F05	—	TD2 sensor error
F06	01: TE1 sensor 02: TE2 sensor	TE1 sensor error TE2 sensor error
F07	—	TL sensor error
F08	—	TO sensor error
F12	—	TS1 sensor error
F13	01: Compressor 1 02: Compressor 2 03: Compressor 3	TH (Heat sink) sensor error

Check code		Check code name
Indication on 7-segment display on the outdoor unit	Auxiliary code	
F15	—	Outdoor temp. sensor miswiring Outdoor pressure sensor miswiring (TE1, TL)
F16	—	Outdoor temp. sensor miswiring Outdoor pressure sensor miswiring (Pd, Ps)
F22	—	TD3 sensor error
F23	—	Ps sensor error
F24	—	Pd sensor error
F31	—	Outdoor EEPROM error
H01	01: Compressor 1 02: Compressor 2 03: Compressor 3	Compressor breaking down
H02	01: Compressor 1 02: Compressor 2 03: Compressor 3	Compressor error (Locked)
H03	01: Compressor 1 02: Compressor 2 03: Compressor 3	Current detection circuit error
H05	—	TD1 sensor miswiring
H06	—	Low pressure protective operation
H07	—	Oil level down detection
H08	01: TK1 sensor error 02: TK2 sensor error 03: TK3 sensor error 04: TK4 sensor error 05: TK5 sensor error	Temperature sensor error for oil level
H15	—	TD2 sensor miswiring
H16	01: TK1 oil circuit error 02: TK2 oil circuit error 03: TK3 oil circuit error 04: TK4 oil circuit error 05: TK5 oil circuit error	Oil level detector circuit error
H25	—	TD3 sensor miswiring
L04	—	Outdoor system address duplication
L06	Number of prior indoor units	Duplication of indoor units with priority
L08	—	Indoor unit group/address unset
L10	—	Outdoor unit capacity unset.
L17	—	Mismatch of the outdoor unit model
L28	—	Outdoor connected quantity over
L29	IPDU number information <sup>(*)</sup>	IPDU quantity error
L30	Detected indoor unit address	External interlock of indoor unit
L31	—	Other compressor errors
P03	—	Discharge temperature TD1 error
P04	01: Compressor 1 02: Compressor 2 03: Compressor 3	High-pressure SW system operation
P05	00: 01: Compressor 1 02: Compressor 2 03: Compressor 3	Phase missing/power failure detection Inverter DC voltage error (on compressor)

Check code		Check code name
Indication on 7-segment display on the outdoor unit		
Auxiliary code		
P07	01: Compressor 1 02: Compressor 2 03: Compressor 3	Heat sink overheat error
P10	Detected indoor unit address	Indoor overflow error
P13	—	Outdoor unit flow back error detected
P15	01: TS condition 02: TD condition	Gas leak detection
P17	—	Discharge temperature TD2 error
P18	—	Discharge temperature TD3 error
P19	Detected outdoor unit number	4-way valve inverse error
P20	—	High-pressure protective operation
P22	0 *: IGBT circuit 1 *: Position detection circuit error 3 *: Motor lock error 4 *: Motor current detected C *: TH sensor error D *: TH sensor error E *: Inverter DC voltage error (outdoor unit's fan)	Outdoor fan IPDU error  (NOTE) Ignore 0-F appearing in the position of "**".
P26	01: Compressor 1 02: Compressor 2 03: Compressor 3	G-TR short protection error
P29	01: Compressor 1 02: Compressor 2 03: Compressor 3	Compressor position detecting circuit error

**\*1PDU number information**

- 01:Compressor 1
- 02:Compressor 2
- 03:Compressors 1 and 2
- 04:Compressor 3
- 05:Compressors 1 and 3
- 06:Compressors 2 and 3
- 07:Compressors 1, 2 and 3
- 08:Fan
- 09:Compressor 1 and fan
- 0A:Compressor 2 and fan
- 0B:Compressors 1, 2 and fan
- 0C:Compressor 3 and fan
- 0D:Compressors 1, 3 and fan
- 0E:Compressors 2, 3 and fan
- 0F:Compressors 1, 2, 3, and fan

# 12 Machine card and logbook

## ■ Machine card

After test run, fill the items on the machine card and paste the card on an accessible place on the product securely before delivery to the customer.

**Describe the following items on the machine card:**

name, address and telephone number of the installer, his service department, the service department of the party concerned or at any addresses and telephone numbers of fire department, police, hospitals and burn centres;

## ■ Logbook

Update the log periodically after maintenance as defined in EN378-4.

**Describe the following items on the logbook:**

1. details of the maintenance and repair works;
2. quantities, kind of (new, reused, recycled) refrigerant which have been charged on each occasion, the quantities of refrigerant which have been transferred from the system on each occasion (see also EN378-4);
3. if there is an analysis of a reused refrigerant, the results shall be kept in the logbook;
4. source of the reused refrigerant;
5. changes and replacements of components of the system;
6. result of all periodic routine tests;
7. significant periods of non-use.

# WARNINGS ON REFRIGERANT LEAKAGE

## Check of Concentration Limit

The room in which the air conditioner is to be installed requires a design that in the event of refrigerant gas leaking out, its concentration will not exceed a set limit.

The refrigerant R410A which is used in the air conditioner is safe, without the toxicity or combustibility of ammonia, and is not restricted by laws to be imposed which protect the ozone layer. However, since it contains more than air, it poses the risk of suffocation if its concentration should rise excessively. Suffocation from leakage of R410A is almost non-existent.

With the recent increase in the number of high concentration buildings, however, the installation of multi air conditioner systems is on the increase because of the need for effective use of floor space, individual control, energy conservation by curtailing heat and carrying power etc.

Most importantly, the multi air conditioner system is able to replenish a large amount of refrigerant compared with conventional individual air conditioners. If a single unit of the multi conditioner system is to be installed in a small room, select a suitable model and installation procedure so that if the refrigerant accidentally leaks out, its concentration does not reach the limit (and in the event of an emergency, measures can be made before injury can occur).

In a room where the concentration may exceed the limit, create an opening with adjacent rooms, or install mechanical ventilation combined with a gas leak detection device.

The concentration is as given below.

$$\frac{\text{Total amount of refrigerant (kg)}}{\text{Min. volume of the indoor unit installed room (m}^3\text{)}} \leq \text{Concentration limit (kg/m}^3\text{)}$$

The concentration limit of R410A which is used in multi air conditioners is 0.3kg/m<sup>3</sup>.

### NOTE 1 :

If there are 2 or more refrigerating systems in a single refrigerating device, the amounts of refrigerant should be as charged in each independent device.

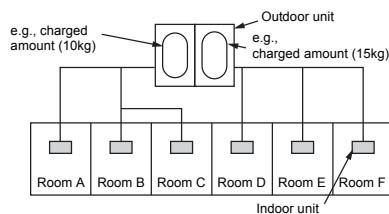

For the amount of charge in this example:

The possible amount of leaked refrigerant gas in rooms A, B and C is 10kg.

The possible amount of leaked refrigerant gas in rooms D, E and F is 15kg.

## Important

### NOTE 2 :

The standards for minimum room volume are as follows.

- (1) No partition (shaded portion)

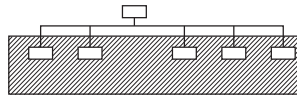

- (2) When there is an effective opening with the adjacent room for ventilation of leaking refrigerant gas (opening without a door, or an opening 0.15% or larger than the respective floor spaces at the top or bottom of the door).

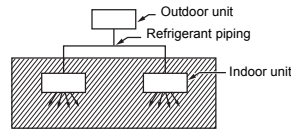

- (3) If an indoor unit is installed in each partitioned room and the refrigerant piping is interconnected, the smallest room of course becomes the object. But when a mechanical ventilation is installed interlocked with a gas leakage detector in the smallest room where the density limit is exceeded, the volume of the next smallest room becomes the object.

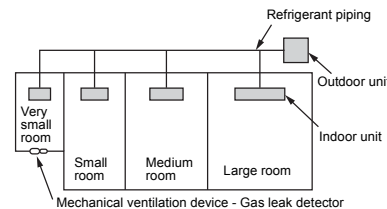

### NOTE 3 :

The minimum indoor floor area compared with the amount of refrigerant is roughly as follows:  
(When the ceiling is 2.7m high)

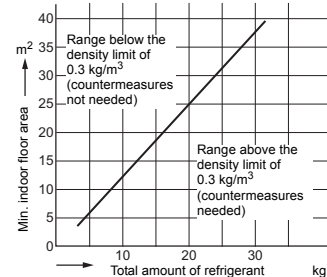

# TOSHIBA CARRIER (THAILAND) CO.,LTD.

144 / 9 Moo 5, Bangkok Industrial Park, Tivanon Road, Amphur Muang, Pathumthani 12000, Thailand

1114207199