



Cassette Type Series

1 Way cassette : AM***FN1DEH*
AM***HN1DEH*
AM***JN1DEH*
2 Way cassette : AM***FN2DEH*
4 Way cassette : AM***FN4DEH*
AM***KN4FEH*

Air Conditioner installation manual

imagine the possibilities

Thank you for purchasing this Samsung product.

Contents

■ Safety Precautions	2
■ Accessories	4
■ Selecting the Installation Location	4
■ Indoor Unit Installation	11
■ Purging the Unit	12
■ Connecting the Refrigerant Pipe	13
■ Cutting/Flaring the Pipes	14
■ Performing Leak Test & Insulation	15
■ Drainpipe and Drain Hose Installation	17
■ Wiring Work	20
■ Setting an indoor unit address and installation option	25
■ Final Checks and User Tips	36
■ Troubleshooting	37

Safety Precautions

(Carefully follow the precautions listed below because they are essential to guarantee the safety of the equipment.)



WARNING

- Always disconnect the air conditioner from the power supply before servicing it or accessing its internal components.
- Verify that installation and testing operations are performed by qualified personnel.
- Verify that the air conditioner is not installed in an easily accessible area.

GENERAL INFORMATION

- ◆ Carefully read the content of this manual before installing the air conditioner and store the manual in a safe place in order to be able to use it as reference after installation.
- ◆ For maximum safety, installers should always carefully read the following warnings.
- ◆ Store the operation and installation manual in a safe location and remember to hand it over to the new owner if the air conditioner is sold or transferred.
- ◆ This manual explains how to install an indoor unit with a split system with two SAMSUNG units. The use of other types of units with different control systems may damage the units and invalidate the warranty. The manufacturer shall not be responsible for damages arising from the use of non compliant units.
- ◆ The manufacturer shall not be responsible for damage originating from unauthorized changes or the improper connection of electric and hydraulic lines. Failure to comply with these instructions or to comply with the requirements set forth in the "Operating limits" table, included in the manual, shall immediately invalidate the warranty.
- ◆ The air conditioner should be used only for the applications for which it has been designed: the indoor unit is not suitable to be installed in areas used for laundry.
- ◆ Do not use the units if damaged. If problems occur, switch the unit off and disconnect it from the power supply.
- ◆ In order to prevent electric shocks, fires or injuries, always stop the unit, disable the protection switch and contact SAMSUNG's technical support if the unit produces smoke, if the power cable is hot or damaged or if the unit is very noisy.
- ◆ Always remember to inspect the unit, electric connections, refrigerant tubes and protections regularly. These operations should be performed by qualified personnel only.
- ◆ The unit contains moving parts, which should always be kept out of the reach of children.
- ◆ Do not attempt to repair, move, alter or reinstall the unit. If performed by unauthorized personnel, these operations may cause electric shocks or fires.
- ◆ Do not place containers with liquids or other objects on the unit.
- ◆ All the materials used for the manufacture and packaging of the air conditioner are recyclable.
- ◆ The packing material and exhaust batteries of the remote control (optional) must be disposed of in accordance with current laws.
- ◆ The air conditioner contains a refrigerant that has to be disposed of as special waste. At the end of its life cycle, the air conditioner must be disposed of in authorized centers or returned to the retailer so that it can be disposed of correctly and safely.

Safety Precautions(Continued)

INSTALLING THE UNIT

IMPORTANT: When installing the unit, always remember to connect first the refrigerant tubes, then the electrical lines.

Always disassemble the electric lines before the refrigerant tubes.

- ◆ Upon receipt, inspect the product to verify that it has not been damaged during transport. If the product appears damaged, DO NOT INSTALL it and immediately report the damage to the carrier or retailer (if the installer or the authorized technician has collected the material from the retailer.)
- ◆ After completing the installation, always carry out a functional test and provide the instructions on how to operate the air conditioner to the user.
- ◆ Do not use the air conditioner in environments with hazardous substances or close to equipment that release free flames to avoid the occurrence of fires, explosions or injuries.
- ◆ The air conditioner should be used only for the applications for which it has been designed: the indoor unit is not suitable to be installed in areas used for laundry.
- ◆ Our units must be installed in compliance with the spaces indicated in the installation manual to ensure either accessibility from both sides or ability to perform routine maintenance and repairs. The units' components must be accessible and that can be disassembled in conditions of complete safety either for people or things.
For this reason, where it is not observed as indicated into the Installation Manual, the cost necessary to reach and repair the unit (in safety, as required by current regulations in force) with slings, trucks, scaffolding or any other means of elevation won't be considered in-warranty and charged to end user.
- ◆ This unit is intended for free-air discharge or for connection to a duct supplying only one room.

POWER SUPPLY LINE, FUSE OR CIRCUIT BREAKER

- ◆ Always make sure that the power supply is compliant with current safety standards. Always install the air conditioner in compliance with current local safety standards.
- ◆ Always verify that a suitable grounding connection is available.
- ◆ Verify that the voltage and frequency of the power supply comply with the specifications and that the installed power is sufficient to ensure the operation of any other domestic appliance connected to the same electric lines.
- ◆ Always verify that the cut-off and protection switches are suitably dimensioned.
- ◆ Verify that the air conditioner is connected to the power supply in accordance with the instructions provided in the wiring diagram included in the manual.
- ◆ Always verify that electric connections (cable entry, section of leads, protections...) are compliant with the electric specifications and with the instructions provided in the wiring scheme. Always verify that all connections comply with the standards applicable to the installation of air conditioners.



CAUTION

- ◆ **Make sure that you earth the cables.**
 - **Do not connect the earth wire to the gas pipe, water pipe, lighting rod or telephone wire.**
 - If earthing is not complete, electric shock or fire may occur.**
- ◆ **Install the circuit breaker.**
 - **If the circuit breaker is not installed, electric shock or fire may occur.**
- ◆ **Make sure that the condensed water dripping from the drain hose runs out properly and safely.**
- ◆ **Install the power cable and communication cable of the indoor and outdoor unit at least 1m away from the electric appliance.**
- ◆ **Install the indoor unit away from lighting apparatus using the ballast.**
 - **If you use the wireless remote control, reception error may occur due to the ballast of the lighting apparatus.**
- ◆ **Do not install the air conditioner in following places.**
 - **Place where there is mineral oil or arsenic acid. Resin parts flame and the accessories may drop or water may leak. The capacity of the heat exchanger may reduce or the air conditioner may be out of order.**
 - **The place where corrosive gas such as sulfurous acid gas generates from the vent pipe or air outlet. The copper pipe or connection pipe may corrode and refrigerant may leak.**
 - **The place where there is a machine that generates electromagnetic waves. The air conditioner may not operate normally due to control system.**
 - **The place where there is a danger of existing combustible gas, carbon fiber or flammable dust. The place where thinner or gasoline is handled. Gas may leak and it may cause fire.**

Accessories

The following accessories are supplied with the indoor unit.
The type and quantity may differ depending on the specifications.

AM****N1DEH*

Installation template 	Dimension gauge 	Insulation drain 	Flexible hose 	Rubber 	Installation manual
---------------------------	---------------------	----------------------	-------------------	------------	-------------------------

AM****FN2DEH*

Installation template 	Dimension gauge 	Insulation drain 	Flexible hose 	Rubber 	Installation manual
---------------------------	---------------------	----------------------	-------------------	------------	-------------------------

AM****FN4DEH*/AM****KN4FEH*

Installation template 	Dimension gauge 	Insulation pipe 	Cable-tie 	Drain hose 	Installation manual 	Clamp
---------------------------	---------------------	---------------------	---------------	----------------	-------------------------	-----------

Selecting the Installation Location

Indoor Unit

- ◆ There must be no obstacles near the air inlet and outlet.
- ◆ Install the indoor unit on a ceiling that can support its weight.
- ◆ Maintain sufficient clearance around the indoor unit.
- ◆ Make sure that the water dripping from the drain hose runs away correctly and safely.
- ◆ The indoor unit must be installed in this way, that they are out of public access. (Not touchable by the users)
- ◆ Rigid wall without vibration.
- ◆ Where it is not exposed to direct sunshine.
- ◆ Where the air filter can be removed and cleaned easily.



CAUTION

- ◆ **As a rule, the unit cannot be installed at a height of less than 2.5 m.**
- ◆ **It is possible to install the unit at a height of between 2.2~2.5m from the ground, if the unit has a duct with a well defined length (300mm or more) to avoid fan motor blower contact.**
- ◆ **If you install the cassette or duct type indoor unit on the ceiling with humidity over 80%, you must apply extra 10mm of polyethylene foam or other insulation with similar material on the body of the indoor unit.**

Selecting the Installation Location (Continued)

Space Requirements for Indoor Unit

AM***FN1DEH*/AM***HN1DEH*/AM***JN1DEH* /
AM***FN2DEH*

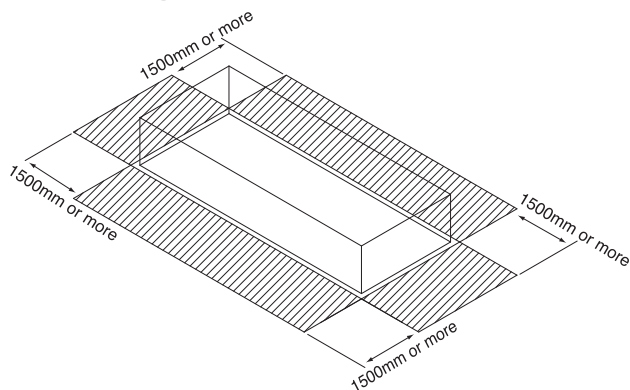

AM***FN4DEH*/AM***KN4FEH*

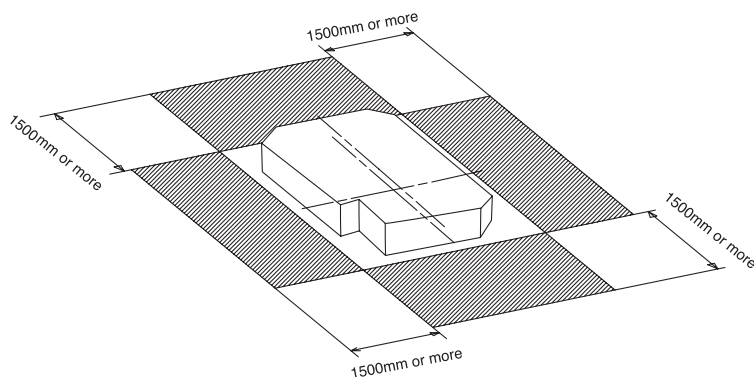

- ◆ **The units must be installed according to distances declared, in order to permit accessibility from each side, either to guarantee correct operation of maintenance or repairing products. The unit's parts must be reachable and removable completely under safety condition (for people or things).**

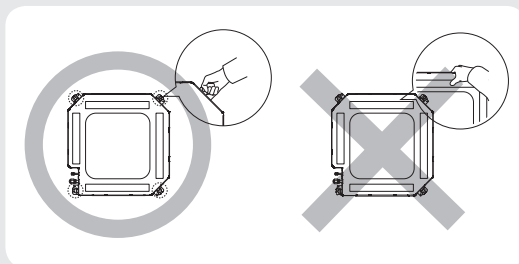

- ◆ **Do not hold the discharge while carrying the indoor unit to avoid the possibility of breakage. You must hold the hanger plate on the corner and carry the indoor unit.**

Selecting the Installation Location (Continued)

Insulation Guide

AM***FN2DEH*

Unit : mm

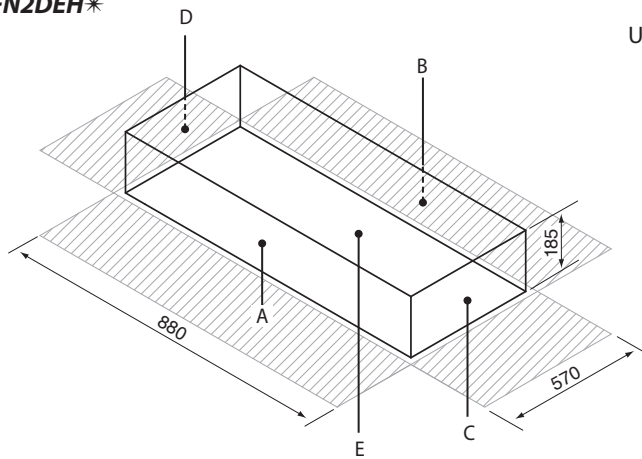

Thickness: more than 10mm

Indoor unit		A	B	C	D	E
2Way-Cst	5.2~7.2kw (890x230x575)	880x185	880x185	570x185	570x185	880x570

◆ Insulate the end of the pipe and some curved area by using separate insulator.

Dimension of the indoor unit

AM***FN1DEH*

Unit : mm

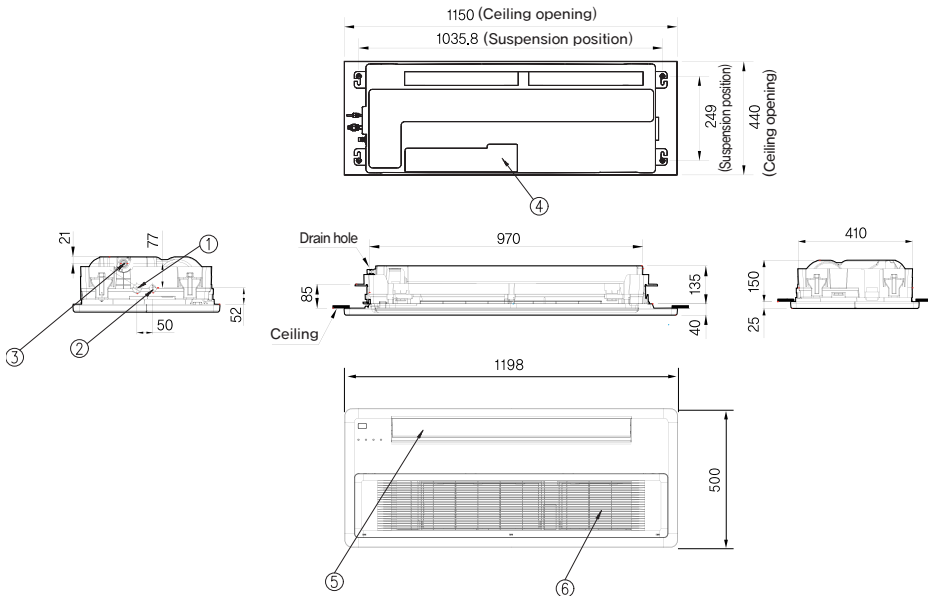

No.	Name	Description	No.	Name	Description
①	Liquid pipe connection	ø6.35	④	Power supply connection	-
②	Gas pipe connection	ø12.70	⑤	Air discharge grille	-
③	Drain pipe connection	OD ø32, ID ø26	⑥	Air suction grille	-

Dimension of the indoor unit

AM***HN1DEH*

Unit : mm

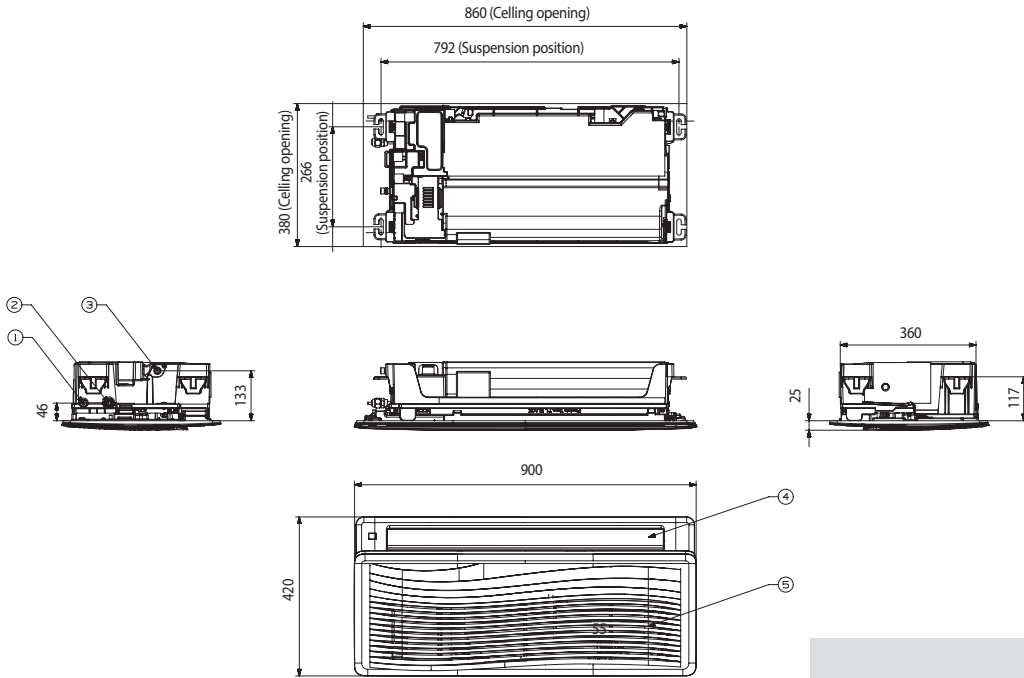

No.	Name	Description
①	Liquid pipe connection	ø6.35
②	Gas pipe connection	ø12.7
③	Drain pipe connection	OD ø32, ID ø26
④	Air discharge grille	-
⑤	Air suction grille	-

Selecting the Installation Location (Continued)

Dimension of the indoor unit

AM***JN1DEH*

Unit : mm

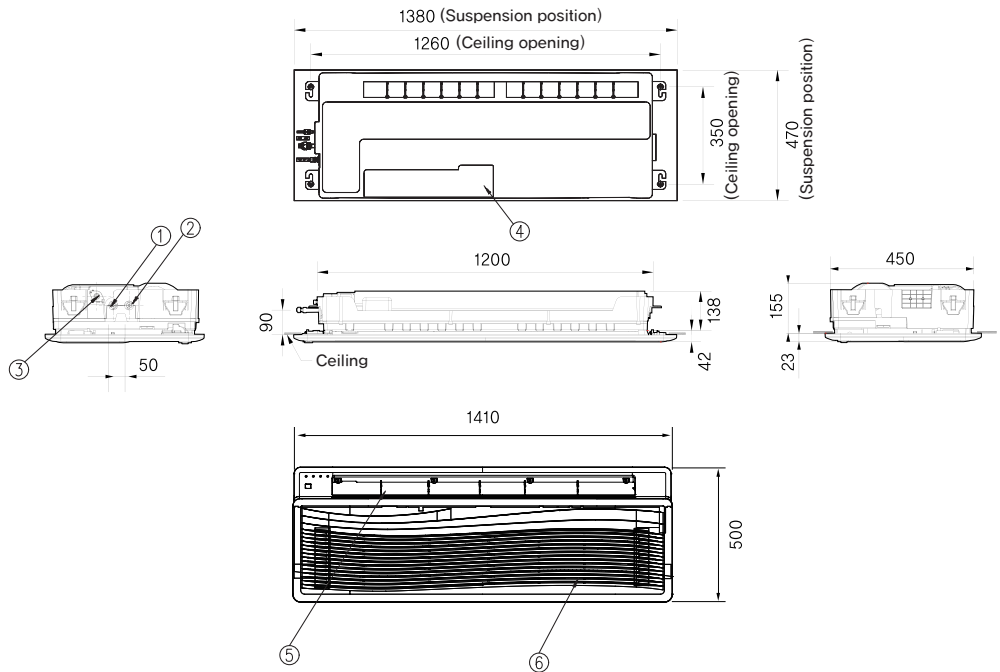

No.	Name	Description
①	Liquid pipe connection	AM056JN1**** : $\phi 6.35$ (1/4") AM071JN1**** : $\phi 9.52$ (3/8")
②	Gas pipe connection	AM056FN1**** : $\phi 12.70$ (1/2") AM071FN1**** : $\phi 15.88$ (5/8")
③	Drain pipe connection	OD $\phi 32$, ID $\phi 26$
④	Power supply connection	-
⑤	Air discharge grille	-
⑥	Air suction grille	-

Dimension of the indoor unit

AM***FN2DEH*

Unit : mm

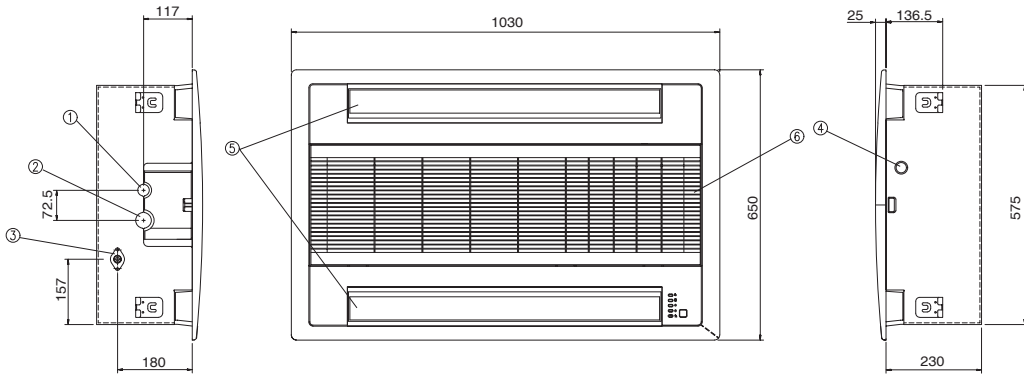
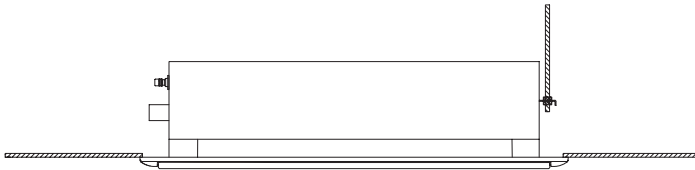
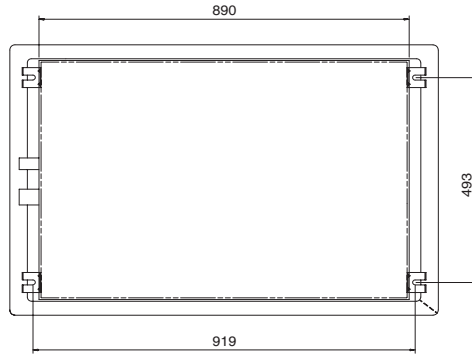

No.	Name	Description
①	Liquid pipe connection	**056** : ø6.35 **071** : ø9.52
②	Gas pipe connection	**056** : ø12.7 **071** : ø15.88
③	Drain pipe connection	OD ø32, ID ø26
④	Power supply connection	-
⑤	Air discharge grille	-
⑥	Air suction grille	-

Selecting the Installation Location

Dimension of the indoor unit

AM***FN4DEH*/AM***KN4FEH*

Unit : mm

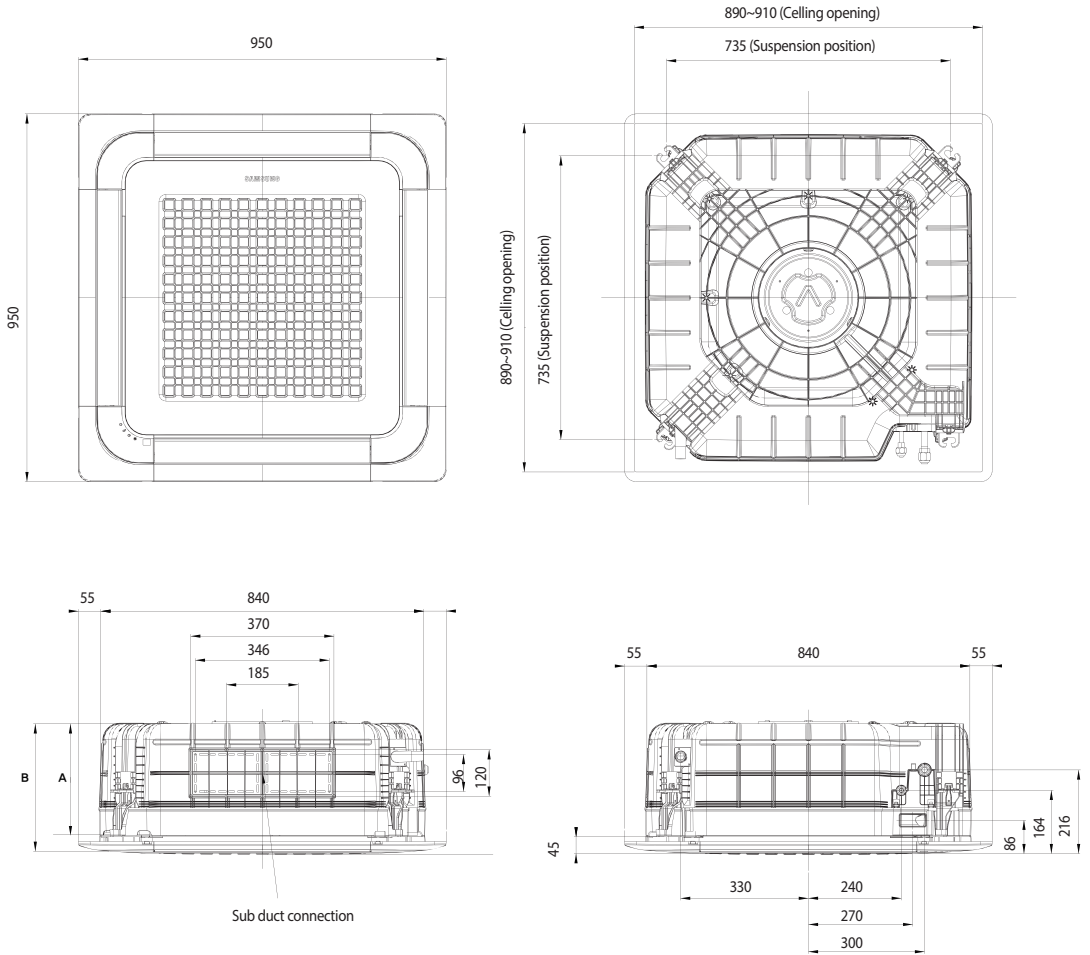

		MODEL			
		AM045FN4DEH* AM056FN4DEH*	AM071FN4DEH* AM090FN4DEH*	AM112FN4DEH*	AM128FN4DEH* AM140FN4DEH* AM060KN4FEH* AM071KN4FEH* AM080KN4FEH*
A	mm	204	204	246	288
B	mm	253	253	295	337
Liquid pipe connection		ø6.35		ø9.52	
Gas pipe connection		ø12.7		ø15.88	
Drain Hose connection		mm OD : ø32, ID : ø26			

Indoor Unit Installation

It is recommended to install the Y-joint before installing the indoor unit.

- 1 Place the pattern sheet on the ceiling at the spot where you want to install the indoor unit.

Note Since the diagram is made of paper, it may shrink or stretch slightly due to temperature or humidity. For this reason, before drilling the holes maintain the correct dimensions between the markings.

- 2 Insert bolt anchors, use existing ceiling supports or construct a suitable support as shown in figure.

- 3 Install the suspension bolts depending on the ceiling type.



- ◆ Ensure that the ceiling is strong enough to support the weight of the indoor unit. Before hanging the unit, test the strength of each attached suspension bolt.
- ◆ If the length of suspension bolt is more than 1.5m, it is required to prevent vibration.
- ◆ If this is not possible, create an opening on the false ceiling in order to be able to use it to perform the required operations on the indoor unit.

- 4 Screw eight nuts to the suspension bolts making space for hanging the indoor unit.



You must install the suspension bolts more than four when installing the indoor unit.

- 5 Check the level of the indoor unit by using a leveler.

- ◆ A tilt of the indoor unit may cause malfunction of a built-in float switch and water leaks.

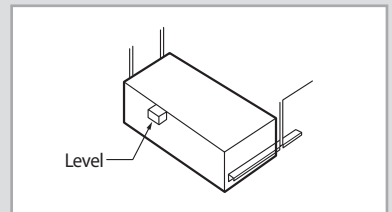
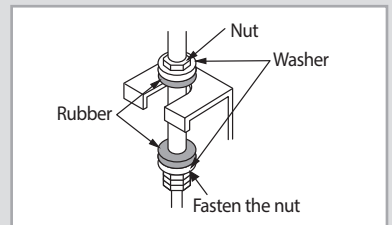
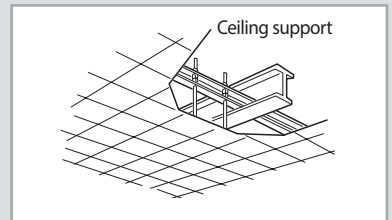
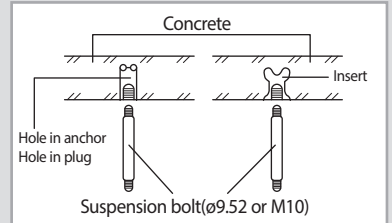
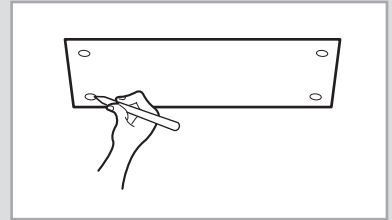

Indoor Unit Installation (Continued)

- 6 Adjust the height of the indoor unit by using jigs.
- ◆ You should adjust the jigs and the pattern sheet to fit the cutting dimensions of ceiling.
 - ◆ Noise may occur if you do not adjust the location of the indoor unit according to location of the jigs during installation.
 - Adjust the location of the indoor unit according to the jigs.
 - ◆ Make sure that the indoor unit is installed at a level if the indoor unit slants too much, there can be water leaks.
 - ◆ AM***HN1DEH* models have installation guide on the product. Make sure to adjust the height of the suspension bolt so that surface of the ceiling and the installation guide on the indoor unit is parallel to each other.

AM***FN1DEH*/ AM***JN1DEH*

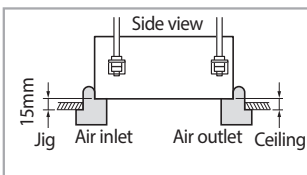

AM***FN2DEH*

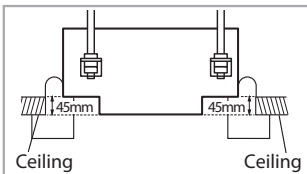

AM***HN1DEH*

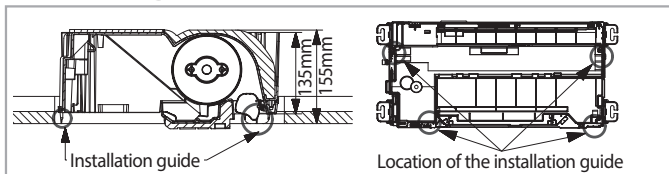

※ Make sure surface of the ceiling and the installation guide is parallel to each other.

AM***FN4DEH*/AM***KN4FEH*

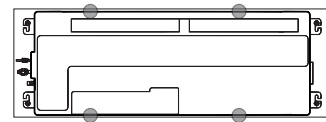
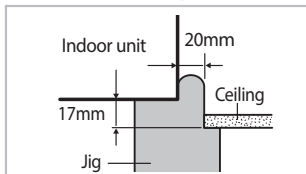

- When installing the indoor unit, make sure that it is not installed too closely to the one side of the opening on the ceiling.

- 7 Tighten the upper part nuts.

- 8 Remove the jigs after installing the indoor unit.

Purging the Unit

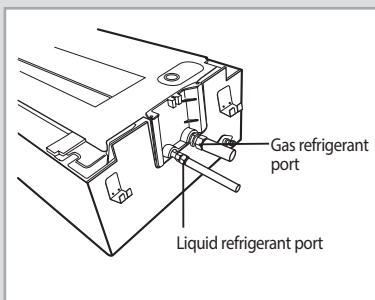

※ The designs and shape are subject to change according to the model.

From factory the unit is supplied and set with a pre-charge of nitrogen gas (insert gas). Therefore, all insert gas must be purged before connecting the assembly piping.

Unscrew the pinch pipe at the end of each refrigerant pipe.

Result: All inert gas escapes from the indoor unit.

Note To prevent dirt or foreign objects from getting into the pipes during installation, do NOT remove the pinch pipe completely until you are ready to connect the piping.

Connecting the Refrigerant Pipe

There are two refrigerant pipes of differing diameters:

- ◆ A smaller one for the liquid refrigerant
- ◆ A larger one for the gas refrigerant
- ◆ The inside of copper pipe must be clean & has no dust.

1 Before connecting the refrigerant pipe, open the cover side.

2 Remove the pinch pipe on the pipes and connect the assembly pipes to each pipe, tightening the nuts, first manually and then with a torque wrench, a spanner applying the following torque.

Outer Diameter (mm)	Torque	
	kgf·cm	N·m
6.35	140~180	14~18
9.52	350~430	34~42
12.70	500~620	49~61
15.88	690~830	68~82

Note Must apply refrigerant oil on the flaring area to prevent a leak.

3 Be sure that there must be no crack or kink on the bended area.

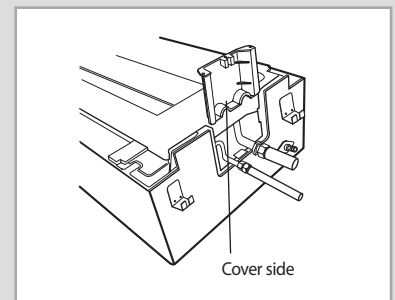
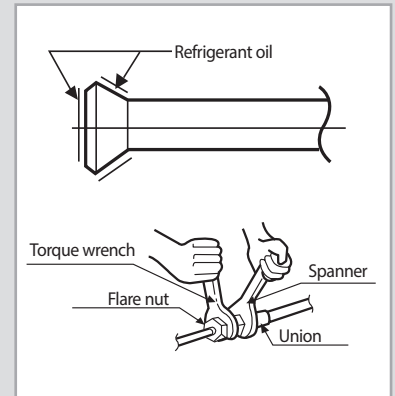

* The designs and shape are subject to change according to the model.



- ◆ **Connect the indoor and outdoor units using pipes with flared connections(not supplied). For the lines, use insulated, unwelded, degreased and deoxidized copper pipe,(Cu DHP type to ISO 1337), suitable for operating pressures of at least 4200kPa and for a burst pressure of at least 20700kPa. Copper pipe for hydro-sanitary applications is completely unsuitable.**
- ◆ **For sizing and limits (height difference, line length, max. bends, refrigerant charge, etc.) see the outdoor unit installation manual.**
- ◆ **All refrigerant connection must be accessible, in order to permit either unit maintenance or removing it completely.**

Cutting/Flaring the Pipes

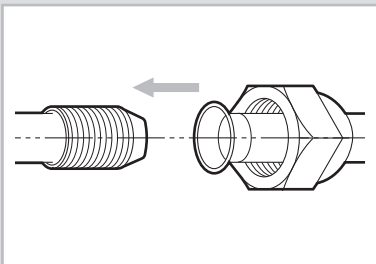
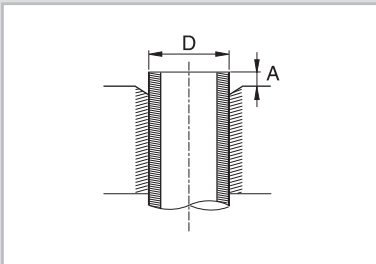
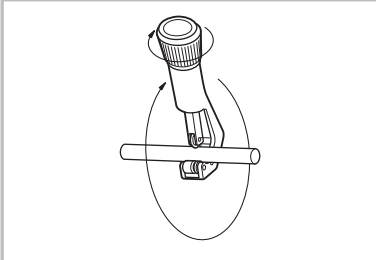

1 Make sure that you prepared the required tools.
(pipe cutter, reamer, flaring tool and pipe holder)

2 If you want to shorten the pipe, cut it using a pipe cutter ensuring that the cut edge remains at 90° with the side of the pipe. There are some examples of correctly and incorrectly cut edges below.

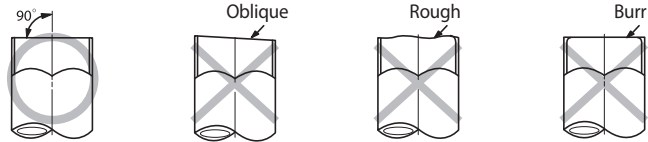

3 To prevent a gas leak, remove all burrs at the cut edge of the pipe using a reamer.

4 Carry out flaring work using flaring tool as shown below.

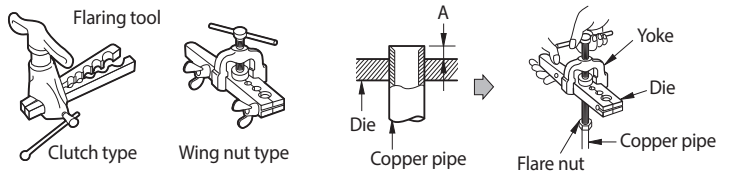

Outer diameter [D (mm)]	Depth [A (mm)]		
	Flare tool for R-410A clutch type	Conventional flare tool	
		Clutch type	Wing nut type
6.35	0~0.5	1.0~1.5	1.5~2.0
9.52	0~0.5	1.0~1.5	1.5~2.0
12.70	0~0.5	1.0~1.5	1.5~2.0
15.88	0~0.5	1.0~1.5	1.5~2.0

5 Check if you flared the pipe correctly. There are some examples of incorrectly flared pipes below.



6 Align the pipes and tighten the flare nuts first manually and then with a torque wrench, applying the following torque.

Outer diameter (D, mm)	Connection Torque		Flare dimension (A, mm)	Flare shape (mm)
	kgf·cm	N·m		
6.35	140~180	14~18	8.70~9.10	
9.52	350~430	34~42	12.80~13.20	
12.70	500~620	49~61	16.20~16.60	
15.88	690~830	68~82	19.30~19.70	



In case of needing brazing, you must work with Nitrogen gas blowing.

Performing Leak Test & Insulation

Leak test

LEAK TEST WITH NITROGEN (before opening valves)

In order to detect basic refrigerant leaks, before recreating the vacuum and recirculating the R-410A, it's responsible of installer to pressurize the whole system with nitrogen (using a pressure regulator) at a pressure above 4.1MPa (gauge).

LEAK TEST WITH R-410A (after opening valves)

Before opening valves, discharge all the nitrogen into the system and create vacuum. After opening valves check leaks using a leak detector for refrigerant R-410A.



Discharge all the nitrogen to create a vacuum and charge the system.

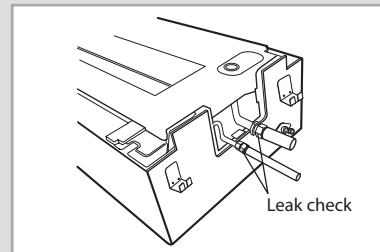

* The designs and shape are subject to change according to the model.

Insulation

Once you have checked that there are no leaks in the system, you can insulate the piping and hose.

- 1 To avoid condensation problems, place **T13.0 or thicker Acrylonitrile Butadien Rubber** separately around each refrigerant pipe.

Note Always make the seam of pipes face upwards.

- 2 Wind insulating tape around the pipes and drain hose avoiding to compress the insulation too much.
- 3 Finish wrapping insulating tape around the rest of the pipes leading to the outdoor unit.
- 4 The pipes and electrical cables connecting the indoor unit with the outdoor unit must be fixed to the wall with suitable ducts.



All refrigerant connection must be accessible, in order to permit either unit maintenance or removing it completely.

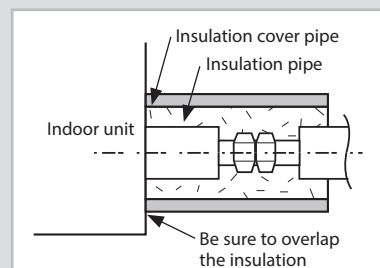
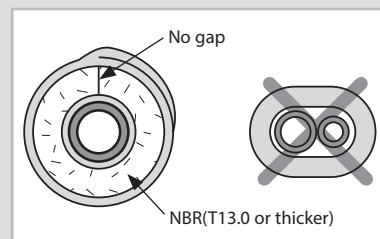

Must fit tightly against body without any gap.

Performing Leak Test & Insulation (Continued)

- 5 Select the insulation of the refrigerant pipe.
- ◆ Insulate the gas side and liquid side pipe referring to the thickness according to the pipe size.
 - ◆ Indoor temperature of 30°C and humidity of 85% is the standard condition. If installing in a high humidity condition, use one grade thicker insulator by referring to the table below.
 - ◆ If installing in an unfavorable conditions, use thicker one.
 - ◆ Insulator's heat-resistance temperature should be more than 120°C.

Pipe	Pipe size	Insulation Type (Heating/Cooling)		Remarks
		Standard [30°C, 85%]	High humidity [30°C, over 85%]	
		EPDM, NBR		
Liquid pipe	Ø6.35 ~ Ø9.52	9t	←	Internal temperature is higher than 120°C
	Ø12.7 ~ Ø50.80	13t	←	
Gas pipe	Ø6.35	13t	19t	
	Ø9.52~Ø25.40	19t	25t	
	Ø28.58~Ø44.45		32t	
	Ø50.80	25t	38t	

- ◆ When installing insulation in places and conditions below, use the same insulation that is used for high humidity conditions.
 - <Geological condition>
 - High humidity places such as shoreline, hot spring, near lake or river, and ridge (when the part of the building is covered by earth and sand.)
 - <Operation purpose condition>
 - Restaurant ceiling, sauna, swimming pool etc.
 - <Building construction condition>
 - The ceiling frequently exposed to moisture and cooling is not covered. e.g. The pipe installed at a corridor of a dormitory and studio or near an exit that opens and closes frequently.
 - The place where the pipe is installed is highly humid due to the lack of ventilation system.

Refrigerant pipe before EEV kit and MCU or without EEV kit and MCU

- ◆ You can contact the gas side and liquid side pipes but the pipes should not be pressed.
- ◆ When contacting the gas side and gas side pipe, use 1 grade thicker insulator.

Refrigerant pipe after EEV kit and MCU

- ◆ Install the gas side and liquid side pipes, leave 10mm of space.
- ◆ When contacting the gas side and liquid side pipe, use 1 grade thicker insulator.

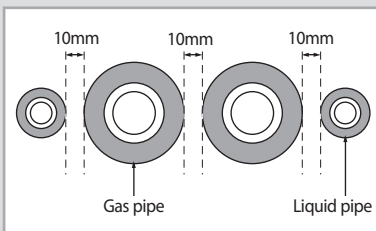
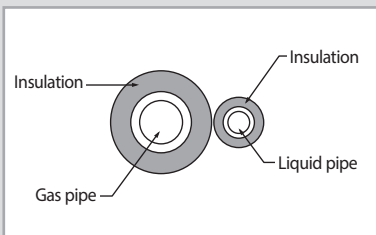

- ◆ **Install the insulation not to get wider and use the adhesives on the connection part of it to prevent moisture from entering.**
- ◆ **Wind the refrigerant pipe with insulation tape if it is exposed to outside sunlight.**
- ◆ **Install the refrigerant pipe respecting that the insulation does not get thinner on the bent part or hanger of pipe.**
- ◆ **Add the additional insulation if the insulation plate gets thinner.**

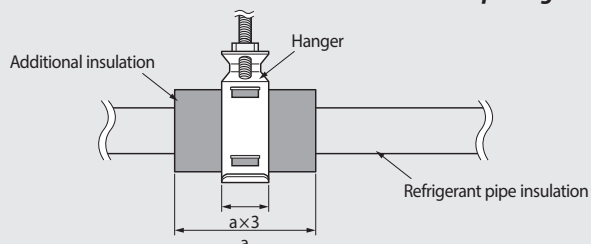

Drain pipe and Drain Hose Installation

Care must be taken when installing the drainpipe and drain hose for the indoor unit so that condensate water is drained correctly outside.

1 Fix the flexible hose to the drainpipe.

AM*FN1DEH*/AM***HN1DEH*/AM***JN1DEH*/**

AM*FN2DEH***

- ◆ The connection part of the flexible hose and PVC drainpipe must be fixed with PVC adhesives.
- ◆ Check out that the connected part doesn't leak.
- ◆ Drain pipe type :
 - VP20
 - VP25

AM*FN4DEH*/AM***KN4FEH***

- ◆ Push the supplied drain hose as far as possible over the drain socket.
- ◆ Tighten the metal clamp as shown in the picture.
- ◆ Wrap the supplied large sealing pad over the metal clamp and drain hose to insulate and fix it with clamps.
- ◆ Insulate the complete drain piping inside the building (field supply).
If the drain hose cannot be sufficiently set on a slope, fit the hose with drain raising piping (field supply).
- ◆ Push the drain hose up to insulation when connecting the drain hose to drain socket.

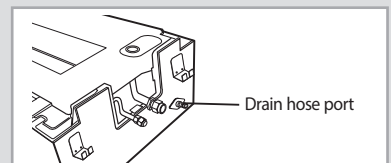
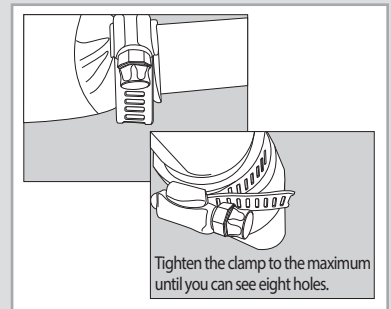
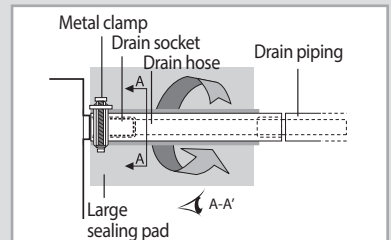
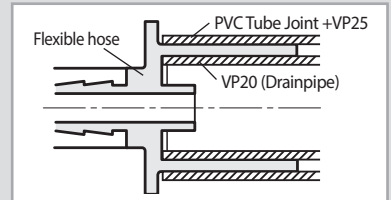

2 Connect the flexible hose to the drain hose port.

- ◆ Make sure that a rubber ring is installed on the drain hose port.
- ◆ Drain hose port location differs depending on the unit types.

3 Install the drain pipe as shortly as possible.

- ◆ Give a slightly slant to the drainpipe for proper drainage of condensate water.
- ◆ There must be no gap on the connected part so that the drainpipe is not separated from the flexible hose.

4 Insulate the drainpipe, and then fix it as indicated.

- ◆ Whole drainpipe should be insulated by 5t(or more) insulation to prevent water condensation.

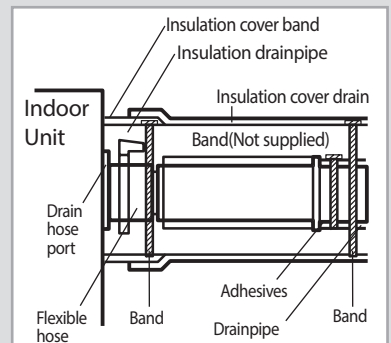

Drain pipe and Drain Hose Installation (Continued)

* Flexible hose Installation

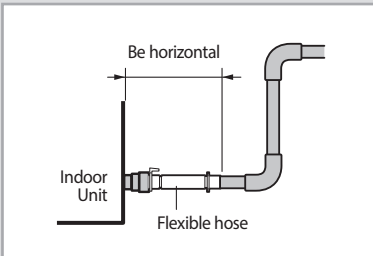

◆ Install horizontally

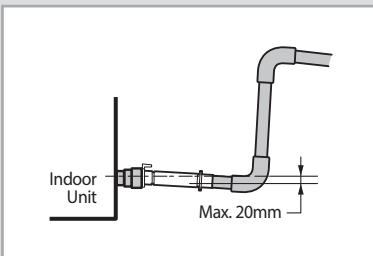

◆ Max. allowable axis gap

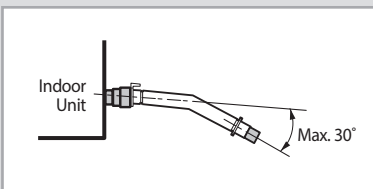

◆ Max. allowable bending angle

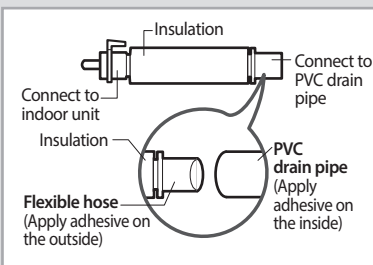

◆ Handle with using adhesive not to block the inside of flexible hose

Drainpipe Connection

- 1 The drain pipe should be installed within 100mm from the flexible hose, lift up from 100mm to 550mm and lift down 20mm or more.
- 2 Install horizontal drainpipe with a slope of 1/100 or more and fix it by hanger space of 1~1.5m.
- 3 Install the air vent in the horizontal drainpipe to prevent water flow back to the indoor unit.

Note You may not need to install it if there were proper slope in the horizontal drainpipe.

- 4 The flexible hose should not be installed upward position, it may cause water flow back to the indoor unit.
- 5 Install U-trap at the end of the drainpipe to prevent a nasty smell to reach the indoor unit.

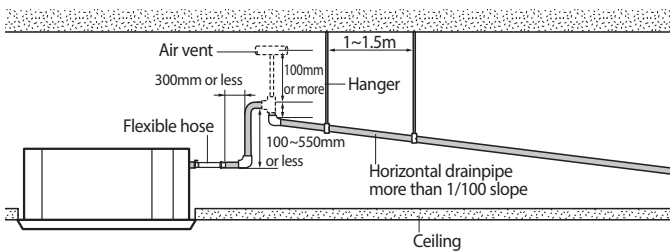

Centralized Drainage

- 1 Install main air vent at the front of the farthest indoor unit from the main drain when installed indoor units are more than 3.
- 2 You may need to install individual air vent to prevent water flow back at the top of each indoor unit drainpipe.

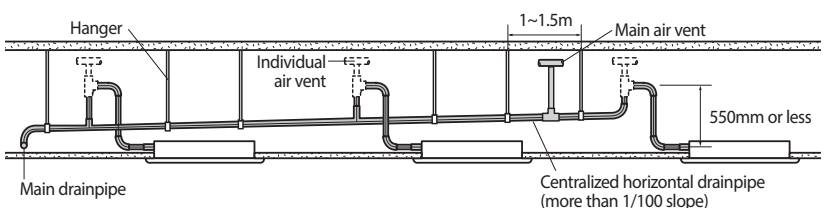

Testing the Drainage

You should test drainage after completing the installation.
Prepare a little water about 1.0 liter.

- 1 Open the cover water supply intake.
- 2 Pour water into the water supply intake.
- 3 Operate the unit in the Cool mode and check a drain pump pumping.
- 4 Check drain water drops at the end of the drainpipe.

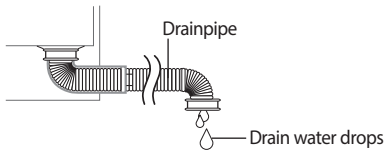

- 5 Make sure there is no water leak at the drainage.
- 6 When you finished the test, close the coverside.



When maintaining the air conditioner, remove condensate water remained in the drain pan by using a drain port for maintenance.

AM*FN1DEH*/**
AM*HN1DEH*/**
AM*JN1DEH***

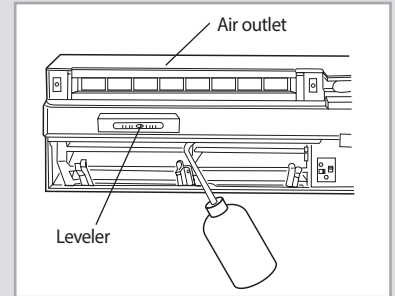

AM*FN2DEH***

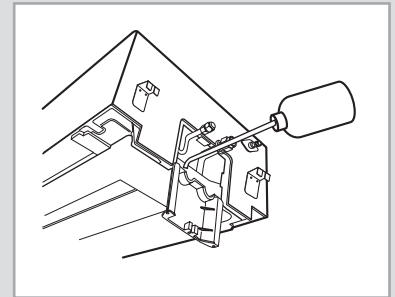

AM*FN4DEH*/**
AM*KN4FEH***

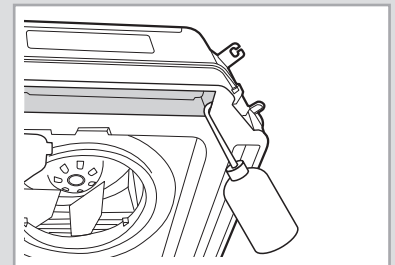

Power and communication cable connection

- 1 Before wiring work, you must turn off all power source.
- 2 Indoor unit power should be supplied through the breaker(MCCB, ELB) separated by the outdoor power.
- 3 The power cable should be used only copper wires.
- 4 Connect the power cable{1(L), 2(N)} among the units within maximum length and communication cable(F1, F2) each.
- 5 Connect F3, F4(for communication) when installing the wired remote Control.

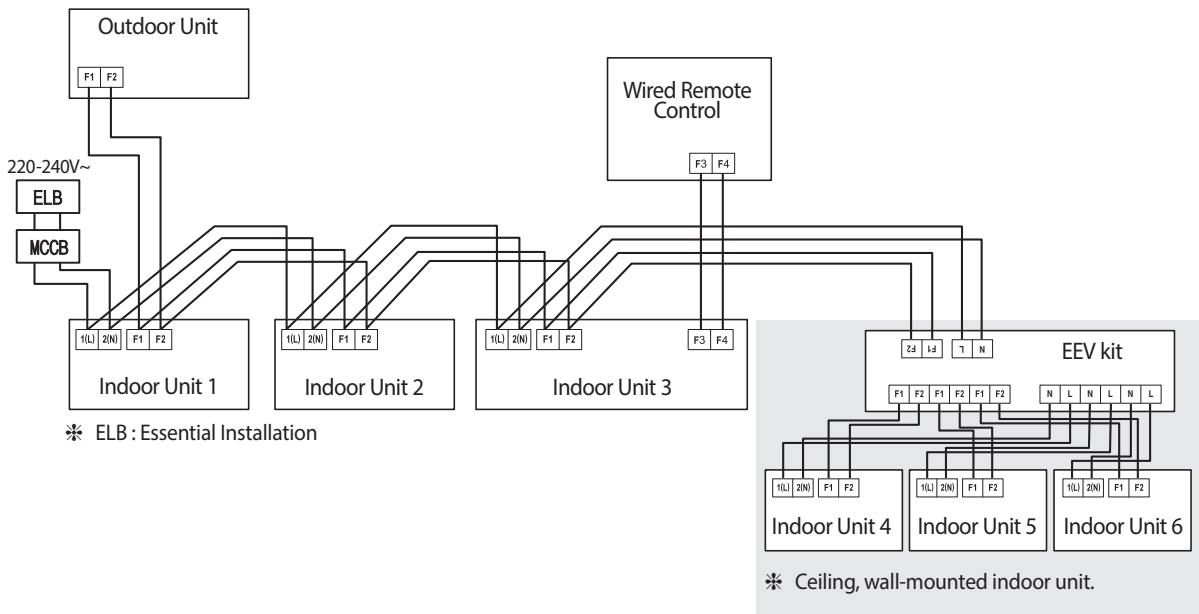

Selecting compressed ring terminal

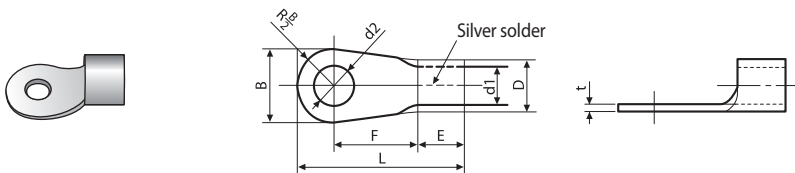

Nominal dimensions for cable (mm ²)	Nominal dimensions for screw (mm)	B		D		d1		E	F	L	d2		t
		Standard dimension (mm)	Allowance (mm)	Standard dimension (mm)	Allowance (mm)	Standard dimension (mm)	Allowance (mm)				Standard dimension (mm)	Allowance (mm)	
1.5	4	6.6	±0.2	3.4	+0.3 -0.2	1.7	±0.2	4.1	6	16	4.3	+0.2 0	0.7
	4	8											
2.5	4	6.6	±0.2	4.2	+0.3 -0.2	2.3	±0.2	6	6	17.5	4.3	+0.2 0	0.8
	4	8.5											
4	4	9.5	±0.2	5.6	+0.3 -0.2	3.4	±0.2	6	5	20	4.3	+0.2 0	0.9

Specification of electronic wire

Power supply	MCCB	ELB	Power cable	Earth cable	Communication cable
Max : 242V Min : 198V	X A	X A, 30mmA 0.1 s	2.5mm ²	2.5mm ²	0.75~1.5mm ²

- ◆ Decide the capacity of ELB and MCCB by below formula.

$$\text{The capacity of ELB, MCCB } X[A] = 1.25 \times 1.1 \times \sum A_i$$

- * X: The capacity of ELB, MCCB
- * $\sum A_i$: Sum of Rating currents of each indoor unit.
- * Refer to each installation manual about the rating current of indoor unit.

- ◆ Decide the power cable specification and maximum length within 10% power drop among indoor units.

$$\sum_{k=1}^n \left(\frac{\text{Coef} \times 35.6 \times L_k \times i_k}{1000 \times A_k} \right) < 10\% \text{ of input voltage[V]}$$

* Coef: 1.55

* L_k : Distance among each indoor unit[m], A_k : Power cable specification[mm²]
 i_k : Running current of each unit[A]

* Rating current

Unit	Model	Rating current
AM***FN1DEH*	**022**	0.20
	028	0.23
	036	0.25
AM***HN1DEH*	**017**	0.14
	022	0.15
AM***JN1DEH*	**056**	0.28
	071	0.40
AM***FN2DEH*	**056**	0.38
	071	0.40
AM***FN4DEH*	**045**	0.22
	056	0.22
	071	0.31
	090	0.43
	112	0.55
	128	0.51
AM***KN4FEH*	**060**	1.20
	071	1.31
	080	1.40

Example of Installation

- Total power cable length L = 100(m), Running current of each units 1[A]
- Total 10 indoor units were installed

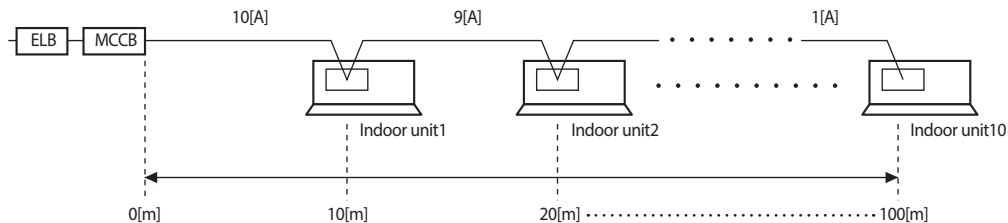

- ◆ Apply following equation.

$$\sum_{k=1}^n \left(\frac{\text{Coef} \times 35.6 \times L_k \times i_k}{1000 \times A_k} \right) < 10\% \text{ of input voltage[V]}$$

* Calculation

- Installing with 1 sort wire.

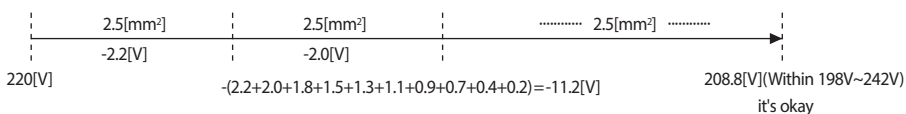

- Installing with 2 different sort wire.

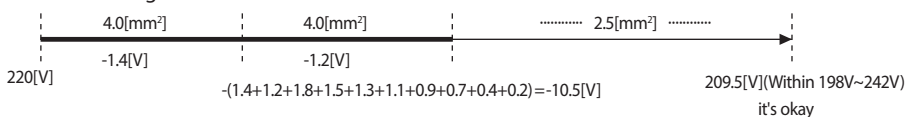







- ◆ **Select the power cable in accordance with relevant local and national regulations.**
- ◆ **Wire size must comply with local and national code.**
- ◆ **Power Supply cords of parts of appliances for outdoor use shall not be lighter than polychloroprene sheathed flexible cord.(Code designation IEC:60245 IEC 57 / CENELEC: H05RN-F or IEC:60245 IEC 66 / CENELEC: H07RN-F)**
- ◆ **You should connect the power cable into the power cable terminal and fasten it with a clamp.**
- ◆ **The unbalanced power must be maintained within 10% of supply rating among whole indoor units.**
- ◆ **If the power is unbalanced greatly, it may shorten the life of the condenser. If the unbalanced power is exceeded over 10% of supply rating, the indoor unit is protected, stopped and the error mode indicates.**
- ◆ **To protect the product from water and possible shock, you should keep the power cable and the connection cord of the indoor and outdoor units in the iron pipe.**
- ◆ **Connect the power cable to the auxiliary circuit breaker. An all pole disconnection from the power supply must be incorporated in the fixed wiring($\geq 3\text{mm}$).**
- ◆ **You must keep the cable in a protection tube.**
- ◆ **Keep distances of 50mm or more between power cable and communication cable.**
- ◆ **Maximum length of power cables are decided within 10% of power drop. If it exceeds, you must consider another power supplying method.**
- ◆ **The circuit breaker(MCCB, ELB) should be considered more capacity if many indoor units are connected from one breaker.**
- ◆ **Use round pressure terminal for connections to the power terminal block.**
- ◆ **For wiring, use the designated power cable and connect it firmly, then secure to prevent outside pressure being exerted on the terminal board.**
- ◆ **Use an appropriate screwdriver for tightening the terminal screws. A screwdriver with a small head will strip the head and make proper tightening impossible.**
- ◆ **Over-tightening the terminal screws may break them.**
- ◆ **See the table below for tightening torque for the terminal screws.**

	Tightening torque	
	N-m	kgf-cm
M3.5	0.8~1.2	8.0~12.0
M4	1.2~1.8	12.0~18.0

How to connect your extended power cables

1 Prepare the following tools.

Tools	Crimping pliers	Connection sleeve (mm)	Insulation tape	Contraction tube (mm)
Spec	MH-14	20xØ6.5(HxOD)	Width 19mm	70xØ8.0(LxOD)
Shape				

2 As shown in the figure, peel off the shields from the rubber and wire of the power cable.

- Peel off 20 mm of the wire shields of the tube.

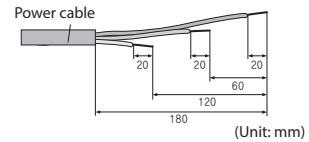

CAUTION

- After peeling off the tube wire, you must insert a contraction tube.
- For information about the power cable specifications for indoor and outdoor units, refer to the installation manual.

3 Insert both sides of core wire of the power cable into the connection sleeve.

► **Method 1**

Push the core wire into the sleeve from both sides.

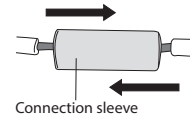

► **Method 2**

Twist the wire cores together and push it into the sleeve.

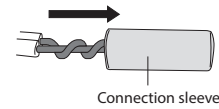

4 Using a crimping tool, compress the two points and flip it over and compress another two points in the same location.

- The compression dimension should be 8.0.
- After compressing it, pull both sides of the wire to make sure it is firmly pressed.

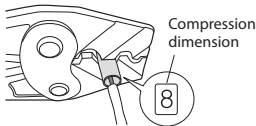

► **Method 1**

Compress it 4 times.

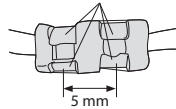

► **Method 2**

Compress it 4 times.

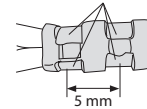

Wiring Work (Continued)

- 5 Wrap it with the insulation tape twice or more and position your contraction tube in the middle of the insulation tape. A total of three or more layers of insulation is required.

► Method 1

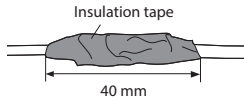

► Method 2

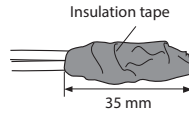

- 6 Apply heat to the contraction tube to contract it.

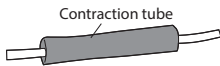

- 7 After tube contraction work is completed, wrap it with the insulation tape to finish.



CAUTION

- Make sure that the connection parts are not exposed to outside.
- Be sure to use insulation tape and a contraction tube made of approved reinforced insulating materials that have the same level of withstand voltage with the power cable. (Comply with the local regulations on extensions.)

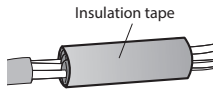

WARNING

- In case of extending the electric wire, please DO NOT use a round-shaped Pressing socket.
- Incomplete wire connections can cause electric shock or a fire.

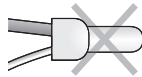

Setting an indoor unit address and installation option

Set the indoor unit address and installation option with remote controller option.
Set the each option separately since you cannot set the ADDRESS setting and indoor unit installation setting option at the same time. You need to set twice when setting indoor unit address and installation option.

The procedure of option setting

MR-DC00, MR-DH00

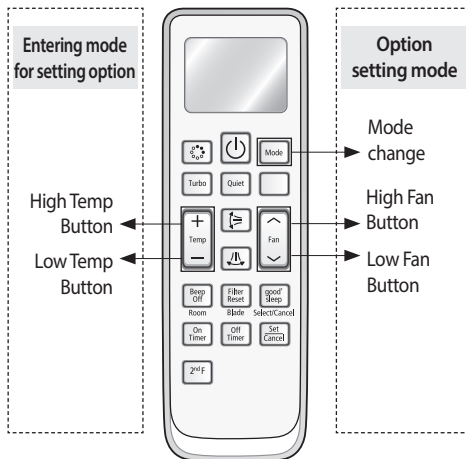

MR-EC00, MR-EH00

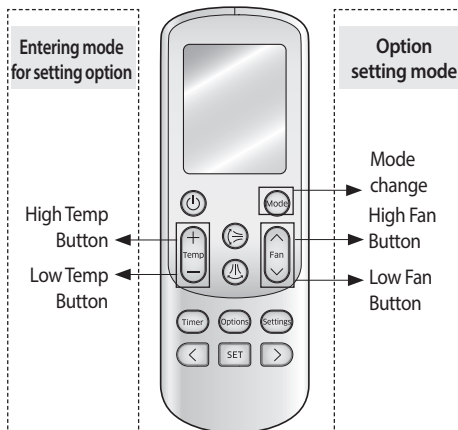

Step 1. Entering mode to set option

1. Remove batteries from the remote controller.
2. Insert batteries and enter the option setting mode while pressing High Temp button and Low Temp button.

3.  Check if you have entered the option setting status.



Step 2. The procedure of option setting

After entering the option setting status, select the option as listed below.











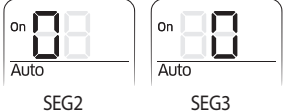
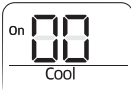
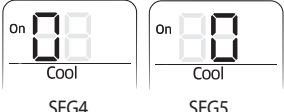

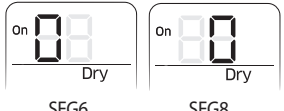

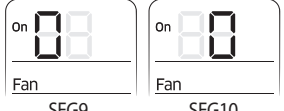

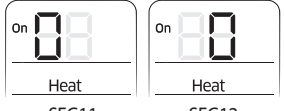

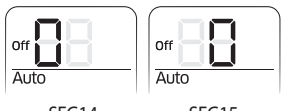







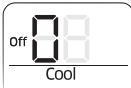
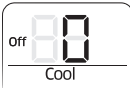





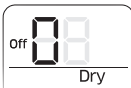

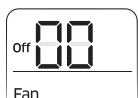



Option setting is available from SEG1 to SEG 24

- ◆ **SEG1, SEG7, SEG13, SEG19 are not set as page option.**
- ◆ **Set the SEG2~SEG6, SEG8~SEG12 as ON status and SEG14~18, SEG20~24 as OFF status.**

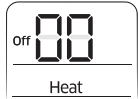
SEG1	SEG2	SEG3	SEG4	SEG5	SEG6	SEG7	SEG8	SEG9	SEG10	SEG11	SEG12	On(SEG1~12)	Off(SEG13~24)
0	X	X	X	X	X	1	X	X	X	X	X		
SEG13	SEG14	SEG15	SEG16	SEG17	SEG18	SEG19	SEG20	SEG21	SEG22	SEG23	SEG24		
2	X	X	X	X	X	3	X	X	X	X	X		

Setting an indoor unit address and installation option (Continued)

Option setting	Status
<p>1. Setting SEG2, SEG3 option Press Low Fan button(V) to enter SEG2 value. Press High Fan button(Λ) to enter SEG3 value. Each time you press the button, 0 → 1 → ... 9 → F will be selected in rotation.</p>	
<p>2. Setting Cool mode (Mode) Press Mode button to be changed to Cool mode in the ON status.</p>	
<p>3. Setting SEG4, SEG5 option Press Low Fan button(V) to enter SEG4 value. Press High Fan button(Λ) to enter SEG5 value. Each time you press the button, 0 → 1 → ... 9 → F will be selected in rotation.</p>	
<p>4. Setting Dry mode (Mode) Press Mode button to be changed to DRY mode in the ON status.</p>	
<p>5. Setting SEG6, SEG8 option Press Low Fan button(V) to enter SEG6 value. Press High Fan button(Λ) to enter SEG8 value. Each time you press the button, 0 → 1 → ... 9 → F will be selected in rotation.</p>	
<p>6. Setting Fan mode (Mode) Press Mode button to be changed to FAN mode in the ON status.</p>	
<p>7. Setting SEG9, SEG10 option Press Low Fan button(V) to enter SEG9 value. Press High Fan button(Λ) to enter SEG10 value. Each time you press the button, 0 → 1 → ... 9 → F will be selected in rotation.</p>	
<p>8. Setting Heat mode (Mode) Press Mode button to be changed to HEAT mode in the ON status.</p>	
<p>9. Setting SEG11, SEG12 option Press Low Fan button(V) to enter SEG11 value. Press High Fan button(Λ) to enter SEG12 value. Each time you press the button, 0 → 1 → ... 9 → F will be selected in rotation.</p>	
<p>10. Setting Auto mode (Mode) Press Mode button to be changed to AUTO mode in the OFF status.</p>	
<p>11. Setting SEG14, SEG15 option Press Low Fan button(V) to enter SEG14 value. Press High Fan button(Λ) to enter SEG15 value. Each time you press the button, 0 → 1 → ... 9 → F will be selected in rotation.</p>	

Option setting	Status
<p>12. Setting Cool mode</p> <p> Press Mode button to be change to Cool mode in the OFF status.</p>	
<p>13. Setting SEG16, SEG17 option</p> <p>Press Low Fan button(∨) to enter SEG16 value. Press High Fan button(∧) to enter SEG17 value. Each time you press the button,  →  → ...  →  will be selected in rotation.</p>	 
<p>14. Setting Dry mode</p> <p> Press Mode button to be change to Dry mode in the OFF status.</p>	
<p>15. Setting SEG18, SEG20 option</p> <p>Press Low Fan button(∨) to enter SEG18 value. Press High Fan button(∧) to enter SEG20 value. Each time you press the button,  →  → ...  →  will be selected in rotation.</p>	 
<p>16. Setting Fan mode</p> <p> Press Mode button to be change to Fan mode in the OFF status.</p>	
<p>17. Setting SEG21, SEG22 option</p> <p>Press Low Fan button(∨) to enter SEG21 value. Press High Fan button(∧) to enter SEG22 value. Each time you press the button,  →  → ...  →  will be selected in rotation.</p>	 
<p>18. Setting Heat mode</p> <p> Press Mode button to be change to HEAT mode in the OFF status.</p>	
<p>19. Setting SEG23, SEG24 mode</p> <p>Press Low Fan button(∨) to enter SEG23 value. Press High Fan button(∧) to enter SEG24 value. Each time you press the button,  →  → ...  →  will be selected in rotation.</p>	 

Step 3. Check the option you have set

After setting option, press  button to check whether the option code you input is correct or not.

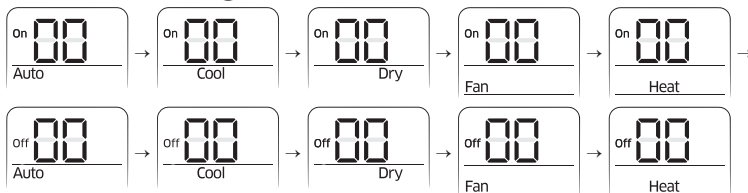

Step 4. Input option

Press operation button  with the direction of remote control for set.
For the correct option setting, you must input the option twice.

Step 5. Check operation

1. Reset the indoor unit by pressing the RESET button of indoor unit or outdoor unit.
2. Take the batteries out of the remote controller and insert them again and then press the operation button.

Setting an indoor unit address and installation option (Continued)

Setting an indoor unit address (MAIN/RMC)

- Check whether power is supplied or not.
 - When the indoor unit is not plugged in, there should be additional power supply in the indoor unit.
- The panel(display) should be connected to an indoor unit to receive option.
- Before installing the indoor unit, assign an address to the indoor unit according to the air conditioning system plan.
- Assign an indoor unit address by wireless remote controller.
 - The initial setting status of indoor unit ADDRESS(MAIN/RMC) is "0A0000-100000-200000-300000".

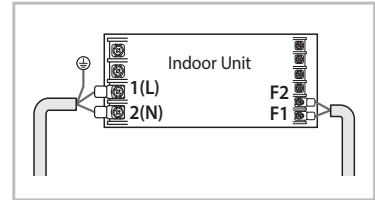

Option No. : 0AXXXX-1XXXXX-2XXXXX-3XXXXX

Option	SEG1		SEG2		SEG3		SEG4		SEG5		SEG6	
Explanation	PAGE		MODE		Setting Main address		100-digit of indoor unit address		10-digit of indoor unit		The unit digit of an indoor unit	
Remote Controller Display												
Indication and Details	Indication	Details	Indication	Details	Indication	Details	Indication	Details	Indication	Details	Indication	Details
	0		A		0	No Main address						
					1	Main address setting mode	0~9	100-digit	0~9	10-digit	0~9	A unit digit
Option	SEG7		SEG8		SEG9		SEG10		SEG11		SEG12	
Explanation	PAGE				Setting RMC address				Group channel(*16)		Group address	
Remote Controller Display												
Indication and Details	Indication	Details			Indication	Details			Indication	Details	Indication	Details
	1				0	No RMC address						
					1	RMC address setting mode			RMC1	0~F	RMC2	0~F



- ◆ When "A"~"F" is entered to SEG5~6, the indoor unit MAIN ADDRESS is not changed.
- ◆ If you set the SEG 3 as 0, the indoor unit will maintain the previous MAIN ADDRESS even if you input the option value of SEG5~6.
- ◆ If you set the SEG 9 as 0, the indoor unit will maintain previous RMC ADDRESS even if you input the option value of SEG11~12.
- ◆ You cannot set SEG11 and SEG12 as F value at the same time.

Setting an indoor unit installation option (suitable for the condition of each installation location)

- Check whether power is supplied or not.
 - When the indoor unit is not plugged in, there should be additional power supply in the indoor unit.
- The panel(display) should be connected to an indoor unit to receive option.
- Set the installation option according to the installation condition of an air conditioner.
 - The default setting of an indoor unit installation option is "020010-100000- 200000-300000".
 - Individual control of a remote controller(SEG20) is the function that controls an indoor unit individually when there is more than one indoor unit.
- Set the indoor unit option by wireless remote controller.

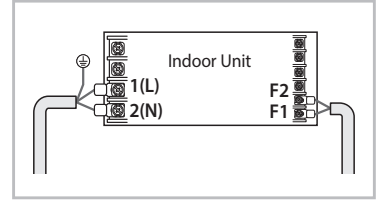

02 series installation option

SEG1	SEG2	SEG3	SEG4	SEG5	SEG6
0	2	-	External room temperature sensor / Minimizing fan operation when thermostat is off	Central control	FAN RPM compensation
SEG7	SEG8	SEG9	SEG10	SEG11	SEG12
1	Drain pump	Hot water heater	-	EEV Step when heating stops	-
SEG13	SEG14	SEG15	SEG16	SEG17	SEG18
2	External control	External control output / External heater On or Off signal	S-Plasma ion	Buzzer	Number of hours using filter
SEG19	SEG20	SEG21	SEG22	SEG23	SEG24
3	Individual control of a remote controller	Heating setting compensation / Removing condensated water in heating mode	EEV Step of stopped unit during oil return/defrost mode	Motion detect sensor	-

- ◆ 1WAY/2WAY/4WAY MODEL : Drain pump(SEG8) will be set to 'USE + 3minute delay' even if the drain pump is set to 0.
- ◆ 1 WAY/2WAY/4WAY,DUCT MODEL : Number of hours using filter(SEG18) will be set to '1000hour' even if the SEG18 is set to except for 2 or 6.
- ◆ When setting the option other than above SEG values, the option will be set as "0".
- ◆ SEG5 central control option is basically set as 1 (Use), so you don't need to set the central control option additionally. However, if the central control is not connected but it doesn't indicate an error message, you need to set the central control option as 0 (Disuse) to exclude the indoor unit from the central control.
- ◆ The output of hot water heater in SEG9 is generated from the hot coil part of the terminal board in duct models.

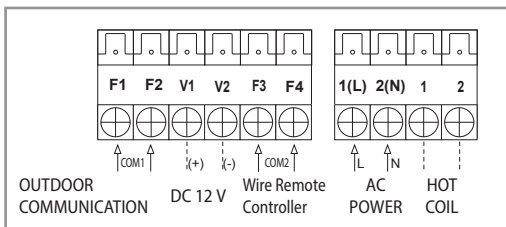

* The output of hot coil terminal is AC 220 V / 230 V
(The same as Indoor Unit's input Power)

- ◆ The external output of SEG15 is generated by MIM-B14 connection. (Refer to the manual of MIM-B14.)

Setting an indoor unit address and installation option (Continued)

■ 02 series installation option(Detailed)

Option No. : 02XXXX-1XXXXX-2XXXXX-3XXXXX

Option	SEG1		SEG2		SEG3		SEG4			SEG5		SEG6						
Explanation	PAGE		MODE		Use of robot cleaning		Use of external room temperature sensor / Minimizing fan operation when thermostat is off			Use of central control		FAN RPM compensation						
Remote Controller Display																		
Indication and Details	Indication	Details	Indication	Details	Indication	Details	Indication	Details		Indication	Details	Indication	Details					
								Use of External room temperature sensor	Minimizing fan operation when thermostat is off									
	0	2	0	Disuse	0	Disuse	0	Disuse	Disuse	0	Disuse	0	Disuse					
					1	Use	1	Use	Disuse			1	Use	1	RPM compensation			
1	Use	1	Use	2	Disuse	2	Disuse	Use (*1)	1	Use	2	High ceiling KIT						
				3	Use	3	Use	Use (*1)										
Option	SEG7		SEG8		SEG9		SEG10			SEG11		SEG12						
Explanation	PAGE		Use of drain pump		Use of hot water heater					EEV Step when heating stops								
Remote Controller Display																		
Indication and Details	Indication	Details	Indication	Details	Indication	Details	Indication	Details		Indication	Details	Indication	Details					
								0	Disuse					0	Disuse	0	Default value	
	1	Use	1	Use	1	Use (*2)	1	Noise decreasing setting										
					2	-							2	-				
2	When an indoor unit stops, drain pump will operate for 3min.	3	Use (*2)	3	Use (*2)													
Option	SEG13		SEG14		SEG15		SEG16			SEG17		SEG18						
Explanation	PAGE		Use of external control		Setting the output of external control / External heater On/Off signal		S-Plasma ion			Buzzer control		Number of hours using filter						
Remote Controller Display																		
Indication and Details	Indication	Details	Indication	Details	Indication	Details		Indication	Details		Indication	Details	Indication	Details				
						Setting the output of external control	External heater On/Off signal											
	2		0	Disuse	0	Thermo on	-	0	Disuse		0	Use buzzer	2	1000 Hour				
					1	Operation on	-								1	Use	1	Disuse buzzer
					2	OFF control	Use (*3)											
3					Window ON/OFF control	Use (*3)												

Option	SEG19	SEG20	SEG21				SEG22		SEG23		SEG24									
Explanation	PAGE	Individual control of a remote controller		Heating setting compensation / Removing condensated water in heating mode			EEV Step of stopped unit during oil return/defrost mode		Motion detect sensor		-									
Remote Controller Display																				
Indication and Details	Indication	Details	Indication	Details	Indication	Details		Indication	Details	Indication	Details									
						Heating Setting Compensation	Removing Condensated Water in Heating Mode													
	3		0 or 1	channel 1	0	Default (*4)	Disuse	0	Default value	0	Disuse									
						2	2°C					Disuse								
						3	5°C					Disuse								
						4	channel 4					3	Default (*4)	Use (*5)						
												4	2°C	Use (*5)						
												5	5°C	Use (*5)						
						1						Oil return or Noise decreasing in defrost mode	1						1	Disuse
																			2	Turn out in 30min. without motion
									3	Turn out in 60min. without motion										
									4	Turn out in 120min. without motion										
									5	Turn out in 180min. without motion										
									6	Turn out in 30min. without motion or *advanced function										
									7	Turn out in 60min. without motion or *advanced function										
									8	Turn out in 120min. without motion or *advanced function										

* Advanced function: Controlling cooling/heating current or power saving with motion detect.

(*)1 Minimizing fan operation when thermostat is off

- Fan operates for 20 seconds at an interval of 5 minutes in heat mode.

(*)2 1: Fan is turned on continually when the hot water heater is turned on,

3: Fan is turned off when the hot water heater is turned on with cooling only indoor unit

Cooling only indoor unit: To use this option, install the Mode Select switch (MCM-C200) on the outdoor unit and fix it as cool mode.

(*)3 When the following 2 or 3 is used as external heater On/Off signal, the signal for monitoring external contact control will not be output.

2: Fan is turned on continually when the external heater is turned on,

3: Fan is turned off when the external heater is turned on with cooling only indoor unit

Cooling only indoor unit: To use this option, install the Mode Select switch (MCM-C200) on the outdoor unit and fix it as cool mode.

※ If Fan is set to off for cooling only indoor unit by setting the SEG9=3 or SEG15=3, you need to use an external sensor or wired remote controller sensor to detect indoor temperature exactly.

(*)4 Default setting value

- 4Way Cassette, Mini 4Way Cassette: 5 °C

- Other indoor units: 2 °C

(*)5 This function can be applied to 4 Way Cassette and Mini 4 Way Cassette only. If the air conditioner operates the heating mode immediately after finishing the cooling mode, the condensated water in the drain pan becomes water vapor by the heat of the indoor unit heat exchanger. Since the water vapor might be condensed on the indoor unit, which may fall into a living space, use this function to get rid of the water vapor out of the indoor unit by operating the fan (for maximum 20 minutes) even when the indoor unit is turned off after cooling mode is turned to heating mode.



◆ Do not install the electronic heater in the flow channel of the indoor unit fan.

Electronic heater should not be installed.

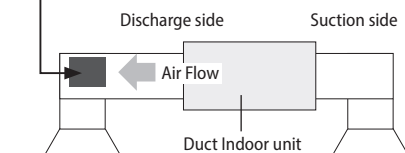





Setting an indoor unit address and installation option (Continued)

05 series installation option

SEG1	SEG2	SEG3	SEG4	SEG5	SEG6
0	5	Use of Auto Change Over for HR only in Auto mode	(When setting SEG3) Standard heating temp. Offset	(When setting SEG3) Standard cooling temp. Offset	(When setting SEG3) Standard for mode change Heating → Cooling
SEG7	SEG8	SEG9	SEG10	SEG11	SEG12
1	(When setting SEG3) Standard for mode change Cooling → Heating	(When setting SEG3) Time required for mode change	Compensation option for Long pipe or height difference between indoor units	-	-
SEG13	SEG14	SEG15	SEG16	SEG17	SEG18
2	-	-	-	-	Control variables when using hot water / external heater
SEG19	SEG20	SEG21	SEG22	SEG23	SEG24
3	-	-	-	-	-

05 series installation option(Detailed)

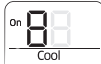
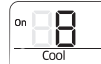
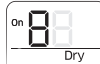
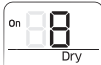
Option No. : 05XXXX-1XXXXX-2XXXXX-3XXXXX

Option	SEG1	SEG2	SEG3	SEG4	SEG5	SEG6																							
Explanation	PAGE	MODE	Use of Auto Change Over for HR only in Auto mode	(When setting SEG3) Standard heating temp. Offset	(When setting SEG3) Standard cooling temp. Offset	(When setting SEG3) Standard for mode change Heating → Cooling																							
Remote Controller Display																													
Indication and Details	Indication	Details	Indication	Details	Indication	Details	Indication	Details	Indication	Details	Indication	Details																	
													0	Follow product option	0	0	0	0	0	1									
													1	Use Auto Change Over for HR only	1	0.5	1	0.5	1	1.5									
															2	1	2	1	2	2									
															3	1.5	3	1.5	3	2.5									
															4	2	4	2	4	3									
															5	2.5	5	2.5	5	3.5									
															6	3	6	3	6	4									
7	3.5	7	3.5	7	4.5																								
Option	SEG7	SEG8	SEG9	SEG10	SEG11	SEG12																							
Explanation	PAGE	(When setting SEG3) Standard for mode change Cooling → Heating	(When setting SEG3) Time required for mode change	Compensation option for Long pipe or height difference between indoor units																									
Remote Controller Display																													
Indication and Details	Indication	Details	Indication	Details	Indication	Details	Indication	Details	Indication	Details	Indication	Details																	
													0	1	0	5 min.	0	Use default value											
													1	1.5	1	7 min.	1	1) Height difference ^(*) is more than 30m or 2) Distance ^(*) is longer than 110m											
													2	2	2	9 min.													
													3	2.5	3	11 min.													
													1																
																										4	3	4	13 min.
																										5	3.5	5	15 min.
6	4	6	20 min.																										
7	4.5	7	30 min.	2	1) Height difference ^(*) is 15~30m or 2) Distance ^(*) is 50~110m																								

Option	SEG13	SEG14	SEG15	SEG16	SEG17	SEG18 (*3)					
Explanation						Control variables when using hot water / external heater					
Remote Controller Display											
Indication and Details	2							Indication	Details		
										Set temp. for heater On/Off	Delay time for heater On
									0	At the same time as thermo on	No delay
									1	At the same time as thermo on	10 minutes
									2	At the same time as thermo on	20 minutes
									3	1.5 °C	No delay
									4	1.5 °C	10 minutes
									5	1.5 °C	20 minutes
									6	3.0 °C	No delay
									7	3.0 °C	10 minutes
									8	3.0 °C	20 minutes
									9	4.5 °C	No delay
									A	4.5 °C	10 minutes
									B	4.5 °C	20 minutes
									C	6.0 °C	No delay
D	6.0 °C	10 minutes									
E	6.0 °C	20 minutes									

^{(*)1} Height difference : The difference of the height between the corresponding indoor unit and the indoor unit installed at the lowest place.
For example, When the indoor unit is installed 40m higher than the indoor unit installed at the lowest place, select the option "1".

^{(*)2} Distance : The difference between the pipe length of the indoor unit installed at farthest place from an outdoor unit and the pipe length of the corresponding indoor unit from an outdoor unit.
For example, when the farthest pipe length is 100m and the corresponding indoor unit is 40m away from an outdoor unit, select the option "2". (100 - 40 = 60m)

^{(*)3} Heater operation when the SEG9 of O2 series installation option is set to using hot water heater or when SEG15 is set to using external heater

e.g. 1) Setting O2 series SEG9 = "1" / Setting O5 series SEG18 = "0": Hot water heater is turned on at the same time as the heating thermostat is on, and turned off when the heating thermostat is off.

e.g. 2) Setting O2 series SEG15 = "2" / Setting O5 series SEG18 = "A":
Room temp. ≤ set temp. + f(heating compensation temp.)
- External heater is turned on when the temperature is maintained as 4.5 °C for 10 minutes.
Room temp. > set temp. + f(heating compensation temp.)
- External heater is turned off when the temperature is maintained as 4.5 °C + 1 °C (1 °C is the Hysteresis for On/Off selection.)

Setting an indoor unit address and installation option (Continued)

SEG 3, 4, 5, 6, 8, 9 additional information

When the SEG 3 is set as "1" and follow Auto Change Over for HR only operation, it will operate as follows.

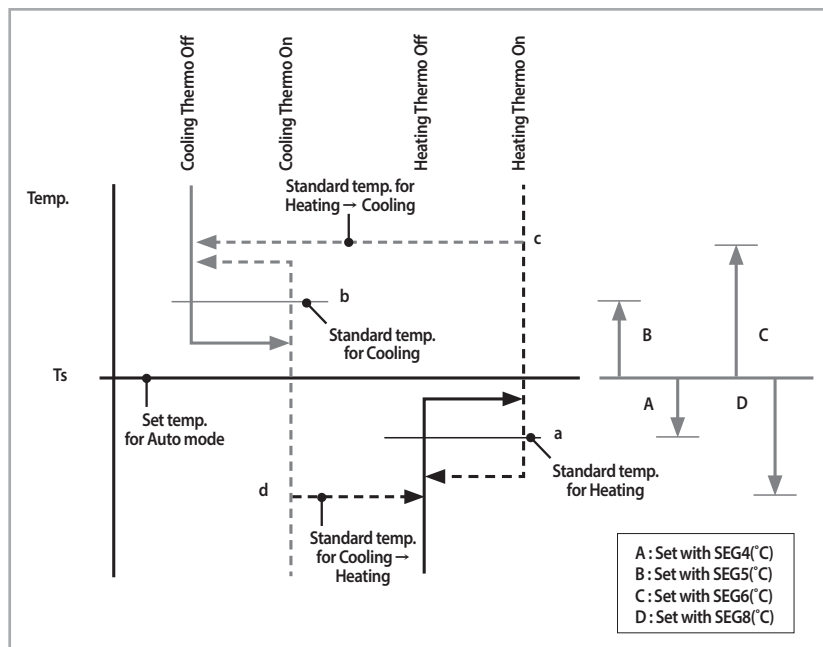

Cooling/Heating mode can be changed when Thermo Off status is maintained during the time with SEG9.

Changing a particular option

You can change each digit of set option.

Option	SEG1		SEG2		SEG3		SEG4		SEG5		SEG6	
Explanation	PAGE		MODE		The option mode you want to change		The tens' digit of an option SEG you will change		The unit digit of an option SEG you will change		The changed value	
Remote Controller Display												
Indication and Details	Indication	Details	Indication	Details	Indication	Details	Indication	Details	Indication	Details	Indication	Details
	0		D		Option mode	1~6	Tens' digit of SEG	0~9	Unit digit of SEG	0~9	The changed value	0~F

- Note**
- When changing a digit of an indoor unit address setting option, set the SEG3 as 'A'.
 - When changing a digit of indoor unit installation option, set the SEG3 as '2'.

Ex) When setting the 'buzzer control' into disuse status.

Option	SEG1		SEG2		SEG3		SEG4		SEG5		SEG6	
Explanation	PAGE		MODE		The option mode you want to change		The tens' digit of an option SEG you will change		The unit digit of an option SEG you will change		The changed value	
Indication	0		D		2		1		7		1	



- ◆ **If you are using heat pump model, mixed operation mode (two or more indoor units operating in different operation mode simultaneously) is not available when the indoor units are connected to same outdoor unit. If you set the master indoor unit with a remote controller, outdoor unit will operate in the mode which was set in the master indoor unit.**

Final Checks and User Tips

To complete the installation, perform the following checks and tests to ensure that the air conditioner operates correctly.

- 1 Check the followings.
 - ◆ Strength of the installation site
 - ◆ Tightness of pipe connection to detect a gas leak
 - ◆ Electric wiring connections
 - ◆ Heat-resistant insulation of the pipe
 - ◆ Drainage
 - ◆ Earth conductor connection
 - ◆ Correct operation (follow the steps below)
-

After finishing the installation of the air conditioner, you should explain the following to the user. Refer to appropriate pages in the User's Manual.

- 1 How to start and stop the air conditioner
 - 2 How to select the modes and functions
 - 3 How to adjust the temperature and fan speed
 - 4 How to adjust the airflow direction
 - 5 How to set the timers
 - 6 How to clean and replace the filters
-

Note When you complete the installation successfully, hand over the User's Manual and this Installation Manual to the user for storage in a handy and safe place.

Troubleshooting





Detection of errors

- ◆ If an error occurs during the operation, an LED flickers and the operation is stopped except the LED.
- ◆ If you re-operate the air conditioner, it operates normally at first, then detect an error again.

LED Display on the receiver & display unit

LED Display

1 Way cassette / 2 Way cassette





Abnormal condition	Error code	LED Display				
						
		Green (*Ice Blue)	Red (*Yellow Green)			
Error on indoor temperature sensor (Short or Open)	E121	×	×	●	×	×
1. Error on Eva-in sensor (Short or Open)	E122					
2. Error on Eva-out sensor (Short or Open)	E123	●	×	●	×	×
3. Discharge sensor error (Short or Open)	E126					
Indoor fan error	E154	×	×	×		×
1. Error on outdoor temperature sensor (Short or Open)	E221					
2. Error on cond sensor	E237					
3. Error on discharge sensor	E251	●	×	×	●	×
Other outdoor unit sensor error that is not on the above list						
1. When there is no communication between the indoor-outdoor units for 2 minutes	E101					
2. Communication error received from the outdoor unit	E102					
3. 3 minute tracking error on outdoor unit	E202					
4. Communication error after tracking due to unmatching number of installed units	E201	×	×	●	●	×
5. Error due to repeated communication address	E108					
6. Communication address not confirmed	E109					
Other outdoor unit communication error that is not on the above list						
Self diagnosis error display						
1. Error due to opened EEV (2nd detection)	E151					
2. Error due to closed EEV (2nd detection)	E152					
3. Eva in sensor is detached	E128	×	×	●	●	●
4. Eva out sensor is detached	E129					
5. Thermal fuse error (Open)	E198					

● On ● Flickering × Off

- ◆ If you turn off the air conditioner when the LED is flickering, the LED is also turned off.
- ◆ If you re-operate the air conditioner, it operates normally at first, then detect an error again.
- ◆ When E108 error occurs, change the address and reset the system.
Ex.) When address of the indoor unit #1 and #2 are set as 5, address of the indoor unit #1 will become 5 and indoor unit #2 will display E108, A002.
- ◆ When error occurs on AM***HN1DEH*/AM***JN1DEH* model, open the horizontal blade to see the LED.
* The LED color of AM***HN1DEH*/AM***JN1DEH* model.

Troubleshooting(Continued)





■ 1 Way cassette / 2 Way cassette(Continued)

Abnormal condition	Error code	LED Display				
						
		Green (*Ice Blue)	Red (*Yellow Green)			
1. COND mid sensor is detached	E241					
2. Refrigerant leakage (2nd detection)	E554					
3. Abnormally high temperature on Cond (2nd detection)	E450					
4. Low pressure s/w (2nd detection)	E451					
5. Abnormally high temperature on discharged air on outdoor unit (2nd detection)	E416					
6. Indoor operation stop due to unconfirmed error on outdoor unit	E559					
7. Error due to reverse phase detection	E425					
8. Comp stop due to freeze detection (6th detection)	E403	×	×	●	●	●
9. High pressure sensor is detached	E301	×	×	●	●	●
10. Low pressure sensor is detached	E306					
11. Outdoor unit copression ration error	E428					
12. Outdoor sump down_1 prevetion control	E413					
13. Compressor down due to low pressure sensor prevention control_1	E410					
14. Simultaneous opening of cooling/heating MCU SOL valve (1st detection)	E180					
15. Simultaneous opening of cooling/heating MCU SOL valve (2nd detection)	E181					
Other outdoor unit self-diagnosis error that is not on the above list						
Flowating s/w (2nd detection)	E153	×	×	×	●	●
EEPROM error	E162	●	●	●	●	●
EEPROM option error	E163	●	●	●	●	●
Error due to incompatible indoor unit	E164	×	×	×	×	●

● On ● Flickering × Off

- ◆ If you turn off the air conditioner when the LED is flickering, the LED is also turned off.
- ◆ If you re-operate the air conditioner, it operates normally at first, then detect an error again.
- ◆ When E108 error occurs, change the address and reset the system.
Ex.) When address of the indoor unit #1 and #2 are set as 5, address of the indoor unit #1 will become 5 and indoor unit #2 will display E108, A002.
- ◆ When error occurs on AM***HN1DEH*/AM***JN1DEH* model, open the horizontal blade to see the LED.
* The LED color of AM***HN1DEH*/AM***JN1DEH* model.

■ 4 Way cassette

Abnormal condition	Error code	LED Display			
		Operation	Defrost	Timer	Filter
					
Error on indoor temperature sensor (Short or Open)	E121	×	●	×	×
1. Error on Eva-in sensor (Short or Open)	E122				
2. Error on Eva-out sensor (Short or Open)	E123	●	●	×	×
3. Discharge sensor error (Short or Open)	E126				
Indoor fan error	E154	×	×	●	×
1. Error on outdoor temperature sensor (Short or Open)	E221				
2. Error on cond sensor	E237	●	×	●	×
3. Error on discharge sensor	E251				
Other outdoor unit sensor error that is not on the above list					

■ 4 Way cassette(Continued)

Abnormal condition	Error code	LED Display			
		Operation	Defrost	Timer	Filter
		⏻	*❄️	🕒	📊
1. When there is no communication between the indoor-outdoor units for 2 minutes	E101				
2. Communication error received from the outdoor unit	E102				
3. 3 minute tracking error on outdoor unit	E202				
4. Communication error after tracking due to unmatching number of installed units	E201	×	●	●	×
5. Error due to repeated communication address	E108				
6. Communication address not confirmed	E109				
Other outdoor unit communication error that is not on the above list					
Self diagnosis error display					
1. Error due to opened EEV (2nd detection)	E151				
2. Error due to closed EEV (2nd detection)	E152	×	●	●	●
3. Eva in sensor is detached	E128				
4. Eva out sensor is detached	E129				
5. Thermal fuse error (Open)	E198				
1. COND mid sensor is detached	E241				
2. Refrigerant leakage (2nd detection)	E554				
3. Abnormally high temperature on Cond (2nd detection)	E450				
4. Low pressure s/w (2nd detection)	E451				
5. Abnormally high temperature on discharged air on outdoor unit (2nd detection)	E416				
6. Indoor operation stop due to unconfirmed error on outdoor unit	E559				
7. Error due to reverse phase detection	E425				
8. Comp stop due to freeze detection (6th detection)	E403				
9. High pressure sensor is detached	E301	×	●	●	●
10. Low pressure sensor is detached	E306				
11. Outdoor unit copression ration error	E428				
12. Outdoor sump down_1 prevetion control	E413				
13. Compressor down due to low pressure sensor prevention control_1	E410				
14. Simultaneous opening of cooling/heating MCU SOL valve (1st detection)	E180				
15. Simultaneous opening of cooling/heating MCU SOL valve (2nd detection)	E181				
Other outdoor unit self-diagnosis error that is not on the above list					
Flowating s/w (2nd detection)	E153	×	×	●	●
EEPROM error	E162	●	●	●	●
EEPROM option error	E163	●	●	●	●
Error due to incompatible indoor unit	E164	●	●	×	●

● On ● Flickering × Off

- ◆ If you turn off the air conditioner when the LED is flickering, the LED is also turned off.
- ◆ If you re-operate the air conditioner, it operates normally at first, then detect an error again.
- ◆ When E108 error occurs, change the address and reset the system.
Ex.) When address of the indoor unit #1 and #2 are set as 5, address of the indoor unit #1 will become 5 and indoor unit #2 will display E108, A002.

SAMSUNG

This product is RoHS compliant