



AM050FNKDEH
AM100FNKDEH

ERV Plus (ERV with DX-COIL) user & installation manual

imagine the possibilities

Thank you for purchasing this Samsung product.

SAMSUNG

Contents

USING PARTS

Safety precautions	5
Checking before use	14
Checking the name of the parts	16
Basic operation	21
Cleaning and maintaining the unit	24
Cleaning and maintaining the product	27
Maintaining your product	28
Appendix	29

INSTALLATION PARTS

Safety precautions	31
Accessories	34
Selecting the installation location	34
Indoor unit installation	36
Purging the unit	37
Connecting the refrigerant pipe	37
Cutting/flaring the pipe	38
Performing leak test & insulation	39
Drain pipe and drain installaton	41
Drain pipe and drain hose installaton	42
Duct connection	43
Wiring work	44
Indoor unit setting	49
Setting an indoor unit address and installation option	50
Additional functions	61
Trial operation	62
Final checks and user tips	64
Troubleshooting	65
Wired Remote Controller Installation/Service Mode	66

How to use this unit

This unit should be used with air conditioners. Air conditioning is impossible only by this unit, because this unit does not have temperature control function. (It's capacity is too small in order to control the room temperature to the whole) And should be operated in combination with standard indoor units. (Interlocked operation) Independent operation is possible, however, temperature setting by remote controller is impossible. In this ON/OFF operation by thermostat depends on factory setting, however, this value is changeable by installation/service mode on site. Model selection should be done not by cooling capacity but by ventilating air flow rate.

Refer to following capacities when using the product with outdoor unit:

AM050FNKDEH - 3.6kW, AM100FNKDEH - 7.1 kW



Correct Disposal of This Product (Waste Electrical & Electronic Equipment)

(Applicable in countries with separate collection systems)

This marking on the product, accessories or literature indicates that the product and its electronic accessories (e.g. charger, headset, USB cable) should not be disposed of with other household waste at the end of their working life. To prevent possible harm to the environment or human health from uncontrolled waste disposal, please separate these items from other types of waste and recycle them responsibly to promote the sustainable reuse of material resources.

Household users should contact either the retailer where they purchased this product, or their local government office, for details of where and how they can take these items for environmentally safe recycling.

Business users should contact their supplier and check the terms and conditions of the purchase contract. This product and its electronic accessories should not be mixed with other commercial wastes for disposal.







For information on Samsung's environmental commitments and product specific regulatory obligations e.g. REACH visit: samsung.com/uk/aboutsamsung/samsungelectronics/corporatecitizenship/data_corner.html

Safety precautions

Before using your new product, please read this manual thoroughly to ensure that you know how to safely and efficiently operate the extensive features and functions of your new appliance.

Because the following operating instructions cover various models, the characteristics of your product may differ slightly from those described in this manual. If you have any questions, call your nearest contact center or find help and information online at www.samsung.com.

Important safety symbols and precautions:

 WARNING	Hazards or unsafe practices that may result in severe personal injury or death.
 CAUTION	Hazards or unsafe practices that may result in minor personal injury or property damage.
	Follow directions.
	Do NOT attempt.
	Make sure the machine is grounded to prevent electric shock.
	Unplug the power plug from the wall socket.
	Do NOT disassemble.

FOR INSTALLATION **WARNING**

-  **Use the power line with the power specifications of the product or higher and use the power line for this appliance only. In addition, do not use an extension line.**
 - ▶ Extending the power line may result in electric shock or fire.
 - ▶ Do not use an electric transformer. It may result in electric shock or fire.
 - ▶ If the voltage/frequency/rated current condition is different, it may cause fire.

! **The installation of this appliance must be performed by a qualified technician or service company.**

- ▶ Failing to do so may result in electric shock, fire, explosion, problems with the product, or injury.

Install a switch and circuit breaker dedicated to the product.

- ▶ Failing to do so may result in electric shock or fire.

Fix the outdoor unit firmly so that the electric part of the outdoor unit is not exposed.

- ▶ Failing to do so may result in electric shock or fire.

⊘ Do not install this appliance near a heater, inflammable material. Do not install this appliance in a humid, oily or dusty location, in a location exposed to direct sunlight and water (rain drops). Do not install this appliance in a location where gas may leak.

- ▶ This may result in electric shock or fire.

Never install the outdoor unit in a location such as on a high external wall where it could fall.

- ▶ If the outdoor unit falls, it may result in injury, death or property damage.

⚡ This appliance must be properly grounded. Do not ground the appliance to a gas pipe, plastic water pipe, or telephone line.

- ▶ Failure to do so may result in electric shock, fire, an explosion, or other problems with the product.
- ▶ Never plug the power cord into a socket that is not grounded correctly and make sure that it is in accordance with local and national codes.

Safety precautions

FOR INSTALLATION CAUTION

 **Install your appliance on a level and hard floor that can support its weight.**

▶ Failing to do so may result in abnormal vibrations, noise, or problems with the product.

Install the draining hose properly so that water is drained correctly.

▶ Failing to do so may result in water overflowing and property damage.

When installing the outdoor unit, make sure to connect the draining hose so that draining is performed correctly.

▶ The water generated during the heating operation by the outdoor unit may overflow and result in property damage.

In particular, in winter, if a block of ice falls, it may result in injury, death or property damage.

 **Do not let the discharged air go back to the indoor through its air suction hole. It can contaminate indoor air.**

Do not connect the electric heater to the product.

Hang down a blockage for bird in front of outdoor air suction duct. If something such as bird's nest blocks the air suction duct, it may result in oxygen shortage in indoors.

FOR POWER SUPPLY WARNING

 **When the circuit breaker is damaged, contact your nearest service center.**

- ⊘ **Do not pull or excessively bend the power line. Do not twist or tie the power line. Do not hook the power line over a metal object, place a heavy object on the power line, insert the power line between objects, or push the power line into the space behind the appliance.**

- ▶ This may result in electric shock or fire.

FOR POWER SUPPLY CAUTION

- ⊘ **When not using the product for a long period of time or during a thunder/lightning storm, cut the power at the circuit breaker.**

- ▶ Failing to do so may result in electric shock or fire.

FOR USING WARNING

- ⊘ **If the appliance is flooded, please contact your nearest service center.**

- ▶ Failing to do so may result in electric shock or fire.

If the appliance generates a strange noise, a burning smell or smoke, unplug the power plug immediately and contact your nearest service center.

- ▶ Failing to do so may result in electric shock or fire.

In the event of a gas leak (such as LNG, LPG or Liquefied natural gas, Liquefied petroleum gas, etc.), ventilate immediately without touching the power line. Do not touch the appliance or power line.

- ▶ Do not use a ventilating fan.

- ▶ A spark may result in an explosion or fire.

Safety precautions

FOR USING

WARNING

- ❗ **To reinstall the product, please contact your nearest service center.**
 - ▶ Failing to do so may result in problems with the product, water leakage, electric shock, or fire.
 - ▶ A delivery service for the product is not provided. If you reinstall the product in another location, additional construction expenses and an installation fee will be charged.
 - ▶ Especially, when you wish to install the product in an unusual location such as in an industrial area or near the seaside where it is exposed to the salt in the air, please contact your nearest service center.

- ⊘ **Do not touch the circuit breaker with wet hands.**
 - ▶ This may result in electric shock.
- Do not strike or pull the product with excessive force.**
 - ▶ This may result in fire, injury, or problems with the product.
- Do not place an object near the outdoor unit that allows children to climb onto the machine.**
 - ▶ This may result in children seriously injuring themselves.
- Do not turn the product off with the circuit breaker while it is operating.**
 - ▶ Turning the product off and then on again with the circuit breaker may cause a spark and result in electric shock or fire.
- After unpacking the product, keep all packaging materials well out of the reach of children, as packaging materials can be dangerous to children.**
 - ▶ If a child places a bag over its head, it may result in suffocation.
- Do not insert your fingers or foreign substances into the air inlet/outlet of the product.**

- ⊘ ▶ Take special care that children do not injure themselves by inserting their fingers into the product.

Do not use the product as a ventilator for a burner.

- ▶ If you use a burner with gas or gasoline, you need to have separate ventilation system for the combustible apparatus.

⊘ **If any foreign substance such as water has entered the appliance, cut the power by unplugging the power plug and turning the circuit breaker off and then contact your nearest service center.**

- ▶ Failing to do so may result in electric shock or fire.

⊘ **Do not attempt to repair, disassemble, or modify the appliance yourself.**

- ▶ Do not use any fuse (such as cooper, steel wire, etc.) other than the standard fuse.
- ▶ This may result in electric shock, fire, problems with the product, or injury.

FOR USING

⚠ CAUTION

⊘ **Do not place objects or devices under the indoor unit.**

- ▶ Water dripping from the indoor unit may result in fire or property damage.

Check that the installation frame of the outdoor unit is not broken at least once a year.

- ▶ Failing to do so may result in injury, death or property damage.

Max current is measured according to IEC standard for safety and current is measured according to ISO standard for energy efficiency.

Safety precautions

FOR USING

CAUTION

 **Do not stand on top of the appliance or place objects (such as laundry, lighted candles, lighted cigarettes, dishes, chemicals, metal objects, etc.) on the appliance.**

▶ This may result in electric shock, fire, problems with the product, or injury.

Do not operate the appliance with wet hands.

▶ This may result in electric shock.

Do not spray volatile material such as insecticide onto the surface of the appliance.

▶ As well as being harmful to humans, it may also result in electric shock, fire or problems with the product.

Do not drink the water from the product.

▶ The water may be harmful to humans.

Do not apply a strong impact to the remote controller and do not disassemble the remote controller.

Do not touch the pipes connected with the product.

▶ This may result in burns or injury.

Do not use this product to preserve precision equipment, food, animals, plants or cosmetics, or for any other unusual purposes.

▶ This may result in property damage.

Avoid directly exposing humans, animals or plants from the air flow from the product for long periods of time.

▶ This may result in harm to humans, animals or plants.

- ⊘ This appliance is not intended for use by persons (including children) with reduced physical, sensory or mental capabilities, or lack of experience and knowledge, unless they have been given supervision or instruction concerning use of the appliance by a person responsible for their safety. Children should be supervised to ensure that they do not play with the appliance.

For use in Europe : This appliance can be used by children aged from 8 years and above and persons with reduced physical, sensory or mental capabilities or lack of experience and knowledge if they have been given supervision or instruction concerning use of the appliance in a safe way and understand the hazards involved. Children shall not play with the appliance. Cleaning and user maintenance shall not be made by children without supervision

Safety precautions

FOR CLEANING

WARNING

 **Do not clean the appliance by spraying water directly onto it. Do not use benzene, thinner or alcohol to clean the appliance.**

▶ This may result in discoloration, deformation, damage, electric shock or fire.

Before cleaning or performing maintenance, unplug the product from the wall socket and wait until the fan stops.

▶ Failing to do so may result in electric shock or fire.

FOR CLEANING

CAUTION

 **Take care when cleaning the surface of the heat exchanger of the outdoor unit since it has sharp edges.**

▶ To avoid cutting your fingers, wear thick cotton gloves when cleaning it.

 **Do not clean the inside of the product by yourself.**

▶ For cleaning inside the appliance, contact your nearest service center.

▶ When cleaning the internal filter, refer to the descriptions in the 'Cleaning and maintaining the unit' section.

▶ Failure to do so may result in damage, electric shock or fire.

Checking before use

Checking Up the Sub Power Supply

The sub power supply is a device to prevent electric leakage due to the over current. Install the sub power supply separately near the unit and turn it off when you clean the unit or you do not use the unit for a long period of time.

- ▶ Turn on the sub power supply which is installed separately.
 - The sub power supply is not supplied with the unit.
 - Purchase the sub power supply individually.

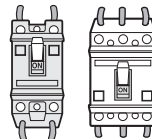

- If the circuit breaker (MCCB, ELB) is installed, the sub power supply does not need to be installed mandatorily.

Install & Operation Ranges

Install condition	Outdoor air condition	Indoor air condition
0~40 °C, 80 %RH below	-15~40 °C, 80 %RH below	0~40 °C, 80 %RH below



- If the unit is operated under the condition other than are indicated, it may not operate due to the protective device in the unit. Especially, if outside temperature is under -15 °C, the unit does not operate at all.
- Do not operate the unit when typhoon comes. Water may get in the room through the unit due to the rain and heavy winds.
- Avoid operating the unit in indoor or outdoor with high temperature and humidity since dew may form on the internal part of the product, including the heat exchanger. Especially avoid using it during the long rainy period in the summer.

Maintaining your product

Internal protections via the unit control system

- ▶ This internal protection operates if an internal fault occurs in the product.

Type	Description
Against cold air	The internal fan will be off to against cold air when the heat pump is heating.
De-frost cycle	The internal fan will be off to against cold air when the heat pump is heating.
Anti-protection of internal battery	The compressor will be off to protect internal battery when the product operates in Cool mode.
Protect compressor	The product does not start operating immediately to protect the compressor of the outdoor unit after it has been started.



- If the heat pump is operating in Heat mode, De-ice cycle is actuated to remove frost from an outdoor unit that may have deposited at low temperatures.
The internal fan is switched off automatically and restarted only after the de-ice cycle is completed.
When the outdoor air suction temperature becomes lower than -10 °C, the unit is changed to intermittent operation to prevent freezing of the heat exchanger element and dew condensation within the unit.

Checking before use

Tips on using product

Here are some tips that you would follow when using your product.

TOPIC	RECOMMENDATION
Heat-EX Mode	<ul style="list-style-type: none">• Energy loss is minimized by recovering energy exhausted when indoor heating and cooling
Quiet Mode	<ul style="list-style-type: none">• This allows you to have quiet sleep and fresh air while sleeping.• The ERV operation lamp will also be less bright.
Away Mode	<ul style="list-style-type: none">• This allows you to operate the ERV while you are away from home.• If the operational status is changed by another controller, the Away mode is canceled.
By-Pass Mode	<ul style="list-style-type: none">• The ventilation method is used when temperature gap of indoor and outdoor is not big.• Outdoor air flows into indoor.
Auto Mode	<ul style="list-style-type: none">• The air is automatically changed depending on the degree of pollution in the indoor air. (Available only when the additional CO₂ sensor is installed)
Energy saving	<ul style="list-style-type: none">• Make operating condition for optimized energy saving.
Clean up	<ul style="list-style-type: none">• Prevent the odor and dust of other places such as bathroom and kitchen from entering inside by making the supply air greater than the exhaust air. (You can reverse this procedure to make the exhaust air bigger than the supply air.)
Cooling / Heating	<ul style="list-style-type: none">• You can have cooling and heating operation through the DX-COIL.• This unit should be used with air conditioners. Air conditioning is impossible only by this unit, because this unit does not have temperature control function. (It's capacity is too small in order to control the room temperature to the whole) and should be operated in combination with standard indoor units.• When a remote controller is only connected to the ERV with DX-COIL, independent operation is possible. However, temperature setting by remote controller is not possible.• In this ON/OFF operation by thermostat depends on factory setting. However, this value is changeable by installation/service mode on site.
Frost & De-frost	<ul style="list-style-type: none">• When the product runs in Heat mode, due to temperature difference between the unit and the outside air, frost will form. If this happens:<ul style="list-style-type: none">- The product stops heating.- The product will operate automatically in De-ice mode for 10 minutes.- The steam produced on the outdoor unit in De-ice mode is safe.No intervention is required; after about 10 minutes, the product operates again normally. *The unit will not operate when it starts to de-ice.
High indoor/outdoor temperatures	<ul style="list-style-type: none">• If both indoor and outdoor temperatures are high and the product is running in Heat mode, the outdoor unit's fan and compressor may stop at times. This is normal; wait until the product turns on again.
Power failure	<ul style="list-style-type: none">• If a power failure occurs during the operation of the product, the operating immediately stops and unit will be off. When power returns, the product will run automatically.
Protection mechanism	<ul style="list-style-type: none">• After the compressor has stopped or the power supply has been switched on, the compressor will not run for 3 minutes for its protection therefore cool/warm air does not come out of the unit immediately.

Checking the name of the parts

Main parts

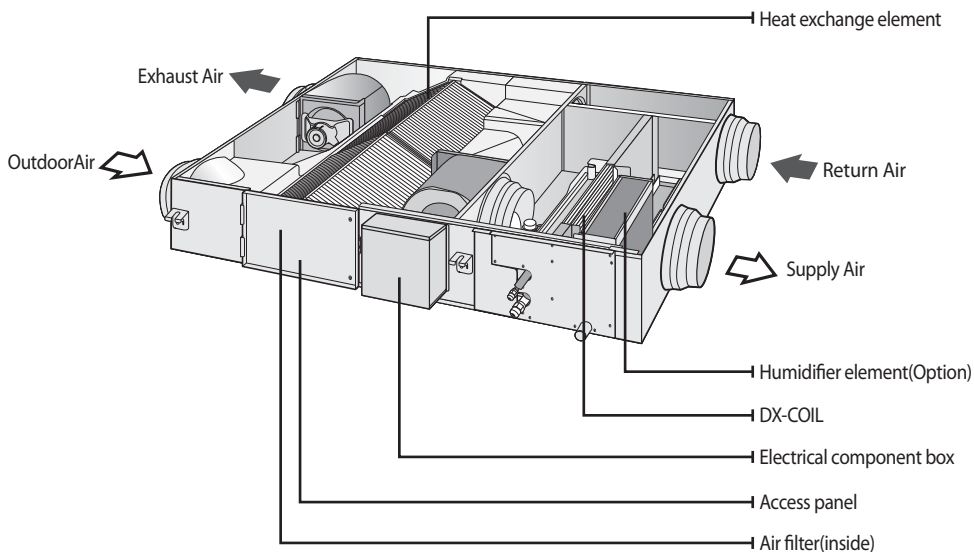

Inspection hole

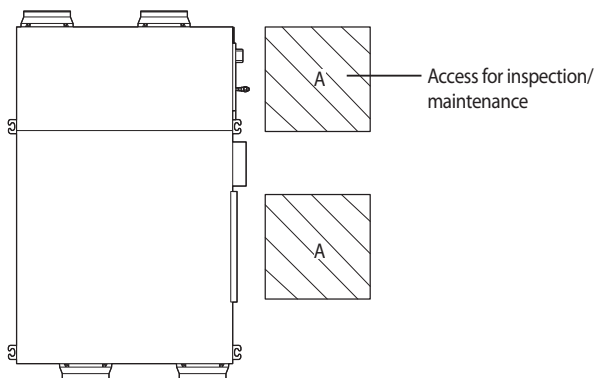

Model	'A' (mm)
AM050FNKDEH	450 x 450
AM100FNKDEH	550 x 550

- ▶ There is access for inspection/maintenance for cleaning the air filter and the heat exchanger element.
- ▶ Lack of installation and maintenance spaces may cause injury or malfunction.
- ▶ There is also access for inspection/maintenance of the DX-coil and humidifier element.









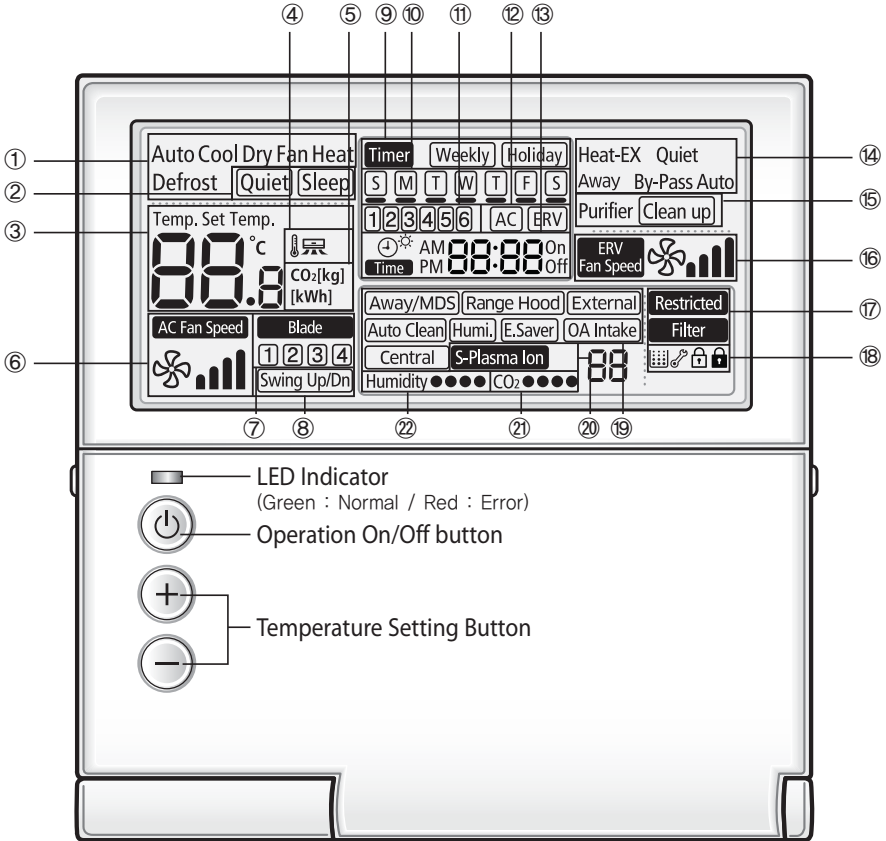











Checking the name of the parts

For detailed instruction, refer to the wired remote controller user manual.

- ▶ Wired remote controller (not supplied)
- ▶ Model: MWR-WE10N

Display









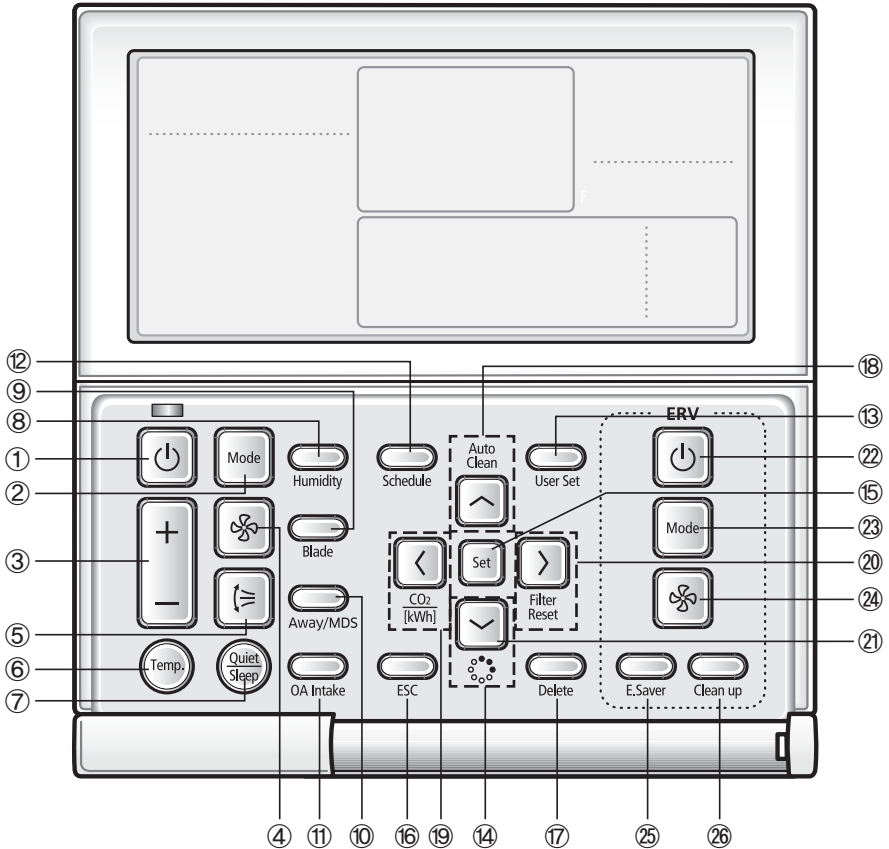











Classification	Indication	Function
Product Related Information	① Auto Cool Dry Fan Heat Defrost	Displays System operation
	② 	Displays Quiet/Sleep operation
	③ Temp. Set Temp. 	Displays Indoor temperature/Set temperature
	④ 	Displays discharge temperature control
	⑤ 	Displays CO ₂ /power consumption
	⑥ 	Displays AC fan speed
	⑦ 	Displays Blade selection
	⑧ 	Displays Air swing(Up/Dn)
Schedule related information	⑨ 	Weekly schedule/Holiday setting displays
	⑩ 	Displays Current day(□) or scheduled day(○)
	⑪ 	Displays Schedule number
	⑫ 	Displays Scheduled device selection
	⑬ 	Displays Current time/summer time/scheduled time
Ventilator (ERV) related information	⑭ Heat-EX Quiet Away By-Pass Auto Purifier	Displays Ventilator(ERV) operation
	⑮ 	Displays Clean up
	⑯ 	Displays Ventilator(ERV) fan speed
Common function related information	⑰ 	Displays Invalid operation /Filter cleaning (filter cleaning period)
	⑱ 	Displays Dust box cleaning alert/check/partial locking/full locking
	⑲ 	Displays Away/Motion detect sensor/Range hood/External interconnection control/Auto clean/ Humidifying/Energy saving/Outdoor air supply intake/ Central control
	⑳ 	Displays S-Plasma Ion
	㉑ 	Displays Indoor CO ₂ density
	㉒ 	Displays Indoor humidity

Checking the name of the parts

Buttons



Classification	Button	Function		
Unit Related Information	①		Operation On/Off button	Turns the unit power On/Off
	②		Mode button	Selects the desired unit operation
	③		Temperature setting button	Sets the desired temperature
	④		Fan speed button	Changes the unit fan speed
	⑤		Air Swing button	Changes the air flow direction to move upward or downward
	⑥		Temp. button	Checks the indoor temperature
	⑦		Quiet/Sleep button	Selects Quiet or Sleep operation for the unit

Classification	Button	Function	
Unit Related Information	⑧  Humidity	Humidity button	Turns the AHU humidifying function On/Off
	⑨  Blade	Blade button	Selects a blade for individual control
	⑩  Away/MDS	Away / Motion detect sensor button	Selects when no one is detected in an indoor area, when the air conditioner needs to be turned off automatically, when the AWAY operation is set
	⑪  OA Intake	Outdoor air intake	Select the AHU Outdoor intake function
Special Function Displays	⑫  Schedule	Schedule Button	Select the schedule setting function
	⑬  User Set	User Set Button	Select the detailed setting function
	⑭ 	Navigational buttons	Move between items or change the item value
	⑮  Set	Set button	Save your new settings
	⑯  ESC	ESC button	Return to general mode from schedule and detailed setting screens
	⑰  Delete	Delete button	Cancel the schedule setting
	⑱  Auto Clean	Auto Clean button	Use the auto cleaning function for your unit
	⑲  CO ₂ [kWh]	CO ₂ /[kWh] button	Display the amount of CO ₂ and the power consumption
	⑳  Filter Reset	Filter Reset button	Turn off the filter cleaning displays (filter using time reset)
	㉑  S-Plasma Ion	S-Plasma Ion button	Choose the S-Plasma Ion function
Ventilator (ERV) Related Buttons	㉒  Operation On/Off	Operation On/Off button	Turn the Ventilator(ERV) On/Off
	㉓  Mode	Mode button	Select the desired operation for the Ventilator(ERV)
	㉔  Fan speed	Fan speed button	Change the fan speed for your Ventilator(ERV)
	㉕  E.Saver	E.Saver button	Begin Energy Saving Operation
	㉖  Clean up	Clean up button	Select air purification through the in/out load controls



NOTE

- After cleaning the filter, please press the **Filter Reset** button. The **Filter** lamp will turn off, and it will be turned on again upon the next cleaning period.
- If you press a functional button not supported by the unit, then the **Restricted** lamp will turn on.
- If the temperature display setting is set to indoor temperature and you press the **Temp.** button, the **Restricted** lamp display will appear. (When you install the wired remote controller, the setting is available.)
- If you press the **On/Off** button when your Ventilator(ERV) is connected to a wired remote controller, then the air conditioner and the Ventilator(ERV) might operate or stop at the same time or only the air conditioner might operate or stop. The factory setting is set to simultaneous operation/stop. (When you install the wired remote controller, the setting is available.)
- Although the air conditioner and the Ventilator(ERV) are set to simultaneous operation/stop, you can individually control the air conditioner and the Ventilator(ERV) by using another controller (e.g. wireless remote controller, central controller, S-net mini) except for a wired remote controller.

Basic operation

Basic operations can be selected after pressing the **Mode** button.

When the wired remote controller is connected to an ERV with DX-COIL and an Air conditioner simultaneously

When controlling an ERV with DX-COIL

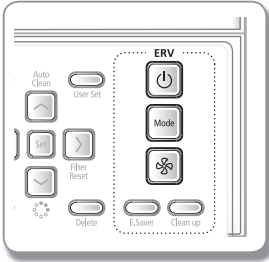





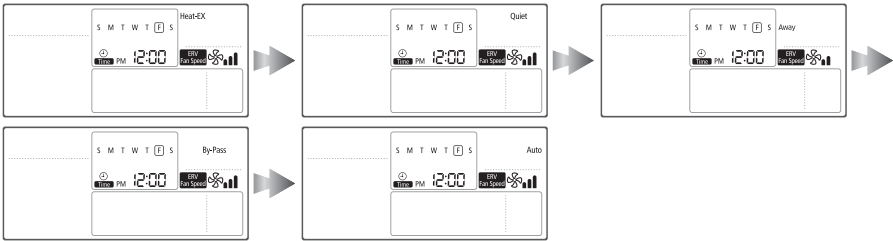









Press the  button to begin the ventilator(ERV) operation.

Press the  button to select the desired operation.



Press the  button to change the fan speed.

Heat-EX	 (High) ▷  (Turbo) ▷  (Medium)
Quiet	Can't change the fan speed.
Away	 (Medium)
By-Pass	 (High) ▷  (Turbo) ▷  (Medium)
Auto	 (High) ▷  (Turbo) ▷  (Medium)

※ After installing a CO₂ sensor in your Ventilator(ERV), you can select from  (High) ▷  (Turbo) ▷  (Auto) ▷  (Medium).
(Exception : Quiet Operation, Away Operation)

When controlling an Air conditioner

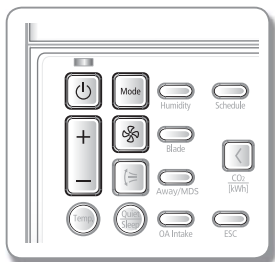





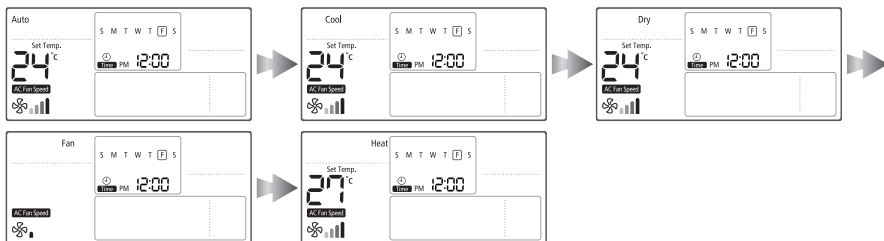









Press the  button to begin operating the air conditioners.

Press the  button to select the desired operation.



Press the  button to select a fan speed.

Auto	 (Auto)
Cool	 (Low),  (Medium),  (High),  (Auto)
Dry	 (Auto)
Fan	 (Low),  (Medium),  (High)
Heat	 (Low),  (Medium),  (High),  (Auto)

Press the  button to set the desired temperature.

Auto	You can adjust the desired temperature by 1 °C within a range of 18 °C~30 °C.
Cool	You can adjust the desired temperature by 1 °C within a range of 18 °C~30 °C.
Dry	You can adjust the desired temperature by 1 °C within a range of 18 °C~30 °C.
Fan	You can't change the desired temperature.
Heat	You can adjust the desired temperature by 1 °C within a range of 16 °C~30 °C.

Basic operation

When controlling an ERV with DX-COIL and Air conditioner simultaneously

▶ Operate the ERV with DX-COIL and Air conditioners separately by referring to the operation of only the ERV with DX-COIL and only the Air conditioner.



- When you operate an ERV with DX-COIL only, cooling and heating operation is impossible.
- When you operate an ERV with DX-COIL and air conditioner at the same time, the ERV with DX-COIL follows the operation of the Air conditioner.

When the wired remote controller is connected to an ERV with DX-COIL only

When you operate the ventilation operation of an ERV with DX-COIL only

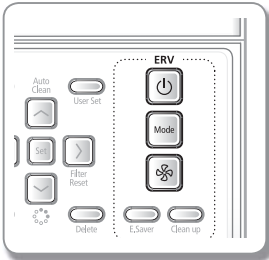

Press the button to begin the ventilator(ERV) operation.

Press the button to select the desired operation.

Press the button to change the fan speed.

When you operate the cooling and heating operation of an ERV with DX-COIL

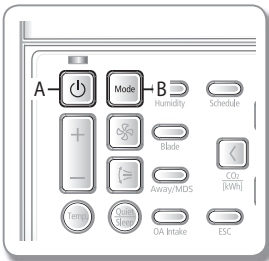

Press the (A or C) button to begin the ventilator(ERV) operation.

Press the (D) button to select the desired ventilator(ERV) operation.

Press the (E) button to change the fan speed.

Press the (B) button to select cooling and heating operation.

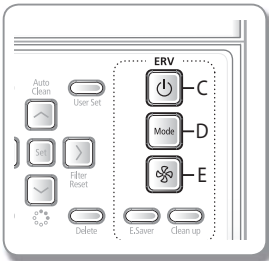

- You cannot set the temperature by an ERV with DX-COIL only.
- You cannot select the dry operation if you operate an ERV with DX-COIL only.

Cleaning and maintaining the unit

Cleaning the Air filter

Clean the air filters at least twice a year. However, the frequency may vary depending on use and environment. Clean the air filters more frequently in dusty place. Make sure that the power supply is disconnected before cleaning the unit.

Remove 2 screws on the access panel.

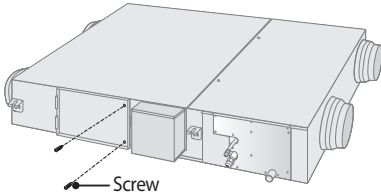

- ▶ Take off the access panel from the unit.
- ▶ Detach the air filters by pulling them forward.
- ▶ There are totally 4 air filters on both sides of the heat exchange element.

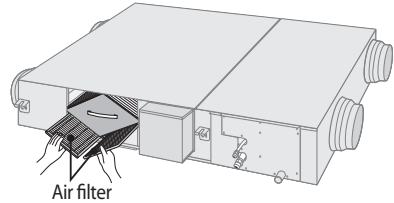

- ▶ Reassemble the air filters and access panel.
- ▶ Make sure to insert the air filters correctly. If not, dust may accumulate on the heat exchange element decreasing the efficiency.

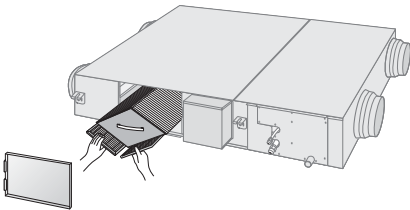

- ▶ Remove all dust on the air filters with a vacuum cleaner or a brush.

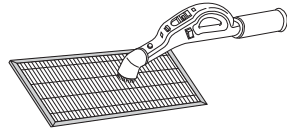

- Change the air filter in every two years. However, changing frequency may vary according to the used period and condition.
- If the air filter is damaged, purchase it individually in a customer care center or an agency that you bought the product.
- Make sure to turn off the power supply.

Cleaning and maintaining the unit

Cleaning the Heat Exchange Element

Clean the Heat exchange element at least twice a year. However, the frequency may vary depending on use and environment. Clean the Heat exchange element more frequently in dusty place. Make sure that the power supply is disconnected before cleaning the unit.

- ▶ Remove 2 screws on the access panel.

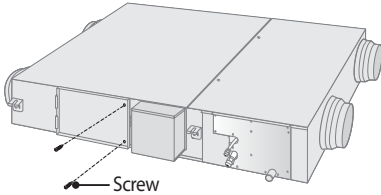

- ▶ Take off the access panel from the unit.
- ▶ Detach the 2 heat exchange elements in order.
- ▶ The heat exchange element is heavy. Take care not to drop it.
- ▶ There are 2 heat exchange elements in the unit. Make sure clean them at once.

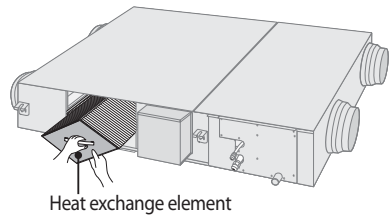

- ▶ Remove all dust and particles on the heat exchange elements with a nozzle of a vacuum cleaner.
- ▶ Take care not to attach the nozzle too close. It may damage the heat exchange element.

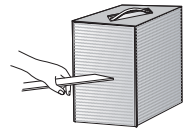

- ▶ Reassemble the heat exchange elements and access panel.



- If the heat exchange element is damaged, purchase it individually in a customer care center or an agency that you bought the product.
- Make sure to turn off the power supply.



- Do not wash the heat exchange element. It may decrease its efficiency.

Cleaning the Humidifier (Optional)

- ▶ Remove 15 screws on the humidifier access panel.
Take off the humidifier access panel.

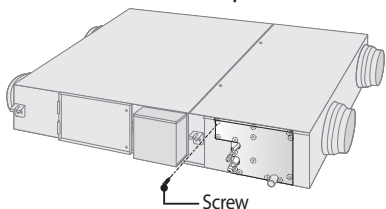

- ▶ Remove 2 more screws.

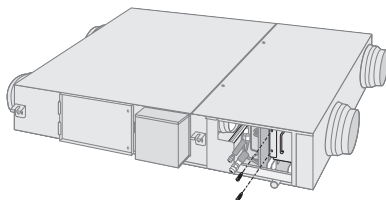

- ▶ Submerge the humidifier element in water and move up and down with care to release any dirt.

- ▶ Do not scrub the humidifier element.
- ▶ Do not spray water directly onto the humidifier element with a hose.
- ▶ Do not use detergent or water hotter than 40 °C.

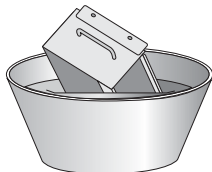

- ▶ Remove the element as illustrated.

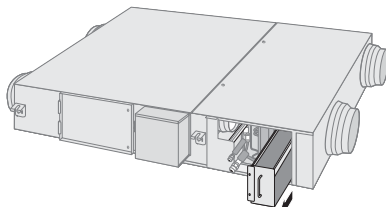

- ▶ Reassemble the humidifier element and access panel.

- ▶ Check whether the humidifier element is correctly assembled. Otherwise, this may result in water leakage and performance deterioration.

Cleaning and maintaining the product

Cleaning the Strainer (Optional)

► Remove the Strainer cap.

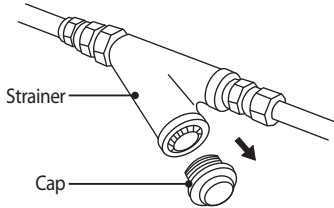

► Take out the mesh inside the strainer.

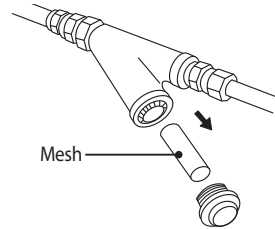

► Clean the mesh with running water.



- Clean the mesh once a month.

Maintaining your product

Period of Replacement & Cleaning

Basic parts

Parts	Replacement	Cleaning	Reasons for exchange or cleaning
Air filter	2 years	6 months	Dust clogging, Performance deterioration
Heat exchange element	-	6 months	Dust clogging
Drain pan	-	1 year	Pollution

Option parts

Parts	Replacement	Cleaning	Reasons for exchange or cleaning
Electronic feed water valve	5 years	-	Deterioration, Clogging
Flow control valve	5 years	-	Deterioration, Clogging
Water piping	10 years	-	Deterioration, pipe water leak
Humidifier element	7~10 years (1,000 hours/year)	1 year	Deterioration of saturation efficiency
Feed water strainer	10 years	1 month (Heating season)	Deterioration, Clogging



NOTE

- The product life and product durable years can be different from the table above according to installation condition and maintenance situation. The table above is applicable when the use of ERV follows the instruction and does the regular maintenance work and is in the general air conditioning condition.
(If the ERV performs round-the-clock operation, replacement interval can be reduced to 1/3~2/5)

Appendix

Troubleshooting

Refer to the following chart if the product operates abnormally. This may save time and unnecessary expenses.

PROBLEM	SOLUTION
The product does not operate immediately after it has been restarted.	<ul style="list-style-type: none">• Because of the protective mechanism, the appliance does not start operating immediately to keep the unit from overloading. The product will start in 3 minutes.
The product does not work at all.	<ul style="list-style-type: none">• Check that the power plug is properly connected. Insert the power plug into the wall socket correctly.• Check if the circuit breaker is switched on.• Check the sub power supply is on.• Check if there is a power failure.• Check your fuse. Make sure it is not blown out.
The cool (warm) air does not come out of the product.	<ul style="list-style-type: none">• Check if the set point temperature of the connected air conditioner is higher (lower) than the current temperature.• Check if the product has just been turned on. If so, wait 3 minutes. Cool air does not come out to protect the compressor of the outdoor unit.• Check if the product is installed in a place with a direct exposure to sunlight. Hang curtains on windows to boost cooling efficiency.• Check if the cover or any obstacle is not near the outdoor unit.• Check if the refrigerant pipe is too long.• Check if the product is only available in Cool mode.• Check if the remote control is only available for cooling model.
The fan speed does not change.	<ul style="list-style-type: none">• Check if you selected Quiet mode. The product automatically adjusts the fan speed to Auto in Quiet mode.
Timer function does not set.	<ul style="list-style-type: none">• Check if you press the Power button on the remote control after you have set the time.
Odors permeate in the room during operation.	<ul style="list-style-type: none">• Check if the appliance is running in a smoky area or if there is a smell entering from outside. Operate the product in Fan mode or open the windows to air out the room.
The product makes a bubbling sound.	<ul style="list-style-type: none">• A bubbling sound may be heard when the refrigerant is circulating through the compressor. Let the product operate in a selected mode.• When you press the Power button on the remote control, noise may be heard from the drain pump inside the product.
Water is dripping from the air flow blades.	<ul style="list-style-type: none">• Check if the product has been cooling for an extended period of time with the air flow blades pointed downwards. Condensation may generate due to the difference in temperature.
The product does not turn on or off with the wired remote control.	<ul style="list-style-type: none">• Check if you set the wired remote control for group control.
The wired remote control does not operate.	<ul style="list-style-type: none">• Check if TEST indicator is displayed on the wired remote control. If so, turn off the unit and switch off the circuit breaker. Call your nearest contact center.
The indicators of the digital display flashes.	<ul style="list-style-type: none">• Press the Power button on the remote control to turn the unit off and switch the circuit breaker off. Then, switch it on again.

PROBLEM	SOLUTION
The air does not come out from the air outlet.	<ul style="list-style-type: none"> • Check whether air filter or heat exchange element is blocked by dust. In case of dust accumulation, it may decrease the efficiency of the ventilator. Clean the air filter and the heat exchange element frequently. • Check whether the air intake or outlet is blocked by dust. Remove all dust in the air intake.
Water drops from the air intake.	<ul style="list-style-type: none"> • Check whether the ventilator is operated in By-Pass mode during heating. When heating, make sure to operate the ventilator in Heat-EX mode.
Humidity operation doesn't work.	<ul style="list-style-type: none"> • Check whether the humidifier element is installed additionally for humidity operation. • Check if the unit is in heat mode. (Humidity operation works only when the unit is in heat mode.) • The on/off operation status of humidity operation is not indicated.

Model specification (Weight and dimension)

Model	Net weight	Net dimension (WxDxH)
AM050FNKDEH/EU	61.0 kg	1553x270x1000 mm
AM100FNKDEH/EU	90.0 kg	1763x340x1135 mm

Safety precautions

Carefully follow the precautions listed below because they are essential to guarantee the safety of the equipment.

- Always disconnect the product from the power supply before servicing it or accessing its internal components.
 - Verify that installation and testing operations are performed by qualified personnel.
 - Verify that the product is not installed in an easily accessible area.
-

General information

- ▶ Carefully read the content of this manual before installing the product and store the manual in a safe place in order to be able to use it as reference after installation.
- ▶ For maximum safety, installers should always carefully read the following warnings.
- ▶ Store the operation and installation manual in a safe location and remember to hand it over to the new owner if the product is sold or transferred.
- ▶ This manual explains how to install an indoor unit with a split system with two SAMSUNG units. The use of other types of units with different control systems may damage the units and invalidate the warranty. The manufacturer shall not be responsible for damages arising from the use of non compliant units.
- ▶ The manufacturer shall not be responsible for damage originating from unauthorized changes or the improper connection of electric and hydraulic lines. Failure to comply with these instructions or to comply with the requirements set forth in the "Operating limits" table, included in the manual, shall immediately invalidate the warranty.
- ▶ The product should be used only for the applications for which it has been designed: the indoor unit is not suitable to be installed in areas used for laundry.
- ▶ Do not use the units if damaged. If problems occur, switch the unit off and disconnect it from the power supply.
- ▶ In order to prevent electric shocks, fires or injuries, always stop the unit, disable the protection switch and contact SAMSUNG's technical support if the unit produces smoke, if the power cable is hot or damaged or if the unit is very noisy.
- ▶ Always remember to inspect the unit, electric connections, refrigerant tubes and protections regularly. These operations should be performed by qualified personnel only.
- ▶ The unit contains moving parts, which should always be kept out of the reach of children.
- ▶ Do not attempt to repair, move, alter or reinstall the unit. If performed by unauthorized personnel, these operations may cause electric shocks or fires.
- ▶ Do not place containers with liquids or other objects on the unit.
- ▶ All the materials used for the manufacture and packaging of the product are recyclable.
- ▶ The product contains a refrigerant that has to be disposed of as special waste. At the end of its life cycle, the air conditioner must be disposed of in authorized centers or returned to the retailer so that it can be disposed of correctly and safely.

Installing the unit

IMPORTANT: When installing the unit, always remember to connect first the refrigerant tubes, then the electrical lines. Always disassemble the electric lines before the refrigerant tubes.

- ▶ Upon receipt, inspect the product to verify that it has not been damaged during transport. If the product appears damaged, DO NOT INSTALL it and immediately report the damage to the carrier or retailer (if the installer or the authorized technician has collected the material from the retailer.)
- ▶ After completing the installation, always carry out a functional test and provide the instructions on how to operate the product to the user.
- ▶ Do not use the product in environments with hazardous substances or close to equipment that release free flames to avoid the occurrence of fires, explosions or injuries.
- ▶ The product should be used only for the applications for which it has been designed: the indoor unit is not suitable to be installed in areas used for laundry.
- ▶ Our units must be installed in compliance with the spaces indicated in the installation manual to ensure either accessibility from both sides or ability to perform routine maintenance and repairs. The units' components must be accessible and that can be disassembled in conditions of complete safety either for people or things. For this reason, where it is not observed as indicated into the Installation Manual, the cost necessary to reach and repair the unit (in safety, as required by current regulations in force) with slings, trucks, scaffolding or any other means of elevation won't be considered in-warranty and charged to end user.
- ▶ Hang down a blockage for bird in front of outdoor air suction duct. If something such as bird's nest blocks the air suction duct, it may result in oxygen shortage in indoors.

Power supply line, fuse or circuit breaker

- ▶ Always make sure that the power supply is compliant with current safety standards. Always install the product in compliance with current local safety standards.
- ▶ Always verify that a suitable grounding connection is available.
- ▶ Verify that the voltage and frequency of the power supply comply with the specifications and that the installed power is sufficient to ensure the operation of any other domestic appliance connected to the same electric lines.
- ▶ Always verify that the cut-off and protection switches are suitably dimensioned.
- ▶ Verify that the product is connected to the power supply in accordance with the instructions provided in the wiring diagram included in the manual.
- ▶ Always verify that electric connections (cable entry, section of leads, protections...) are compliant with the electric specifications and with the instructions provided in the wiring scheme. Always verify that all connections comply with the standards applicable to the installation of products.
- ▶ Be sure not to perform power cable modification, extension wiring, and multiple wire connection.
 - It may cause electric shock or fire due to poor connection, poor insulation, or current limit override.
 - When extension wiring is required due to power line damage, refer to "How to connect your extended power cables" in the installation manual.

Safety precautions











- Make sure that you earth the cables.
 - Do not connect the earth wire to the gas pipe, water pipe, lighting rod or telephone wire. If earthing is not complete, electric shock or fire may occur.
- Install the circuit breaker.
 - If the circuit breaker is not installed, electric shock or fire may occur.
- Make sure that the condensed water dripping from the drain hose runs out properly and safely.
- Install the power cable and communication cable of the indoor and outdoor unit at least 1m away from the electric appliance.
- Do not install the product in following places.
 - Place where there is mineral oil or arsenic acid. Resin parts flame and the accessories may drop or water may leak. The capacity of the heat exchanger may reduce or the product may be out of order.
 - The place where corrosive gas such as sulfurous acid gas generates from the vent pipe or air outlet. The copper pipe or connection pipe may corrode and refrigerant may leak.
 - The place where there is a machine that generates electromagnetic waves. The product may not operate normally due to control system
 - The place where there is a danger of existing combustible gas, carbon fiber or flammable dust. The place where thinner or gasoline is handled. Gas may leak and it may cause fire.
- Do not install the unit in a climate of high temperature and humidity. It may form dewdrop inside of the unit and heat exchange element.
 - Install & Operation ranges

Install condition	Outdoor air condition	Indoor air condition
0~40 °C, 80 %RH below	-15~40 °C, 80 %RH below	0~40 °C, 80 %RH below

- Noise may increase when there are large amount of exhausting air. Be sure to install the duct based on standard air volume. When necessary, control the air volume by installing volume damper. If the noise continues, install the noise chamber or flexible noise reducer additionally. (Volume damper, noise chamber and flexible noise reducer are optional.)
- When cold air flows in to the product, frost may form within the product therefore make sure that the outlet of the air conditioner and the RA diffuser is installed at least 1.5m apart.
- Install the external grille (hood) designed to prevent rain water from entering. (Highly recommended extra accessory)
- It is mandatory to install electric damper on the OA (outdoor air) side and back draft damper on the EA (exhaust air) side. It is also recommended to install them on RA (room air) and SA (supply air) side. You may prevent the dew formation within the product which forms due to outdoor air inflow or temperature difference between the indoor and outdoor. (Electric damper and back draft damper should be purchased separately.)
- Outdoor air duct must be installed at least 3m above the product.

Accessories

The following accessories are supplied with the indoor unit.
The type and quantity may differ depending on the specifications.

User & Installation manual 	Insulation cover pipe in 	Insulation cover pipe out 	Insulation drain 	Insulation cover drain 	Insulation pipe 	Cable tie 
Flexible hose 	Clamp hose 					

Selecting the installation location

- ▶ There must be no obstacles near the air inlet and outlet.
- ▶ Install the indoor unit on a ceiling that can support its weight.
- ▶ Maintain sufficient clearance around the indoor unit.
- ▶ Make sure that the water dripping from the drain hose runs away correctly and safely.
- ▶ The indoor unit must be installed in this way, that they are out of public access. (Not touchable by the users)
- ▶ After connecting a chamber, insulate the connection part between the indoor unit and the chamber with t10 or thicker insulation. Otherwise, there can be air leak or dew from the connection part.
- ▶ Rigid wall without vibration.
- ▶ Where it is not exposed to direct sunshine.
- ▶ Where the replacement parts. (air filter, heat exchange element, humidifier element) can be removed and cleaned easily.

Space Requirements

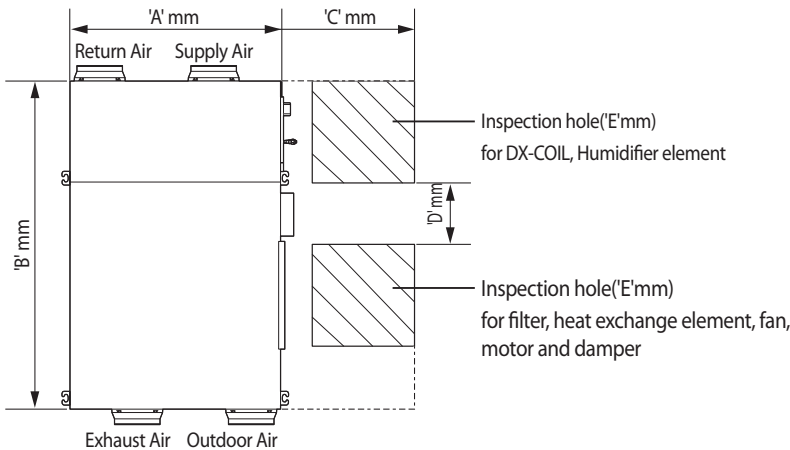

Model	'A'	'B'	'C'	'D'	'E'
AM050FNKDEH	1000	1553	600	200	450 x 450 or more
AM100FNKDEH	1135	1763	800	300	550 x 550 or more

Selecting the installation location

► The ventilator should be installed in a ceiling which has enough space above as seen in the picture.

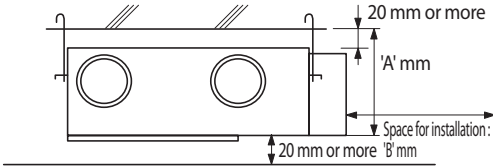

Model	'A'	'B'
AM050FNKDEH	320	600
AM100FNKDEH	440	800

Dimension of the indoor unit

Unit : mm

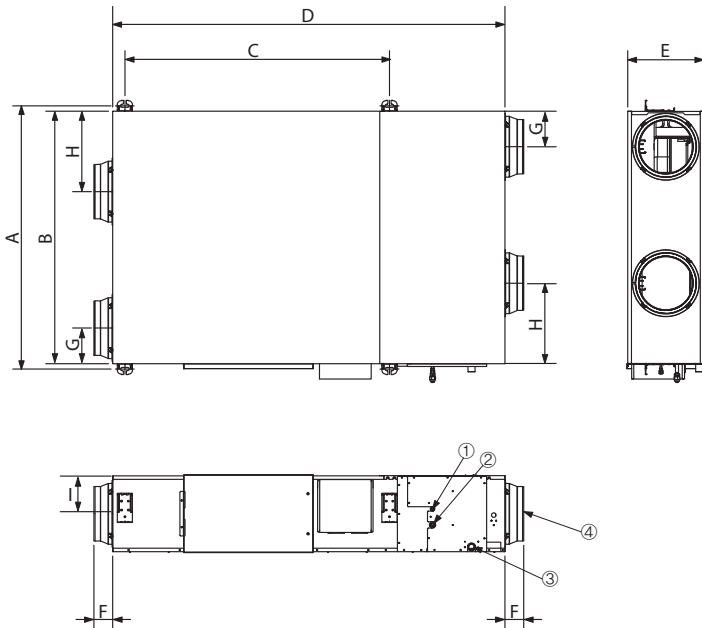

Model	A	B	C	D	E	F	G	H	I
AM050FNKDEH	1036	1000	987	1553	270	99	130	253	135
AM100FNKDEH	1183	1135	1189	1763	340	84	160	362	170

No.	Name	Description	
①	Liquid pipe connection	ø6.35	
②	Gas pipe connection	ø12.70	
③	Drain pipe connection	VP25 (OD ø32, ID ø25)	
④	Nominal diameter for duct	AM050FNKDEH	ø200
		AM100FNKDEH	ø250

Indoor unit installation

It is recommended to install the Y-joint before installing the indoor unit.

1. Insert bolt anchors, use existing ceiling supports or construct a suitable support as shown in figure.
2. Install the suspension bolts depending on the ceiling type.



- Ensure that the ceiling is strong enough to support the weight of the indoor unit. Before hanging the unit, test the strength of each attached suspension bolt.
- If the length of suspension bolt is more than 1.5 m, it is required to prevent vibration.
- If this is not possible, create an opening on the false ceiling in order to be able to use it to perform the required operations on the indoor unit.

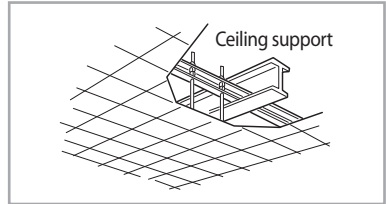
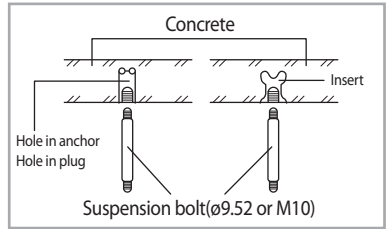

3. Fit two nuts on each suspension rod allowing space for the indoor unit between.



- You must install the suspension bolts more than four when installing the indoor unit.

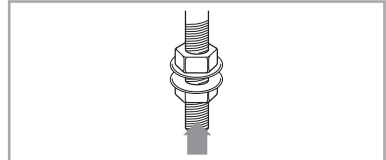

4. Hang the indoor unit to the suspension bolts between two nuts.

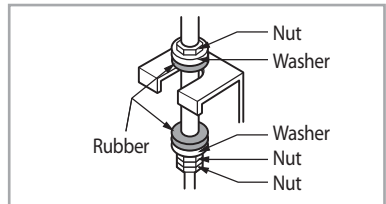

5. Tighten the nuts securely to clamp the brackets on the unit and prevent movement.

6. Adjust level of the unit by using measurement plate for all 4 sides.

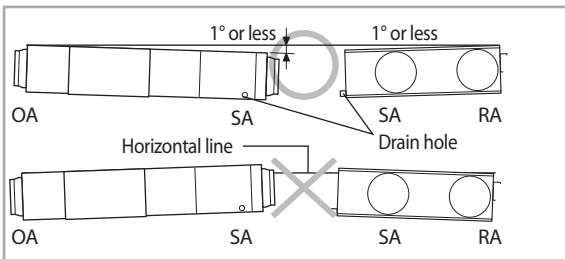

- For proper drainage of condensate, give 1° or less slant to the side of the unit which will be connected with the drain hose, as shown in the figure.

Purging the unit

On delivery, the indoor unit is loaded with inert gas. All this gas must therefore be purged before connecting the assembly piping. To purge the inert gas, proceed as follows.

1. **Unscrew the pinch pipe at the end of each refrigerant pipe.**

Result: All inert gas escapes from the indoor unit.



- To prevent dirt or foreign objects from getting into the pipes during installation, do NOT remove the pinch pipe completely until you are ready to connect the piping.

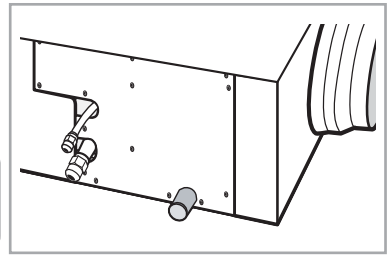

※ The designs and shape are subject to change according to the model.

Connecting the refrigerant pipe

There are two refrigerant pipes of differing diameters:

- ▶ A smaller one for the liquid refrigerant
- ▶ A larger one for the gas refrigerant
- ▶ The inside of the copper pipe must be clean, dry and free from debris.

The connection procedure for the refrigerant pipes varies according to the exit position of the pipes from the indoor unit, as seen when facing the indoor in the "A" side.

- ▶ Liquid refrigerant port
- ▶ Gas refrigerant port
- ▶ Drain hose port

1. Remove the pinch pipe on the pipes and connect the assembly pipes to each pipe, tightening the nuts, first manually and then with a torque wrench, a spanner applying the following torque.

Outer Diameter	Torque	
	kgf-cm	N-m
6.35 mm	140~180	14~18
9.52 mm	350~430	34~42
12.70 mm	500~620	49~61
15.88 mm	690~830	68~82



- Must apply refrigerant oil on the flaring area to prevent a leak.

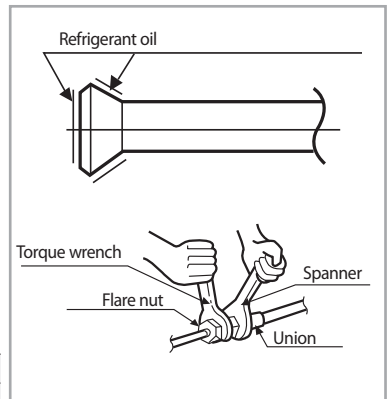

2. Ensure there are no kinks or cracks on pipe bends.

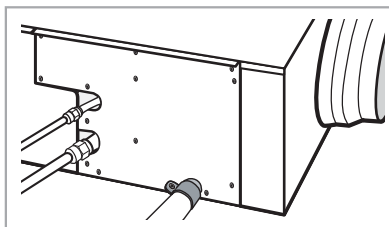
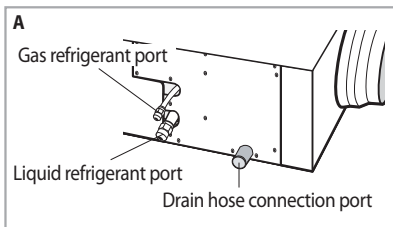

※ The designs and shape are subject to change according to the model.

Cutting/flaring the pipe

1. Make sure that you prepared the required tools. (pipe cutter, reamer, flaring tool and pipe holder)
2. If you want to shorten the pipe, cut it using a pipe cutter ensuring that the cut edge remains at 90° with the side of the pipe. There are some examples of correctly and incorrectly cut edges below.

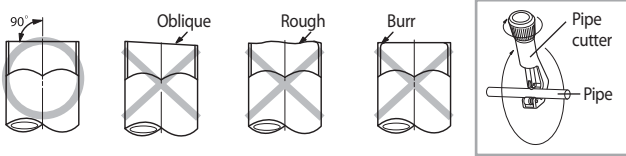

3. To prevent a gas leak, take care not to allow burrs to enter the pipe and clean the flare.
4. Carry out flaring work using flaring as shown below.

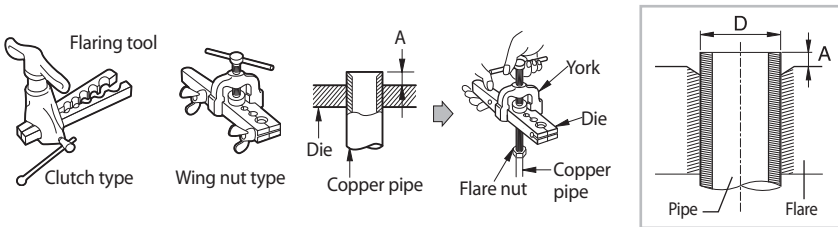

Outer diameter (mm)	A(mm)		
	Flare tool for R410A clutch type	Conventional flare tool	
		Clutch type	Wing nut type
ø6.35 mm	0~0.5	0~0.5	1.5~2.0
ø9.52 mm	0~0.5	0~0.5	1.5~2.0
ø12.70 mm	0~0.5	0~0.5	1.5~2.0
ø15.88 mm	0~0.5	0~0.5	1.5~2.0

5. Check if you flared the pipe correctly (see examples of incorrectly flared pipes below).



6. Align the pipes and tighten the flare nuts first manually and then with a torque wrench, applying the following torque.

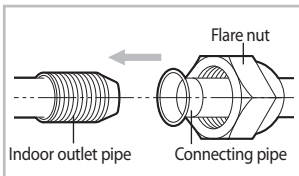

Outer diameter (D mm)	Connection Torque		Flare dimension (A mm)	Flare shape (mm)
	kgf·cm	N·m		
6.35	140~180	14~18	8.70~9.10	
9.52	350~430	34~42	12.80~13.20	
12.70	500~620	49~61	16.20~16.60	
15.88	690~830	68~82	19.30~19.70	



• Purge pipe work with oxygen free nitrogen while brazing.

Performing leak test & insulation

Leak test

LEAK TEST WITH NITROGEN (before opening valves)

In order to detect basic refrigerant leaks, Pressure test the system to 4.1MPa with oxygen free nitrogen before vacuuming the system.

LEAK TEST WITH R410A (after opening valves)

Once the valves are opened and gauge manifold is disconnected, use a leak detector to check for leaks.

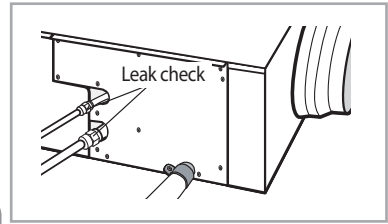

- Release the nitrogen slowly and safely before connecting gauges to the Vacuum pump.

* The designs and shape are subject to change according to the model.

Insulation

1. To avoid condensation problems, place **T13.0 or thicker Acrylonitrile Butadiene Rubber** separately around each refrigerant pipe.



- Always make the seam of pipes face upwards.
- Any joints in the insulation must be taped or glued with approved materials to prevent water leaks.

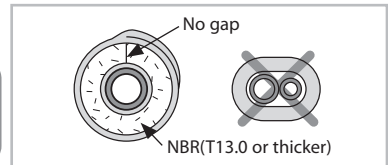

2. Wind insulating tape around the pipes and drain hose avoiding to compress the insulation too much.
3. Finish wrapping insulating tape around the rest of the pipes leading to the outdoor unit.
4. The pipes and electrical cables connecting the indoor unit with the outdoor unit must be fixed to the wall with suitable fixings.

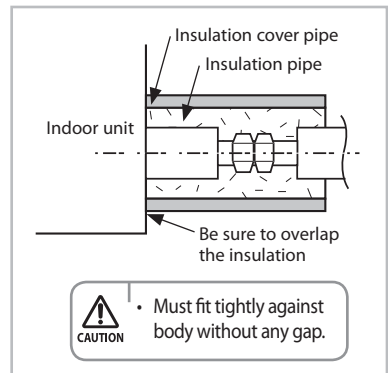

5. Selecting the insulation for the refrigerant pipes.

- ▶ Insulate the gas side and liquid side pipe referring to the thickness according to the pipe size.
- ▶ The thickness according to the pipe size is a standard of the indoor temperature of 27 °C and humidity of 80 %. If installing in an unfavorable conditions, use thicker one.
- ▶ Insulator's heat-resistance temperature should be more than 120 °C.

Pipe size (mm)	Minimum thickness of insulator (mm)		Remarks
	PE foam	EPDM foam	
Ø6.35~Ø15.88	13	10	If you install the pipe underground, at the seaside, a spa or on the lake, use 1 grade thicker one according to the pipe size.
-	25	19	

Refrigerant pipe before EEV kit and MCU or without EEV kit and MCU

- ▶ You can contact the gas side and liquid side pipes but the pipes should not be pressed.
- ▶ When contacting the gas side and gas side pipe, use 1 grade thicker insulator.

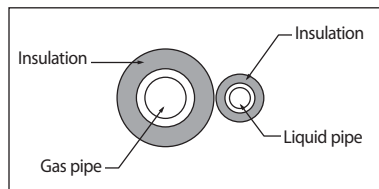

Refrigerant pipe after EEV kit and MCU

- ▶ Install the gas side and liquid side pipes, leave 10 mm of space.
- ▶ When contacting the gas side and liquid side pipe, use 1 grade thicker insulator.

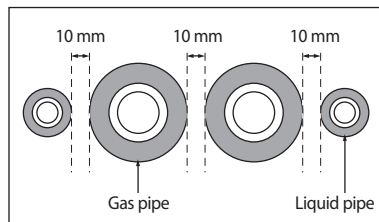

- Install the insulation not to get wider and use the adhesives on the connection part of it to prevent moisture from entering.
- Wind the refrigerant pipe with insulation tape if it is exposed to outside sunlight.
- Install the refrigerant pipe respecting that the insulation does not get thinner on the bent part or hanger of pipe.
- Add the additional insulation if the insulation plate gets thinner.
- Ensure that the pipe insulation is not crushed eg: on bends, where supported by hangers, where cable ties are used.

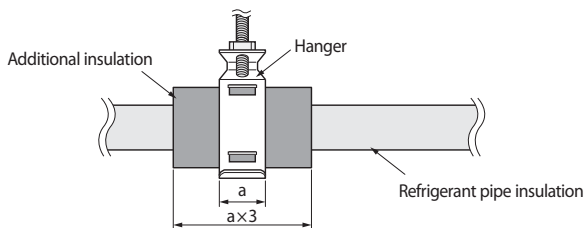

Drain pipe and drain installaton

1. Unscrew the 4 tapped screws to remove the cover of the drain hose connection port.

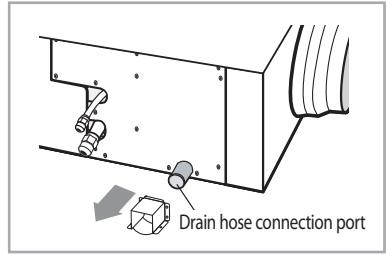

2. Insert the flexible hose to the drain hose port.

NOTE

- Fix the flexible hose to the indoor unit with the supplied cable clamp securely. (Use the screwdriver to fix the flexible hose securely.)

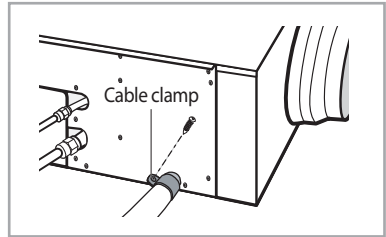

3. Install the drain hose so that its length can be as short as possible. Internal diameter of the drain hose should be the same or slightly bigger than the external diameter of the drain hose port.

▶ Inner diameter of the drain hose

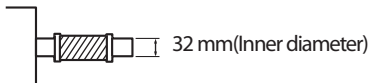

NOTE

- Install the drain hose with a slope away from the unit to give adequate drainage of condensate.
- Fix the flexible hose to the PVC with the supplied cable tie securely.

4. Wrap the drain hose with the insulation drain as shown in figure and secure it.

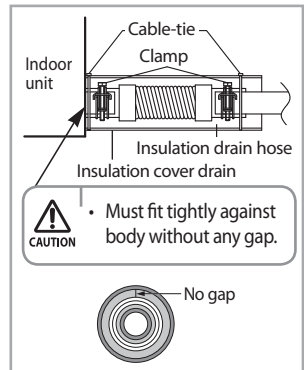

Drain pipe and drain hose installation

Drainpipe Connection

1. Install horizontal drainpipe with a slope of $1/100$ or more and fix it by hanger space of 1.0~1.5 m.
2. Install U-trap at the end of the drainpipe to prevent any odors reaching the indoor unit.
3. Do not install the drain with an upward inclination as it will prevent drainage.

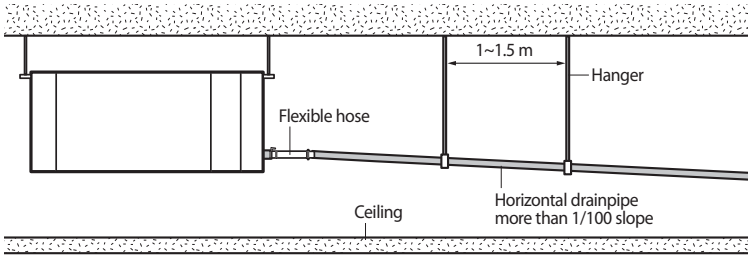

- Do not use the drain pump and allow the natural drainage.

Centralized Drainage

1. Install horizontal drainpipe with a slope of $1/100$ or more and fix it by hanger space of 1.0~1.5 m.
2. Install U-trap at the end of the drainpipe to prevent a nasty smell to reach the indoor unit.

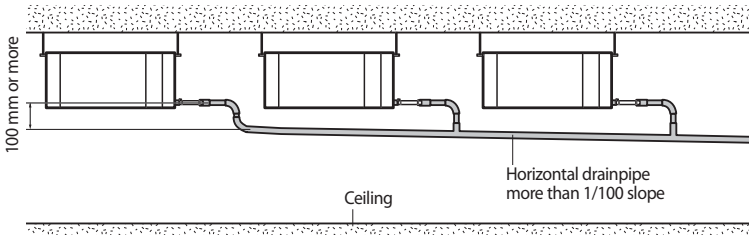

- Do not use the drain pump and allow the natural drainage.

Drain pipe and drain hose installation

Testing the drainage

Prepare a little water about 5 liters.

1. Pour water into the base pan in the indoor unit as shown in figure.
2. Confirm that the water flows out through the drain hose.
3. Check drain water drops at the end of the drain pipe.
4. Check that no water leaks from joints in the drain installation.
5. Reassemble the cover of water supply intake.

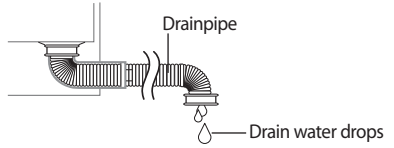
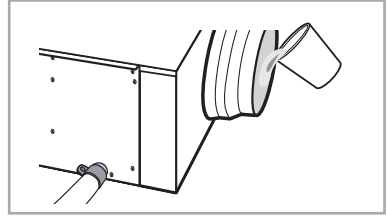

Duct connection

Make sure to insulate the duct referring to the picture.

- ▶ Wind the aluminum tape securely round the duct connection so that the air in the duct does not leak.
- ▶ To prevent rain from permeating duct connection, install the two outdoor ducts (OA, EA) on a slope.
- ▶ To prevent condensation from forming, insulate the three ducts. (Outdoor ducts and Indoor supply air duct)
(Material: Glass wool of 25 mm thick)
- ▶ Outdoor air duct must be installed at least 3m above the product.
- ▶ Install electric damper and back draft damper during duct installation.

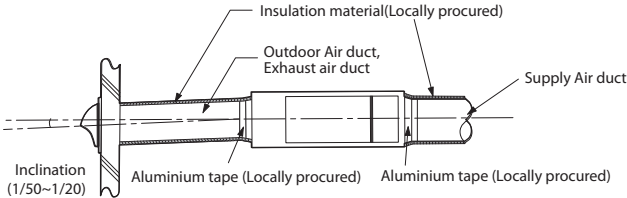

- The use of flexible hose made of fiber glass is recommended to minimize noise. Install the duct at least over 3m to reduce the noise as well.
- If the duct is not attached correctly and securely, it may result in malfunction.
- To prevent a short circuit, install the indoor air intake as far away as possible from an air outlet.

Examples of incorrect duct installation



Extreme bend



Multi bend



Narrow diameter of connection part

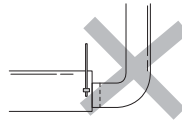

A bend right next to the outlet

Wiring work

Power and communication cable connection

1. Before wiring work, you must turn off all power source.
2. Indoor unit power should be supplied through the breaker(ELCB or MCCB+ELB) separated by the outdoor power.
 ELCB: Earth Leakage Circuit Breaker
 MCCB:Molded Case Circuit Breaker
 ELB:Earth Leakage Breaker
3. The power cable should be used only copper wires.
4. Connect the power cable(1(L), 2(N)) among the units within maximum length and communication cable(F1, F2) each.
5. Connect F3, F4(for communication) when installing the wired remote control.

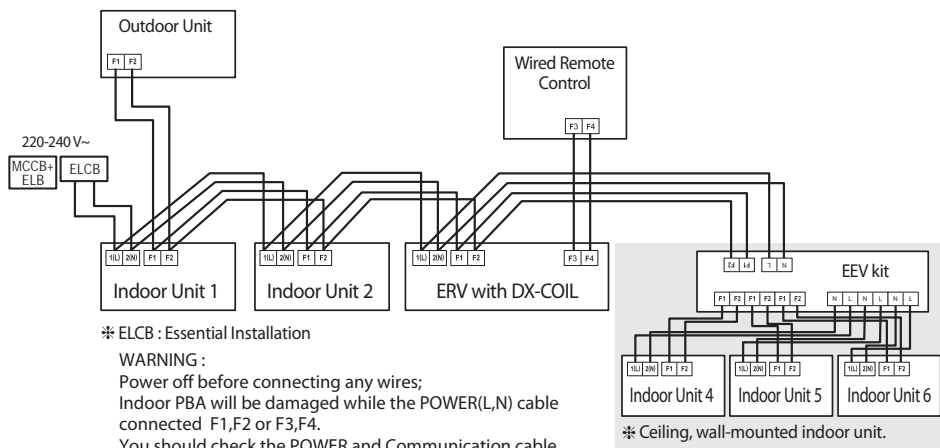

Selecting compressed ring terminal

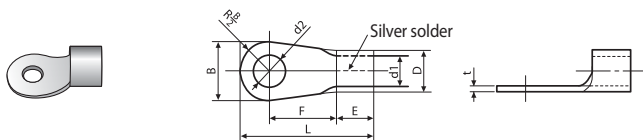

Nominal dimensions for cable (mm ²)	Nominal dimensions for screw (mm)	B		D		d1		E	F	L	d2		t
		Standard dimension (mm)	Allowance (mm)	Standard dimension (mm)	Allowance (mm)	Standard dimension (mm)	Allowance (mm)				Standard dimension (mm)	Allowance (mm)	
1.5	4	6.6	±0.2	3.4	+0.3 -0.2	1.7	±0.2	4.1	6	16	4.3	+0.2 0	0.7
	4	8											
2.5	4	6.6	±0.2	4.2	+0.3 -0.2	2.3	±0.2	6	6	17.5	4.3	+0.2 0	0.8
	4	8.5											
4	4	9.5	±0.2	5.6	+0.3 -0.2	3.4	±0.2	6	5	20	4.3	+0.2 0	0.9

Wiring work

Specification of electric wire

Power supply	MCCB	ELB or ELCB	Power cable	Earth cable	Communication cable
Max : 242V Min : 198V	X A	X A, 30 mA 0.1 s	2.5 mm ²	2.5 mm ²	0.75~1.5 mm ²

▶ Decide the capacity of ELCB(or MCCB+ELB) by below formula.

The capacity of ELCB(or MCCB+ELB) X [A] = 1.25 X 1.1 X $\sum A_i$

- * X : The capacity of ELCB(or MCCB+ELB).
- * $\sum A_i$: Sum of Rating currents of each indoor unit.
- * Refer to each installation manual about the rating current of indoor unit.

▶ Decide the power cable specification and maximum length within 10 % power drop among indoor units.

$$\sum_{k=1}^n \left(\frac{\text{Coef} \times 35.6 \times L_k \times i_k}{1000 \times A_k} \right) < 10 \% \text{ of input voltage [V]}$$

- * coef: 1.55
- * L_k: Distance among each indoor unit[m], A_k: Power cable specification[mm²]
- i_k: Running current of each unit[A]

※ Rating current

Model	Rating current
AM050FNKDEH	1.7A
AM100FNKDEH	3.7A

Example of Installation

1. - Total power cable length L = 100(m), Running current of each units 1[A]
2. - Total 10 indoor units were installed

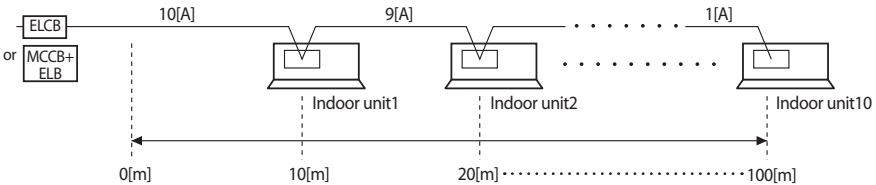

▶ Apply following equation.

$$\sum_{k=1}^n \left(\frac{\text{Coef} \times 35.6 \times L_k \times i_k}{1000 \times A_k} \right) < 10 \% \text{ of input voltage [V]}$$

※ Calculation

▶ Installing with one size cable.

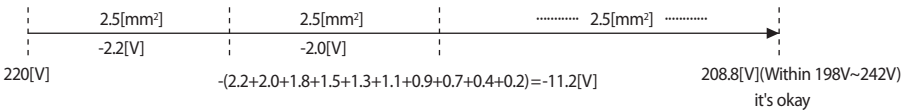

▶ Installing with two size cables.

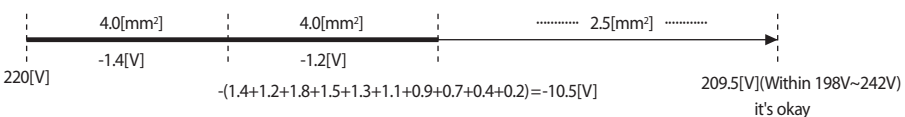



CAUTION





- Select the power cable in accordance with relevant local and national regulations.
- Wire size must comply with local and national code.
- Power Supply cords of parts of appliances for outdoor use shall not be lighter than polychloroprene sheathed flexible cord.(Code designation IEC:60245 IEC 57 / CENELEC: H05RN-F or IEC:60245 IEC 66 / CENELEC: H07RN-F)
- You should connect the power cable into the power cable terminal and fasten it with a clamp.
- The unbalanced power must be maintained within 10 % of supply rating among whole indoor units.
- If the power is unbalanced greatly, it may shorten the life of the condenser. If the unbalanced power is exceeded over 10 % of supply rating, the indoor unit is protected, stopped and the error mode indicates.
- To protect the product from water and possible shock, you should keep the power cable and the connection cord of the indoor and outdoor units in the iron pipe.
- Connect the power cable to the auxiliary circuit breaker.
An all pole disconnection from the power supply must be incorporated in the fixed wiring(≥ 3 mm).
- You must keep the cable in a protection tube.
- Keep distances of 50 mm or more between power cable and communication cable.
- Maximum length of power cables are decided within 10 % of power drop. If it exceeds, you must consider another power supplying method.
- The circuit breaker(ELCB or MCCB+ELB) should be considered more capacity if many indoor units are connected from one breaker.
- Use round pressure terminal for connections to the power terminal block.
- For wiring, use the designated power cable and connect it firmly, then secure to prevent outside pressure being exerted on the terminal board.
- Use an appropriate screwdriver for tightening the terminal screws. A screwdriver with a small head will strip the head and make proper tightening impossible.
- Over-tightening the terminal screws may break them.
- See the table below for tightening torque for the terminal screws.

Tightening torque		
M4	12.0~18.0 kgf·cm	1.2~1.8 N·m

Wiring work

How to connect your extended power cables

1. Prepare the following tools.

Tools	Crimping pliers	Connection sleeve (mm)	Insulation tape	Contraction tube (mm)
Spec	MH-14	20xØ6.5(HxOD)	Width 19mm	70xØ8.0(LxOD)
Shape				

2. As shown in the figure, peel off the shields from the rubber or wire of the power cable.

- Peel off 20 mm of cable shields from the pre-installed tube.

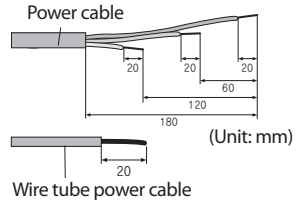

- For information about the power cable specifications for indoor and outdoor units, refer to the installation manual.
- After peeling off cable wires from the pre-installed tube, insert a contraction tube.

3. Insert both sides of core wire of the power cable into the connection sleeve.

► Method 1

Push the core wire into the sleeve from both sides.

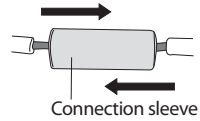

► Method 2

Twist the wire cores together and push it into the sleeve.

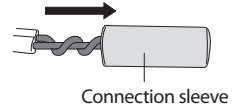

4. Using a crimping tool, compress the two points and flip it over and compress another two points in the same location.

- The compression dimension should be 8.0.
- After compressing it, pull both sides of the wire to make sure it is firmly pressed.

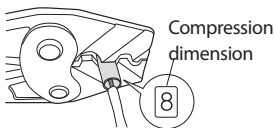

► Method 1

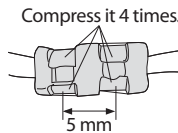

► Method 2

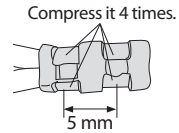

5. Wrap it with the insulation tape twice or more and position your contraction tube in the middle of the insulation tape. Three or more layers of insulation are required.

► Method 1

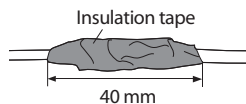

► Method 2

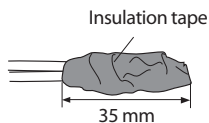

6. Apply heat to the contraction tube to contract it.

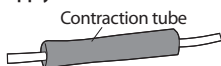

7. After tube contraction work is completed, wrap it with the insulation tape to finish.

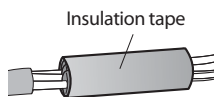

CAUTION

- Make sure that the connection parts are not exposed to outside.
- Be sure to use insulation tape and a contraction tube made of approved reinforced insulating materials that have the same level of withstand voltage with the power cable. (Comply with the local regulations on extensions.)



WARNING

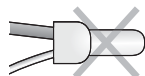

- In case of extending the electric wire, please DO NOT use a round-shaped Pressing socket.
- Incomplete wire connections can cause electric shock or a fire.

Indoor unit setting

Power and communication cable connection

1. Before installing the indoor unit, assign an address to the indoor unit according to the air conditioning system plan.

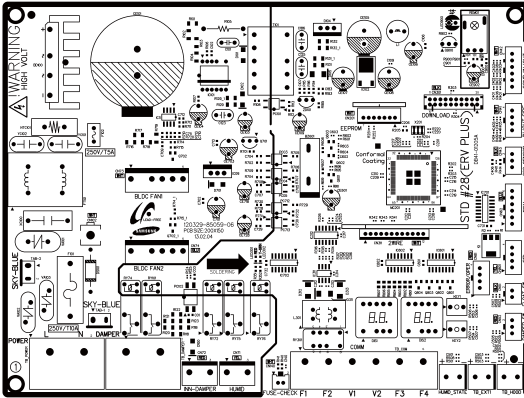

Basic specification of display

e.g.



SEG1: Displays "U" when an indoor unit communicates with a wired remote controller.

SEG2: Displays a digit of RMC address.(0~F)

SEG3/SEG4: Displays two digits of main address.

→ In case of initial status, U0 00 will be displayed as the example above.

(Communication with a remote controller: On, RMC address: "0", MAIN address : "00")



NOTE

- The contents above will be displayed with error, trial operation/VIEW mode and RESET.
- The "U" display which means whether the communication of a wired remote controller for SEG1 is on or not may be delayed for 2-3 minutes due to the time difference in communication.

Setting an indoor unit address and installation option

Set the indoor unit address and installation option with remote controller option.

Set the each option separately since you cannot set the ADDRESS setting and indoor unit installation setting option at the same time. You need to set twice when setting indoor unit address and installation option.

The procedure of option setting using wireless remote controller

MR-DC00, MR-DH00

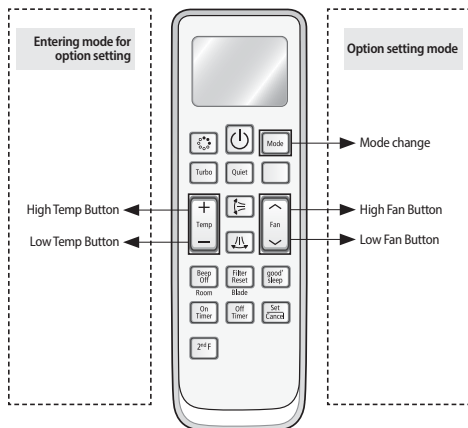

MR-EC00, MR-EH00

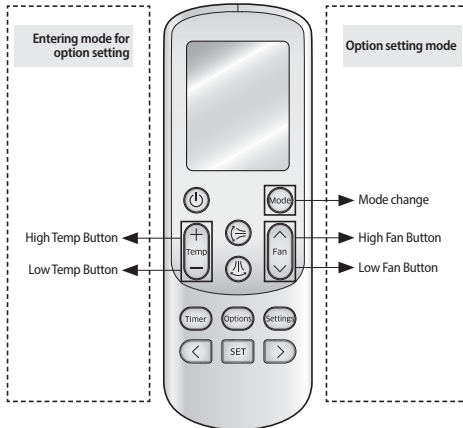

* The display of the remote controller may be different depending on the model.

Step 1. Entering mode to set option

1. Remove batteries from the remote controller.
2. Insert batteries and enter the option setting mode while pressing High Temp button and Low Temp button.



3. Check if you have entered the option setting status.



Step 2. The procedure of option setting

After entering the option setting status, select the option as listed below.





















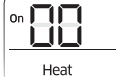

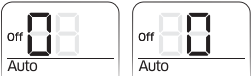

Option setting is available from SEG1 to SEG24

- SEG1, SEG7, SEG13, SEG19 are not set as page option.
- Set the SEG2~SEG6, SEG8~SEG12 as ON status and SEG14~18, SEG20~24 as OFF status.

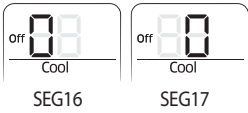
SEG1	SEG2	SEG3	SEG4	SEG5	SEG6	SEG7	SEG8	SEG9	SEG10	SEG11	SEG12	On(SEG1~12)	Off(SEG13~24)
0	X	X	X	X	X	1	X	X	X	X	X		
SEG13	SEG14	SEG15	SEG16	SEG17	SEG18	SEG19	SEG20	SEG21	SEG22	SEG23	SEG24		
2	X	X	X	X	X	3	X	X	X	X	X		

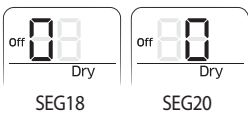
Setting an indoor unit address and installation option

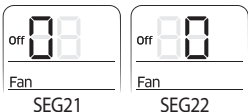
Option setting	Status
<p>1. Setting SEG2, SEG3 option Press Low Fan button(V) to enter SEG2 value. Press High Fan button(^) to enter SEG3 value. Each time you press the button, 0 → 1 → ... → 9 will be selected in rotation.</p>	
<p>2. Setting Cool mode  Press Mode button to be changed to Cool mode in the ON status.</p>	
<p>3. Setting SEG4, SEG5 option Press Low Fan button(V) to enter SEG4 value. Press High Fan button(^) to enter SEG5 value. Each time you press the button, 0 → 1 → ... → 9 will be selected in rotation.</p>	
<p>4. Setting Dry mode  Press Mode button to be changed to DRY mode in the ON status.</p>	
<p>5. Setting SEG6, SEG8 option Press Low Fan button(V) to enter SEG6 value. Press High Fan button(^) to enter SEG8 value. Each time you press the button, 0 → 1 → ... → 9 will be selected in rotation.</p>	
<p>6. Setting Fan mode  Press Mode button to be changed to FAN mode in the ON status.</p>	
<p>7. Setting SEG9, SEG10 option Press Low Fan button(V) to enter SEG9 value. Press High Fan button(^) to enter SEG10 value. Each time you press the button, 0 → 1 → ... → 9 will be selected in rotation.</p>	
<p>8. Setting Heat mode  Press Mode button to be changed to HEAT mode in the ON status.</p>	
<p>9. Setting SEG11, SEG12 option Press Low Fan button(V) to enter SEG11 value. Press High Fan button(^) to enter SEG12 value. Each time you press the button, 0 → 1 → ... → 9 will be selected in rotation.</p>	
<p>10. Setting Auto mode  Press Mode button to be changed to AUTO mode in the OFF status.</p>	
<p>11. Setting SEG14, SEG15 option Press Low Fan button(V) to enter SEG14 value. Press High Fan button(^) to enter SEG15 value. Each time you press the button, 0 → 1 → ... → 9 will be selected in rotation.</p>	

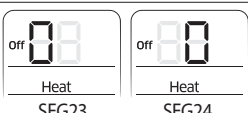
Option setting	Status
<p>12. Setting Cool mode</p> <p> Press Mode button to be change to Cool mode in the OFF status.</p>	
<p>13. Setting SEG16, SEG17 option</p> <p>Press Low Fan button(∨) to enter SEG16 value. Press High Fan button(∧) to enter SEG17 value. Each time you press the button, 0 → 8 → ... → E → F will be selected in rotation.</p>	
<p>14. Setting Dry mode</p> <p> Press Mode button to be change to Dry mode in the OFF status.</p>	
<p>15. Setting SEG18, SEG20 option</p> <p>Press Low Fan button(∨) to enter SEG18 value. Press High Fan button(∧) to enter SEG20 value. Each time you press the button, 0 → 8 → ... → E → F will be selected in rotation.</p>	
<p>16. Setting Fan mode</p> <p> Press Mode button to be change to Fan mode in the OFF status.</p>	
<p>17. Setting SEG21, SEG22 option</p> <p>Press Low Fan button(∨) to enter SEG21 value. Press High Fan button(∧) to enter SEG22 value. Each time you press the button, 0 → 8 → ... → E → F will be selected in rotation.</p>	
<p>18. Setting Heat mode</p> <p> Press Mode button to be change to HEAT mode in the OFF status.</p>	
<p>19. Setting SEG23, SEG24 mode</p> <p>Press Low Fan button(∨) to enter SEG23 value. Press High Fan button(∧) to enter SEG24 value. Each time you press the button, 0 → 8 → ... → E → F will be selected in rotation.</p>	

Step 3. Check the option you have set

After setting option, press  button to check whether the option code you input is correct or not.



Step 4. Input option

Press operation button  with the direction of remote control for set.
For the correct option setting, you must input the option twice.

Step 5. Check operation

1. Reset the indoor unit by pressing the RESET button of indoor unit or outdoor unit.
2. Take the batteries out of the remote controller and insert them again and then press the operation button.



• For the option setting by MWR-WE10N(wired remote controller), refer to the wired remote controller manual or p.59 and 60 of this manual.

Setting an indoor unit address and installation option

Setting an indoor unit address (MAIN/RMC)

- The receiver module of a wireless remote controller is at PBA phase.
(This receiver module is only for setting the option, not for operating the ERV+.)
You can set or check the MAIN or RMC address with the main menu 4 of a wired remote controller.
- Main Address**
 - ▶ You may not need to set main address if you select auto address setting from the outdoor unit.
 - ▶ You can set the Main address from "00" to "79". If an address above 80 is entered, it will be ignored.
 - ▶ The Main addresses are different each other.
- RMC Address**
 - ▶ You don't have to set the RMC address when not using the centralized controller.
 - ▶ You can set the Main address from "0" to "F".

Option No. : 0AXXXX-1XXXXX-2XXXXX-3XXXXX

Option	SEG1		SEG2		SEG3		SEG4		SEG5		SEG6	
Explanation	PAGE		MODE		Setting Main address		100-digit of indoor unit address		10-digit of indoor unit		The unit digit of an indoor unit	
Remote Controller Display												
Indication and Details	Indication	Details	Indication	Details	Indication	Details	Indication	Details	Indication	Details	Indication	Details
	0		A		0	No Main address	0~9	100-digit	0~9	10-digit	0~9	A unit digit
				1	Main address setting mode							
Option	SEG7		SEG8		SEG9		SEG10		SEG11		SEG12	
Explanation	PAGE		RESERVED		Setting RMC address		RESERVED		Group channel(*16)		Group address	
Remote Controller Display												
Indication and Details	Indication	Details			Indication	Details			Indication	Details	Indication	Details
		1		0	No RMC address	RMC1	0~F	RMC2	0~F			
				1	RMC address setting mode							



- When "A"~"F" is entered to SEG4~6, the indoor unit MAIN ADDRESS is not changed.
- If you set the SEG 3 as 0, the indoor unit will maintain the previous MAIN ADDRESS even if you input the option value of SEG5~6.
- If you set the SEG 9 as 0, the indoor unit will maintain previous RMC ADDRESS even if you input the option value of SEG11~12.
- You cannot set SEG11 and SEG12 as F value at the same time.

Setting an indoor unit installation option (suitable for the condition of each installation location)

- The receiver module of a wireless remote controller is at PBA phase.
(This receiver module is only for setting the option, not for operating the ERV+.)
You can set or check the MAIN installation option with the main menu 4 and sub menu 4 of a wired remote controller.
- Set the installation option according to the installation condition of an air conditioner.
 - ▶ The default setting of an indoor unit installation option is "020010-100000-200000-300000" and "050000-100000-200000-300000".

02 series installation option

SEG1	SEG2	SEG3	SEG4	SEG5	SEG6
0	2	-	External room temperature sensor / Minimizing fan operation when thermostat is off	Central control	-
SEG7	SEG8	SEG9	SEG10	SEG11	SEG12
1	-	-	-	EEV opening when heating stop	-
SEG13	SEG14	SEG15	SEG16	SEG17	SEG18
2	External control	External control output / External heater On or Off signal	S-Plasma ion	-	Number of hours using filter
SEG19	SEG20	SEG21	SEG22	SEG23	SEG24
3	-	Heating setting compensation / Removing condensated water in heating mode	EEV Step of stopped unit during oil return/ defrost mode	-	-

- ▶ When setting the option other than above SEG values, the option will be set as "0".
- ▶ SEG5 central control option is basically set as 1 (Use), so you don't need to set the central control option additionally.
However, if the central control is not connected but it doesn't indicate an error message, you need to set the central control option as 0 (Disuse) to exclude the indoor unit from the central control.
- ▶ The output of hot water heater in SEG9 is generated from the hot coil part of the terminal board in duct models.

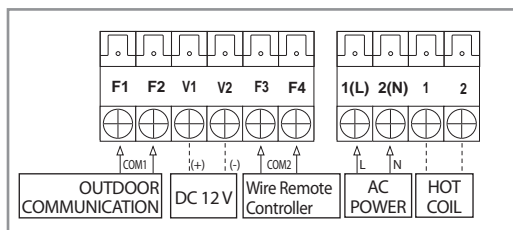









* The output of hot coil terminal is AC 220 V / 230 V
(The same as Indoor Unit's input Power)

- ▶ The external output of SEG15 is generated by MIM-B14 connection. (Refer to the manual of MIM-B14.)

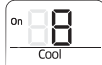
Setting an indoor unit address and installation option

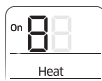
■ 02 series installation option (Detailed)

Option No. : 02XXXX-1XXXXX-2XXXXX-3XXXXX

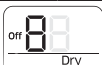
Option	SEG1	SEG2	SEG3	SEG4	SEG5	SEG6			
Explanation	PAGE	MODE	RESERVED	Use of external room temperature sensor / Minimizing fan operation when thermostat is off	Use of central control	RESERVED			
Remote Controller Display									
Indication and Details	Indication	Details		Indication	Details		Indication	Details	
	0			2			0	Disuse	
	0				Use of External room temperature sensor		Minimizing fan operation when thermostat is off		
	1			Disuse	Disuse				
2			1	Use	Disuse				
3			2	Disuse	Use ¹⁾				
Option	SEG7	SEG8	SEG9	SEG10	SEG11	SEG12			
Explanation	PAGE	RESERVED	Use of hot water heater	RESERVED	EEV Step when heating stops				
Remote Controller Display									
Indication and Details	Indication		Details		Indication		Details	Indication	Details
	1				0		Disuse	0	Default value
					1		Use ²⁾	1	Noise decreasing setting
			2	-					
		3	Use ²⁾						
Option	SEG13	SEG14	SEG15	SEG16	SEG17	SEG18			
Explanation	PAGE	Use of external control	Setting the output of external control / External heater On/Off signal	S-Plasma ion	RESERVED	Number of hours using filter			
Remote Controller Display									
Indication and Details	Indication	Details	Indication	Details		Indication	Details		
	2		0	Disuse		0	Disuse		
			1	ON/OFF control		0	Thermo on	-	
			2	OFF control	1	Operation on	-		
		3	Window ON/OFF control	2	-	Use ³⁾			
			3	-	Use ³⁾				
						2	1000 Hour		
						6	2000 Hour		

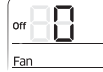
Option	SEG19	SEG20	SEG21	SEG22	SEG23	SEG24		
Explanation	PAGE	RESERVED	Heating setting compensation / Removing condensated water in heating mode		EEV Step of stopped unit during oil return/defrost mode			
Remote Controller Display								
Indication and Details	Indication		Indication	Details		Indication	Details	
				Heating Setting Compensation	Removing Condensated Water in Heating Mode			
				0	Default ⁴⁾	Disuse	0	Default value
				1	2°C	Disuse	1	Oil return or Noise decreasing in defrost mode
				2	5°C	Disuse		
				3	Default ⁴⁾	Use ⁵⁾		
			4	2°C	Use ⁵⁾			
	3			5	5°C	Use ⁵⁾		

* Advanced function: Controlling cooling/heating current or power saving with motion detect.

¹⁾ Minimizing fan operation when thermostat is off

- Fan operates for 20 seconds at an interval of 5 minutes in heat mode.

²⁾ 1: Fan is turned on continually when the hot water heater is turned on,
3: Fan is turned off when the hot water heater is turned on with cooling only indoor unit

Cooling only indoor unit: To use this option, install the Mode Select switch (MCM-C200) on the outdoor unit and fix it as cool mode.

³⁾ When the following 2 or 3 is used as external heater On/Off signal, the signal for monitoring external contact control will not be output.

2: Fan is turned on continually when the external heater is turned on,

3: Fan is turned off when the external heater is turned on with cooling only indoor unit

Cooling only indoor unit: To use this option, install the Mode Select switch (MCM-C200) on the outdoor unit and fix it as cool mode.

* If Fan is set to off for cooling only indoor unit by setting the SEG9=3 or SEG15=3, you need to use an external sensor or wired remote controller sensor to detect indoor temperature exactly.

⁴⁾ Default setting value

- 4Way Cassette, Mini 4Way Cassette: 5°C

- Other indoor units: 2°C

⁵⁾ This function can be applied to 4 Way Cassette and Mini 4 Way Cassette only. If the air conditioner operates the heating mode immediately after finishing the cooling mode, the condensated water in the drain pan becomes water vapor by the heat of the indoor unit heat exchanger. Since the water vapor might be condensed on the indoor unit, which may fall into a living space, use this function to get rid of the water vapor out of the indoor unit by operating the fan (for maximum 20 minutes) even when the indoor unit is turned off after cooling mode is turned to heating mode.

 Do not install the electronic heater in the flow channel of the indoor unit fan.

CAUTION

Electronic heater should not be installed.

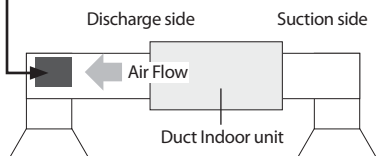

Setting an indoor unit address and installation option





■ 05 series installation option

SEG1	SEG2	SEG3	SEG4	SEG5	SEG6
0	5	RESERVED	RESERVED	RESERVED	RESERVED
SEG7	SEG8	SEG9	SEG10	SEG11	SEG12
1	RESERVED	RESERVED	Compensation option for Long pipe or height difference between indoor units	-	Clean Up
SEG13	SEG14	SEG15	SEG16	SEG17	SEG18
2	Humidifier	CO ₂ Sensor	External Damper	-	Control variables when using hot water / external heater
SEG19	SEG20	SEG21	SEG22	SEG23	SEG24
3	-	-	-	-	-

- ▶ When setting the option other than above SEG values, the option will be set as "0".

■ 05 series installation option(Detailed)

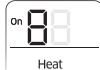
Option No. : 05XXXX-1XXXXX-2XXXXX-3XXXXX

Option	SEG1		SEG2		SEG3	SEG4		SEG5		SEG6	
Explanation	PAGE		MODE		RESERVED	RESERVED		RESERVED		RESERVED	
Remote Controller Display											
Indication and Details	Indication	Details	Indication	Details							
	0		5								
Option	SEG7		SEG8		SEG9	SEG10		SEG11		SEG12	
Explanation	PAGE		RESERVED		RESERVED	Compensation option for Long pipe or height difference between indoor units		-		Clean Up	
Remote Controller Display											
Indication and Details	Indication	Details				Indication	Details	Indication	Details	Indication	Details
	1		0	Use default value	0	Exhaustion air RPM is fixed as Quiet mode RPM					
			1	1) Height difference ¹⁾ is more than 30m or 2) Distance ²⁾ is longer than 110m							
2			1) Height difference ¹⁾ is 15~30m or 2) Distance ²⁾ is 50~110m	1			Supply air RPM is fixed as Quiet mode RPM				

Setting an indoor unit address and installation option

Option	SEG13	SEG14		SEG15		SEG16		SEG17	SEG18 ³⁾			
Explanation	PAGE	Humidifier		CO ₂ SENSOR		External Damper		RESERVED	Control variables when using hot water / external heater			
Remote Controller Display												
Indication and Details	Indication	Details	0	Disuse	0	Disuse	0		Disuse	Indication	Details	
			2	1	Use	1	Use		1		Use	Set temp. for heater On/Off
	0	At the same time as thermo on								No delay		
	1	At the same time as thermo on		10 minutes								
	2	At the same time as thermo on		20 minutes								
	3	1.5 °C		No delay								
	4	1.5 °C		10 minutes								
	5	1.5 °C		20 minutes								
	6	3.0 °C		No delay								
	7	3.0 °C	10 minutes									
8	3.0 °C	20 minutes										
9	4.5 °C	No delay										
A	4.5 °C	10 minutes										
B	4.5 °C	20 minutes										
C	6.0 °C	No delay										
D	6.0 °C	10 minutes										
E	6.0 °C	20 minutes										
Option	SEG19	SEG20		SEG21		SEG22		SEG23	SEG24			
Explanation	PAGE	RESERVED		RESERVED		RESERVED		RESERVED	RESERVED			
Remote Controller Display												
Indication and Details	Indication										Details	
		3										

- ¹⁾ Height difference : The difference of the height between the corresponding indoor unit and the indoor unit installed at the lowest place.
For example, When the indoor unit is installed 40m higher than the indoor unit installed at the lowest place, select the option "1".
- ²⁾ Distance : The difference between the pipe length of the indoor unit installed at farthest place from an outdoor unit and the pipe length of the corresponding indoor unit from an outdoor unit.
For example, when the farthest pipe length is 100m and the corresponding indoor unit is 40m away from an outdoor unit, select the option "2". (100 - 40 = 60m)
- ³⁾ Heater operation when the SEG9 of O2 series installation option is set to using hot water heater or when SEG15 is set to using external heater
- e.g. 1) Setting O2 series SEG9 = "1" / Setting O5 series SEG18 = "0": Hot water heater is turned on at the same time as the heating thermostat is on, and turned off when the heating thermostat is off.
- e.g. 2) Setting O2 series SEG15 = "2" / Setting O5 series SEG18 = "A":
Room temp. ≤ set temp. + f(heating compensation temp.)
- External heater is turned on when the temperature is maintained as 4.5 °C for 10 minutes.
Room temp. > set temp. + f(heating compensation temp.)
- External heater is turned off when the temperature is maintained as 4.5 °C + 1 °C
(1 °C is the Hysteresis for On/Off selection.)

1. **SEG 3, 4, 5, 6, 8, 9 additional information**

When the SEG 3 is set as "1" and follow Auto Change Over for HR only operation, it will operate as follows.

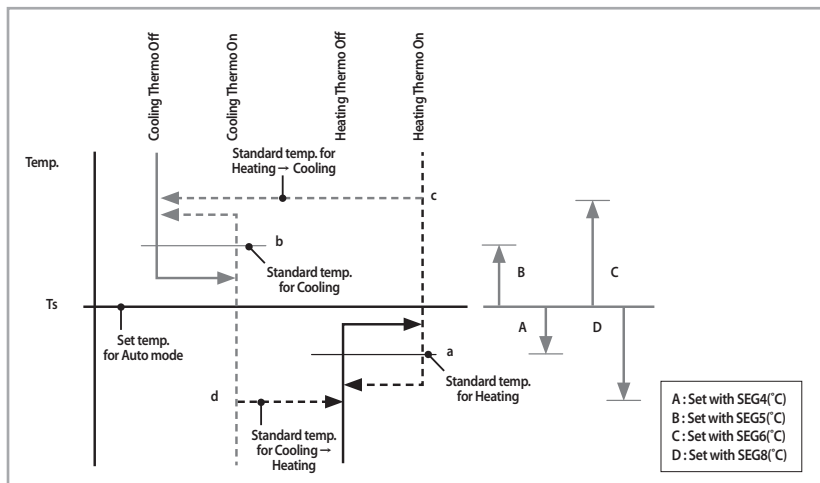

Cooling/Heating mode can be changed when Thermo Off status is maintained during the time with SEG9.

Changing a particular option

1. You can change each digit of set option.

Option	SEG1	SEG2	SEG3	SEG4	SEG5	SEG6
Explanation	PAGE	MODE	The option mode you want to change	The tens' digit of an option SEG you will change	The unit digit of an option SEG you will change	The changed value
Remote Controller Display						
Indication and Details	Indication	Indication	Indication	Indication	Indication	Indication
	Details	Details	Details	Details	Details	Details
	0	D	Option mode 1~6	Tens' digit of SEG 0~9	Unit digit of SEG 0~9	The changed value 0~F



- When changing a digit of an indoor unit address setting option, set the SEG3 (Option mode) as "A"
 - When changing a digit of an indoor unit installation setting option, set the SEG3 (Option mode) as "2" or "5"
- Ex) When setting only the S-Plasma Ion into use status*

Option	SEG1	SEG2	SEG3	SEG4	SEG5	SEG6
Explanation	PAGE	MODE	The option mode you want to change	The tens' digit of an option SEG you will change	The unit digit of an option SEG you will change	The changed value
Indication	0	D	2	1	6	1

Additional functions

External Control

Use an external control to interlock control the ventilator with external device or external contact point.

- ▶ It connects both sides of EXT1.
 - Only 1 unit can be connected.
- ▶ The picture displays the condition that external controller, kitchen hood and humid sensor are connected. If the external controller 1 is set to ON position, ventilator is operated in the last used condition.
- ▶ If you enter a kitchen hood, the supply air operates in Turbo fan speed and exhaust air operates in Low fan speed.
- ▶ When a signal comes to the humidification sensor, the ventilator (ERV) continues its operation. However, the humidity solenoid valve of the ventilator (ERV) will be closed and this will result in stopping the humidification operation.

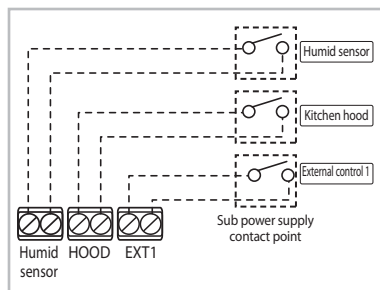

* Humid sensor is not supplied.

Trial operation

When you press the trial operation button(KEY1), the unit operates as the table below.

TACT S/W PUSH (KEY1)	Operation		Display
	When the humidity option is not used.	When the humidity option is used.	
One time	Not working	Start water supply by opening humidity SOLENOID VALVE.	1SOL
Two times	Damper operation * Opens and closes one time	Damper operation * Opens and closes one time. * Maintain the open status of humidity SOLENOID VALVE	2DAM
Three times	Supply / Exhaust FAN operation * Turbo breeze is generated	Supply / Exhaust Fan operation * Turbo breeze is generated * Maintain the open status of humidity SOLENOID VALVE	3FAN
Four times	Cancel the trial operation	Cancel the trial operation	Return to original status

- ▶ Trial operation will stop after maintaining 30 minutes of operation and return to previous display status.
- ▶ KEY 1 does not work during the normal SET operation.

Trial operation

Press the KEY 2 button to indicate the specification below on the display.

Press time	Display item	Display	Example of indication
1	FAN RPM of air exhaust(Actual operation RPM)	1120	1200RPM(Indicates only three digits from thousand's digit)
2	FAN RPM of air supply(Actual operation RPM)	2090	900RPM(Indicates only three digits from thousand's digit)
3	INSIDE_TEMP	3025	25 °C(Indicates only three digits from hundred's digit)
4	OUTSIDE TEMP	4010	10 °C(Indicates only three digits from hundred's digit)
5	COND_TEMP	5065	65 °C(Indicates only three digits from hundred's digit)
6	EVA_IN_TEMP	6035	35 °C(Indicates only three digits from hundred's digit)
7	EVA_OUT_TEMP	7020	20 °C(Indicates only three digits from hundred's digit)
8	CO ₂ sensor value	8135	1350 PPM(Indicates only three digits from thousand's digit)
9	EEV opening	9048	480 STEP(Indicates only three digits from thousand's digit)

► When you press and holde the KEY2 switch for more than 3 seconds, PBA will be reset (in 40sec)

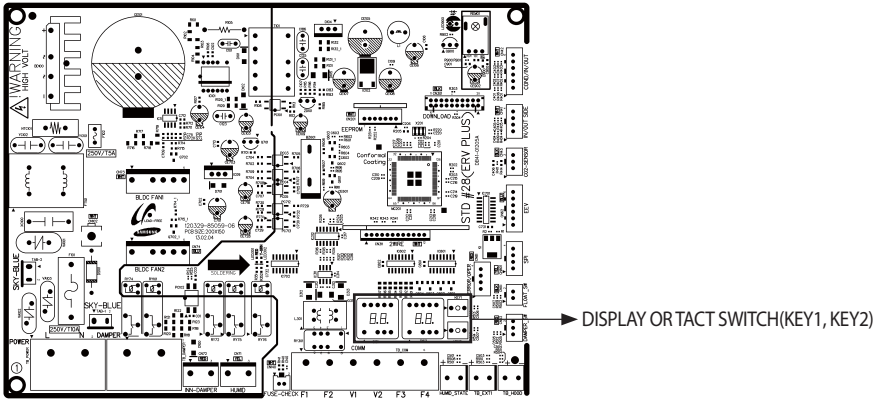

Final checks and user tips

To complete the installation, perform the following checks and tests to ensure that the product operates correctly.

1. **Check the following.**
 - ▶ Strength of the installation site
 - ▶ Tightness of pipe connection to detect a gas leak
 - ▶ Electric wiring connections
 - ▶ Heat-resistant insulation of the pipe
 - ▶ Drainage
 - ▶ Earth conductor connection
 - ▶ Correct operation (follow the steps below)
 - ▶ Insulation

After finishing the installation of the product, you should explain the following to the user. Refer to appropriate pages in the user & installation manual.

1. **How to start and stop the product**
2. **How to select the modes and functions**
3. **How to adjust the temperature and fan speed**
4. **How to adjust the airflow direction**
5. **How to set the timers**
6. **How to clean and replace the filters**



NOTE

- When you complete the installation successfully, hand over the user & installation manual to the user for storage in a handy and safe place.

Troubleshooting

If an error occurs during the operation, The Wired Remote controller show that Error mode.

- When ERRORS related to cooling and heating operation occur, the ventilator (ERV) continues to perform in normal operation.
- When ERRORS related to a ventilator (ERV) occur, it stops operating.

ERROR CODE DISPLAY on Wired remote controller

Error code	Explanation	Classifications
E101	No communication between indoor unit and outdoor unit	Errors related to cooling and heating operation
E102	Indoor unit receiving the communication error from outdoor unit	
E122	EVA-IN Sensor(open/short)	
E123	EVA-OUT Sensor(open/short)	
E128	Breakaway of EVA-IN Sensor	
E129	Breakaway of EVA-OUT Sensor	
E174	EVA-IN Air sensor(open/short)	
E151	Error of EEV open	
E152	Error of EEV close	
E161	Error of mixed operation	
E201	Communication error from outdoor unit due to the mismatching of the communication numbers and installed numbers after tracking	Errors related to ventilator (ERV) operation
E121	Indoor Temperature Sensor(open/short)	
E175	Outdoor Temperature Sensor(open/short)	
E139	CO ₂ sensor (open/short)	
E162	EEPROM ERROR	
E163	EEPROM option setting error	
E186	SPI Error	
E561	Supply Air Fan Motor error	
E562	Exhaust Air Fan Motor error	
E654	Damper ERROR (When there is no switch input for 100 seconds while monitoring the damper)	

Wired Remote Controller Installation/Service Mode

Additional Functions of Your Wired Remote Controller



- 'NONE' will be displayed if the indoor unit does not support the function.
In some cases, the setting may not be possible or it may be not applied though it is set on the unit.
- If communication initialization is needed after the setting, the system will reset automatically and communication will be initialized.

Main menu	Sub menu	Function	Data bit	Factory setting	Description	Unit	
1	1	Wireless remote controller Option setting/checking (1)	Cooling/Heating selection	1	0	0 - Cooling/Heating, 1 - Cooling only	-
			Use of wireless remote controller	2	1	0 - No use, 1 - Use	-
			MAIN/SUB wired remote controller	3	0	0 - MAIN, 1 - SUB	-
			Temperature unit	4	0	0 - Celcius(°C), 1 - Fahrenheit(°F)	-
	2	Wireless remote controller Option setting/checking (2)	Temperature sensor selection	1	0	0 - Indoor unit, 1 - Wired remote controller	-
			Use of average temperature	2	0	0 - No use, 1 - Use	-
			Use of Auto mode	3	1	0 - No use, 1 - Use	-
			Temperature display	4	0	0 - Set temperature, 1 - Room temperature	-
			AC On/Off button function	5	0	0 - Indoor unit + ERV, 1 - Indoor unit only, 2 - ERV only,	-
	3	Blade setting/checking	Lock of Blade1	1	0	0 - Unlock, 1 - lock	-
			Lock of Blade2	2	0	0 - Unlock, 1 - lock	-
			Lock of Blade3	3	0	0 - Unlock, 1 - lock	-
			Lock of Blade4	4	0	0 - Unlock, 1 - lock	-
	4	ERV option Setting/checking	Use of By-Pass mode	1	0	0 - No use, 1 - Use	-
			Use of Auto mode	2	0	0 - No use, 1 - Use	-
			Use of air purification mode	3	0	0 - No use, 1 - Use	-
			Use of external control	4	0	0 - No use, 1 - Use	-
	5	Room Temperature compensation	Temperature control reference	1,2,3	0	-9 ~ 40 °C(15 ~ 104 °F)	0.1 °C
			Temperature compensation value	4,5,6	0	-9.9 ~ 9.9 °C	0.1 °C
	6	Number of connected units	Number of indoor units	1,2	-	0 ~ 16	-
Number of ERVs			3,4	-	0 ~ 16	-	
7		Temperature increment/decrement (°C only)	1	0	0-1 °C, 1-0.5 °C, 2-0.1 °C	-	
8	Set/Check ERV Energy saving operation	Select individual Energy saving operation	1	0	0-ON/OFF alternating operation, 1-Outdoor air cooling operation for different temperature setting	-	
		Minimum temperature of outdoor air cooling	3,4	15	5 ~ 15 °C (41 ~ 59 °F)	°C	
0		Factory option setting	1	0	0 - Unchanged 1 - Factory setting	-	
2	1	Software code	1~6	-	Software code	-	
	2	Software version	1~6	-	Software version	-	

Wired Remote Controller Installation/Service Mode

Main menu	Sub menu	Function	Data bit	Factory setting	Description	Unit	
3	1	Indoor unit room temperature	1,2,3	-	Room temperature	°C	
	2	Indoor unit EVA IN temperature	1,2,3	-	EVA IN temperature	°C	
	3	Indoor unit EVA OUT temperature	1,2,3	-	EVA OUT temperature	°C	
	4	Indoor unit EEV step	1,2,3	-	EEV step	-	
	5	Indoor unit option checking (1)	Use of central control	1	-	0 – No use, 1 - Use	-
			Use of drain pump	2	-	0 – No use, 1 - Use	-
			Use of electric heater	3	-	0 – No use, 1 - Use	-
			Use of hot water coil	4	-	0 – No use, 1 - Use	-
	6	Indoor unit option checking (2)	Use of external control	1	-	0 – No use, 1 - Use	-
			Use of RPM compensation	2	-	0 – No use, 1 - Use	-
			Filter time	3	-	0 – 2000 hours, 1 – 1000 hours	-
			Heating temperature compensation	4	-	0-2 °C, 1-5 °C	-
EEV stop step in heating			5	-	0 – 1/80 steps, 1 – 80	-	
4	1	Indoor Unit Option Setting ²⁾	Indoor unit main address	1,2	-	main address (00H~4FH)	-
			Indoor unit setup address (manual setting main address)	3,4	-	main address (00H~4FH)	-
			Indoor unit RMC address	5,6	-	main address (00H~FEH)	-
			Indoor unit BASIC option code	1)*	-	Indoor unit option code	-
			Indoor unit INSTALL option	1)*	-	Refer to the indoor unit installation manual for details	-
			Indoor unit INSTALL option(2)	1)*	-		-
5	1	AHU setting/checking	RPM setting/checking	3,4	-	0~31 steps	1 step
			Humidity setting/checking	6	-	0 – 30, 1 - 40, 2 - 50	-
	2	Indoor unit, AHU discharge temperature setting/checking	Use of discharge temperature control	1	-	0 – No use, 1 - Use	-
			Cooling discharge temperature	3,4	-	8~18 °C (46~64 °F)	1 °C
			Heating discharge temperature	5,6	-	30~43 °C (86~109 °F)	1 °C
	3	Fresh Duct discharge temperature checking	Cooling discharge temperature	1,2	-	15~25 °C (59~77 °F)	1 °C
			Heating discharge temperature	3,4	-	18~30 °C (64~86 °F)	1 °C
6	1	ERV Plus setting/checking	Use of cold air prevention	1	-	0 – No use, 1 - Use	-
			Use of humidification when Heating thermo off	2	-	0 – No use, 1 - Use	-
			Use of fan operation in Defrost	3	-	0 – No use, 1 - Use	-
			Use of humidification when Heating	4	-	0 – No use, 1 - Use	-
	2	ERV Plus temperature setting/checking	Cooling	1,2	-	15~30 °C (59~86 °F)	1 °C
			Heating	3,4	-	15~30 °C (59~86 °F)	1 °C
	3	ERV Plus Auto mode temperature setting/checking	Set temperature	1,2	-	15~30 °C (59~86 °F)	1 °C
			Set temperature difference	3,4	-	5~15 °C (41~59 °F)	1 °C
	4	Setting/checking the compensating temperature A under the Heating EEV control for ERV Plus	Checking the compensating temperature A under the Heating EEV control for ERV Plus	1,2	-	0~10 °C	1 °C
			Checking the compensating temperature B under the Heating EEV control for ERV Plus	3	-	0 – Non use of humidifier(0 °C/32 °F) 1 – Use humidifier(10 °C/50 °F)	-
	5	ERV Plus fan RPM setting/ checking	Air supply RPM	1,2	-	10~27 steps	1 step
			Air exhaustion RPM	3,4	-	10~27 steps	1 step

Main menu	Sub menu	Function	Data bit	Factory setting	Description	Unit	
7	1	Master setting/checking (F3F4 line Indoor unit master)	Indoor unit Master setting/ checking	123456	-	address	-
	2		ERV unit Master setting/ checking	123456	-	address	-
	3	Mode master indoor unit setting/checking (F1F2 line Indoor unit master) 3)*	Mode master indoor unit checking	123456	-	address	-
	4		Mode master indoor unit setting	1	-	0-No use, 1-Use, 2-Release	-
0	1	Reset	Factory setting	1	0	0-No use, 1-Reset	-
	2		Power Master Reset 4)*	1	0	0-No use, 1-Reset	-
	3		Addressing Reset	1	0	0-No use, 1-Reset	-

1)* The total option codes are 24 digits. You can set six digits at a time and it is distinguished by page number.
Press [>] button to go to the next page.

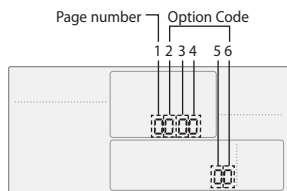

SEG1	SEG2	SEG3	SEG4	SEG5	SEG6
0	*	*	*	*	*

Page number

SEG7	SEG8	SEG9	SEG10	SEG11	SEG12
1	*	*	*	*	*

Page number

SEG13	SEG14	SEG15	SEG16	SEG17	SEG18
2	*	*	*	*	*

Page number

SEG19	SEG20	SEG21	SEG22	SEG23	SEG24
3	*	*	*	*	*

Page number

※ Regardless of Celsius and Fahrenheit setting, service mode setting is available only with Celsius.

- 2)* If you enter Main menu #4, you must select the targeted indoor unit address and then select the sub menu.
3)* Setting is available when there is only 1 indoor unit connection and while the indoor unit operation is not operating.
4)* Power Master Reset is a setting needed to supply optimized power to wired remote controller when multiple indoor units are connected to wired remote controller in a group.

Wired Remote Controller Installation/Service Mode

The example of ERV PLUS option setting method

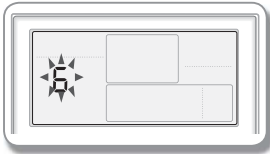

1. Press **Set** and **ESC** buttons at the same time for more than 3 seconds.

- ▶ (Main menu) will be displayed and then press the [^]/[v] button to select no.6.

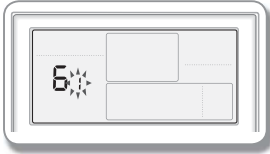

2. Press [**>**] button to select the number you will set.

- ▶ Press [^]/[v] button and select no.1

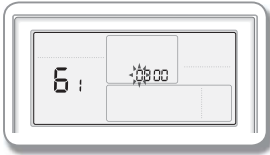

3. Press [**>**] button to enter the data setting stage.

- ▶ When you enter the setting stage, the current setting value will be displayed.

Example of data setting stage display

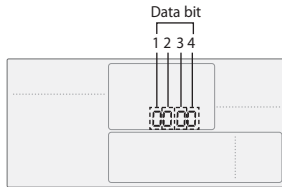

Data1: Nonuse of cold breeze prevention

Data2: Cold breeze prevention: Non use of humidification when the heating THERM is off

Data3: No operation for air supply fan of defrosting operation

Data4: Nonuse of humidification in heating operation



4. Press [**<**]/[**>**] button to select the desired Data1.

- ▶ Press [<]/[>] button to select no.1.
- ▶ The wired remote controller option is changed from "Nonuse of cold breeze prevention" to "Use of cold breeze prevention".

5. Press **Set** button to complete the option setting.

- ▶ Save the setting value and exit to sub menu.

6. Press **Esc** button to exit to normal mode.

QUESTIONS OR COMMENTS?

COUNTRY	CALL	OR VISIT US ONLINE AT
UK	0330 SAMSUNG (7267864)	www.samsung.com/uk/support
IRELAND (EIRE)	0818 717100	www.samsung.com/ie/support
GERMANY	06196 77 555 77*OTH	www.samsung.com/de/support
FRANCE	01 48 63 00 00	www.samsung.com/fr/support
ITALIA	800-SAMSUNG (800.7267864)	www.samsung.com/it/support
SPAIN	0034902172678	www.samsung.com/es/support
PORTUGAL	808 207 267	www.samsung.com/pt/support
LUXEMBURG	261 03 710	www.samsung.com/be_fr/support
NETHERLANDS	088 90 90 100	www.samsung.com/nl/support
BELGIUM	02-201-24-18	www.samsung.com/be/support (Dutch) www.samsung.com/be_fr/support (French)
NORWAY	21629099	www.samsung.com/no/support
DENMARK	707 019 70	www.samsung.com/dk/support
FINLAND	030-6227 515	www.samsung.com/fi/support
SWEDEN	0771 726 786	www.samsung.com/se/support
POLAND	801-172-678* lub +48 22 607-93-33* Dedykowana infolinia do obsługi zapytań dotyczących telefonów komórkowych: 801-672-678* lub +48 22 607-93-33* *(opłata według taryfy operatora)	http://www.samsung.com/pl/support/
HUNGARY	0680SAMSUNG (0680-726-7864)	www.samsung.com/hu/support
AUSTRIA	0800-SAMSUNG (0800-7267864) [Only for KNOX customers] 0800 400848 [Only for Premium HA] 0800-366661 [Only for Dealers] 0810-112233 [Only for E-Store] 0800 100 232	www.samsung.com/at/support

COUNTRY	CALL	OR VISIT US ONLINE AT
SWITZERLAND	0800 726 78 64 (0800-SAMSUNG)	www.samsung.com/ch/support (German) www.samsung.com/ch_fr/support (French)
CZECH	800 - SAMSUNG (800-726786)	www.samsung.com/cz/support
SLOVAKIA	0800 - SAMSUNG (0800-726 786)	www.samsung.com/sk/support
CROATIA	072 726 786	www.samsung.com/hr/support
BOSNIA	055 233 999	www.samsung.com/support
MONTENEGRO	020 405 888	www.samsung.com/support
SLOVENIA	080 697 267 (brezplačna številka)	www.samsung.com/si/support
SERBIA	011 321 6899	www.samsung.com/rs/support
ALBANIA	045 620 202	www.samsung.com/al/support
BULGARIA	*3000 Цена в мрежата 0800 111 31, Безплатна телефонна линия	www.samsung.com/bg/support
ROMANIA	*8000 (apel in retea) 08008-726-78-64 (08008-SAMSUNG) Apel GRATUIT	www.samsung.com/ro/support
CYPRUS	8009 4000 only from landline, toll free	www.samsung.com/gr/support
GREECE	80111-SAMSUNG (80111 726 7864) only from land line (+30) 210 6897691 from mobile and land line	
LITHUANIA	8-800-77777	www.samsung.com/lt/support
LATVIA	8000-7267	www.samsung.com/lv/support
ESTONIA	800-7267	www.samsung.com/ee/support
INDIA	1800 40 SAMSUNG (1800 40 7267864) (Toll-Free)	www.samsung.com/in/support

SAMSUNG ELECTRONICS CO., LTD.

107, Hanamsandan 6beon-ro, Gwangsan-gu, Gwangju-si, Korea 62218

Samsung Electronics

Service Department

PO Box 12987, Blackrock, Co. Dublin. Ireland

or

Blackbushe Business Park, Yateley, GU46 6GG. UK

This product is RoHS compliant



DB68-03715A-07