



DVM S

AM***JXV*** Series

AM***KXV*** Series

AM***MXV*** Series

Air Conditioner installation manual

imagine the possibilities

Thank you for purchasing this Samsung product.

SAMSUNG

Contents

Safety precautions	3
Preparing for installation	6
Selecting installation location	27
Space requirement for installation	29
Accessories	31
Base construction and installation of the outdoor unit	32
Installing the wind/snow prevention duct	36
Refrigerant pipe installation	39
Electrical wiring work	70
Air tightness test and vacuum drying	89
Pipe insulation	91
Charging refrigerant	94
Basic segment display	97
Setting outdoor unit option switch and key function	97
Setting the MCU and Pipe Addresses (for HR Only)	107
Things to check after completing the installation	112
Inspection and test operation	113
Automatic refrigerant amount detection function	120



Correct Disposal of This Product (Waste Electrical & Electronic Equipment)

(Applicable in countries with separate collection systems)

This marking on the product, accessories or literature indicates that the product and its electronic accessories (e.g. charger, headset, USB cable) should not be disposed of with other household waste at the end of their working life. To prevent possible harm to the environment or human health from uncontrolled waste disposal, please separate these items from other types of waste and recycle them responsibly to promote the sustainable reuse of material resources.

Household users should contact either the retailer where they purchased this product, or their local government office, for details of where and how they can take these items for environmentally safe recycling.

Business users should contact their supplier and check the terms and conditions of the purchase contract. This product and its electronic accessories should not be mixed with other commercial wastes for disposal.

For information on Samsung's environmental commitments and product-specific regulatory obligations, e.g. REACH, WEEE, Batteries, visit : samsung.com/uk/aboutsamsung/samsungelectronics/corporatecitizenship/data_corner.html

Safety precautions

Please follow the following safety information for safety of the installer and the user.

- ※ DVM S air conditioner uses R-410A refrigerant.
 - When using R-410A, moisture or foreign substances may affect the performance and reliability of the product. Safety precautions must be obeyed when installing the refrigerant pipe.
 - The designed maximum pressure of the system is 4.1MPa and therefore select appropriate material and thickness according to the regulations.
 - R-410A is a quasi-azeotrope of two refrigerants and it has to be charged in liquid phase when filling the refrigerant. (If you charge vapor refrigerant, it may change the blend of the refrigerant and cause product malfunction.)
 - ※ You must connect the indoor units for R-410A refrigerant. Refer to product catalog to find out the models names for connectable indoor units. (If you connect the indoor units that are not designed for R-410A, it cannot operated normally.)
-
- ※ After completing the installation and trial operation, explain to the user how to use and maintain the product. Also, hand over this installation manual so that it can be stored by the user.
 - ※ Manufacturer is not responsible for the incidents occurred by improper installation. Installer is responsible for any installation related claims from the user occurred by neglecting warnings and cautions stated in this manual. (Installer will be responsible for any service charges that may occur)
 - ※ Generally, system air conditioners should not be relocated after installation. But when it has to be relocated for inevitable reasons, please contact Samsung's qualified dealers for system air conditioners.



WARNING

- Hazards or unsafe practices that may **result in severe personal injury or death.**



CAUTION

- Hazards or unsafe practices that may **result in minor personal injury (to installer/user) or property damage.**

SEVERE WARNING SIGNS

Consult qualified installer or dealer for installation.

- ▶ When installation is done by unqualified person, problems such as water leakage, electric shock or fire may occur.

Installation work must be done properly according to this installation manual.

- ▶ When installation is not done properly, it may cause water leakage, electric shock or fire.

When installing the unit in a small room, take measure to keep the refrigerant concentration from exceeding allowable safety limits in case of refrigerant leakage. Consult the dealer for precautionary measure before the installation.

- ▶ When refrigerant leaks and exceed dangerous concentration level, it may cause suffocation accidents.

If any gas or impurities, except R-410A refrigerant, come into the refrigerant pipe, serious problem may occur and it may cause injury.

Use the supplied accessories, specified components and tools for the installation.

- ▶ Do not use the pipe and the installation product used for the R-22 refrigerant.
- ▶ Failure to use the specified components can cause product fall down, water leakage, electrical shock, and fire. (The pipe and flare components used for R-22 refrigerant must not be used)

Install the outdoor unit on a hard and even place that can support its weight.

- ▶ If the place cannot support its weight, the outdoor unit may fall down and it may cause injury.

Safety precautions

Check the following before installation and service work.

- ▶ Before welding, remove dangerous and inflammable things that may cause an explosion and fire around the work.
- ▶ Before welding, remove the refrigerant from inside the pipe or the product.
 - If you perform welding while refrigerant is in the pipe, it may increase the pressure of the refrigerant and cause the pipe to burst. If the pipe bursts or explodes, it may cause severe injury to the installer.
- ▶ When welding, use the nitrogen gas to eliminate oxidation inside the pipe.

Do not modify the product on your own.

- ▶ Potential risk of electric shock, fire, product failure or injury.

Fix the outdoor unit securely on foundation to resist strong wind or earthquake.

- ▶ If the outdoor unit is not properly fixed, it turns over and accidents may occur.

Electric work must be done by qualified persons, complying the national wiring regulations and installed according to the instruction stated in the installation manual with leased circuit.

- ▶ Capacity shortage on the leased circuit and improper installation may cause electric shock or fire.

Make sure to perform grounding work.

- ▶ Do not connect the ground wire to a gas pipe, water pipe, lightning rod or telephone grounding. Improper grounding could cause electric shock.

Wiring must be connected with the designated wires and it must be fixed securely so that it does not apply any external force to the connection part of the terminals.

- ▶ If connection for fixation is not properly done, it may cause heat generation or fire.

Neatly arrange the wires in the electrical parts to make sure that electrical cover is closed securely without any gaps.

- ▶ If the cover is not properly closed, heat may generate on the electrical terminal and cause electric shock or fire.

Exclusive circuit breaker (MCCB, ELB) must be installed to the power supply.

- ▶ When overcurrent or current leakage occurs with no circuit breaker installed, power will not be cut-off and it may cause electric shock or fire.
- ▶ Do not use damaged parts. It may cause fire or electric shock.

You must cut-off the power before you work on, or adjust any power supply part for product installation, maintenance, repair or any other services.

- ▶ There is risk of electric shock.
- ▶ Even when the power is off, it is dangerous when you come in contact with inverter PCB, fan PCB since high pressure DC voltage is charged to those parts.
- ▶ When replacing/repairing the PCB, cut-off the power and wait until the DC voltage is discharged before replacing/repairing them. (Wait for more than 15 minutes to allow it to discharge naturally.)

If the refrigerant gas leaks during the installation, you should ventilate the room.

- ▶ When the refrigerant gas gets in contact with flammable substance, it may generate toxic gas.

Gas leakage must be checked after installation is completed.

- ▶ When the refrigerant gas gets in contact with flammable substance, it may generate toxic gas.

You can get a frostbite if you get in contact with the leaked refrigerant gas.

Supply power to the product during winter time since the product will operate in protection mode itself when the temperature decrease below 0°C.

- ▶ If you cut-off the power, compressor protection mode cannot be operated and may cause damage to the product.

This appliance is not intended for use by persons (including children) with reduced physical, sensory or mental capabilities, or lack of experience and knowledge, unless they have been given supervision or instruction concerning use of the appliance by a person responsible for their safety. Children should be supervised to ensure that they do not play with the appliance.

For use in Europe : This appliance can be used by children aged from 8 years and above and persons with reduced physical, sensory or mental capabilities or lack of experience and knowledge if they have been given supervision or instruction concerning use of the appliance in a safe way and understand the hazards involved. Children shall not play with the appliance. Cleaning and user maintenance shall not be made by children without supervision.

CAUTION SIGNS

Do not install the drain pipe directly to the bottom part of the outdoor unit and built a proper drainage so that water drains out smoothly. If not, pipe may freeze or bursts during winter time and cause damage to the product or water leakage.

- ▶ When the draining work is not done properly, water leak may occur and cause property damage.

Install the power cable and communication cable of the indoor and outdoor unit at least 1.5m away from the electric appliances and install it at least 2m away from the lightning conductor.

- ▶ Noise may be generated from the electronic devices, depending on the status of the electric wave.

Install the outdoor unit within the angle stated in the table, according to the height of the building.

- ▶ Do not leave the refrigerant container under the hot sunlight. (There is risk of explosion.)
- ▶ You must use the appropriate pipes according to the standard since the pressure of the refrigerant is very high.
- ▶ Make sure that the pipes does not get any weaker by welding it too much.
- ▶ Make sure to install the product away from children's' reach. (Sharp parts of the heat exchanger is may cause personal injury and when parts of the product gets damage, it may decrease product's performance.)

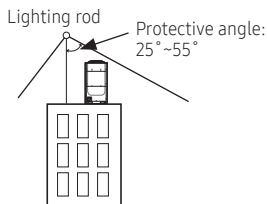

Height of the building	Protection control
20m or less	55°
40m or less	35°
60m or less	25°

Install the indoor unit away from lighting apparatus that uses ballast stabilizer.

- ▶ If you use the wireless remote control, it may not operate normally due to ballast stabilizer.

Do not install the product in following places.

- ▶ Place where outdoor unit's noise and warm air may disturb neighbors. (It may cause property loss.)
- ▶ Do not leave any obstacles around the inlet and outlet of the product. (It may cause damage or accidents.)
- ▶ The place where there is mineral oil or arsenic acid.
 - Those parts may get damaged due to burned resin and cause water leakage or product may fall.
 - The efficiency of the heat exchanger may reduce or product may break.
- ▶ The place where corrosive gas such as sulfurous acid gas generates from the vent pipe or air outlet.
 - The copper pipe or connection pipe may corrode and refrigerant may leak.
- ▶ The place where there is a machine that generates electromagnetic waves.
 - The air conditioner may not operate normally due to problems in control system.
- ▶ The place where there is a danger of combustible gas leakage or place where thinner or gasoline is handled.
 - (There is risk of fire or explosion.)
- ▶ The place with carbon fiber or flammable dust.
- ▶ The place near seashore or hot spring where there is risk of outdoor unit corrosion.

Safety precautions

Changes in DVM S (inverter) compare to conventional models that has to noted when installing

- ▶ For optimal distribution of the refrigerant, you must use Y-joint as branch joint for connecting outdoor units. (Do not use T-joint)
- ▶ You cannot operate normally if you do not complete the trial operation through outdoor unit key mode. You must use KEY MODE to run trial operation.
- ▶ DVM S air conditioner uses R-410A refrigerant.
- ▶ Check the compatibility of other products such as indoor unit, EEV kits etc. which will be connected to DVM S.
- ▶ Make sure to note that outdoor unit combination is different from DVM PLUS III and IV.
- ▶ The length of maximum piping, level difference, the quantity of connectable indoor units, the installation at the outdoor joints and the outdoor unit combinations are different from the conventional models.
- ▶ If the pipe length is over 2 m between outdoor units, make traps to prevent oil stagnation. Oil stagnation may occur when outdoor unit at the end of module stops while other outdoor units are still in operation.

Preparing for installation

Outdoor unit classification

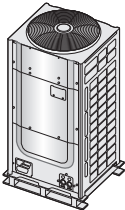
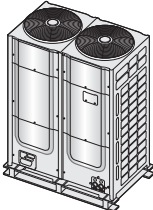
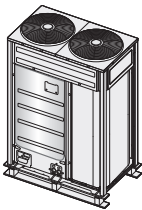
Classification	Small type	DVM S Large A type	DVM S Large B type
Appearance			



CAUTION

Packaging material disposition

- Safely store or dispose the packaging materials.
 - Sharp metals such as nails or wooden material packaging that may break into pieces become a cause for personal injury.
 - Make sure to store or dispose the vinyl type packaging material to keep it out of reach of children. Children may put them over their face, which is very dangerous since it may lead them to suffocation.

Outdoor unit combination

- ▶ Make sure to use an indoor unit that is compatible with DVM S.
- ▶ Indoor units can be connected within the range indicated in following table.
- ▶ If the total capacity of the connected indoor units exceeds the indicated maximum capacity, cooling and heating capacity of the indoor unit may decrease.
- ▶ Total capacity of the connected indoor units can be allowed from 50% to 130% of the total outdoor unit capacity. $0.5 \times \Sigma(\text{Outdoor unit capacity}) \leq \text{Total capacity of the connected indoor units} \leq 1.3 \times \Sigma(\text{Outdoor unit capacity})$
- ※ You can connect maximum 64 indoor units to the outdoor unit. Maximum quantity of connectable indoor unit is set to 64 since outdoor unit only support up to 64 communication address. Indoor unit address can be assigned from 0~63. If the indoor unit address was assigned from 64~79, E201 error will occur.
- ※ Maximum 32 Wall-mount type indoor units with EEV (AM**X*NQDEH*, AM**X*JNV*) can be connected.
- ※ Do not install 1st-generation MCU and 2nd-generation MCU together.
 - 1st-generation MCU: MCU-S*NEE*N, MCU-S2NEK1N
 - 2nd-generation MCU: MCU-S*NEK2N, MCU-S4NEK3N, MCU-S1NEK1N



- Use the following table to determine the size and number of outdoor units needed to achieve the capacity requirements.

Standard type (Heat pump)

Model mane of combination		AM080JX VAGH/EU	AM100JX VAGH/EU	AM120JX VAGH/EU	AM140KX VAGH/ET	AM160KX VAGH/ET	AM180KX VAGH/ET
Number of individual outdoor units		1	1	1	1	1	1
Combined outdoor unit	AM080JXVAGH/EU	1					
	AM100JXVAGH/EU		1				
	AM120JXVAGH/EU			1			
	AM140KXVAGH/ET				1		
	AM160KXVAGH/ET					1	
	AM180KXVAGH/ET						1
	AM200KXVAGH/ET						
	AM220KXVAGH/ET						
	AM240KXVAGH/ET						
	AM260KXVAGH/ET						
AM280KXVAGH/ET							
AM300KXVAGH/ET							
Rated capacity	Cooling (kW)	22.4	28	33.6	40	45	50.4
	Heating (kW)	25.2	31.5	37.8	45	50.4	56.7
Total capacity of the connected indoor units (Cooling)	Minimum (kW)	11.2	14	16.8	20	22.5	25.2
	Maximum (kW)	29.1	36.4	43.7	52.0	58.5	65.5
Maximum number of connectable indoor units		14	18	21	26	29	32

Preparing for installation

Model mane of combination		AM200KX VAGH/ET	AM220KX VAGH/ET	AM240KX VAGH/ET	AM260KX VAGH/ET	AM280KX VAGH/ET	AM300KX VAGH/ET
Number of individual outdoor units		1	1	1	1	1	1
Combined outdoor unit	AM080JXVAGH/EU						
	AM100JXVAGH/EU						
	AM120JXVAGH/EU						
	AM140KXVAGH/ET						
	AM160KXVAGH/ET						
	AM180KXVAGH/ET						
	AM200KXVAGH/ET	1					
	AM220KXVAGH/ET		1				
	AM240KXVAGH/ET			1			
	AM260KXVAGH/ET				1		
AM280KXVAGH/ET					1		
AM300KXVAGH/ET						1	
Rated capacity	Cooling (kW)	56	61.6	67.2	72.8	78.6	84
	Heating (kW)	63	69.3	75.6	81.9	88.2	94.5
Total capacity of the connected indoor units (Cooling)	Minimum (kW)	28	30.8	33.6	36.4	39.3	42
	Maximum (kW)	72.8	80.1	87.4	94.6	102.2	109.2
Maximum number of connectable indoor units		36	40	43	47	51	54
Model mane of combination		AM320KX VAGH/ET	AM340KX VAGH/ET	AM360KX VAGH/ET	AM380KX VAGH/ET	AM400KX VAGH/ET	AM420KX VAGH/ET
Number of individual outdoor units		2	2	2	2	2	2
Combined outdoor unit	AM080JXVAGH/EU						
	AM100JXVAGH/EU	1					
	AM120JXVAGH/EU		1				
	AM140KXVAGH/ET			1			
	AM160KXVAGH/ET				1		
	AM180KXVAGH/ET					1	
	AM200KXVAGH/ET						1
	AM220KXVAGH/ET	1	1	1	1	1	1
	AM240KXVAGH/ET						
	AM260KXVAGH/ET						
AM280KXVAGH/ET							
AM300KXVAGH/ET							
Rated capacity	Cooling (kW)	89.6	95.2	101.6	106.6	112	117.6
	Heating (kW)	100.8	107.1	114.3	119.7	126	132.3
Total capacity of the connected indoor units (Cooling)	Minimum (kW)	44.8	47.6	50.8	53.3	56	58.8
	Maximum (kW)	116.5	123.8	132.1	138.6	145.6	152.9
Maximum number of connectable indoor units		58	61	64	64	64	64

Model mane of combination		AM440KX VAGH/ET	AM460KX VAGH/ET	AM480KX VAGH/ET	AM500KX VAGH/ET	AM520KX VAGH/ET	AM540KX VAGH/ET
Number of individual outdoor units		2	2	2	2	2	2
Combined outdoor unit	AM080JXVAGH/EU						
	AM100JXVAGH/EU						
	AM120JXVAGH/EU						
	AM140KXVAGH/ET						
	AM160KXVAGH/ET		1				
	AM180KXVAGH/ET			1			
	AM200KXVAGH/ET				1		
	AM220KXVAGH/ET	2				1	
	AM240KXVAGH/ET						1
	AM260KXVAGH/ET						
AM280KXVAGH/ET							
AM300KXVAGH/ET		1	1	1	1	1	
Rated capacity	Cooling (kW)	123.2	129	134.4	140	145.6	151.2
	Heating (kW)	138.6	144.9	151.2	157.5	163.8	170.1
Total capacity of the connected indoor units (Cooling)	Minimum (kW)	61.6	64.5	67.2	70	72.8	75.6
	Maximum (kW)	160.2	167.7	174.7	182.0	189.3	196.6
Maximum number of connectable indoor units		64	64	64	64	64	64

Model mane of combination		AM560KX VAGH/ET	AM580KX VAGH/ET	AM600KX VAGH/ET	AM620KX VAGH/ET	AM640KX VAGH/ET	AM660KX VAGH/ET
Number of individual outdoor units		2	2	2	3	3	3
Combined outdoor unit	AM080JXVAGH/EU						
	AM100JXVAGH/EU				1		
	AM120JXVAGH/EU					1	
	AM140KXVAGH/ET						1
	AM160KXVAGH/ET						
	AM180KXVAGH/ET						
	AM200KXVAGH/ET						
	AM220KXVAGH/ET				1	1	1
	AM240KXVAGH/ET						
	AM260KXVAGH/ET	1					
AM280KXVAGH/ET		1					
AM300KXVAGH/ET	1	1	2	1	1	1	
Rated capacity	Cooling (kW)	156.8	162.6	168	173.6	179.2	185.6
	Heating (kW)	176.4	182.7	189	195.3	201.6	208.8
Total capacity of the connected indoor units (Cooling)	Minimum (kW)	78.4	81.3	84	86.8	89.6	92.8
	Maximum (kW)	203.8	211.4	218.4	225.7	233.0	241.3
Maximum number of connectable indoor units		64	64	64	64	64	64

Preparing for installation

Model mane of combination		AM680KX VAGH1ET	AM700KX VAGH/ET	AM720KX VAGH/ET	AM740KX VAGH/ET	AM760KX VAGH/ET	AM780KX VAGH/ET
Number of individual outdoor units		3	3	3	3	3	3
Combined outdoor unit	AM080JXVAGH/EU						
	AM100JXVAGH/EU						
	AM120JXVAGH/EU						
	AM140KXVAGH/ET						
	AM160KXVAGH/ET	1					
	AM180KXVAGH/ET		1				
	AM200KXVAGH/ET			1			
	AM220KXVAGH/ET	1	1	1	2	1	1
	AM240KXVAGH/ET					1	
	AM260KXVAGH/ET						1
AM280KXVAGH/ET							
AM300KXVAGH/ET	1	1	1	1	1	1	
Rated capacity	Cooling (kW)	190.6	196	201.6	207.2	212.8	218.4
	Heating (kW)	214.2	220.5	226.8	233.1	239.4	245.7
Total capacity of the connected indoor units (Cooling)	Minimum (kW)	95.3	98	100.8	103.6	106.4	109.2
	Maximum (kW)	247.8	254.8	262.1	269.4	276.6	283.9
Maximum number of connectable indoor units		64	64	64	64	64	64

Model mane of combination		AM800KX VAGH/ET	AM820KX VAGH/ET	AM840KX VAGH/ET	AM860KX VAGH/ET	AM880KX VAGH/ET	AM900KX VAGH/ET
Number of individual outdoor units		3	3	3	3	3	3
Combined outdoor unit	AM080JXVAGH/EU						
	AM100JXVAGH/EU						
	AM120JXVAGH/EU						
	AM140KXVAGH/ET						
	AM160KXVAGH/ET						
	AM180KXVAGH/ET						
	AM200KXVAGH/ET						
	AM220KXVAGH/ET	1	1				
	AM240KXVAGH/ET			1			
	AM260KXVAGH/ET				1		
AM280KXVAGH/ET	1				1		
AM300KXVAGH/ET	1	2	2	2	2	3	
Rated capacity	Cooling (kW)	224.2	229.6	235.2	240.8	246.6	252
	Heating (kW)	252	258.3	264.6	270.9	277.2	283.5
Total capacity of the connected indoor units (Cooling)	Minimum (kW)	112.1	114.8	117.6	120.4	123.3	126
	Maximum (kW)	291.5	298.5	305.8	313.0	320.6	327.6
Maximum number of connectable indoor units		64	64	64	64	64	64

Premium compact type (Heat pump)

Model mane of combination		AM080JX VHGH/EU	AM100JX VHGH/EU	AM120JX VHGH/EU	AM140JX VHGH/ET	AM160JX VHGH/ET	AM180JX VHGH/ET
Number of individual outdoor units		1	1	1	1	1	1
Combined outdoor unit	AM080JXVHGH/EU	1					
	AM100JXVHGH/EU		1				
	AM120JXVHGH/EU			1			
	AM140JXVHGH/ET				1		
	AM160JXVHGH/ET					1	
	AM180JXVHGH/ET						1
	AM200JXVHGH/ET						
	AM220JXVHGH/ET						
	AM240KXVGGH/ET						
	AM260KXVGGH/ET						
AM280KXVGGH/ET							
AM300KXVAGH/ET							
Rated capacity	Cooling (kW)	22.4	28	33.6	40	45	50.4
	Heating (kW)	25.2	31.5	37.8	45	50.4	56.7
Total capacity of the connected indoor units (Cooling)	Minimum (kW)	11.2	14	16.8	20	22.5	25.2
	Maximum (kW)	29.1	36.4	43.7	52.0	58.5	65.5
Maximum number of connectable indoor units		14	18	21	26	29	32

Model mane of combination		AM200JX VHGH/ET	AM220JX VHGH/ET	AM240KX VGGH/ET	AM260KX VGGH/ET	AM280KX VGGH/ET	AM300KX VAGH/ET
Number of individual outdoor units		1	1	1	1	1	1
Combined outdoor unit	AM080JXVHGH/EU						
	AM100JXVHGH/EU						
	AM120JXVHGH/EU						
	AM140JXVHGH/ET						
	AM160JXVHGH/ET						
	AM180JXVHGH/ET						
	AM200JXVHGH/ET	1					
	AM220JXVHGH/ET		1				
	AM240KXVGGH/ET			1			
	AM260KXVGGH/ET				1		
AM280KXVGGH/ET					1		
AM300KXVAGH/ET						1	
Rated capacity	Cooling (kW)	56	61.6	67.2	72.8	78.6	84
	Heating (kW)	63	69.3	75.6	81.9	88.2	94.5
Total capacity of the connected indoor units (Cooling)	Minimum (kW)	28	30.8	33.6	36.4	39.3	42
	Maximum (kW)	72.8	80.1	87.4	94.6	102.2	109.2
Maximum number of connectable indoor units		36	40	43	47	51	54

Preparing for installation

Model mane of combination		AM320KX VGGH1ET	AM340KX VGGH1ET	AM360KX VGGH1ET	AM380KX VGGH1ET	AM400KX VGGH1ET	AM420KX VGGH1ET
Number of individual outdoor units		2	2	2	2	2	2
Combined outdoor unit	AM080JXVHGH/EU						
	AM100JXVHGH/EU						
	AM120JXVHGH/EU	1	1				
	AM140JXVHGH/ET			1			
	AM160JXVHGH/ET				1		
	AM180JXVHGH/ET					1	
	AM200JXVHGH/ET	1					1
	AM220JXVHGH/ET		1	1	1	1	1
	AM240KXVGGH/ET						
	AM260KXVGGH/ET						
AM280KXVGGH/ET							
AM300KXVAGH/ET							
Rated capacity	Cooling (kW)	89.6	95.2	101.6	106.6	112	117.6
	Heating (kW)	100.8	107.1	114.3	119.7	126	132.3
Total capacity of the connected indoor units (Cooling)	Minimum (kW)	44.8	47.6	50.8	53.3	56	58.8
	Maximum (kW)	116.5	123.8	132.1	138.6	145.6	152.9
Maximum number of connectable indoor units		58	61	64	64	64	64

Model mane of combination		AM440KX VGGH1ET	AM460KX VGGH1ET	AM480KX VGGH1ET	AM500KX VGGH1ET	AM520KX VGGH1ET	AM540KX VGGH1ET
Number of individual outdoor units		2	2	2	2	2	2
Combined outdoor unit	AM080JXVHGH/EU						
	AM100JXVHGH/EU						
	AM120JXVHGH/EU						
	AM140JXVHGH/ET	1					
	AM160JXVHGH/ET		1				
	AM180JXVHGH/ET			1			
	AM200JXVHGH/ET				1		
	AM220JXVHGH/ET					1	
	AM240KXVGGH/ET						1
	AM260KXVGGH/ET						
AM280KXVGGH/ET							
AM300KXVAGH/ET	1	1	1	1	1	1	
Rated capacity	Cooling (kW)	124	129	134.4	140	145.6	151.2
	Heating (kW)	139.5	144.9	151.2	157.5	163.8	170.1
Total capacity of the connected indoor units (Cooling)	Minimum (kW)	62	64.5	67.2	70	72.8	75.6
	Maximum (kW)	161.2	167.7	174.7	182.0	189.3	196.6
Maximum number of connectable indoor units		64	64	64	64	64	64

Model mane of combination		AM560KX VGGH1ET	AM580KX VGGH1ET	AM600KX VGGH1ET	AM620KX VGGH1ET	AM640KX VGGH1ET	AM660KX VGGH1ET
Number of individual outdoor units		2	2	2	3	3	3
Combined outdoor unit	AM080JXVHGH/EU						
	AM100JXVHGH/EU						
	AM120JXVHGH/EU				1	1	
	AM140JXVHGH/ET						1
	AM160JXVHGH/ET						
	AM180JXVHGH/ET						
	AM200JXVHGH/ET				1		
	AM220JXVHGH/ET					1	1
	AM240KXVGGH/ET						
	AM260KXVGGH/ET	1					
AM280KXVGGH/ET		1					
AM300KXVAGH/ET	1	1	2	1	1	1	
Rated capacity	Cooling (kW)	156.8	162.6	168	173.6	179.2	185.6
	Heating (kW)	176.4	182.7	189	195.3	201.6	208.8
Total capacity of the connected indoor units (Cooling)	Minimum (kW)	78.4	81.3	84	86.8	89.6	92.8
	Maximum (kW)	203.8	211.4	218.4	225.7	233.0	241.3
Maximum number of connectable indoor units		64	64	64	64	64	64

Model mane of combination		AM680KX VGGH1ET	AM700KX VGGH1ET	AM720KX VGGH1ET	AM740KX VGGH1ET	AM760KX VGGH1ET	AM780KX VGGH1ET
Number of individual outdoor units		3	3	3	3	3	3
Combined outdoor unit	AM080JXVHGH/EU						
	AM100JXVHGH/EU						
	AM120JXVHGH/EU						
	AM140JXVHGH/ET						
	AM160JXVHGH/ET	1					
	AM180JXVHGH/ET		1				
	AM200JXVHGH/ET			1			
	AM220JXVHGH/ET	1	1	1	2	1	1
	AM240KXVGGH/ET					1	
	AM260KXVGGH/ET						1
AM280KXVGGH/ET							
AM300KXVAGH/ET	1	1	1	1	1	1	
Rated capacity	Cooling (kW)	190.6	196	201.6	207.2	212.8	218.4
	Heating (kW)	214.2	220.5	226.8	233.1	239.4	245.7
Total capacity of the connected indoor units (Cooling)	Minimum (kW)	95.3	98	100.8	103.6	106.4	109.2
	Maximum (kW)	247.8	254.8	262.1	269.4	276.6	283.9
Maximum number of connectable indoor units		64	64	64	64	64	64

Preparing for installation

Model mane of combination		AM800KX VGGH1ET	AM820KX VGGH1ET	AM840KX VGGH1ET	AM860KX VGGH1ET	AM880KX VGGH1ET	AM900KX VGGH1ET
Number of individual outdoor units		3	3	3	3	3	3
Combined outdoor unit	AM080JXVHGH/EU						
	AM100JXVHGH/EU						
	AM120JXVHGH/EU						
	AM140JXVHGH/ET						
	AM160JXVHGH/ET						
	AM180JXVHGH/ET						
	AM200JXVHGH/ET						
	AM220JXVHGH/ET	1	1				
	AM240KXVGGH/ET			1			
	AM260KXVGGH/ET				1		
AM280KXVGGH/ET	1				1		
AM300KXVAGH/ET	1	2	2	2	2	3	
Rated capacity	Cooling (kW)	224.2	229.6	235.2	240.8	246.6	252
	Heating (kW)	252	258.3	264.6	270.9	277.2	283.5
Total capacity of the connected indoor units (Cooling)	Minimum (kW)	112.1	114.8	117.6	120.4	123.3	126
	Maximum (kW)	291.5	298.5	305.8	313.0	320.6	327.6
Maximum number of connectable indoor units		64	64	64	64	64	64

Premium energy efficiency type (Heat pump)

Model mane of combination		AM080JX VHGH/EU	AM100JX VHGH/EU	AM120JX VHGH/EU	AM140JX VHGH/ET	AM160JX VHGH/ET	AM180JX VHGH/ET
Number of individual outdoor units		1	1	1	1	1	1
Combined outdoor unit	AM080JXVHGH/EU	1					
	AM100JXVHGH/EU		1				
	AM120JXVHGH/EU			1			
	AM140JXVHGH/ET				1		
	AM160JXVHGH/ET					1	
	AM180JXVHGH/ET						1
	AM200JXVHGH/ET						
	AM220JXVHGH/ET						
	AM240KXVGGH/ET						
AM260KXVGGH/ET							
Rated capacity	Cooling (kW)	22.4	28	33.6	40	45	50.4
	Heating (kW)	25.2	31.5	37.8	45	50.4	56.7
Total capacity of the connected indoor units (Cooling)	Minimum (kW)	11.2	14	16.8	20	22.5	25.2
	Maximum (kW)	29.1	36.4	43.7	52.0	58.5	65.5
Maximum number of connectable indoor units		14	18	21	26	29	32

Model mane of combination		AM200JX VHGH/ET	AM220KX VGGH2ET	AM240KX VGGH2ET	AM260KX VGGH2ET	AM280KX VGGH2ET	AM300KX VGGH2ET
Number of individual outdoor units		1	2	2	2	2	2
Combined outdoor unit	AM080JXVHGH/EU				1	1	
	AM100JXVHGH/EU		1				
	AM120JXVHGH/EU		1	2			1
	AM140JXVHGH/ET						
	AM160JXVHGH/ET						
	AM180JXVHGH/ET				1		1
	AM200JXVHGH/ET	1				1	
	AM220JXVHGH/ET						
	AM240KXVGGH/ET						
AM260KXVGGH/ET							
Rated capacity	Cooling (kW)	56	61.6	67.2	72.8	78.4	84
	Heating (kW)	63	69.3	75.6	81.9	88.2	94.5
Total capacity of the connected indoor units (Cooling)	Minimum (kW)	28	30.8	33.6	36.4	39.2	42
	Maximum (kW)	72.8	80.1	87.4	94.6	101.9	109.2
Maximum number of connectable indoor units		36	40	43	47	51	54

Model mane of combination		AM320KX VGGH2ET	AM340KX VGGH2ET	AM360KX VGGH2ET	AM380KX VGGH2ET	AM400KX VGGH2ET	AM420KX VGGH2ET
Number of individual outdoor units		2	3	2	2	3	3
Combined outdoor unit	AM080JXVHGH/EU		2			1	1
	AM100JXVHGH/EU						
	AM120JXVHGH/EU						
	AM140JXVHGH/ET	1				1	1
	AM160JXVHGH/ET						
	AM180JXVHGH/ET	1	1	2	1	1	
	AM200JXVHGH/ET				1		1
	AM220JXVHGH/ET						
	AM240KXVGGH/ET						
AM260KXVGGH/ET							
Rated capacity	Cooling (kW)	90.4	95.2	100.8	106.4	112.8	118.4
	Heating (kW)	101.7	107.1	113.4	119.7	126.9	133.2
Total capacity of the connected indoor units (Cooling)	Minimum (kW)	45.2	47.6	50.4	53.2	56.4	59.2
	Maximum (kW)	117.5	123.8	131.0	138.3	146.6	153.9
Maximum number of connectable indoor units		58	61	64	64	64	64

Preparing for installation

Model mane of combination		AM440KX VGGH2ET	AM460KX VGGH2ET	AM480KX VGGH2ET	AM500KX VGGH2ET	AM520KX VGGH2ET	AM540KX VGGH2ET
Number of individual outdoor units		3	3	3	3	3	3
Combined outdoor unit	AM080JXVHGH/EU	1	1	1		1	1
	AM100JXVHGH/EU						
	AM120JXVHGH/EU						
	AM140JXVHGH/ET				1		
	AM160JXVHGH/ET						
	AM180JXVHGH/ET	2	1		2	1	
	AM200JXVHGH/ET		1	2			1
	AM220JXVHGH/ET						
	AM240KXVGGH/ET						
AM260KXVGGH/ET					1	1	
Rated capacity	Cooling (kW)	123.2	128.8	134.4	140.8	145.6	151.2
	Heating (kW)	138.6	144.9	151.2	158.4	163.8	170.1
Total capacity of the connected indoor units (Cooling)	Minimum (kW)	61.6	64.4	67.2	70.4	72.8	75.6
	Maximum (kW)	160.2	167.4	174.7	183.0	189.3	196.6
Maximum number of connectable indoor units		64	64	64	64	64	64

Model mane of combination		AM560KX VGGH2ET	AM580KX VGGH2ET	AM600KX VGGH2ET	AM620KX VGGH2ET	AM640KX VGGH2ET	AM660KX VGGH2ET
Number of individual outdoor units		3	3	3	4	4	4
Combined outdoor unit	AM080JXVHGH/EU		1		1	1	
	AM100JXVHGH/EU						
	AM120JXVHGH/EU	1					1
	AM140JXVHGH/ET						
	AM160JXVHGH/ET						
	AM180JXVHGH/ET	1		2	3	2	3
	AM200JXVHGH/ET					1	
	AM220JXVHGH/ET						
	AM240KXVGGH/ET		1	1			
AM260KXVGGH/ET	1	1					
Rated capacity	Cooling (kW)	156.8	162.4	168	173.6	179.2	184.8
	Heating (kW)	176.4	182.7	189	195.3	201.6	207.9
Total capacity of the connected indoor units (Cooling)	Minimum (kW)	78.4	81.2	84	86.8	89.6	92.4
	Maximum (kW)	203.8	211.1	218.4	225.7	233.0	240.2
Maximum number of connectable indoor units		64	64	64	64	64	64

Model mane of combination		AM680KX VGGH2ET	AM700KX VGGH2ET	AM720KX VGGH2ET	AM740KX VGGH2ET	AM760KX VGGH2ET	AM780KX VGGH2ET
Number of individual outdoor units		4	4	4	4	4	4
Combined outdoor unit	AM080JXVHGH/EU		1				
	AM100JXVHGH/EU						
	AM120JXVHGH/EU						
	AM140JXVHGH/ET	1					
	AM160JXVHGH/ET						
	AM180JXVHGH/ET	3	2	4	3	2	1
	AM200JXVHGH/ET				1	2	3
	AM220JXVHGH/ET						
	AM240KXVGGH/ET						
AM260KXVGGH/ET		1					
Rated capacity	Cooling (kW)	191.2	196	201.6	207.2	212.8	218.4
	Heating (kW)	215.1	220.5	226.8	233.1	239.4	245.7
Total capacity of the connected indoor units (Cooling)	Minimum (kW)	95.6	98	100.8	103.6	106.4	109.2
	Maximum (kW)	248.6	254.8	262.1	269.4	276.6	283.9
Maximum number of connectable indoor units		64	64	64	64	64	64

Model mane of combination		AM800KX VGGH2ET	AM820KX VGGH2ET	AM840KX VGGH2ET	AM860KX VGGH2ET	AM880KX VGGH2ET	AM900KX VGGH2ET
Number of individual outdoor units		4	4	4	4	4	4
Combined outdoor unit	AM080JXVHGH/EU						
	AM100JXVHGH/EU						
	AM120JXVHGH/EU						
	AM140JXVHGH/ET						
	AM160JXVHGH/ET						
	AM180JXVHGH/ET	3	2	1	1	1	1
	AM200JXVHGH/ET		1	2	1	1	1
	AM220JXVHGH/ET				1		
	AM240KXVGGH/ET					1	
AM260KXVGGH/ET	1	1	1	1	1	2	
Rated capacity	Cooling (kW)	224	229.6	235.2	240.8	246.4	252
	Heating (kW)	252	258.3	264.6	270.9	277.2	283.5
Total capacity of the connected indoor units (Cooling)	Minimum (kW)	112	114.8	117.6	120.4	123.2	126
	Maximum (kW)	291.2	298.5	305.8	313.0	320.3	327.6
Maximum number of connectable indoor units		64	64	64	64	64	64

Preparing for installation

Essential type (Heat pump)

Model mane of combination		AM100MX VDGH/ET	AM120MX VDGH/ET	AM140MX VDGH/ET	AM160MX VDGH/ET	AM180MX VDGH/ET	AM200MX VDGH/ET
Number of individual outdoor units		1	1	1	1	1	2
Combined outdoor unit	AM100MXVDGH/ET	1					2
	AM120MXVDGH/ET		1				
	AM140MXVDGH/ET			1			
	AM160MXVDGH/ET				1		
	AM180MXVDGH/ET					1	
Rated capacity	Cooling (kW)	28.0	33.6	40.0	45.0	50.4	56.0
	Heating (kW)	31.5	37.8	45.0	50.4	56.7	63.0
Total capacity of the connected indoor units (Cooling)	Minimum (kW)	14.0	16.8	20.0	22.5	25.2	28.0
	Maximum (kW)	36.4	43.7	52.0	58.5	65.5	72.8
Maximum number of connectable indoor units		18	21	26	29	32	36

Model mane of combination		AM220MX VDGH/ET	AM240MX VDGH/ET	AM260MX VDGH/ET	AM280MX VDGH/ET	AM300MX VDGH/ET	AM320MX VDGH/ET
Number of individual outdoor units		2	2	2	2	2	2
Combined outdoor unit	AM100MXVDGH/ET	1					
	AM120MXVDGH/ET	1	2	1		1	
	AM140MXVDGH/ET			1	2		1
	AM160MXVDGH/ET						
	AM180MXVDGH/ET					1	1
Rated capacity	Cooling (kW)	61.6	67.2	73.6	80.0	84.0	90.4
	Heating (kW)	69.3	75.6	82.8	90.0	94.5	101.7
Total capacity of the connected indoor units (Cooling)	Minimum (kW)	30.8	33.6	36.8	40.0	42.0	45.2
	Maximum (kW)	80.1	87.4	95.7	104.0	109.2	117.5
Maximum number of connectable indoor units		40	43	47	51	54	58

Model mane of combination		AM340MX VDGH/ET	AM360MX VDGH/ET	AM380MX VDGH/ET	AM400MX VDGH/ET
Number of individual outdoor units		2	2	3	3
Combined outdoor unit	AM100MXVDGH/ET				
	AM120MXVDGH/ET			2	1
	AM140MXVDGH/ET			1	2
	AM160MXVDGH/ET	1			
	AM180MXVDGH/ET	1	2		
Rated capacity	Cooling (kW)	95.4	100.8	107.2	113.6
	Heating (kW)	107.1	113.4	120.6	127.8
Total capacity of the connected indoor units (Cooling)	Minimum (kW)	47.7	50.4	53.6	56.8
	Maximum (kW)	124.0	131.0	139.4	147.7
Maximum number of connectable indoor units		61	64	64	64

Premium compact type (Heat recovery)

Model mane of combination		AM080JX VHGR/EU	AM100JX VHGR/EU	AM120JX VHGR/EU	AM140JX VHGR/ET	AM160JX VHGR/ET	AM180JX VHGR/ET
Number of individual outdoor units		1	1	1	1	1	1
Combined outdoor unit	AM080JXVHGR/EU	1					
	AM100JXVHGR/EU		1				
	AM120JXVHGR/EU			1			
	AM140JXVHGR/ET				1		
	AM160JXVHGR/ET					1	
	AM180JXVHGR/ET						1
	AM200JXVHGR/ET						
	AM220JXVHGR/ET						
	AM240MXVGNR/ET						
	AM260MXVGNR/ET						
AM280MXVGNR/ET							
AM300MXVANR/ET							
Rated capacity	Cooling (kW)	22.4	28	33.6	40	45	50.4
	Heating (kW)	25.2	31.5	37.8	45	50.4	56.7
Total capacity of the connected indoor units (Cooling)	Minimum (kW)	11.2	14	16.8	20	22.5	25.2
	Maximum (kW)	29.1	36.4	43.7	52.0	58.5	65.5
Maximum number of connectable indoor units		14	18	21	26	29	32

Model mane of combination		AM200JX VHGR/ET	AM220JX VHGR/ET	AM240MX VGNR/ET	AM260MX VGNR/ET	AM280MX VGNR/ET	AM300MX VANR/ET
Number of individual outdoor units		1	1	1	1	1	1
Combined outdoor unit	AM080JXVHGR/EU						
	AM100JXVHGR/EU						
	AM120JXVHGR/EU						
	AM140JXVHGR/ET						
	AM160JXVHGR/ET						
	AM180JXVHGR/ET						
	AM200JXVHGR/ET	1					
	AM220JXVHGR/ET		1				
	AM240MXVGNR/ET			1			
	AM260MXVGNR/ET				1		
AM280MXVGNR/ET					1		
AM300MXVANR/ET						1	
Rated capacity	Cooling (kW)	56	61.6	67.2	72.8	78.6	84
	Heating (kW)	63	69.3	75.6	81.9	88.2	94.5
Total capacity of the connected indoor units (Cooling)	Minimum (kW)	28	30.8	33.6	36.4	39.3	42
	Maximum (kW)	72.8	80.1	87.4	94.6	102.2	109.2
Maximum number of connectable indoor units		36	40	43	47	51	54

Preparing for installation

Model mane of combination		AM320MX VGNR1ET	AM340MX VGNR1ET	AM360MX VGNR1ET	AM380MX VGNR1ET	AM400MX VGNR1ET	AM420MX VGNR1ET
Number of individual outdoor units		2	2	2	2	2	2
Combined outdoor unit	AM080JXVHGR/EU						
	AM100JXVHGR/EU						
	AM120JXVHGR/EU	1	1				
	AM140JXVHGR/ET			1			
	AM160JXVHGR/ET				1		
	AM180JXVHGR/ET					1	
	AM200JXVHGR/ET	1					1
	AM220JXVHGR/ET		1	1	1	1	1
	AM240MXVGNR/ET						
	AM260MXVGNR/ET						
AM280MXVGNR/ET							
AM300MXVANR/ET							
Rated capacity	Cooling (kW)	89.6	95.2	101.6	106.6	112	117.6
	Heating (kW)	100.8	107.1	114.3	119.7	126	132.3
Total capacity of the connected indoor units (Cooling)	Minimum (kW)	44.8	47.6	50.8	53.3	56	58.8
	Maximum (kW)	116.5	123.8	132.1	138.6	145.6	152.9
Maximum number of connectable indoor units		58	61	64	64	64	64

Model mane of combination		AM440MX VGNR1ET	AM460MX VGNR1ET	AM480MX VGNR1ET	AM500MX VGNR1ET	AM520MX VGNR1ET	AM540MX VGNR1ET
Number of individual outdoor units		2	2	2	2	2	2
Combined outdoor unit	AM080JXVHGR/EU						
	AM100JXVHGR/EU						
	AM120JXVHGR/EU						
	AM140JXVHGR/ET	1					
	AM160JXVHGR/ET		1				
	AM180JXVHGR/ET			1			
	AM200JXVHGR/ET				1		
	AM220JXVHGR/ET					1	
	AM240MXVGNR/ET						1
	AM260MXVGNR/ET						
AM280MXVGNR/ET							
AM300MXVANR/ET	1	1	1	1	1	1	
Rated capacity	Cooling (kW)	124	129	134.4	140	145.6	151.2
	Heating (kW)	139.5	144.9	151.2	157.5	163.8	170.1
Total capacity of the connected indoor units (Cooling)	Minimum (kW)	62	64.5	67.2	70	72.8	75.6
	Maximum (kW)	161.2	167.7	174.7	182.0	189.3	196.6
Maximum number of connectable indoor units		64	64	64	64	64	64

Model mane of combination		AM560MX VGNR1ET	AM580MX VGNR1ET	AM600MX VGNR1ET	AM620MX VGNR1ET	AM640MX VGNR1ET	AM660MX VGNR1ET
Number of individual outdoor units		2	2	2	3	3	3
Combined outdoor unit	AM080JXVHGR/EU						
	AM100JXVHGR/EU						
	AM120JXVHGR/EU				1	1	
	AM140JXVHGR/ET						1
	AM160JXVHGR/ET						
	AM180JXVHGR/ET						
	AM200JXVHGR/ET				1		
	AM220JXVHGR/ET					1	1
	AM240MXVGNR/ET						
	AM260MXVGNR/ET	1					
AM280MXVGNR/ET		1					
AM300MXVANR/ET	1	1	2	1	1	1	
Rated capacity	Cooling (kW)	156.8	162.6	168	173.6	179.2	185.6
	Heating (kW)	176.4	182.7	189	195.3	201.6	208.8
Total capacity of the connected indoor units (Cooling)	Minimum (kW)	78.4	81.3	84	86.8	89.6	92.8
	Maximum (kW)	203.8	211.4	218.4	225.7	233.0	241.3
Maximum number of connectable indoor units		64	64	64	64	64	64

Model mane of combination		AM680MX VGNR1ET	AM700MX VGNR1ET	AM720MX VGNR1ET	AM740MX VGNR1ET	AM760MX VGNR1ET	AM780MX VGNR1ET
Number of individual outdoor units		3	3	3	3	3	3
Combined outdoor unit	AM080JXVHGR/EU						
	AM100JXVHGR/EU						
	AM120JXVHGR/EU						
	AM140JXVHGR/ET						
	AM160JXVHGR/ET	1					
	AM180JXVHGR/ET		1				
	AM200JXVHGR/ET			1			
	AM220JXVHGR/ET	1	1	1	2	1	1
	AM240MXVGNR/ET					1	
	AM260MXVGNR/ET						1
AM280MXVGNR/ET							
AM300MXVANR/ET	1	1	1	1	1	1	
Rated capacity	Cooling (kW)	190.6	196	201.6	207.2	212.8	218.4
	Heating (kW)	214.2	220.5	226.8	233.1	239.4	245.7
Total capacity of the connected indoor units (Cooling)	Minimum (kW)	95.3	98	100.8	103.6	106.4	109.2
	Maximum (kW)	247.8	254.8	262.1	269.4	276.6	283.9
Maximum number of connectable indoor units		64	64	64	64	64	64

Preparing for installation

Model mane of combination		AM800MX VGNR1ET	AM820MX VGNR1ET	AM840MX VGNR1ET	AM860MX VGNR1ET	AM880MX VGNR1ET	AM900MX VGNR1ET
Number of individual outdoor units		3	3	3	3	3	3
Combined outdoor unit	AM080JXVHGR/EU						
	AM100JXVHGR/EU						
	AM120JXVHGR/EU						
	AM140JXVHGR/ET						
	AM160JXVHGR/ET						
	AM180JXVHGR/ET						
	AM200JXVHGR/ET						
	AM220JXVHGR/ET	1	1				
	AM240MXVGNR/ET			1			
	AM260MXVGNR/ET				1		
AM280MXVGNR/ET	1				1		
AM300MXVANR/ET	1	2	2	2	2	3	
Rated capacity	Cooling (kW)	224.2	229.6	235.2	240.8	246.6	252
	Heating (kW)	252	258.3	264.6	270.9	277.2	283.5
Total capacity of the connected indoor units (Cooling)	Minimum (kW)	112.1	114.8	117.6	120.4	123.3	126
	Maximum (kW)	291.5	298.5	305.8	313.0	320.6	327.6
Maximum number of connectable indoor units		64	64	64	64	64	64

Premium energy efficiency type (Heat recovery)

Model mane of combination		AM080JX VHGR/EU	AM100JX VHGR/EU	AM120JX VHGR/EU	AM140JX VHGR/ET	AM160JX VHGR/ET	AM180JX VHGR/ET
Number of individual outdoor units		1	1	1	1	1	1
Combined outdoor unit	AM080JXVHGR/EU	1					
	AM100JXVHGR/EU		1				
	AM120JXVHGR/EU			1			
	AM140JXVHGR/ET				1		
	AM160JXVHGR/ET					1	
	AM180JXVHGR/ET						1
	AM200JXVHGR/ET						
	AM220JXVHGR/ET						
	AM240MXVGNR/ET						
AM260MXVGNR/ET							
Rated capacity	Cooling (kW)	22.4	28	33.6	40	45	50.4
	Heating (kW)	25.2	31.5	37.8	45	50.4	56.7
Total capacity of the connected indoor units (Cooling)	Minimum (kW)	11.2	14	16.8	20	22.5	25.2
	Maximum (kW)	291	36.4	43.7	52.0	58.5	65.5
Maximum number of connectable indoor units		14	18	21	26	29	32

Model mane of combination		AM200JX VHGR/ET	AM220MX VGNR2ET	AM240MX VGNR2ET	AM260MX VGNR2ET	AM280MX VGNR2ET	AM300MX VGNR2ET
Number of individual outdoor units		1	2	2	2	2	2
Combined outdoor unit	AM080JXVHGR/EU				1	1	
	AM100JXVHGR/EU		1				
	AM120JXVHGR/EU		1	2			1
	AM140JXVHGR/ET						
	AM160JXVHGR/ET						
	AM180JXVHGR/ET				1		1
	AM200JXVHGR/ET	1				1	
	AM220JXVHGR/ET						
	AM240MXVGNR/ET						
AM260MXVGNR/ET							
Rated capacity	Cooling (kW)	56	61.6	67.2	72.8	78.4	84
	Heating (kW)	63	69.3	75.6	81.9	88.2	94.5
Total capacity of the connected indoor units (Cooling)	Minimum (kW)	28	30.8	33.6	36.4	39.2	42
	Maximum (kW)	72.8	80.1	87.4	94.6	101.9	109.2
Maximum number of connectable indoor units		36	40	43	47	51	54

Model mane of combination		AM320MX VGNR2ET	AM340MX VGNR2ET	AM360MX VGNR2ET	AM380MX VGNR2ET	AM400MX VGNR2ET	AM420MX VGNR2ET
Number of individual outdoor units		2	3	2	2	3	3
Combined outdoor unit	AM080JXVHGR/EU		2			1	1
	AM100JXVHGR/EU						
	AM120JXVHGR/EU						
	AM140JXVHGR/ET	1				1	1
	AM160JXVHGR/ET						
	AM180JXVHGR/ET	1	1	2	1	1	
	AM200JXVHGR/ET				1		1
	AM220JXVHGR/ET						
	AM240MXVGNR/ET						
AM260MXVGNR/ET							
Rated capacity	Cooling (kW)	90.4	95.2	100.8	106.4	112.8	118.4
	Heating (kW)	101.7	107.1	113.4	119.7	126.9	133.2
Total capacity of the connected indoor units (Cooling)	Minimum (kW)	45.2	47.6	50.4	53.2	56.4	59.2
	Maximum (kW)	117.5	123.8	131.0	138.3	146.6	153.9
Maximum number of connectable indoor units		58	61	64	64	64	64

Preparing for installation

Model mane of combination		AM440MX VGNR2ET	AM460MX VGNR2ET	AM480MX VGNR2ET	AM500MX VGNR2ET	AM520MX VGNR2ET	AM540MX VGNR2ET
Number of individual outdoor units		3	3	3	3	3	3
Combined outdoor unit	AM080JXVHGR/EU	1	1	1		1	1
	AM100JXVHGR/EU						
	AM120JXVHGR/EU						
	AM140JXVHGR/ET				1		
	AM160JXVHGR/ET						
	AM180JXVHGR/ET	2	1		2	1	
	AM200JXVHGR/ET		1	2			1
	AM220JXVHGR/ET						
	AM240MXVGNR/ET						
AM260MXVGNR/ET					1	1	
Rated capacity	Cooling (kW)	123.2	128.8	134.4	140.8	145.6	151.2
	Heating (kW)	138.6	144.9	151.2	158.4	163.8	170.1
Total capacity of the connected indoor units (Cooling)	Minimum (kW)	61.6	64.4	67.2	70.4	72.8	75.6
	Maximum (kW)	160.2	167.4	174.7	183.0	189.3	196.6
Maximum number of connectable indoor units		64	64	64	64	64	64

Model mane of combination		AM560MX VGNR2ET	AM580MX VGNR2ET	AM600MX VGNR2ET	AM620MX VGNR2ET	AM640MX VGNR2ET	AM660MX VGNR2ET
Number of individual outdoor units		3	3	3	4	4	4
Combined outdoor unit	AM080JXVHGR/EU		1		1	1	
	AM100JXVHGR/EU						
	AM120JXVHGR/EU	1					1
	AM140JXVHGR/ET						
	AM160JXVHGR/ET						
	AM180JXVHGR/ET	1		2	3	2	3
	AM200JXVHGR/ET					1	
	AM220JXVHGR/ET						
	AM240MXVGNR/ET		1	1			
AM260MXVGNR/ET	1	1					
Rated capacity	Cooling (kW)	156.8	162.4	168	173.6	179.2	184.8
	Heating (kW)	176.4	182.7	189	195.3	201.6	207.9
Total capacity of the connected indoor units (Cooling)	Minimum (kW)	78.4	81.2	84	86.8	89.6	92.4
	Maximum (kW)	203.8	211.1	218.4	225.7	233.0	240.2
Maximum number of connectable indoor units		64	64	64	64	64	64

Model mane of combination		AM680MX VGNR2ET	AM700MX VGNR2ET	AM720MX VGNR2ET	AM740MX VGNR2ET	AM760MX VGNR2ET	AM780MX VGNR2ET
Number of individual outdoor units		4	4	4	4	4	4
Combined outdoor unit	AM080JXVHGR/EU		1				
	AM100JXVHGR/EU						
	AM120JXVHGR/EU						
	AM140JXVHGR/ET	1					
	AM160JXVHGR/ET						
	AM180JXVHGR/ET	3	2	4	3	2	1
	AM200JXVHGR/ET				1	2	3
	AM220JXVHGR/ET						
	AM240MXVGNR/ET						
AM260MXVGNR/ET		1					
Rated capacity	Cooling (kW)	191.2	196	201.6	207.2	212.8	218.4
	Heating (kW)	215.1	220.5	226.8	233.1	239.4	245.7
Total capacity of the connected indoor units (Cooling)	Minimum (kW)	95.6	98	100.8	103.6	106.4	109.2
	Maximum (kW)	248.6	254.8	262.1	269.4	276.6	283.9
Maximum number of connectable indoor units		64	64	64	64	64	64

Model mane of combination		AM800MX VGNR2ET	AM820MX VGNR2ET	AM840MX VGNR2ET	AM860MX VGNR2ET	AM880MX VGNR2ET	AM900MX VGNR2ET
Number of individual outdoor units		4	4	4	4	4	4
Combined outdoor unit	AM080JXVHGR/EU						
	AM100JXVHGR/EU						
	AM120JXVHGR/EU						
	AM140JXVHGR/ET						
	AM160JXVHGR/ET						
	AM180JXVHGR/ET	3	2	1	1	1	1
	AM200JXVHGR/ET		1	2	1	1	1
	AM220JXVHGR/ET				1		
	AM240MXVGNR/ET					1	
AM260MXVGNR/ET	1	1	1	1	1	2	
Rated capacity	Cooling (kW)	224	229.6	235.2	240.8	246.4	252
	Heating (kW)	252	258.3	264.6	270.9	277.2	283.5
Total capacity of the connected indoor units (Cooling)	Minimum (kW)	112	114.8	117.6	120.4	123.2	126
	Maximum (kW)	291.2	298.5	305.8	313.0	320.3	327.6
Maximum number of connectable indoor units		64	64	64	64	64	64

Preparing for installation

Moving the outdoor unit

- ▶ Select the moving path in advance.
- ▶ Be sure that moving path can support weight of the outdoor unit.
- ▶ Do not slant the product more than 30° when carrying it. (Do not lay the product down in sideways.)
- ▶ Surface of the heat exchanger is sharp. Be careful not to get injured while moving the product.



- You must use certain part of the product when moving the product.

When moving with a crane

- ▶ Fasten the wire rope as shown in the figure.
- ▶ To protect damage or scratches, insert a piece of cloth between the outdoor unit and the wire rope.

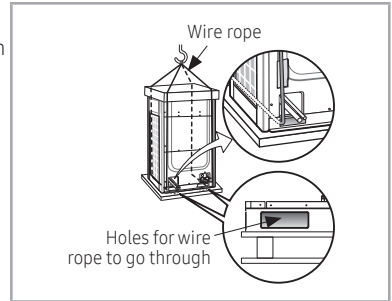

When moving with a forklift

- ▶ Carefully insert the forklift forks into the forklift holes at the bottom of the outdoor unit.
- ▶ Be careful with the forklift from damaging the product.

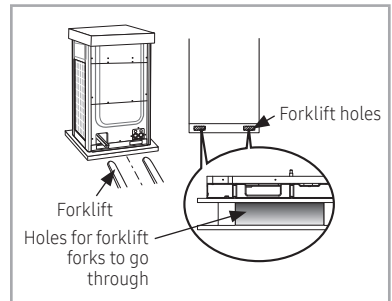

When moving the product without wooden pallet and the crane is not available for use

- ▶ Connect a wire rope to the outdoor unit as you would move it with a crane.
- ▶ Hang the wire rope to the forklift fork to move the outdoor unit.

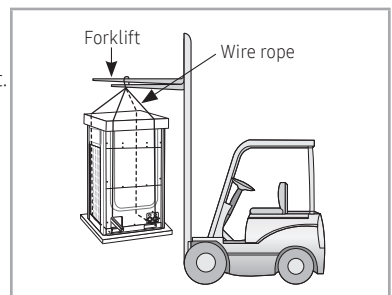

Selecting installation location

Decide the installation location, with the consideration of the following conditions, under user's approval.

- ▶ Place where hot discharge air or noise from the outdoor unit may not disturb the neighbor (Especially in residential areas, keep the operation hours in mind.)
- ▶ Place where structure can bear the weight and vibration of the outdoor unit.
- ▶ Place with flat surface where rainwater does not settle or leak.
- ▶ Place where it is not exposed to strong wind.
- ▶ Well ventilated place with sufficient service place for repairs and maintenance. (Discharge duct can be purchased separately)
- ▶ Place where you can connect the refrigerant pipes between indoor and outdoor units within allowable distance.
- ▶ Place where it allows easy waterproofing and draining work for the condensation water generated from the outdoor unit during heating operation.
- ▶ Place where there is no risk of inflammable gas leakage.
- ▶ Place where there is no direct influence of snow or rain.

Selecting installation location

Installation Guide at the seashore

Make sure to follow below guides when installing at the seashore.

1. Do not install the product in a place where it is directly exposed to sea water and sea breeze.
 - Make sure to install the product behind a structure (such as building) that can block sea breeze.
 - Even when it is inevitable to install the product in seashore, make sure that product is not directly exposed to sea breeze by installing a protection wall.
2. Consider that the salinity particles clinging to the external panels should be sufficiently washed out.
3. Because the residual water at the bottom of the outdoor unit significantly promotes corrosion, make sure that the slope does not disturb drainage.
 - Keep the floor level so that rain does not accumulate.
 - Be careful not to block the drain hole due to foreign substance
4. When product is installed in seashore, periodically clean it with water to remove attached salinity.
5. Make sure to install the product in a place that provides smooth water drainage. Especially, ensure that the base part has good drainage.
6. If the product is damaged during the installation or maintenance, make sure to repair it.
7. Check the condition of the product periodically.
 - Check the installation site every 3 months and perform anti-corrosion treatment such as R-Pro supplied by SAMSUNG (Code : MOK-220SA) or commercial water repellent grease and wax, etc., based on the product condition.
 - When the product is to be shut down for a long period of time, such as off-peak hours, take appropriate measures like covering the product.
8. If the product installed within 500m of seashore, special anti-corrosion treatment is required.
 - ※ Please contact your local SAMSUNG representative for further details.

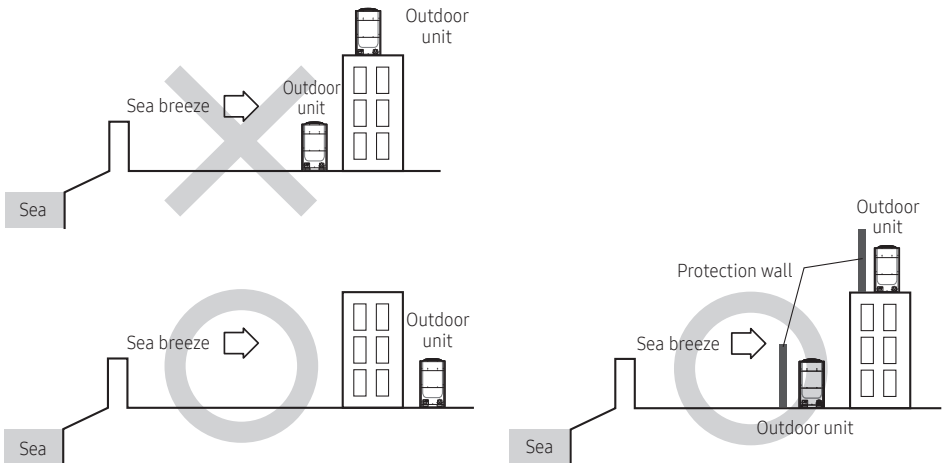

Protection wall should be constructed with a solid material that can block the sea breeze and the height and width of the wall should be 1.5 times larger than the size of the outdoor unit. (You must secure more than 700mm of space between the protection wall and the outdoor unit for air circulation.)

Space requirement for installation



- System air conditioner may cause static noise when listening to AM stations. Therefore, select an installation location for indoor unit where electrical wiring can be done while keeping certain distance from a radio, computer and stereo equipment.
 - Especially, keep the unit at least 3m away from the electrical equipment in an area with weak electromagnetic waves and put the main power cable and communication cables in a separately installed protection tube.
 - Make sure that there is no equipment that generates electromagnetic waves. If not electromagnetic waves may cause problem to the control systems which may lead to air conditioner malfunction. (Example: Remote control sensor of the indoor unit may not receive the signal very well, due to ballast stabilizer of the lighting equipment.)
- In regions with heavy snowfall, make sure to install the outdoor unit where there is no concerns of direct snowfall on the outdoor unit. Also, build higher base support so that accumulated snow does not block the air inlet or the heat exchanger.
- R-410A refrigerant is a safe, nontoxic and nonflammable refrigerant. However, if the place holds any concerns for exceeding dangerous level of refrigerant concentration in case of refrigerant leakage, extra ventilation system is required.
- When you install the outdoor unit in high places such as roof, install fence or guardrail around it. When there is no fence or guardrail, service person could fall.
- Do not install the product in places where corrosive gases such as sulfur oxides, ammonia, and sulfurous gas are produced. (e.g. Toilet outlet, ventilation opening, sewage works, dyeing complex, cattle shed, sulfuric hot spring, nuclear power plant, ship etc.) When installing the product in those places, contact an installation specialty store as the copper pipe and brazing part will need additional corrosion proof or anti-rust additive to prevent corrosion.
- Make sure to keep any inflammable materials (such as wooden materials, oil etc.) around the outdoor unit. When there's fire, those inflammable material will easily catch the fire and may pass it on to the product.
- Depending on the condition of power supply, unstable power or voltage any cause malfunction of the parts or control system. (At the ship or places using power supply from electric generator...etc)
- Make sure to install MCU when using HR products.
- When you select the location to install MCU, the location is far away from indoor rooms because the refrigerant running of MCU may create noise.

- ▶ Space requirement was decided based on following conditions; Cooling mode, outdoor temperature of 35 °C. Larger space is required if the outdoor temperature is higher than 35 °C or if the place is heated easily by quantity of solar radiation.
- ▶ When you secure installation space, consider path for people and the direction of the wind.
- ▶ Secure installation space as shown in the below illustration, considering ventilation and the service space.
- ▶ If the installation space is narrow, installer or other worker may get injured during work and may also cause problem to the product.
- ▶ If you install multiple number of outdoor units in one space, make sure to secure enough ventilation space if there's any walls around the product that may disturb the air flow. If enough ventilation space is not secured, product may malfunction.
- ▶ You may install the outdoor units with 20mm of space between the product, but product's performance may decrease depending on the installation environment.

Space requirement for installation

Single installation

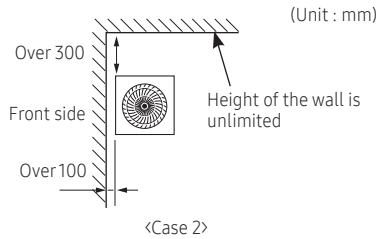
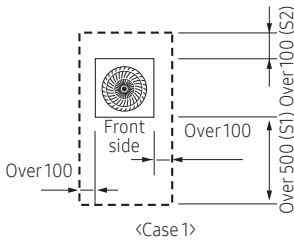

Module installation

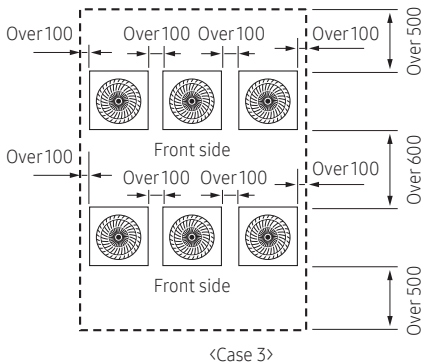
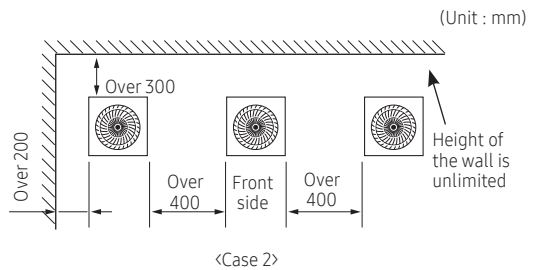
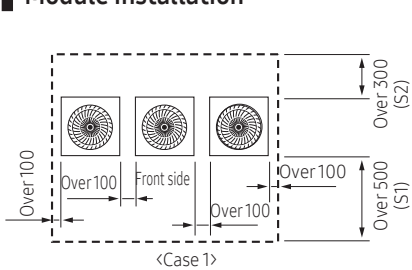

※ For <Case 1> or <Case 3>

- Height of the wall on the front side should not be higher than 1500mm.
- Height of the wall on the air inlet side should not be higher than 500mm.
- Height of the wall on the side is not limited.
- If the height of the wall exceeds by certain value (h_1 , h_2), additional clearance $[(h_1)/2, (h_2)/2$: Half of the exceeded distance] should be added to the service space (S_1 , S_2).

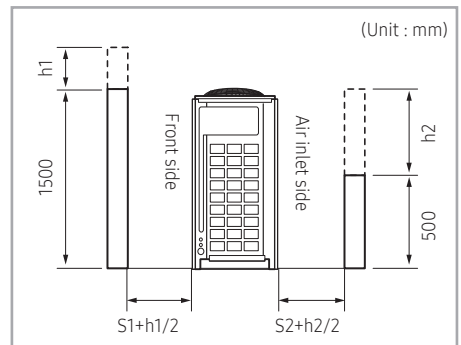

Accessories

Accessories

- ▶ You must keep following accessories until the installation is finished.
- ▶ Hand over the installation manual to the customer after finishing the installation.

Installation manual (1)



Optional accessories

- ▶ Following optional accessories are needed for connecting pipes between the indoor and outdoor units.

Classification	Model Name	Specification
Y-Joint	MXJ-YA1509M	15.0 kW and below
	MXJ-YA2512M	15.1 kW ~ 40.0 kW
	MXJ-YA2812M	40.1 kW ~ 45.0 kW
	MXJ-YA2815M	45.1 kW ~ 70.3 kW
	MXJ-YA3419M	70.4 kW ~ 98.4 kW
	MXJ-YA4119M	98.5 kW ~ 135.2 kW
	MXJ-YA4422M	Over 135.2 kW
Y-Joint (Only H/R)	MXJ-YA1500M	22.4 kW and below
	MXJ-YA2500M	22.5 kW ~ 70.3 kW
	MXJ-YA3100M	70.4 kW ~ 135.2 kW
	MXJ-YA3800M	Over 135.2 kW
Distribution header	MXJ-HA2512M	45.0 kW and below (for 4 rooms)
	MXJ-HA3115M	70.3 kW and below (for 8 rooms)
	MXJ-HA3819M	70.4 kW ~ 135.2 kW (for 8 rooms)
Y-Joint - Outdoor unit	MXJ-TA3419M	135.2 kW and below
	MXJ-TA4122M	Over 135.2 kW
Y-Joint (Only H/R) - Outdoor unit	MXJ-TA3100M	135.2 kW and below
	MXJ-TA3800M	Over 135.2 kW

- ※ If you use an indoor unit with no internal EEV(Electric Expansion Valve), you will need an EEV kit.
- ※ Only use the genuine accessories listed in above table and do not use imitated accessories.

Base construction and installation of the outdoor unit



- Make sure to remove the wooden pallet before installing the outdoor unit. If you do not remove the wooden pallet, there is risk of fire during welding the pipes. If the outdoor unit is installed with wooden pallet on, and it was used for long period time, wooden palette may break and cause electrical hazard or high pressure may damage the pipes.

- ※ Fix an outdoor unit firmly on the base ground with anchor bolts.
 - ※ Manufacturer is not responsible for the damage occurred by not following the installation standards.
1. Make sure that the height of the base ground is 200mm or higher to protect the outdoor unit from rain water or other external conditions. Also, install a draining pit around the base ground and connect the drain pipe to the drainage.
 2. Considering the vibration and weight of the outdoor unit, strength of the base ground must be strong to prevent noise and the top surface of it should be flat.
 3. Base ground should be 1.5 times larger than the bottom of the outdoor unit.
 4. Outdoor unit must be fixed firmly so that it can withstand the wind speed of 30m/s. If you cannot fix the outdoor unit on the base ground, fix it by side or use extra structure.
 5. In heating operation, defrost water may form so you must really care about the drainage and waterproofing the floor. To prevent defrost water from stagnating or freezing, construct a drainage with over 1/50 slope. (Ice may form on the floor in winter season.)
 6. It is necessary to add wire mesh or steel bar during concrete construction for the base ground to prevent damages or cracks.
 7. When installing multiple outdoor units at the same place, construct an H beam or an anti-vibration frame on the base ground to install the outdoor unit.
 8. After installing an H beam or an anti-vibration frame, apply corrosion protection and other necessary coating.
 9. When concrete construction for outdoor unit installation is completed, install an anti-vibration pad (t=20mm or more) or an anti-vibration frame to prevent vibration of the outdoor unit from transferring to the base ground.
 10. Place the outdoor unit on an H beam or an anti-vibration frame and fix it with the bolt, nut and washer. (The bearing force has to be over 3.5kN)

Base ground construction

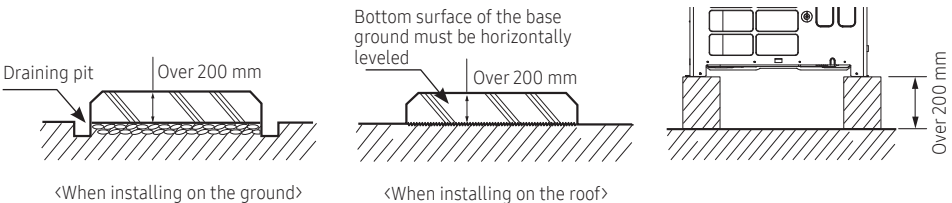

Outdoor unit installation

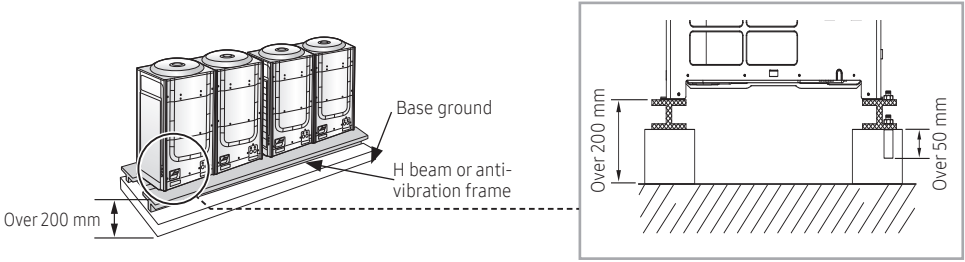

Outdoor unit base mount and anchor bolt position

(Unit : mm)

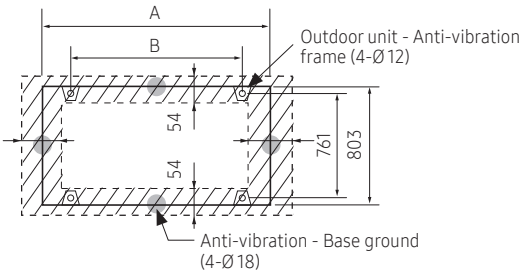

(Unit : mm)

Classification	DVM S Small Type	DVM S Large A Type	DVM S Large B type
A	880	1,295	1,295
B	740	1,150	1,150

※ Refer to the blueprints in technical data book to make a holes for connecting the anti-vibration pad.

Base construction and installation of the outdoor unit

Examples of draining work

- ▶ Construct the drainage ditch with reinforced concretes and make sure that water-proofing work is done.
- ▶ For smooth draining of defrost water, make sure to apply 1/50 slope.
- ▶ Construct a drainage around the outdoor unit to prevent the defrost water (from the outdoor unit) from stagnating, overflowing or freezing near the installation space.
- ▶ When the outdoor unit is installed on the roof, check the strength and waterproof status of the roof.

(Unit : mm)

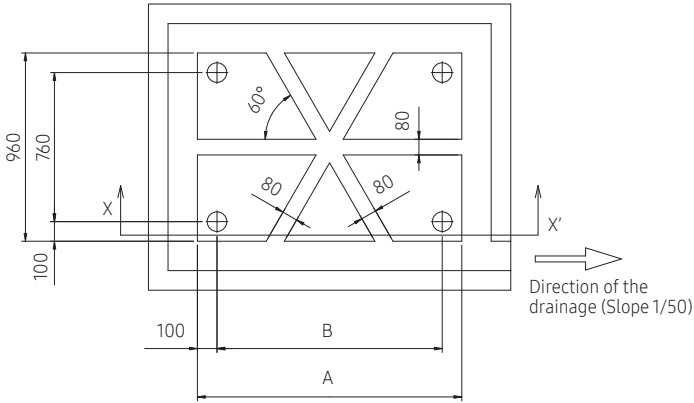

<Drainage work for single installation>

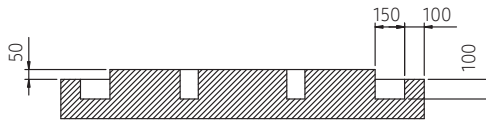

<X-X' SECTION>

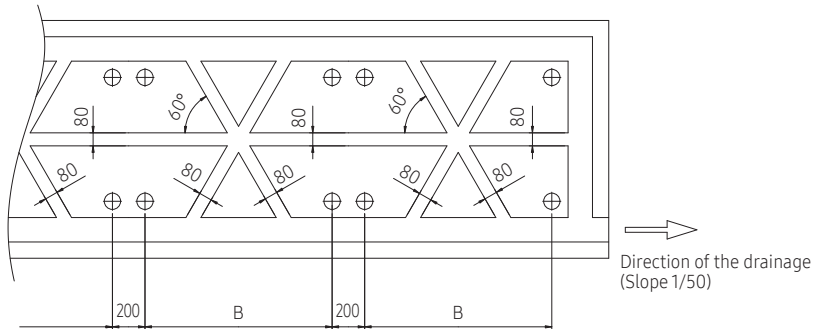

<Drainage work for module installation>

(Unit : mm)

Classification	DVMS Small Type	DVMS Large A Type	DVMS Large B type
A	940	1,350	1,350
B	740	1,150	1,150



Cautions regarding on connecting the anchor bolt

- ▶ Tighten the rubber washer to prevent the bolt connection part of the outdoor unit from corroding.

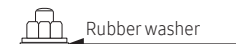

Rubber washer

- ▶ Anchor specification

Size	Diameter of drill bit (a)	Anchor length (b)	Sleeve length (c)	Insert depth	Fastening torque
Ø10	14 mm	75 mm	40 mm	50 mm	30 N·m

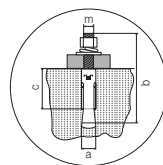

- ※ Use the anchor bolts and nuts that is zinc plated or made of STS material. Regular anchor bolts or nuts may get damaged by corrosion.

Cautions regarding on connecting the pipe

- ▶ If you install the outdoor unit on the rooftop, check the strength and make sure to waterproof the rooftop.
- ▶ Construct draining pit around the base construction and pay attention to the drainage around the outdoor unit. (Condensation or defrost water may form during outdoor unit operation.)
- ▶ If there's any possibility of small animals from entering the pipe outlet, block the outlet as shown in the illustration.

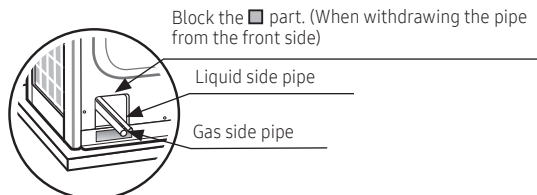

Cautions regarding on anti-vibration frame installation

- ▶ During installation, make sure there is no gap between the base ground and the supporting structures such as anti-vibration frame or H beam.
- ▶ Base ground must be constructed strongly to support the bottom part of the anti-vibration mount.

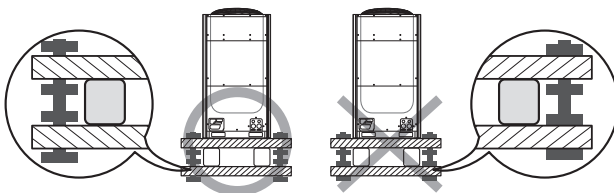

- ▶ After installing the anti-vibration frame, untighten the fixing part on the top and bottom part of the frame.

Base construction and installation of the outdoor unit



Caution for installing discharge duct

- ▶ Static pressure of the discharge duct should be within the standard specification (78.45 Pa) when installing the duct.
- ▶ If you remove the fan guard to install the discharge duct, make sure to install a safety net on the duct outlet. Foreign substance may enter into the product and there could be a risk of personal injury.
- ▶ Wear protection equipment at all times when making galvanized sheet metal duct, since the worker may get injured by the sharp parts.
- ▶ When installing the outdoor unit under the tree or near forest, leaves may get into the product and cause problems on the product. Therefore, install a discharge duct to prevent foreign substance infiltration.

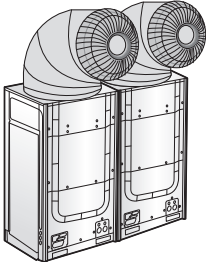

<Preventing foreign substance infiltration>

Installing the wind/snow prevention duct

Installing the outdoor unit around the obstacles

- ▶ It is necessary to install a discharge guide duct(field supply) to direct exhaust from the fan horizontally, when it is difficult to provide a minimum space of 2m between the air outlet and a nearby obstacle.

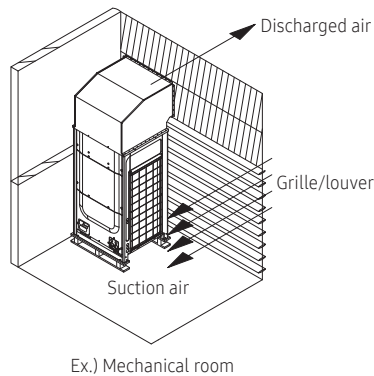
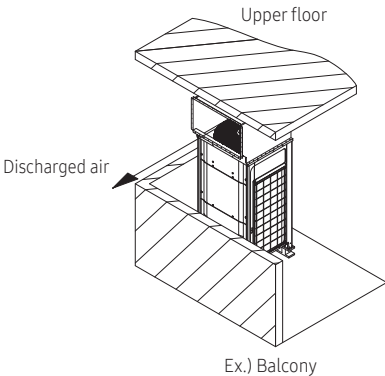

Installing the outdoor unit in cold region

- ▶ In cold regions with lots of snowfall, install a snow prevention duct, as a sufficient countermeasure, to prevent snow from accumulating on the outdoor unit. When the snow prevention duct is not installed, frost may accumulate on the heat exchanger and heating operation may not work normally.
- ▶ Air outlet of the duct should not be directed to the enclosed space.

Installing the wind/snow prevention duct



Caution regarding on installing the frame and selecting the base ground

- Height (h) of the frame and the base ground should be higher than the "heaviest expected snowfall".
- Area of the frame and the base ground should not be larger than the are of the outdoor unit. Snow may accumulate if the area of the frame or the base ground is larger.

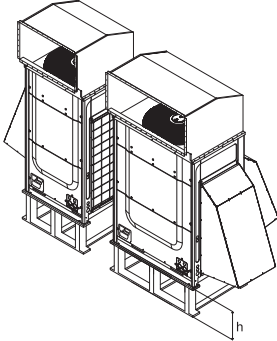

- Should adopt bar type louver. Don't use a type of rain resistance louver.

[Bar type louver]

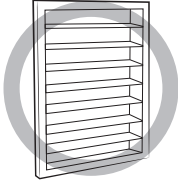

[Rain resistance louver]

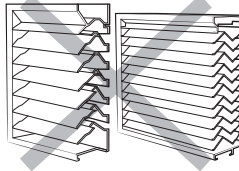

- Louver specifications.
 - Angle criteria : less than 20°
 - Opening ratio criteria : greater than 80%

Installing the wind/snow prevention duct

Installing the outdoor unit in windy region

- ▶ In windy regions such as near sea shores, protection wall or wind protection duct must be installed for normal operation of the outdoor unit. (Refer to the illustration of the snow prevention duct, for installing the wind protection duct.)
- ▶ Install the wind prevention duct with the consideration of major wind direction. If the direction of the discharge part is same as major direction of the wind, it could cause product's performance decrease.



Cautions regarding on installing the frame and selecting the base ground

- The base ground must be solid and the outdoor unit must be fixed with anchor bolts.
- Make sure to install outdoor unit in a place strong enough to withstand its weight. If the place cannot withstand the weight of the outdoor unit, outdoor unit may fall and cause personal injury.
- When installing on a rooftop subject to strong wind, countermeasures must be taken to prevent the unit from falling down.
- Use a frame that is resistant to corrosion.

(Unit : mm)

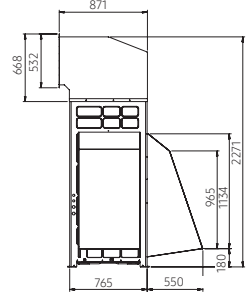
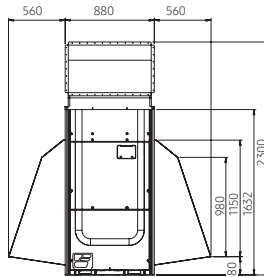
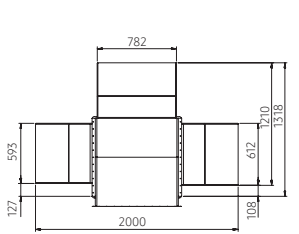

DVM S Small Type

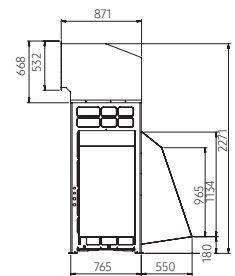
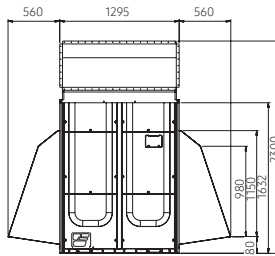
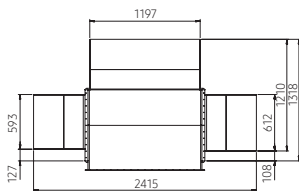

DVM S Large A Type

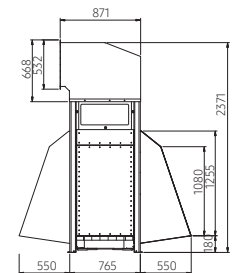
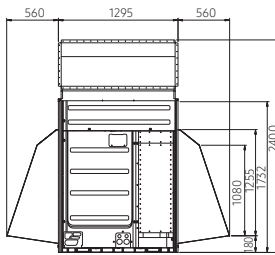
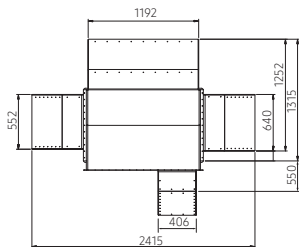

DVM S Large B Type

Refrigerant pipe installation



- When installing, make sure there is no leakage. When collecting the refrigerant, stop the compressor first before removing the connection pipe. If the refrigerant pipe is not properly connected and the compressor works with the service valve open, the pipe inhales the air and it makes the pressure inside of the refrigerant cycle abnormally high which may lead to explosion and injury.

Refrigerant pipe work

- The length of refrigerant pipe should be as short as possible and the height difference between an indoor and outdoor unit should be minimized.
- Piping work must be done within allowable piping length, height difference, and the allowable length after branching.
- The pressure of the R-410A is high. Use only certified refrigerant pipe and follow the installation method.
- After installing the pipes, calculate the total length of the pipe to check if additional refrigerant is needed. When you need to charge the additional refrigerant, make sure to use R-410A refrigerant.
- Use clean refrigerant pipe and there shouldn't be any harmful ion, oxide, dust, iron content or moisture inside pipe.
- Use tools and accessories that fit on R-410A only.

Tool	Installation process/purpose		Compatibility with conventional tool
Pipe cutter	Refrigerant pipe installation	Pipe cutting	Compatible
Flaring tool		Pipe flaring	
Refrigerant machine oil		Apply refrigerant oil on flared part	Exclusive ether oil, ester oil, alkali benzene oil or synthetic oil
Torque wrench		Connect flare nut with pipe	Compatible
Pipe bender		Pipe bending	
Nitrogen gas	Prevent oxidation within the pipe		
Welder	Air tightness test	Pipe welding	
Manifold gage	Air tightness test ~ additional refrigerant charging	Vacuuming, charging refrigerant and checking operation	Need exclusive one to prevent mixture of R-22 refrigerant oil use and also the measurement is not available due to high pressure
Refrigerant charging hose			Need exclusive one since there is risk of refrigerant leakage or inflow of impurities
Vacuum pump	Pipe drying		Compatible (Use products which contain the check valve to prevent the oil from flowing backward into the outdoor unit.) Use the one that can be vacuumed up to -100.7kpa(5Torr).
Scale for refrigerant charging	Refrigerant charging		Compatible
Gas leak detector	Gas leak test		Need exclusive one (Ones used for R-134a is compatible)
Flare nut	Must use the flare nut equipped with the product. Refrigerant leakage may occur when the conventional flare nut for R-22 is used.		

Refrigerant pipe installation

Selecting refrigerant pipe

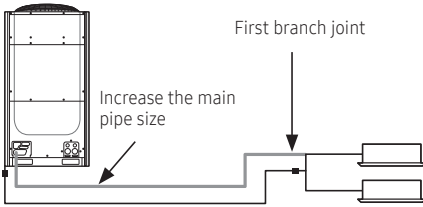

- ▶ Install the refrigerant pipe according to main pipe size of each outdoor unit capacity.
- ▶ When the pipe length (including elbow) between an outdoor unit and the farthest indoor unit exceeds 90m, you must increase the size of the pipe (main pipe) by one grade which connects between the outdoor unit to the first branch joint.
- ▶ For H/R model, When the pipe length (including elbow) between an outdoor unit and the farthest indoor unit exceeds 90m, you must increase the size of the liquid pipe by one grade among the pipes(main pipe) which connects between the outdoor unit to the first branch joint.

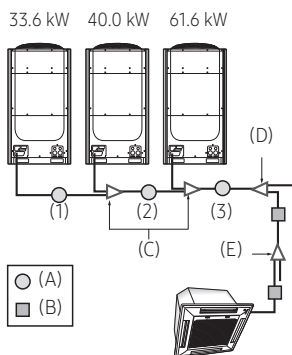

Ex.) 135.2 kW

Capacity (kW)	No.	Pipe size (mm)	
		Liquid pipe	Gas pipe
33.6 kW	(1)	Ø 12.70	Ø 28.58
73.6 kW	(2)	Ø 19.05	Ø 34.92
135.2 kW	(3)	Ø 19.05	Ø 41.28

Size of the pipe connected to the outdoor unit (A)

Select the size of the main pipe according to the below table.

Outdoor unit capacity (kW) (Cooling)	*Maximum pipe length within 90m		*Maximum pipe length over 90m	
	Liquid pipe (mm)	gas pipe (mm)	Liquid pipe (mm)	gas pipe (mm)
22.4 kW	Ø 9.52	Ø 19.05	Ø 12.70	Ø 22.22
22.5 kW ~ 28.1 kW		Ø 22.22		Ø 25.40 ^{note1)}
28.2 kW ~ 33.6 kW	Ø 12.70	Ø 28.58	Ø 15.88	Ø 28.58
33.7 kW ~ 40.0 kW				Ø 31.75 ^{note2)}
40.1 kW ~ 45.0 kW				
45.1 kW ~ 50.4 kW	Ø 15.88	Ø 34.92	Ø 19.05	Ø 31.75 ^{note2)}
50.5 kW ~ 56.0 kW				Ø 38.10 ^{note3)}
56.1 kW ~ 63.3 kW				
63.4 kW ~ 70.3 kW	Ø 19.05	Ø 41.28	Ø 22.22	Ø 38.10 ^{note3)}
70.4 kW ~ 78.4 kW				Ø 41.28
78.5 kW ~ 88.4 kW	Ø 22.22	Ø 53.98	Ø 25.40 ^{note1)}	Ø 41.28
88.5 kW ~ 98.4 kW				Ø 53.98
98.5 kW ~ 135.2 kW	Ø 22.22	Ø 53.98	Ø 25.40 ^{note1)}	Ø 53.98
135.3 kW ~ 169.0 kW	Ø 22.22	Ø 53.98	Ø 25.40 ^{note1)}	Ø 53.98
169.1 kW ~ 252.0 kW	Ø 22.22	Ø 53.98	Ø 25.40 ^{note1)}	Ø 53.98

*Maximum pipe length : The pipe length between an outdoor unit and the farthest indoor unit.

Note1) If Ø 25.40 pipe is not available on site, use Ø 28.58 pipe.

Note2) If Ø 31.75 pipe is not available on site, use Ø 34.92 pipe.

Note3) If Ø 38.10 pipe is not available on site, use Ø 41.28 pipe

※ For the case that the diameter of the default pipe of an outdoor unit does not match that of the pipe installed on the site, a socket is provided by default together with the outdoor unit.

Refrigerant pipe installation

Size of the pipe between branch joints (B)

Select the pipe size according to the sum of indoor unit capacity which will be connected after the branch.

※ However, if the size of the pipe between branch joints (B) is bigger than the size of the pipe connected to the outdoor unit (A), apply the pipe size (A).

Indoor unit capacity (kW)	Branch pipe length within 45m		Branch pipe length between 45~90m	
	Liquid pipe (mm)	Gas pipe (mm)	Liquid pipe (mm)	Gas pipe (mm)
15.0 kW and below	Ø 9.52	Ø 15.88	Ø 12.70	Ø 19.05
15.1 kW ~ 22.4 kW		Ø 19.05		Ø 22.22
22.5 kW ~ 28.1 kW		Ø 22.22		Ø 25.40 ^{note1)}
28.2 kW ~ 40.0 kW	Ø 12.70	Ø 28.58	Ø 15.88	Ø 28.58
40.1 kW ~ 45.0 kW				Ø 31.75 ^{note2)}
45.1 kW ~ 63.3 kW	Ø 15.88	Ø 34.92	Ø 19.05	Ø 38.10 ^{note3)}
63.4 kW ~ 70.3 kW				Ø 41.28
70.4 kW ~ 98.4 kW	Ø 19.05	Ø 41.28	Ø 22.22	Ø 41.28
98.5 kW ~ 135.2 kW				Ø 53.98
135.3 kW ~ 169.0 kW	Ø 22.22	Ø 53.98	Ø 25.40 ^{note1)}	Ø 53.98
Over 169.0 kW				

Note1) If Ø 25.40 pipe is not available on site, use Ø 28.58 pipe.

Note2) If Ø 31.75 pipe is not available on site, use Ø 34.92 pipe.

Note3) If Ø 38.10 pipe is not available on site, use Ø 41.28 pipe

Size of the pipe between the branch joint and the indoor unit

Make a selection according to outdoor unit capacity.

Indoor unit capacity (kW)	Pipe size (O.D. mm)	
	Liquid pipe	Gas pipe
6.0 kW and below	Ø 6.35	Ø 12.70
6.1 kW ~ 16.0 kW	Ø 9.52	Ø 15.88
16.1 kW ~ 23.0 kW	Ø 9.52	Ø 19.05
Over 23.0 kW	Ø 9.52	Ø 22.22

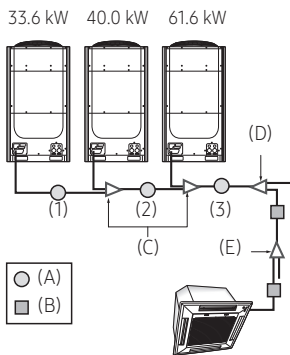

Branch joint

- ▶ Branch joint between outdoor units (C)

Classification	Model name	Specification (kW)
Y-joint for outdoor unit (C)	MXJ-TA3419M	135.2 kW and below
	MXJ-TA4122M	Over 135.2 kW

- ▶ First branch joint (D)
Make a selection according to outdoor unit capacity.

Classification	Outdoor unit capacity (kW)	Model name of the branch joint
Y-joint (D)	40.0 kW and below	MXJ-YA2512M
	40.1 kW ~ 45.0 kW	MXJ-YA2812M
	45.1 kW ~ 67.2 kW	MXJ-YA2815M
	67.3 kW ~ 95.2 kW	MXJ-YA3419M
	95.3 kW ~ 135.2 kW	MXJ-YA4119M
	Over 135.2 kW	MXJ-YA4422M

- ▶ Branch joint (E)

Select a branch joint according to the sum of indoor unit capacity which will be connected after the branch.

- ※ However, if the size of the pipe between branch joints (E) is bigger than the size of the pipe connected to the outdoor unit (D), apply the pipe size (D).

- 1) Y-joint

Classification	Model name	Specification (kW)
Y-joint (E)	MXJ-YA1509M	15.0 kW and below
	MXJ-YA2512M	15.1 kW ~ 40.0 kW
	MXJ-YA2812M	40.1 kW ~ 45.0 kW
	MXJ-YA2815M	45.1 kW ~ 70.3 kW
	MXJ-YA3419M	70.4 kW ~ 98.4 kW
	MXJ-YA4119M	98.5 kW ~ 135.2 kW
	MXJ-YA4422M	Over 135.2 kW

- 2) Distribution header

Classification	Model name	Specification (kW)
Distribution header (E)	MXJ-HA2512M	45.0 kW and below (for 4 rooms)
	MXJ-HA3115M	70.3 kW and below (for 8 rooms)
	MXJ-HA3819M	70.4 kW ~ 135.2 kW

Refrigerant pipe installation

H/R

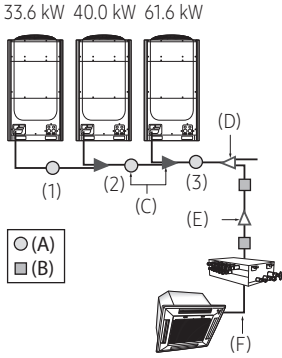

Ex.) 135.2 kW

Capacity (kW)	No.	Pipe size (mm)		
		Liquid pipe	Low pressure gas pipe	High pressure gas pipe
33.6 kW	(1)	Ø 12.70	Ø 28.58	Ø 19.05
73.6 kW	(2)	Ø 19.05	Ø 34.92	Ø 28.58
135.2 kW	(3)	Ø 19.05	Ø 41.28	Ø 34.92

Size of the pipe connected to the outdoor unit (A)

Select the size of the pipe according to the below table.

Outdoor unit capacity (kW) (Cooling)	*Maximum pipe length within 90m			*Maximum pipe length over 90m		
	Liquid pipe (mm)	Low pressure gas pipe (mm)	High pressure gas pipe (mm)	Liquid pipe (mm)	Low pressure gas pipe (mm)	High pressure gas pipe (mm)
22.4 kW	Ø 9.52	Ø 19.05	Ø 15.88	Ø 12.70	Ø 19.05	Ø 15.88
22.5 kW ~ 28.1 kW		Ø 22.22	Ø 19.05		Ø 22.22	Ø 19.05
28.2 kW ~ 33.6 kW	Ø 12.70	Ø 28.58		Ø 22.22	Ø 15.88	
33.7 kW ~ 40.0 kW			Ø 15.88			Ø 28.58
40.1 kW ~ 45.0 kW	Ø 19.05	Ø 28.58		Ø 28.58	Ø 34.92	
45.1 kW ~ 50.4 kW			Ø 15.88			Ø 28.58
50.5 kW ~ 56.0 kW	Ø 19.05	Ø 34.92		Ø 22.22	Ø 41.28	
56.1 kW ~ 63.3 kW			Ø 15.88			Ø 34.92
63.4 kW ~ 70.3 kW	Ø 19.05	Ø 41.28		Ø 34.92	Ø 22.22	
70.4 kW ~ 98.4 kW			Ø 22.22			Ø 53.98
98.5 kW ~ 135.2 kW	Ø 19.05	Ø 41.28		Ø 34.92	Ø 22.22	
135.3 kW ~ 169.0 kW			Ø 22.22			Ø 53.98
169.1 kW ~ 252.0 kW	Ø 22.22	Ø 53.98		Ø 53.98	Ø 25.40 ^{note1)}	

*Maximum pipe length : The pipe length between an outdoor unit and the farthest indoor unit.

Note1) If Ø 25.40 pipe is not available on site, use Ø 28.58 pipe.

- ※ For HR model, only increase the size of the liquid pipe if pipe length exceeds 90m
- ※ For the case that the diameter of the default pipe of an outdoor unit does not match that of the pipe installed on the site, a socket is provided by default together with the outdoor unit.

Size of the pipe between branch joints (B)

Select the pipe size according to the sum of indoor unit capacity which will be connected after the branch.

- ※ However, if the size of the pipe between branch joints (B) is bigger than the size of the pipe connected to the outdoor unit (A), apply the pipe size (A).

Outdoor unit capacity (kW) (Cooling)	Pipe size (mm)		
	Liquid pipe	Low pressure gas pipe	High pressure gas pipe
15.0 kW and below	Ø 9.52	Ø 15.88	Ø 15.88
15.1 kW ~ 22.4 kW		Ø 19.05	
22.5 kW ~ 28.1 kW		Ø 22.22	Ø 19.05
28.2 kW ~ 33.6 kW	Ø 12.70	Ø 28.58	
33.7 kW ~ 45.0 kW			Ø 15.88
45.1 kW ~ 50.4 kW	Ø 28.58	Ø 28.58	
50.5 kW ~ 63.3 kW			
63.4 kW ~ 70.3 kW	Ø 19.05	Ø 41.28	Ø 34.92
70.4 kW ~ 98.4 kW		Ø 19.05	Ø 41.28
98.5 kW ~ 135.2 kW			
135.3 kW ~ 169.0 kW	Ø 22.22	Ø 53.98	Ø 41.28
Over 169.0 kW			

Size of the pipe between the branch joint and the indoor unit

Make a selection according to outdoor unit capacity.

Indoor unit capacity (kW)	Pipe size (O.D. mm)	
	Liquid pipe	Gas pipe
6.0 kW and below	Ø 6.35	Ø 12.70
6.1 kW ~ 16.0 kW	Ø 9.52	Ø 15.88
16.1 kW ~ 23.0 kW	Ø 9.52	Ø 19.05
Over 23.0 kW	Ø 9.52	Ø 22.22

Refrigerant pipe installation

33.6 kW 39.2 kW 44.8 kW

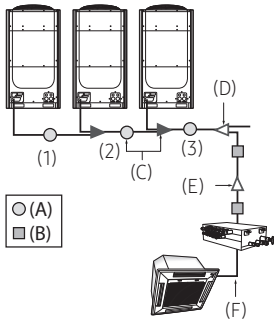

Branch joint

- ▶ Branch joint between outdoor units (C)

Classification	Model name	Specification (kW)
Liquid/Low pressure Y-joint (C)	MXJ-TA3419M	135.2 kW and below
	MXJ-TA4122M	Over 135.2 kW
High pressure Y-joint (C)	MXJ-TA3100M	135.2 kW and below
	MXJ-TA3800M	Over 135.2 kW

- ▶ First branch joint (D)

Make a selection according to outdoor unit capacity.

Classification	Outdoor unit capacity (kW)	Model name of the branch joint
Liquid/Low pressure Y-joint (D)	40.0 kW and below	MXJ-YA2512M
	40.1 kW ~ 45.0 kW	MXJ-YA2812M
	45.1 kW ~ 67.2 kW	MXJ-YA2815M
	67.3 kW ~ 95.2 kW	MXJ-YA3419M
	95.3 kW ~ 135.2 kW	MXJ-YA4119M
	Over 135.2 kW	MXJ-YA4422M
High pressure Y-joint (D)	22.4 kW	MXJ-YA1500M
	22.5 kW ~ 67.2 kW	MXJ-YA2500M
	67.3 kW ~ 135.2 kW	MXJ-YA3100M
	Over 135.2 kW	MXJ-YA3800M

- ▶ Branch joint (E)

Select a branch joint according to the sum of indoor unit capacity which will be connected after the branch.

- ※ However, if the size of the pipe between branch joints (E) is bigger than the size of the pipe connected to the outdoor unit (D), apply the pipe size (D).
- Y-joint

Classification	Model name	Specification (kW)
Y-joint (E)	MXJ-YA1509M	15.0 kW and below
	MXJ-YA2512M	15.1 kW ~ 40.0 kW
	MXJ-YA2812M	40.1 kW ~ 45.0 kW
	MXJ-YA2815M	45.1 kW ~ 70.3 kW
	MXJ-YA3419M	70.4 kW ~ 98.4 kW
	MXJ-YA4119M	98.5 kW ~ 135.2 kW
	MXJ-YA4422M	Over 135.2 kW
Y-joint (E) (Only H/R)	MXJ-YA1500M	22.4 kW and below
	MXJ-YA2500M	22.5 kW ~ 70.3 kW
	MXJ-YA3100M	70.4 kW ~ 135.2 kW
	MXJ-YA3800M	Over 135.2 kW

Additional refrigerant

H/P

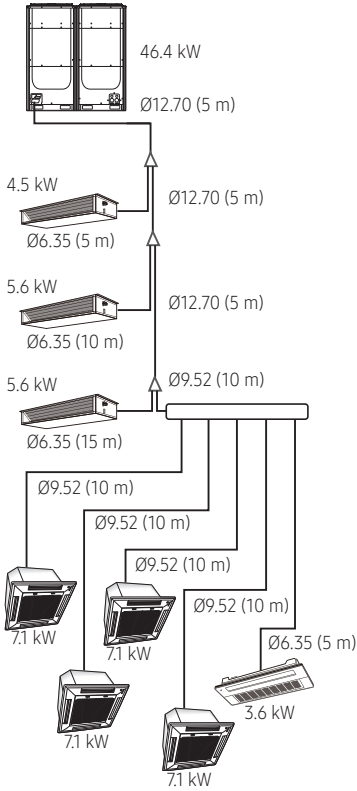

H/R

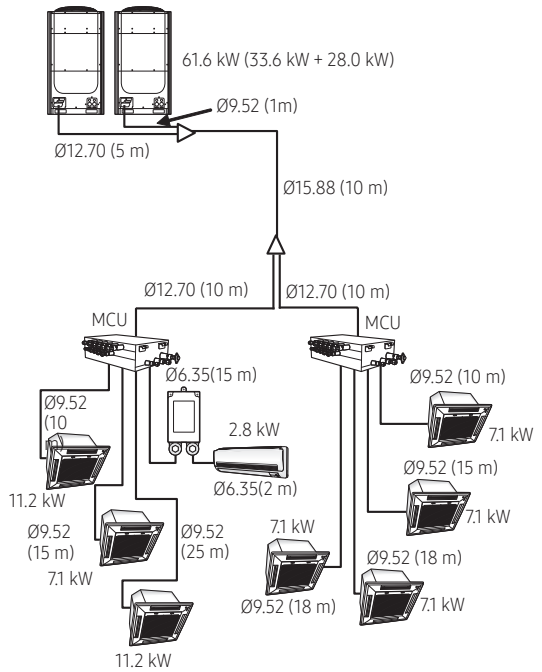

Refrigerant pipe installation

Refrigerant pipe installation

- ▶ Basic amount of refrigerant within the outdoor unit (kg)
 - Amount of additional refrigerant has to be calculated based on the sum of all liquid pipe length.

Classification	AM080JXVHGH/EU	AM100JXVHGH/EU	AM120JXVHGH/EU	AM140JXVHGH/ET	AM160JXVHGH/ET	AM180JXVHGH/ET
Basic amount	6.5	6.5	6.5	9.4	9.4	8.4
Classification	AM200JXVHGH/ET	AM220JXVHGH/ET	AM240KXVGGH/ET	AM260KXVGGH/ET	AM280KXVGGH/ET	
Basic amount	11.0	11.0	14.0	14.0	14.0	
Classification	AM080JXVAGH/EU	AM100JXVAGH/EU	AM120JXVAGH/EU	AM140KXVAGH/ET	AM160KXVAGH/ET	AM180KXVAGH/ET
Basic amount	5.5	5.5	6.5	7.7	8.4	8.4
Classification	AM200KXVAGH/ET	AM220KXVAGH/ET	AM240KXVAGH/ET	AM260KXVAGH/ET	AM280KXVAGH/ET	AM300KXVAGH/ET
Basic amount	8.4	8.4	14.0	14.0	14.0	14.0
Classification	AM100MXVDGH/ET	AM120MXVDGH/ET	AM140MXVDGH/ET	AM160MXVDGH/ET	AM180MXVDGH/ET	
Basic amount	5.5	6.5	7.7	8.4	8.4	
Classification	AM080JXVHGR/EU	AM100JXVHGR/EU	AM120JXVHGR/EU	AM140JXVHGR/ET	AM160JXVHGR/ET	AM180JXVHGR/ET
Basic amount	6.5	6.5	6.5	9.4	9.4	8.4
Classification	AM200JXVHGR/ET	AM220JXVHGR/ET	AM240MXVGNR/ET	AM260MXVGNR/ET	AM280MXVGNR/ET	AM300MXVGNR/ET
Basic amount	11.0	11.0	14.0	14.0	14.0	14.0

- ▶ Amount of additional refrigerant depending on the pipe size (㉓)
 - Amount of additional refrigerant has to be calculated based on the sum of all liquid pipe length.

Size of liquid pipe	Ø 6.35	Ø 9.52	Ø 12.70	Ø 15.88	Ø 19.05	Ø 22.22	Ø 25.40	Ø 28.58
Additional amount (kg/m)	0.02	0.06	0.125	0.18	0.27	0.35	0.53	0.65

- For the indoor unit already connected to EEV kit, the additional refrigerant charging is 0.01kg per meter regardless of the pipe size.

- ▶ Amount of additional refrigerant for each indoor unit (㉔)

(Unit : kg)

Model	Capacity (kW)																				500	1000								
	1.5	1.7	2.2	2.8	3.2	3.6	4	4.5	5.6	6	7.1	8.2	9	9.3	11	11.2	12.8	14	16	18	22	22.4	25	28	32	50	CMH	1000	CMH	
Interior 1way cassette (AM***HN1DEH/***) (AM***NN1PEH/***)		0.15	0.15																											
Slim 1way cassette (AM***FUJ/NN1DEH/**)			0.25	0.25		0.25			0.32	0.32																				
2way cassette (AM***N2DEH/***)									0.31	0.47																				
4way cassette S (600x600) (AM***NNDEH/***)	0.29		0.29	0.29		0.29		0.37	0.37	0.37																				
4way cassette S (AM***FNIN4DEH/**)								0.45	0.45		0.45	0.45				0.57	0.69	0.69												
4way cassette S (AM***N4FEH/***)				0.69		0.69	0.69		1.00	1.00	1.00	1.00	1.00		1.00															
360 cassette (AM***KN4DEH/**)								0.45	0.45		0.45	0.45				0.69	0.69	0.69												
Duct S (AM***NMPKH/**)						0.22		0.22	0.22		0.22		0.31			0.38	0.38	0.38												
Duct S (AM***NMPKH9**)					0.31	0.31		0.38	0.38		0.38																			
Duct S (AM***HNHPKH/**)																0.38	0.38	0.38												
Home Duct (AM***KNLDEH/**)		0.13	0.13	0.13		0.17																								
Home Duct (AM***MNLDEH/**)								0.24	0.24		0.31																			

Refrigerant pipe installation

- ▶ Method to calculate total amount of additional refrigerant
 - Amount of additional refrigerant depending on the pipe length (a)
 - Amount of additional refrigerant for each indoor unit (b) = Σ (Amount of additional refrigerant for each connected indoor unit) ※ Refer to the table
 - Total amount of additional refrigerant = a+b
- ※ Sum of total amount of additional refrigerant and the basic amount of refrigerant should not exceed 100kg. If the refrigerant exceeds 100kg, separate the module so that weight of the refrigerant doesn't exceed 100kg.
 Ex.) For AM200XVAGX, basic amount of refrigerant is 8.4kg, therefore total amount of additional refrigerant (a+b) should not exceed 91.6 kg.
- ▶ Example of refrigerant calculation for HP models

Classification	Size of liquid pipe	Length (m)	Unit amount of refrigerant (kg/m)	Amount of additional refrigerant (kg)	Total amount of additional refrigerant (kg)
		①	②	①×②	Σ (①×②)
Liquid pipe (a)	Ø 6.35	35	0.02	0.7	a 5.575
	Ø 9.52	50	0.06	3.0	
	Ø 12.70	15	0.125	1.875	

Classification	Model name of indoor unit	Number of units	Unit amount of refrigerant (kg/EA)	Amount of additional refrigerant (kg)	Total amount of additional refrigerant (kg)
		①	②	①×②	Σ (①×②)
Indoor unit (b)	4way cassette (AM071FN4DEH X)	4	0.45	1.80	b 3.10
	Slim duct (AM056FNLDEH X)	2	0.35	0.70	
	Slim duct (AM045FNLDEH X)	1	0.35	0.35	
	1way cassette (AM036FN1DEH X)	1	0.25	0.25	

- Total amount of refrigerant (a+b) = 5.575+3.10 = 8.675 (kg)

► Example of refrigerant calculation for HR models

Classification	Size of liquid pipe	Length (m)	Unit amount of refrigerant (kg/m)	Amount of additional refrigerant (kg)	Total amount of additional refrigerant (kg)
		①	②	①×②	Σ(①×②)
Liquid pipe (a)	Ø 6.35	15	0.02	0.3	a 11.965
	Ø 9.52	112	0.06	6.72	
	Ø 12.70	25	0.125	3.125	
	Ø 15.88	10	0.18	1.8	
	Ø 6.35 (EEV Kit ~ indoor unit)	2	0.01	0.02	

Classification	Model name of indoor unit	Number of units	Unit amount of refrigerant (kg/EA)	Amount of additional refrigerant (kg)	Total amount of additional refrigerant (kg)
		①	②	①×②	Σ(①×②)
Indoor unit (b)	4way cassette (AM071FN4DEH*)	5	0.45	2.25	b 4.66
	4way cassette (AM112FN4DEH*)	2	0.57	1.14	
	Neo forte (AM028FNTDEH*)	1	0.27	0.27	
	MCU	2	0.5	1	

- Total amount of refrigerant (a)+ (b) = 11.965+4.66 = 16.625 (kg)

Temper grade and minimum thickness of the refrigerant pipe

Outer diameter (mm)	Minimum thickness (mm)	Temper grade
Ø 6.35	0.70	Annealed
Ø 9.52	0.70	
Ø 12.70	0.80	
Ø 15.88	1.00	
Ø 19.05	0.90	Drawn
Ø 22.22	0.90	
Ø 25.40	1.00	
Ø 28.58	1.10	
Ø 31.75	1.10	
Ø 34.92	1.20	
Ø 38.10	1.35	
Ø 41.28	1.43	
Ø 44.45	1.60	
Ø 50.80	2.00	
Ø 53.98	2.10	

Refrigerant pipe installation



- For pipes larger than $\varnothing 19.05$, drawn type (C1220T-1/2H or C1220T-H) type copper pipe must be used. If an annealed type (C1220T-O) copper pipe is used, pipe may break due to its low pressure resistance and cause personal injury.

Keeping refrigerant pipe

To prevent foreign materials or water from entering the pipe, storing method and sealing method (especially during installation) is very important. Apply correct sealing method depending on the environment.

Exposure place	Exposure time	Sealing type
Outdoor	Longer than one month	Pipe pinch
	Shorter than one month	Taping
Indoor	-	Taping

Refrigerant pipe welding and safety information



Important information for refrigerant pipe work

- Make sure there is no moisture inside the pipe.
- Make sure there are no foreign substances and impurities in the pipe.
- Make sure there is no leakage.
- Make sure to follow the instruction when welding or storing the pipe.

Nitrogen flushing welding

- When welding the refrigerant pipes, flush them with nitrogen gas as shown in the picture.
- If you do not perform nitrogen flushing when welding the pipes, oxide may form inside the pipe. It can cause the damage of the important parts such as compressor and valves etc.
- Adjust the flow rate of the nitrogen flushing with a pressure regulator to maintain $0.05\text{m}^3/\text{h}$ or less.

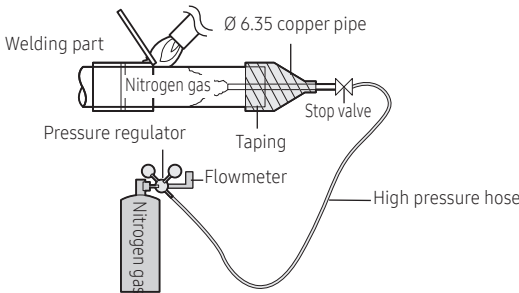

Direction of the pipe when welding

- Direction of the pipe should be headed downward or in a sideways when welding.
- Avoid welding the pipe with pipe direction heading upward.



- When you test gas leakage after welding the pipes, use a designated solution for gas leakage detection. If you use the detection solution that includes sulfuric ingredient, it may cause corrosion to the pipes.

Cutting or flaring the pipes

1. Make sure that you prepared the required tools.
 - ▶ Pipe cutter, Deburring tool, flaring tool and pipe holder, etc.
2. If you want to shorten the pipe, cut it with a pipe cutter ensuring that the cut edge remains at 90° with the side of the pipe.
 - ▶ Refer to below illustrations for correct and incorrect examples of cut edges.

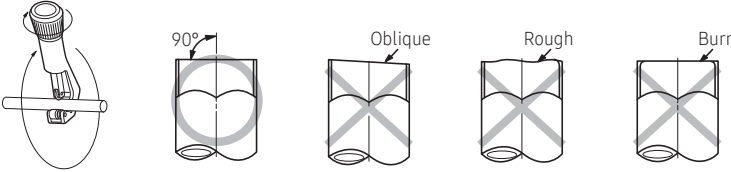

3. To prevent a gas leak, remove all burrs at the cut edge of the pipe using a Deburring tool.
4. Carry out flaring work using flaring tool as shown below.

[Flaring tools]

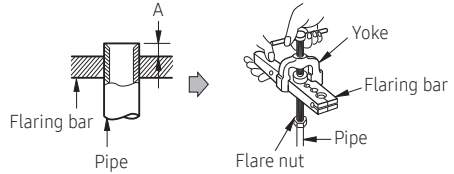
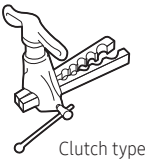

	Pipe diameter [D (mm)]	Depth of flaring part [A (mm)]		
		Using flaring tool for R-410A	Using conventional flaring tool	
			Clutch type	Wing nut type
	Ø 6.35	0~0.5	1.0~1.5	1.5~2.0
	Ø 9.52	0~0.5	1.0~1.5	1.5~2.0
	Ø 12.70	0~0.5	1.0~1.5	1.5~2.0
	Ø 15.88	0~0.5	1.0~1.5	1.5~2.0

5. Check that you flared the pipe correctly.
 - ▶ Refer to below illustrations for correct and incorrect examples of flared pipe.



- If foreign matters or burrs are not removed after cutting pipe, refrigerant gas may leak.
- If foreign matters enter inside the pipe, important interior parts of the unit may get damaged or product efficiency will be reduced. So, the direction of pipe should be downward during pipe cutting or flaring.

Refrigerant pipe installation

Connecting the flared pipes

- ▶ Check if the flaring is properly done according to the standard size.
- ▶ Align the center of the piping and tighten the flare nut with your hands. Then, tighten the flare nut with torque wrench in a direction of the arrow indicated in below illustration.
- ▶ Make sure to use ester oil to coat the flare connection section.

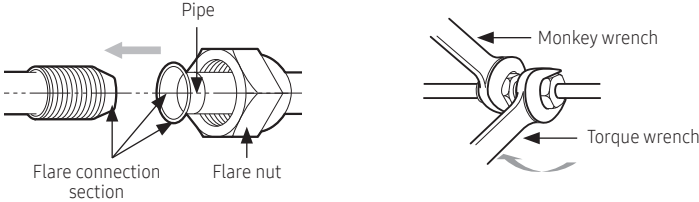

Outer diameter (D, mm)	Connection torque (N·m)	Flare dimension (L, mm)	Flare shape (mm)
∅ 6.35	14~18	8.7~9.1	
∅ 9.52	34~42	12.8~13.2	
∅ 12.70	49~61	16.2~16.6	
∅ 15.88	68~82	19.3~19.7	
∅ 19.05	100~120	23.6~24.0	



- Blowing Nitrogen gas should be done when welding the pipe.
- Make sure to use the provided flare nut.
- Make sure that there are no cracks or twisted part when you need to bend the pipe.
- Do not fasten the flare nut with excessive strength.
- R-410A is a high pressure refrigerant and there is a risk of refrigerant leakage if the flare connection is not coated with ester oil. Therefore, apply ester oil to coat the flare connection area.

Pipe installation for an outdoor unit

1. Direction of the pipe

Refrigerant pipe can be withdrawn from the front, left and right side. Take necessary method to install the pipes according to the condition of the installation site.

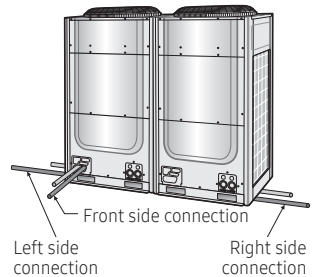



Caution for using knock-out hole

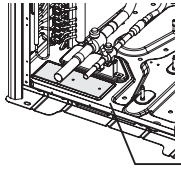

Knock-out hole

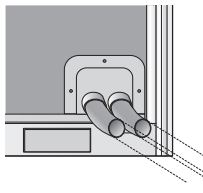

- Make sure to prevent any damages on the exterior of the outdoor unit.
- Remove all burrs around the knock-out hole and apply varnish on the cross section and edges of the knock-out hole to prevent rust.
- Use a cable protection tube and bushing to prevent a cable from being damaged when passing through a knock-out hole.

2. Connecting refrigerant pipe for outdoor unit

Classification	Front side connection	Right/left (and bottom) side connection
Working process	<ul style="list-style-type: none"> • First, remove the piping cover from the outdoor unit. • Separate the knock-out hole that you are going to use. If you separate the knock-out hole that is going to be unused, small animals such as squirrels and rats may get into the unit through the hole. • Fix the bottom side of the piping cover first and then fix the top part of it. 	<ul style="list-style-type: none"> • Separate the knock-out hole at the bottom side of the unit and install the pipe. • After installing and insulating the pipe, close up the remaining holes. If not, small animals such as rats and squirrels may get inside the unit.
H/P		
H/R		

Refrigerant pipe installation



Caution for welding the pipe to an outdoor unit

- When welding the pipe, the unit may get damaged by the heat and flame from welding. Use a flame proofing cloth to protect the unit from a welding fire or flame. Sensor for detecting outside temperature is located on the left side of the welding part so be extra careful not to damage the sensor when welding.
- The O-ring and Teflon packing inside service valve may get damaged by the heat from welding. Wrap the bottom side of the service valve with a wet cloth and weld it as shown in the illustration. Also, water dripping from the wet cloth may interrupt the welding. Make sure the water does not drip from the wet cloth.
- Make sure that connected pipes does not interrupt each other or make contact with the product. (Vibration may cause damage to the pipes.)
- When removing the sealed pipe on the bottom side of the service valve, cut it with a pipe cutter first and then start the welding. When the sealed pipe is welded without cutting, you may get injured by the refrigerant within the pipe.

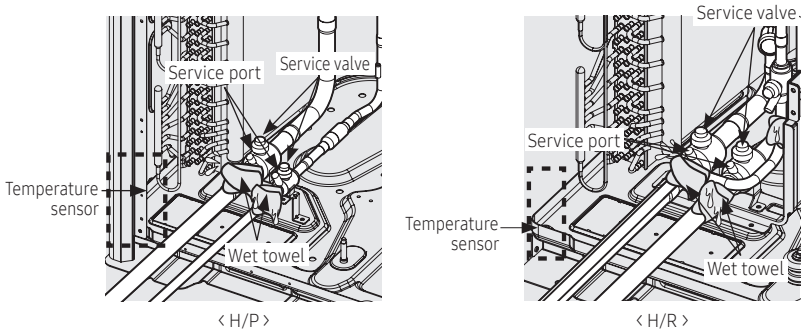

3. Pipe installation between the outdoor units

- ▶ You will need branch joints, which is an optional accessory, for connecting in between outdoor units in order to combine outdoor units in module.
- ※ **For optimal distribution of the refrigerant, you must use Y-joint as branch joint for connecting outdoor units. (Do not use T-joint)**
- ▶ When you install the outdoor units in module, there is no restriction of installation order among outdoor units.
- ▶ Height of the connection pipe should be same or lower than the ones connected to the outdoor units.
- ▶ Check the changes in comparison with the DVM II, III and IV.

Caution	Correct installation	Incorrect installation
<p>Refrigerant pipes should be connected at the same or lower level than the ones connected to the outdoor unit.</p>		

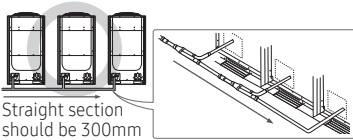
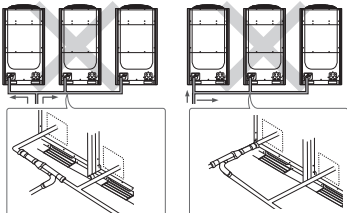
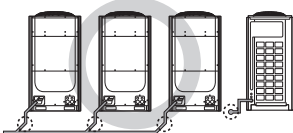
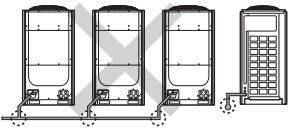
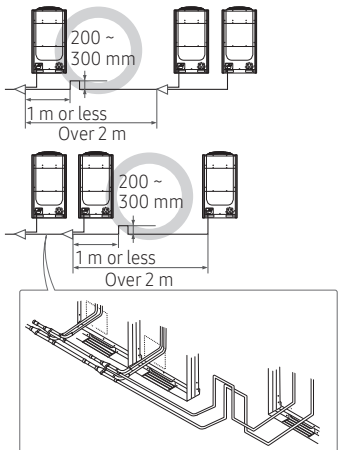
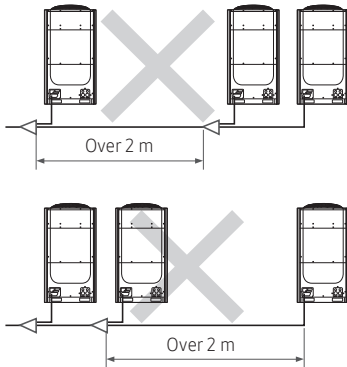
Caution	Correct installation	Incorrect installation
<p>Refrigerant pipes must be connected by the side of the product.</p>	 <p>Straight section should be 300mm or more</p>	
<p>Branch joint between outdoor units must be installed horizontally.</p>		
<p>Install a vertical trap in following cases as shown in the figure :</p> <p>Case1. Pipe length between outdoor unit branches exceeds 2m.</p> <p>Case2. Pipe length between outdoor unit and its branch exceeds 2m.</p>		

Examples of refrigerant pipe installation

H/P

1. Using Y-joint

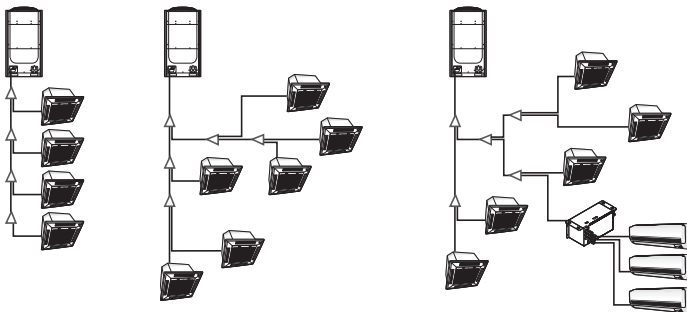

Refrigerant pipe installation

2. Using distribution header

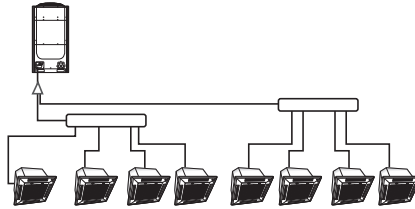
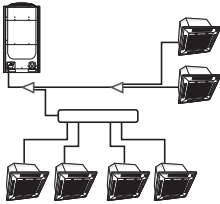

H/R

Using Y-joint

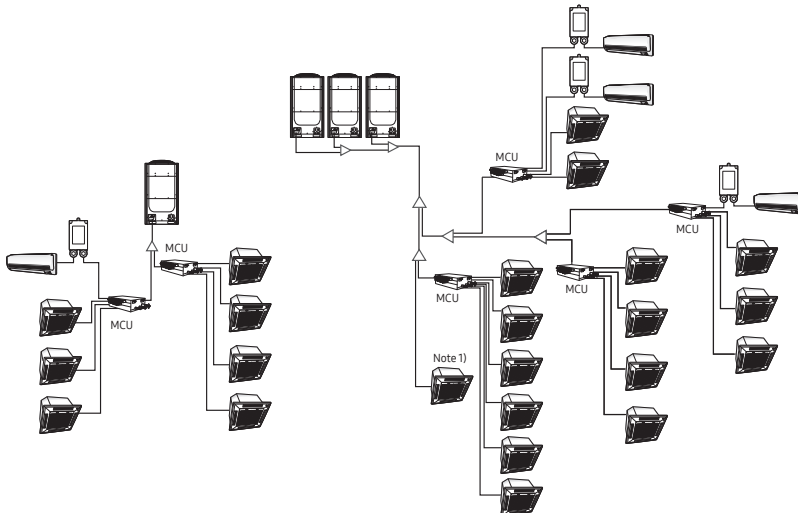

Note 1) Direct-connected indoor unit without MCU (for HR only)

- This indoor unit can only be used for cooling operation. (Heating operation is not possible.)
- Connect indoor unit to liquid and low pressure gas pipe.
- Change the installation option for direct-connected indoor unit without MCU. (refer to the indoor unit installation manual)

Allowable length of the refrigerant pipe and the installation examples

H/P

ENGLISH

Classification	Single Installation	Module installation
Installing only with Y-joint		
Installing with Y-joint and distribution header		
Installing only with distribution header		

Classification		Example		Remarks		
Maximum allowable length of pipe	Outdoor unit ~ Indoor unit	Actual length (Equivalent length)	200m and below (220m and below)	Installing only with Y-joint	$a+b+c+d+e+f+g+p \leq 200\text{m}(220\text{m})$	Equivalent length Y-joint: 0.5 m, Distribution header: 1 m
				Installing with Y-joint and distribution header	$a+b+h \leq 200\text{m}(220\text{m})$, $a+i+k \leq 200\text{m}(220\text{m})$	
				Installing only with distribution header	$a+i \leq 200\text{m}(220\text{m})$	
	Total length of pipe (m)	1,000 m or less	Installing only with Y-joint	$a+b+c+d+e+f+g+h+i+j+k+l+m+n+p \leq 1000\text{m}$	-	
			Installing with Y-joint and distribution header	$a+b+c+d+e+f+g+h+i+j+k \leq 1000\text{m}$	-	
			Installing only with distribution header	$a+b+c+d+e+f+g+h+i \leq 1000\text{m}$	-	
Outdoor unit ~ Outdoor unit (Module installation)	Pipe length	10 m or less	$x \leq 10\text{ m}, y \leq 10\text{ m}, z \leq 10\text{ m}$			
	Equivalent length	13 m or less	$x \leq 13\text{ m}, y \leq 13\text{ m}, z \leq 13\text{ m}$			
Maximum allowable height difference of pipe	Outdoor unit ~ Indoor unit	110/110m ^{Note 2)}	$H1 \leq 110/110\text{m}$			
	Indoor unit ~ Indoor unit	50m or less	$H2 \leq 50\text{m}$			
But, when AM***XNQDEH* / AM***XJNV* is installed, H2 is 15 m or less.						

Refrigerant pipe installation

Classification			Example		Remarks	
Maximum allowable length after branch joint	First branch joint ~ Farthest Indoor unit	Pipe length	45 m or less	Installing only with Y-joint Installing with Y-joint and distribution header	$b+c+d+e+f+g+p \leq 45$ m $i+k \leq 45$ m	-
				Installing only with distribution header	$i \leq 45$ m	
		45 m~90 m <small>Note 1)</small>	Required conditions must be satisfied			

EEV kit		Model name		Remarks	
EEV kit ~ Indoor unit	Actual pipe length	2 m	MEV-E24SA	1 indoor	Apply to products without EEV (Wall mount & ceiling)
			MEV-E32SA		
		20 m or less	MXD-E24K132A	2 indoor	
			MXD-E24K200A		
			MXD-E32K200A		
			MXD-E24K232A	3 indoor	
			MXD-E24K300A		
MXD-E32K224A					
MXD-E32K300A					

※ Please refer to the EEV Kit manual.

Note 1) Required condition

Classification	Condition	Example
First branch joint ~ Farthest Indoor unit	$45m \leq b+c+d+e+f+g+p \leq 90m$: branch pipes (b, c, d, e, f, g) size must be increased by 1 grade	
Total length of extended pipe	If the size of pipe (main pipe), between the first branch joint and the outdoor unit, is not increased by 1 grade, $a+(b+c+d+e+f+g) \times 2 + h+i+j+k+l+m+n+p \leq 1000$ m	
	If the size of pipe (main pipe), between the first branch joint and the outdoor unit, is increased by 1 grade, $(a+b+c+d+e+f+g) \times 2 + h+i+j+k+l+m+n+p \leq 1000$ m	
Each Y-joint ~ Each indoor unit	$h, i, j, \dots p \leq 45$ m	
Difference between the distance of the outdoor unit to the farthest indoor unit and nearest indoor unit $\leq 45m$, $(a+b+c+d+e+f+g+p)-(a+h) \leq 45m$		

Note 2) When indoor unit is located at higher level than outdoor unit, allowable height difference is 110m, (If the height difference is over 40m, contact your local dealer for more information.)

but when the indoor unit is located at lower level than outdoor unit, allowable height difference is 110m (If the height difference is over 50m, need to decide whether to install PDM kit or not.)

Model name of the PDM kit : MXD-A38K2A, MXD-A12K2A, MXD-A58K2A

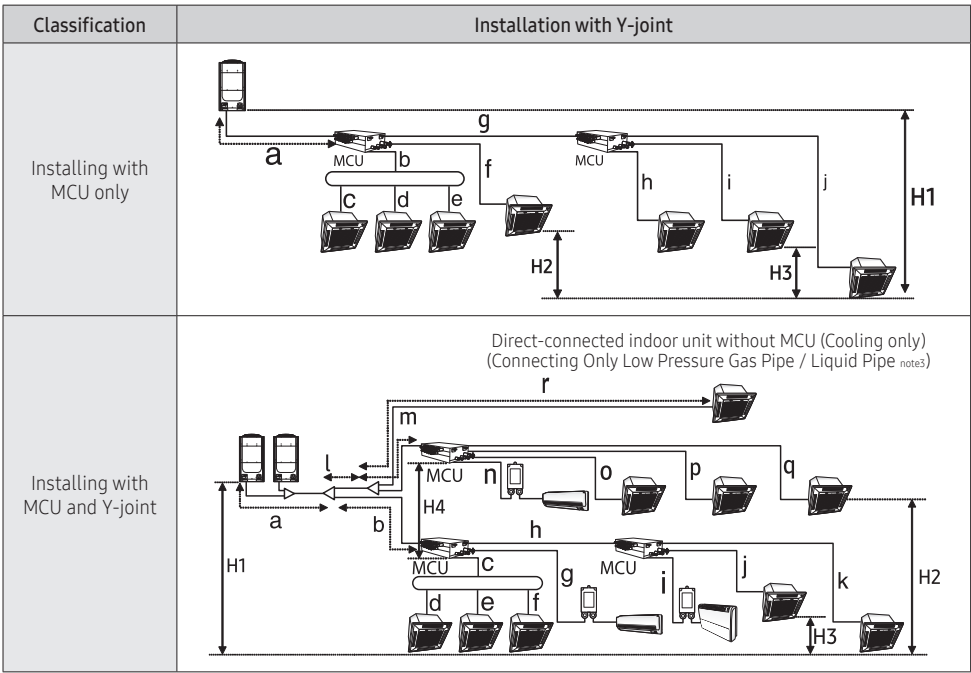

Classification		Example		Remarks	
Maximum allowable pipe length	Outdoor unit ~ Indoor unit	Actual pipe length (Equivalent length)	200 m or less (220 m or less)	Installing only with MCU $a+g+j \leq 200 \text{ m (220 m)}$	Equivalent length • Y-joint: 0.5 m • Distribution header: 1 m • MCU: 1 m
		Total length of pipe	1000 m or less	Installing with MCU and Y-joint $a+b+h+k \leq 200 \text{ m (220 m)}$	
	Outdoor unit ~ Outdoor unit (Module installation)	Pipe length	10 m or less	Installing only with MCU $a+b+c+d+e+f+g+h+i+j \leq 1000 \text{ m}$	
		Equivalent length	13 m or less	Installing with MCU and Y-joint $a+b+c+\dots+r \leq 1000 \text{ m}$	
MCU ~ Indoor unit	Pipe length	45 m or less	Installing only with MCU $b+c \leq 45 \text{ m}, b+d \leq 45 \text{ m}, b+e \leq 45 \text{ m}, f \leq 45 \text{ m}, g+h \leq 45 \text{ m}, g+i \leq 45 \text{ m}, g+j \leq 45 \text{ m}$		
		45 m or less	Installing with MCU and Y-joint $c+d, c+e, c+f, g, h+i, h+j, h+k, n, o, p, q, r \leq 45 \text{ m}$		

Refrigerant pipe installation

Classification			Example		Remarks
Maximum allowable height difference	Outdoor unit ~ Indoor unit	Pipe length	110 m / 110 m <small>Note 1)</small>	H1 ≤ 110 m / 110 m	
	Indoor unit ~ Indoor unit		40 m or less	H2 ≤ 40 m	
	Indoor unit ~ Indoor unit (in one MCU)		15 m or less	H3 ≤ 15 m	
	MCU ~ MCU		30 m or less	H4 ≤ 30 m	
Maximum allowable length after branch joint	First branch joint ~ Farthest Indoor unit	Pipe length	45 m or less	Installing only with MCU	g+j ≤ 45 m
				Installing with MCU and Y-joint	b+h+k ≤ 45 m l+m+q ≤ 45 m l+r ≤ 45 m
			45 ~ 90 m <small>Note 2)</small>	Required conditions must be satisfied	

EEV Kit		Model name		Remarks	
EEV kit ~ Indoor unit	Actual pipe length	2 m	MEV-E24SA	1 indoor	Apply to products without EEV (Wall mount & ceiling)
			MEV-E32SA		
		20 m or less	MXD-E24K132A	2 indoor	
			MXD-E24K200A		
			MXD-E32K200A		
			MXD-E24K232A	3 indoor	
			MXD-E24K300A		
			MXD-E32K222A		
MXD-E32K300A					

※ Please refer to the EEV Kit manual.

Note 1) When indoor unit is located at higher level than outdoor unit, allowable height difference is 110m, (If the height difference is over 40m, contact your local dealer for more information.) but when the indoor unit is located at lower level than outdoor unit, allowable height difference is 110m (If the height difference is over 50m, need to decide whether to install PDM kit or not.)
 Model name of the PDM kit : MXD-A38K2A, MXD-A12K2A, MXD-A58K2A

Note 2) Required condition

Classification	Condition	Example
First branch joint ~ Farthest Indoor unit	$45\text{ m} \leq b+h+k, l+m+q, l+r \leq 90\text{ m}$: Size of the branch liquid and low pressure gas pipes (b, l, m) must be increased by 1 grade.	
Total length of extended pipe	<p>If the size of pipe (main pipe), between the first branch joint and the outdoor unit, is not increased by 1 grade, $a+(b+l+m) \times 2+c+d+e+f+g+h+i+j+k+n+o+p+q+r \leq 1000\text{ m}$</p> <p>If the size of pipe (main pipe), between the first branch joint and the outdoor unit, is increased by 1 grade, $(a+b+l+m) \times 2+c+d+e+f+g+h+i+j+k+n+o+p+q+r \leq 1000\text{ m}$</p>	
MCU ~ Each indoor unit	$c+d, c+e, c+f, g, h+i, h+j, h+k, n, o, p, q, r \leq 45\text{ m}$	
	Difference between the distance of the outdoor unit to the farthest indoor unit and nearest indoor unit ≤ 45 $(a+b+h+k) - (a+b+c+d) \leq 45$	

Note 3) For indoor units to which no MCU is connected, be sure to set their options to “Cooling only indoor unit,” and then connect them to a low pressure gas pipe and a liquid pipe. Be sure to combine the cooling only indoor units so that their total capacity becomes 50% or less of the total capacity of all indoor units.

Note 4) In case of connecting more than one indoor unit in one MCU Port, the below indoor units cannot be combined. ERV plus (AM***FNKDE**), OAP duct(AM***JNEPE**), Hydro Unit HE(AM***FNBD**), Hydro Unit HT(AM***FNBF**), AHU kit (MXD-K***AN, MCM-D***N)

Note 5) In case of connecting two MCU ports with Y-joint, the indoor units cannot be combined to more than one.

Refrigerant pipe installation

Installing the branch joints

Branch joints must be installed 'horizontally' or 'vertically'.

Horizontal installation

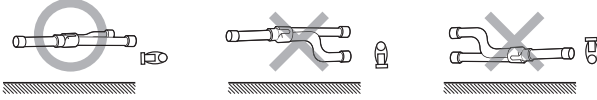

Vertical installation

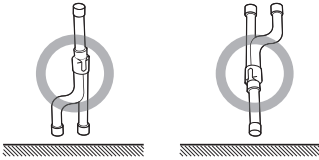

- For A~J type branch joints : Connect the branch joint to the connection pipe with the provided reducer.
- For K~Z type branch joints : Cut the connection part of the branch joint or the provided socket, according to the diameter of the connection pipe, before connecting them.

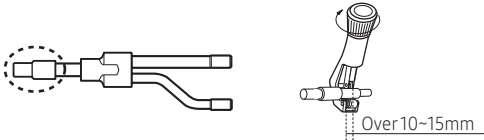

- Install the branch joint within $\pm 15^\circ$ of the horizon or vertical line.
- Make sure that the pipe is not bent at where it is connected to the branch joint.
- Keep a minimum straight line distance of 500mm or more before connecting branch joint.

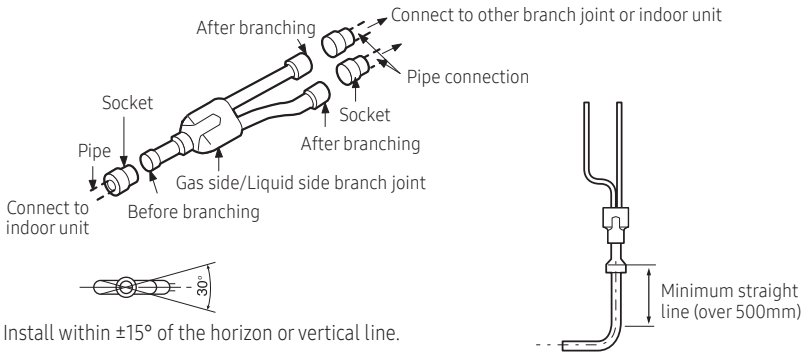

Installing the distribution header

1. Select the reducer that fits the diameter of the pipe.

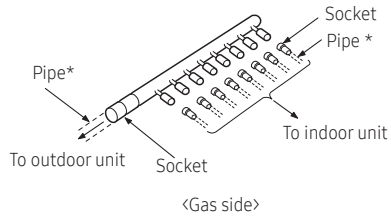
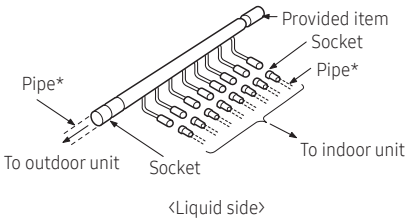

※ Pipe : Separately purchased item

2. If the number of connected indoor unit is fewer than ports on the distribution header, block the unused ports with caps.

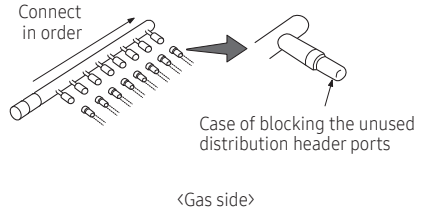
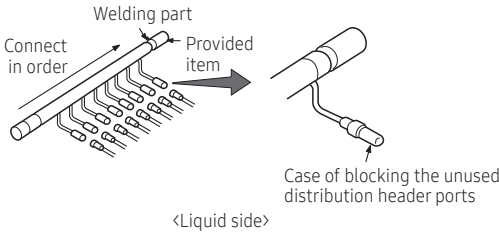

- For A~J type distribution header :
Connect the distribution header to the connection pipe with the provided reducer.
- For K~Z type distribution headers :
Cut the provided socket, according to the diameter of the connection pipe, before connecting it.

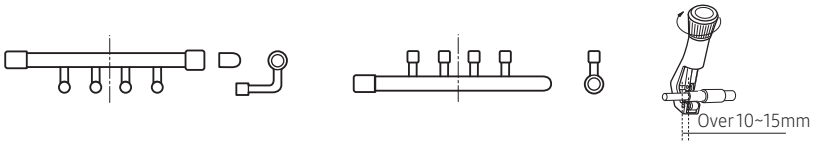

- Connect the indoor units in order, while respecting the direction of the arrow shown in the illustration.
- When indoor units are connected to same distribution head, indoor unit must be connected in order of their capacity, from largest to smallest.

Refrigerant pipe installation

- 3. Install the distribution header horizontally.
- ▶ Install the distribution header horizontally so that its ports does not face down.

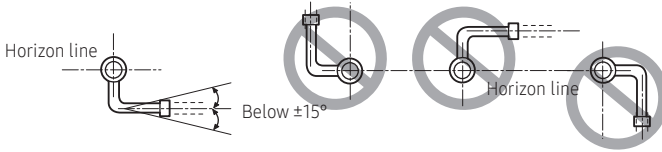
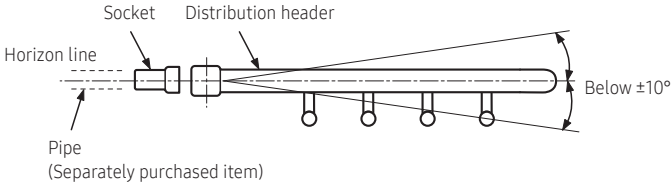

< Liquid side >

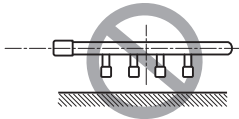
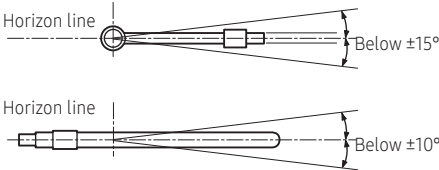

< Gas side >

Installing the branch joint between outdoor units

Installation of outdoor joints

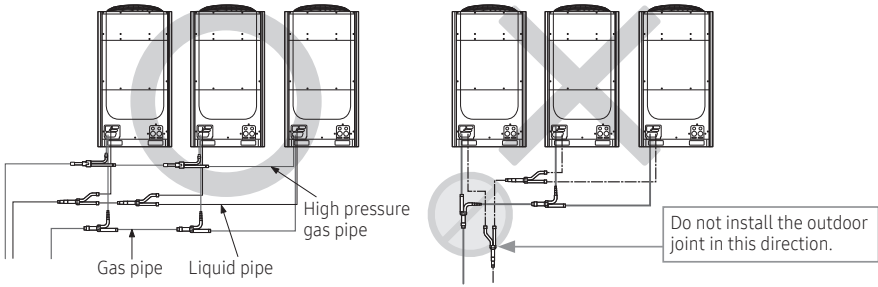

※ High pressure gas pipe only applies to the H/R product.

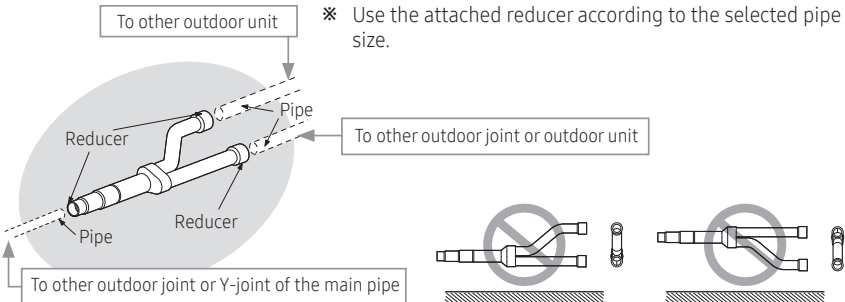

<Liquid side>

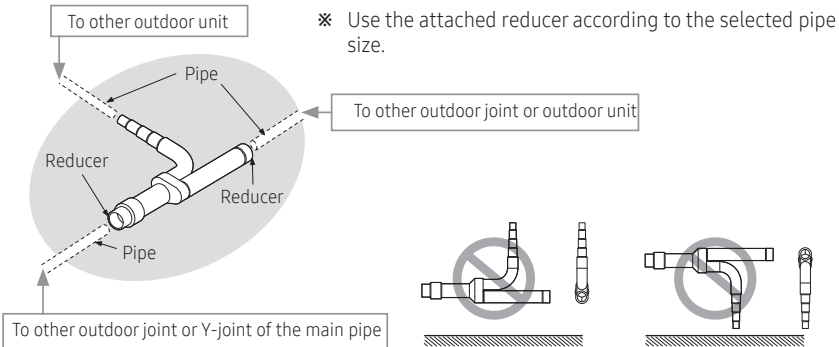
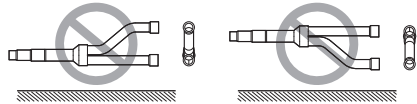

<Gas side>

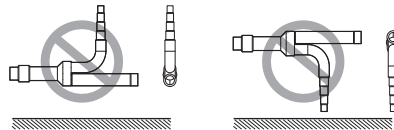

Refrigerant pipe installation

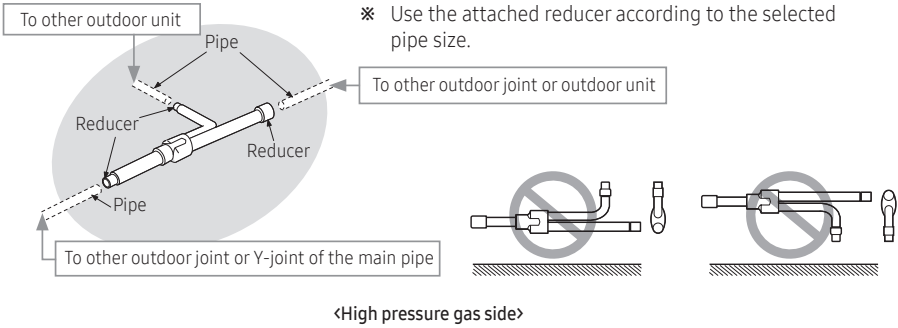

NOTE

- Connect the Outdoor joint to the pipe by cutting the outlet of the Outdoor joint or provided reducer properly.

10-15 mm or more

Installing the MCU











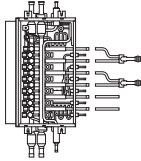
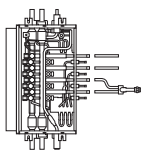
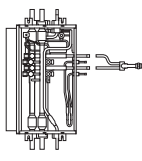
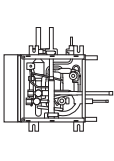
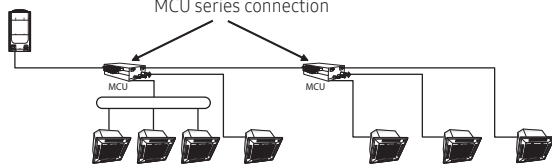

MCU specification

Model	MCU-S6NEK2N	MCU-S4NEK3N	MCU-S2NEK2N	MCU-S1NEK1N
Exterior of MCU				
Number of connectable indoor units at one port	Up to 8 units	Up to 8 units	Up to 8 units	Up to 8 units
The maximum capacity of the connectable indoor units at one port	16 kW	16 kW	16 kW	16 kW
The maximum capacity of the connectable indoor units	61.6 kW	61.6 kW	32.0 kW	16 kW
Internal EEV	Not included			

CAUTION

- Indoor units without internal EEV(AM***NTDE*, AM***NADE*) can not be connected directly to the MCU.
- Please connect these indoor units using EEV kit(MEV-E**SA, MXD-E**K**A).

Installing the indoor units

Model	MCU-S6NEK2N	MCU-S4NEK3N	MCU-S2NEK2N	MCU-S1NEK1N												
<p>Example installing (Each port connection)</p>																
<p>Example installing (MCU series connection)</p>	<p style="text-align: center;">MCU series connection</p> 															
<p>Installing indoor units</p>	<p>Under 16.0 kW indoor unit : Don't use Y-connector 16.0 kW ~ 28.0 kW indoor unit : Use Y-connector at the Gas & Liquid line If you want to continuous cooling operation under -5 °C, set outdoor 'Expand operational temperature range for cooling operation (HR only)', and use Y-connector on 5.0 ~ 16 kW indoor unit</p> <p>In case of using Y-connector, it is only connectable for port combination at below Connectable port combination for Y-connector : A + B port, C + D port, E + F port Non-connectable port combination for Y-connector : B + C port, D + E port, non-continuous port</p> <p>Set Dip Switch option for using Y-connector</p> <table border="0" style="width: 100%; text-align: center;"> <tr> <td>S/W Option</td> <td>S/W Option</td> <td>S/W Option</td> <td>S/W Option</td> </tr> <tr> <td></td> <td></td> <td></td> <td></td> </tr> <tr> <td>Default</td> <td>Combination of A+B port</td> <td>Combination of C+D port</td> <td>Combination of E+F port</td> </tr> </table> <p>In case of MCU connection in series, the maximum capacity of indoor units in MCU series connection is 61.6 kW</p>			S/W Option	S/W Option	S/W Option	S/W Option					Default	Combination of A+B port	Combination of C+D port	Combination of E+F port	<p>This unit is only connectable for one port under 16 Kw</p> <p>This unit is impossible to connect MCU to MCU in series.</p>
S/W Option	S/W Option	S/W Option	S/W Option													
																
Default	Combination of A+B port	Combination of C+D port	Combination of E+F port													

Electrical wiring work

How to connect the pipes

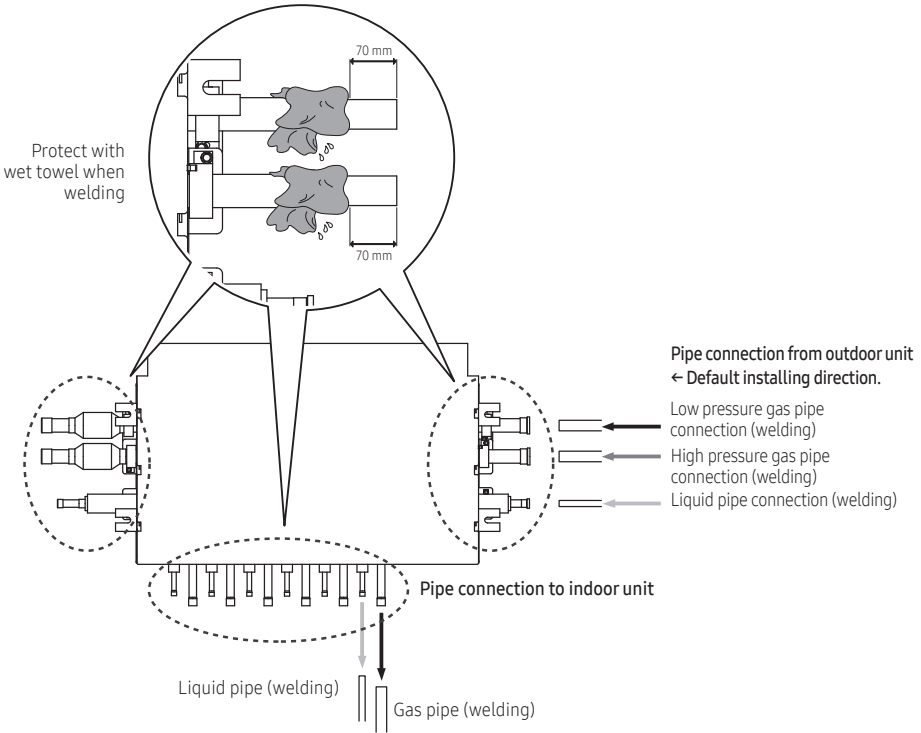

- ※ When installing MCU, use the pattern sheet for installation that is provided with the product.
- ※ When welding the gas pipes, protect the product with the flame-proof sheet.
- ※ When connecting the MCU with outdoor units, default direction is set in the MCU.
If installing opposite direction, weld the enclosed copper cap in each high pressure, low pressure and liquid pipes.

Specification of the circuit breaker and power cable

Premium compact type (Heat pump)

Model	MCA	MFA
AM080JXVHGH/EU	18.0	25
AM100JXVHGH/EU	21.1	32
AM120JXVHGH/EU	25.0	32
AM140JXVHGH/ET	25.0	32
AM160JXVHGH/ET	32.0	40
AM180JXVHGH/ET	39.2	50
AM200JXVHGH/ET	42.0	63
AM220JXVHGH/ET	44.6	63
AM240KXVGGH/ET	55.0	63
AM260KXVGGH/ET	60.0	75
AM280KXVGGH/ET	67.0	75
AM300KXVAGH/ET	73.0	80
AM320KXVGGH1ET	67.0	80
AM340KXVGGH1ET	69.6	80
AM360KXVGGH1ET	69.6	80
AM380KXVGGH1ET	76.6	90
AM400KXVGGH1ET	83.8	100
AM420KXVGGH1ET	86.6	100
AM440KXVGGH1ET	98.0	125
AM460KXVGGH1ET	105.0	125
AM480KXVGGH1ET	112.2	125
AM500KXVGGH1ET	115.0	150
AM520KXVGGH1ET	117.6	150
AM540KXVGGH1ET	128.0	150
AM560KXVGGH1ET	133.0	150
AM580KXVGGH1ET	140.0	175
AM600KXVGGH1ET	146.0	175
AM620KXVGGH1ET	140.0	175
AM640KXVGGH1ET	142.6	175
AM660KXVGGH1ET	142.6	175
AM680KXVGGH1ET	149.6	175
AM700KXVGGH1ET	156.8	175
AM720KXVGGH1ET	159.6	175
AM740KXVGGH1ET	162.2	200
AM760KXVGGH1ET	172.6	200
AM780KXVGGH1ET	177.6	200
AM800KXVGGH1ET	184.6	225
AM820KXVGGH1ET	190.6	225
AM840KXVGGH1ET	201.0	225
AM860KXVGGH1ET	206.0	250
AM880KXVGGH1ET	213.0	250
AM900KXVGGH1ET	219.0	250

Premium energy efficiency type (Heat pump)

Model	MCA	MFA
AM080JXVHGH/EU	18.0	25
AM100JXVHGH/EU	21.1	32
AM120JXVHGH/EU	25.0	32
AM140JXVHGH/ET	25.0	32
AM160JXVHGH/ET	32.0	40
AM180JXVHGH/ET	39.2	50
AM200JXVHGH/ET	42.0	63
AM220KXVGGH2ET	46.1	63
AM240KXVGGH2ET	50.0	63
AM260KXVGGH2ET	57.2	63
AM280KXVGGH2ET	60.0	75
AM300KXVGGH2ET	64.2	75
AM320KXVGGH2ET	64.2	75
AM340KXVGGH2ET	75.2	90
AM360KXVGGH2ET	78.4	90
AM380KXVGGH2ET	81.2	90
AM400KXVGGH2ET	82.2	90
AM420KXVGGH2ET	85.0	100
AM440KXVGGH2ET	96.4	125
AM460KXVGGH2ET	99.2	125
AM480KXVGGH2ET	102.0	125
AM500KXVGGH2ET	103.4	125
AM520KXVGGH2ET	117.2	150
AM540KXVGGH2ET	120.0	150
AM560KXVGGH2ET	124.2	150
AM580KXVGGH2ET	133.0	150
AM600KXVGGH2ET	133.4	150
AM620KXVGGH2ET	135.6	150
AM640KXVGGH2ET	138.4	175
AM660KXVGGH2ET	142.6	175
AM680KXVGGH2ET	142.6	175
AM700KXVGGH2ET	156.4	175
AM720KXVGGH2ET	156.8	175
AM740KXVGGH2ET	159.6	175
AM760KXVGGH2ET	162.4	200
AM780KXVGGH2ET	165.2	200
AM800KXVGGH2ET	177.6	200
AM820KXVGGH2ET	180.4	200
AM840KXVGGH2ET	183.2	225
AM860KXVGGH2ET	185.8	225
AM880KXVGGH2ET	196.2	225
AM900KXVGGH2ET	201.2	225

Electrical wiring work

Standard type (Heat pump)

Model	MCA	MFA
AM080JXVAGH/EU	18.0	25
AM100JXVAGH/EU	21.1	32
AM120JXVAGH/EU	25.0	32
AM140KXVAGH/ET	25.0	32
AM160KXVAGH/ET	32.0	40
AM180KXVAGH/ET	39.2	50
AM200KXVAGH/ET	42.0	63
AM220KXVAGH/ET	44.6	63
AM240KXVAGH/ET	55.0	63
AM260KXVAGH/ET	60.0	75
AM280KXVAGH/ET	67.0	75
AM300KXVAGH/ET	73.0	80
AM320KXVAGH/ET	65.7	80
AM340KXVAGH/ET	69.6	80
AM360KXVAGH/ET	69.6	80
AM380KXVAGH/ET	76.6	90
AM400KXVAGH/ET	83.8	100
AM420KXVAGH/ET	86.6	100
AM440KXVAGH/ET	89.2	100
AM460KXVAGH/ET	105.0	125
AM480KXVAGH/ET	112.2	125
AM500KXVAGH/ET	115.0	150
AM520KXVAGH/ET	117.6	150
AM540KXVAGH/ET	128.0	150
AM560KXVAGH/ET	133.0	150
AM580KXVAGH/ET	140.0	175
AM600KXVAGH/ET	146.0	175
AM620KXVAGH/ET	138.7	175
AM640KXVAGH/ET	142.6	175
AM660KXVAGH/ET	142.6	175
AM680KXVAGH/ET	149.6	175
AM700KXVAGH/ET	156.8	175
AM720KXVAGH/ET	159.6	175
AM740KXVAGH/ET	162.2	200
AM760KXVAGH/ET	172.6	200
AM780KXVAGH/ET	177.6	200
AM800KXVAGH/ET	184.6	225
AM820KXVAGH/ET	190.6	225
AM840KXVAGH/ET	201.0	225
AM860KXVAGH/ET	206.0	250
AM880KXVAGH/ET	213.0	250
AM900KXVAGH/ET	219.0	250

Essential type (Heat pump)

Model	MCA	MFA
AM100MXVDGH/ET	21.1	32
AM120MXVDGH/ET	25.0	32
AM140MXVDGH/ET	25.0	32
AM160MXVDGH/ET	32.0	40
AM180MXVDGH/ET	39.2	50
AM200MXVDGH/ET	42.2	63
AM220MXVDGH/ET	46.1	63
AM240MXVDGH/ET	50.0	63
AM260MXVDGH/ET	50.0	63
AM280MXVDGH/ET	50.0	63
AM300MXVDGH/ET	64.2	75
AM320MXVDGH/ET	64.2	75
AM340MXVDGH/ET	71.2	80
AM360MXVDGH/ET	78.4	90
AM380MXVDGH/ET	75.0	90
AM400MXVDGH/ET	75.0	90

Premium compact type (Heat recovery)

Model	MCA	MFA
AM080JXVHGR/EU	18.0	25
AM100JXVHGR/EU	21.1	32
AM120JXVHGR/EU	25.0	32
AM140JXVHGR/ET	25.0	32
AM160JXVHGR/ET	32.0	40
AM180JXVHGR/ET	39.2	50
AM200JXVHGR/ET	42.0	63
AM220JXVHGR/ET	44.6	63
AM240MXVGNR/ET	55.0	63
AM260MXVGNR/ET	60.0	75
AM280MXVGNR/ET	67.0	75
AM300MXVANR/ET	73.0	80
AM320MXVGNR1ET	67.0	80
AM340MXVGNR1ET	69.6	80
AM360MXVGNR1ET	69.6	80
AM380MXVGNR1ET	76.6	90
AM400MXVGNR1ET	83.8	100
AM420MXVGNR1ET	86.6	100
AM440MXVGNR1ET	98.0	125
AM460MXVGNR1ET	105.0	125
AM480MXVGNR1ET	112.2	125
AM500MXVGNR1ET	115.0	150
AM520MXVGNR1ET	117.6	150
AM540MXVGNR1ET	128.0	150
AM560MXVGNR1ET	133.0	150
AM580MXVGNR1ET	140.0	175
AM600MXVGNR1ET	146.0	175
AM620MXVGNR1ET	140.0	175
AM640MXVGNR1ET	142.6	175
AM660MXVGNR1ET	142.6	175
AM680MXVGNR1ET	149.6	175
AM700MXVGNR1ET	156.8	175
AM720MXVGNR1ET	159.6	175
AM740MXVGNR1ET	162.2	200
AM760MXVGNR1ET	172.6	200
AM780MXVGNR1ET	177.6	200
AM800MXVGNR1ET	184.6	225
AM820MXVGNR1ET	190.6	225
AM840MXVGNR1ET	201.0	225
AM860MXVGNR1ET	206.0	250
AM880MXVGNR1ET	213.0	250
AM900MXVGNR1ET	219.0	250

Premium energy efficiency type (Heat recovery)

Model	MCA	MFA
AM080JXVHGR/EU	18.0	25
AM100JXVHGR/EU	21.1	32
AM120JXVHGR/EU	25.0	32
AM140JXVHGR/ET	25.0	32
AM160JXVHGR/ET	32.0	40
AM180JXVHGR/ET	39.2	50
AM200JXVHGR/ET	42.0	63
AM220MXVGNR2ET	46.1	63
AM240MXVGNR2ET	50.0	63
AM260MXVGNR2ET	57.2	63
AM280MXVGNR2ET	60.0	75
AM300MXVGNR2ET	64.2	75
AM320MXVGNR2ET	64.2	75
AM340MXVGNR2ET	75.2	90
AM360MXVGNR2ET	78.4	90
AM380MXVGNR2ET	81.2	90
AM400MXVGNR2ET	82.2	90
AM420MXVGNR2ET	85.0	100
AM440MXVGNR2ET	96.4	125
AM460MXVGNR2ET	99.2	125
AM480MXVGNR2ET	102.0	125
AM500MXVGNR2ET	103.4	125
AM520MXVGNR2ET	117.2	150
AM540MXVGNR2ET	120.0	150
AM560MXVGNR2ET	124.2	150
AM580MXVGNR2ET	133.0	150
AM600MXVGNR2ET	133.4	150
AM620MXVGNR2ET	135.6	150
AM640MXVGNR2ET	138.4	175
AM660MXVGNR2ET	142.6	175
AM680MXVGNR2ET	142.6	175
AM700MXVGNR2ET	156.4	175
AM720MXVGNR2ET	156.8	175
AM740MXVGNR2ET	159.6	175
AM760MXVGNR2ET	162.4	200
AM780MXVGNR2ET	165.2	200
AM800MXVGNR2ET	177.6	200
AM820MXVGNR2ET	180.4	200
AM840MXVGNR2ET	183.2	225
AM860MXVGNR2ET	185.8	225
AM880MXVGNR2ET	196.2	225
AM900MXVGNR2ET	201.2	225

Electrical wiring work

- ※ When installing outdoor units in module, select the power supply cable according to the sum of outdoor unit capacity. (Refer to the table for each model)
- ※ Power Supply cords of parts of appliances for outdoor use shall not be lighter than polychloroprene sheathed flexible cord. (Code designation IEC:60245 IEC 66 / CENELEC: H07RN-F)
Ex.) AM500×XVA××

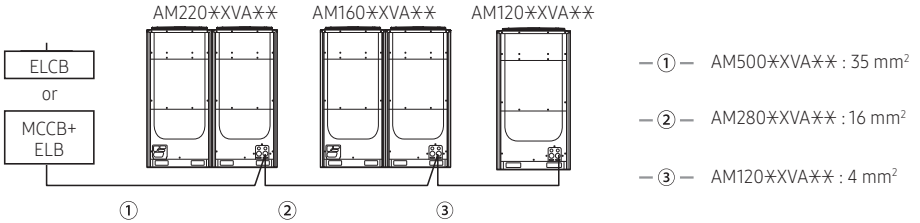



NOTE

- This device is intended for the connection to a power supply system with a maximum permissible system impedance shown in the table (on the left page) at the interface point (power service box) of the user's supply.
- The user must ensure that this device is connected only to a power supply system which fulfills the requirement above. If necessary, the user can ask the public power supply company for the system impedance at the interface point.
- This equipment complies with IEC 61000-3-12 provided that the short-circuit power S_{sc} is greater than or equal to $S_{sc}(*2)$ at the interface point between the user's supply and the public system. It is the responsibility of the installer or user of the equipment to ensure, by consultation with the distribution network operator if necessary, that the equipment is connected only to a supply with a short-circuit power S_{sc} greater than or equal to $S_{sc}(*2)$.

[$S_{sc}(*2)$]

Model	S_{sc} [MVA]
AM080JXVHGH/EU	3.1
AM100JXVHGH/EU	4.5
AM120JXVHGH/EU	5.3
AM140JXVHGH/ET	5.3
AM160JXVHGH/ET	6.6
AM180JXVHGH/ET	7.6
AM200JXVHGH/ET	8.0
AM220JXVHGH/ET	8.6
AM240KXVGGH/ET	12.5
AM260KXVGGH/ET	12.2
AM280KXVGGH/ET	13.6
AM080JXVHGR/EU	3.1
AM100JXVHGR/EU	4.5
AM120JXVHGR/EU	5.3
AM140JXVHGR/ET	5.3
AM160JXVHGR/ET	6.6
AM180JXVHGR/ET	7.6
AM200JXVHGR/ET	8.0
AM220JXVHGR/ET	8.6
AM240MXVGNR/ET	12.5
AM260MXVGNR/ET	12.2
AM280MXVGNR/ET	13.6
AM300MXVANR/ET	14.8
AM080JXVAGH/EU	3.1
AM100JXVAGH/EU	4.5
AM120JXVAGH/EU	5.3
AM140KXVAGH/ET	5.4
AM160KXVAGH/ET	7.2
AM180KXVAGH/ET	8.8

Model	S_{sc} [MVA]
AM200KXVAGH/ET	8.1
AM220KXVAGH/ET	8.6
AM240KXVAGH/ET	12.5
AM260KXVAGH/ET	12.2
AM280KXVAGH/ET	13.6
AM300KXVAGH/ET	14.8
AM100MXVDGH/ET	4.5
AM120MXVDGH/ET	5.3
AM140MXVDGH/ET	5.4
AM160MXVDGH/ET	7.2
AM180MXVDGH/ET	8.8

Electrical wiring work



Caution for electrical work

- You must install ELCB or MCCB + ELB
 - ELCB: Earth leakage breaker
 - MCCB: Molded case circuit breaker
 - ELB: Earth leakage breaker
- Do not operate the outdoor unit before completing the refrigerant pipe work.
- Do not disconnect or change the cable inside the product. It may cause damage to the product.
- Specification of the power cable is selected based on following installation condition; culvert installation/ ambient temperature 30 °C/ single multi conductor cables. If the condition is different from the ones stated, please consult an electrical installation expert and re-select the power cable.
 - If the length of power cable exceed 50m, re-select the power cable considering the voltage drop.
- Use a power cable made out of incombustible material for the insulator (inner cover) and the sheath (outer cover).
- Do not use the power cable with the core wire exposed due to insulator damage occurred during removal of the sheath. When the core wire is exposed, it may cause fire.

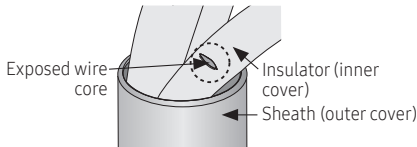

<The example of exposed core wire>

Power and communication cable configuration

- ▶ Main power and the ground cable must be withdrawn through the knock-out hole on the bottom-right or right side of the cabinet.
- ▶ Withdraw the communication cable from the designated knock-out hole on the bottom-right side of the front part.
- ▶ Install the power and communication cable using separate cable protection tube.
- ▶ Fix a protection tube to the knock-out hole on the outdoor unit by using a CD connector or bushing. Make sure to use insulating bushing.

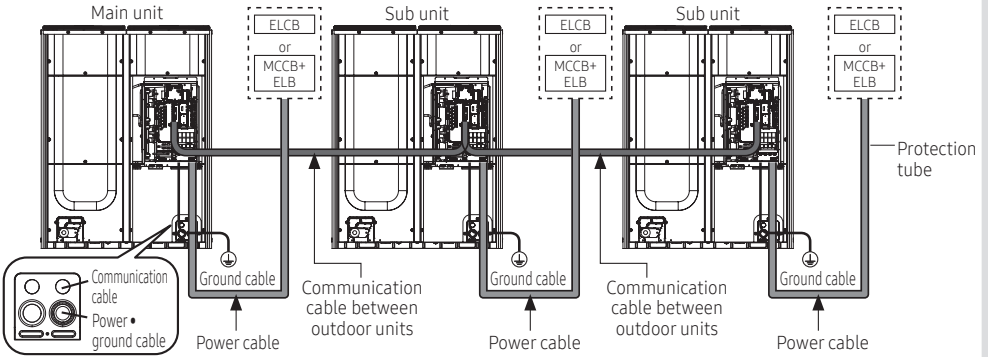

<When the module combination is in the tables of "Outdoor unit combination">

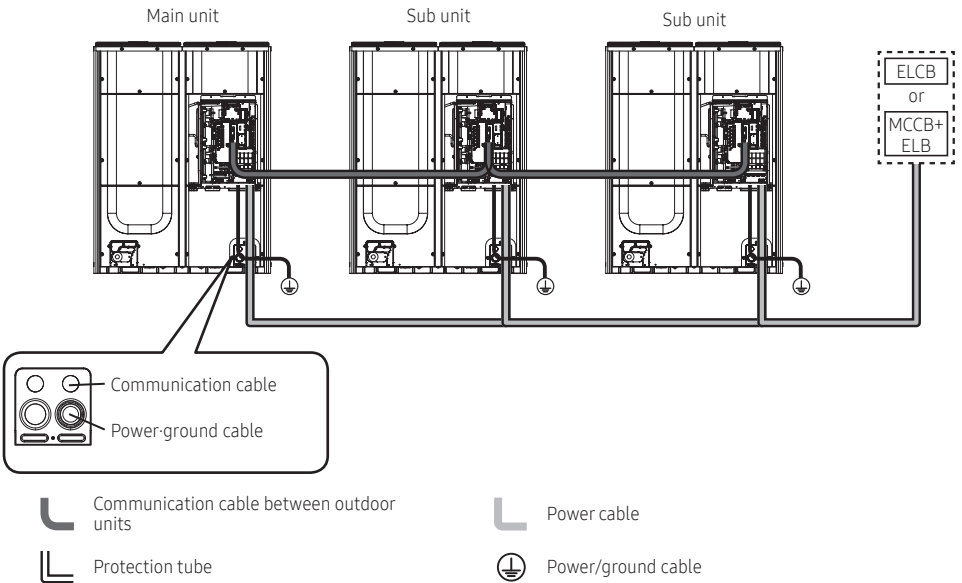

※ Power Supply cords of parts of appliances for outdoor use shall not be lighter than polychloroprene sheathed flexible cord. (Code designation IEC:60245 IEC 66 / CENELEC: H07RN-F)

Electrical wiring work

Specification of the protection tube

Name	Temper grade	Applicable conditions
Flexible PVC conduit	PVC	When the protection tube is installed indoor and not exposed to outside, because it is embedded in concrete structure
Class 1 flexible conduit	Galvanized steel sheet	When the protection tube is installed indoor but exposed to outside so there are risk of damage to the protection tube
Class 1 PVC coated flexible conduit	Galvanized steel sheet and Soft PVC compound	When the protection tube is installed outdoor and exposed to outside so there are risk of damage to the protection tube and extra waterproof is needed



Caution for perforating the knock-out hole

- Perforate a knock-out hole by punching it with a hammer.
- After perforating the knock-out hole, apply rust resisting paint around the hole.
- When you need to pass the cables through the knock-out hole, remove burrs on the hole and protection the cable with a protection tape or bushing etc.

Caution for installing communication cable

- When you connect the cable, it may sag and pressed by other parts. Therefore cables should be fixed to a clamp highlighted with a box on the illustration.

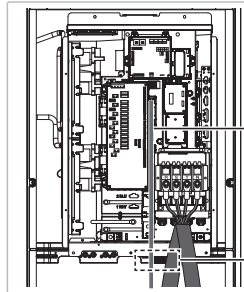

Path for arranging external communication cable

Fixing location of the external communication cable

Power wiring diagram

Supplying 3 phase 4 wires (380-415 V~)

<When the module combination is in the tables of "Outdoor unit combination">

3 phase 4 wires
(380-415 V~)

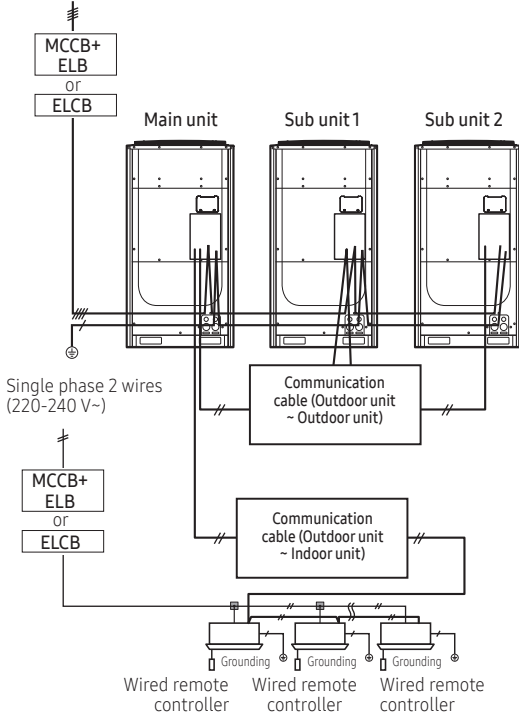

Single phase 2 wires
(220-240 V~)

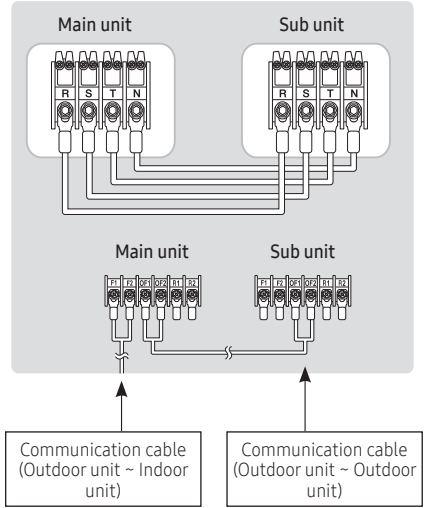
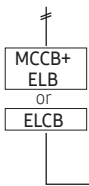

Electrical wiring work

<When the module combination is not in the tables of “Outdoor unit combination”>

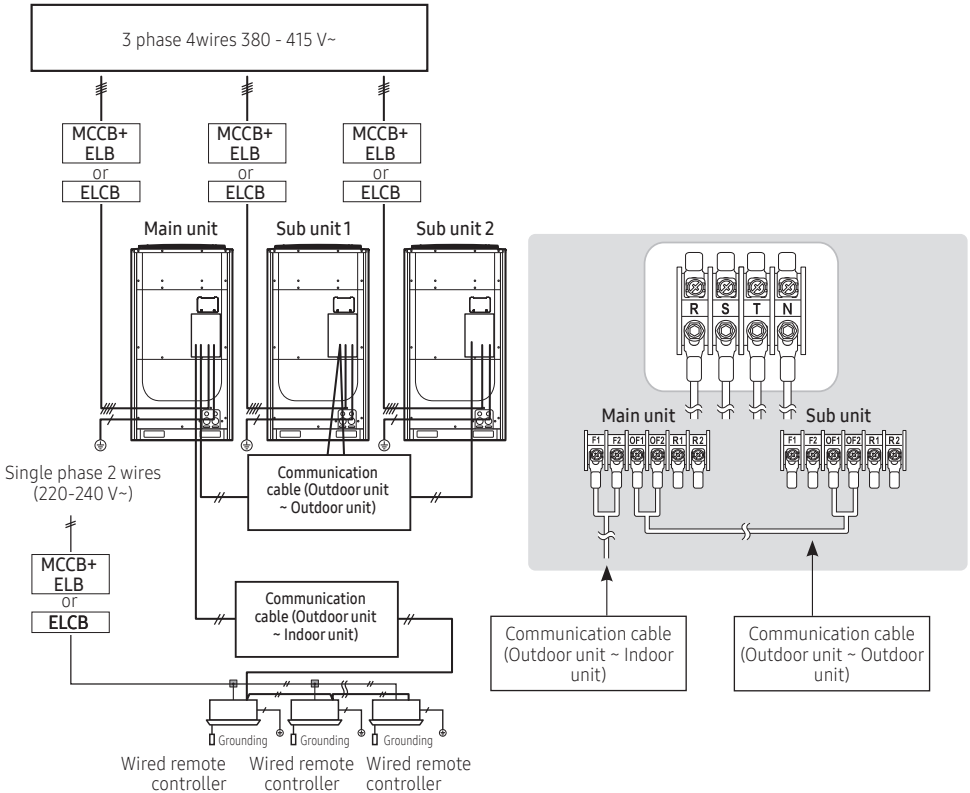

- ▶ Connect a power cable of the outdoor unit after checking that R-S-T-N (3 phase 4 wire) is properly connected. (If the 380-415 V power is supplied to the N phase, PCB and other electrical part will be damaged.)
- ▶ Communication cable between indoor and outdoor units and communication cable between Sub outdoor units has no polarity.
- ▶ Arrange the cables with a cable tie.
- ※ ELCB and ELB must be installed since there is risk of electric shock or fire when they are not installed.

Selecting solderless ring terminal

- ▶ Select a solderless ring terminal for a power cable according to the nominal dimensions for cable.
- ▶ Apply insulation coating to the connection part of the solderless ring terminal and the power cable.

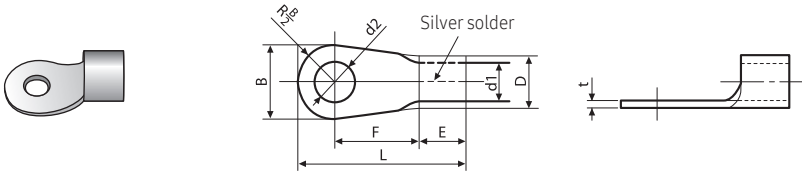

Nominal dimensions for cable (mm ²)		4/6	10	16	25		35		50	70
Nominal dimensions for screw (mm)		4	8	8	8	8	8	8	8	8
B	Standard dimension (mm)	9,5	15	15	16	12	16,5	16	22	24
	Allowance (mm)	±0.2	±0.2	±0.2	±0.2	±0.3	±0.3	±0.3	±0.3	±0.4
D	Standard dimension (mm)	5.6	7.1	9	11.5	13.3	13.5	17.5		
	Allowance (mm)	+0.3 -0.2	+0.3 -0.2	+0.3 -0.2	+0.5 -0.2	+0.5 -0.2	+0.5 -0.2	+0.5 -0.4		
d1	Standard dimension (mm)	3.4	4.5	5.8	7.7	9.4	11.4	13.3		
	Allowance (mm)	±0.2	±0.2	±0.2	±0.2	±0.2	±0.3	±0.4		
E	Min. (mm)	6	7.9	9.5	11	12.5	17.5	18.5		
F	Min. (mm)	5	9	9	13	15	13	14	20	
L	Max. (mm)	20	28.5	30	33	34	38	43	50	51
d2	Standard dimension (mm)	4.3	8.4	8.4	8.4	8.4	8.4	8.4	8.4	8.4
	Allowance (mm)	+ 0.2 0	+ 0.4 0	+ 0.4 0	+ 0.4 0	+ 0.4 0	+ 0.4 0	+ 0.4 0	+ 0.4 0	+ 0.4 0
t	Min. (mm)	0.9	1.15	1.45	1.7	1.8	1.8	2.0		

Electrical wiring work

Connecting the power terminal

- ▶ Connect the cables to the terminal board with solderless ring terminals.
- ▶ Properly connect the cables by using certified and rated cables and make sure to fix them properly so that external force is not applied to the terminal.
- ▶ Use a driver and wrench that can apply the rated torque when tightening the screws on the terminal board.
- ▶ Tighten the terminal screws by complying rated torque value. If the terminal is loose, fire can occur due to arc heat generation and if the terminal is too tight, terminal board could get damaged.

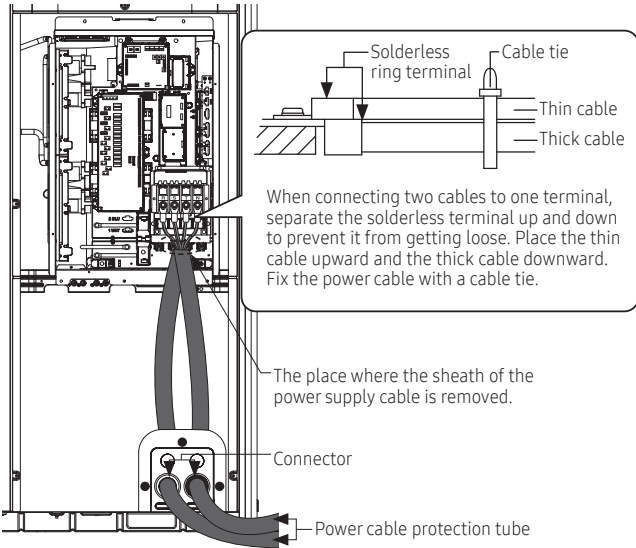

When connecting two cables to one terminal, separate the solderless terminal up and down to prevent it from getting loose. Place the thin cable upward and the thick cable downward. Fix the power cable with a cable tie.

Screw	Tightening torque for terminal (N·m)	
M4	1.2~1.8	Single phase (220-240 V) power cable
M8	5.5~7.3	3 phase (380-415 V) power cable



- When removing the outer sheath of the power supply cable, be careful not to scratch the inner sheath of the cable.
- Make sure that more than 20mm of the outer sheath of the indoor unit power and communication cable are inside the electrical component box.
- Install the communication cable separately from power cable and other communication cables.

Examples of how to use the cable stripper

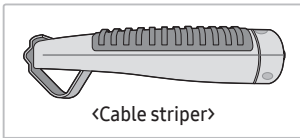

1. Adjust the blade position by coin. (Controller is at the bottom side of the tool.) Fix the blade position according to the outer sheath thickness of the power cable.
2. Fix the power cable and tool by using the hook at the top side of the tool.
3. Cut out the outer sheath of the power cable by revolving the tool in the direction of the arrow, two or three times.
4. At this situation, cut out the outer sheath of the power cable by moving the tool toward the direction of the arrow.
5. Slightly bend the wire and pull out the cut part of the outer sheath.

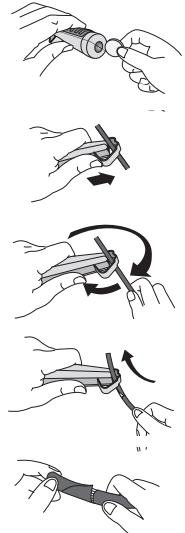

Fixing the power cable

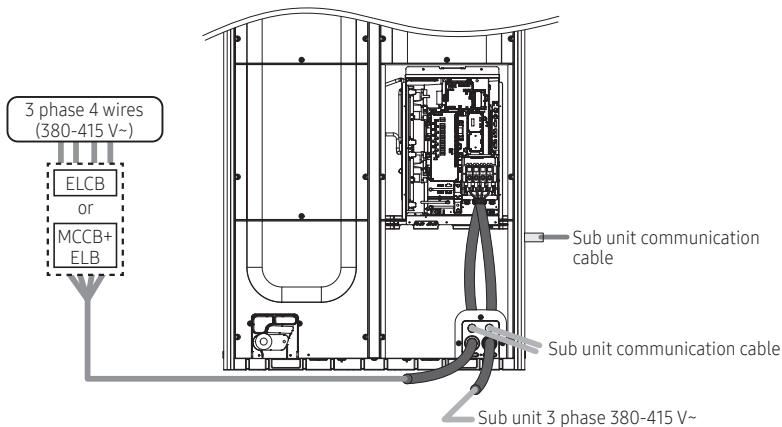

Electrical wiring work



- Do not let the power cable come into contact with the pipes inside the outdoor unit. If the power supply cable touches the pipes, the vibration of the compressor is transferred to the pipes and can damage the power supply cables or pipes, creating the danger of fire or explosion.
- Make sure that the place where the sheath of power supply cable is removed is inside the power supply box. If it is impossible, you should connect the protection tube for power cable to the power supply box.
- After arranging the power cable into the power supply box, tighten the cover.

Connect the ring terminal of 3 phase cable

1. Cut the power cable to an appropriate length and connect it with the solderless terminal.
2. After connecting the power cable to the terminal as seen in the illustration, fix it with cable tie.
3. Fix the housing, which has an insulator, to the terminal board.

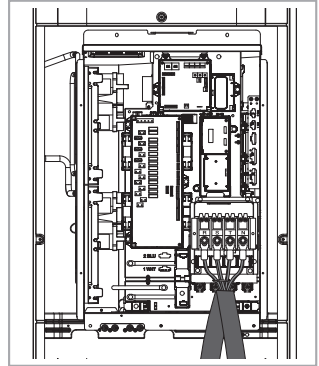

Fixing the ground cable

- ▶ Connect the ground cable to the grounding hole inside the power supply box.

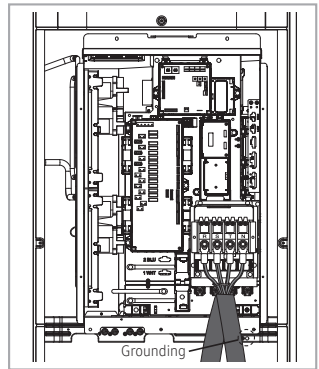

Withdrawing the power cable

- ▶ Withdrawing from the front side
 - Connect the power cable protection tube into the power supply box as shown picture.
 - Be sure that the power supply cable is not damaged by burr on the knock-out hole.

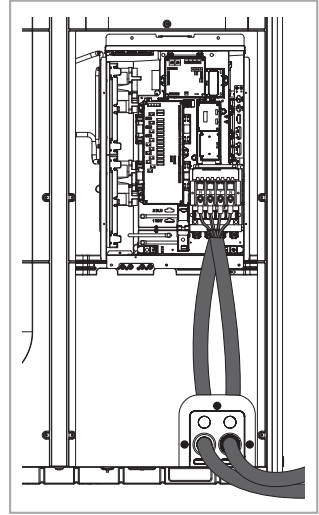

Installing the Solution device

- ▶ When the number of indoor units installed with the outdoor unit is 16 or less

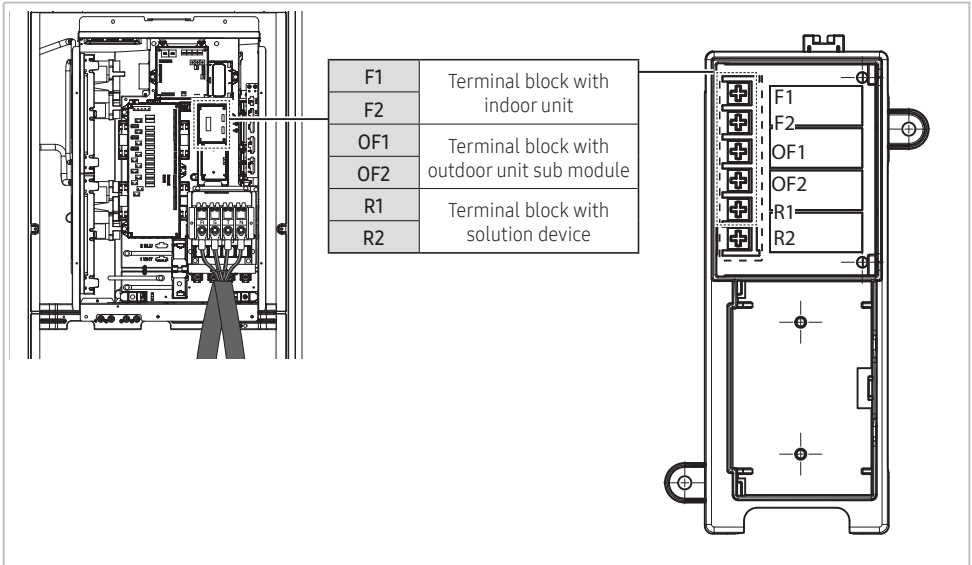

Electrical wiring work

Connecting the MCU (MCU-S6NEE1N, MCU-S4NEE1N, MCU-S4NEE2N, MCU-S2NEK1N)

Example 1

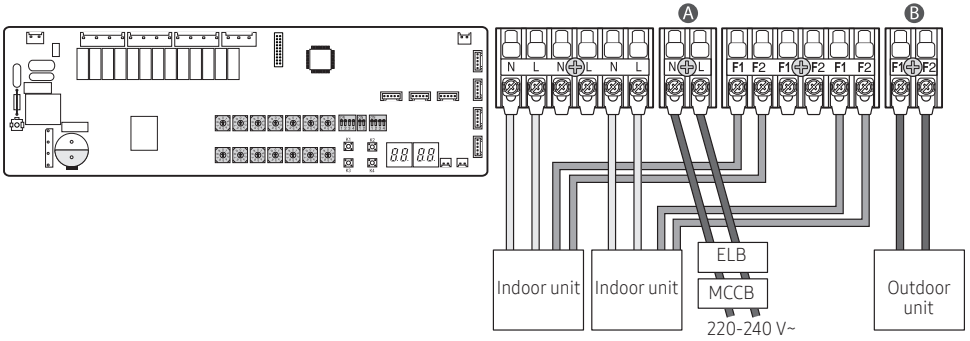

Example 2

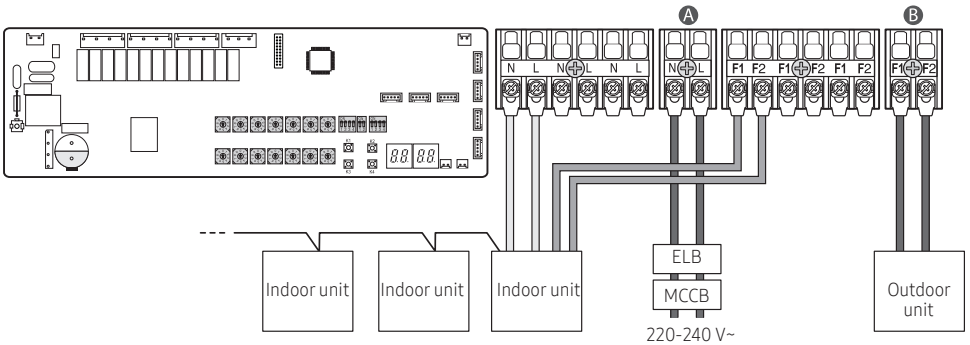

- ▶ **A** Power must be supplied to the MCU separately from the outdoor unit.
- ▶ **B** Connect the communication cable of the outdoor unit (F1, F2) to the communication cable of the MCU (F1, F2)

CAUTION Power cable connection should be done with the solderless ring terminal.

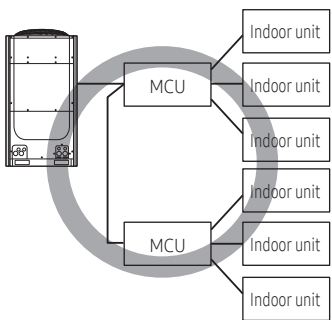
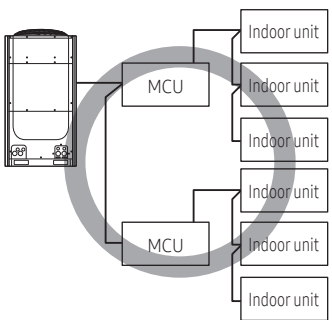
• When installing the MCU, communication cable can be connected as shown above.

Connecting the MCU (MCU-S6NEK2N, MCU-S4NEK3N, MCU-S2NEK2N, MCU-S1NEK1N)

Example

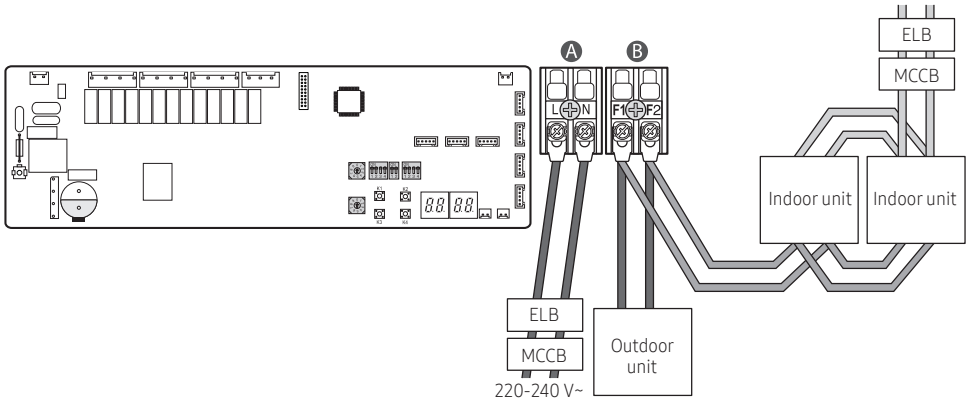

- ▶ **A** Power must be supplied to the MCU separately from the outdoor unit.
- ▶ **B** Connect the communication cable of the outdoor unit (F1, F2) to the communication cable of the MCU (F1, F2)



• Power cable connection should be done with the solderless ring terminal.

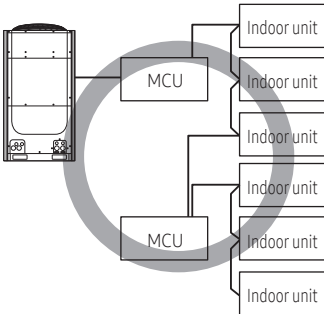

- When installing the MCU, communication cable can be connected as shown above.

Electrical wiring work

Grounding work

Grounding must be done by a qualified installer for your safety.

Grounding the power cable

- ▶ The standard of grounding may vary according to the rated voltage and installation place of the air conditioner.
- ▶ Ground the power cable according to the following table.

Installation place \ Power condition	Voltage to ground is lower than 150V	Voltage to ground is over 150V
	High humidity	Must perform the grounding work 3. ^{Note 1)} (Including the case where earth leakage breaker is installed)
Average humidity	Perform grounding work 3. ^{Note 1)}	Must perform the grounding work 3. ^{Note 1)} (Including the case where earth leakage breaker is installed)
Low humidity	Perform grounding work 3, if possible, for your safety. ^{Note 2)}	

Note 1) About grounding work 3.

- Grounding work must be done by an expert (with qualification).
- Check if the grounding resistance is lower than 100Ω. When installing an earth leakage breaker (that can cut the electric circuit within 0.5 second in case of a short circuit), allowable grounding resistance should be 30~500Ω.

Note 2) Grounding at dry place

- The grounding resistance should be lower than 100Ω. Even in worst case, grounding resistance should be lower than 250Ω.

Performing the grounding work

- ▶ Use a rated grounding cable by referring to the specification of the electric cable for the outdoor unit.
 - ※ When using the exclusive grounding terminal (When the grounding terminal is already built on the house)
- ※ When using grounding of the switch board

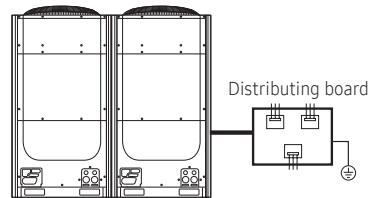
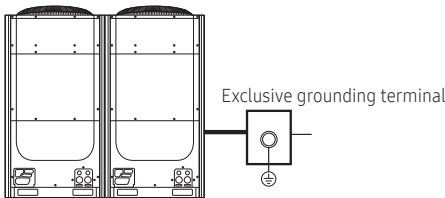

Air tightness test and vacuum drying

Air tightness test

- ▶ Use tools for R-410A to prevent the inflow of foreign substances and resist against the internal pressure.
- ▶ Do not remove the core of filling port.
- ▶ Use Nitrogen gas for air tightness test as shown in the illustration.

H/P

H/R

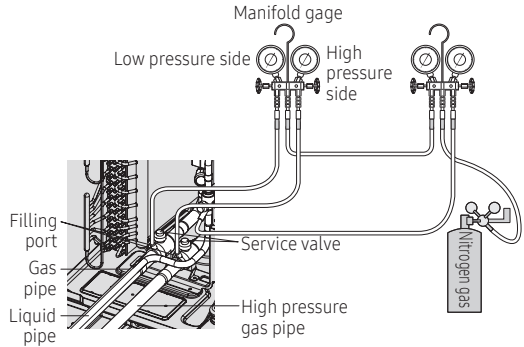
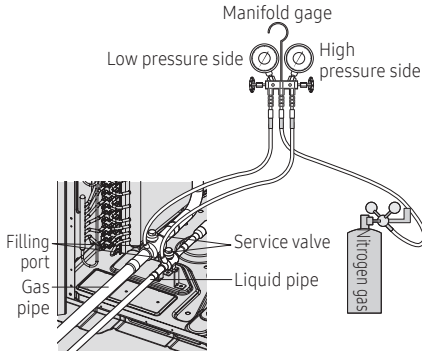

Apply pressure to the liquid side pipe and gas side pipe (when installing outdoor units in module) with Nitrogen gas at 4.1MPa.

If you apply pressure at more than 4.1MPa, pipes may get damaged. Apply pressure with pressure regulator and pay attention to the pressure of the nitrogen.

Keep it for minimum 24 hours to check if pressure drops.

After applying Nitrogen gas, check there's any change of pressure, using a pressure regulator.

If the pressure drops, check for gas leakage.

If the pressure is changed, apply soap water to check for leakage and check the pressure of the nitrogen gas again.

Maintain 1.0MPa of the pressure before performing vacuum drying and check for further gas leakage.

After checking the first gas leakage, maintain 1.0MPa to check for further gas leakage.



- Perform a Nitrogen gas leak test with the service valve of the outdoor unit closed.
- When charging the nitrogen gas, charge it from the both (high•low pressure) sides.
- If the pipe is filled in a short time with a highly excessive pressure of Nitrogen gas, the pipes may get damaged. Make sure to use a regulator to prevent the high pressure Nitrogen gas, over 4.1MPa, from entering into the pipe.

Air tightness test and vacuum drying

Vacuum drying pipes and indoor units

- ▶ Use tools for R-410A to prevent the inflow of foreign substances and resist against the internal pressure.
- ▶ Use vacuum pump that allows vacuuming under -100.7kPa (5 Torr).
- ▶ Use the vacuum pump with the check valve to prevent pump oil from flowing backward while the vacuum pump is stopped.
- ▶ Completely close the liquid gas side service valve of the outdoor unit.

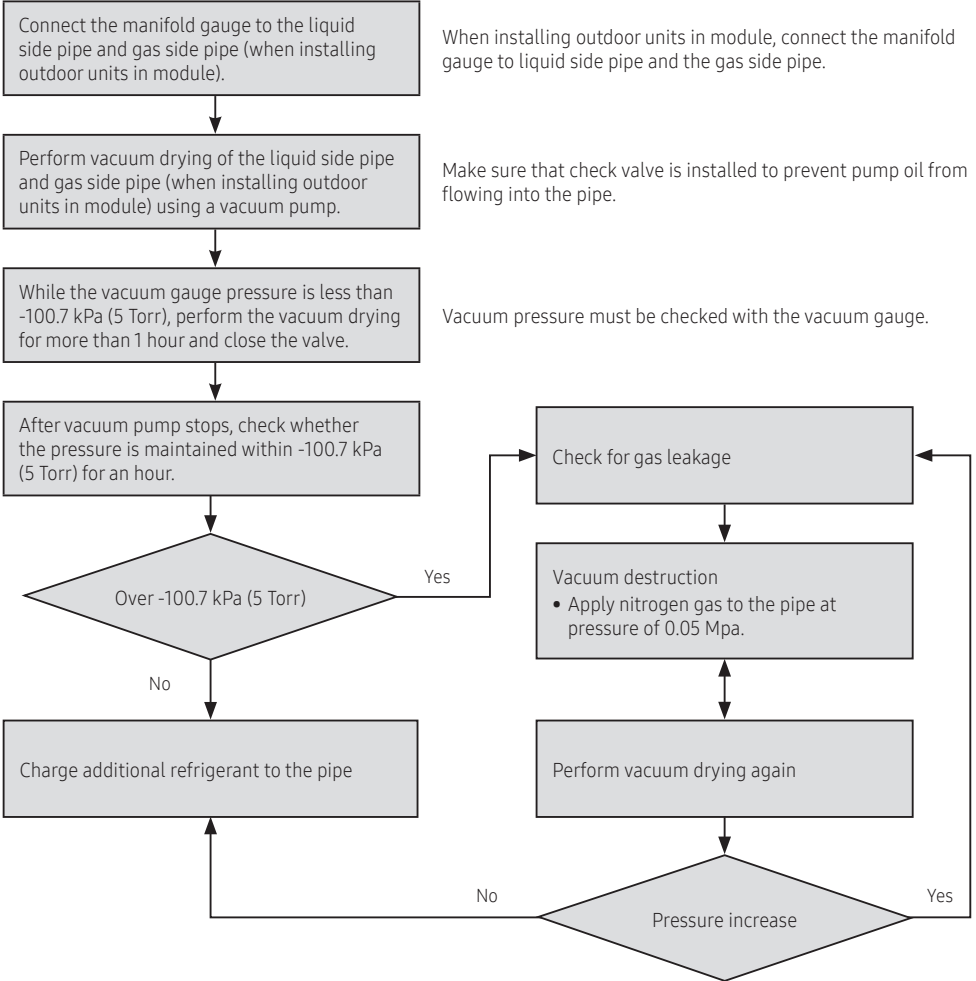

- ※ If the pressure rises in an hour, either water is remaining inside the pipe or there is a leakage.
- ※ When the ambient temperature of vacuuming pipe is low (less than $0\text{ }^{\circ}\text{C}$), moisture might remain within the pipe. Therefore, pay special attention to the pipe sealing in the winter.

Pipe insulation

Insulating the refrigerant pipes and branch joints

- ▶ Check for gas leakage before completing (the hose and pipe insulation) and if there is no sign of leakage, make sure to insulate the pipes and hoses.
- ▶ Use EPDM material insulator that meets the following conditions.

Test item	Unit	Standard
Density	g/cm ³	0.048~0.096
Dimensional change rate by heat	%	Below -5
Absorption rate	g/cm ³	Below 0.005
Thermal conduction rate	W/m·K	Below 0.037
Moisture transpiration factor	ng/(m ² ·s·Pa)	Below 15
Moisture transpiration grade	g/(m ² ·24h)	Below 15
Formaldehyde dispersion	mg/L	There should be none
Oxygen rate	%	Over 25

Selecting the refrigerant pipe insulator

- ▶ Insulate the gas pipe and liquid pipe by referring to the thickness of insulator for each pipe size.
- ▶ The standard condition is; temperature at 30°C, humidity less than 85%. If case if the humidity is higher, you must increase the size by one grade as stated in below table.

Pipe	Diameter of refrigerant pipe	Insulator (Cooling·Heating)		Remarks
		General [30 °C, 85 %]	High humidity [30 °C, over 85 %]	
		EPDM, NBR		
Liquid pipe	∅ 6.35~∅ 9.52	9 mm	←	Heat resisting temperature over 120°C
	∅ 12.7~∅ 50.80	13 mm	←	
Gas pipe	∅ 6.35	13 mm	19 mm	
	∅ 9.52 ~ ∅ 25.40	19 mm	25 mm	
	∅ 28.58 ~ ∅ 44.45		32 mm	
	∅ 50.80	25 mm	38 mm	

- ※ When installing insulation in places and conditions below, use the same insulation that is used for high humidity conditions.
- <Geological condition>
- High humidity places such as shoreline, hot spring, near lake or river, and ridge (when the part of the building is covered by earth and sand.)
- <Operation purpose condition>
- Restaurant ceiling, sauna, swimming pool etc.
- <Building construction condition>
- The ceiling frequently exposed to moisture and cooling is not covered. (e.g. The pipe installed at a corridor of a dormitory and studio or near an exit that opens and closes frequently.)
 - The place where the pipe is installed is highly humid due to the lack of ventilation system.

Pipe insulation

Insulate the refrigerant pipe

- ▶ Make sure to insulate the refrigerant pipe, branch joint, distribution header, and the connection part of the pipes.
- ▶ If you insulate the pipes, condensed water will not fall from the pipes.
- ▶ Check if there are any cracks on the insulation at the bent part of the pipe.

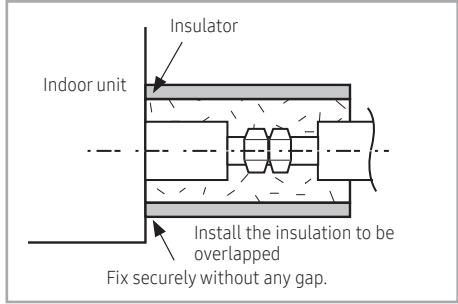
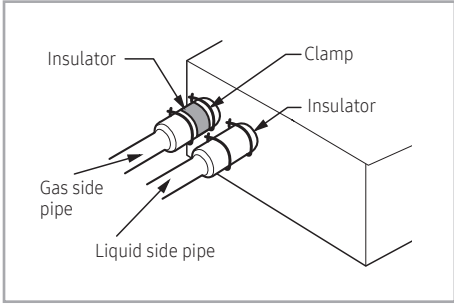

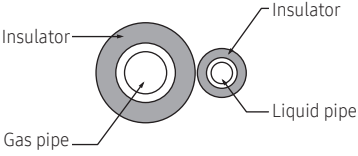
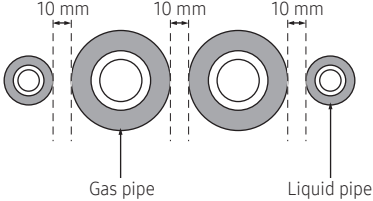
Insulating pipes	Insulating pipes connected behind the EEV kit
<ul style="list-style-type: none"> • The insulation of the gas and liquid pipes can be in contact with each other but they should not press excessively against each other. • When the gas side and liquid side pipes are contacting each other, increase the thickness of the insulation by one grade. 	<ul style="list-style-type: none"> • When installing the gas side and liquid side pipes, leave at least 10mm of space. • When the gas side and liquid side pipes are contacting each other, increase the thickness of the insulation by one grade. 



- Install the insulation without any gaps or cracks and use adhesive on the connection part of it to prevent moisture from entering.
- Bind the refrigerant pipe with insulation tape if it is exposed to outside sunlight. (When binding the pipe with finishing tape, be careful not to reduce the thickness of the insulation.)
- Install the refrigerant pipe respecting that the insulation does not get thinner on the bent part or hanger of pipe.
- When the thickness of insulation is reduced, reinforce the reduced thickness with additional insulation.

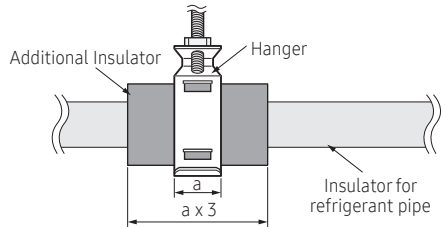

Insulate the distribution header

- ▶ Fix the distribution header with a cable tie and cover the connected part.
- ▶ Insulate the distribution header and the welded part and wrap the connected part with an adhesive insulation tape to prevent dew formation.

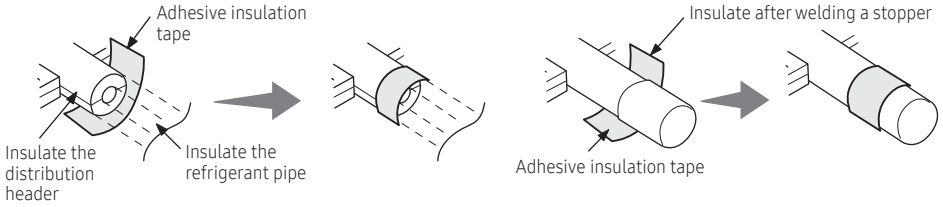
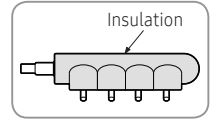

- ▶ Fix the distribution header with a hanger after insulating it.

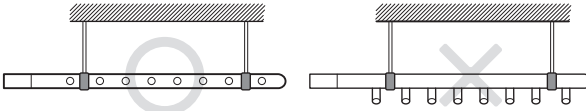

Insulating the branch joint

- ▶ Tightly attach the insulator, provided with the branch joint, to the separately purchased insulator. Wrap the connected part with an insulator (separately purchased item) that has thickness of at least 10mm.
- ▶ Use an insulator that resist heat up to 120°C. Wrap the branch joint with an insulation that has thickness of at least 10mm.

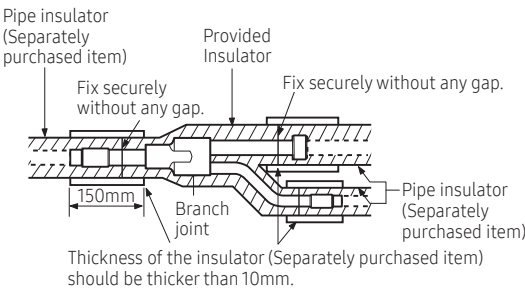

Insulation tape (Separately purchased item)

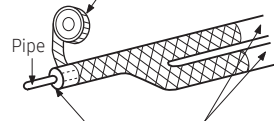

Pipe insulator (Separately purchased item)

- ※ Attach the adhesive insulation tape to the pipe, as shown in the picture, after insulating the pipe.

Pipe insulation

Insulating the pipe located inside of the outdoor unit

- ▶ With a pipe insulator, insulate the pipe up to whole service valve located inside of the outdoor unit.
- ▶ Seal the gap between the outdoor unit pipe and the insulator. Rainwater and dewdrops may soak through the gap between the pipe and the insulation of the outdoor unit installed on the outside.
- ▶ Separate the cover of the pipe and close it after insulation work. Only remove a knock-out hole cover where the pipe will be installed. If the knock-out hole is open unnecessarily, it must be closed. If not, small animals such as squirrels and rats may get into the unit through the hole and the unit may be damaged.

H/P

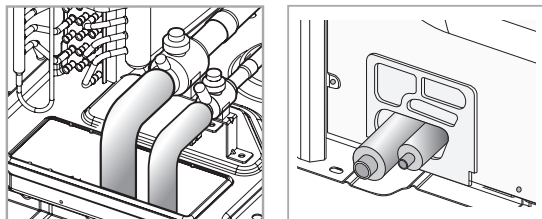

H/R

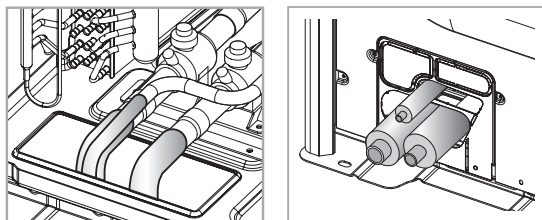

Charging refrigerant

- ▶ The R410A refrigerant is blended refrigerant. Add only liquid refrigerant.
- ▶ Measure the quantity of the refrigerant according to the length of the liquid side pipe. Add quantity of the refrigerant using a scale.

Important information: regulation regarding the refrigerant used

This product contains fluorinated greenhouse gases. Do not vent gases into the atmosphere.



- Inform user if the system contains 5 tCO₂e or more of fluorinated greenhouse gases. In this case, it must be checked for leakage at least once every 12 months, according to regulation No. 517/2014. This activity must be covered by qualified personnel only. In the case of the situation above, the installer (or authorized person with responsibility for final check) must provide a maintenance book, with all the information recorded, according to REGULATION (EU) No. 517/2014 OF THE EUROPEAN PARLIAMENT AND OF THE COUNCIL of 16 April 2014 on fluorinated greenhouse gases.

Charging refrigerant

Please fill in the following with indelible ink on the refrigerant charge label supplied with this product and on this manual.

- ▶ ① : The factory refrigerant charge of the product.
- ▶ ② : The additional refrigerant amount charged in the field.
- ▶ ① + ② : The total refrigerant charge.

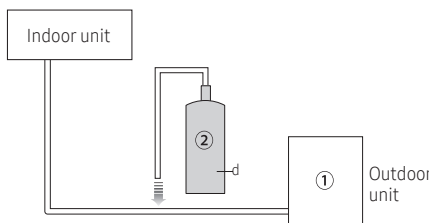

Unit	Kg	tCO ₂ e
①, a		
②, b		
①+②, c		

Refrigerant type	GWP value
R-410A	2088

- GWP=Global Warming Potential
- Calculating tCO₂e : kg x GWP / 1000

NOTE

- a Factory refrigerant charge of the product: see unit name plate.
- b Additional refrigerant amount charged in the field. (Refer to the above information for the quantity of refrigerant replenishment.)
- c Total refrigerant charge.
- d Refrigerant cylinder and manifold for charging.

CAUTION

- The filled-out label must be adhered in the proximity of the product charging port. (ex. onto the inside of the stop valve cover.)

Single installation

- ▶ Open the manifold gauge valve connected to the liquid side service valve and add the liquid refrigerant.
- ▶ If you cannot add the whole quantity of the refrigerant while the outdoor unit is stopped, open the gas side and liquid side service valve. Then, add remaining refrigerant by pressing the refrigerant adding button of the outdoor PCB.

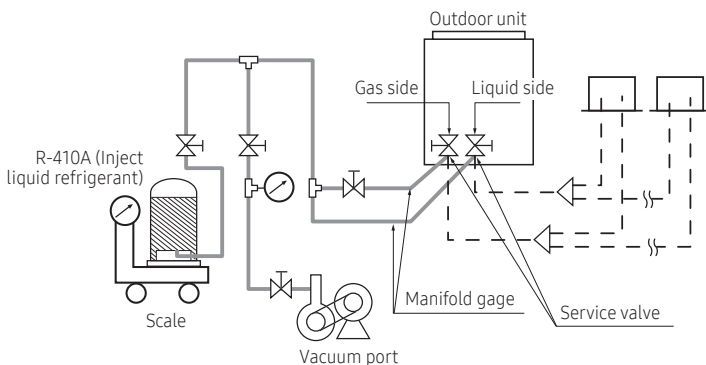

Charging refrigerant

Module installation

- ▶ Open the manifold gauge valve connected to the liquid side service valve and add the liquid refrigerant.
- ▶ If you cannot add the whole quantity of the refrigerant while the outdoor unit is stopped, open the gas side and liquid side service valve. Then, add remaining refrigerant by pressing the refrigerant adding button of the outdoor PCB.
- ▶ If you use the refrigerant charging function from the PCB, outdoor unit will operate and charge the refrigerant. At this time, you must use gas side manifold gauge for cooling operation and use charging port for heating at the manifold gauge for heating operation.

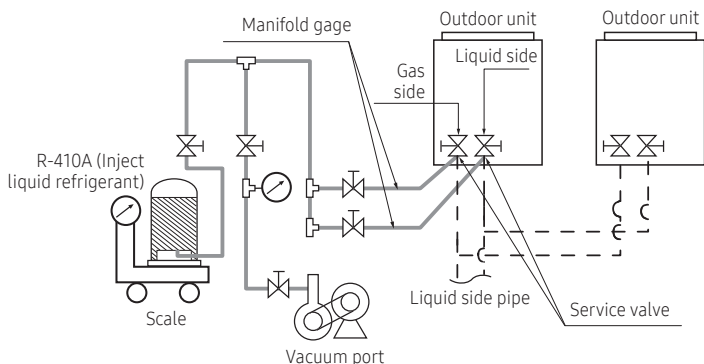

- Open the gas side and liquid side service valve completely after charging the refrigerant. (If you operate the air conditioner with the service valve closed, the important parts may be damaged.)
- Put on safety equipment when charging refrigerant.
- Do not charge the refrigerant when you adjust or control other product such as indoor units or EEV kits.
- If you charge the refrigerant with the front cabinet open, be very careful with the fan on the top of the product to prevent personal injury.
- When the ambient temperature is low in winter time, do not heat the refrigerant container to speed up the charging process. There is risk of explosion.
- Beware for possibility of refrigerant leakage when you connect the manifold gauge to the charging port for heating.
- Close the valve of the refrigerant container immediately after charging the refrigerant. If not, there might be a change in entire amount of refrigerant.

Using service valve for gas

- ▶ After charging the refrigerant, close all caps as shown in the illustration.
- ▶ Tightening torque for the cap of refrigerant charging port 10~12 N·m
- ▶ Tightening torque for the cap of control part 20~25 N·m
- ▶ Opening/closing torque for the valve
 - Over $\varnothing 19.05$: 10.0 N·m

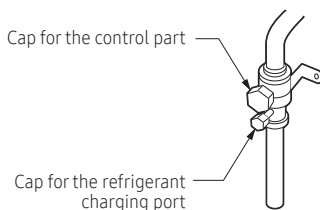

Basic segment display

Step	Display content	Display			
At initial power input	Checking segment display	SEG 1	SEG 2	SEG 3	SEG 4
		"8"	"8"	"8"	"8"
While setting communication between indoor and outdoor unit (Addressing)	Number of connected indoor units	SEG 1	SEG 2	SEG 3	SEG 4
		"A"	"d"	Number of communicated units * Refer to "View Mode" for communication address	
After communication setting (usual occasion)	MCU, Indoor unit address	SEG 1	SEG 2	SEG 3	SEG 4
		I/U: "A" MCU: "C"	I/U: "0" MCU: "1"	Reception address (in decimal number)	

* I/U : Indoor unit

Setting outdoor unit option switch and key function

Setting outdoor unit option switches : A TYPE

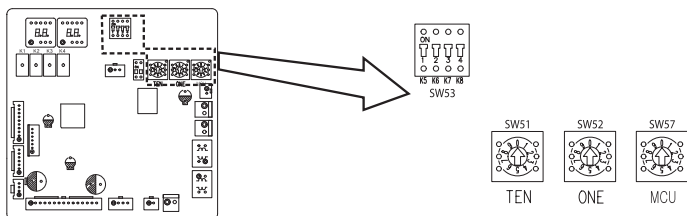

* If you install HR products, you must match the address between the MCU and the indoor unit.

Switch	Setting	Function	Remarks	
SW51 / SW52		Setting total number of installed indoor unit SW51: Tens digit, SW52: Units digit	Setting can be done from the main outdoor unit only (sub unit: setting is unnecessary) Ex) When 12 indoor units are installed → SW51: 1, SW52: 2	
SW53	K6	On	Enable maximum capacity restriction for cooling operation	Restrict excessive capacity increase when operating indoor units with small capacity
		Off	Disable maximum capacity restriction for cooling operation	-
	K7	K8	Selecting outdoor unit address	
	On	On	Outdoor unit address: No. 1	Main unit
	On	Off	Outdoor unit address: No. 2	Sub unit 1
	Off	On	Outdoor unit address: No. 3	Sub unit 2
SW57		Off	Outdoor unit address: No. 4	Sub unit 3
			Setting total number of connected MCU	Setting can be done from Main unit only. Ex) When 3 MCUs are installed → SW57:3, When 10 MCUs are installed → SW57:A

Setting outdoor unit option switch and key function

Setting outdoor unit option switches : B TYPE

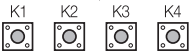
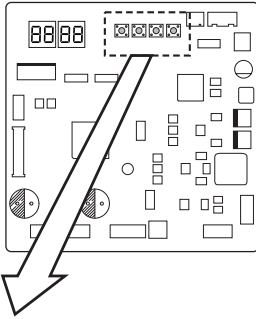

► Setting outdoor install option

Step	Button	Display	Description	Note
Outdoor unit address				
Step1	Outdoor unit display	od nd	Setting required	-
Step2	Press (K1+K2) for 2 seconds	od 00	Unit address for module combination	00: Main unit
	K4 x 1 time	od 01		01: Sub1 unit
	K4 x 2 times	od 02		02: Sub2 unit
	K4 x 3 times	od 03		03: Sub3 unit
Step3	If it is main unit, go to step4. Otherwise, press K2 button for 2 seconds to save & exit (system will be reset)			
Quantity of indoor units				
Step4	Press K1	nd 00	Ready to set	-
Step5	K2 x n times	nd X0	Tens digit (0 ~ 6)	Ex) 03: 3 units 64: 64 units
	K4 x n times	nd 0X	Ones digit (0 ~ 9)	
* K4: Press for 2 seconds - automatic detection of indoor units' quantity				
Step6	If it is heat recovery model, go to step 7. Otherwise, press K2 button for 2 seconds to save & exit (system will be reset)			
Quantity of MCUs * Heat recovery model only				
Step7	Press K1	nc 00	Ready to set	-
Step8	K2 x n times	nc X0	Tens digit (0 ~ 1)	Ex) 03: 3 units 16: 16 units
	K4 x n times	nc 0X	Ones digit (0 ~ 9)	
* K4: Press for 2 seconds - automatic detection of MCUs' quantity				
Step9	K2: long	88 00	Save	Restart
* Press K1 for 2 seconds to exit without save regardless of setting step.				

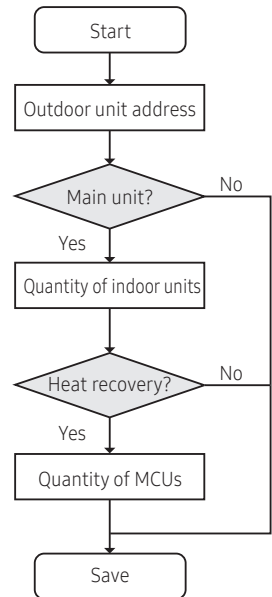

Installing and setting the option with tact switch and explanation of the functions

Setting the option

1. Press and hold K2 to enter the option setting. (Only available when the operation is stopped)
 - If you enter the option setting, display will show the following. (If you have set the 'Emergency operation for compressor malfunction', 1 or 2 will be displayed on Seg 4.)

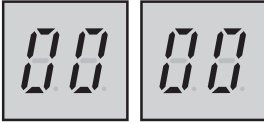

- Seg 1 and Seg 2 will display the number for selected option.
 - Seg 3 and Seg 4 will display the number for set value of the selected option.
2. If you have entered option setting, you can shortly press the K1 switch to adjust the value of the Seg 1, Seg 2 and select the desired option. (Refer to pages 81~83 for the Seg number of the function for each option)

Example)

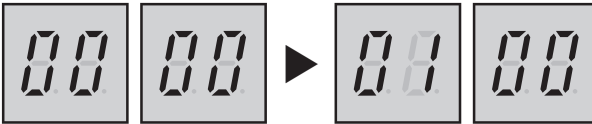

3. If you have selected desired option, you can shortly press the K2 switch to adjust the value of the Seg 3, Seg 4 and change the function for the selected option. (Refer to pages 81~83 for the Seg number of the function for each option)

Example)



4. After selecting the function for options, press and hold the K2 switch for 2 seconds. Edited value of the option will be saved when entire segments blinks and tracking mode begins.



• Edited option will not be saved if you do not end the option setting as explained in above instruction.

- ※ While you are setting the option, you may press and hold the K1 button to reset the value to previous setting.
- ※ If you want to restore the setting to factory default, press and hold the K4 button while you are in the option setting mode.
 - If you press and hold the K4 button, setting will be restored to factory default but it doesn't mean that restored setting is saved. Press and hold the K2 button. When the segments shows that tracking mode is in progress, setting will be saved.

Setting outdoor unit option switch and key function

Optional item	Input unit	SEG1	SEG2	SEG3	SEG4	Function of the option	Remarks
Emergency operation for compressor malfunction	Individual	0	0	0	0	Disabled (Factory default)	E560 will occur when all the compressors are set as malfunction state.
				0	1	Set compressor 1 as malfunction state	
				0	2	Set compressor 2 as malfunction state	
Cooling capacity correction	Main	0	1	0	0	7-9 (Factory default in case of A type PBA)	Targeted evaporation temperature [°C]. (When low temperature value is set, discharged air temperature of the indoor unit will decrease)
				0	1	5-7 (Factory default in case of B type PBA)	
				0	2	9-11	
				0	3	10-12	
				0	4	11-13	
				0	5	12-14	
Capacity correction for heating	Main	0	2	0	0	3.0 (Factory default)	Targeted high pressure [MPa]. (When low pressure value is set, discharged air temperature of the indoor unit will decrease)
				0	1	2.5	
				0	2	2.6	
				0	3	2.7	
				0	4	2.8	
				0	5	2.9	
				0	6	3.1	
				0	7	3.2	
Current restriction rate	Individual	0	3	0	0	100% (Factory default)	When restriction option is set, cooling and heating performance may decrease.
				0	1	95 %	
				0	2	90 %	
				0	3	85 %	
				0	4	80 %	
				0	5	75 %	
				0	6	70 %	
				0	7	65 %	
				0	8	60 %	
				1	0	50 %	
Oil collection interval	Main	0	4	0	0	Factory default	
				0	1	Shorten the interval by 1/2	
Temperature to trigger defrost operation	Main	0	5	0	0	Factory default	
				0	1	Apply setting when the product is being installed in humid area such as near river or lake	
Fan speed correction for outdoor unit	Individual	0	6	0	0	Factory default	Increase the outdoor unit's fan speed to maximum value
				0	1	Increase fan speed	

Optional item	Input unit	SEG1	SEG2	SEG3	SEG4	Function of the option	Remarks
Silent mode	Main	0	7	0	0	Disabled (Factory default)	Enables the silent mode for night-time in cooling mode (It operates automatically depending on the temperature.) However, if the external contact interface module (MIM-B14) is used, entering the silent mode is available with contact signal in cooling and heating mode. (A type PBA : this function is used in cooling mode.)
				0	1	LEVEL 1 / Auto	
				0	2	LEVEL 2 / Auto	
				0	3	LEVEL 3 / Auto	
				0	4	LEVEL 1 / External contact	
				0	5	LEVEL 2 / External contact	
High-head condition setting	Main	0	8	0	0	Disabled (Factory default)	
				0	1	Level 1 of height difference type 1 (Indoor unit is lower than outdoor unit)	When outdoor unit is located 40~80m above the indoor unit
				0	2	Level 2 of height difference type 1 (Indoor unit is lower than outdoor unit)	When outdoor unit is located over 80m above the indoor unit
				0	3	Height difference type 2 (Outdoor unit is lower than indoor unit)	When indoor unit is over 30 m above the outdoor unit
Long-piping condition setting (Setting is unnecessary if high-head condition is set)	Main	0	9	0	0	Disabled (Factory default)	
				0	1	LEVEL 1	When equivalent length of farthest indoor unit from the outdoor unit is between 100~170m
				0	2	LEVEL 2	When equivalent length of farthest indoor unit from the outdoor unit is over 170m
Energy saving setting (A Type PBA)	Main	1	0	0	0	Disabled (Factory default)	
				0	1	Enabled	Energy saving mode triggers when the room temperature reaches desired temperature while operating in heating mode.
Energy control operation (B Type PBA)	Main	1	0	0	0	Basic (Factory default)	Energy control option of designated operation sequence ※ Operating in energy saving mode, capacity might decrease compared to normal operation mode
				0	1	Energy saving	
				0	2	Power	
Rotation defrost (HR only)	Main	1	1	0	0	Disabled (Factory default)	
				0	1	Enabled	When enabled, continuous heating operation is possible but heating performance will decrease during rotation defrost operation

Setting outdoor unit option switch and key function

Optional item	Input unit	SEG1	SEG2	SEG3	SEG4	Function of the option	Remarks
Expand operational temperature range for cooling operation (HR only)	Main	1	2	0	0	Disabled (Factory default)	When enabled, continuous cooling operation is possible even in low temperature condition up to -15°C, but noise of the MCU will increase
				0	1	Enabled	
Channel address	Main	1	3	A	U	Automatic setting (Factory default)	Address for classifying the product from upper level controller (DMS, S-NET 3, etc.)
				0 ~ 15		Manual setting for channel 0~15	
Snow accumulation prevention control	Main	1	4	0	0	Enabled (Factory default)	During snow accumulation, the fan may spin even when the unit is not in operation
				0	1	Disabled	
Unused option	Main	1	5	0	0	Unused option	Unused option by this model
Unused option	Main	1	6	0	0	Unused option	Unused option by this model
Speed operation	Main	1	7	0	0	Disabled (Factory default)	Enabling this setting will command the air conditioner to cool/heat faster at initial start-up. However, this function will not work when High-head condition setting or Long-piping condition setting is enabled.
				0	1	Enabled	
Max. capacity restriction (B type PBA)	Main	1	8	0	0	Enabled (Factory default)	Restrict excessive capacity increase when operating indoor units with small capacity
				0	1	Disabled	
Gas leak pump down (B type PBA)	Main	1	9	0	0	Disabled (Factory default)	If the gas leak occurred it should be entered in the pump down operation.
				0	1	Enabled	
Unused option	Main	2	0	0	0	Unused option	Unused option by this model
LA KIT option (B type PBA)	Main	2	1	0	0	Disabled (Factory default)	Set when LA KIT is installed.
				0	1	Enabled	
Emergency operation for indoor unit communication error (B type PBA)	Main	2	2	0	0	Disabled (Factory default)	When set, emergency operation is possible even if an indoor communication error occurs.
				0	1	Indoor high humidity condition (operating for up to 12hours)	
				0	2	Indoor low humidity condition (operating for up to 24hours)	

※ There is a risk of water leakage during emergency operation for indoor unit communication error. Please be careful when using it.

Setting key operation and checking the view mode with tact switch

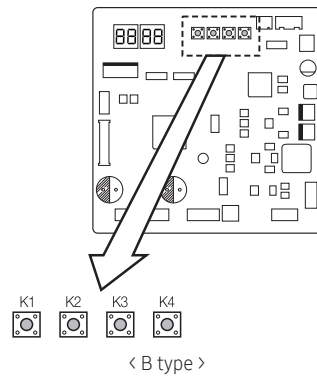
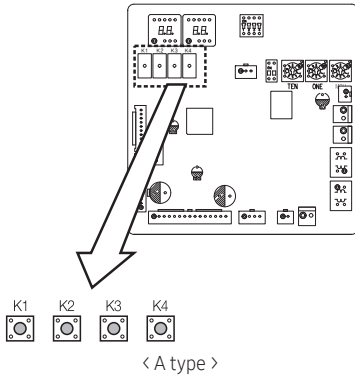

K1 control	KEY operation	Display on segment
Press and hold 1 time	Auto trial operation	"K" "K" "BLANK" "BLANK"

K1 (Number of press)	KEY operation	Display on segment
1 time	Refrigerant charging in Heating mode	"K" "1" "BLANK" "BLANK"
2 times	Trial operation in Heating mode	"K" "2" "BLANK" "BLANK"
3 times	Pump out in Heating mode (Outdoor unit address 1)	"K" "3" "BLANK" "1"
4 times	Pump out in Heating mode (Outdoor unit address 2)	"K" "3" "BLANK" "2"
5 times	Pump out in Heating mode (Outdoor unit address 3)	"K" "3" "BLANK" "3"
6 times	Pump out in Heating mode (Outdoor unit address 4)	"K" "3" "BLANK" "4"
7 times	Vacuuming (Outdoor unit address 1)	"K" "4" "BLANK" "1"
8 times	Vacuuming (Outdoor unit address 2)	"K" "4" "BLANK" "2"
9 times	Vacuuming (Outdoor unit address 3)	"K" "4" "BLANK" "3"
10 times	Vacuuming (Outdoor unit address 4)	"K" "4" "BLANK" "4"
11 times	Vacuuming (All outdoor units)	"K" "4" "BLANK" "A"
12 times	End Key operation	-

Setting outdoor unit option switch and key function



- After installing the product, be sure to perform leak tests on the piping connections. After pumping down refrigerant to inspect or relocate the outdoor unit, be sure to stop the compressor and then remove the connected pipes.
 - Do not operate the compressor while a valve is open due to refrigerant leakage from a pipe or an unconnected or incorrectly connected pipe. Failure to do so may cause air to flow into the compressor and too a high pressure to develop inside the refrigerant circuit, leading to an explosion or product malfunction.

K2 (Number of press)	KEY operation		Display on segment
1 time	Refrigerant charging in Cooling mode		"K" "5" "BLANK" "BLANK"
2 times	Trial operation in Cooling mode		"K" "6" "BLANK" "BLANK"
3 times	Pump down all units in Cooling mode		"K" "7" "BLANK" "BLANK"
4 times	H/R: Checking the pipe connection H/P: Automatic setting of operation mode (Cooling/Heating) for trial operation		"K" "8" "BLANK" "BLANK"
5 times	Checking the amount of refrigerant		"K" "9" X X (Display of last two digits may differ depending on the progress)
6 times	Discharge mode of DC link voltage		"K" "A" "BLANK" "BLANK"
7 times	Forced defrost operation		"K" "B" "BLANK" "BLANK"
8 times	Forced oil collection		"K" "C" "BLANK" "BLANK"
9 times	Inverter compressor 1 check		"K" "D" "BLANK" "BLANK"
10 times	Inverter compressor 2 check		"K" "E" "BLANK" "BLANK"
11 times	Fan 1 check		"K" "F" "BLANK" "BLANK"
12 times	Fan 2 check		"K" "G" "BLANK" "BLANK"
13 times	A type PBA	End key operation	"K" "H" X X (Display of last two digits may differ depending on the progress)
	B type PBA	H/R : Auto pipe pairing, H/P : Unused	
14 times	B type PBA	End key operation	

- During "Discharge mode of DC link voltage", voltage of INV1 and INV2 will be displayed alternately.
- Even when the outdoor unit power is off, it is dangerous when you come in contact with inverter PCB and fan PCB since they are charged with high DC voltage.
- When pressing K2 key 9 to 12 times without inverter checker, error code can be displayed on segment even though the outdoor unit is normal.
- When replacing/repairing the PCB, cut-off the power and wait until the DC voltage is discharged before replacing/repairing them. (Wait for more than 15 minutes to allow it to discharge naturally.)
- When there were error, 'Discharge mode of DC link voltage' may not have been effective. Especially if error E464 and E364 have been occurred, power element might be damaged by fire and therefore, do not use the 'Discharge mode of DC link voltage'.
- If the 1st-generation MCU is installed, the Auto pipe pairing operation can not be used.
If the 2nd-generation MCU is installed, the Checking the pipe connection can not be used.
 - 1st-generation MCU : MCU-S*NEE*N, MCU-S2NEK1N
 - 2nd-generation MCU : MCU-S*NEK2N,MCU-S4NEK3N,MCU-S1NEK1N
- If there is an A type PBA among the outdoor units installed as a module, the Auto pipe pairing operation can not be used.

K3 (Number of press)	KEY operation	Display on segment
1 time	Initialize (Reset) setting	Same as initial state

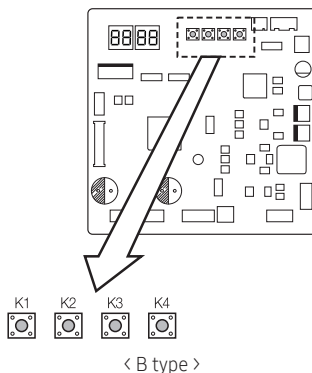
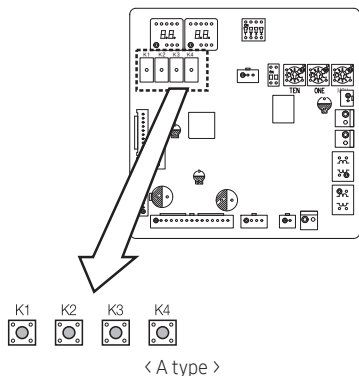

K4 (Number of press)	KEY operation	Display on segment	
		SEG1	SEG2, 3, 4
1 time	Outdoor unit model	1	AM160FXVX×××× → Off, 1, 6
2 times	Order frequency of the compressor 1	2	120 Hz → 1, 2, 0
3 times	Order frequency of the compressor 2	3	120 Hz → 1, 2, 0
4 times	High pressure (MPa)	4	1.52 MPa → 1, 5, 2
5 times	Low pressure (MPa)	5	0.43 MPa → 0, 4, 3
6 times	Discharge temperature (Compressor 1)	6	87 °C → 0, 8, 7
7 times	Discharge temperature (Compressor 2)	7	87 °C → 0, 8, 7
8 times	IPM temperature (Compressor 1)	8	87 °C → 0, 8, 7
9 times	IPM temperature (Compressor 2)	9	87 °C → 0, 8, 7
10 times	CT sensor value (Compressor 1)	A	2 A → 0, 2, 0
11 times	CT sensor value (Compressor 2)	B	2 A → 0, 2, 0
12 times	Suction temperature	C	-42 °C → -, 4, 2
13 times	COND OUT temperature	D	-42 °C → -, 4, 2
14 times	Temperature of liquid pipe	E	-42 °C → -, 4, 2
15 times	TOP temperature (Compressor 1)	F	-42 °C → -, 4, 2
16 times	TOP temperature (Compressor 2)	G	-42 °C → -, 4, 2
17 times	Outdoor temperature	H	-42 °C → -, 4, 2
18 times	EVI inlet temperature	I	-42 °C → -, 4, 2
19 times	EVI outlet temperature	J	-42 °C → -, 4, 2
20 times	Main EEV1 step	K	2000 steps → 2, 0, 0
21 times	Main EEV2 step	L	2000 steps → 2, 0, 0
22 times	EVI EEV step	M	300 steps → 3, 0, 0
23 times	HR EEV step	N	300 steps → 3, 0, 0
24 times	Fan step (SSR or BLDC)	O	13 steps → 0, 1, 3
25 times	Current frequency (Compressor 1)	P	120 Hz → 1, 2, 0
26 times	Current frequency (Compressor 2)	Q	120 Hz → 1, 2, 0

Setting outdoor unit option switch and key function

K4 (Number of press)	KEY operation	Display on segment	
		SEG1	SEG2, 3, 4
27 times	Suction 2 temperature	R	-42 °C → -, 4, 2
28 times	Master indoor unit address	S	Master indoor unit not selected → BLANK, N, D If indoor unit No.1 is selected as the master unit → 0, 0, 1

K4 (Number of press) Press and hold the K4 to enter the setting	Displayed content	Display on segment			
		page1	page2		
1 time	Main version	MAIN	Version (ex. 1412)		
2 times	Hub version	HUB	Version (ex. 1412)		
3 times	Inverter1 version	INV1	Version (ex. 1412)		
4 times	Inverter 2 version	INV2	Version (ex. 1412)		
5 times	Fan 1 version	FAN1	Version (ex. 1412)		
6 times	Fan 2 version	FAN2	Version (ex. 1412)		
7 times	EEP version	EEP	Version (ex. 1412)		
8 times	Automatically assigned address of the units	AUTO	SEG1	SEG2	SEG3, 4
			Indoor unit: "A" MCU: "C"	Indoor unit: "0" MCU: "1"	Address (ex: 07)
9 times	Manually assigned address of the units	MANU	SEG1	SEG2	SEG3, 4
			Indoor unit: "A"	Indoor unit: "0"	Address (ex: 15)

※ I/U : Indoor unit

Setting the MCU and Pipe Addresses (for HR Only)

You can set the MCU address, the MCU ports to use, and the address for each MCU port connected to each indoor unit. It is for 2nd-generation MCU only. (MCU-S*NEK2N, MCU-S4NEK3N, MCU-S1NEK1N)

Setting the MCU address and the MCU ports to use

You can set the MCU address and the MCU ports on the MCU PBA.

MCU address switch



DIP switch



S/W option DIP switch

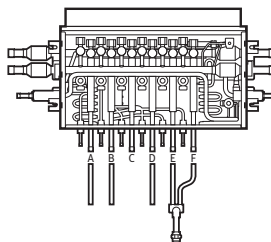

1. Set the MCU address switch to a value. If two or more MCUs are installed, be sure to set a unique value for each MCU. For the MCU address, you can set a value from 0 to 15.
2. For each MCU ports that are connected to an indoor unit through piping, set their DIP switch to ON. For other MCU ports, set their DIP switches to OFF. You can find the address (A to F) of an MCU port on the indoor unit piping connection.
3. If two MCU ports are connected to an indoor unit through a Y-joint, set the relevant S/W option DIP switch to the settings given in the following table:

S/W option DIP switch No.	ON (Individual connection)	OFF (Shared connection)
1	Each of ports A and B	Both ports A and B
2	Each of ports C and D	Both ports C and D
3	Each of ports E and F	Both ports E and F

※ You cannot make a shared connection for the two ports B and C, and D and E at the same time.

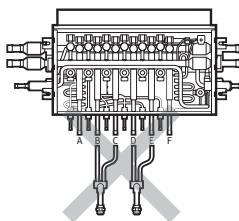
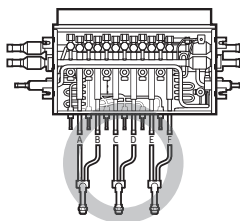

4. Set the address of each MCU port that is connected to an indoor unit by taking the procedures in Setting the Pipe Addresses Manually or Setting the Pipe Addresses Automatically. (Auto pipe pairing operation)



- If the following models are connected, set the pipe addresses manually by referring to Setting the Pipe Addresses Manually.
 - ERV plus (AM***NKDE*), OAP duct (AM***NEPE*), Hydro Unit (AM***NBDE*, AM***NBF**), AHU kit (MXD-K***AN, MCM-D***N)
- If 1st-generation MCU (MCU-S*NEE*N, MCU-S2NEK1N) is installed, refer to the corresponding install manual.

Setting the MCU and Pipe Addresses (for HR Only)

Setting the Pipe Addresses Manually

You can use the wired or wireless remote control or the S-NET Pro 2 to set the pipe addresses for each indoor unit.

Setting by using the wired or wireless remote control (For how to operate the remote control buttons, see the remote control user manual.)

1. Turn on both the indoor unit and the remote control.
2. Enter the "Option setting mode" on the remote control.
3. Set the address of each MCU port that is connected to an indoor unit by referring to the following table. (You can also set the address of each indoor unit.)

Option	SEG1	SEG2	SEG3	SEG4	SEG5	SEG6
Value	0	A: Address setting mode	0: The address of the indoor unit will not be set. 1: The address of the indoor unit will be set.	0 to 9: Hundreds digit of the indoor unit address	0 to 9: Tens digit of the indoor unit address	0 to 9: Units digit of the indoor unit address
Option	SEG7	SEG8	SEG9	SEG10	SEG11	SEG12
Value	1	0	0: The RMC address will not be set. 1: The RMC address will be set.	0	0 to F: RMC group channel	0 to F: RMC group address
Option	SEG13	SEG14	SEG15	SEG16	SEG17	SEG18
Value	2	0	0: The MCU address will not be set. 1: The MCU address will be set.	0 to 1: Tens digit of the MCU address	0 to 9: Units digit of the MCU address	A to F: MCU port address
Option	SEG19	SEG20	SEG21	SEG22	SEG23	SEG24
Value	3	0	0	0	0	0

Examples> If the indoor unit whose address is not yet set is connected to port A on the MCU 1, set 0A0000-100000-20101A-300000.

If the indoor unit whose address is set to 9 is connected to port B on the MCU 2, set 0A1009-100000-20102B-300000.

Setting by using S-NET Pro 2

- ▶ Set the pipe addresses by using Add-on > Change address on S-NET Pro 2. (For more information, see the S-NET Pro 2 Help.)

Setting the Pipe Addresses Automatically (Auto pipe pairing operation)

You can use the Automatic pipe-address setting operation to automatically set the address of each MCU port that is connected to an indoor unit.

If an MCU port is set incorrectly or a pipe between an MCU and an indoor unit is connected incorrectly, that indoor unit is indicated.

Check items before running the Auto pipe pairing operation

1. Ensure that the service valve of the outdoor unit is open.
2. Ensure that the power cables and communication cables of the indoor and outdoor units are correctly connected.
3. Turn on the indoor and outdoor units 6 hours before running the Automatic pipe-address setting operation to warm up both units sufficiently.
4. Before turning on the power, check whether the voltages and phases are correct by using a voltmeter and a phase tester.
 - Check for the R, S, T, and N terminals: ensure that 380-415V is read between lines (R-S, S-T, T-R) and 200-240V (R-N, S-N, T-N) between phases.
5. After the power is turn on, set the devices (indoor unit, MCU, and others) that are connected to the outdoor unit, and set the options.

Note that, before the MCU port addresses are set, MCU port setting errors (E216, 217, 218) may occur. You can run the Automatic pipe-address setting operation regardless of MCU port setting errors.
6. If the OAP(Outdoor Air Processing) Duct or Hydro unit is connected, set the pipe addresses manually referring to [Setting the Pipe Addresses Manually].
7. Check the operating temperature for the Automatic pipe-address setting operation:

If this operation is run at a temperature out of the operating temperature range, the addresses set automatically may be incorrect. Set the pipe addresses manually by referring to Setting the Pipe Addresses Manually.
8. Auto pipe-pairing operation does not work within 3 minutes after power on and reset due to communication check.

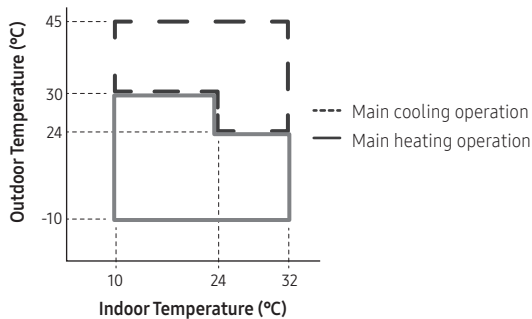

[Operating temperature for the Auto pipe pairing operation]

Setting the MCU and Pipe Addresses (for HR Only)

- ※ Before running the Auto pipe pairing operation, be sure to close the front cabinet. If this operation is run with the front cabinet open, the product may be damaged and the pipe addresses cannot be correctly recognized.

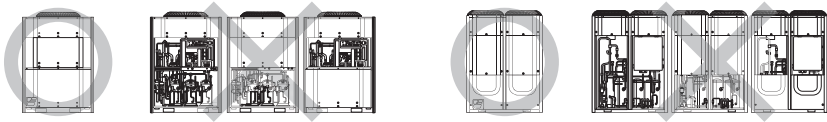

To run the Auto pipe pairing operation, take the following steps:

1. Press the K2 button 13 times on the main PBA of the outdoor unit to start the Auto pipe pairing operation. (Display : **FH** **01**.)

	Outdoor temperature < 24°C	24°C ≤ Outdoor temperature < 30°C	30°C ≤ Outdoor temperature
Indoor temperature < 24°C	Main heating operation	Main heating operation	Main cooling operation
Indoor temperature ≥ 24°C	Main heating operation	Main cooling operation	Main cooling operation

Each step is indicated on the outdoor unit display. (The whole operation takes about 25 to 55minutes normally, depending on the number of indoor units connected. However, it can be operated for up to 2 hours to protect the compressor.)

- Step 1 (Start **FH01**) → Steps 2 to 8 (Setup **FH08**) → Step 9 (Check **FH09**) → Step 10 (Confirmation **FH10**)

2. When the Auto pipe pairing operation finishes, the following data is shown on the outdoor unit display.

Result	Outdoor unit display	Description
Setting completed	End	
Setting error	E191 ↔ Indoor unit data (displayed alternately)	<p>Indoor unit data</p> <p>- SEG 1,2 = indoor unit address / SEG 3,4 = error status</p> <p>00: An MCU port is not disabled, or a pipe is not connected.</p> <p>01: Cooling only indoor unit is connected to MCU.</p> <p>02: The shared setting for two ports is incorrect.</p> <p>Example) When the MCU port connected to the indoor unit 12 is disabled, E191 and 1200 are displayed alternately</p> <p>- If two or more indoor units have setting errors, the data about the next indoor unit is displayed each time you press the K2 switch.</p>



- If the MCU ports to use are set incorrectly, the Auto pipe pairing operation may stop due to high-pressure or low-pressure protection control or the data about the indoor unit that has a MCU port setting error may be incorrect. Ensure that the MCU ports to use are set correctly.
- Depending on the indoor and outdoor temperatures, the Auto pipe pairing operation may stop due to protection control.
- If an error occurs while the Auto pipe pairing operation is running, check the error code and take actions.
- If you cannot finish the Auto pipe pairing operation because of the previous reasons, set the pipe addresses manually by referring to Setting the Pipe Addresses Manually.

Things to check after completing the installation

- Before supplying the power, use DC 500 V insulation resistance tester to measure the power (3 phase: R, S, T / 1 phase: L, N) terminal and the outdoor unit grounding.
 - Measurement should be over 30MΩ.
- Before supplying the power, use a voltmeter and phase tester to check the voltage and the phase.
 - R, S, T, N terminal: check if the voltage is within 380-415 V between wires (R-S, S-T, T-R) and 200-240 V between phases (R-N, S-N, T-N) before turning on the switch.



- Never measure the communication terminal since communication circuit may get damaged.
- Check for short-circuit of the communication terminal with a general circuit tester.

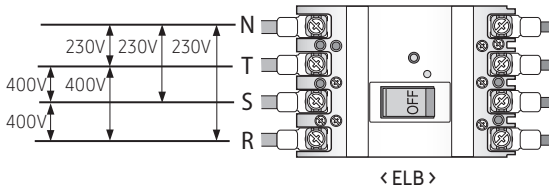

- Check if the R-410A indoor units are connected.
- When N phase is not correctly connected to R, S and T phase, over-voltage protection control will be in effect and it will cut-off the power of the PCB. Check the power cable connection of the N phase if the PCB is not turned on.
- Check the following after the installation is completed.

Installation work	Outdoor unit	<ul style="list-style-type: none"> Have you checked the external surface and the inside of the outdoor unit? Is there any possibility of short-circuit caused by the heat of an outdoor unit? Is the place well-ventilated and ensures space for service? Is the outdoor unit fixed securely to withstand any external force?
	Indoor unit	<ul style="list-style-type: none"> Have you checked the external surface and the inside of the indoor unit? Is there enough space for service? Have you checked if the center of the indoor unit is ensured and it is installed horizontally?
Refrigerant pipe work		<ul style="list-style-type: none"> Have you selected correct pipes? Are the liquid and gas valve open? Is the total number of connected indoor units within the allowable range? Are the length and the height difference between the refrigerant pipes within the allowable range? Are the branch joints properly installed? Did you check the connection of liquid and gas pipes? Have you selected correct insulator for pipes and insulated them correctly? Did you insulate the pipes and connection part correctly? Is the quantity of the additional refrigerant correctly weighed in? (You must record the amount of additional refrigerant on the service record paper placed inside of the outdoor unit.)

Drain pipe work	<ul style="list-style-type: none"> • Have you checked if the drain pipes of the indoor and outdoor unit are connected together? • Have you completed the drain test? • Is the drain pipe properly insulated?
Electrical wiring work	<ul style="list-style-type: none"> • Are the power cable and communication cable tightened firmly on the terminal board within the range of rated tightening torque? • Have you checked for cross-connection of the power and communication cables? • Have you performed the earthing work 3 to the outdoor unit? • Did you make sure to use 2-core cable (not multi-core cable) for the communication cable? • Is the length of the wire within allowed range? • Is the wiring route correct?
Setting address	<ul style="list-style-type: none"> • Did you set the address of the indoor and outdoor units properly? • Did you set the address of the indoor and outdoor units properly? (When using multiple remote controllers)
Option	<ul style="list-style-type: none"> • If there is a possibility of the outdoor unit from vibrating, check whether the anti-vibration frame is correctly installed.

Inspection and test operation



CAUTION

Precautions before test operation

- When the outdoor temperature is low, turn on the main power 6 hours before beginning the operation.
 - If you start the operation immediately after turning on the main power, it may cause serious damage to the part in the product.
- Do not touch the refrigerant pipe during or right after the operation.
 - Refrigerant pipe may be hot or cold during or right after the operation depending on the status of the refrigerant which flows through the refrigerant pipe, compressor and other parts of the refrigerant cycle.
- Do not operate the product with its panel or protection nets off.
 - There is risk of personal injury from the parts rotating, heated or with the high voltage.
- Do not turn off the main power immediately after stopping the operation.
 - Wait for at least 5 minutes before turning off the main power. If not, water leakage or other problems may occur.
- Connect all the indoor units and the power supply for the outdoor unit and run auto address setting. Run auto address setting even after changing the indoor unit PCB.

Inspection and trial operation

Checklist before auto trial operation

1. Check the power cable and communication cable of the indoor and outdoor unit.
2. Supply power to the outdoor unit 6 hours before trial operation to pre-heat the crank case heater.
3. Before supplying the power, use a voltmeter and phase tester to check the voltage and the phase.
 - R, S, T, N terminal: check if the voltage is within 380 -415 V between wires (R-S, S-T, T-R) and 200-240 V between phases (R-N, S-N, T-N).
4. When the power is supplied, outdoor unit will execute tracking to check the indoor unit connection and other optional functions.
5. Write down the installation report on the service history report paper attached on the front part of the control box.



- Supply power to the outdoor unit 6 hours before auto trial operation to pre-heat the crank case heater.

6. Guaranteed range of auto trial operation

For precise judgment, you must perform auto trial operation in below indoor/outdoor temperature condition.

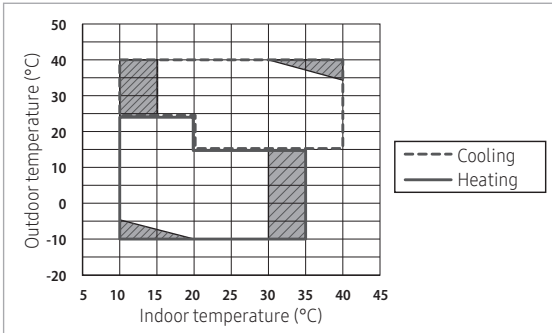

- In Auto trial operation, product will automatically select either cooling or heating mode and operate in selected mode.
- In the temperature range marked with slashed pattern, system protection control may trigger during operation.(If the system protection control is enabled, it can be hard to get the precise judgment after the auto trial operation.)
- When the temperature is outside of guaranteed range, accuracy of judgment on auto trial operation may decrease near boarder line area.
- If all indoor units are connected with only hydro unit, it is operated by heating mode. If outdoor temperature is above 35 °C, auto trial operation is skipped and UP mode will be cleared.

Auto trial operation

1. If the Auto Trial Operation is not completed, normal operation will be prohibited.
 - When the auto trial operation is not completed, UP (UnPrepared) will appear on the segment after the communication check and restrict compressor from operating. (UP Mode will be cleared automatically when auto trial mode is completed.)
 - Auto trial operation may take 20 minutes to maximum 2 hours depending on the operation status.
 - During auto trial operation, noise can be generated due to valve inspection. (Check the product if abnormal noise occurs continuously)
2. When error occurs during auto trial operation, check the error code and take appropriate measures.
 - Refer to next couple of pages when E503, E505 or E506 error occurs.
3. When auto trial operation ends, use S-NET pro or S-CHECKER to issue a result report.
 - Refer to service manual if you have any items with "NG" on the result report.
 - After taking appropriate measure for the items with "NG", run the auto trial operation again.
4. Check the following items by running trial operation (cooling/heating).
 - Check if cooling/heating operation performs normally.
 - Individual indoor unit control: Check for air flow direction and fan speed.
 - Check for abnormal operation noise from the indoor and outdoor unit.
 - Check for proper draining from the indoor unit during cooling operation.
 - Use S-NET pro to check the detail operation status.
5. Explain to the user how to use the air conditioner according to the user's manual.
6. Hand over the installation manual to the customer so they can keep it with them.



- Make sure to close the top and bottom part of the outdoor unit cabinet during operation. If you operate the unit with the front cabinet open, it may cause damage to the product and you may not get the precise data from S-NET pro.

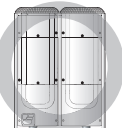

Inspection and trial operation

Measure to take when E503 error occurs

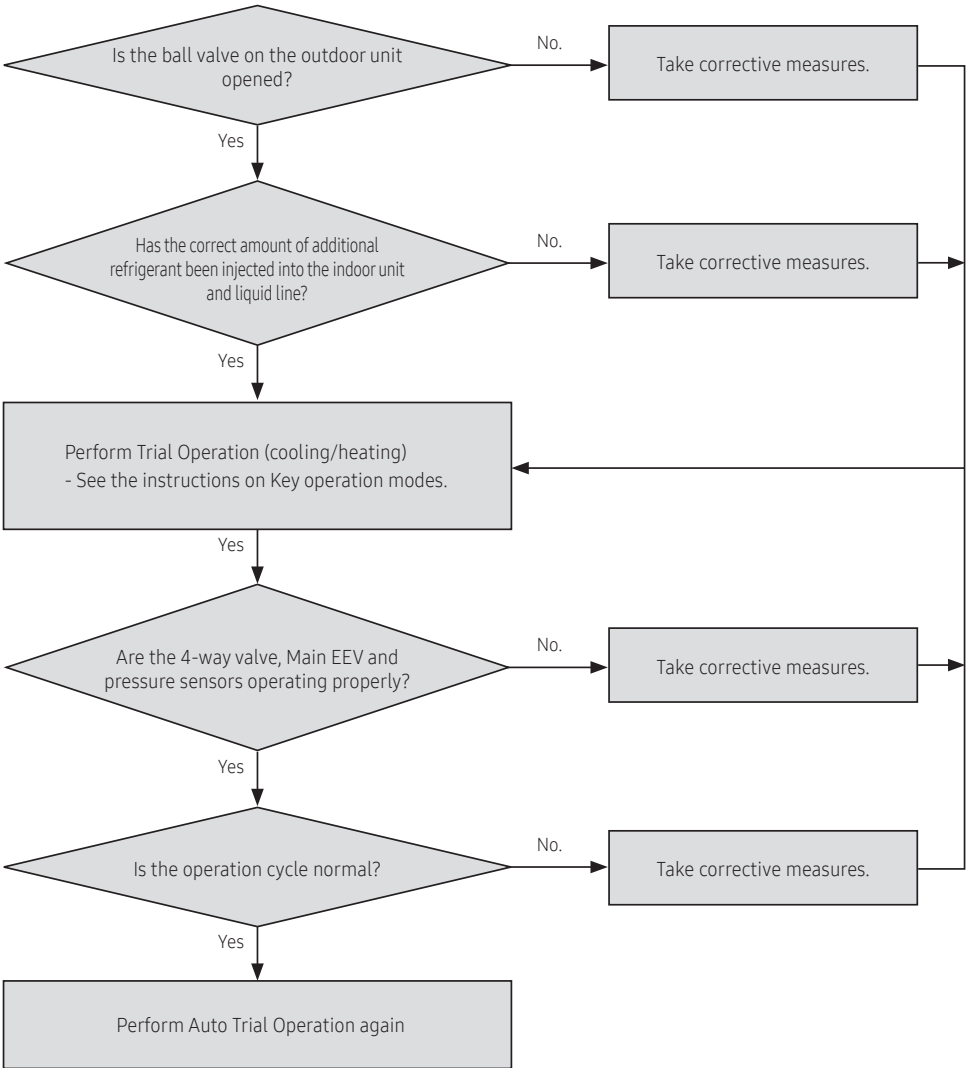

- ※ Symptoms for abnormal operation of the 4way valve
 - Abnormal noise during compressor operation, Increase in the suction temperature.
- ※ Symptoms for abnormal operation of the Main EEV
 - It is not possible to control the superheat (SH)
 - It is not possible to secure a DSH of higher than 20K
- ※ For more information, see the troubleshooting in the service manual.



- If service valve (ball valve) check is required, corresponding outdoor unit will display the error.
- If service valve (ball valve) check is required, auto detection mode will be terminated. Check service valve (ball valve) of gas pipe and liquid pipe at the same time when checking service valve (ball valve).
- When 4way valve, Main EEV detection is needed, run heating trial operation for more than 1 hour and analyze the data to check for a problem.
- If there's frost formed in outdoor unit or the outdoor unit is operating in defrost operation, it may be hard to detect problem normally. In this case, perform Trial operation or Forced defrost operation to eliminate the frost, and then perform Auto Trial Operation again.
- If the operation range is not within guaranteed range, error may occur even though the product is normal.
- To replace a component or inspect the PBA, be sure to cut off the power supply first. If inspection must be performed with the power supply on, exercise extra care to prevent electric shock.

Inspection and trial operation

Measure to take when E505, E506 error occurs

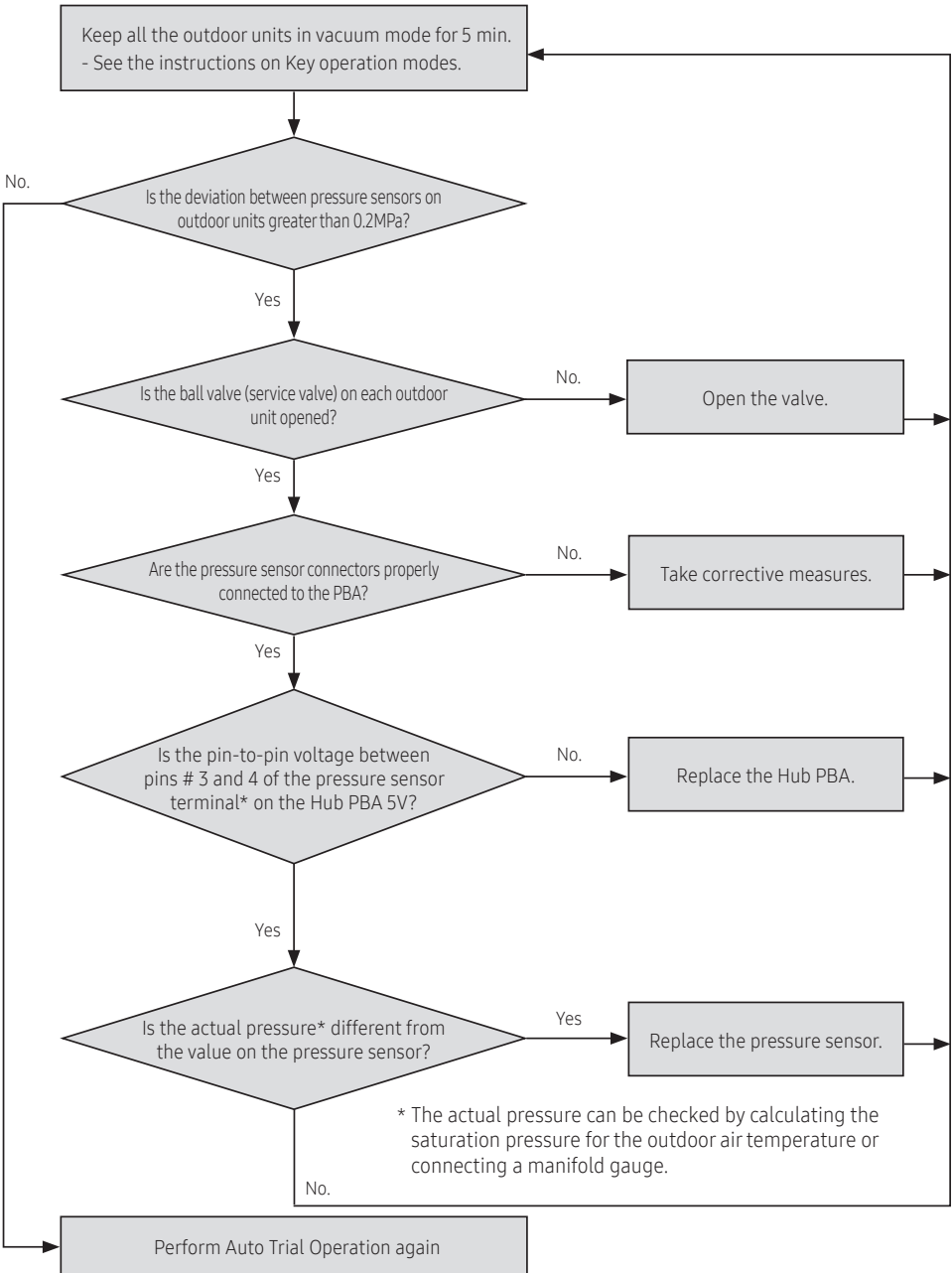

※ For more information, see the troubleshooting in the service manual.



- When the auto trial operation for pressure sensor was executed before the pressure of the outdoor unit is equalized (when there's close to no difference between high and low pressure), error may occur even though the product is normal.
- If pressure sensor check is required , error will be displayed on all installed outdoor units.
- If pressure sensor check is required, outdoor units will terminate auto trial operation mode automatically.
- To check for the pressure sensor with the problem, run trial operation for more than 1 hour and analyze the data to check for a problem.
- To replace a component or inspect the PBA, be sure to cut off the power supply first. If inspection must be performed with the power supply on, exercise extra care to prevent electric shock.

Automatic refrigerant amount detection function

This function checks amount of refrigerant in the system through refrigerant amount detection operation

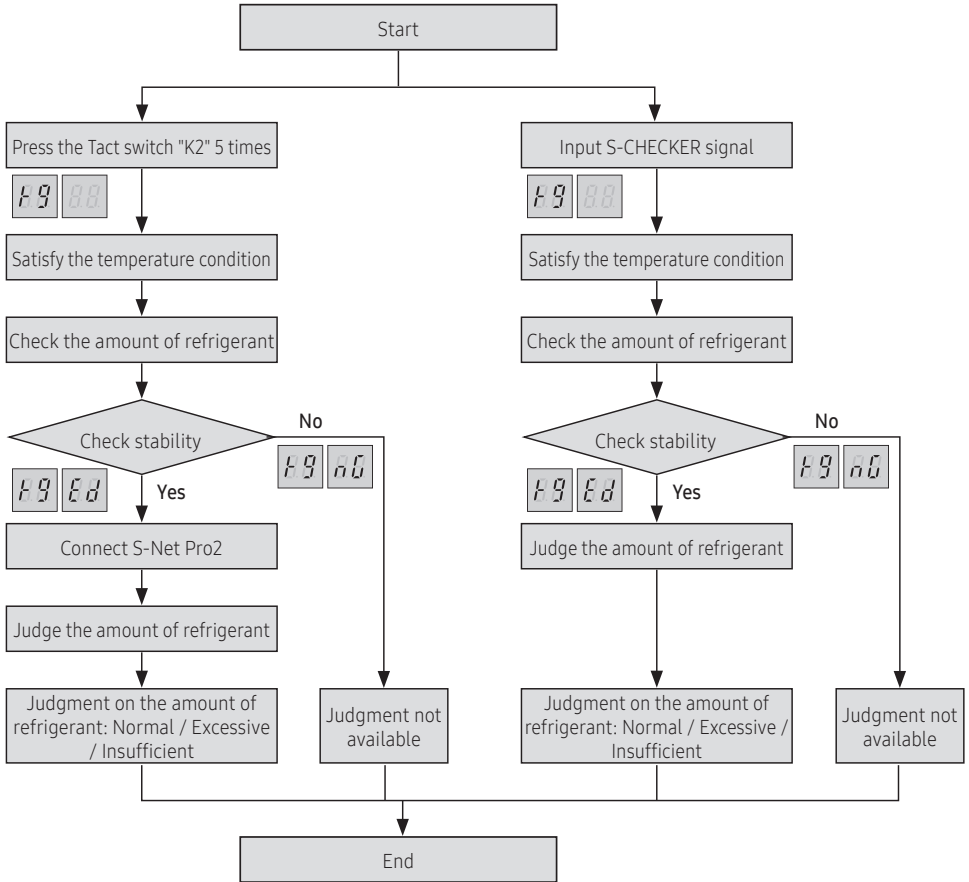



- If the temperature is out of the guaranteed range below, exact result will not be obtained.
 - Indoor: 20~32 °C
 - Outdoor: 5~43 °C
- If the operation cycle is not stable, the operation of refrigerant amount check may be forcibly finished.
- Accuracy of the result may decrease if the product has not been operated for a long period of time or Heat mode has been operated before running the function of refrigerant amount check. Therefore, use the function of refrigerant amount check after operating the product in Cool mode for at least 30 minutes.
- Product may trigger system protection operation depending on the installation environment. In this case, the result of refrigerant amount check may not be accurate.
- After refrigerant amount detection is finished, if you see "K9 Ed" on the display and cannot check the refrigerant amount from the S-net pro and S-checker, it means insufficient degree of supercooling.

Actions to take for the check result

- Excessive amount of refrigerant
 - Discharge 5% of total amount of refrigerant and restart the refrigerant amount check.
- Insufficient amount of refrigerant
 - Add 5% of the total amount of refrigerant and restart the refrigerant amount check.
- Insufficient degree of supercooling
 - Add 10 % of the total amount of refrigerant and restart the refrigerant amount check.
- Judgment not available
 - Check if the function of refrigerant amount check is executed within the guaranteed temperature range. Run trial operation to check if there are other problems on the system.

Model	Net weight (kg)	Net size (W x H x D, mm)
AM080JXVHGH/EU	192.0	880.0 x 1695.0 x 765.0
AM100JXVHGH/EU	192.0	880.0 x 1695.0 x 765.0
AM120JXVHGH/EU	192.0	880.0 x 1695.0 x 765.0
AM140JXVHGH/ET	248.0	1295.0 x 1695.0 x 765.0
AM160JXVHGH/ET	279.0	1295.0 x 1695.0 x 765.0
AM180JXVHGH/ET	288.0	1295.0 x 1695.0 x 765.0
AM200JXVHGH/ET	300.0	1295.0 x 1695.0 x 765.0
AM220JXVHGH/ET	300.0	1295.0 x 1695.0 x 765.0
AM240KXVGGH/ET	342.0	1295.0 x 1795.0 x 765.0
AM260KXVGGH/ET	350.0	1295.0 x 1795.0 x 765.0
AM280KXVGGH/ET	350.0	1295.0 x 1795.0 x 765.0
AM080JXVAGH/EU	186.0	880.0 x 1695.0 x 765.0
AM100JXVAGH/EU	197.0	880.0 x 1695.0 x 765.0
AM120JXVAGH/EU	210.0	880.0 x 1695.0 x 765.0
AM140KXVAGH/ET	226.0	1295.0 x 1695.0 x 765.0
AM160KXVAGH/ET	253.0	1295.0 x 1695.0 x 765.0
AM180KXVAGH/ET	255.0	1295.0 x 1695.0 x 765.0
AM200KXVAGH/ET	282.0	1295.0 x 1695.0 x 765.0
AM220KXVAGH/ET	290.0	1295.0 x 1695.0 x 765.0
AM240KXVAGH/ET	342.0	1295.0 x 1795.0 x 765.0
AM260KXVAGH/ET	350.0	1295.0 x 1795.0 x 765.0
AM280KXVAGH/ET	350.0	1295.0 x 1795.0 x 765.0
AM300KXVAGH/ET	350.0	1295.0 x 1795.0 x 765.0
AM100MXVDGH/ET	197.0	880.0 x 1695.0 x 765.0
AM120MXVDGH/ET	210.0	880.0 x 1695.0 x 765.0
AM140MXVDGH/ET	226.0	1295.0 x 1695.0 x 765.0
AM160MXVDGH/ET	253.0	1295.0 x 1695.0 x 765.0
AM180MXVDGH/ET	255.0	1295.0 x 1695.0 x 765.0
AM080JXVHGR/EU	197.0	880.0 x 1695.0 x 765.0
AM100JXVHGR/EU	197.0	880.0 x 1695.0 x 765.0
AM120JXVHGR/EU	197.0	880.0 x 1695.0 x 765.0
AM140JXVHGR/ET	254.0	1295.0 x 1695.0 x 765.0
AM160JXVHGR/ET	285.0	1295.0 x 1695.0 x 765.0
AM180JXVHGR/ET	294.0	1295.0 x 1695.0 x 765.0
AM200JXVHGR/ET	306.0	1295.0 x 1695.0 x 765.0
AM220JXVHGR/ET	306.0	1295.0 x 1695.0 x 765.0
AM240MXVGNR/ET	350.0	1295.0 x 1795.0 x 765.0
AM260MXVGNR/ET	358.0	1295.0 x 1795.0 x 765.0
AM280MXVGNR/ET	358.0	1295.0 x 1795.0 x 765.0
AM300MXVANR/ET	358.0	1295.0 x 1795.0 x 765.0

SAMSUNG

SAMSUNG ELECTRONICS CO., LTD.

107, Hanamsandan 6beon-ro, Gwangsan-gu, Gwangju-si, Korea 62218

501# Suhong East Road, Industrial Park, Suzhou, Jiagsu, China

Samsung Electronics

Service Department

PO Box 12987, Blackrock, Co. Dublin. Ireland

or

Blackbushe Business Park, Yateley, GU46 6GG. UK