

# TOSHIBA



## Installation Manual

---

### Flow Selector unit

---

---

**RBM-Y1123FE**

**RBM-Y1803FE**

**RBM-Y2803FE**

Thank you very much for purchasing TOSHIBA Super Heat Recovery Multi (S-HRM) Air conditioner.  
Please read this manual carefully before using your Flow Selector unit.

- When installing an indoor or outdoor unit, follow the installation manual supplied with the unit.
- To connect the Flow Selector unit to an outdoor unit with pipes, a branching joint or header is required.  
Choose one according to the capacity of the units.
- Nitrogen gas is filled in the selection unit.

### ADOPTION OF NEW REFRIGERANT

This SUPER HRM Air Conditioner is a new type which adopts a new refrigerant HFC (R410A) instead of the conventional refrigerant R22 in order to prevent destruction of the ozone layer.









Be sure to use an indoor or outdoor unit in combination with the new refrigerant.

## CONTENTS

Accessory parts and Parts to be procured locally .....	1
<b>1</b> PRECAUTIONS FOR SAFETY .....	1
<b>2</b> INSTALLATION OF NEW REFRIGERANT AIR CONDITIONER .....	2
<b>3</b> SELECTION OF INSTALLATION PLACE .....	3
<b>4</b> INSTALLATION OF FLOW SELECTOR UNIT .....	4
<b>5</b> REFRIGERANT PIPING .....	5
<b>6</b> ELECTRIC WORK .....	6

## Accessory parts and Parts to be procured locally

### ■ Accessory parts

Part name	Q'ty RBM-			Shape	Usage
	Y1123FE	Y1803FE	Y2803FE		
Installation Manual	1	1	1	—	(Be sure to hand over to customers.)
Attached wire (For power supply)	1	1	1		For power supply from indoor unit (3-core, 6m)
Attached wire (For control wiring)	1	1	1		For communication with indoor unit (5-core, 6m)
Heat insulating pipe	3	3	2		For heat insulating of suction gas, discharge gas, and gas pipe connecting sections
Heat insulating pipe	—	—	1		For heat insulating of discharge gas
Heat insulating pipe	2	2	2		For heat insulating of liquid pipe connecting section
Attached pipe	1	—	—		Ø9.5 - Ø6.4, connection pipe
Attached pipe	1	—	—		Ø15.9 - Ø12.7, connection pipe
Attached pipe	1	—	—		Ø15.9 - Ø9.5, connection pipe
Wire joint	2	2	2		For connection with certain indoor units

## 1 PRECAUTIONS FOR SAFETY

- Ensure that all Local, National and International regulations are satisfied.
- Read this "PRECAUTIONS FOR SAFETY" carefully before Installation.
- The precautions described below include the important items regarding safety. Observe them without fail.
- After the installation work, perform a trial operation to check for any problem.  
Follow the Owner's Manual to explain how to use and maintain the unit to the customer.
- Turn off the main power supply switch (or breaker) before the unit maintenance.
- Ask the customer to keep the Installation Manual together with the Owner's Manual.

### CAUTION

#### New Refrigerant Air Conditioner Installation

- **THIS AIR CONDITIONER ADOPTS THE NEW HFC REFRIGERANT (R410A) WHICH DOES NOT DESTROY OZONE LAYER.**

The characteristics of R410A refrigerant are ; easy to absorb water, oxidizing membrane or oil, and its pressure is approx. 1.6 times higher than that of refrigerant R22. Accompanied with the new refrigerant, refrigerating oil has also been changed. Therefore, during installation work, be sure that water, dust, former refrigerant, or refrigerating oil does not enter the refrigerating cycle.

To prevent charging an incorrect refrigerant and refrigerating oil, the sizes of connecting sections of charging port of the main unit and installation tools are changed from those for the conventional refrigerant.

Accordingly the exclusive tools are required for the new refrigerant (R410A).

For connecting pipes, use new and clean piping designed for R410A, and please care so that water or dust does not enter. Moreover, do not use the existing piping because there are problems with pressure-resistance force and impurity in it.

# 1 PRECAUTIONS FOR SAFETY

## ⚠ WARNING

- **Ask an authorized dealer or qualified installation professional to install/maintain the air conditioner.**  
Inappropriate installation may result in water leakage, electric shock or fire.
- **Turn off the main power supply switch or breaker before attempting any electrical work.**  
Make sure all power switches are off. Failure to do so may cause electric shock.
- **Connect the connecting wire correctly.**  
If the connecting wire is connected in a wrong way, electric parts may be damaged.
- **When moving the air conditioner for the installation into another place, be very careful not to enter any gaseous matter other than the specified refrigerant into the refrigeration cycle.**  
If air or any other gas is mixed in the refrigerant, the gas pressure in the refrigeration cycle becomes abnormally high and it as a result causes pipe burst and injuries on persons.
- **Do not modify this unit by removing any of the safety guards or by by-passing any of the safety interlock switches.**
- **Exposure of unit to water or other moisture before installation may cause a short-circuit of electrical parts.**  
Do not store it in a wet basement or expose to rain or water.
- **After unpacking the unit, examine it carefully if there is possible damage.**
- **Do not install in a place that might increase the vibration of the unit.**
- **To avoid personal injury (with sharp edges), be careful when handling parts.**
- **Perform installation work properly according to the Installation Manual.**  
Inappropriate installation may result in water leakage, electric shock or fire.
- **When the air conditioner is installed in a small room, provide appropriate measures to ensure that the concentration of refrigerant leakage occur in the room does not exceed the critical level.**
- **Install the air conditioner securely in a location where the base can sustain the weight adequately.**
- **Perform the specified installation work to guard against an earthquake.**  
If the air conditioner is not installed appropriately, accidents may occur due to the falling unit.
- **If refrigerant gas has leaked during the installation work, ventilate the room immediately.**  
If the leaked refrigerant gas comes in contact with fire, noxious gas may generate.
- **After the installation work, confirm that refrigerant gas does not leak.**  
If refrigerant gas leaks into the room and flows near a fire source, such as a cooking range, noxious gas might generate.
- **Electrical work must be performed by a qualified electrician in accordance with the Installation Manual. Make sure the air conditioner uses an exclusive power supply.**  
An insufficient power supply capacity or inappropriate installation may cause fire.
- **Use the specified wires for wiring connect the terminals securely fix.**  
To prevent external forces applied to the terminals from affecting the terminals.
- **Conform to the regulations of the local electric company when wiring the power supply.**  
Inappropriate grounding may cause electric shock.
- **Do not install the air conditioner in a location subject to a risk of exposure to a combustible gas.**  
If a combustible gas leaks, and stays around the unit, a fire may occur.

# 2 INSTALLATION OF NEW REFRIGERANT AIR CONDITIONER

This air conditioner adopts the new HFC refrigerant (R410A) which does not deplete the ozone layer.

- R410A refrigerant is apt to be affected by impurity such as water, oxidizing membrane, or oils because the pressure of R410A refrigerant is higher than that of the former refrigerant by approx. 1.6 times. Accompanied with adoption of the new refrigerant, refrigerating oil has been also changed. Therefore pay attention so that water, dust, former refrigerant, or refrigerating oil does not enter into the refrigerating cycle of the new refrigerant air conditioner during installation work.
- To prevent from mixing of refrigerant or refrigerating oil, the size of charge port of the main unit or connecting section of installation tool differs from that of the air conditioner for the former refrigerant. Accordingly the exclusive tools are required for the new refrigerant (R410A) as shown below.
- For connecting pipes, use the new and clean piping materials so that water or dust does not enter.

## ■ Required tools and cautions on handling

It is necessary to prepare the tools and parts as described below for the installation work.

The tools and parts which will be newly prepared in the following items should be restricted to the exclusive use.

### Explanation of symbols

- : Newly prepared (It is necessary to use it properly exclusive to R410A separated from those for R22 or R407C.)
- : Former tool is available.

Used tools	Usage	Proper use of tools/parts
Gauge manifold	Vacuuming or charging of refrigerant and operation check	● Newly prepared, Exclusive to R410A
Charging hose		● Newly prepared, Exclusive to R410A
Gas leak detector	Checks gas leak	● Newly prepared
Vacuum pump	Vacuum drying	Usable if a counter-flow preventive adapter is attached
Vacuum pump with counter-flow preventive adapter	Vacuum drying	○ : R22 (Existing article)
Bender	Bending processing of pipes	○ : R22 (Existing article)
Refrigerant recovery device	Recovers refrigerant	● Exclusive to R410A
Pipe cutter	Cuts pipes	○ : R22 (Existing article)
Refrigerant cylinder	Charges refrigerant	● Exclusive to R410A ID : Refrigerant name entered
Welding machine/ Nitrogen gas cylinder	Welding of pipes	○ : R22 (Existing article)
Refrigerant charging balance	Charges refrigerant	○ : R22 (Existing article)

## ■ Refrigerant piping

- Piping material used for the conventional refrigerant cannot be used.
- Use copper pipe with 0.8mm or more thickness for Ø6.4, Ø9.5, Ø12.7mm.  
Use copper pipe with 1.0mm or more thickness for Ø15.9mm, Ø19.1mm, Ø22.2mm or more.
- Use clean and new pipes for the refrigerant pipes and perform piping work so that water or dust does not contaminate the refrigerant.

# 3 SELECTION OF INSTALLATION PLACE

## ⚠ CAUTION

### Do not install the air conditioner at place where combustible gas may leak.

If gas leaks and is collected at surrounding the unit, the production of fire may be caused.

### Cautions for Installation at a Place with the Quiet Background Sound

As the Flow Selector unit incorporates the solenoid valve, the refrigerant sound or the operating sound of the solenoid valve such as "Bushuu..." generates when exchanging between cooling and heating mode and during defrost operation. Therefore, avoid installing the unit at a place with quiet background sound as follows.

- (1) Rooms with quiet background sound such as bedroom, hospital, or room in a hotel.
- (2) Rooms which have no ceiling and a fabric does not block the residence space from the Flow Selector unit.
- (3) Rooms which have opening port at the ceiling.

When installing the unit at the above places, separate the unit from the indoor unit (within 15 m) and install the unit at a place so that sound does not transmit into the room such as in the corridor ceiling.

### Upon customer's approval, install the air conditioner at a place where satisfies the following conditions.

- Place where it can be installed horizontally.
- Place which can reserve a service space for safe maintenance or check.
- Place where there is no problem even if the drained water flows.

### Apply electric insulation between metal section of the building and metal section of the air conditioner in conformance with the Local Regulation.

### Avoid the following places.

- Salty place (seaside area) or place with much gas sulfide (hot spring area)  
(If selecting such a place, a special maintenance is required.)
- Place where oil (including machine oil), steam, oil smoke or corrosive gas generates.
- Place where a device generating high frequency (inverter, non-utility generator, medical apparatus, or communication equipment) is set. (A bad influence may generate by malfunction of the air conditioner, control error, or noise for such equipment.)

## ■ Installation space

- Make space for installation and service. (Make space to the electrical parts box cover side for service.)
- When installing the unit inside the ceiling, be sure to create a check port.  
The check port is required when the unit is installed and serviced.
- Keep a clearance of 50mm or more between the top panel of the unit and the ceiling.
- The length of a connection pipe to the indoor unit should be 15m or less.

### <Installation space>

#### RBM-Y1123FE, RBM-Y1803FE

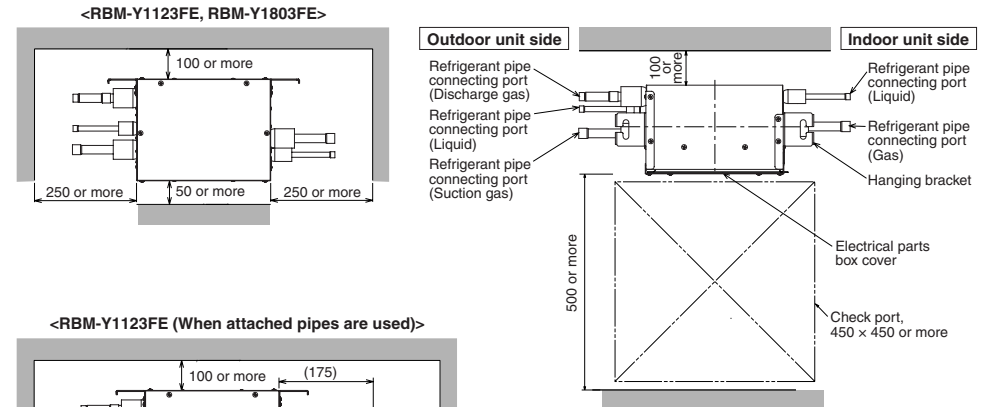

#### <RBM-Y1123FE (When attached pipes are used)>

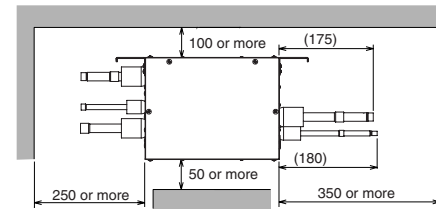

#### RBM-Y2803FE

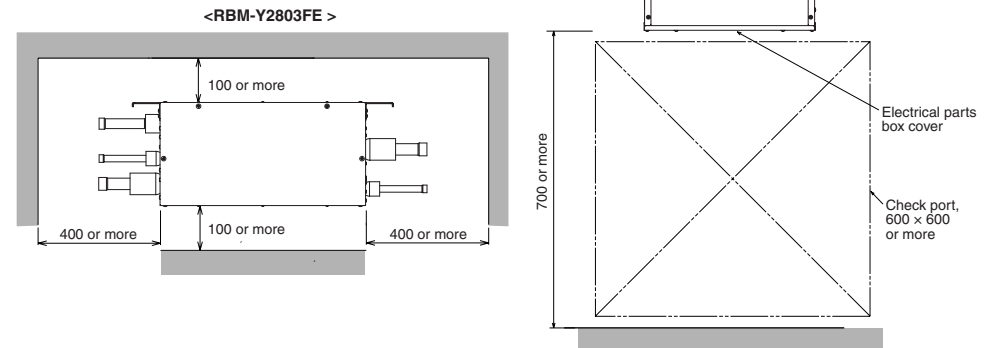

### 3 SELECTION OF INSTALLATION PLACE

#### ■ Installation space

- Make space for installation and service. (Make space to the electrical parts box cover side for service.)
- When installing the unit inside the ceiling, be sure to create a check port. The check port is required when the unit is installed and serviced.
- Keep a clearance of 50mm or more between the top panel of the unit and the ceiling.
- The length of a connection pipe to the indoor unit should be 15m or less.

#### <Installation space>

RBM-Y1123FE, RBM-Y1803FE

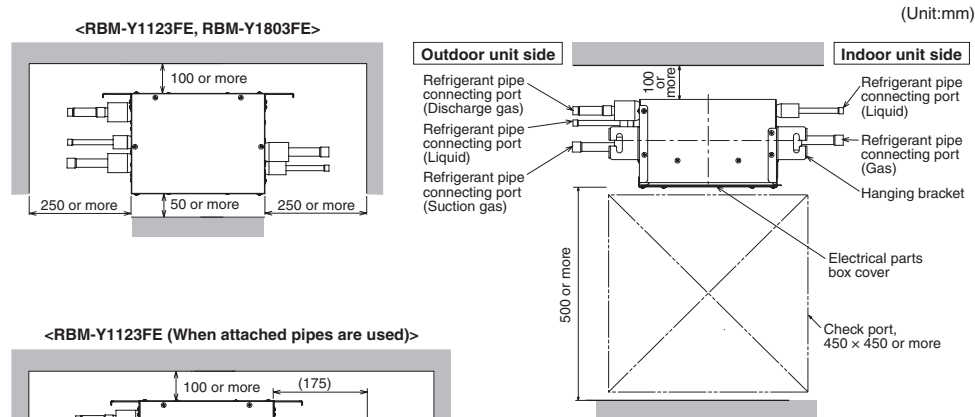

**<RBM-Y1123FE (When attached pipes are used)>**

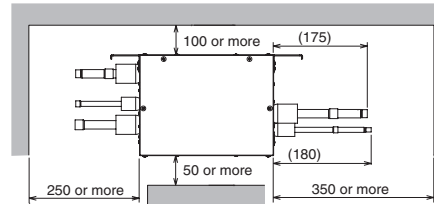

RBM-Y2803FE

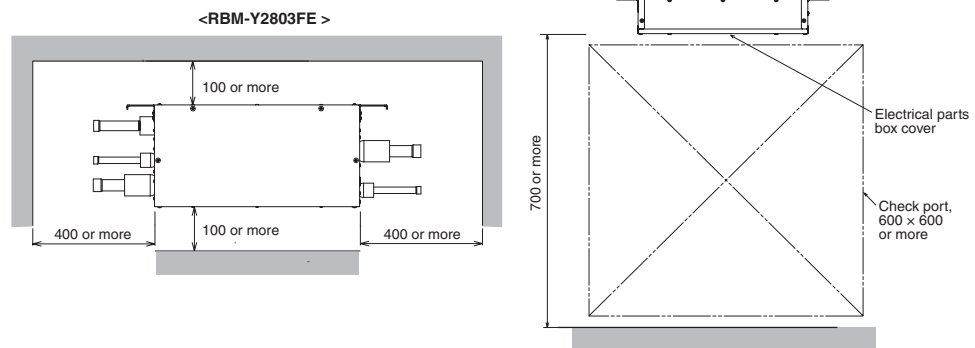

## 4 INSTALLATION OF FLOW SELECTOR UNIT

### ⚠ WARNING

**Install the unit securely in the place to sufficiently withstand the weight of the unit.**

If the foundation is not sturdy enough, the unit may fall and cause personal injury.

**Perform a specified installation work to guard against earth quake.**

Improper installation may cause the unit to fall.

### REQUIREMENT

To prevent damage on the Flow Selector unit or personal injury, follow the instructions below.

- Do not step, or put any heavy object on the packed Flow Selector unit.
- When carrying the Flow Selector unit, hold the two hanging brackets and be careful not to apply excessive force to the refrigerant pipes.

### External view

RBM-Y1123FE, RBM-Y1803FE

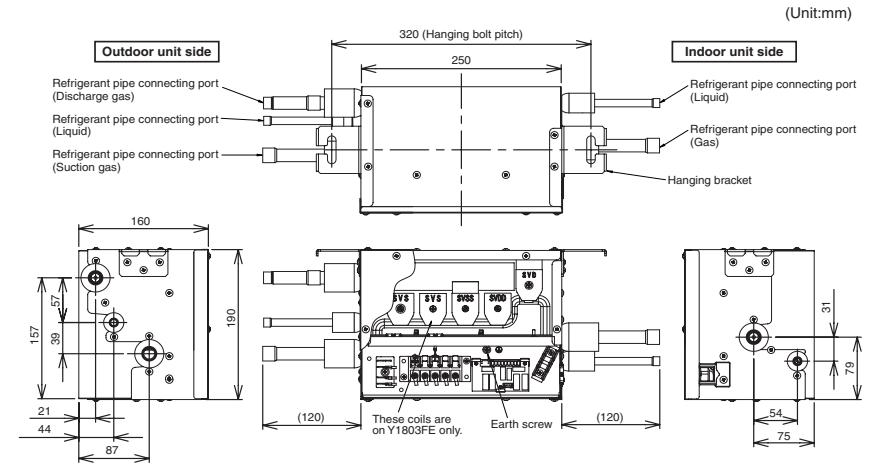

RBM-Y2803FE

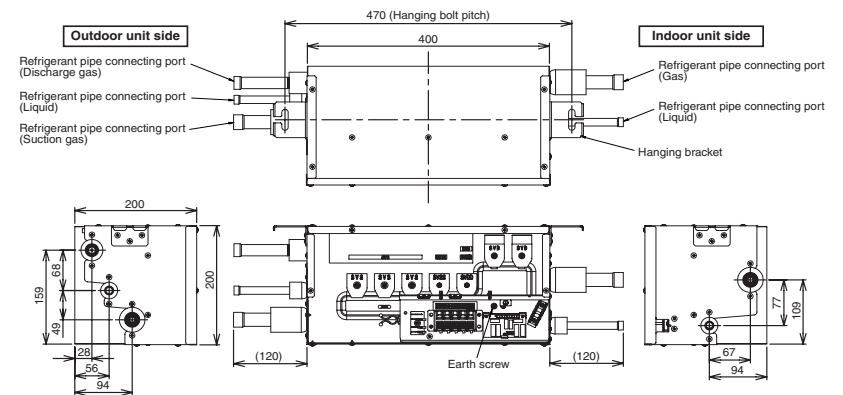

# 5 REFRIGERANT PIPING

## ⚠ WARNING

If refrigerant gas has leaked during the installation work, ventilate the room immediately.  
If the leaked refrigerant gas comes in contact with fire, noxious gas may be generated.

After the installation work, confirm that refrigerant gas does not leak.

If refrigerant gas leaks into the room and flows near a fire source, such as a fan heater, cooking stove or heating unit, noxious gas may be generated.

### ■ Permissible pipe length and permissible height difference

The length of a connection pipe to the indoor unit should be 15m or less.  
For details, refer to the installation manual attached to the outdoor unit.

### REQUIREMENT

When the refrigerant pipe is long, set the support brackets to fix the pipe at intervals of 2.5 to 3m.  
If the pipe is not fixed, noise may be generated.

### ■ Piping material and dimensions

#### One indoor unit connection

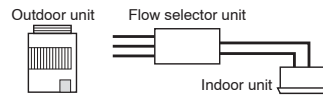

Material	Seamless phosphorus deoxidized copper pipe for air conditioning					
	Flow Selector unit	RBM-	Y1123FE			Y1803FE
Indoor unit	MM*-AP***	007 to 012	015 to 018	024 to 030	036 to 056	072 to 096
Indoor unit side pipe size (mm)	Gas pipe	Ø9.5*	Ø12.7*	Ø15.9	Ø15.9	Ø22.2
	Liquid pipe	Ø6.4*	Ø6.4*	Ø9.5	Ø9.5	Ø12.7
Outdoor unit side pipe size (mm)	Suction gas pipe	Ø15.9	Ø15.9	Ø15.9	Ø15.9	Ø22.2
	Discharge gas pipe	Ø12.7	Ø12.7	Ø12.7	Ø12.7	Ø19.1
	Liquid pipe	Ø9.5	Ø9.5	Ø9.5	Ø9.5	Ø12.7

\* Use pipes attached with the Flow Selector unit.

#### Multi indoor unit connection

For selection of the branching pipe, refer to the Installation Manual attached to the outdoor unit.

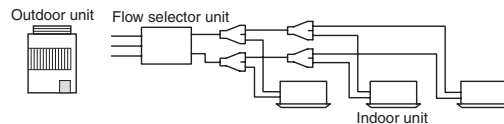

Material	Seamless phosphorus deoxidized copper pipe for air conditioning				
	Flow Selector unit	RBM-	Y1123FE	Y1803FE	Y2803FE
Indoor unit capacity code			Less than 11.2	11.2 or more less than 18.0	18.0 or more less than 22.0
Indoor unit side pipe size (mm)	Gas pipe		Ø15.9	Ø15.9	Ø22.2
	Liquid pipe		Ø9.5	Ø9.5	Ø12.7
Outdoor unit side pipe size (mm)	Suction gas pipe		Ø15.9	Ø15.9	Ø22.2
	Discharge gas pipe		Ø12.7	Ø12.7	Ø19.1
	Liquid pipe		Ø9.5	Ø9.5	Ø12.7
Connectable indoor units			5	8	8

### <RBM-Y1123FE (Use pipes attached with the Flow Selector unit.)>

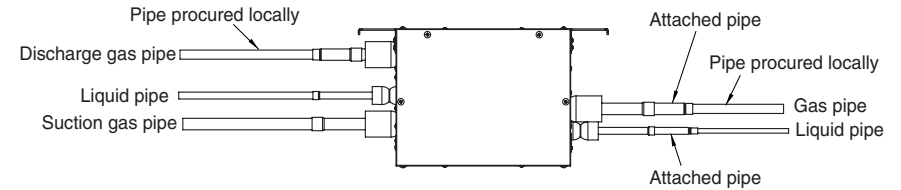

### <RBM-Y1123FE, RBM-Y1803FE>

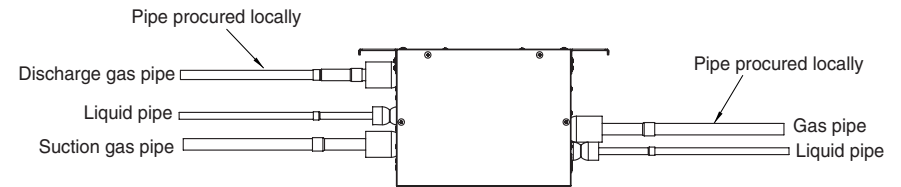

### <RBM-Y2803FE (Use pipes attached with the Flow Selector unit.)>

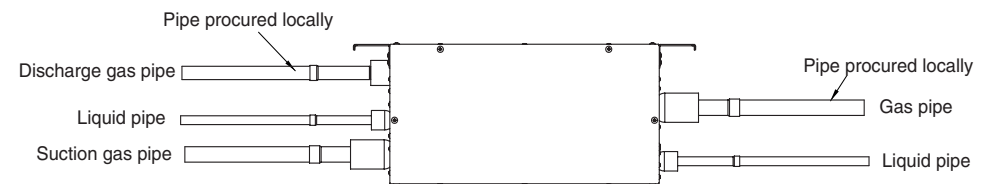

## ⚠ CAUTION

\* Be sure to wrap the pipe with wet cloth when applying brazing.

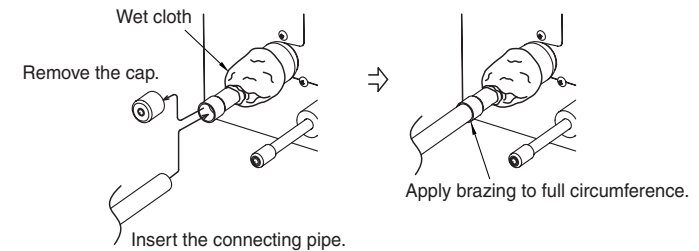

• For a brazing work of the refrigerant pipes, be sure to use nitrogen gas in order to prevent oxidation of the inside of the pipes; otherwise clogging of the refrigerating cycle due to oxidized scale may occur.

\* Remove all flux after brazing.

## 5 REFRIGERANT PIPING

### ■ Airtight test/Air purge, etc.

For airtight test, air purge, addition of refrigerant, and gas leak check, follow the Installation Manual attached to the outdoor unit.

### REQUIREMENT

Be sure to use the tool such as charge hose exclusive to R410A.

Do not turn on the power until the airtight test and the vacuuming have finished.

(If turning on the power, the incorporated PMV is closed fully and the period until the vacuuming finishes elongates.)

### ■ Open fully valves of the outdoor unit

### ■ Gas leak check

Check with a leak detector or soap water whether gas leaks or not, from the pipe connecting section.

### REQUIREMENT

Use a leak detector manufactured exclusively for HFC refrigerant (R410A, R134a, etc.).

### ■ Heat insulating process

Perform heat insulating for pipes at liquid side and gas side separately.

In cooling time, temperature at both liquid and gas sides becomes lower.

Therefore, perform heat insulating process sufficiently to avoid dewing.

- For heat insulator of pipe at gas side, be sure to use one with heat-resisting temp. 120°C or more.
- Using the attached heat insulating pipe, perform heat insulating process securely for pipe connecting part of the Flow Selector units without clearance.

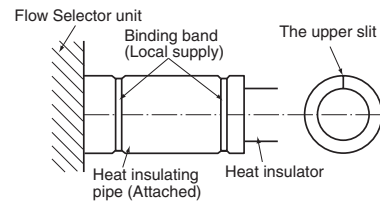

### REQUIREMENT

Apply the heat insulation to the pipe connecting section of the Flow Selector unit securely up to the root without exposure of the pipe. (The pipe exposed to the outside causes water leak.)

## 6 ELECTRIC WORK

### ⚠ WARNING

1. **Using the specified wires, ensure to connect the wires, and fix wires securely so that the external strength of the wires do not transmit to the connecting part of the terminals.**

Incomplete connection or fixation may cause fire, etc.

2. **Be sure to connect earth wire. (Grounding work)**

Do not connect the earth wire to gas pipe, city water pipe, lightning rod, or the earth wire of telephone.

Incomplete grounding causes an electric shock.

3. **For electric work, strictly follow to the Local Regulation in each country and the Installation Manual, and use an exclusive circuit.**

Capacity shortage of power circuit or incomplete installation may an electric shock or fire.

### REQUIREMENT

- Perform the electric wiring so that it does not come to contact with the high-temperature part of the pipe. The coating may melt resulted in an accident.
- After connecting wires to the terminal blocks, provide a trap and fix wires with the wire clamp.
- Store the refrigerant piping line and control wiring line in the same line.
- Do not turn on the power of the indoor unit until vacuuming of the refrigerant pipes completes.

### ■ Wire connections

**Use the supplied, dedicated wires.**

### REQUIREMENT

- Check that power is not supplied to the indoor unit before connecting wires.
- For safety, connect wires to the Flow Selector unit first.
- Be sure to put wires through the wire connecting ports on the Flow Selector unit and the indoor unit.

# 6 ELECTRIC WORK

## [Connection diagram]

- Power is supplied from the connected indoor unit.
  - Connect the attached wires (power supply/control wiring) between the Flow Selector unit and the indoor unit.
- Connect wires as shown in the below figure.
- If the distance between indoor unit and Flow Selector unit exceeds 5m, connect by using the extension cable kit (RBC-CBK15FE). (Sold separately)

RBM-Y1123FE, RBM-Y1803FE / RBM-Y2803FE

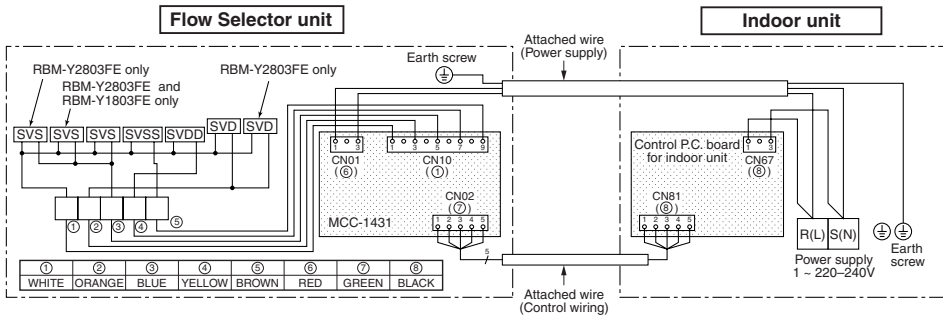

## [Flow Selector unit]

- Remove the fixing screws (4 parts) from the cover of the Flow Selector unit.
- Connect the connector (Red) of the attached wire (power supply) to CN01 on the control P.C. board.
- Connect the ring terminal of the attached wire (power supply) to the earth screw.
- Connect the connector (Green) of the attached wire (control wiring) to CN02 on the control P.C. board.
- Secure the two attached wires with the attached cord clamp.
- (Be careful not to apply tension to the wires and connectors.)
- Check that the wires are not pinched, and then attach the cover.

RBM-Y1123FE, RBM-Y1803FE

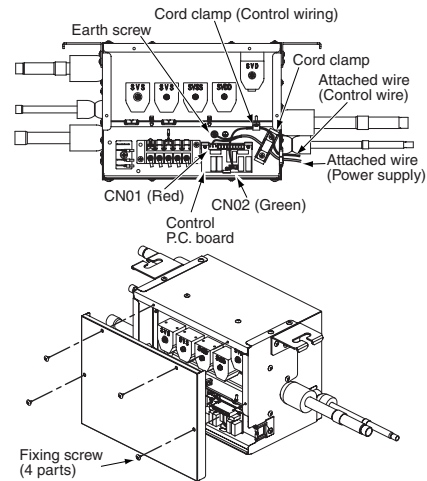

RBM-Y2803FE

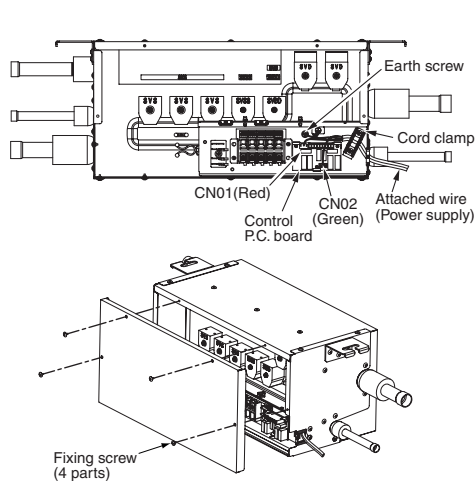

## ■ System wiring diagram

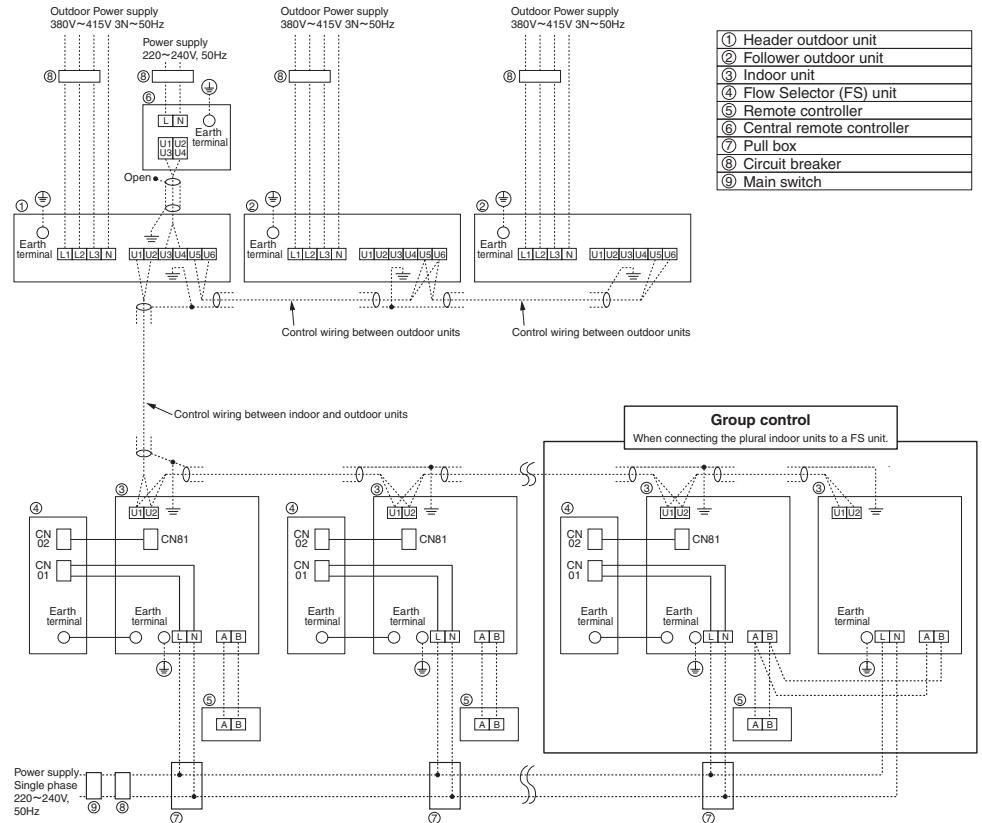

## NOTE :

Control wire and power wire between FS unit and indoor unit are the accessory parts of FS unit. (Wire length : 6m)  
 If the length between indoor and FS unit exceeds 5m, connect by using the connection cable kit sold separately (RBC-CBK15FE).



# 6 ELECTRIC WORK

[Indoor unit]

See also the Installation Manual supplied with the indoor unit.

- Remove the electrical parts box cover from the indoor unit.
- Connect the faston (R(L) and S(N)) on the attached wire (power supply) to a free area on the R(L), S(N) terminal block for power supply.

## ◆ Connections

### Concealed Duct High Static Pressure Type (MMD-AP\*\*\*H Series)

#### ⚠ CAUTION

Connect the wire to the lead wires with wire joint on the R(L), S(N) terminal block for power supply, using the following procedure:

Cut the wire joint on each lead wire, and cut the faston (R(L) and S(N)) on the attached wire (power supply). Then check the R(L) and S(N) phases, and connect the wire and the lead wires with the attached wire joints.

- Connect the ring terminal of the attached wire (power supply) to the earth screw.
- Connect the connector (Black) of the attached wire (control wiring) to CN081 on the indoor P.C. board.
- Secure the two attached wires with the attached cord clamp.
- Check that the wires are not pinched, and then attach the cover.

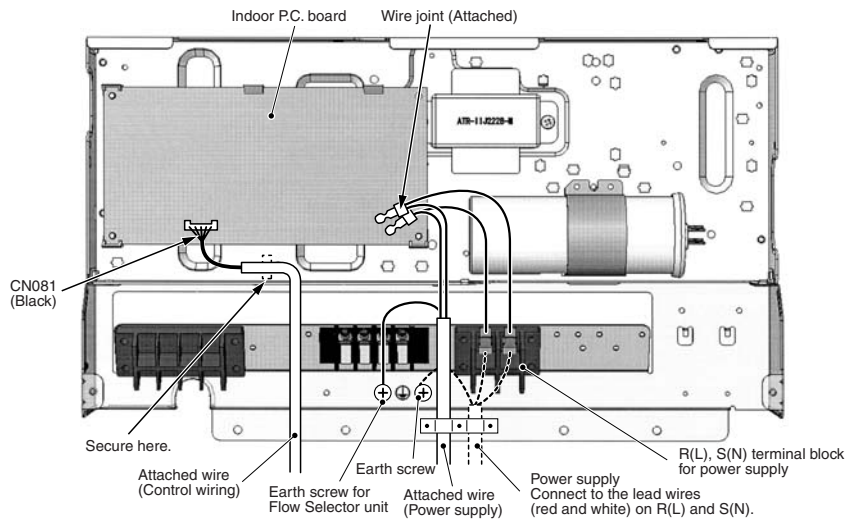

### 4-way Air Discharge Cassette Type (MMU-AP\*\*\*2H Series)

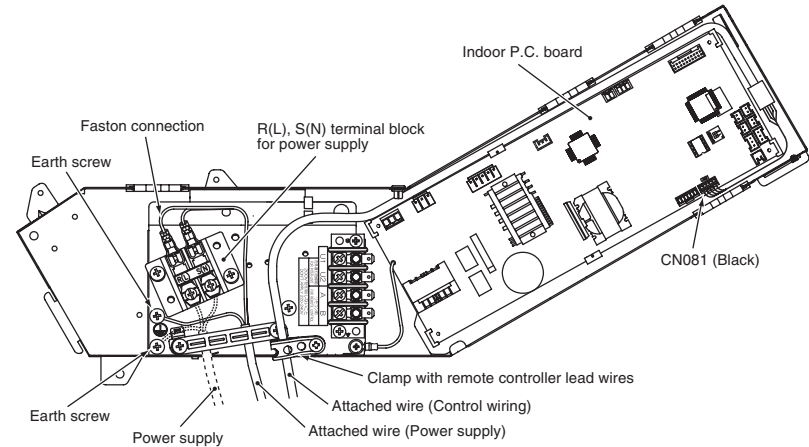

### 4-way Air Discharge Cassette Type (MMU-AP\*\*\*MH Series)

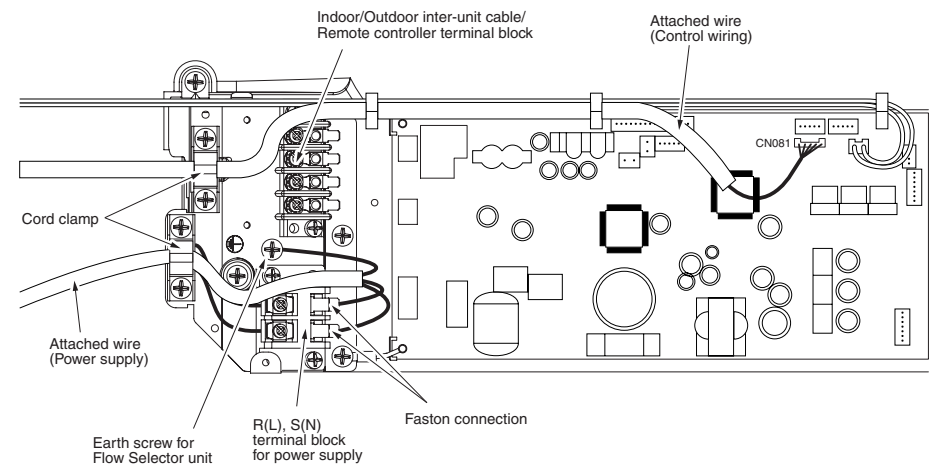

# 6 ELECTRIC WORK

## 2-way Air Discharge Cassette Type (MMU-AP\*\*\*2WH Series)

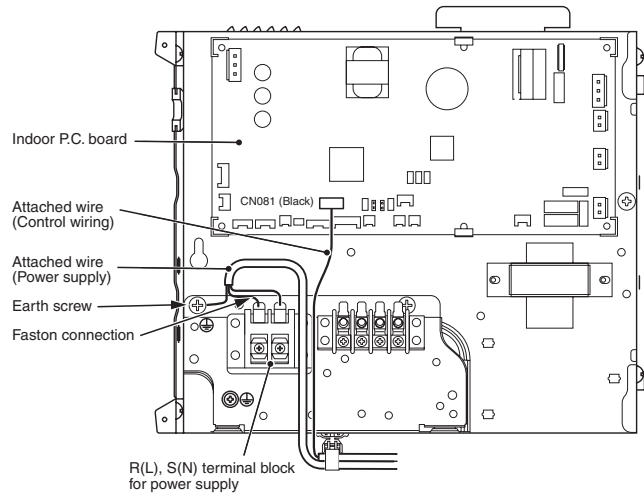

## Floor Standing Type (MMF-AP\*\*\*H Series)

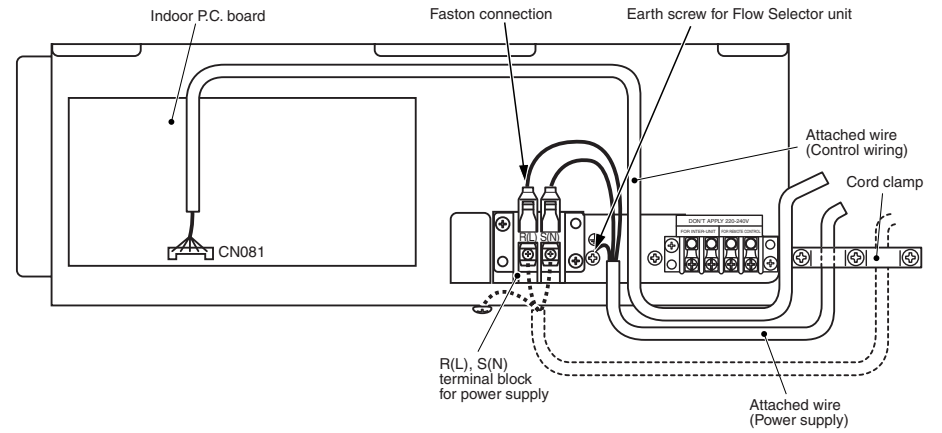

## 1-way Air Discharge Cassette Type (MMU-AP\*\*\*YH Series)

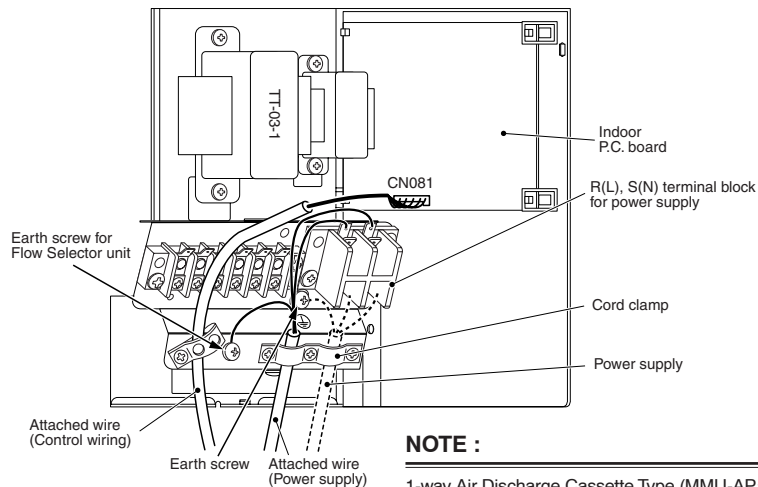

**NOTE :**  
 1-way Air Discharge Cassette Type (MMU-AP\*\*\*SH Series) wiring refer to the Under Ceiling Type (page 11).

## Concealed Slim Duct Type (MMD-AP\*\*\*SPH Series)

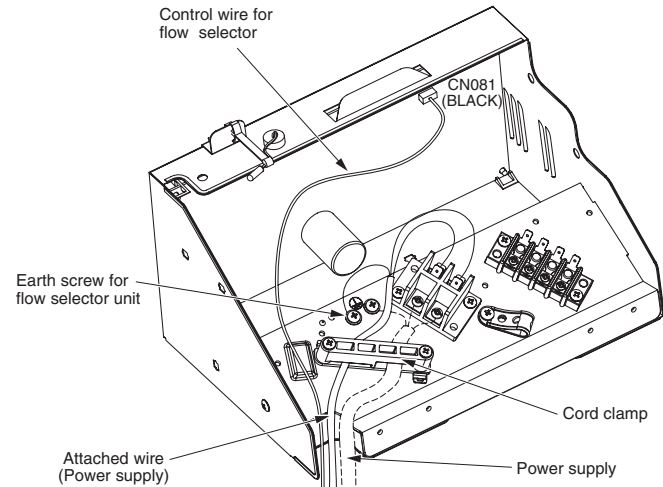

## 6 ELECTRIC WORK

### Concealed Duct Standard Type (MMD-AP\*\*4BH Series)

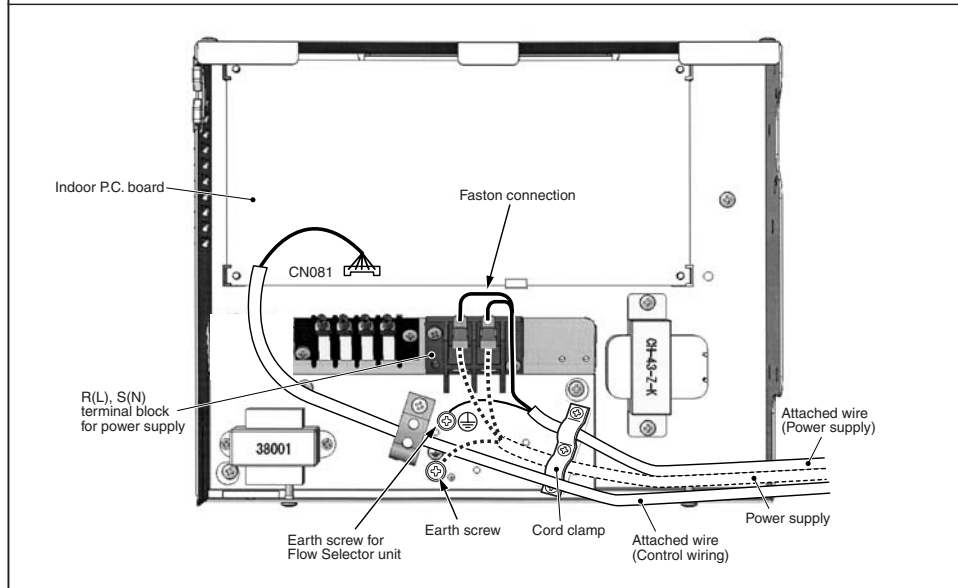

### Under Ceiling Type (MMC-AP\*\*\*H Series) 1-way Air Discharge Cassette Type (MMU-AP\*\*\*SH Series)

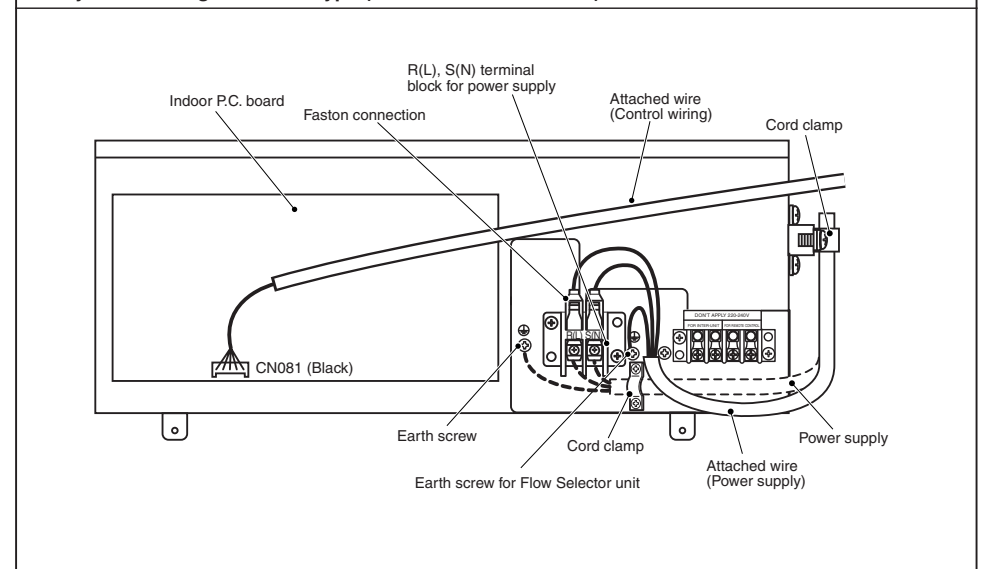

### Concealed Duct Standard Type (MMD-AP\*\*6BH Series)

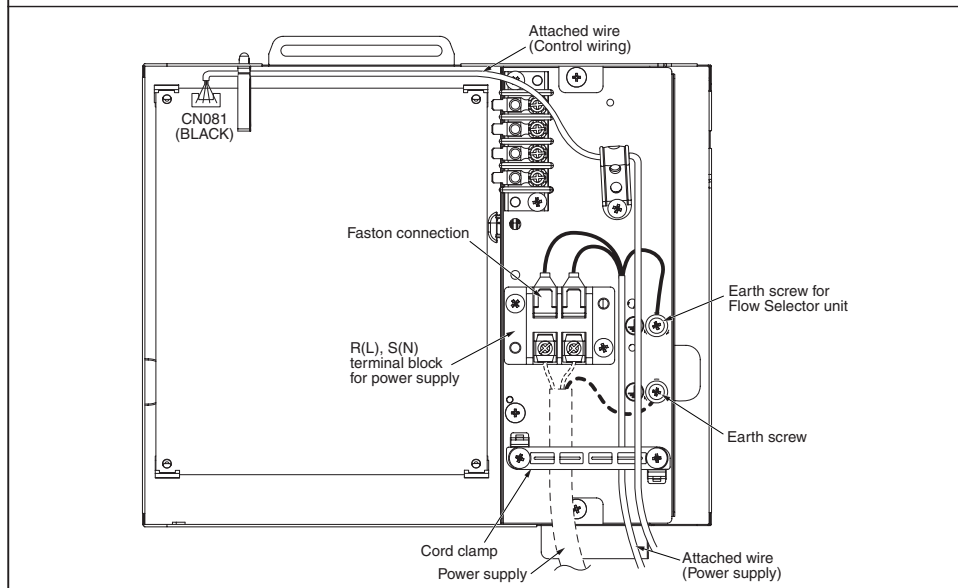

## 6 ELECTRIC WORK

### High Wall Type (MMK-AP\*\*\*4MH Series (MMK-AP\*\*\*2H Series))

For the Flow Selector unit that has power supply cord, connect a power supply cable to it as mentioned below.

1. Open the air inlet grille upward.
2. Remove the four screws securing the front panel.
3. Slightly open the lower part of the front panel then pull the upper part of the front panel toward you to remove it from the rear plate.
4. After removing the front panel, remove the wiring cover and the cord clamp.
5. Connect and secure the power supply cable of Flow Selector unit and secure the cord clamp.
6. The control wires are included in terminal block part of the power supply. Take out the control wires outwards through the slit of the terminal block.
7. Fasten the wiring cover surely with screws.
8. Connect the control wire taken out through the slit on the terminal block and the control wire from the Flow Selector unit at the relay terminal section.

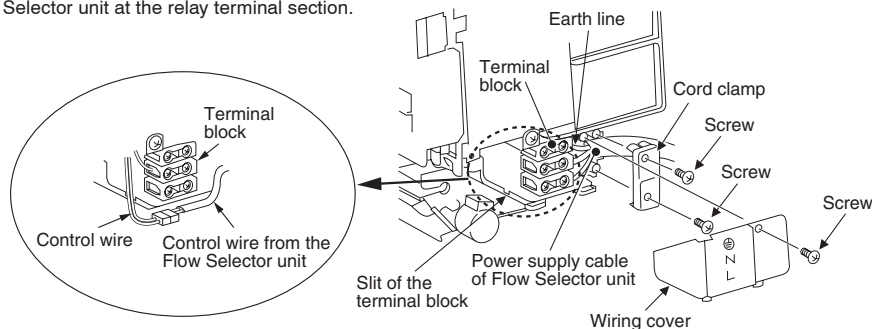

### High Wall Type (MMK-AP\*\*\*3H Series)

Connect the power supply wire and the communication wire supplied with the flow selector unit to the indoor unit.

1. Remove the air inlet grille. Open the air inlet grille upward and pull it toward you.
2. Remove the four screws securing the front panel.
3. Slightly open the lower part of the front panel, and then pull the upper part of the front panel toward you to remove it from the rear plate.
4. Remove the terminal cover and the clamp base.
5. Insert the control wire fully into the control/wired remote controller terminal block and secure it tightly with screws.
6. Connect the control wire connector of the flow selector unit to the lead with a connector to the left of the control/wired remote controller terminal block.
7. Clamp the control wire and the control wire of the flow selector unit with the cord clamp.
8. Install the clamp base with a screw.
9. Insert the power supply wire fully into the terminal block and secure it tightly with screws. Tightening torque: 1.2 N·m (0.12 kg·m). Secure the earth line with the earth screw.
10. Clamp the power supply wire with the cord clamp.
11. Insert the power supply wire faston terminal of the flow selector unit into the power supply terminal. Secure the earth line with the earth screw.
12. Clamp the power supply wire of the flow selector unit tight with the cord clamp.
13. Attach the terminal cover, the front panel and the air inlet grille to the indoor unit.

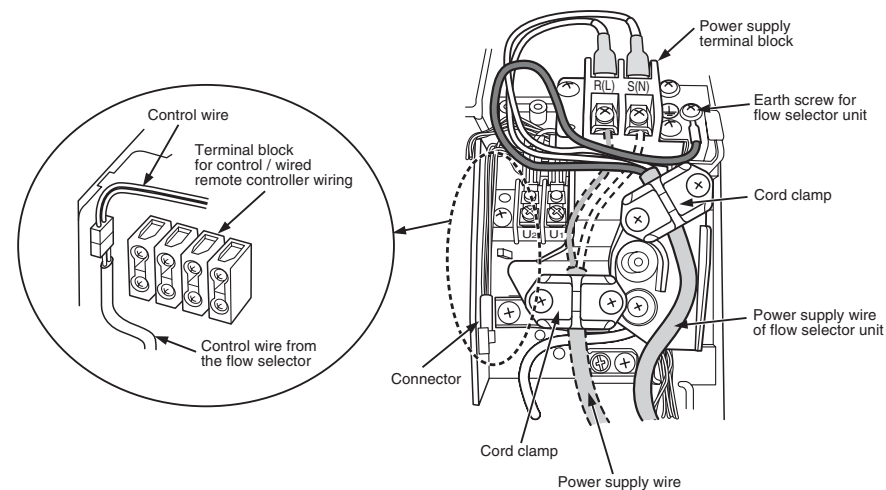

### ⚠ CAUTION

Confirm that every wires are stored in the electric parts box without getting caught before attaching the terminal cover.

# 6 ELECTRIC WORK

## Floor Standing Cabinet Type (MML-AP\*\*\*H Series)

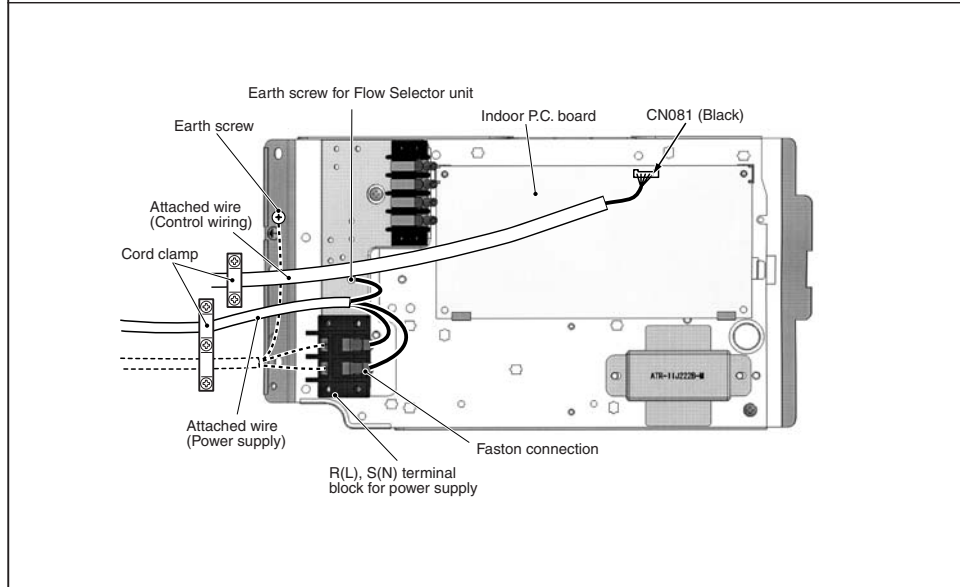

## Air to Air Heat Exchanger with DX Coil Unit (MMD-VN\*\*\*HEXE Series)

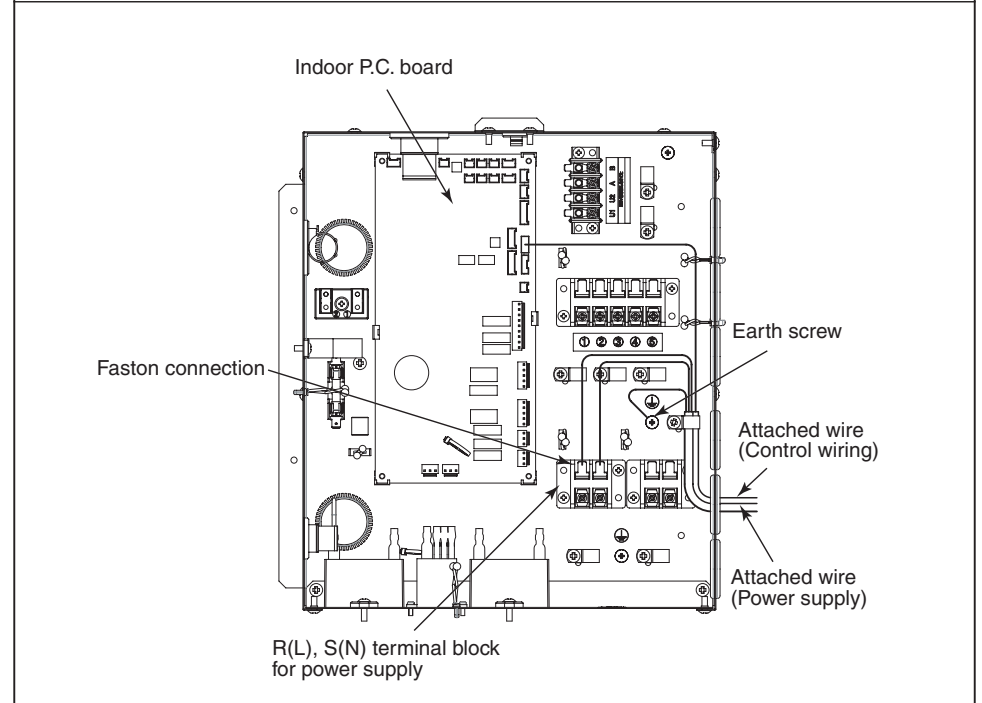

## Floor Standing Concealed Type (MML-AP\*\*\*BH Series)

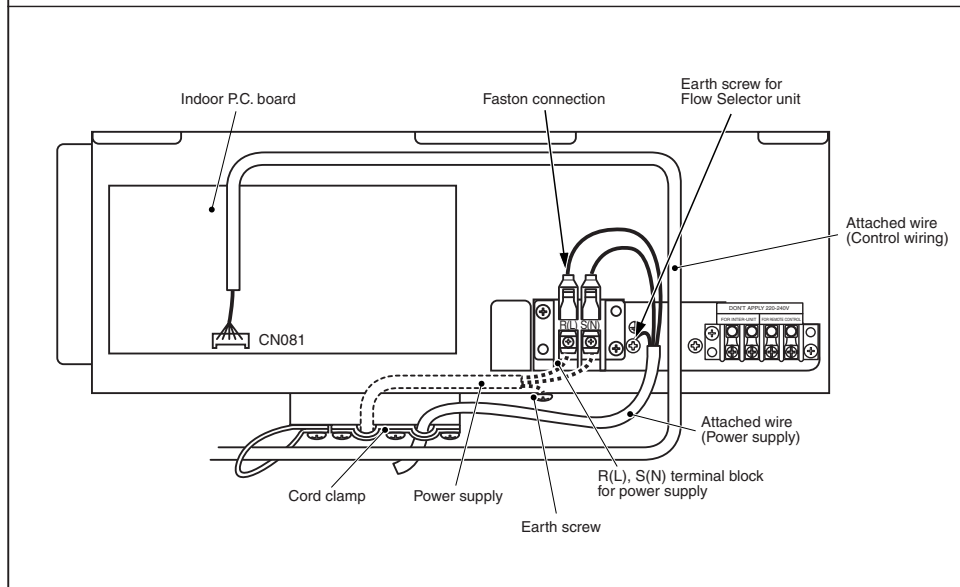

# 6 ELECTRIC WORK

## Console Type (MML-AP\*\*\*H Series)

Connect the power supply wire and the communication wire supplied with the flow selector unit to the indoor unit.

1. Removing the front panel.
2. Remove the terminal cover and cord clamp.
3. Take a power supply wire and control wire (according to the local rule) into the pipe hole on the hole.
4. Take the power supply wire out of the cable slot on the rear panel so that it produces about 430 mm from the front.
5. Insert the power supply wire fully into the terminal block and secure it tightly with screws.  
Tighten torque: 1.2 N/m (0.12 kgf/m)
6. Insert the power supply wire faston terminal of the flow selector unit into the power supply terminal.  
Secure the earth line with the earth screw.
7. Connect the control wire connector of flow selector unit to the control wire.
8. Clamp the power supply wire with the cord clamp.
9. Attach the terminal cover with a screw
10. Take the control wire out of the cable slot on the rear panel so that it produces about 600 mm from the front.
11. Remove the terminal cover (UP)
12. Remove the LED BASE
13. Insert the control wire fully into the control/Wired remote controller terminal block (U), (U), (A), (B) and secure it tightly with screws.
14. Clamp the control wire with the cord clamp.
15. Attach the LED base, terminal cover (UP) and front panel

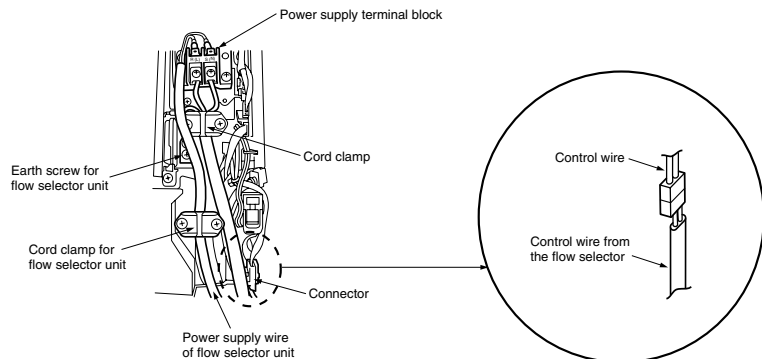

## Setting when connecting multiple indoor units to a Flow Selector (FS) unit

### [Cautions to connection of indoor unit]

- When connecting the multiple indoor units to a single FS unit, it is necessary to set up the Item code. Be sure to set up the Item code after setup of address.
- When connecting the multiple indoor units to a single FS unit, only group control is available. For the indoor unit, a remote controller cannot be individually connected.

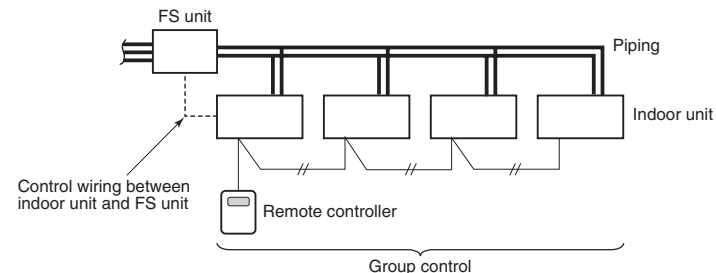

### Incorrect example of connection

When connecting the multiple indoor units to a single FS unit, the indoor units which are connected with the multiple FS units are unavailable for the group control by a single remote controller.

For the indoor unit, a remote controller cannot be individually connected.

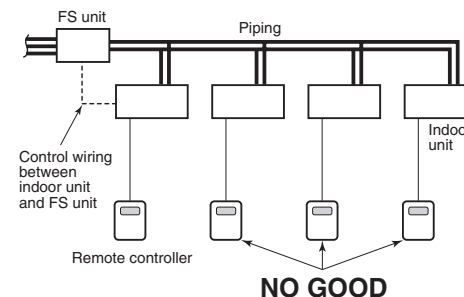
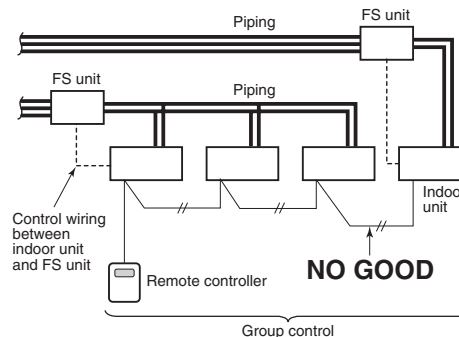

### [How to set up Item code]

- 1 Push **VENT** + **TEST** buttons simultaneously for 4 seconds or more.
  - **ALL** is displayed in the UNIT No. window.
  - In this time, the fans of all the indoor units in the group control start the fan operation.
- 2 Using the set temperature buttons (▼) / (▲), select the Item code "0E".
- 3 Change SET DATA to "01" by the timer buttons (▼) / (▲).
- 4 Push **SET** button.
- 5 Push **TEST** button. Then the setup finished.

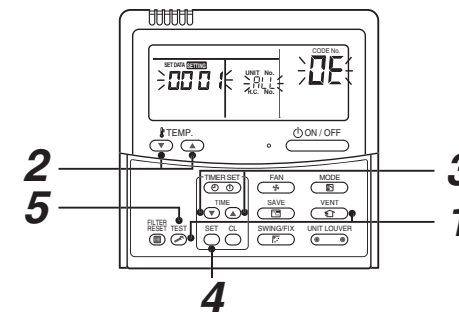

# **TOSHIBA CARRIER CORPORATION**

336, TADEHARA, FUJI-SHI, SHIZUOKA-KEN, 416-8521, JAPAN

EH99893899