

Cool Summer Offer

On those hot sweltering summer days and long restless nights, there is no better escape from the heat than the cool comforts of home. Your new air conditioner brings an end to exhausting hot summer days and lets you rest. This summer, beat the heat with your own air conditioner.

Cost Efficient System

Your new air conditioner not only provides maximum cooling power in the summer, but can also be an efficient heating method in the winter with the advanced "Heat pump" system. This technology is up to 300% more efficient than electrical heating, so you can further reduce its running cost. Now, meet year-round needs with one air conditioner.

Flexible installation

Duct type air conditioner is designed to be slimmer and offers different solutions for any shape room allowing for specific air flow requirements. Also, the air intake can be set up on either the bottom or rear of the unit, so there is more flexibility in installation.

Safety precautions	3
Checking before use	10
Viewing the parts	12
Cleaning and maintaining the air conditioner	13
Appendix	16
Installation parts	20



Correct Disposal of This Product (Waste Electrical & Electronic Equipment)

(Applicable in the countries with separate collection systems)

This marking on the product, accessories or literature indicates that the product and its electronic accessories (e.g. charger, headset, USB cable) should not be disposed of with other household waste at the end of their working life. To prevent possible harm to the environment or human health from uncontrolled waste disposal, please separate these items from other types of waste and recycle them responsibly to promote the sustainable reuse of material resources.

Household users should contact either the retailer where they purchased this product, or their local government office, for details of where and how they can take these items for environmentally safe recycling.

Business users should contact their supplier and check the terms and conditions of the purchase contract. This product and its electronic accessories should not be mixed with other commercial wastes for disposal.







For information on Samsung's environmental commitments and product specific regulatory obligations e.g. REACH visit: samsung.com/uk/aboutsamsung/samsungelectronics/corporatecitizenship/data_corner.html

Safety precautions

Before using your new air conditioner, please read this manual thoroughly to ensure that you know how to safely and efficiently operate the extensive features and functions of your new appliance.

Because the following operating instructions cover various models, the characteristics of your air conditioner may differ slightly from those described in this manual. If you have any questions, call your nearest contact center or find help and information online at www.samsung.com.

Important safety symbols and precautions:

 WARNING	Hazards or unsafe practices that may result in severe personal injury or death .
 CAUTION	Hazards or unsafe practices that may result in minor personal injury or property damage .
	Follow directions.
	Do NOT attempt.
	Make sure the machine is grounded to prevent electric shock.
	Unplug the power plug from the wall socket.
	Do NOT disassemble.

FOR INSTALLATION

WARNING

 Use the power line with the power specifications of the product or higher and use the power line for this appliance only. In addition, do not use an extension line.

- ▶ Extending the power line may result in electric shock or fire.
- ▶ Do not use an electric transformer. It may result in electric shock or fire.
- ▶ If the voltage/frequency/rated current condition is different, it may cause fire.

The installation of this appliance must be performed by a qualified technician or service company.

- ▶ Failing to do so may result in electric shock, fire, explosion, problems with the product, or injury.

Install a switch and circuit breaker dedicated to the air conditioner.

- ▶ Failing to do so may result in electric shock or fire.

Fix the outdoor unit firmly so that the electric part of the outdoor unit is not exposed.

- ▶ Failing to do so may result in electric shock or fire.

Safety precautions

FOR INSTALLATION

WARNING



Do not install this appliance near a heater, inflammable material. Do not install this appliance in a humid, oily or dusty location, in a location exposed to direct sunlight and water (rain drops). Do not install this appliance in a location where gas may leak.

▶ This may result in electric shock or fire.

Never install the outdoor unit in a location such as on a high external wall where it could fall.

▶ If the outdoor unit falls, it may result in injury, death or property damage.



This appliance must be properly grounded. Do not ground the appliance to a gas pipe, plastic water pipe, or telephone line.

▶ Failure to do so may result in electric shock, fire, an explosion, or other problems with the product.

▶ Never plug the power cord into a socket that is not grounded correctly and make sure that it is in accordance with local and national codes.

FOR INSTALLATION

CAUTION



Install your appliance on a level and hard floor that can support its weight.

▶ Failing to do so may result in abnormal vibrations, noise, or problems with the product.

Install the draining hose properly so that water is drained correctly.



▶ Failing to do so may result in water overflowing and property damage.

When installing the outdoor unit, make sure to connect the draining hose so that draining is performed correctly.

▶ The water generated during the heating operation by the outdoor unit may overflow and result in property damage.

In particular, in winter, if a block of ice falls, it may result in injury, death or property damage.

FOR POWER SUPPLY **WARNING**

-  **When the circuit breaker is damaged, contact your nearest service center.**
-  **Do not pull or excessively bend the power line. Do not twist or tie the power line. Do not hook the power line over a metal object, place a heavy object on the power line, insert the power line between objects, or push the power line into the space behind the appliance.**
 - ▶ This may result in electric shock or fire.

FOR POWER SUPPLY **CAUTION**

-  **When not using the air conditioner for a long period of time or during a thunder/lightning storm, cut the power at the circuit breaker.**
 - ▶ Failing to do so may result in electric shock or fire.

FOR USING **WARNING**

-  **If the appliance is flooded, please contact your nearest service center.**
 - ▶ Failing to do so may result in electric shock or fire.
- If the appliance generates a strange noise, a burning smell or smoke, unplug the power plug immediately and contact your nearest service center.**
 - ▶ Failing to do so may result in electric shock or fire.
- In the event of a gas leak (such as propane gas, LP gas, etc.), ventilate immediately without touching the power line.**
- Do not touch the appliance or power line.**
 - ▶ Do not use a ventilating fan.
 - ▶ A spark may result in an explosion or fire.
- To reinstall the air conditioner, please contact your nearest service center.**
 - ▶ Failing to do so may result in problems with the product, water leakage, electric shock, or fire.
 - ▶ A delivery service for the product is not provided. If you reinstall the product in another location, additional construction expenses and an installation fee will be charged.
 - ▶ Especially, when you wish to install the product in an unusual location such as in an industrial area or near the seaside where it is exposed to the salt in the air, please contact your nearest service center.

Safety precautions

FOR USING

WARNING



Do not touch the circuit breaker with wet hands.

- ▶ This may result in electric shock.

Do not strike or pull the air conditioner with excessive force.

- ▶ This may result in fire, injury, or problems with the product.

Do not place an object near the outdoor unit that allows children to climb onto the machine.

- ▶ This may result in children seriously injuring themselves.

Do not turn the air conditioner off with the circuit breaker while it is operating.

- ▶ Turning the air conditioner off and then on again with the circuit breaker may cause a spark and result in electric shock or fire.

After unpacking the air conditioner, keep all packaging materials well out of the reach of children, as packaging materials can be dangerous to children.

- ▶ If a child places a bag over its head, it may result in suffocation.

Do not insert your fingers or foreign substances into the outlet when the air conditioner is operating or the front panel is closing.

- ▶ Take special care that children do not injure themselves by inserting their fingers into the product.

Do not touch the front panel with your hands or fingers during the heating operation.

- ▶ This may result in electric shock or burns.

Do not insert your fingers or foreign substances into the air inlet/outlet of the air conditioner.

- ▶ Take special care that children do not injure themselves by inserting their fingers into the product.

Do not use this air conditioner for long periods of time in badly ventilated locations or near infirm people.

- ▶ Since this may be dangerous due to a lack of oxygen, open a window at least once an hour.

FOR USING

WARNING

 **If any foreign substance such as water has entered the appliance, cut the power by unplugging the power plug and turning the circuit breaker off and then contact your nearest service center.**

▶ Failing to do so may result in electric shock or fire.

 **Do not attempt to repair, disassemble, or modify the appliance yourself.**

▶ Do not use any fuse (such as cooper, steel wire, etc.) other than the standard fuse.

▶ Failing to do so may result in electric shock, fire, problems with the product, or injury.

FOR USING

CAUTION

 **Do not place objects or devices under the indoor unit.**

▶ Water dripping from the indoor unit may result in fire or property damage.

Check that the installation frame of the outdoor unit is not broken at least once a year.

▶ Failing to do so may result in injury, death or property damage.

Max current is measured according to IEC standard for safety and current is measured according to ISO standard for energy efficiency.

 **Do not stand on top of the appliance or place objects (such as laundry, lighted candles, lighted cigarettes, dishes, chemicals, metal objects, etc.) on the appliance.**

▶ This may result in electric shock, fire, problems with the product, or injury.

Do not operate the appliance with wet hands.

▶ This may result in electric shock.

Do not spray volatile material such as insecticide onto the surface of the appliance.

▶ As well as being harmful to humans, it may also result in electric shock, fire or problems with the product.

Do not drink the water from the air conditioner.

▶ The water may be harmful to humans.

Do not apply a strong impact to the remote controller and do not disassemble the remote controller.

Do not touch the pipes connected with the product.

▶ This may result in burns or injury.

Safety precautions

FOR USING



CAUTION

 **Do not use this air conditioner to preserve precision equipment, food, animals, plants or cosmetics, or for any other unusual purposes.**

▶ This may result in property damage.

Avoid directly exposing humans, animals or plants from the air flow from the air conditioner for long periods of time.

▶ This may result in harm to humans, animals or plants.

This appliance is not intended for use by persons (including children) with reduced physical, sensory or mental capabilities, or lack of experience and knowledge, unless they have been given supervision or instruction concerning use of the appliance by a person responsible for their safety. Children should be supervised to ensure that they do not play with the appliance.

For use in Europe :

▶ This appliance can be used by children aged from 8 years and above and persons with reduced physical, sensory or mental capabilities or lack of experience and knowledge if they have been given supervision or instruction concerning use of the appliance in a safe way and understand the hazards involved. Children shall not play with the appliance. Cleaning and user maintenance shall not be made by children without supervision.

FOR CLEANING



WARNING

 **Do not clean the appliance by spraying water directly onto it. Do not use benzene, thinner or alcohol to clean the appliance.**

▶ This may result in discoloration, deformation, damage, electric shock or fire.

Before cleaning or performing maintenance, unplug the air conditioner from the wall socket and wait until the fan stops.

▶ Failing to do so may result in electric shock or fire.

FOR CLEANING



CAUTION

! Take care when cleaning the surface of the heat exchanger of the outdoor unit since it has sharp edges.

▶ To avoid cutting your fingers, wear thick cotton gloves when cleaning it.

⊘ Do not clean the inside of the air conditioner by yourself.

▶ For cleaning inside the appliance, contact your nearest service center.

▶ When cleaning the internal filter, refer to the descriptions in the 'Cleaning and maintaining the air conditioner' section.

▶ Failure to do may result in damage, electric shock or fire.

Checking before use

Operation ranges

The table below indicates the temperature and humidity ranges the air conditioner can be operated within.

Refer to the table for efficient use.

MODE	OUTDOOR TEMPERATURE	INDOOR TEMPERATURE	INDOOR HUMIDITY
COOLING	-15°C/5°F to 50°C/122°F	18°C/64°F to 32°C/90°F	80% or less
HEATING	-20°C/-4°F to 24°C/75°F	27°C/81°F to less	
DRYING	-15°C/5°F to 50°C/122°F	18°C/64°F to 32°C/90°F	



NOTE

- The standardized temperature for heating is 7°C/45°F. If the outdoor temperature drops to 0°C/32°F or below, the heating capacity can be reduced depending on the temperature condition. If the cooling operation is used at over 32°C/90°F (indoor temperature), it does not cool at its full capacity.



CAUTION

- The use of the air conditioner at a relative humidity above the expected one (80%) may cause the formation of condensate and the leakage of water drops on the floor.

Maintaining your air conditioner

Internal protections via the unit control system

► This internal protection operates if an internal fault occurs in the air conditioner.

Type	Description
Against cold air	The internal fan will be off to against cold air when the heat pump is heating.
De-ice cycle (Defrost cycle)	The internal fan will be off to against cold air when the heat pump is heating.
Anti-protection of internal battery	The compressor will be off to protect internal battery when the air conditioner operates in Cool mode.
Protect compressor	The air conditioner does not start operating immediately to protect the compressor of the outdoor unit after it has been started.



NOTE

- If the heat pump is operating in Heat mode, De-ice cycle is actuated to remove frost from an outdoor unit that may have deposited at low temperatures. The internal fan is switched off automatically and restarted only after the de-ice cycle is completed.

Tips on using air conditioner

Here are some tips that you would follow when using your air conditioner.

TOPIC	RECOMMENDATION
Cooling	<ul style="list-style-type: none">• If current outside temperatures are much higher than the selected indoor temperature, it may take time to bring the inner temperature to the desired coolness.• Avoid drastically turning down the temperature. Energy is wasted and the room does not cool faster.
Heating	<ul style="list-style-type: none">• Since the air conditioner heats the room by taking heat energy from outdoor air, the heating capacity may decrease when outdoor temperatures are extremely low. If you feel the air conditioner insufficiently heats, using an additional heating appliance in combination with the air conditioner is recommended.
Frost & De-ice	<ul style="list-style-type: none">• When the air conditioner runs in Heat mode, due to temperature difference between the unit and the outside air, frost will form. If this happens:<ul style="list-style-type: none">- The air conditioner stops heating.- The air conditioner will operate automatically in De-ice mode for 10 minutes.- The steam produced on the outdoor unit in De-ice mode is safe.No intervention is required; after about 10 minutes, the air conditioner operates again normally. * The unit will not operate when it starts to de-ice.
Fan	<ul style="list-style-type: none">• Fan may not operate for about 3~5 minutes at the beginning to prevent any cold blasts while the air conditioner is warming up.
High indoor/ outdoor temperatures	<ul style="list-style-type: none">• If both indoor and outdoor temperatures are high and the air conditioner is running in Heat mode, the outdoor unit's fan and compressor may stop at times. This is normal; wait until the air conditioner turns on again.
Power failure	<ul style="list-style-type: none">• If a power failure occurs during the operation of the air conditioner, the operating immediately stops and unit will be off. When power returns, the air conditioner will run automatically.
Protection mechanism	<ul style="list-style-type: none">• If the air conditioner has just been turned on after operation stops or being plugged in, cool/warm air does not come out for 3 minutes to protect the compressor of the outdoor unit.

Viewing the parts

Congratulations on the purchase of the air conditioner. We hope you enjoy the features of your air conditioner and stay cool or warm with optimal efficiency.

Please read the user manual to get started and to make the best use of the air conditioner.

GLOBAL DUCT Type

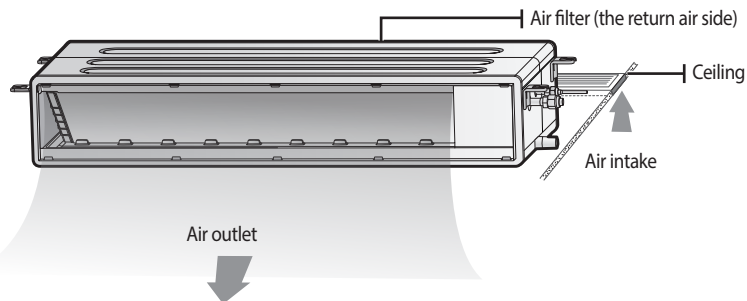

- Your air conditioner and display may look slightly different from the illustration shown above depending on your model.

Cleaning and maintaining the air conditioner

GLOBAL DUCT (Plastic Type)

1. Press both hooks and take the filter downward.

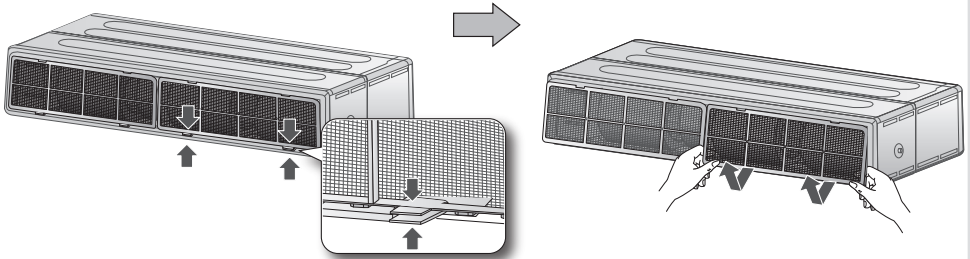

2. Clean the Air filter with a vacuum cleaner or soft brush. If dust is too heavy, then rinse it with running water and dry it in a ventilated area.

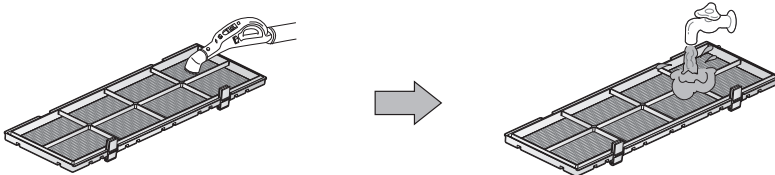

- For best conditions, repeat every two weeks.
- If the Air filter dries in a confined (or humid) area, odors may generate. If it occurs, re-clean and dry it in a ventilated area.

3. Insert the Air filter back in its original position.

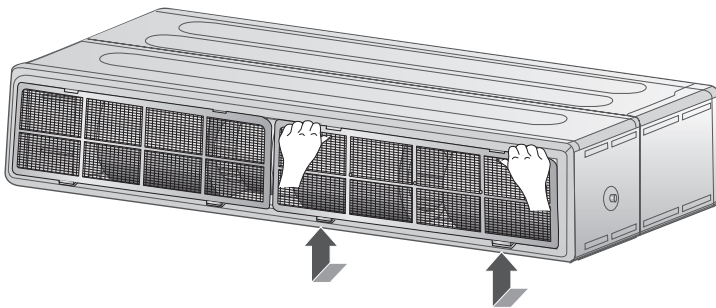

- NOTE**
- The illustration shown above may differ from yours depending on your model.
 - After cleaning the filter, press the **Filter Reset** button on the remote control for 2 seconds to reset the filter schedule. Filter sign indicator will be on for cleaning time.

Cleaning and maintaining the air conditioner

GLOBAL DUCT (Steel wire Type)

1. Pull out the Air filter from the frame .

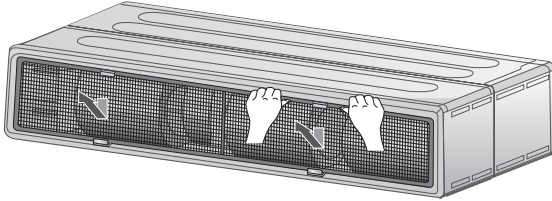

2. Clean the Air filter with a vacuum cleaner or soft brush. If dust is too heavy, then rinse it with running water and dry it in a ventilated area.

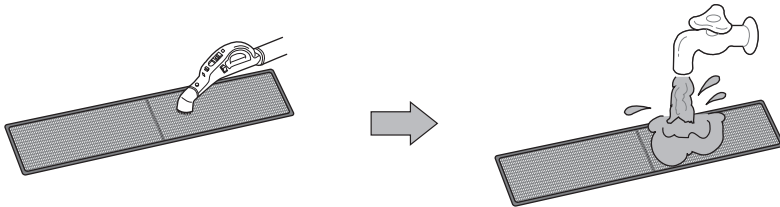

- For best conditions, repeat every two weeks.
- If the Air filter dries in a confined (or humid) area, odors may generate. If it occurs, re-clean and dry it in a ventilated area.

3. Insert the Air filter back in its original position.

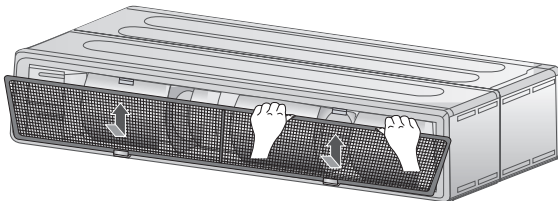

- NOTE
- The illustration shown above may differ from yours depending on your model.
 - After cleaning the filter, press the **Filter Reset** button on the remote control for 2 seconds to reset the filter schedule. Filter sign indicator will be on for cleaning time.

If the air conditioner will not be used for an extended period of time, dry the air conditioner to maintain it in best condition.

- ▶ Dry the air conditioner thoroughly by operating in Fan mode for 3 to 4 hours and disconnect the power plug.
There may be internal damage if moisture is left in components.
- ▶ Before using the air conditioner again, dry the inner components of the air conditioner again by running in Fan mode for 3 to 4 hours. This helps remove odors which may have generated from dampness.

Periodical checks

Refer to the following chart to maintain the air conditioner properly.

Type	Description	Monthly	Every 4 months	Once a year
Indoor unit	Clean the air filter (1)	●		
	Clean the condensate drain pan (2)			●
	Thoroughly clean the heat exchanger (2)			●
	Clean the condensate drain pipe (2)		●	
	Replace the remote control batteries (1)			●
Outdoor unit	Clean the heat exchanger on the outside of the unit (2)		●	
	Clean the heat exchanger on the inside of the unit (2)			●
	Clean the electric components with jets of air (2)			●
	Verify that all the electric components are firmly tightened (2)			●
	Clean the fan (2)			●
	Verify that all the fan assembly is firmly tightened (2)			●
	Clean the condensate drain pan (2)			●

- : This check mark requires checking the indoor/outdoor unit periodically, following to the description to maintain the air conditioner properly.



NOTE

- The described operations should be performed more frequently if the area of installation is very dusty.



CAUTION

- These operations must always be performed by qualified personnel. For more detailed information, see the installation part in the manual.

Appendix

Troubleshooting

Refer to the following chart if the air conditioner operates abnormally. This may save time and unnecessary expenses.

PROBLEM	SOLUTION
The air conditioner does not operate immediately after it has been restarted.	<ul style="list-style-type: none">• Because of the protective mechanism, the appliance does not start operating immediately to keep the unit from overloading. The air conditioner will start in 3 minutes.
The air conditioner does not work at all.	<ul style="list-style-type: none">• Check that the power plug is properly connected. Insert the power plug into the wall socket correctly.• Check if the circuit breaker is switched off.• Check if there is a power failure.• Check your fuse. Make sure it is not blown out.
The temperature does not change.	<ul style="list-style-type: none">• Check if you selected Fan mode. Press the Mode button on the remote control to select another mode.
The cool (warm) air does not come out of the air conditioner.	<ul style="list-style-type: none">• Check if the set temperature is higher (lower) than the current temperature. Press the Temperature button on the remote control to change the set temperature. Press the Temperature button to decrease or increase the temperature.• Check if the air filter is blocked by dirt. Clean the air filter every two weeks.• Check if the air conditioner has just been turned on. If so, wait 3 minutes. Cool air does not come out to protect the compressor of the outdoor unit.• Check if the air conditioner is installed in a place with a direct exposure to sunlight. Hang curtains on windows to boost cooling efficiency.• Check if the cover or any obstacle is not near the outdoor unit.• Check if the refrigerant pipe is too long.• Check if the air conditioner is only available in Cool mode.• Check if the remote control is only available for cooling model.

PROBLEM	SOLUTION
The fan speed does not change.	<ul style="list-style-type: none"> Check if you selected Auto or Dry mode. The air conditioner automatically adjusts the fan speed to Auto in Auto/Dry mode.
Timer function does not set.	<ul style="list-style-type: none"> Check if you press the Power button on the remote control after you have set the time.
Odors permeate in the room during operation.	<ul style="list-style-type: none"> Check if the appliance is running in a smoky area or if there is a smell entering from outside. Operate the air conditioner in Fan mode or open the windows to air out the room.
The air conditioner makes a bubbling sound.	<ul style="list-style-type: none"> A bubbling sound may be heard when the refrigerant is circulating through the compressor. Let the air conditioner operate in a selected mode. When you press the Power button on the remote control, noise may be heard from the drain pump inside the air conditioner.
Water is dripping from the air flow blades.	<ul style="list-style-type: none"> Check if the air conditioner has been cooling for an extended period of time with the air flow blades pointed downwards. Condensation may generate due to the difference in temperature.
Remote control is not working.	<ul style="list-style-type: none"> Check if your batteries are depleted. Make sure batteries are correctly installed. Make sure nothing is blocking your remote control sensor. Check that there are strong lighting apparatus near the air conditioner. Strong light which comes from fluorescent bulbs or neon signs may interrupt the electric waves.
The air conditioner does not turn on or off with the wired remote control.	<ul style="list-style-type: none"> Check if you set the wired remote control for group control.
The wired remote control does not operate.	<ul style="list-style-type: none"> Check if TEST indicator is displayed on the wired remote control. If so, turn off the unit and switch off the circuit breaker. Call your nearest contact center.
The indicators of the digital display flashes.	<ul style="list-style-type: none"> Press the Power button on the remote control to turn the unit off and switch the circuit breaker off. Then, switch it on again.

Appendix

Model specification (Dimension and weight)

Dimension and weight			
Type	Model	Net dimension (WxDxH) (mm)	Net weight (kg)
Indoor unit	AM036HNMPKH	850*700*250	25.5
	AM045HNMPKH	850*700*250	25.5
	AM056HNMPKH	850*700*250	25.5
	AM071HNMPKH	850*700*250	25.5
	AM090HNMPKH	1200*700*250	32.5
	AM112HNMPKH	1300*700*300	36.5
	AM128HNMPKH	1300*700*300	36.5
	AM140HNMPKH	1300*700*300	36.5
	AM112HNHPKH	1300*700*300	46
	AM128HNHPKH	1300*700*300	46
	AM140HNHPKH	1300*700*300	46

Indoor unit installation

When deciding on the location of the air conditioner with the owner, the following restrictions must be taken into account.

- 1 Place the pattern sheet on the ceiling at the spot where you want to install the indoor unit.



NOTE

- Since the diagram is made of paper, it may shrink or stretch slightly due to temperature or humidity. For this reason, before drilling the holes maintain the correct dimensions between the markings.
- Pattern sheet is supplied depending on the model type.

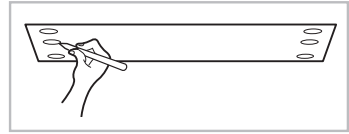

- 2 Insert bolt anchors. Use existing ceiling supports or construct a suitable support as shown in figure.
- 3 Install the suspension bolts depending on the ceiling type.



CAUTION

- Ensure that the ceiling is strong enough to support the weight of the indoor unit. Before hanging the unit, test the strength of each attached suspension bolt.
- If the length of suspension bolt is more than 1.5m, it is required to prevent vibration.
- If this is not possible, create an opening on the false ceiling in order to be able to use it to perform the required operations on the indoor unit.

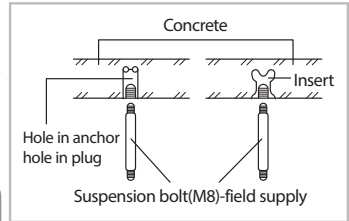

- 4 Screw eight nuts to the suspension bolts making space for hanging the indoor unit.



NOTE

- You must install all the suspension rods.

- 5 Hang the indoor unit to the suspension bolts between two nuts.



CAUTION

- Piping must be laid and connected inside the ceiling when suspending the unit. If the ceiling is already constructed, lay the piping into position for connection to the unit before placing the unit inside the ceiling.

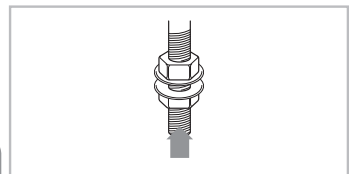
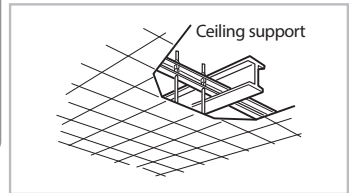

- 6 Screw the nuts to suspend the unit.

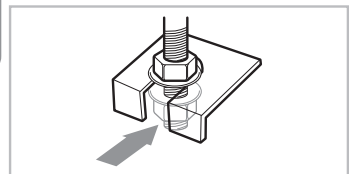

- 7 Adjust level of the unit by using measurement plate for all 4 sides.



CAUTION

- For proper drainage of condensate, give a 3mm slant to the left or right side of the unit which will be connected with the drain hose, as shown in the figure. Make a tilt when you wish to install the drain pump, too.
- When installing the indoor unit, make sure it is not tilted toward front or back side.

When the drain hose is installed to the right.

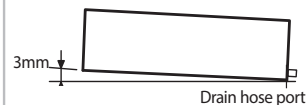

Performing leak test & insulation

Leak test

◆ LEAK TEST WITH NITROGEN (before opening valves)

In order to detect basic refrigerant leaks, before recreating the vacuum and recirculating the R410A, it's responsible of installer to pressurize the whole system with nitrogen (using a cylinder with pressure reducer) at a pressure above 40 bar (gauge).

◆ LEAK TEST WITH R410A (after opening valves)

Before opening valves, discharge all the nitrogen into the system and create vacuum. After opening valves check leaks using a leak detector for refrigerant R410A.



- Discharge all the nitrogen to create a vacuum and charge the system.

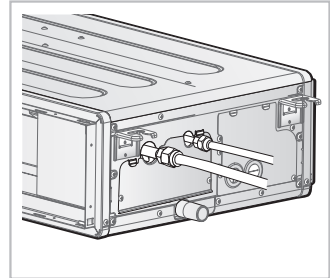

* The designs and shape are subject to change according to the model.

Insulation

Once you have checked that there are no leaks in the system, you can insulate the piping and hose.

- 1 To avoid condensation problems, place T13.0 or thicker Acrylonitrile Butadien Rubber separately around each refrigerant pipe.



- Always make the seam of pipes face upwards.



- The insulation has to be produced in full compliance of European regulation reg. EEC / EU 2037/ 2000 that requires the use of sheaths insulation form without using CFC and HCFC gases for health and the environment.

- 2 Wind insulating tape around the pipes and drain hose avoiding to compress the insulation too much.
- 3 Finish wrapping insulating tape around the rest of the pipes leading to the outdoor unit.
- 4 The pipes and electrical cables connecting the indoor unit with the outdoor unit must be fixed to the wall with suitable ducts.



- All refrigerant connection must be accessible, in order to permit either unit maintenance or removing it completely.

- 5 Select the insulation of the refrigerant pipe.

- ◆ Insulate the gas side and liquid side pipe referring to the thickness according to the pipe size.
- ◆ Indoor temperature of 30°C and humidity of 85% is the stan dard condition.
If installing in a high humidity condition, use one grade thicker insulator by referring to the table below.
If installing in an unfavorable conditions, use thicker one.
- ◆ Insulator's heat-resistance temperature should be more than 120°C.

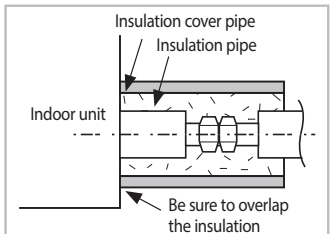
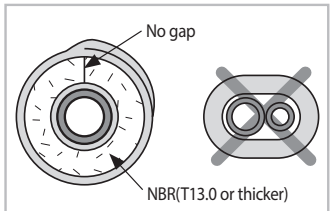

- Must fit tightly against body without any gap.

Performing leak test & insulation

Pipe	Pipe size	Insulation Type (Heating/Cooling)		Remarks
		Standard [30°C, 85%]	High humidity [30°C, over 85%]	
		EPDM, NBR		
Liquid pipe	Ø6.35 ~ Ø9.52	9t	9t	Internal temperature is higher than 120°C
	Ø12.7 ~ Ø19.05	13t	13t	
Gas pipe	Ø6.35	13t	19t	
	Ø9.52	19t	25t	
	Ø12.70			
	Ø15.88			
	Ø19.05			

◆ When installing insulation in places and conditions below, use the same insulation that is used for high humidity conditions.

<Geological condition>

- High humidity places such as shoreline, hot spring, near lake or river, and ridge (when the part of the building is covered by earth and sand.)

<Operation purpose condition>

- Restaurant ceiling, sauna, swimming pool etc.

<Building construction condition>

- The ceiling frequently exposed to moisture and cooling is not covered.

e.g. The pipe installed at a corridor of a dormitory and studio or near an exit that opens and closes frequently.

- The place where the pipe is installed is highly humid due to the lack of ventilation system.

Drainpipe and drain hose installation

Care must be taken when installing the drain hose for the indoor unit to ensure that any condensate water is correctly drained outside.

The drain hose can be installed to the right of the base pan.

- 1 Installing the drain hose should be the shorter, the better.

 - ◆ In order to discharge condensation water, the drain hose should keep tilted.
 - ◆ Fix the drain hose with Cable-Tie, so that it will not separate from the machine.
 - ◆ While using draining pump, connect the end with draining pump.
- 2 Insulate and fix the drain hose according to the figure.

 - ◆ Insert the drain hose to bottom of the outfall of water basin.
 - ◆ Lock steel ring of the drain hose according to the figure.
 - ◆ Wind and wrap steel ring and drain hose fully with thermal insulation sponge; fix both ends of external layer with ribbon for thermal insulation.
 - ◆ After being installed, drain hose must be insulated fully by heat insulating material. (To be provided at site.)

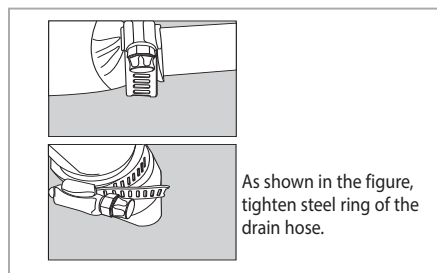
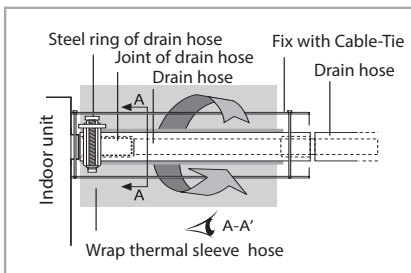

Drainpipe and drain hose installation

Drainpipe Connection

Without the drain pump

1. Install horizontal drainpipe with a slope of 1/100 or more and fix it by hanger space of 1.0~1.5m.
2. Install U-trap at the end of the drainpipe to prevent a nasty smell to reach the indoor unit.
3. Do not install the drainpipe to upward position. It may cause water flow back to the unit.

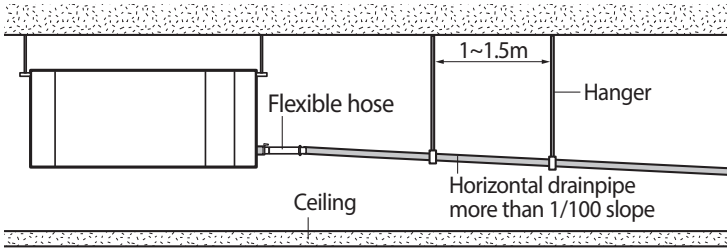

With the drain pump

1. The drain pipe should be installed within 300mm to 550mm from the flexible hose and then lift down 20mm or more.
2. Install horizontal drainpipe with a slope of 1/100 or more and fix it by hanger space of 1.0~1.5m.
3. Install the air vent in the horizontal drainpipe to prevent water flow back to the indoor unit.



• You may not need to install it if there were proper slope in the horizontal drainpipe.

4. The flexible hose should not be installed upward position, it may cause water flow back to the indoor unit.

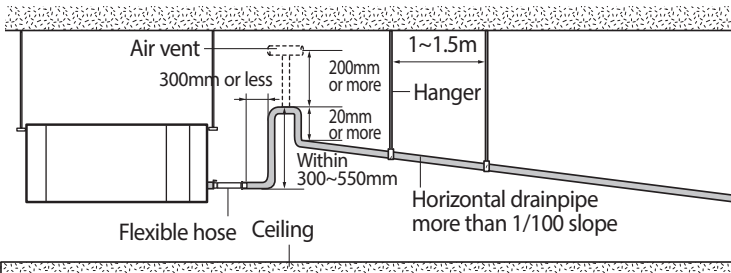

Drainpipe and drain hose installation

Centralized Drainage

Without the drain pump

- 1 Install horizontal drainpipe with a slope of 1/100 or more and fix it by hanger space of 1.0~1.5m.
- 2 Install U-trap at the end of the drainpipe to prevent a nasty smell to reach the indoor unit.

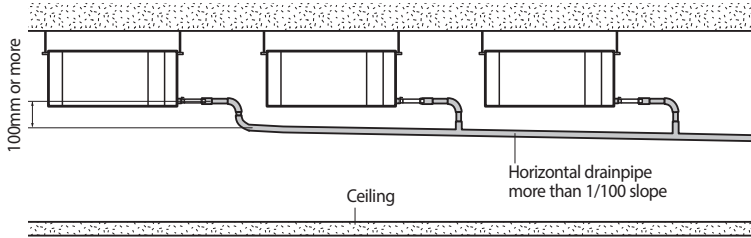

With the drain pump

- 1 Install main air vent at the front of the farthest indoor unit from the main drain when installed indoor units are more than 3.
- 2 You may need to install individual air vent to prevent water flow back at the top of each indoor unit drainpipe.

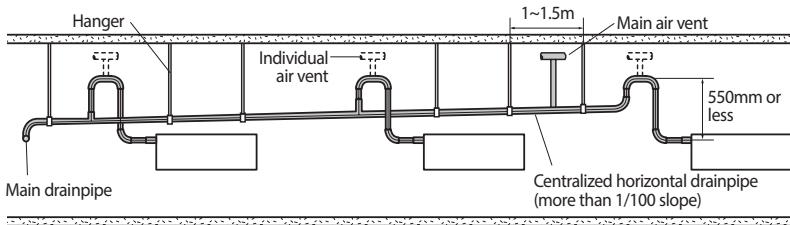

Testing the drainage

Prepare a little water about 2 liter.

- 1 Pour water into the base pan in the indoor unit as shown in figure.
- 2 Confirm that the water flows out through the drain hose.

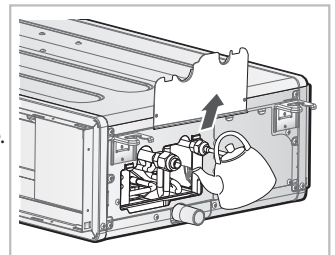

Wiring work

Power and communication cable connection

1. Before wiring work, you must turn off all power source.
2. Indoor unit power should be supplied through the breaker(ELCB or MCCB+ELB) separated by the outdoor power.
ELCB:Earth Leakage Circuit Breaker
MCCB:Molded Case Circuit Breaker
ELB:Earth Leakage Breaker
3. The power cable should be used only copper wires.
4. Connect the power cable{1(L), 2(N)} among the units within maximum length and communication cable(F1, F2) each.
5. Connect F3, F4(for communication) when installing the wired remote control.

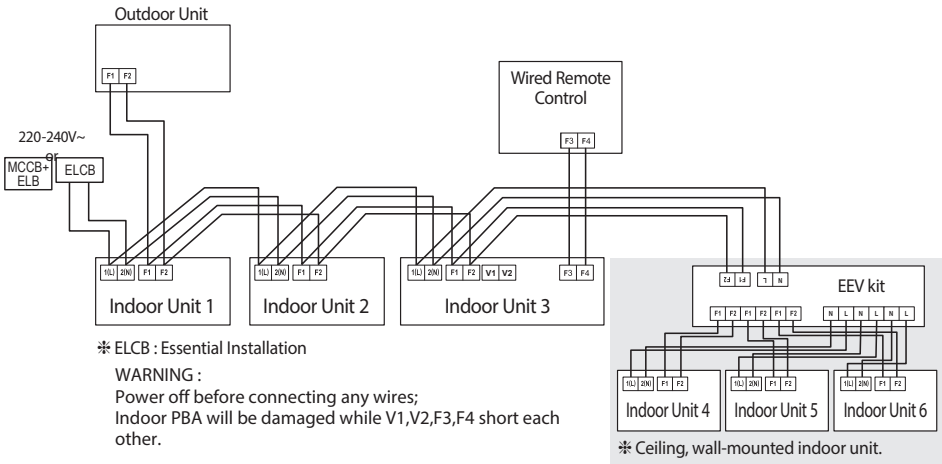

Selecting compressed ring terminal

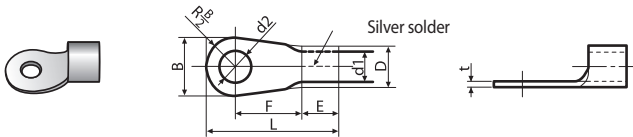

Nominal dimensions for cable (mm ²)	Nominal dimensions for screw (mm)	B		D		d1		E	F	L	d2		t
		Standard dimension (mm)	Allowance (mm)	Standard dimension (mm)	Allowance (mm)	Standard dimension (mm)	Allowance (mm)				Standard dimension (mm)	Allowance (mm)	
1.5	4	6.6	±0.2	3.4	+0.3 -0.2	1.7	±0.2	4.1	6	16	4.3	+0.2 0	0.7
	4	8											
2.5	4	6.6	±0.2	4.2	+0.3 -0.2	2.3	±0.2	6	6	17.5	4.3	+0.2 0	0.8
	4	8.5											
4	4	9.5	±0.2	5.6	+0.3 -0.2	3.4	±0.2	6	5	20	4.3	+0.2 0	0.9

Wiring work

Specification of electronic wire

Power supply	MCCB	ELB or ELCB	Power cable	Earth cable	Communication cable
Max : 242V Min : 198V	X A	X A, 30mmA 0.1 s	2.5mm ²	2.5mm ²	0.75~1.5mm ²

- ◆ Decide the capacity of ELCB(or MCCB+ELB) by below formula.
- ◆ Power supply cords of parts of appliances for outdoor use shall not be lighter than polychloroprene sheathed flexible cord.
(Code designation IEC:60245 IEC 57 / CENELEC:H05RN-F ; IEC:60245 IEC 66 / CENELEC:H07RN-F)

$$\text{The capacity of ELCB(or MCCB+ELB) } X [A] = 1.25 \times 1.1 \times \sum A_i$$

- * X: The capacity of ELCB(or MCCB+ELB).
- * $\sum A_i$: Sum of Rating currents of each indoor unit.
- * Refer to each installation manual about the rating current of indoor unit.

- ◆ Decide the power cable specification and maximum length within 10% power drop among indoor units.

$$\sum_{k=1}^n \left(\frac{\text{Coef} \times 35.6 \times L_k \times i_k}{1000 \times A_k} \right) < 10\% \text{ of input voltage [V]}$$

- * coef: 1.55
- * L_k : Distance among each indoor unit[m], A_k : Power cable specification[mm²]
 i_k : Running current of each unit[A]

Adjusting air flow

Automatic Air-Volume

When DPM is installed, Automatic Air-Volume function cannot be performed simultaneously for all indoor units. Automatic Air-Volume function must be performed for each indoor unit with the wired remote control attached. With its BLDC motor, you can use smart adjust the indoor unit fan speed depending on the installation condition. If the external static pressure is high so that the duct becomes longer or if the external static pressure is low so that the duct becomes shorter, Using the Automatic Air-Volume function, the volume of exhaust air has been adjusted to the rated volume flow rate automatically.

Performing the Automatic Air-Volume function.

- Check the air conditioning unit stop.

Press the Power button to stop the air conditioner

- Go to Service setting mode with remote controller.

1). Press the **Set** and **ESC** buttons at the same time for more than 3 seconds and then a Main menu will be displayed.

2). Press the **▲/▼** button to select **8** and then press **▶** button to enter a Sub-menu setting screen.

3). Press the **▲/▼** button to select **2** and then press **▶** button to enter a automatic air-volume setting screen.

4). Press the **▲/▼** button to select 1 to enable automatic air-volume operation.

5). Select mode No. 8.2, and set to "1".

6). Press the **▲/▼** button to select 3 and then press **▶** button to enter input voltage.

7). Press the **▲/▼** button to select 1~3 to set voltage.

(1 : 220V, 2 : 230V, 3 : 240V)

8). Press the **Set** button, then the air conditioning unit will start the fan operation for Automatic Air-Volume adjustment.

* Do not adjust the dampers during fan operation for Automatic Air-Volume adjustment.

9). Press **ESC** button to escape setting mode.

(During the automatic air-volume adjustment, [Main Menu] will be displayed **8** → **2** → **1** → **3** repetitively)

10). After 1 to 8 minutes, the air conditioning unit stops operating automatically when Automatic Air-Volume adjustment has been carried out (fan operation icon will be off.)

11). When the air conditioning unit has stopped, check the Mode No. 8.1 is "1" for completion of Automatic Air-Volume.

If the Mode No. 8.1 is "0", Automatic Air-Volume adjustment is fail. Then adjust the fan speed by referring the E. S. P (External Static Pressure) setting table.

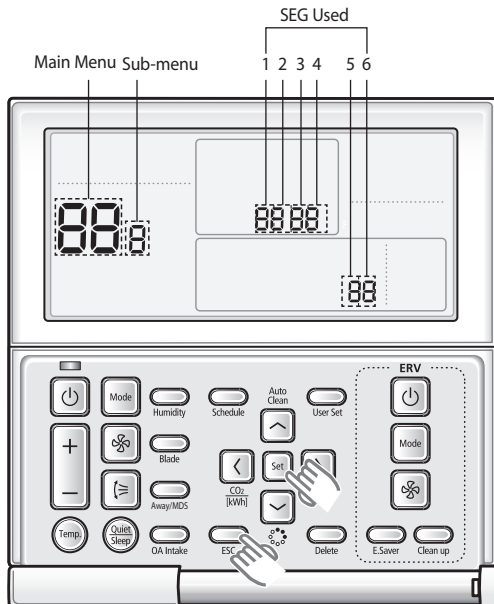

Adjusting air flow

Main menu	Sub menu	Functions	SEG used	Default	Range
8	1	Automatic Air-Volume State Return	1	0	0 - OFF (Fail or Disable) 1 - Completion. 2 - Running Automatic Air-Volume.
	2	Automatic Air-Volume Operation	1	0	0 - Disable 1 - Enable
	3	Automatic Air-Volume Voltage Setting	1	2	1- 220V 2- 230V (Default) 3- 240V



NOTE

- If the coil is not dry, run the unit for 2 hours with fan only to dry the coil.
- The air filter is properly attached into the air passage on the air suction side of the air conditioning unit.
- Adjust the dampers so that each air inlet and outlet exhusts the designed airflow rate.
- If using booster fans(an outdoor air processing unit or ERV via duct), do not use Automatic Air-Volume function.
- If the duct configurations have been changed, automatic air-volume function perform again.
- The product can be used within the range of rated voltage 220 V/230 V/240 V \pm 5 V. If the product needs to be installed in the condition that is out of the rated voltage stated above, additional setting with installation option is required.

Easy Tuning

EASY Tuning

If the more cooling and heating airflow rate which set up when installing is wanted, or if the more Silent operation which sets up when installing is wanted, air conditioner is tuned for comfort.

Indoor unit airflow rate for high, mid, low mode increases or decreases for +2 ~ -2 Steps with wired remotecon.

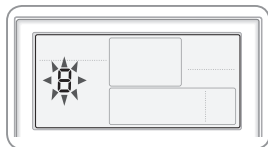

1. Press the User Set button.

▶ (Main Menu) will be displayed, and you can press the [▲]/[▼] buttons to select No. 8, which will set the Easy Tuning.

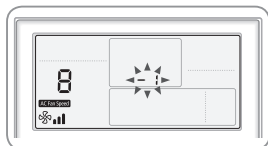

2. Press the [>] button to select airflow step.

▶ Press the [▲]/[▼] buttons to select airflow step(-2,-1,0,1,2) tuning (During the Easy Tuning setting, AC Fan Speed icon will be displayed)



3) Press the [Set] button to complete the Easy Tuning.

(When the Easy Tuning setting complete, AC Fan Speed icon will be off)

4) Press the [ESC] button to to exit to normal mode.

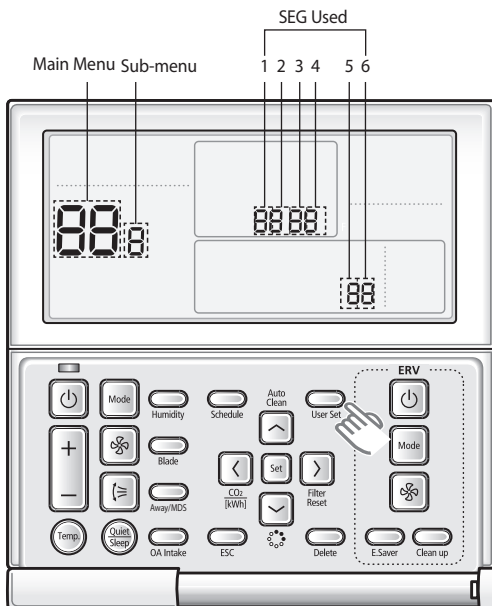

Main menu	Sub menu	Functions	SEG used	Default	Range
8	-	Easy Tuning	1,2	0	-2: -2 Step -1: -1 Step 0: No Use 1: +1 Step 2: +2 Step

NOTE

- Press the [ESC] button anytime during setup to exit without setting.
- According to airflow changed from the Easy Tuning, Air conditioning performance reducing is possible.

Setting the indoor unit option code

In order to set the indoor unit option code use the wired remote controller and follow the directions below.

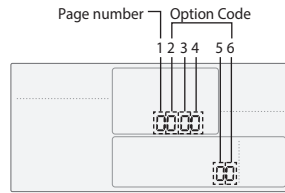
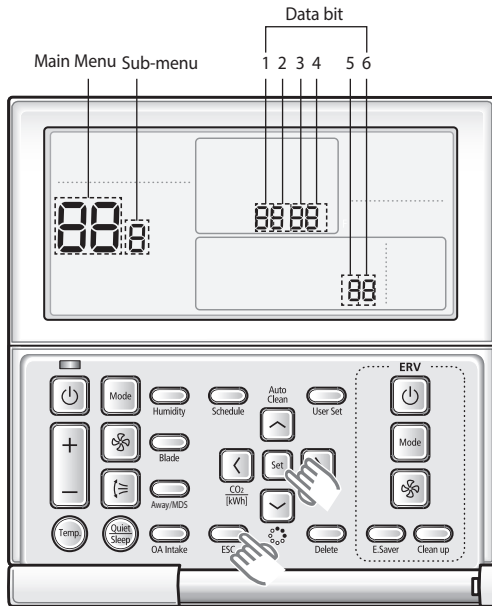

SEG1	SEG2	SEG3	SEG4	SEG5	SEG6
0	*	*	*	*	*

Page number

SEG7	SEG8	SEG9	SEG10	SEG11	SEG12
1	*	*	*	*	*

Page number

SEG13	SEG14	SEG15	SEG16	SEG17	SEG18
2	*	*	*	*	*

Page number

SEG19	SEG20	SEG21	SEG22	SEG23	SEG24
3	*	*	*	*	*

Page number

- 1) Press the **Set** and **ESC** buttons at the same time for more than 3 seconds and then a Main menu will be displayed.
- 2) Press the **▲/▼** button to select **4** and then press **▶** button to enter a Sub-menu setting screen.
- 3) Press the **▲/▼** button to select **2** and then press **▶** button to enter a Indoor unit option code setting screen.

- NOTE**
- The first digit represents the page number and the remaining five digits are option codes.
 - The option code which is currently setting will flicker.

- 4) Press the **▲/▼** button to set the option code in order. Press **▶** button to go to the next page.
- 5) Press the **Set** button to save and complete the option setting.
- 6) Press the **ESC** button to exit to normal mode.

- NOTE**
- Press the **ESC** button anytime during setup to exit without setting.



- CAUTION**
- Option code will not be applied if you don't press the **Set**
 - Setting indoor unit option code is only possible in Master wired remote controller. You can only check the indoor unit option code in Slave wired remote controller.
 - Setting indoor unit option code is possible when one indoor unit is connected. If more than 2 indoor units are connected, you can only check the Master indoor unit option code.

Setting an indoor unit address and installation option

Set the indoor unit address and installation option with remote controller option. Set the each option separately since you cannot set the ADDRESS setting and indoor unit installation setting option at the same time. You need to set twice when setting indoor unit address and installation option.

Setting an indoor unit address

- 1) Press the **Set** and **ESC** buttons at the same time for more than 3 seconds and then a Main menu will be displayed.
- 2) Press the **↵/⏪** button to select **4** and then press **➤** button to enter a Sub-menu setting screen.
- 3) Press the **↵/⏪** button to select **1** and then press **➤** button to enter a Indoor Address setting screen.

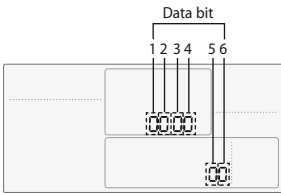

NOTE

- The Main/RMC Address which is currently setting will flicker.
- Data bit 1 and 2 present Indoor unit main address checking
- Data bit 3 and 4 present Indoor unit main address setting(outdoor unit reset is needed to set).
- Data bit 5 and 6 present Indoor unit RMC address setting/checking.

- 4) Press the **↵/⏪** button to set the Indoor unit Main/RMC Address.
- 5) Press the **Set** button to save and complete the option setting.
- 6) Press the **ESC** button to exit to normal mode.



NOTE

- Press the **ESC** button anytime during setup to exit without setting.
- Address will not be applied if you don't press **Set** button.
- Setting Main/RMC Address of an Indoor unit is available only with a master wired remote controller.

Setting an indoor unit installation option

In order to check and set the indoor unit installation option code use the wired remote controller and follow the directions below.

- 1) Press the **Set** and **ESC** buttons at the same time for more than 3 seconds and then a Main menu will be displayed.
- 2) Press the **↵/⏪** button to select **4** and then press **➤** button to enter a Sub-menu setting screen.
- 3) Press the **↵/⏪** button to select **3** and then press **➤** button to enter a Indoor unit installation option code setting screen.

Setting an indoor unit address and installation option



NOTE

- The first digit represents the page number and the remaining five digits are installation option.
- The total option codes are 24 digits. You can set six digits at a time and it is distinguished by page number (0, 1, 2, 3).

4) Press the / button to set the installation option code in order. Press button to go to the next page.

SEG1	SEG2	SEG3	SEG4	SEG5	SEG6
0	2	--	External room temperature sensor / Minimizing fan operation when thermostat is off	Central control	FAN RPM compensation
SEG7	SEG8	SEG9	SEG10	SEG11	SEG12
1	Drain pump	Hot water heater	--	EEV Step when heating stops	--
SEG13	SEG14	SEG15	SEG16	SEG17	SEG18
2	External control	External control output / External heater On or Off signal	S-Plasma ion	Buzzer	Number of hours using filter
SEG19	SEG20	SEG21	SEG22	SEG23	SEG24
3	Individual control of a remote controller	Heating setting compensation / Removing condensated water in heating mode	EEV Step of stopped unit during oil return/ defrost mode	Motion detect sensor	--

5) Press the button to save and complete the option setting.

6) Press the button to exit to normal mode.



NOTE

- Press button anytime during setup to exit without setting.
- Option code will not be applied if you don't press button.
- Setting Installation option code is available only with a master wired remote controller.
- Setting Installation option code is available when there is one on one connection between a wired remote controller and an indoor unit.

Set the indoor unit address and installation option with remote controller option.
 Set the each option separately since you cannot set the ADDRESS setting and indoor unit installation setting option at the same time. You need to set twice when setting indoor unit address and installation option.

The procedure of option setting

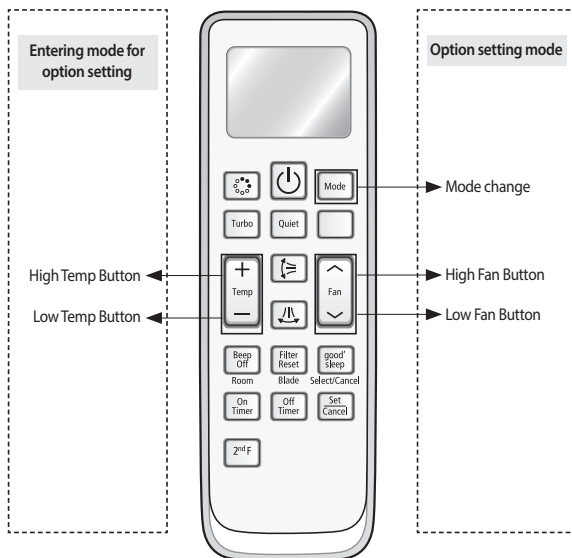

Step 1. Entering mode to set option

1. Remove batteries from the remote controller.
2. Insert batteries and enter the option setting mode while pressing High Temp button and Low Temp button.

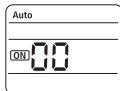

3.  Check if you have entered the option setting status.

Step 2. The procedure of option setting

After entering the option setting status, select the option as listed below.







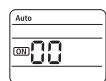
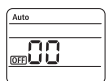



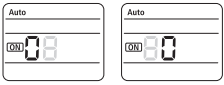

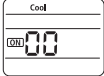
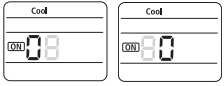

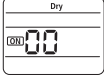

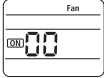
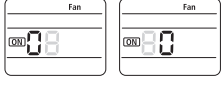

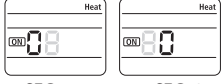











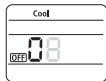
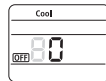





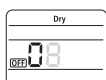
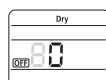

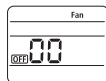
- Option setting is available from SEG1 to SEG 24
- SEG1, SEG7, SEG13, SEG19 are not set as page option.
- Set the SEG2~SEG6, SEG8~SEG12 as ON status and SEG14~18, SEG20~24 as OFF status.

SEG1	SEG2	SEG3	SEG4	SEG5	SEG6	SEG7	SEG8	SEG9	SEG10	SEG11	SEG12
0	X	X	X	X	X	1	X	X	X	X	X
SEG13	SEG14	SEG15	SEG16	SEG17	SEG18	SEG19	SEG20	SEG21	SEG22	SEG23	SEG24
2	X	X	X	X	X	3	X	X	X	X	X

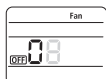
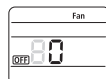
On(SEG1~12)	Off(SEG13~24)
	

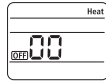
Setting an indoor unit address and installation option

Option setting	Status
<p>1. Setting SEG2, SEG3 option Press Low Fan button(∨) to enter SEG2 value. Press High Fan button(∧) to enter SEG3 value. Each time you press the button, 0 → 1 → ... E → F will be selected in rotation.</p>	
<p>2. Setting Cool mode  Press Mode button to be changed to Cool mode in the ON status.</p>	
<p>3. Setting SEG4, SEG5 option Press Low Fan button(∨) to enter SEG4 value. Press High Fan button(∧) to enter SEG5 value. Each time you press the button, 0 → 1 → ... E → F will be selected in rotation.</p>	
<p>4. Setting Dry mode  Press Mode button to be changed to DRY mode in the ON status.</p>	
<p>5. Setting SEG6, SEG8 option Press Low Fan button(∨) to enter SEG6 value. Press High Fan button(∧) to enter SEG8 value. Each time you press the button, 0 → 1 → ... E → F will be selected in rotation.</p>	
<p>6. Setting Fan mode  Press Mode button to be changed to FAN mode in the ON status.</p>	
<p>7. Setting SEG9, SEG10 option Press Low Fan button(∨) to enter SEG9 value. Press High Fan button(∧) to enter SEG10 value. Each time you press the button, 0 → 1 → ... E → F will be selected in rotation.</p>	
<p>8. Setting Heat mode  Press Mode button to be changed to HEAT mode in the ON status.</p>	
<p>9. Setting SEG11, SEG12 option Press Low Fan button(∨) to enter SEG11 value. Press High Fan button(∧) to enter SEG12 value. Each time you press the button, 0 → 1 → ... E → F will be selected in rotation.</p>	
<p>10. Setting Auto mode  Press Mode button to be changed to AUTO mode in the OFF status.</p>	
<p>11. Setting SEG14, SEG15 option Press Low Fan button(∨) to enter SEG14 value. Press High Fan button(∧) to enter SEG15 value. Each time you press the button, 0 → 1 → ... E → F will be selected in rotation.</p>	

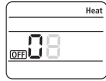
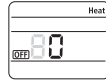
Option setting	Status
<p>12. Setting Cool mode</p>  Press Mode button to be change to Cool mode in the OFF status.	
<p>13. Setting SEG16, SEG17 option</p> <p>Press Low Fan button(V) to enter SEG16 value. Press High Fan button(^) to enter SEG17 value. Each time you press the button,  →  → ...  →  will be selected in rotation.</p>	  SEG16 SEG17
<p>14. Setting Dry mode</p>  Press Mode button to be change to Dry mode in the OFF status.	
<p>15. Setting SEG18, SEG20 option</p> <p>Press Low Fan button(V) to enter SEG18 value. Press High Fan button(^) to enter SEG20 value. Each time you press the button,  →  → ...  →  will be selected in rotation.</p>	  SEG18 SEG20
<p>16. Setting Fan mode</p>  Press Mode button to be change to Fan mode in the OFF status.	
<p>17. Setting SEG21, SEG22 option</p> <p>Press Low Fan button(V) to enter SEG21 value. Press High Fan button(^) to enter SEG22 value. Each time you press the button,  →  → ...  →  will be selected in rotation.</p>	  SEG21 SEG22
<p>18. Setting Heat mode</p>  Press Mode button to be change to HEAT mode in the OFF status.	
<p>19. Setting SEG23, SEG24 mode</p> <p>Press Low Fan button(V) to enter SEG23 value. Press High Fan button(^) to enter SEG24 value. Each time you press the button,  →  → ...  →  will be selected in rotation.</p>	  SEG23 SEG24

Step 3. Check the option you have set

After setting option, press  button to check whether the option code you input is correct or not.

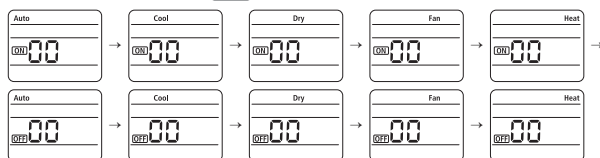

Step 4. Input option

Press operation button  with the direction of remote control for set.
For the correct option setting, you must input the option twice.

Step 5. Check operation

1. Reset the indoor unit by pressing the RESET button of indoor unit or outdoor unit.
2. Take the batteries out of the remote controller and insert them again and then press the operation button.

Setting an indoor unit address and installation option

Setting an indoor unit address (MAIN/RMC)

- Check whether power is supplied or not.
 - When the indoor unit is not plugged in, there should be additional power supply in the indoor unit.
- The panel(display) should be connected to an indoor unit to receive option.
- Before installing the indoor unit, assign an address to the indoor unit according to the air conditioning system plan.
- Assign an indoor unit address by wireless remote controller.
 - The initial setting status of indoor unit ADDRESS(MAIN/RMC) is "0A0000-100000-200000-300000".

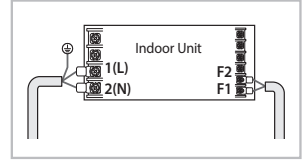

Option No. : 0AXXXX-1XXXXX-2XXXXX-3XXXXX

Option	SEG1		SEG2		SEG3		SEG4		SEG5		SEG6	
Explanation	PAGE		Mode		Setting Main address		100-digit of indoor unit address		10-digit of indoor unit		The unit digit of an indoor unit	
Remote Controller Display												
Indication and Details	Indication	Details	Indication	Details	Indication	Details	Indication	Details	Indication	Details	Indication	Details
	0		A		0	No Main address						
					1	Main address setting mode	0~9	100-digit	0~9	10-digit	0~9	A unit digit
Option	SEG7		SEG8		SEG9		SEG10		SEG11		SEG12	
Explanation	PAGE				Setting RMC address				Group channel(*16)		Group address	
Remote Controller Display												
Indication and Details	Indication	Details	—		Indication	Details	—		Indication	Details	Indication	Details
	1				0	No RMC address						
					1	RMC address setting mode			RMC1	0~F	RMC2	0~F



- When "A"~"F" is entered to SEG5~6, the indoor unit MAIN ADDRESS is not changed.
- If you set the SEG 3 as 0, the indoor unit will maintain the previous MAIN ADDRESS even if you input the option value of SEG5~6.
- If you set the SEG 9 as 0, the indoor unit will maintain previous RMC ADDRESS even if you input the option value of SEG11~12.
- You cannot set SEG11 and SEG12 as F value at the same time.

Setting an indoor unit installation option (suitable for the condition of each installation location)

1. Check whether power is supplied or not.
 - When the indoor unit is not plugged in, there should be additional power supply in the indoor unit.
2. The panel(display) should be connected to an indoor unit to receive option.
3. Set the installation option according to the installation condition of an air conditioner.
 - The default setting of an indoor unit installation option is "020010-100000- 200000-300000".
 - Individual control of a remote controller(SEG20) is the function that controls an indoor unit individually when there is more than one indoor unit.
4. Set the indoor unit option by wireless remote controller.

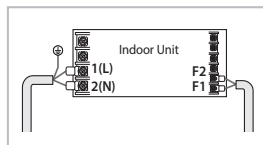

02 series installation option

SEG1	SEG2	SEG3	SEG4	SEG5	SEG6
0	2	--	External room temperature sensor / Minimizing fan operation when thermostat is off	Central control	FAN RPM compensation
SEG7	SEG8	SEG9	SEG10	SEG11	SEG12
1	Drain pump	Hot water heater	--	EEV Step when heating stops	--
SEG13	SEG14	SEG15	SEG16	SEG17	SEG18
2	External control	External control output / External heater On or Off signal	S-Plasma ion	Buzzer	Number of hours using filter
SEG19	SEG20	SEG21	SEG22	SEG23	SEG24
3	Individual control of a remote controller	Heating setting compensation / Removing condensated water in heating mode	EEV Step of stopped unit during oil return/ defrost mode	Motion detect sensor	--

- ◆ 1WAY/2WAY/4WAY MODEL : Drain pump(SEG8) will be set to 'USE + 3minute delay' even if the drain pump is set to 0.
- ◆ 1 WAY/2WAY/4WAY,DUCT MODEL : Number of hours using filter(SEG18) will be set to '1000hour' even if the SEG18 is set to except for 2 or 6.
- ◆ When setting the option other than above SEG values, the option will be set as "0".
- ◆ SEG5 central control option is basically set as 1 (Use), so you don't need to set the central control option additionally.
However, if the central control is not connected but it doesn't indicate an error message, you need to set the central control option as 0 (Disuse) to exclude the indoor unit from the central control.

Setting an indoor unit address and installation option

- ◆ The output of hot water heater in SEG9 is generated from the hot coil part of the terminal board in duct models.

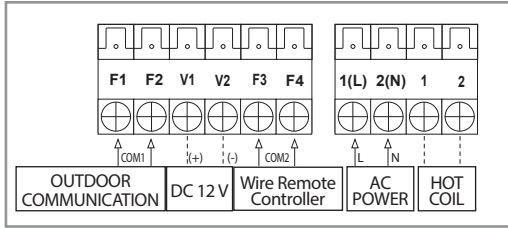



* The output of hot coil terminal is AC 220 V / 230 V
(The same as Indoor Unit's input Power)

- ◆ The external output of SEG15 is generated by MIM-B14 connection. (Refer to the manual of MIM-B14.)

■ 02 series installation option(Detailed)

Option No. : 02XXXX-1XXXXX-2XXXXX-3XXXXX

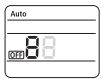
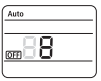
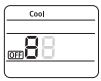
Option	SEG1		SEG2		SEG3		SEG4			SEG5		SEG6	
Explanation	PAGE		MODE		Use of robot cleaning		Use of external room temperature sensor / Minimizing fan operation when thermostat is off			Use of central control		FAN RPM compensation	
Remote Controller Display													
Indication and Details	Indication	Details	Indication	Details	Indication	Details	Indication	Details		Indication	Details	Indication	Details
	0		2		0	Disuse	0	Disuse	Disuse	0	Disuse	0	Disuse
					1	Use	1	Use	Disuse	1	Use	1	RPM compensation
					2	Disuse	2	Disuse	Use(*)	2	Use	2	High ceiling KIT
Option	SEG7		SEG8		SEG9		SEG10			SEG11		SEG12	
Explanation	PAGE		Use of drain pump		Use of hot water heater					EEV Step when heating stops			
Remote Controller Display													
Indication and Details	Indication	Details	Indication	Details	Indication	Details	Indication	Details		Indication	Details	Indication	Details
	1		0	Disuse	0	Disuse				0	Default value		
			1	Use	1	Use (*)							
			2	When an indoor unit stops, drain pump will operate for 3min	2	--				1	Noise decreasing setting		
		3		3	Use (*)								

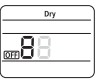
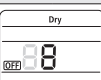
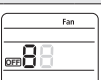
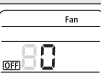
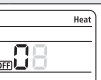
Option	SEG13		SEG14		SEG15			SEG16		SEG17		SEG18	
Explanation	PAGE		Use of external control		Setting the output of external control / External heater On/Off signal			S-Plasma ion		Buzzer control		Hours of filter usage	
Remote Controller Display													
Indication and Details	Indication	Details	Indication	Details	Indication	Details		Indication	Details	Indication	Details	Indication	Details
						Setting the output of external control	External heater On/Off signal						
	2		0	Disuse	0	Thermo on	-	0	Disuse	0	Use buzzer	2	1000 Hour
			1	ON/OFF control	1	Operation on	-	1	Use	1	Disuse buzzer	6	2000 Hour
			2	OFF control	2	-	Use ^{(*)3}						
3	Window ON/OFF control	3	-	Use ^{(*)3}									
Option	SEG19		SEG20		SEG21			SEG22		SEG23		SEG24	
Explanation	PAGE		Individual control of a remote control of a		Heating setting compensation / Removing condensated water in heating mode			EEV Step of stopped unit during oil return/ defrost mode		Motion detect sensor		-	
Remote Controller Display													
Indication and Details	Indication	Details	Indication	Details	Indication	Details		Indication	Details	Indication	Details	Indication	Details
						Heating Setting Compensation	Removing Condensated Water in Heating Mode						
	3		0 or 1	channel 1	0	Default ^{(*)4}	Disuse	0	Default value	0	Disuse		
			2	channel 2	1	2 °C	Disuse	1	Oil return or Noise decreasing in defrost mode	1	Turn out in 30min. without motion		
			3	channel 3	2	5 °C	Disuse			2	Turn out in 60min. without motion		
			4	channel 4	3	Default ^{(*)4}	Use ^{(*)5}	3	Turn out in 120min. without motion				
					4	2 °C	Use ^{(*)5}	4	Turn out in 180min. without motion				
			5	5 °C	Use ^{(*)5}	5	5 °C	Use ^{(*)5}	5	Turn out in 30min. without motion or *advanced function			
						6	Turn out in 60min. without motion or *advanced function						
			7	Turn out in 120min. without motion or *advanced function									
8	Turn out in 180min. without motion or *advanced function												

Setting an indoor unit address and installation option

* Advanced function: Controlling cooling/heating current or power saving with motion detect.

(*1) Minimizing fan operation when thermostat is off

- Fan operates for 20 seconds at an interval of 5 minutes in heat mode.

(*2) 1: Fan is turned on continually when the hot water heater is turned on,

3: Fan is turned off when the hot water heater is turned on with cooling only indoor unit

Cooling only indoor unit: To use this option, install the Mode Select switch(MCM-C200) on the outdoor unit and fix it as cool mode.

(*3) When the following 2 or 3 is used as external heater On/Off signal, the signal for monitoring external contact control will not be output.

2: Fan is turned on continually when the external heater is turned on,

3: Fan is turned off when the external heater is turned on with cooling only indoor unit

Cooling only indoor unit: To use this option, install the Mode Select switch(MCM-C200) on the outdoor unit and fix it as cool mode.

- If Fan is set to off for cooling only indoor unit by setting the SEG9=3 or SEG15=3, you need to use an external sensor or wired remote controller sensor to detect indoor temperature exactly.

(*4) Default setting value

- 4Way Cassette, Mini 4Way Cassette: 5 °C

- Other indoor units: 2 °C

(*5) This function can be applied to 4 Way Cassette and Mini 4 Way Cassette only. If the air conditioner operates the heating mode

immediately after finishing the cooling mode, the condensed water in the drain pan becomes water vapor by the heat of the indoor

unit heat exchanger. Since the water vapor might be condensed on the indoor unit, which may fall into a living space, use this function to get rid of the water vapor out of the indoor unit by operating the fan (for maximum 20 minutes) even when the indoor unit is turned off after cooling mode is turned to heating mode.

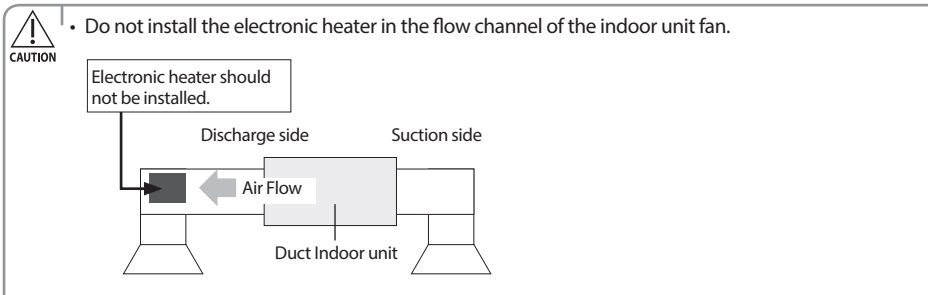









■ 05 series installation option

SEG1	SEG2	SEG3	SEG4	SEG5	SEG6
0	5	Use of Auto Change Over for HR only in Auto mode	(When setting SEG3) Standard heating temp. Offset	(When setting SEG3) Standard cooling temp. Offset	(When setting SEG3) Standard for mode change Heating → Cooling
SEG7	SEG8	SEG9	SEG10	SEG11	SEG12
1	(When setting SEG3) Standard for mode change Cooling → Heating	(When setting SEG3) Time required for mode change	Compensation option for Long pipe or height difference between indoor units	-	-
SEG13	SEG14	SEG15	SEG16	SEG17	SEG18
2	-	-	-	-	Control variables when using hot water / external heater
SEG19	SEG20	SEG21	SEG22	SEG23	SEG24
3	-	-	-	-	-

■ 05 series installation option(Detailed)

Option No. : 05XXXX-1XXXXX-2XXXXX-3XXXXX

Option	SEG1		SEG2		SEG3		SEG4		SEG5		SEG6							
Explanation	PAGE		MODE		Use of Auto Change Over for HR only in Auto mode		(When setting SEG3) Standard heating temp. Offset		(When setting SEG3) Standard cooling temp. Offset		(When setting SEG3) Standard for mode change Heating → Cooling							
Remote Controller Display																		
Indication and Details	Indication	Details	Indication	Details	0	Follow product option	0	0°C	0	0°C	0	1°C						
							1	0.5°C	1	0.5°C	1	1.5°C						
					1	Use Auto Change Over for HR only	2	1°C	2	1°C	2	2°C						
							3	1.5°C	3	1.5°C	3	2.5°C						
							4	2°C	4	2°C	4	3°C						
							5	2.5°C	5	2.5°C	5	3.5°C						
							6	3°C	6	3°C	6	4°C						
							7	3.5°C	7	3.5°C	7	4.5°C						
Option	SEG7		SEG8		SEG9		SEG10		SEG11		SEG12							
Explanation	PAGE		(When setting SEG3) Standard for mode changing Cooling → Heating mode		(When setting SEG3) Time required for mode change		Compensation option for Long pipe or height difference between indoor units											
Remote Controller Display																		
Indication and Details	Indication	Details	Indication	Details	Indication	Details	Indication	Details										
													0	1°C	0	5 min.	0	Use default value
													1	1.5°C	1	7 min.	1	1) Height difference ¹⁾ is more than 30m or 2) Distance ²⁾ is longer than 110m
													2	2°C	2	9 min.		
													3	2.5°C	3	11 min.	2	1) Height difference ¹⁾ is 15~30m or 2) Distance ²⁾ is 50~110m
													4	3°C	4	13 min.		
													5	3.5°C	5	15 min.		
													6	4°C	6	20 min.		
7	4.5°C	7	30 min.															

Setting an indoor unit address and installation option

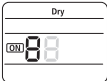
Option	SEG13	SEG14	SEG15	SEG16	SEG17	SEG18 ^{(*)3}					
Explanation						Control variables when using hot water / external heater					
Remote Controller Display											
Indication and Details	2								Indication	Details	
										Set temp. for heater On/Off	Delay time for heater On
									0	At the same time as thermo on	No delay
									1	At the same time as thermo on	10 minutes
									2	At the same time as thermo on	20 minutes
									3	1.5 °C	No delay
									4	1.5 °C	10 minutes
									5	1.5 °C	20 minutes
									6	3.0 °C	No delay
									7	3.0 °C	10 minutes
									8	3.0 °C	20 minutes
									9	4.5 °C	No delay
									A	4.5 °C	10 minutes
									B	4.5 °C	20 minutes
									C	6.0 °C	No delay
									D	6.0 °C	10 minutes
									E	6.0 °C	20 minutes

(*1) Height difference : The difference of the height between the corresponding indoor unit and the indoor unit installed at the lowest place.
For example, When the indoor unit is installed 40m higher than the indoor unit installed at the lowest place, select the option "1".

(*2) Distance : The difference between the pipe length of the indoor unit installed at farthest place from an outdoor unit and the pipe length of the corresponding indoor unit from an outdoor unit.
For example, when the farthest pipe length is 100 m(328 ft) and the corresponding indoor unit is 40 m away from an outdoor unit, select the option "2".
(100 - 40 = 60m)

(*3) Heater operation when the SEG9 of 02 series installation option is set to using hot water heater or when SEG15 is set to using external heater

e.g. 1) Setting 02 series SEG9 = "1" / Setting 05 series SEG18 = "0": Hot water heater is turned on at the same time as the heating thermostat is on, and turned off when the heating thermostat is off.

e.g. 2) Setting 02 series SEG15 = "2" / Setting 05 series SEG18 = "A":

Room temp. ≤ set temp. + f(heating compensation temp.)

- External heater is turned on when the temperature is maintained as 4.5 °C for 10 minutes.

Room temp. > set temp. + f(heating compensation temp.)

- External heater is turned off when the temperature is maintained as 4.5 °C + 1 °C (1 °C is the Hysteresis for On/Off selection.)

SEG 3, 4, 5, 6, 8, 9 additional information

When the SEG 3 is set as "1" and follow Auto Change Over for HR only operation, it will operate as follows.

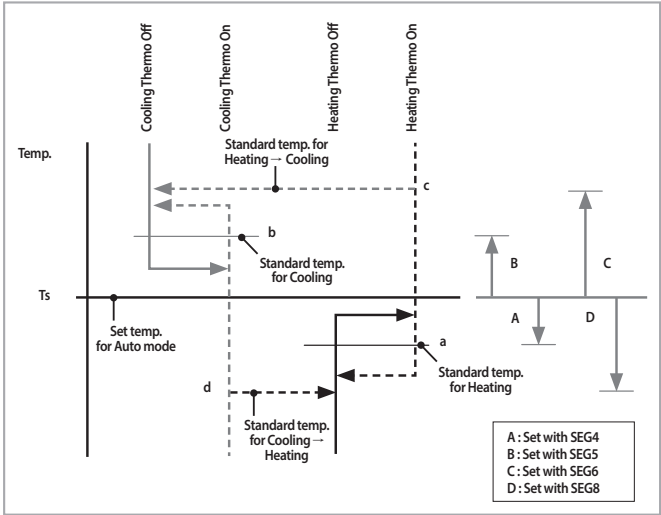

Cooling/Heating mode can be changed when Thermo Off status is maintained during the time with SEG9.

Setting an indoor unit address and installation option

Changing a particular option

You can change each digit of set option.

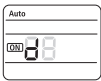
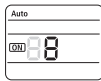
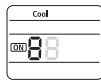
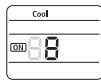
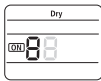
Option	SEG1		SEG2		SEG3		SEG4		SEG5		SEG6	
Explanation	PAGE		MODE		The option mode you want to change		The tens' digit of an option SEG you will change		The unit digit of an option SEG you will change		Changed value	
Remote Controller Display												
Indication and Details	Indication	Details	Indication	Details	Indication	Details	Indication	Details	Indication	Details	Indication	Details
	0		D		Option mode	1~6	Tens' digit of SEG	0~9	Unit digit of SEG	0~9	The changed value	0~F



NOTE

- When changing a digit of an indoor unit address setting option, set the SEG3 as 'A'.
- When changing a digit of indoor unit installation option, set the SEG3 as '2'.
Ex) When setting the 'buzzer control' into disuse status.

Option	SEG1	SEG2	SEG3	SEG4	SEG5	SEG6
Explanation	PAGE	MODE	The option mode you want to change	The tens' digit of an option SEG you will change	The unit digit of an option SEG you will change	Changed value
Indication	0	D	2	1	7	1



CAUTION

- If you are using heat pump model, mixed operation mode (two or more indoor units operating in different operation mode simultaneously) is not available when the indoor units are connected to same outdoor unit. If you set the master indoor unit with a remote controller, outdoor unit will operate in the mode which was set in the master indoor unit.

QUESTIONS OR COMMENTS?

COUNTRY	CALL	OR VISIT US ONLINE AT
AUSTRIA	0800-SAMSUNG (0800-7267864) [Only for KNOX customers] 0800 400848 [Only for Premium HA] 0800-366661 [Only for Dealers] 0810-112233 [Only for E-Store] 0800 100 232	www.samsung.com/at/support
BELGIUM	02-201-24-18	www.samsung.com/be/support (Dutch) www.samsung.com/be_fr/support (French)
BOSNIA	055 233 999	www.samsung.com/support
BULGARIA	*3000 Цена в мрежата 0800 111 31, Безплатна телефонна линия	www.samsung.com/bg/support
CROATIA	072 726 786	www.samsung.com/hr/support
CZECH	800-SAMSUNG (800-726786)	www.samsung.com/cz/support
DENMARK	707 019 70	www.samsung.com/dk/support
FINLAND	030-6227 515	www.samsung.com/fi/support
FRANCE	01 48 63 00 00	www.samsung.com/fr/support
GERMANY	06196 77 555 66 *HHP 06196 77 555 77 *OTH	www.samsung.com/de/support
CYPRUS	8009 4000 only from landline, toll free	www.samsung.com/gr/support
GREECE	8011-SAMSUNG (80111 726 7864) only from land line (+30) 210 6897691 from mobile and land line	www.samsung.com/gr/support
HUNGARY	0680SAMSUNG (0680-726-7864)	www.samsung.com/hu/support
ITALIA	800-SAMSUNG (800.7267864)	www.samsung.com/it/support
LUXEMBURG	261 03 710	www.samsung.com/lux/support
MONTENEGRO	020 405 888	www.samsung.com/support
SLOVENIA	080 697 267 (brezplačna številka)	www.samsung.com/si/support
NETHERLANDS	088 90 90 100	www.samsung.com/nl/support
NORWAY	21629099	www.samsung.com/no/support
POLAND	801-172-678* lub +48 22 607-93-33* Dedykowana infolinia do obsługi pytań dotyczących telefonów komórkowych: 801-672-678* lub +48 22 607-93-33* * (opłata według taryfy operatora)	www.samsung.com/pl/support
PORTUGAL	808 20 7267	www.samsung.com/pl/support
ROMANIA	*8000 (apel in retea) 08008-726-78-64 (08008-SAMSUNG) Apel GRATUIT	www.samsung.com/ro/support
SERBIA	011 321 6899	www.samsung.com/rs/support
SLOVAKIA	0800-SAMSUNG(0800-726 786)	www.samsung.com/sk/support
SPAIN	0034902172678 [HHP] 0034902167267	www.samsung.com/es/support
SWEDEN	0771 726 786	www.samsung.com/se/support
SWITZERLAND	0848 726 78 64 (0800-SAMSUNG)	www.samsung.com/ch/support (German) www.samsung.com/ch_fr/support (French)
UK	0330 SAMSUNG (7267864)	www.samsung.com/uk/support
IRELAND (EIRE)	0818 717100	www.samsung.com/ie/support
LITHUANIA	8-800-7777	www.samsung.com/lt/support
LATVIA	8000-7267	www.samsung.com/lv/support
ESTONIA	800-7267	www.samsung.com/ee/support
RUSSIA	8-800-555-55-55 (VIP care 8-800-555-55-88)	www.samsung.com/ru/support
GEORGIA	0-800-555-555	www.samsung.com/support
ARMENIA	0-800-05-555	www.samsung.com/support
AZERBAIJAN	0-88-555-55-55	www.samsung.com/support
KAZAKHSTAN	8-10-800-500-55-500(GSM: 7799, VIP care 7700)	www.samsung.com/support
UZBEKISTAN	00-800-500-55-500 (GSM: 7799)	www.samsung.com/support
KYRGYZSTAN	00-800-500-55-500 (GSM: 9977)	www.samsung.com/kz_ru/support
TAJIKISTAN	8-10-800-500-55-500 (GSM: 8888)	www.samsung.com/support
MONGOLIA	1800-25-55	www.samsung.com/support
BELARUS	810-800-500-55-500	www.samsung.com/support
UKRAINE	0-800-502-000	www.samsung.com/ua/support (Ukrainian) www.samsung.com/ua_ru/support (Russian)

COUNTRY	CALL	OR VISIT US ONLINE AT
MOLDOVA	0-800-614-40	www.samsung.com/support
UAE	800-SAMSUNG (800 - 726 7864)	
OMAN	800-SAM CS (800-72627)	
KUWAIT	183-CALL (183-2255)	www.samsung.com/ae/support (English) www.samsung.com/ae_ar/support (Arabic)
BAHRAIN	8000-GSAM (8000-4726)	
QATAR	800-CALL (800-2255)	
EGYPT	08000-726786 16580	www.samsung.com/eg/support
ALGERIA	3004	www.samsung.com/n_afrika/support
PAKISTAN	0800-Samsung (72678)	www.samsung.com/pk/support
TUNISIA	80 1000 12	www.samsung.com/n_afrika/support
JORDAN	0800-22273 06 5777444	
SYRIA	962 5777444	www.samsung.com/Levant/support
Lebanon	1299	
Iraq	80010080	
IRAN	021-8255 (CE) 021-42132 (HHP)	www.samsung.com/iran/support
MOROCCO	080 100 2255	www.samsung.com/n_afrika/support
SAUDI ARABIA	(+966) 8002474357 (800 24/7 HELP)	www.samsung.com/sa_en/support(English) www.samsung.com/sa/support(Arabic)
TURKEY	444 77 11	www.samsung.com/tr/support
Israel	*6963	www.samsung.com/il/support/
ARGENTINA	0800-555-SAMSUNG(7267)	www.samsung.com/ar
URUGUAY	0800-SAMS(7267)	www.samsung.com/uy
PARAGUAY	0800-11-SAMS(7267)	www.samsung.com/py
BRAZIL	0800-124-421 (Demais cidades e regiões) 4004-0000 (Capitais e grandes centros)	www.samsung.com/br/support
CHILE	800-SAMSUNG(726-7864) [HHP] 02-24828200	www.samsung.com/cl/support
BOLIVIA	800-10-7260	www.samsung.com/cl/support
COLOMBIA	Bogotá en el 600 12 72 Sin costo en todo el país 01 8000 112 112 Y desde tu celular #726	www.samsung.com/co/support
COSTA RICA	00-800-1-SAMSUNG (726-7864)	
DOMINICAN REPUBLIC	1-809-200-7264	
ECUADOR	1-800-SAMSUNG (72-6786)	www.samsung.com/latin/support (Spanish) www.samsung.com/latin_en/support (English)
EL SALVADOR	8000-SAMSUNG (726-7864)	
GUATEMALA	1-800-299-0033	
HONDURAS	800-2791-9111	
JAMAICA	1-800-SAMSUNG (726-7864)	www.samsung.com/latin_en/support (English)
MEXICO	01-800-SAMSUNG(726-7864)	www.samsung.com/mx/support
NICARAGUA	001-800-5077267	
PANAMA	800-0101	www.samsung.com/latin/support (Spanish) www.samsung.com/latin_en/support (English)
PUERTO RICO	1-800-682-3180	
TRINIDAD & TOBAGO	1-800-SAMSUNG(726-7864)	
PERU	080077708 Desde teléfonos fijos, públicos o celulares	www.samsung.com/pe/support
VENEZUELA	0-800-SAMSUNG (726-7864)	www.samsung.com/latin/support (Spanish) www.samsung.com/latin_en/support (English)
AUSTRALIA	1300 362 603 (Other) 1300 425 299 (HHP)	www.samsung.com/au/support
PHILIPPINES	Only for HHP PRODUCT: 02-422-2177 Standard Landline OTH PRODUCT: 1-800-10-726-7864 PLDT Toll Free 1-800-8-726-7864 Globe Landline and Mobile 02-422-2111 Standard Landline	www.samsung.com/ph/support
SINGAPORE	1800 7267864 1800-SAMSUNG (Other) 1800 4252997 1800-GALAXYS (HHP)	www.samsung.com/sg/support

SAMSUNG ELECTRONICS CO.,LTD.

No.501 Suhong East Road,Suzhou Industrial Park,Jiangsu Province,PR.China

Samsung Electronics

Service Department

PO Box 12987, Blackrock, Co. Dublin, Ireland

or

Blackbushe Business Park, Yateley, GU46 6GG, UK



DB68-04861A-02



Duct Type Series

Global Duct :

AM***HNMP***

AM***HNHP***

Air Conditioner user manual

imagine the possibilities

Thank you for purchasing this Samsung product.

SAMSUNG