

**SAMSUNG**

# SYSTEM AIR CONDITIONER

Indoor Unit

Model Name :

AC200KNHPKH

AC250KNHPKH

Outdoor Unit

AC200KXAPNH

AC250KXAPNH

Model Code :

AC200KNHPKH/EU

AC250KNHPKH/EU

AC200KXAPNH/EU

AC250KXAPNH/EU

# ***SERVICE*** Manual

AIR CONDITIONER

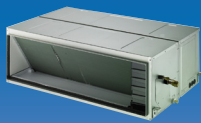

AC200KNHPKH  
AC250KNHPKH



AC200KXAPNH  
AC250KXAPNH

CONTENTS

1. Precautions
2. Product Specifications
3. Disassembly and Reassembly
4. Troubleshooting
5. PCB Diagram
6. Wiring Diagram
7. Reference Sheet

# Contents

1. Precautions .....	1-1
1-1 Precautions for the Service .....	1-1
1-2 Precautions for the Static Electricity and PL .....	1-1
1-3 Precautions for the Safety .....	1-1
1-4 Others .....	1-1
2. Product Specifications .....	2-1
2-1 The Feature of Product .....	2-1
2-2 Product Specifications .....	2-2
2-3 Accessory .....	2-4
3. Disassembly and Reassembly .....	3-1
3-1 Indoor Unit .....	3-2
3-2 Outdoor Unit .....	3-14
4. Trouble shooting .....	4-1
4-1 Wired remote controller .....	4-1
4-2 Outdoor Trouble shooting .....	4-4
4-3 Troubleshooting by symptoms .....	4-7
4-3-1 Indoor temperature sensor (open/short) .....	4-7
4-3-2 Eva in and out sensor (open/short) .....	4-8
4-3-3 Float switch(Open) .....	4-9
4-3-4 Fan error .....	4-10
4-3-5 EEPROM error .....	4-11
4-3-6 Option error .....	4-12
4-3-7 Terminal Block's Terminal Fuse(Open) .....	4-13
4-3-8 Communication error after finishing tracking (E202) .....	4-14
4-3-9 Outdoor's service valve(Clog) .....	4-15
4-3-10 No Power(completely dead) - Initial diagnosis .....	4-16
4-3-11 E102 : Communication error between indoor and outdoor unit	
E201 : Unit quantity miss matching between Indoor and Outdoor	
E202 : Abnormal state, no communication between Indoor and Outdoor Main PCB	
E203 : 1min Time out of communication error(Main↔Inverter).....	4-20
4-3-12 External Sensor Error (Error Code: E221, E231, E251, E320) .....	4-21
4-3-13 E403 : Freezing control causes comp. down .....	4-22
4-3-14 E416 : Dischage temperature sensor error .....	4-23
4-3-15 E440, E441 : Abnormal outside temperature halts operation of the compressor ...	4-24
4-3-16 Outdoor unit BLDC Fan1 or Fan2 error (E458 : Fan1 error, E475 : Fan2 error) .....	4-25
4-3-17 E461: Compressor start error	
E467: Compressor wire missing error .....	4-26
4-3-18 E462 : Current protection control causes comp. down	
E484 : PFC overload error .....	4-27
4-3-19 E463 : OLP protection control caused comp. down .....	4-28
4-3-20 E464 : O.C. (Over Current) error .....	4-29
4-3-21 E466: DC Link Over voltage/ Low voltage error .....	4-30
4-3-22 Pipe Blocking Error (Error Code: E422) .....	4-31

# Contents

4-3-23 The others .....	4-32
4-4 Setting Option Setup Method .....	4-33
4-5 Items to be checked first.....	4-40
5. PCB Diagram and Parts list .....	5-1
5-1 INDOOR UNIT .....	5-1
5-2 OUTDOOR UNIT .....	5-4
6. Wiring Diagram .....	6-1
6-1 Indoor Unit .....	6-1
6-2 Outdoor Unit .....	6-2
7. Reference Sheet .....	7-1
7-1 Refrigerating Cycle Diagram .....	7-1
7-2 Index for Model Name .....	7-2

---

# 1. Precautions

---

## 1-1 Precautions for the Service

---

- ▶ Use the standard parts when replacing the electric parts.
  - Confirm the model name, rated voltage, rated current of the electric parts.
- ▶ Repair the disconnection of HARNESS securely when repairing the break down.
  - If there is any connection error, it causes an abnormal noise and incorrect operation.
- ▶ In case that you assemble or disassemble the products with laying it on the side, do work on the work cloth.
  - If not, the exterior of products can be scratched.
- ▶ Remove dust and foreign materials from harness, connection part, and inspection part thoroughly when repairing the break down.
  - It protects the danger of fire such as tracking and short.
- ▶ Tighten tightly the service valve of outdoor unit and the cap of charging valve with a monkey spanner.
- ▶ Check the assembly status of parts after repairing the break down.
  - It should be same as the status before repairing.

## 1-2 Precautions for the Static Electricity and PL

---

- ▶ As the PCB power terminal has a weakness for the static electricity, pay attention to it during the repair and measurement.
  - Work with insulation gloves during the repair and measurement of PCB.
- ▶ Check the distance between the product and the other electronic appliances such as TV, video, and audio. It should be over 2m.
  - If not, it causes a bad picture quality or a noise.
- ▶ Repairing the products by consumer should be strictly prohibited.
  - There is a danger of electric shock or fire due to incorrect disassembly.

## 1-3 Precautions for the Safety

---

- ▶ Do not pull any electric wires and do not touch an auxiliary power switch with a wet hand.
  - There is a danger of electric shock or fire.
- ▶ In case any wire or power plug has been damaged, replace it to eliminate any possible danger.
- ▶ Do not bend the power cord by force and do not put any heavy object on the power cord.
  - There is a danger of electric shock or fire.
- ▶ Do not use multi socket.
  - There is a danger of electric shock or fire.
- ▶ Ground the product if necessary.
  - Be sure to ground the product if there is any danger of electric leakage due to water or moisture.
- ▶ Be sure to turn off the auxiliary power switch or pull out the power plug during replacement or repair of electric parts.
  - There is a danger of electric shock.
- ▶ In case the product will not be in use for a long time, the battery of remote control should be kept separately.
  - Leakage of inside fluid can cause break down of remote control.

## 1-4 Others

---

- ▶ Never store or load the air conditioner upside down or sideways to prevent the damage to the compressor.
- ▶ Young children or infirm persons should be always supervised when they use the air conditioner.
- ▶ Max current is measured according to IEC standard for safety.
- ▶ Current is measured according to ISO standard for energy efficiency.
- ▶ When installing, make sure there is no leakage. When recovering the refrigerant, ground the compressor first before removing the connection pipe. If the refrigerant pipe is not properly connected and the compressor works with the service valve open, the pipe inhales the air and it makes the pressure inside of the refrigerant cycle abnormally high. It may cause explosion and injury.
- ▶ Pump Down Procedure (When removing the product)
  - Turn on the air conditioner and select Cool mode to run the compressor for 3 minutes.
  - Release the valve caps on High and Low pressure side.
  - Use L wrench to close the valve on the high pressure side.
  - Approximately 2 minutes after, close the valve on the low pressure side.
  - Stop operation of the air conditioner.
  - Disconnect the pipes.



---

## 2. Product Specifications

---

### 2-1 The Feature of Product

---











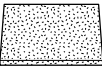

- Built-in Duct Type  
After installed, the air conditioner can be harmonized with a room interior.
  
- High Performance & Energy Saving  
With the advanced BLDC inverter technology, it makes a room cool with highly energy saving and arises the efficiency of air conditioner.
  
- Long Piping (Length & Height)  
It can give the benefit to the installers and arises the reliability of the air conditioner.
  
- Long Ambient Operation (In Low Temperature)  
It can arise the reliability and the capacity of the air conditioner, especially operated in low temperature.
  
- Eco-friendly Product (Lead-Free, RoHS, WEEE)

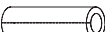
## 2-2 Product Specification

ITEM			AC200KNHPKH AC200KXAPNH/	
IMAGE	Indoor Unit			
	Outdoor Unit			
	Remote Controller		MWR-WE10N 	
Power	Product		3Φ, 380~415V/50Hz	
Indoor	W*D*H	mm	1350 x 910 x 450	
Outdoor	W*D*H	mm	940 x 460 x 1630	
Indoor	Product	kg(Net)	82.5	
Outdoor	Product	kg(Net)	154	
Capacity	Cooling/Heating(ISO)	W	20000/23000	
Power input	Cooling/Heating (ISO)	W	6450/6660	
Operation current	Cooling/Heating (ISO)	A	10.0/10.3	
Noise (Cooling/Heating)	Indoor unit	In case of strongest air blow	dB	52/52
	Outdoor unit	In case of strongest air blow	dB	67/71
Refrigerant (R410A)		g	6600(Charged for 30m)	
Connecting Pipe	Liquid	mm	9.52	
	Gas	mm	19.05	
Additional Refrigerant (R410A)		g/m	50	
Standard		m	5	
Extension length(Total)		m	75	
Extension length(Elevation)		m	30	
Option Code		Product Option	011074-1C50C0-27C8E6-372000	
		Installation Option	020000-100000-200000-300000 030000-100000-200000-300000	







ITEM			AC250KNHPKH AC250KXAPNH	
IMAGE	Indoor Unit			
	Outdoor Unit			
	Remote Controller		MWR-WE10N 	
Power	Product		3Φ, 380~415V/50Hz	
Indoor	W*D*H	mm	1350 x 910 x 450	
Outdoor	W*D*H	mm	940 x 460 x 1630	
Indoor	Product	kg(Net)	82.5	
Outdoor	Product	kg(Net)	154	
Capacity	Cooling/Heating(ISO)	W	25000/27000	
Power input	Cooling/Heating (ISO)	W	9580/8330	
Operation current	Cooling/Heating (ISO)	A	14.9/12.9	
Noise (Cooling/Heating)	Indoor unit	In case of strongest air blow	dB	55/55
	Outdoor unit	In case of strongest air blow	dB	68/72
Refrigerant (R410A)		g	6600 (Charged for 30m)	
Connecting Pipe		Liquid	mm	9.52
		Gas	mm	22.2
Additional Refrigerant (R410A)		g/m	50	
Standard		m	5	
Extension length(Total)		m	75	
Extension length(Elevation)		m	30	
Option Code		Product Option	011074-1C50F0-270014-373800	
		Installation Option	020000-100000-200000-300000 030000-100000-200000-300000	

## 2-3 Accessory

Item	Descriptions	Code-No.	Q'TY	Remark
	Owner's Manual	DB98-32657A	1	Indoor Unit
	INSTALLATION MANUAL	DB68-04923A	1	
	Insulation	DB62-04318S	1	
	Insu DRAIN HOSE	DB62-11028A	1	
	INSU HOSE D	DB62-11028E	1	
	INSU TUBE OUT	DB62-11028F	1	
	ASSY DRAIN HOSE JOINT	DB67-01191A	1	
	Ass'y Drain Hose Joint	DB90-06701A	1	
	GROMMET-HANGER	DB63-00237A	8	
	RUBBER LEG	DB73-20134A	4	
	INSTALLATION MANUAL	DB68-04924A	1	
	DRAIN PLUG	DB67-00477A	1	
	RUBBER LEG	DB73-20134A	4	

### 3. Disassembly and Reassembly

#### ■ Necessary Tools

Item	Remark
+SCREW DRIVER	
MONKEY SPANNER	
-SCREW DRIVER	
NIPPER	
ELECTRIC MOTION DRIVER	
L-WRENCH	

### 3-1 Indoor Unit

#### ■ AC200KNHPKH / AC250KNHPKH

No	Parts	Procedure	Remark
1	Commom	<p>1)Disasseble the Cover Control. - Unscrew 2 screws</p> <p><b>⚠ You must turn off the Power before disassembly.</b></p>	

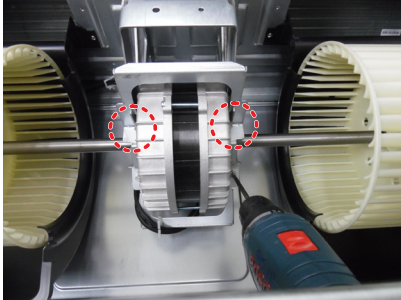
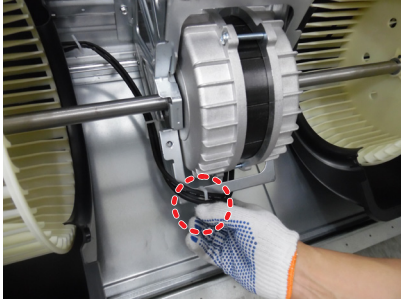
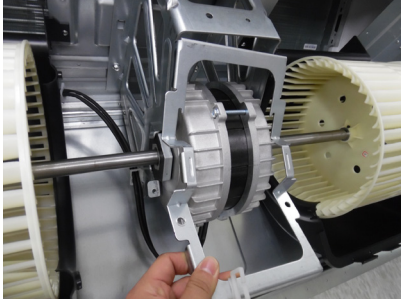
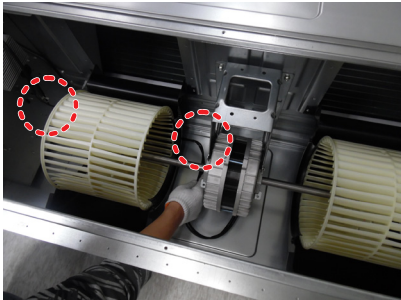

► service from Top side

No	Parts	Procedure	Remark
2	Motor & Fan	<p>1) Disassemble the connection wire to take the motor fan out</p> <p>2) Disassemble th Cabinet Top Fan. - Unscrew 6 screws</p> <p>3) Disassemble the Link Screw - Unscrew 3 screws</p> <p>4) Disassemble Cabinet Top Fan.</p>	    



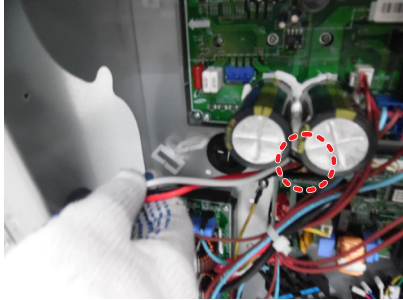
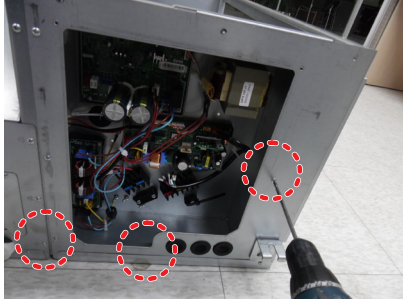

No	Parts	Procedure	Remark
		<p>5) Disassemble 2 Case Blower Top. - Unscrew 8 screws</p> <p>6) Disassemble 1 Holder Motor. - Unscrew 2 screws</p> <p>7) Disassemble Motor wire from 2 holder wire</p>	    

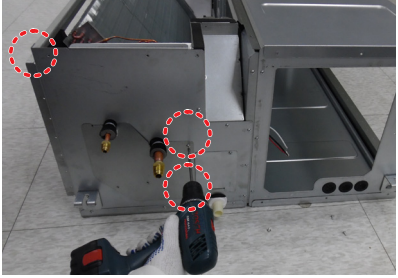

No	Parts	Procedure	Remark
		<p>8) After disassemble the Motor and Blower for the set, disassemble the Blower by use of 3mm wrench.</p>	 
		<p>9) Disassemble 2 Case blower bottom. - Unscrew 4 screws</p>	
		<p>10) Disassemble the Bracket Motor. - Unscrew 4 screws</p>	

No	Parts	Procedure	Remark
3	Control Box	<p>1)Disassemble Evap Sensor wire and EEV wire(20kW only)</p> <p>2) Disassemble the Case Control. - Unscrew 3 screws</p>	  

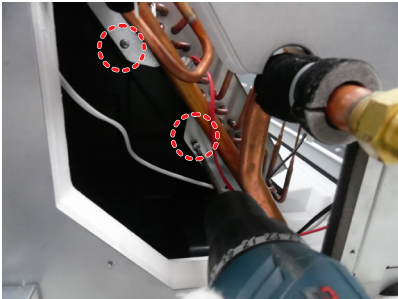
No	Parts	Procedure	Remark
4	Evap	<p>1)Disassemble The Case Evap Top  - [AC***JNHFKH]Unscrew 8 screws  - [AC***JNHPKH]Unscrew 6 screws</p> <p>2)Disassemble The Cushion Front.</p> <p>3)Disassemble The Cushion Support.  - Unscrew 1 screw</p>	



No	Parts	Procedure	Remark
		<p>4)Disassemble The Cover pipe. - Unscrew 3 screws</p> <p>5)Remove The cable tie on the Support Evap</p> <p>6)Disassemble The Evap. - Unscrew 4 screws</p>	    

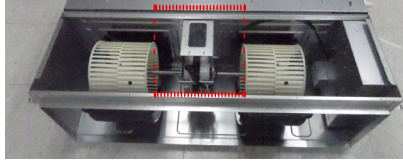

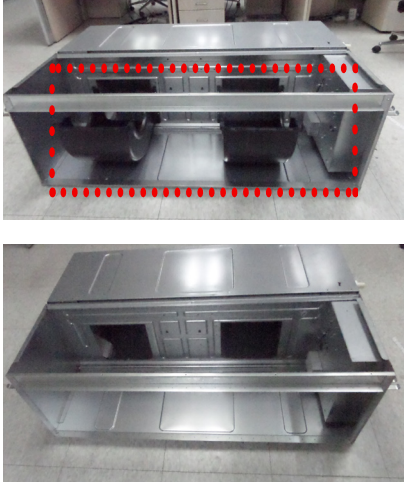

► service from Bottom side

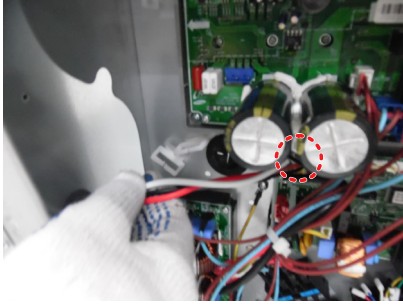
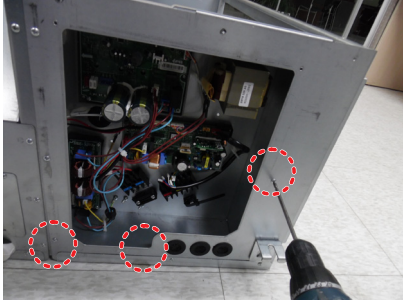
No	Parts	Procedure	Remark
1	Motor & Fan	<p>1)Disassembl the connection wire to take the motor fan out</p> <p>2) Diassemble The Cabi Fan Bottom. - Unscrew 9 screws</p> <p>3) Disassemble the Link Screw - Unscrew 3 screws</p> <p>4)Disassemble 2 Case blower bottom. - Unscrew 4 screws</p> <p>5)Disassemble Bracket Motor and Motor. - Unscrew 4 screws</p> <p>6)After disassemble the Motor and Blower for the set, disassemble the Blower by use of 3mm wrench.</p>	      

No	Parts	Procedure	Remark
		<p>7)Disassemble The Case Blower Top.            - Unscrew 8 screws</p>	

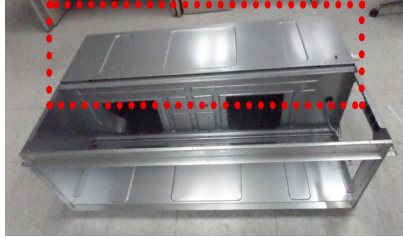

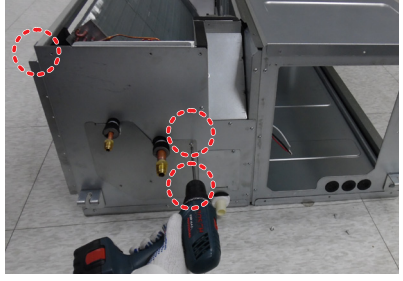
No	Parts	Procedure	Remark
2	Control Box	<p>1) Disassemble Evap Sensor wire and EEV wire (20kW only)</p> <p>2) Disassemble the Case Control. - Unscrew 3 screws</p>	  

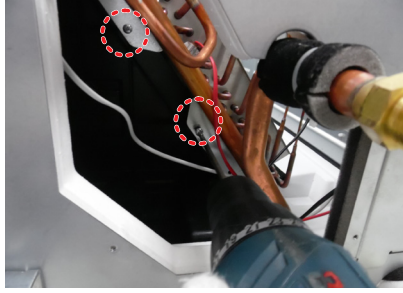
No	Parts	Procedure	Remark
3	Evap	<p>1)Disassemble The Case Evap Bottom  - [AC***JNHFKH]Unscrew 11 screws  - [AC***JNHPKH]Unscrew 7 screws</p> <p>2)Disassemble The Drain Pan</p> <p>3)Disassemble The Cover pipe.  - Unscrew 3 screws</p> <p>4)Remove The cable tie on the Support Evap</p> <p>5)Disassemble The Support Evap.  - Unscrew 2 screws</p>	    



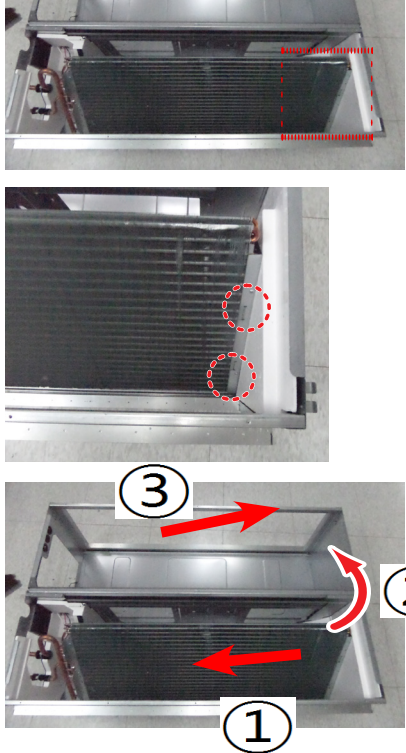



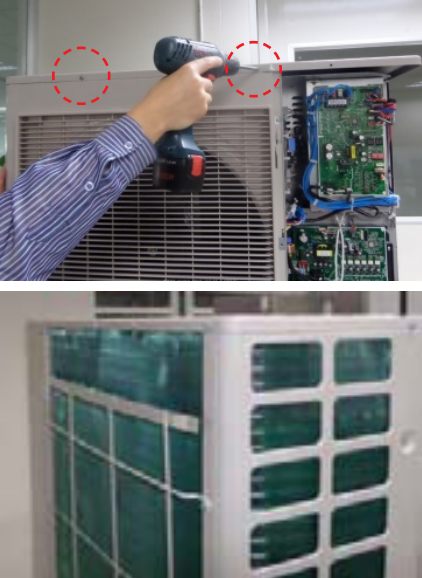

No	Parts	Procedure	Remark
		<p>6) Disassemble The Evap.  - Unscrew 2 screws</p> <p>① Moving the Evap 2~5cm to pipe direction  ② Holding the pipe side and then rotating the opposite side  ③ Moving the Evap in the direction of the arrow 3</p>	

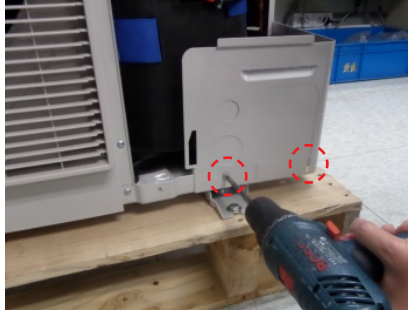

## 3-2 Outdoor Unit

### ■ AC200KXAPNH / AC250KXAPNH

No.	Parts	Procedure	Remark
1	CABINET FRONT RIGHT	<p><b>⚠ Warning: Make sure the power is disconnected before work</b></p> <p>1) Remove 3 screws. (use "+" screw driver or electric motion driver)</p>	
2	CABINET TOP	<p>2) Remove 8 screws around cabi top. (use "+" screw driver or electric motion driver)</p>	

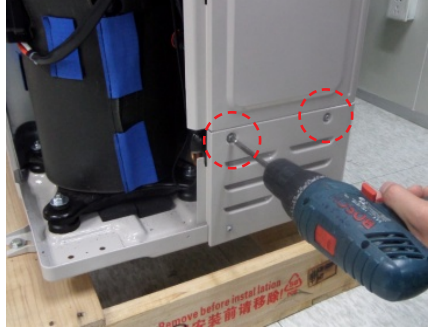

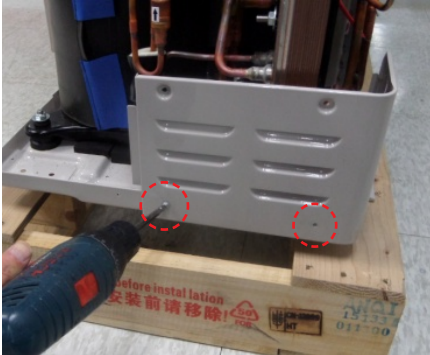
No.	Parts	Procedure	Remark
3	CABINET FRONT INSTALL	1) Remove 2 screws (use "+" screw driver or electric motion driver) and lift up to take off.	
4	GUARD COND	<p>1) Take off the sensor.</p> <p>2) Remove 4 screws. (use "+" screw driver or electric motion driver)</p>	 

No.	Parts	Procedure	Remark
5	CABI BACK RIGEHT	<p>1) Take out the sensor wire through the holeon cabinet.</p> <p>2) Remove 13 screws. (use ""+"" screw driver or electric motion driver)</p>	   

No.	Parts	Procedure	Remark
6	CABINET BACK INSTALL	1) Remove 2 scrwe. (using "+" screw driver or electric motion driver)	
7	CABI FRONT LF	1) Remove 10 screws. (using "+" screw driver or electric motion driver)	

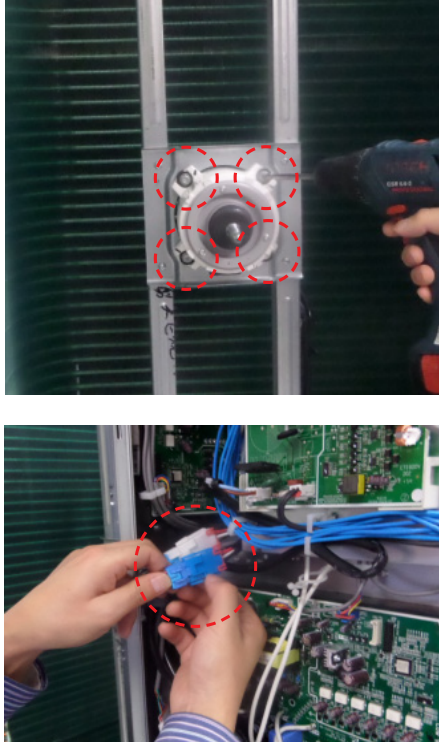

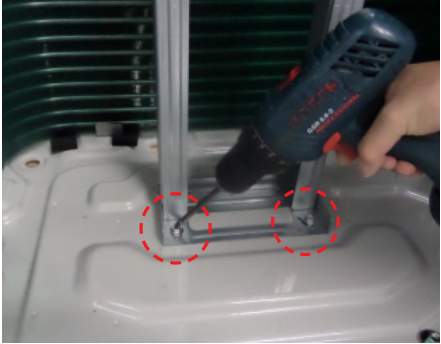
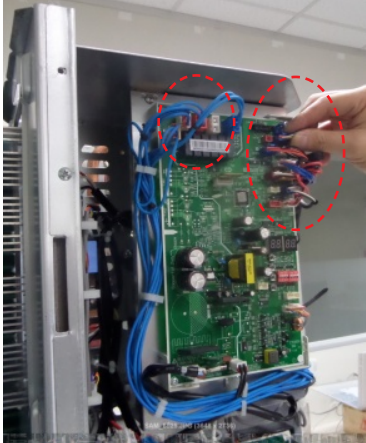
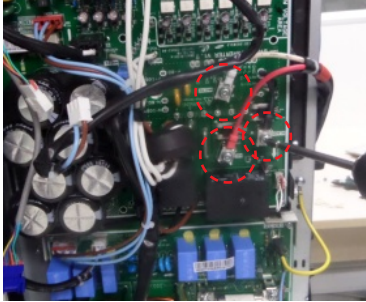

No.	Parts	Procedure	Remark
8	FAN PROPELLER	1) Remove nut, take out the fan. (using wrench turn clockwise)	
9	MOTOR	1) Remove 4 screws, take off the motor. (using "+" screw driver or electric motion driver)  2) Pull out the connector on main pcb board.	

No.	Parts	Procedure	Remark
10	BRACKET MOTOR	1) Remove 2 screws on the base. (using "+" screwdriver or electric motion driver)	
11	CONTROL BOX	1) Pull out all the connector on the pcb board.  <b>⚠ Warning : Make sure the power is disconnected before work</b>  2) Remove the screw that fix comp power wire. (using "+" screw driver or electric motion driver)  3) Remove the screw that fix comp power wire. (using "+" screw driver or electric motion driver)	  

No.	Parts	Procedure	Remark
11	CONTROL BOX	<p>4) Remove PBA of control box.</p> <p>a) Remove 2 screws that fix plate cover control box, and revolve open it. (using "+" screwdriver or electric motion driver)</p> <p>b) Remove 2 screws that fix reactor wire. (using "+" screwdriver or electric motion driver)</p> <p>c) Remove 2 screws that fix reactor and pull up it. (using "+" screwdriver or electric motion driver)</p>	

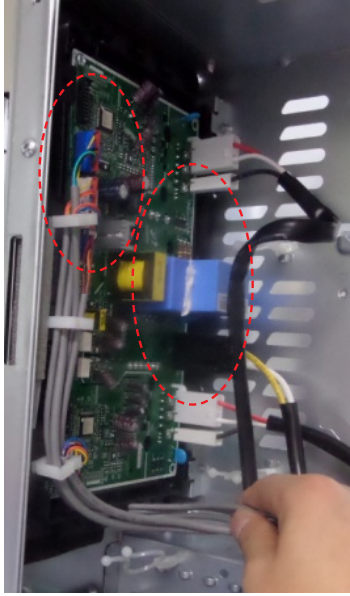

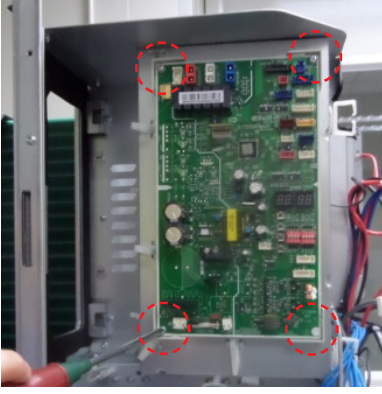
No.	Parts	Procedure	Remark
11	CONTROL BOX	<p>d) pull out the connector wire that's on fan motor diver PBA.</p> <p>e) Remove 2 screws that fix PBA CASE,and pull out assy fan motor diver PBA,</p> <p>d) Pull out the connector wire that's on MAIN PBA.</p> <p>e) Remove 4 screws that fix MAIN PBA,and pull out it.</p>	  

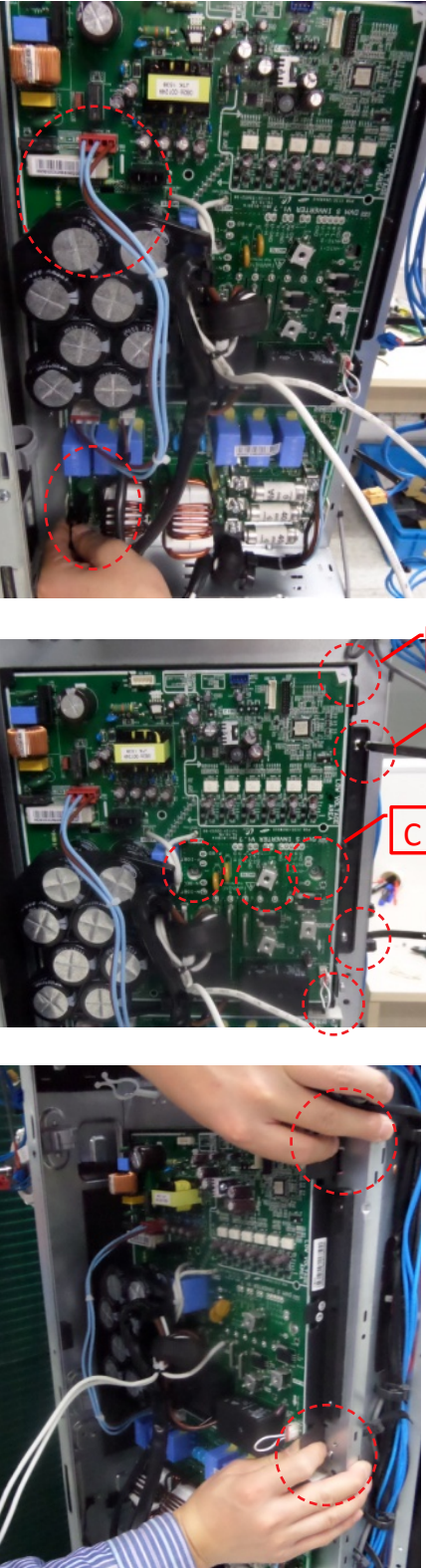
No.	Parts	Procedure	Remark
11	CONTROL BOX	<p>f) pull out the connector wire that's on Inverter PBA.</p> <p>g) Remove 2 screws that fixing inverter PCB(A part);  Remove 2 screws that fixing inverter PCB case (B part);  Remove 2 screws that fixing the plate colling(C part).  (using "+" screwdriver or electric motion driver)  * For 14HP models,the number of screws that fixing inverter PCB is 4.</p> <p>h) Band the handel of the case and take off the assy inverter PBA.  (Reffer right pic)</p> <p><b>⚠ Warning :</b> Becareful when take off inverter pcb ;when reasemble should ensure the silicon grease thin and even.</p>	

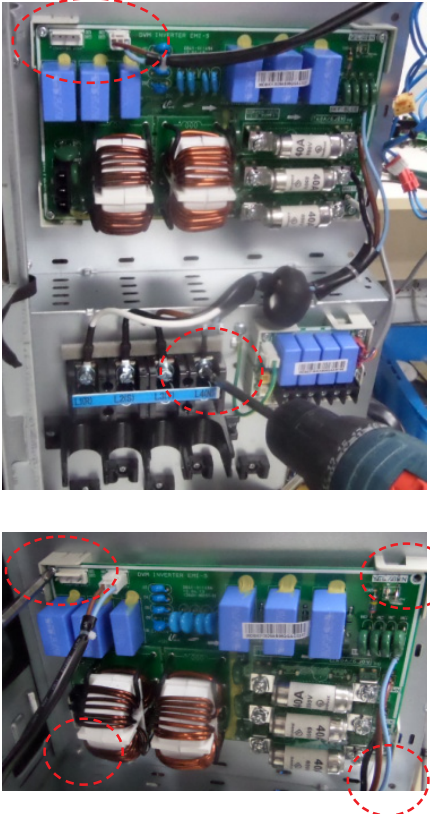
No.	Parts	Procedure	Remark
11	CONTROL BOX	<p>i) Pull out the connector wire that's on EMI PBA.</p> <p>j) Remove 4 screws that fix EMI PBA, and pull out it. (using "+" screwdriver or electric motion driver)</p>	

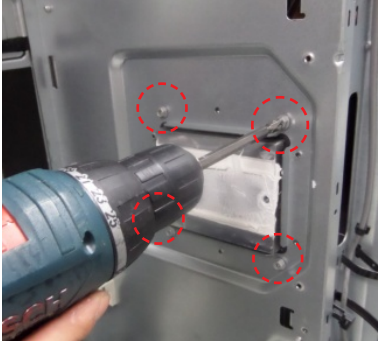
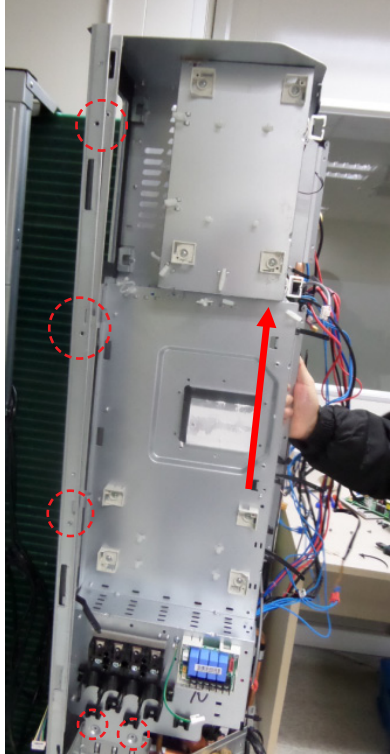
No.	Parts	Procedure	Remark
11	CONTROL BOX	<p>5) Remove 4 screws that fixing heat sink with control case.</p> <p>6) Remove 5 screws that fixing control box with partition and bracket valve.</p> <p>7) Then you can take off the whole control box.</p>	 

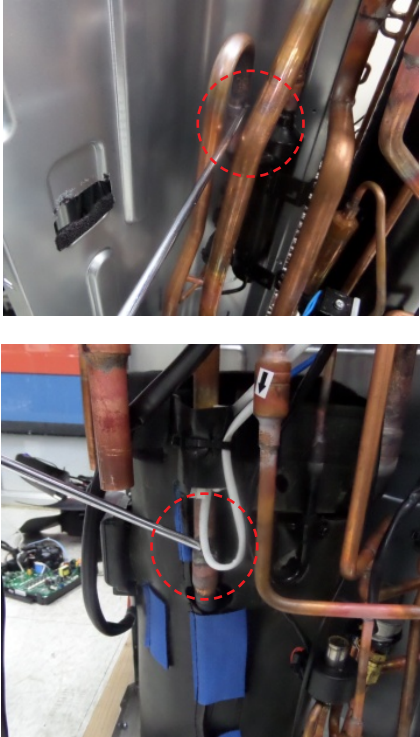
No.	Parts	Procedure	Remark
12	PLATE COOLING	1) Purge the Coolant first. 2) Separate 2 weld points on plate cooling by using a welder. <b>⚠ Warning :</b> When removing the compressor, Heat Exchanger, and Pipe, purge the Coolant inside the Compressor completely and remove the pipe with a welding flame.	
13	TUBE DISCHARGE	1) Separate 2 weld points by using a welder. (Tube discharge to oil separator & compressor)	



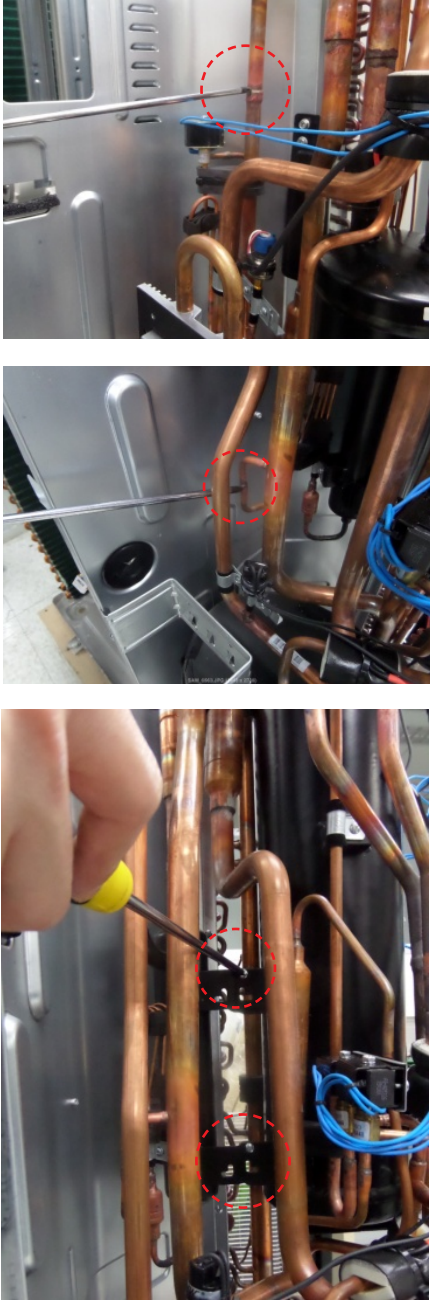

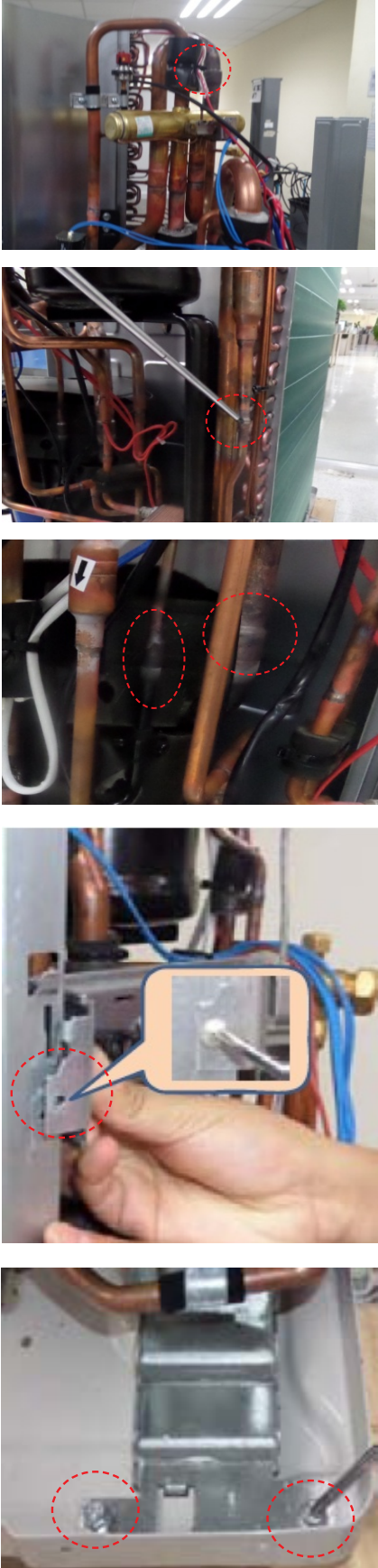

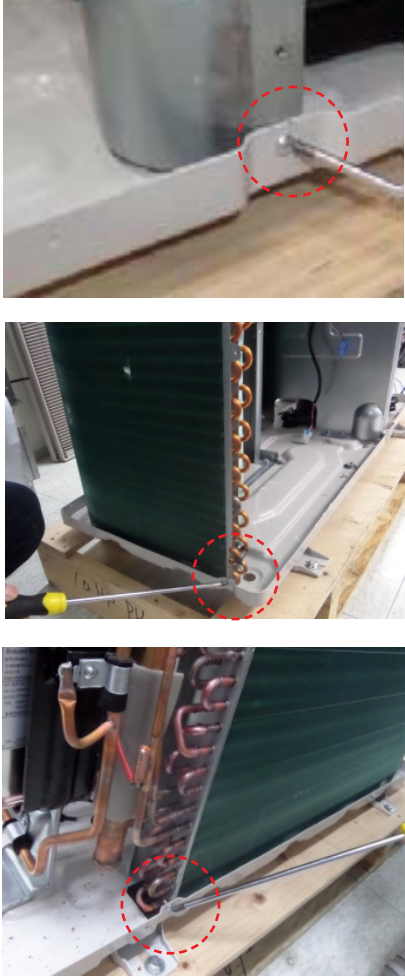
No.	Parts	Procedure	Remark
14	ASSY TUBE-OIL SEPARATOR	<p>1) Separate 2 weld points by using a welder . (1. Oil separator to 4way valve tube. 2.Oil tube to suction tube.)</p> <p>2) Remove 2 screws that fix oil separator on accumulator.</p>	

No.	Parts	Procedure	Remark
15	ASSY TUBE-4WAY VALVE	<p>1) Separate 2 weld points by using a welder. (4way valve to Assy cond)</p> <p>2) Separate 2 weld points by using a welder (1.scution tube to compressor. 2.tube vapor to compressor.)</p> <p>3) Remove 3 screws refer to the picture. - After ewmmove screw on bracket valve, need to pall up it from patition</p>	

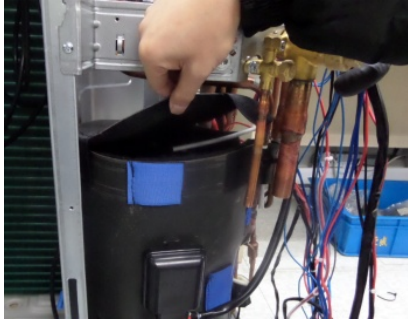
No.	Parts	Procedure	Remark
16	ASSY COND	1) Remove 1 screw that fix partition. Remove 2 screws that fix cond. (Using "+" screwdriver or electric motion driver.)	 <p>The Remark column contains three photographs illustrating the removal of screws from the condenser assembly. The top photo shows a screw being removed from the partition. The middle photo shows a screw being removed from the condenser assembly. The bottom photo shows a screw being removed from the condenser assembly.</p>

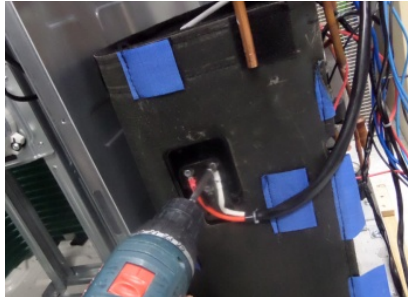

No.	Parts	Procedure	Remark
17	COMPERESSOR	<p>1) Remove felt top and felt side from compressor.</p> <p>2) Open cover power of comp,remove power wire. (using "+" screwdriver or electric motion driver)</p> <p>3) Remove 3 screws on front of comp and 1 screw back of comp.</p>	   

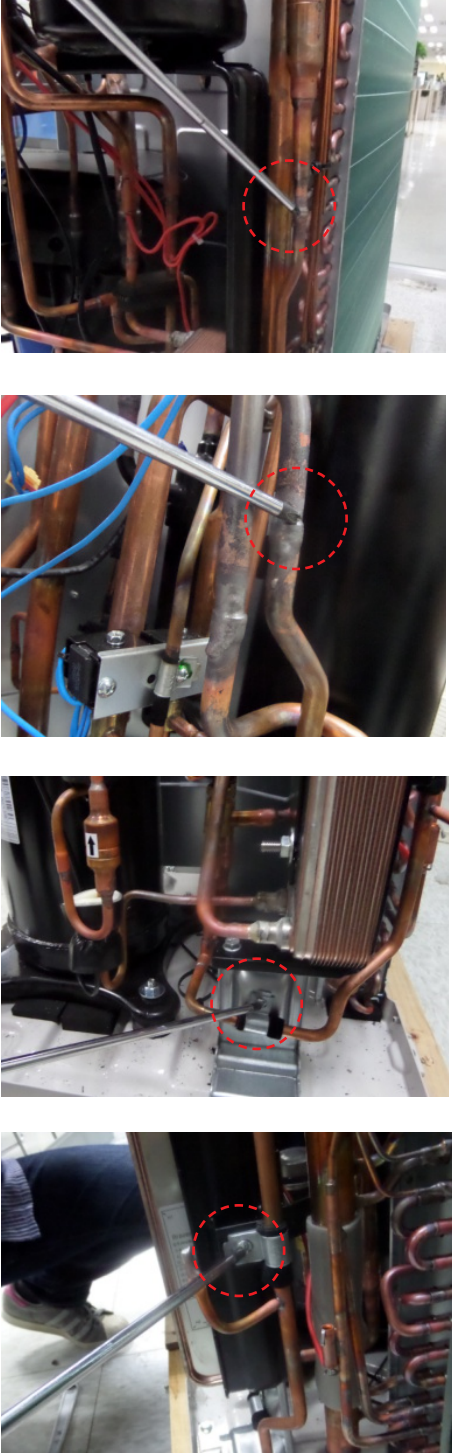
No.	Parts	Procedure	Remark
18	ASSY TUBE-EEV	<p>1) Separate 1 weld points by using a welder. (EEV tube to cond)</p> <p>2) Separate 1 weld points by using a welder. (EEV tube to tube plate cooling)</p> <p>3) Remove 2 screws fix assy eev tube on bracket accumulator. Pull out assy tube-EEV.</p>	

## 4. Troubleshooting

### 4-1 Wired remote controller































- ◆ If an error occurs,  is displayed on the wired remote controller.  
If you would like to see an error code, press the Test button.

Error mode	Contents	Error type
808	Indoor unit communication error	Communication error
808	Duplicated address setting error	Communication error
809	No response error address from indoor unit	Communication error
821	Indoor temperature sensor (open/short error)	Indoor sensor error
822	Indoor unit Eva In sensor (Open/Short)	Indoor sensor error
853	Indoor floating switch secondary detection	Self diagnostic error
202	Indoor/outdoor communication error (1 min)	Communication error
203	Communication error between indoor/outdoor INV↔MAIN MICOM (1 min)	Communication error
221	Outdoor temperature sensor error	Outdoor sensor error
231	COND temperature sensor error	Outdoor sensor error
251	[Inverter] Emission temperature sensor error	Outdoor sensor error
403	Detection of Indoor Freezing (when Comp. Stops)	Outdoor unit protection control error
404	Protection of Outdoor Overload (when Comp. Stops)	Outdoor unit protection control error
406	Emission temperature excessively high	Outdoor unit protection control error
422	High pressure blockage error (Refrigerant completely Leakage error)	Self diagnostic error
440	Heating operation blocked	Self diagnostic error
441	Cooling operation blocked	Self diagnostic error
458	Outdoor fan 1 error	Self diagnostic error
461	[Inverter] Compressor startup error	Outdoor unit protection control error
462	[Inverter] Total current error/PFC over current error	Outdoor unit protection control error

<b>Error mode</b>	<b>Contents</b>	<b>Error type</b>
<b>463</b>	OLP Overheat and Comp. Stop	Outdoor unit protection control error
<b>464</b>	[Inverter] IPM over current error	Outdoor unit protection control error
<b>465</b>	Compressor V limit error	Outdoor unit protection control error
<b>466</b>	DC LINK over/low voltage error	Outdoor unit protection control error
<b>467</b>	[Inverter] Compressor rotation error	Outdoor unit protection control error
<b>468</b>	[Inverter] Current sensor error	Outdoor unit protection control error
<b>469</b>	[Inverter] DC LINK voltage sensor error	Outdoor unit protection control error
<b>470</b>	EEPROM Read/Write error	Outdoor unit protection control error
<b>471</b>	[Inverter] OTP error	Outdoor unit protection control error
<b>472</b>	AC ZERO CROSSING SIGNAL OUT error	Outdoor unit protection control error
<b>473</b>	Compressor LOCK error	Outdoor unit protection control error
<b>475</b>	Outdoor fan 2 error	Self diagnostic error
<b>500</b>	IPM Overheat Error for Outdoor Unit Inverter Comp.	Outdoor unit protection control error
<b>554</b>	Gas leak error	Self diagnostic error
<b>556</b>	Capacities not matched	Outdoor unit protection control error
<b>601</b>	Communication error between the indoor unit and wired remote controller	Wired remote controller error
<b>602</b>	Communication error between the Master and Slave wired remote controllers	Wired remote controller error

- ◆ If an error occurs during the operation, one or more LED flickers and the operation is stopped except the LED.
- ◆ If you re-operate the air conditioner, it operates normally at first, then detect an error again.

## LED Display on the receiver & display unit

Abnormal conditions	Indicators					Remarks
	Concealed Type					
	GREEN	RED				
	Standard Type					
						
Power reset		X	X	X	X	
Error of Room sensor in the indoor unit(Open/Short)	X	X		X	X	
Error of EVA-IN,EVA-OUT discharge sensor in the indoor unit(Open/Short)		X		X	X	
Error of Fan motor in the indoor unit	X	X	X		X	
1. Error of Outdoor 2. Thermal Fuse Open Error of Indoor's Terminal Block	X	X				
1. Clogging of outdoor's service valve 2. the refrigerant leakage		X	X			
Detection of the float switch	X	X	X			
1. Error of EEPROM 2. Error of Option setting						
1. Error of Outdoor Temp. sensor 2. Error of Cond Temp. sensor 3. Error of discharge Temp. sensor		X	X		X	
1. No communication for 2 minutes between indoor units (Communication error for more than 2 minutes) 2. Indoor unit receiving the communication error from outdoor unit 3. Outdoor unit tracking 3 minutes error 4. When sending the communication error from the outdoor unit, the mismatching of the communication numbers and installed numbers after completion of tracking.(Communication error for more than 2 minutes)	X	X			X	1. Indoor unit error (Display is unrelated with operation) 2. Outdoor unit error (Display is unrelated with operation)

● On    ◐ Flickering    X Off

- ◆ If you turn off the air conditioner when the LED is flickering, the LED is also turned off.

## 4-2 Outdoor Trouble shooting

The table below give indication about self diagnostic routine. Some of error code requires activities exclusively for Authorized Service Center.

### Outdoor unit

If an error occurs during the operation, it is displayed on the outdoor unit PCB LED, both MAIN PCB and INVERTER PCB.

### Outdoor unit

If an error occurs during the operation, it is displayed on the outdoor unit PCB LED, both MAIN PCB and INVERTER PCB.

No.	Error Code	Meaning	Remarks
1	E108	Error due to repeated address setting(when 2 or more devices has same address within the network)	Check on repeated indoor unit main address
2	E121	Error on indoor temperature sensor of indoor unit(Short or Open)	Indoor unit Room Thermistor Open/Short
3	E122	Error on EVA IN sensor of indoor unit(Short or Open)	Indoor unit EVA_IN Thermistor Open/Short
4	E123	Error on EVA OUT sensor of indoor unit(Short or Open)	Indoor unit EVA_OUT Thermistor Open/Short
5	E153	Error on float switch (2nd detection)	"Indoor unit Float Switch Open/Short Drain Pump operation Check"
6	E154	RPM feedback error of indoor unit	Check on indoor unit indoor Fan operation
7	E162	Outdoor unit EEPROM Read/Write error (H/W)	Check Outdoor EEPROM PBA
8	E163	Outdoor unit EEPROM Read/Write error (Option)	Check Outdoor EEPROM Data
9	E198	Error on thermal fuse of indoor unit (Open)	Thermal Fuse Open Check of indoor unit Terminal Block
10	E201	"Communication error between indoor and outdoor unit(Installation number setting error repeated indoor unit address,indoor unit communication cable error)"	Check indoor quantity setting in outdoor
11	E202	"Communication error between indoor and outdoor unit(Communication error on all indoor unit, outdoor unit communication cable error)"	Check electrical connection and setting between indoor unit and outdoor unit
12	E205	Communication error on all PBA within the outdoor unit C-Box,communication cable error	-
13	E206	E206-C002 : Fan PBA communication error, E206-C003 : INV PBA communication error	-
14	E221	Error on outdoor temperature sensor (Short or Open)	Check Outdoor sensor Open / Short
15	E231	Error on outdoor COND OUT sensor (Short or Open)	Check Cond-Out sensor Open / Short
16	E251	Error on discharge temperature sensor of compressor 1 (Short or Open)	Check Discharge sensor Open / Short
17	E320	Error on OLP sensor (Short or Open)	Check OLP sensor Open / Short
18	E346	Error due to operation failure of Fan2	FAN2 error
19	E347	Motor wire of Fan2 is not connected	FAN2 error
20	E348	Lock error on Fan2 of outdoor unit	FAN2 error
21	E353	Error due to overheated motor of outdoor unit's Fan2	FAN2 error
22	E355	Error due to overheated IPM of Fan2	FAN2 error
23	E378	Error due to overcurrent of Fan2	FAN2 error
24	E386	Over-voltage/low-voltage error of Fan2	FAN2 error
25	E387	Hall IC connection error of Fan2	FAN2 error
26	E389	V-limit error on Fan2 of compressor	FAN2 error
27	E391	Error due to DataFlash of Fan2	FAN2 error
28	E393	Output current sensor error of Fan2	FAN2 error

No.	Error Code	Meaning	Remarks
29	E396	DC voltage sensor error of Fan2	FAN2 error
30	E399	Heat sink temperature sensor error of Fan2	FAN2 error
31	E403	Compressor down due to freeze protection control	Check Outdoor Cond.
32	E404	System stop due to overload protection control	Check Comp. when it start
33	E416	System stop due to discharge temperature	-
34	E422	Blockage detected on high pressure pipe	1. Check if the service valve is open 2. Check for refrigerant leakage(pipe connections, heat exchanger) and charge refrigerant if necessary 3. Check if there's any blockage on refrigerant cycle(indoor unit/outdoor unit) 4. Check if additional refrigerant has been added after pipe extension
35	E425	Reverse phase or open phase	Check whether 3 phase is reversed or opened.
36	E440	Heating mode restriction due to high air temperature	HEATING
37	E441	Cooling mode restriction due to low air temperature	COOLING
38	E446	Error due to operation failure of Fan1	FAN1 error
39	E447	Motor wire of Fan1 is not connected	FAN1 error
40	E448	Lock error on Fan1 of outdoor unit	FAN1 error
41	E452	Error due to ZCP detection circuit problem or power failure	-
42	E453	Error due to overheated motor of outdoor unit's Fan1	FAN1 error
43	E455	Error due to overheated IPM of Fan1	FAN1 error
44	E458	Fan speed error	FAN1 ERROR
45	E461	Error due to operation failure of inverter compressor	-
46	E462	System stop due to full current control	-
47	E463	Over current trip / PFC over current error	Check OLP sensor
48	E464	IPM Over Current(O.C)	IPM
49	E465	Comp. Over load error	-
50	E466	DC-Link voltage under/over error	Check AC Power and DC Link Voltage
51	E467	Error due to abnormal rotation of the compressor or unconnected wire of compressor	Check Comp wire
52	E468	Error on current sensor (Short or Open)	Check Outdoor Inverter PBA.
53	E469	Error on DC-Link voltage sensor (Short or Open)	-
54	E471	Outdoor EEPROM checksum error between MAIN and INVERTER (AC***KXAPNH)	Check Outdoor EEPROM PBA
55	E472	AC Line Zero Cross Signal out	-
56	E473	Comp Lock error	-
57	E474	Error on IPM Heat Sink sensor of inverter 1 (Short or Open)	heck Outdoor Inverter PBA
58	E475	Error on inverter fan 2	FAN2 ERROR
59	E478	Error due to overcurrent of Fan1	FAN1 error
60	E484	PFC Overload (Over current) Error	Check Outdoor Inverter PBA.
61	E485	Error on input current sensor of inverter 1 (Short or Open)	Check Outdoor EEPROM PBA
62	E486	Over-voltage/low-voltage error of Fan1	FAN1 error

No.	Error Code	Meaning	Remarks
63	E487	Hall IC connection error of Fan1	FAN1 error
64	E489	V-limit error on Fan1 of compressor	FAN1 error
65	E491	Error due to DataFlash of Fan1	FAN1 error
66	E493	Output current sensor error of Fan1	FAN1 error
67	E496	DC voltage sensor error of Fan1	FAN1 error
68	E499	Heat sink temperature sensor error of Fan1	FAN1 error
69	E500	IPM over heat error on inverter 1	Check Outdoor Inverter PBA.
70	E508	Smart install is not installed	-
71	E554	Gas leak detected	Check the refrigerant
72	E556	Error due to mismatching capacity of indoor and outdoor unit	Check the indoor and Outdoor unit Capacity
73	E557	Option code miss matching among the indoor units (only for DPM)	Check the indoor option code
74	E590	Outdoor EEPROM checksum error between MAIN and INVERTER (AC***JXAFKH, AC***JXAFNH, AC***JXAPNH)	-
75	E660	Inverter Boot Code error	-



## 4-3 Troubleshooting by symptoms

### 4-3-1 Indoor temperature sensor (open/short)

Wire remote controller display	E121
Symptom	Error of Room sensor in the indoor unit(Open/Short)
Failure	Short or leakage of the Room sensor

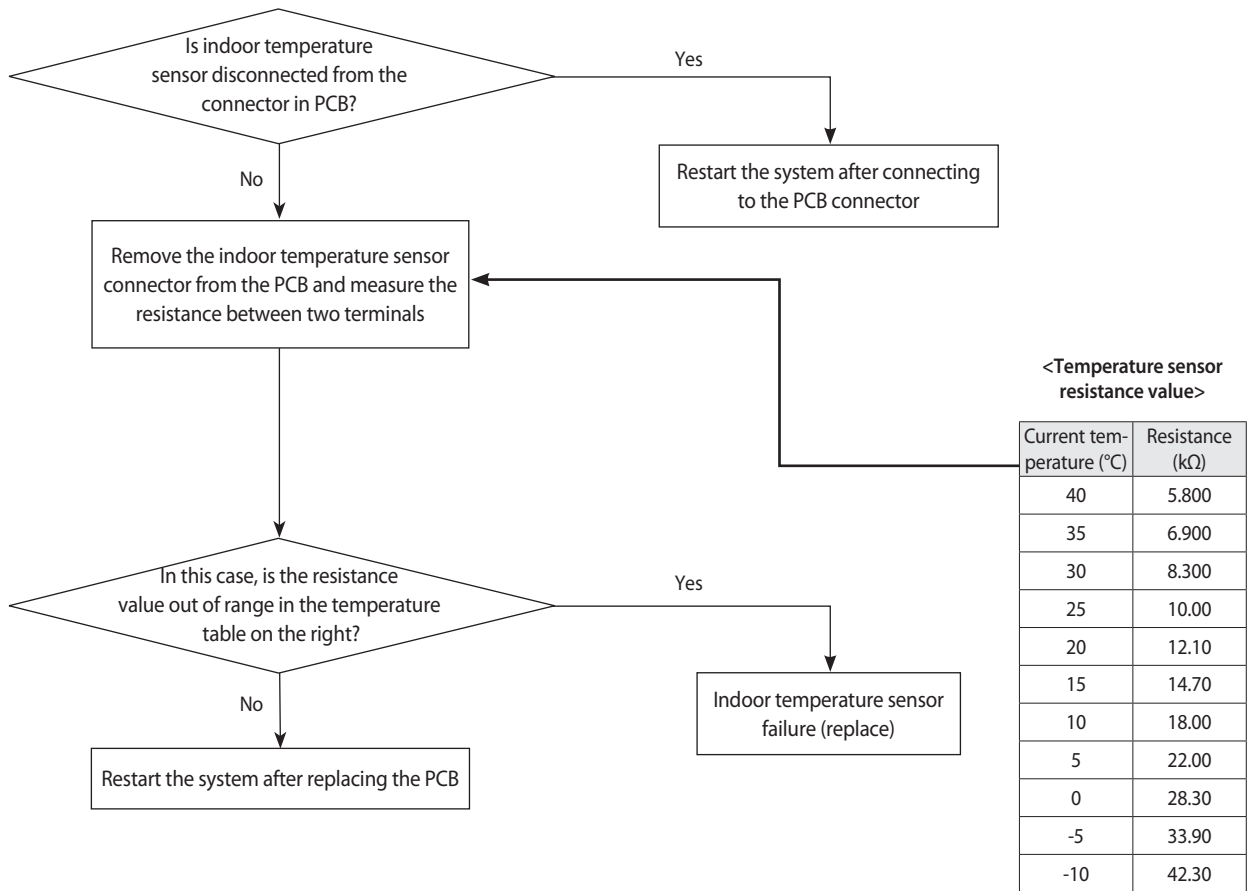

### 4-3-2 Eva in and out sensor (open/short)

Wire remote controller display	E122, E123
Symptom	Error of EVA-IN, EVA-OUT sensor in the indoor unit (Open/Short)
Failure	Short or leakage of the EVA sensor

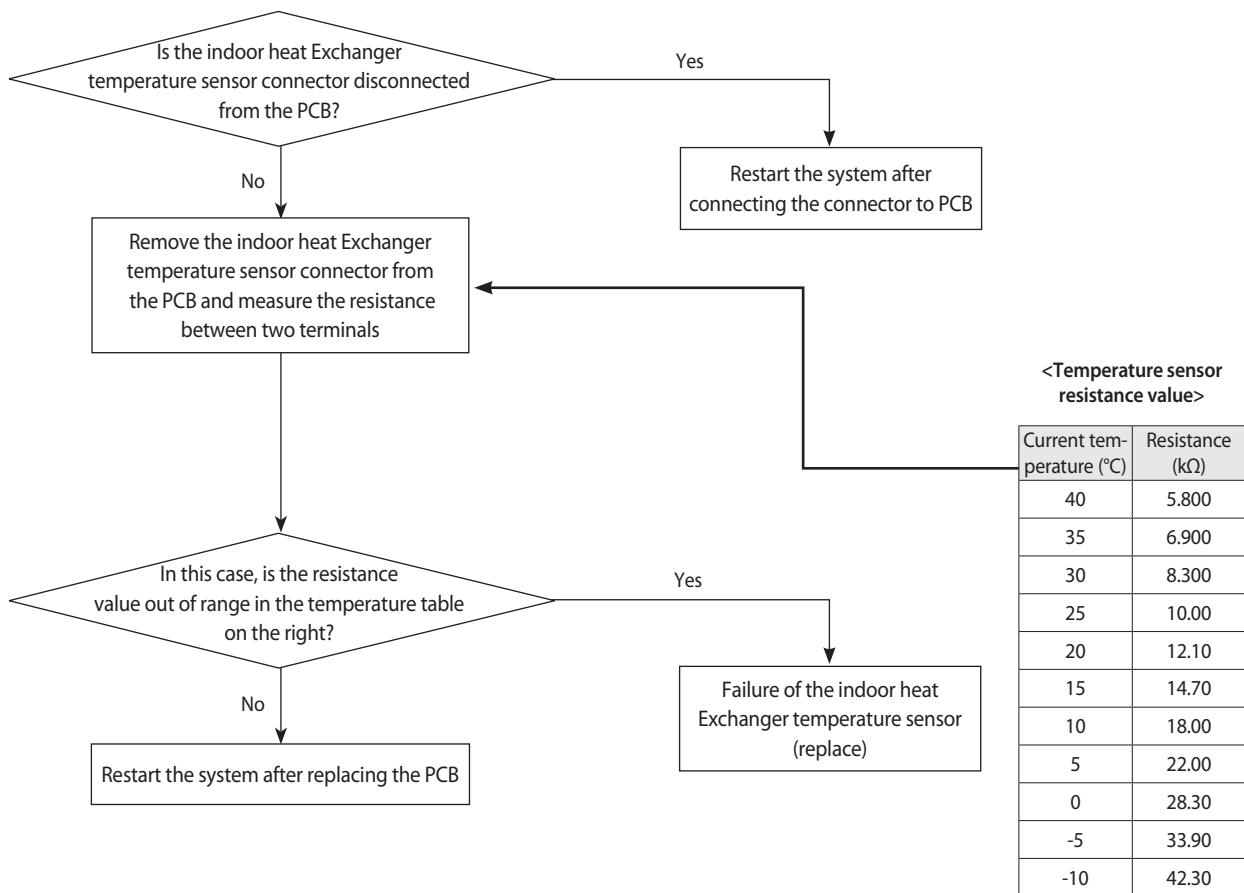

### 4-3-3 Float switch(Open)

Wire remote controller display	E153
Symptom	2nd Detection of the float switch
Failure	Float switch open

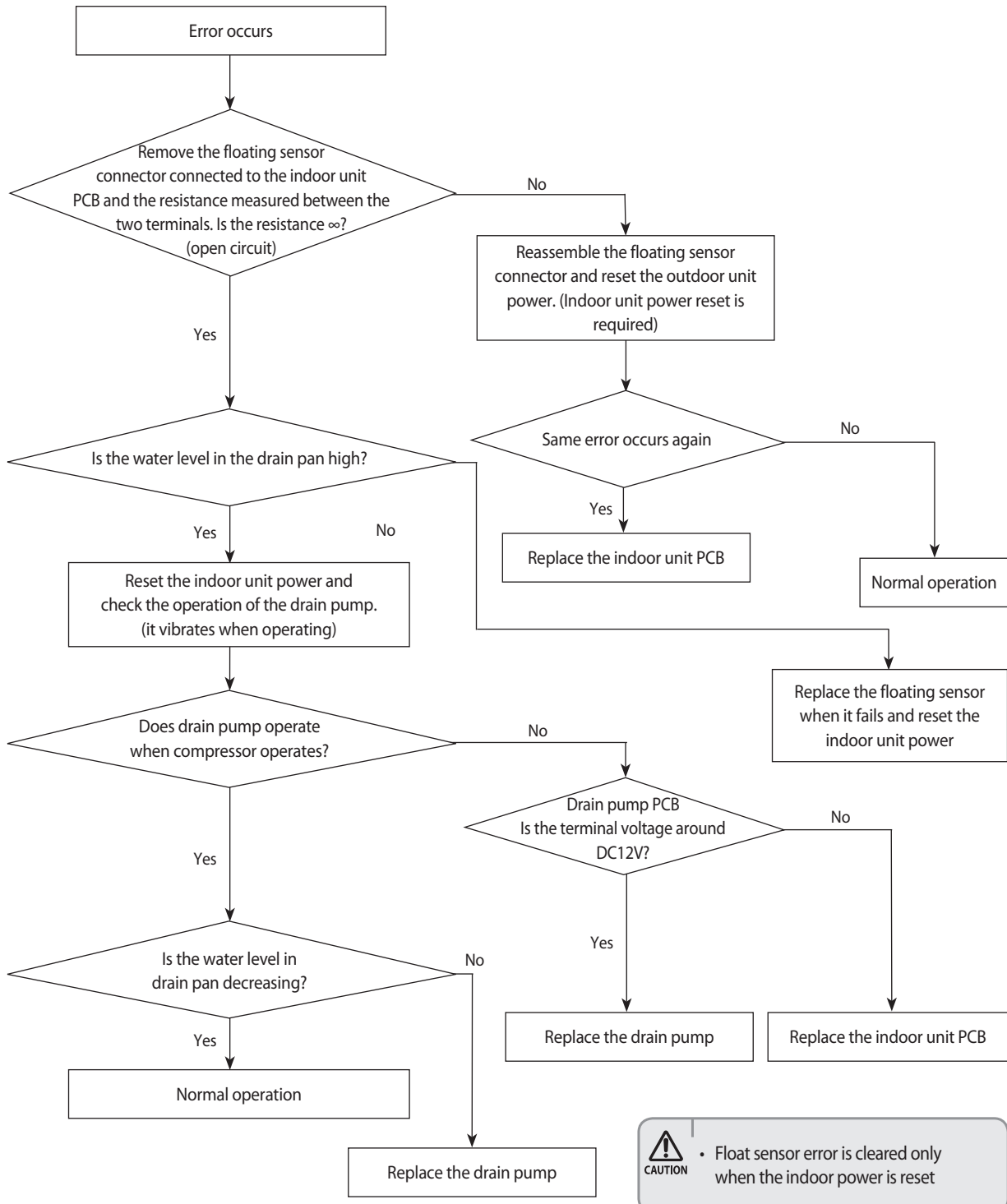

**CAUTION** • Float sensor error is cleared only when the indoor power is reset

### 4-3-4 Fan error

Wire remote controller display	E154
Symptom	Error of Fan motor in the indoor unit
Failure	Fan error

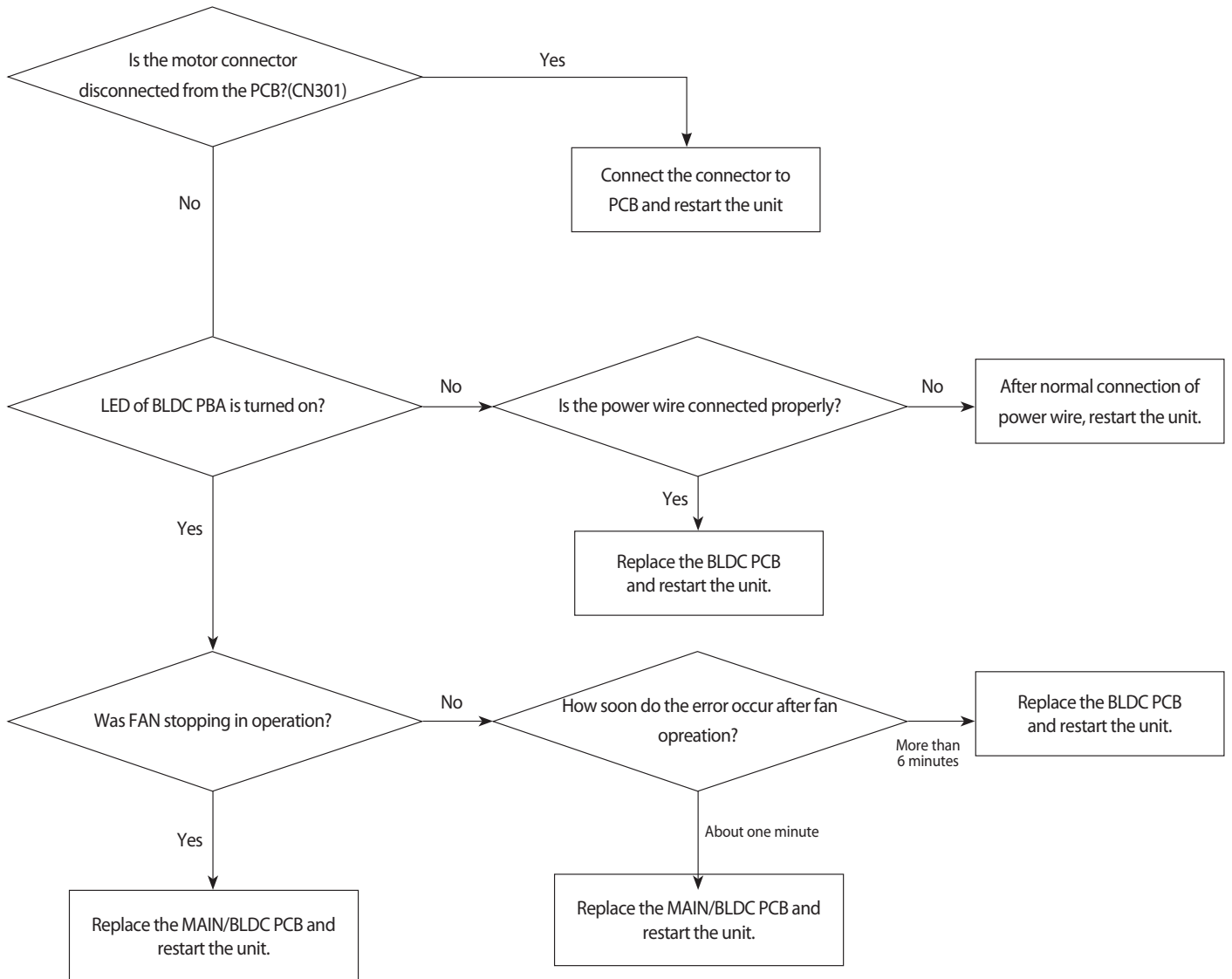

### 4-3-5 EEPROM error

Wire remote controller display	E162
Symptom	EEPROM PCB disconnected from the MAIN PCB
Failure	Option error

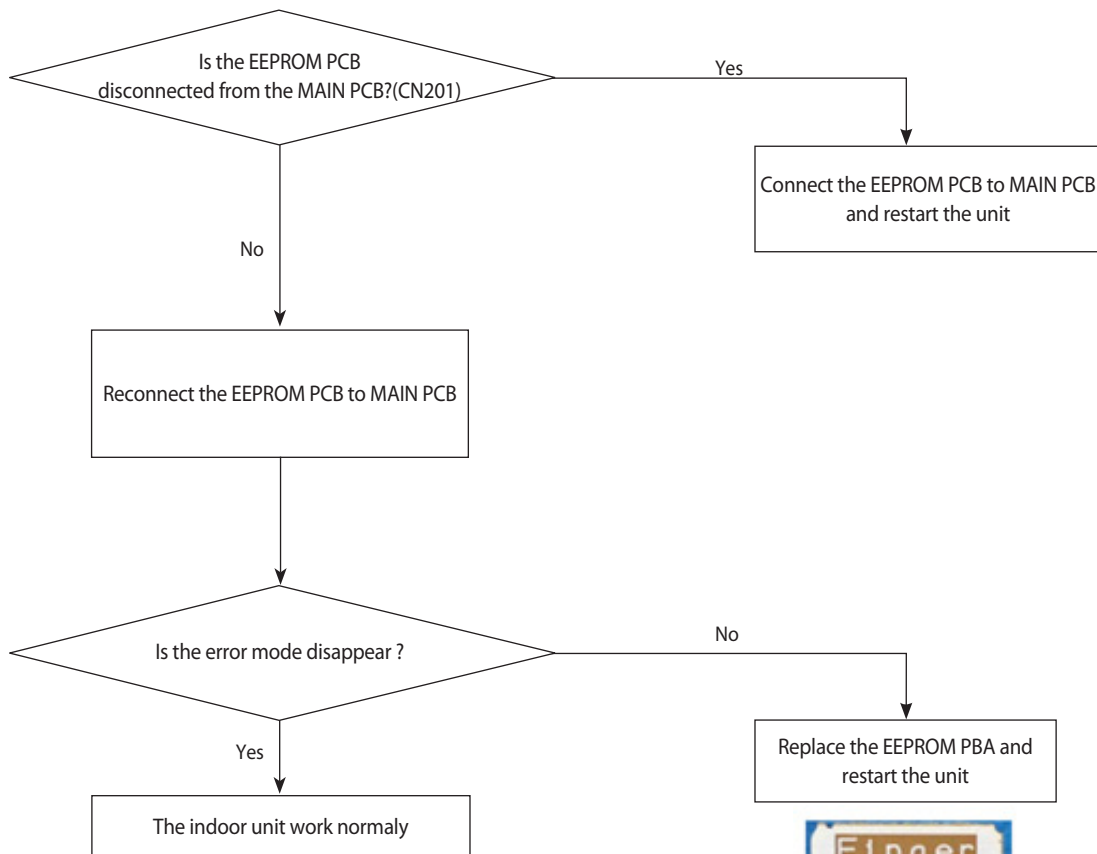

### 4-3-6 Option error

Wire remote controller display	E163
Symptom	EEPROM option setting error
Failure	Option error

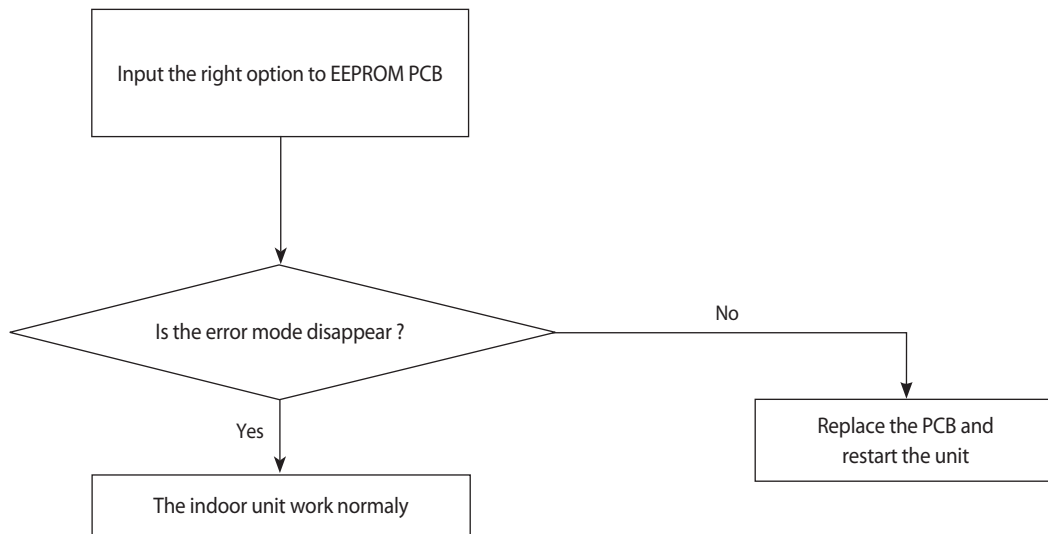



### 4-3-7 Terminal Block's Terminal Fuse(Open)

Wire remote controller display	E198
Symptom	Error of Terminal Block's Terminal Fuse(Open)
Failure	Fuse open

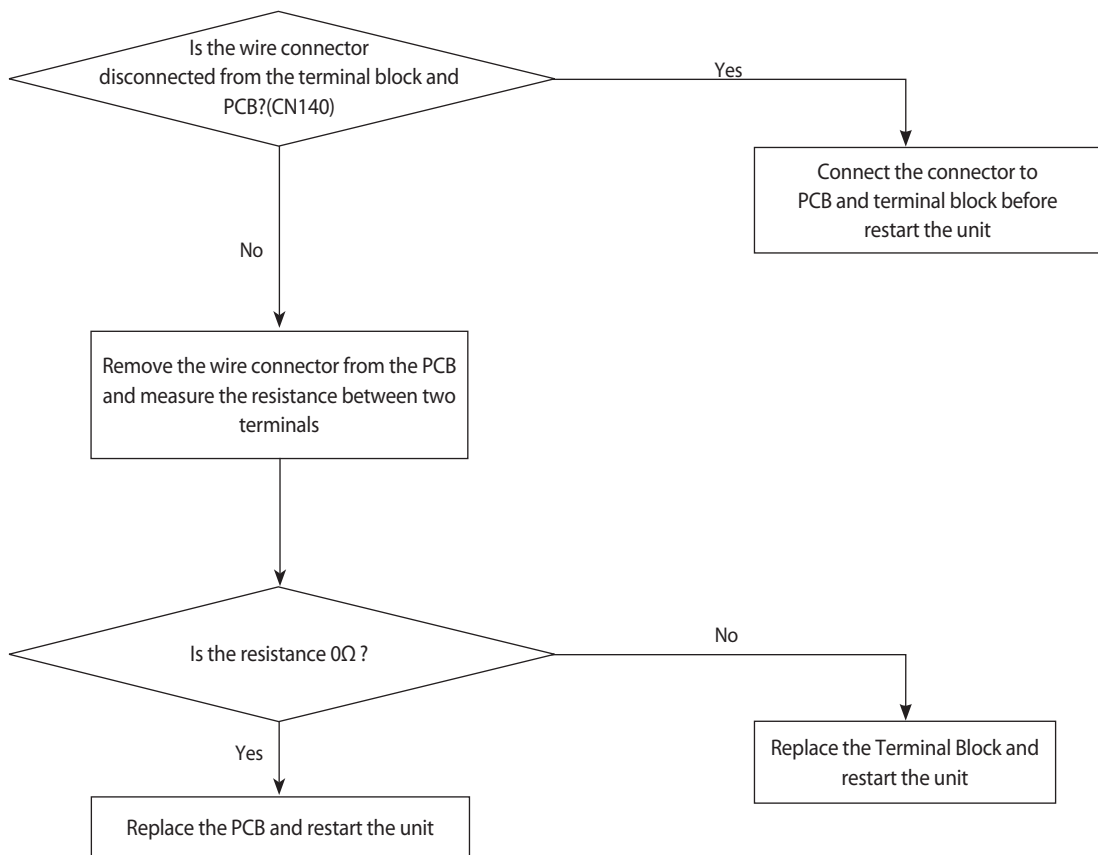

### 4-3-8 Communication error after finishing tracking (E202)

1. Check items
  - 1) Is the communication cable short/open?
  - 2) Is there a response from the indoor unit PCB?
2. Check procedure

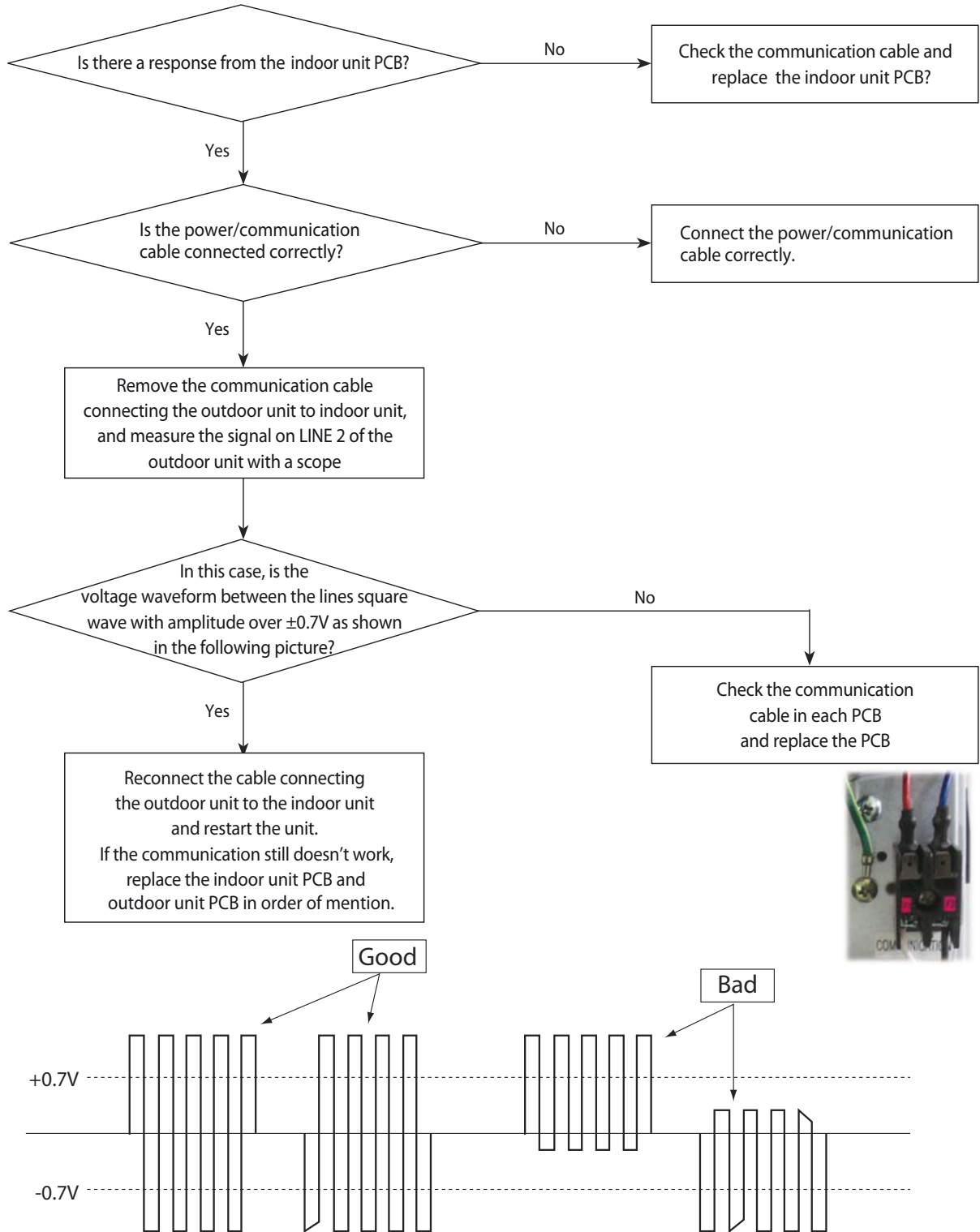

cf.) If there is no oscillo scope, it can be replaced multimeter instead of osillo scope.  
 If measured voltage is floating value from 0.1V to 4.5V, then it means that the PCB is normal.

### 4-3-9 Outdoor's service valve(Clog)

Wire remote controller display	E422
Symptom	Clogging of outdoor's service valve
Failure	Valve clog

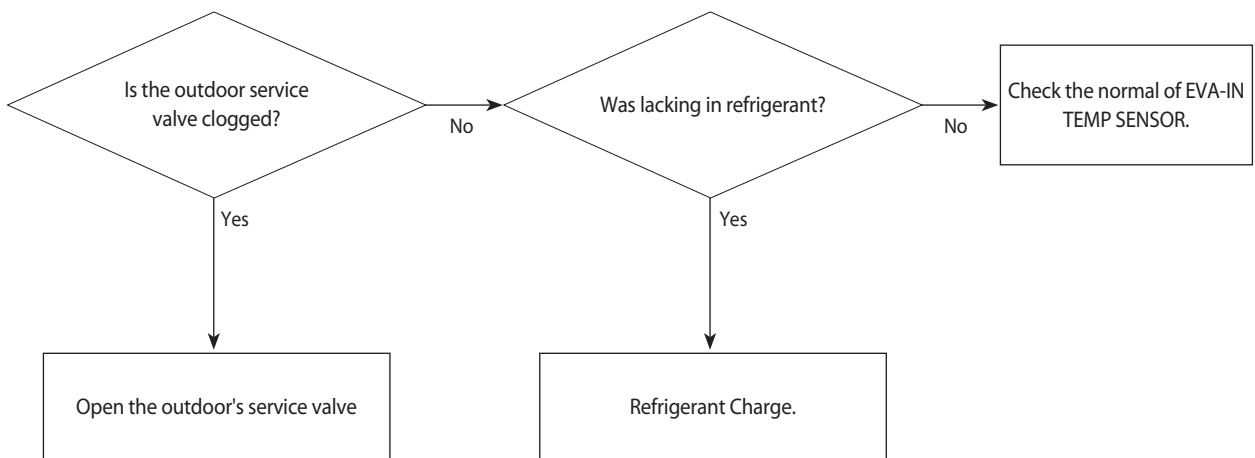

## 4-3-10 No Power(completely dead) - Initial diagnosis

### Outdoor unit is not powered on – Initial diagnosis (1phase)

1. Check items
  - 1) Is the power supply voltage 220V?
  - 2) Is the AC power connected correctly?
  - 3) Are the LEDs in the main PCB and inverter PCB of the outdoor unit ON?
  - 4) Is the input power voltage of the indoor unit 220V?
  - 5) Is the wired remote controller connected correctly?
2. Check procedure

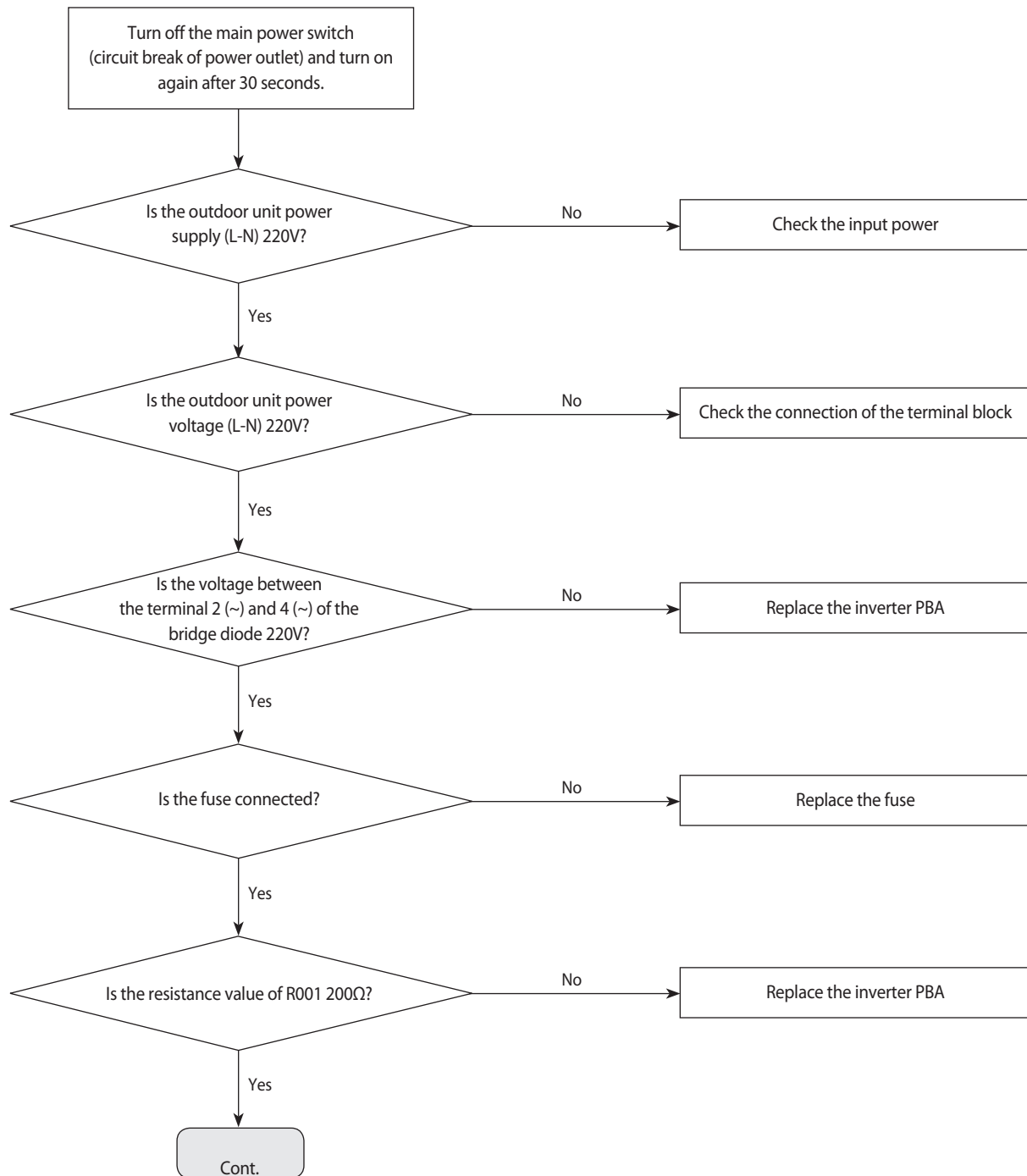

**Outdoor unit is not powered on – Initial diagnosis (1phase) (cont.)**

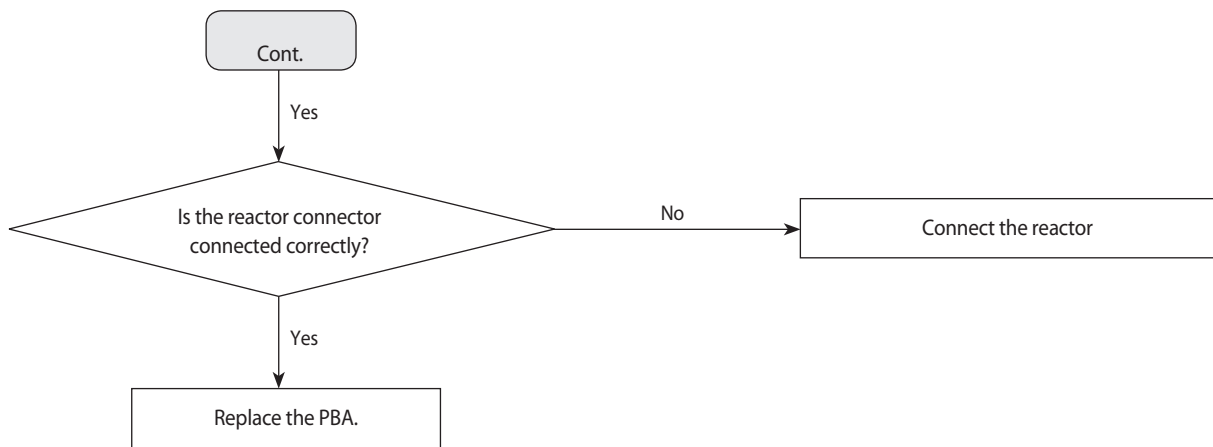

## Outdoor unit is not powered on – Initial diagnosis ( 3phase)

1. Check items:
  - 1) Is the power supply voltage 380V?
  - 2) Is the AC power connected correctly?
  - 3) Are the LEDs in the main PCB and inverter PCB of the outdoor unit ON?
  - 4) Is the input power voltage of the indoor unit 220V?
  - 5) Is the wired remote controller connected correctly?

### 2. Troubleshooting procedure

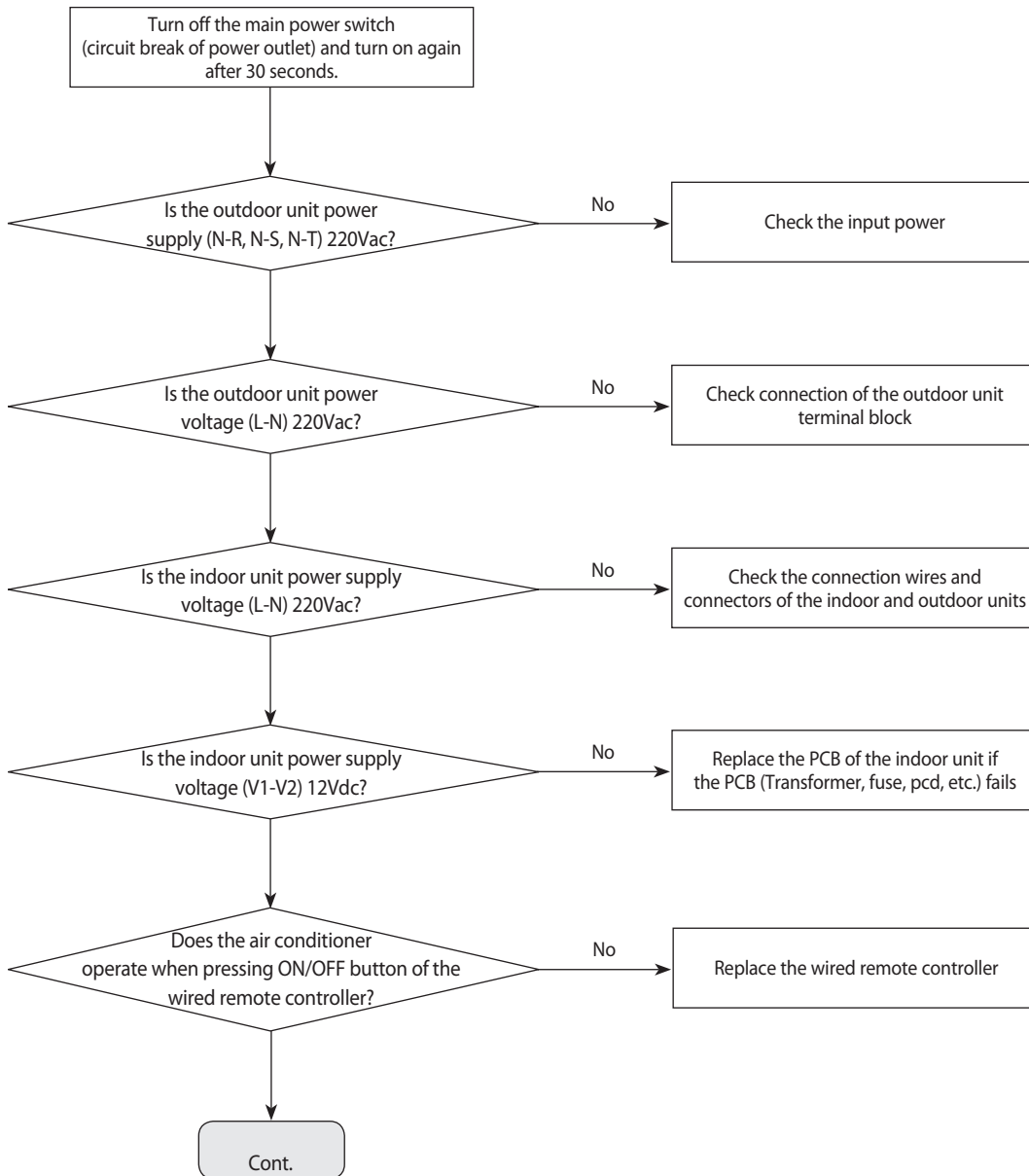



## Outdoor unit is not powered on – Initial diagnosis ( 3phase) (cont.)

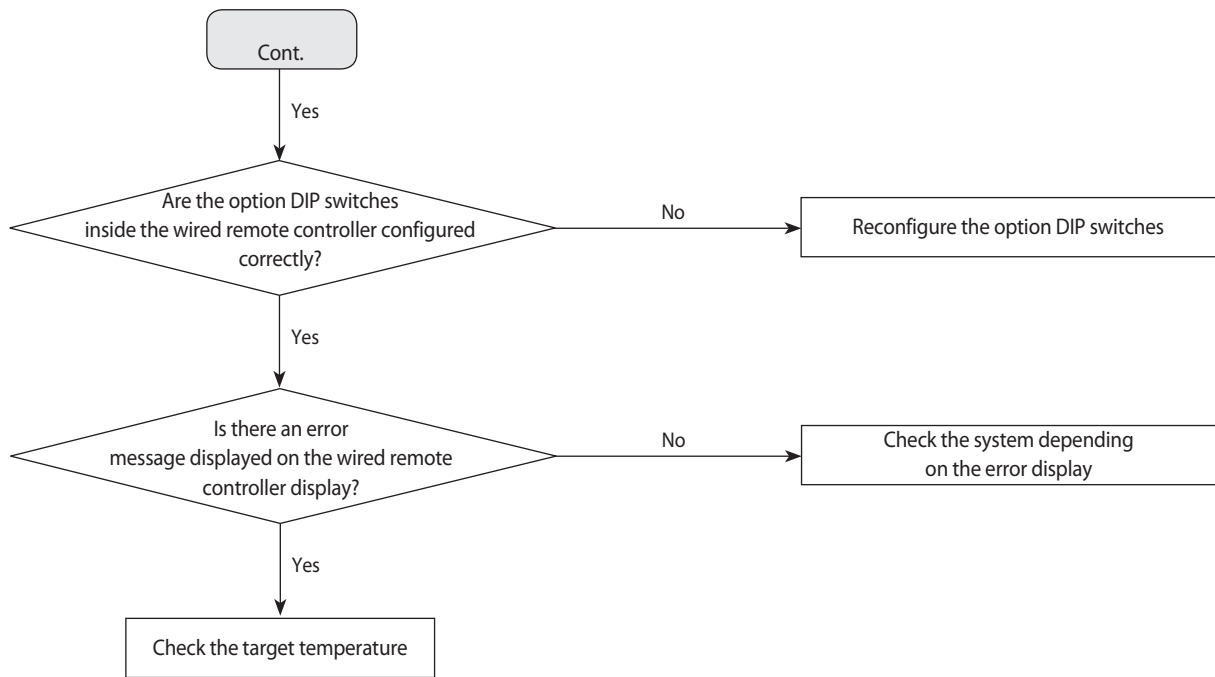

**4-3-11 E102 : Communication error between indoor and outdoor unit**  
**E201 : Unit quantity miss matching between Indoor and Outdoor**  
**E202 : Abnormal state, no communication between Indoor and Outdoor Main PCB**  
**E203 : 1min Time out of communication error(Main↔Inverter)**

1. Checklist :
  - 1) Is the communication cable between the indoor unit and outdoor unit connected correctly?
  - 2) Isn't the power cable and communication cable wiring error?

2. Troubleshooting procedure

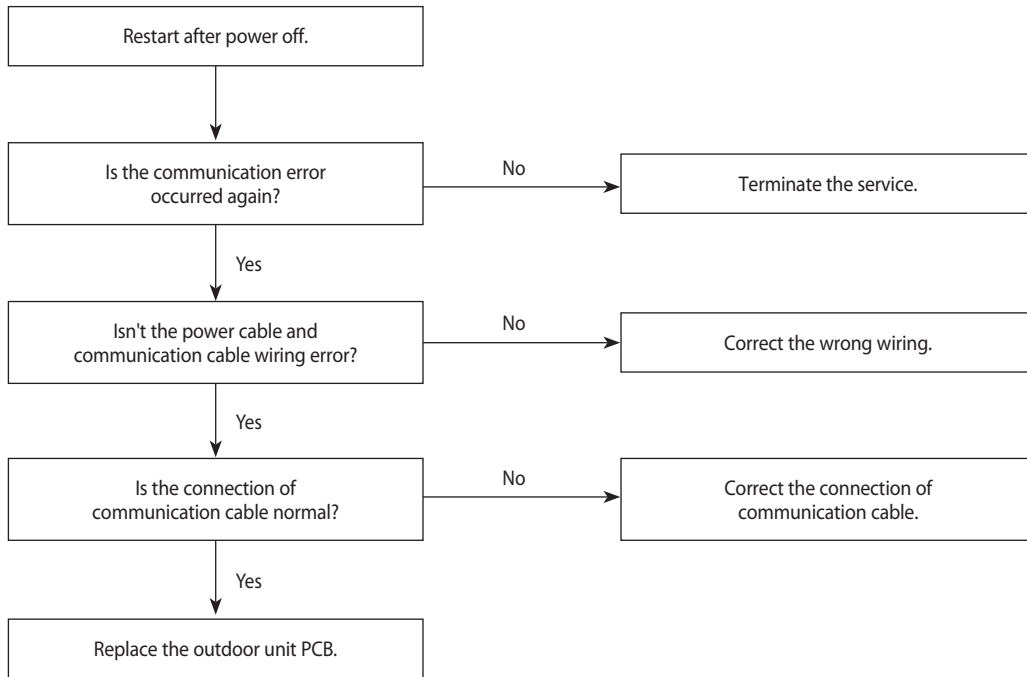

### 4-3-12 External Sensor Error (Error Code: E221, E231, E251, E320)

1. Test Item
  - 1) Check the connection of the temperature sensor connector.
  - 2) Check the resistance value of the temperature sensor.
2. Check procedure

Error Code	Description
E221	Error of the temperature sensor of the outdoor unit
E231	Error of the COND. sensor of the outdoor unit
E251	Error of the discharge sensor of the outdoor unit
E320	Error of the OLP sensor of the outdoor unit

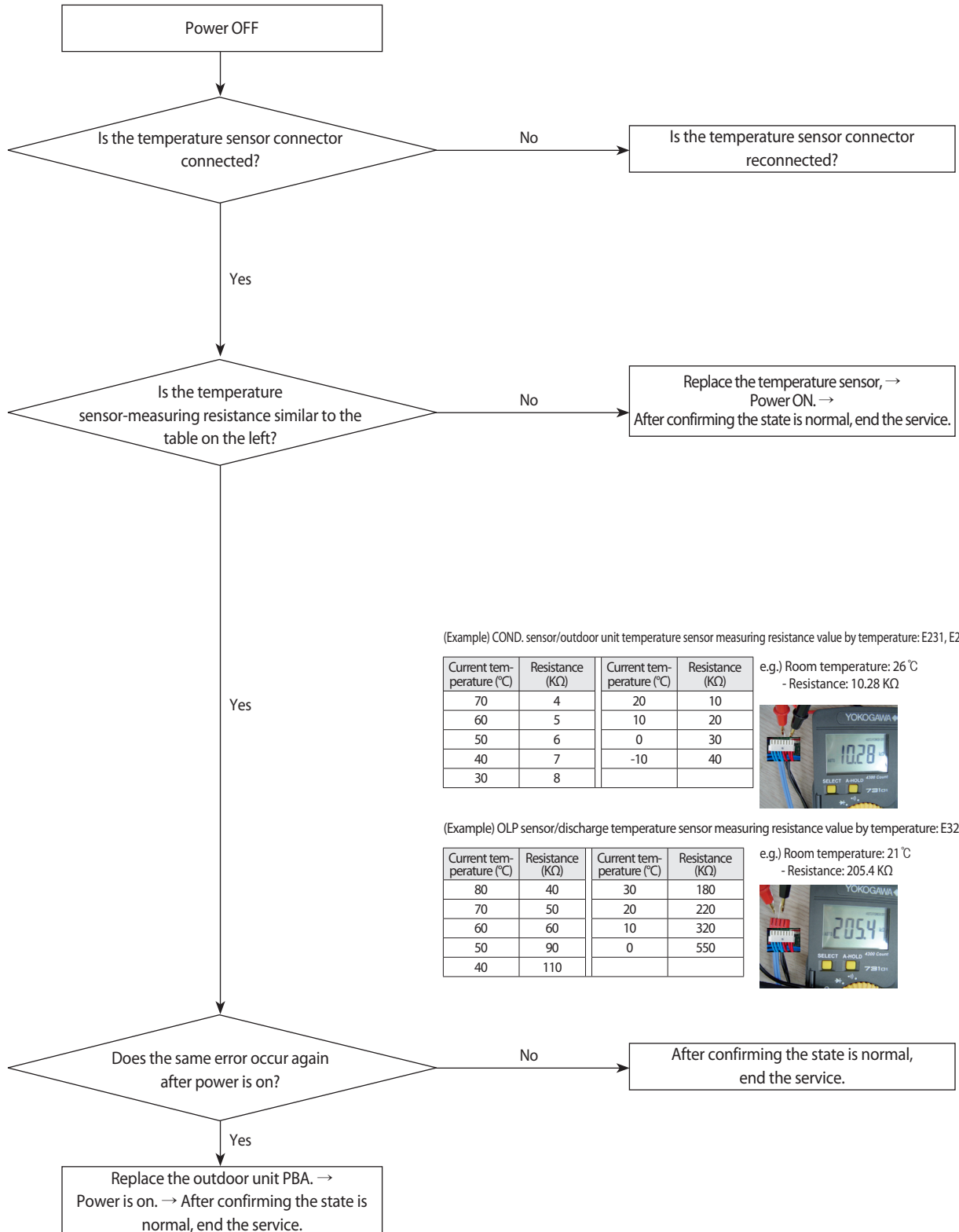

### 4-3-13 E403 : Freezing control causes comp. down

Outdoor unit display	E403
Criteria	•All the operating indoor machines do not reach -4°C for more than five minutes
Cause of problem	•Check if the indoor FAN/MOTOR operates normally. •Check if the indoor EEV operates normally. •Check the indoor heat Exchanger's IN/OUT sensor. •Check for clogging in the suction area of the indoor machine.

#### 1. How to check

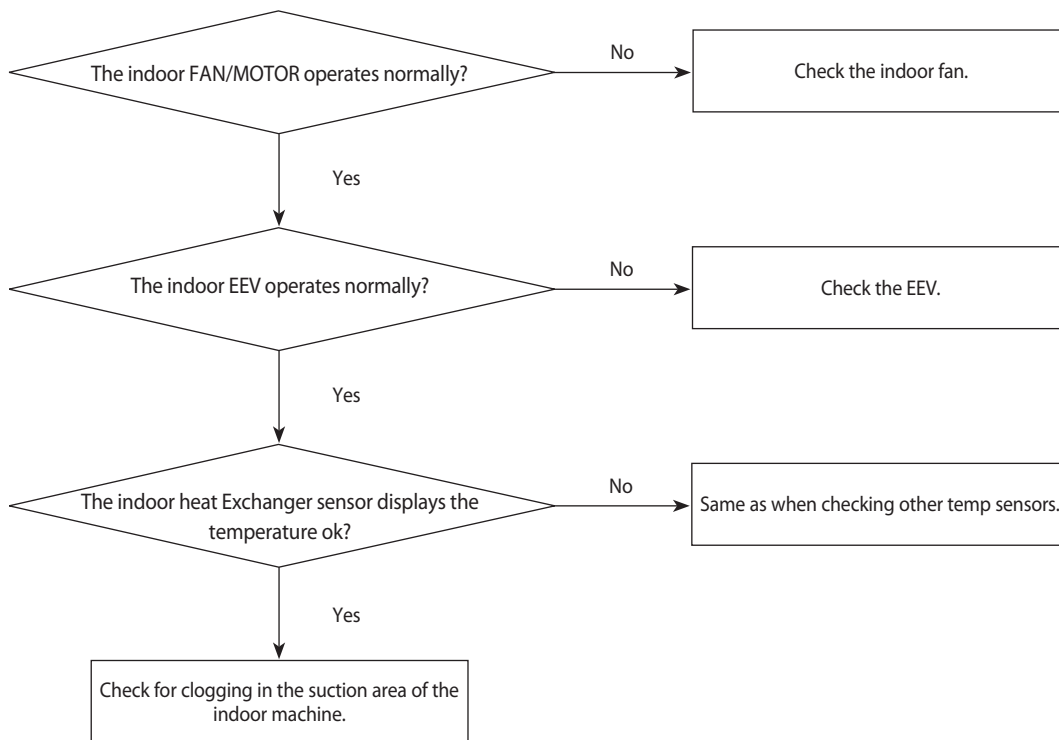

### 4-3-14 E416 : Discharge temperature sensor error

Outdoor unit display	E416
Criteria	•The compressor temperature above 110°C.
Cause of problem	<ul style="list-style-type: none"> <li>•Insufficient coolant.</li> <li>•Clogging in the outdoor machine's solenoid valve.</li> <li>•Clogging in the sub valve.</li> <li>•Malfunctioning exhaust gas temp sensor.</li> <li>•Clogging in the pipeline and the filter.</li> <li>• Liquid EEV damaged.</li> </ul>

#### 1. How to check

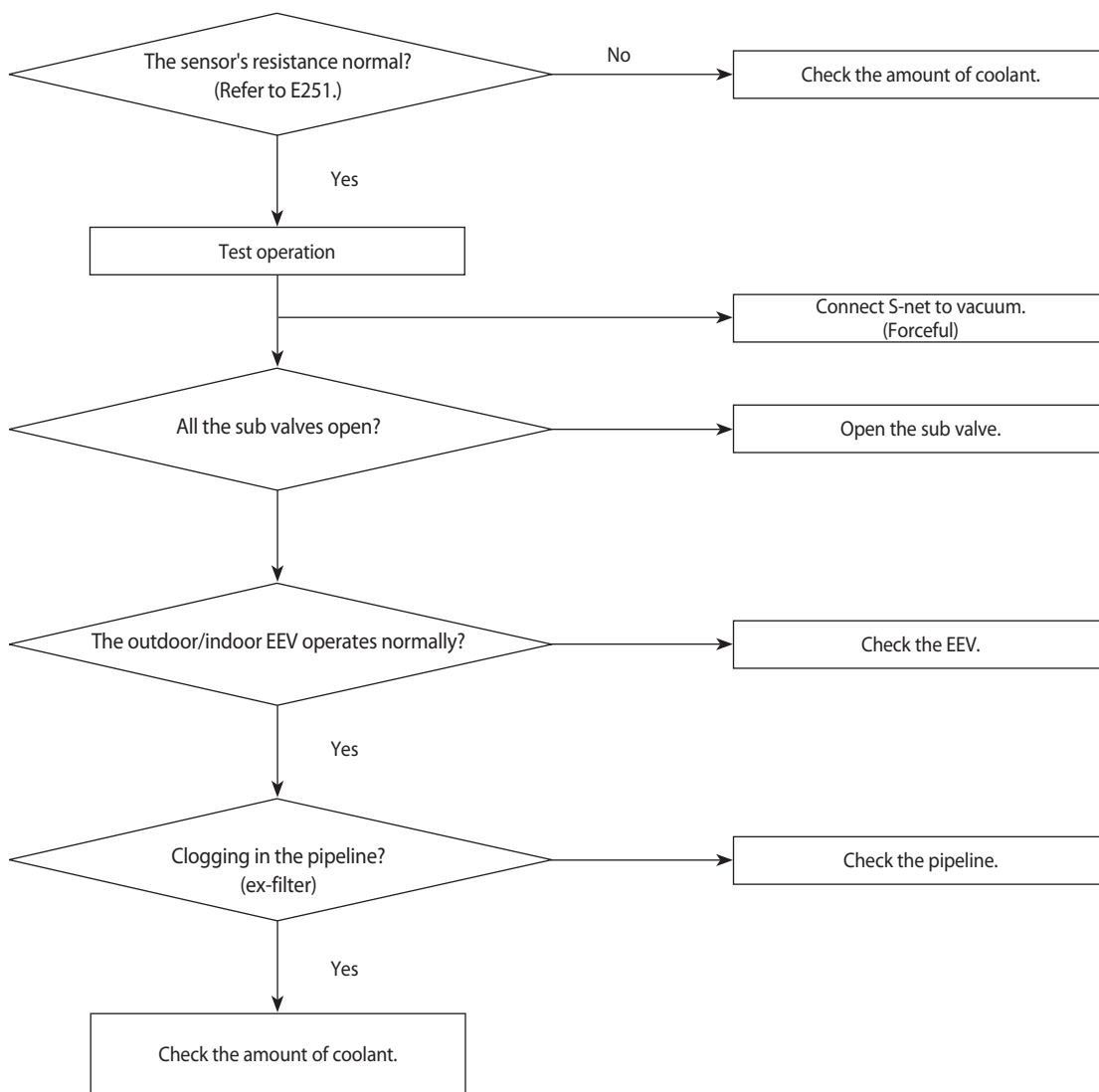

### 4-3-15 E440, E441 : Abnormal outside temperature halts operation of the compressor

<b>Outdoor unit display</b>	E440 (No heater operation with the outside temperature above 30°C.) E441 No AC operation with the outside temperature below -10°C.)
<b>Criteria</b>	•The compressor temperature above 110°C.
<b>Cause of problem</b>	E440: If the outside temperature is above 30°C, operation of the indoor heater with a remote control causes this error. E441: The indoor machine remote control ON signal. If the outside temperature is below -10°C before the AC runs, this error occurs.
<b>Cause of problem</b>	•OLP SENSOR temp above Trip_Dis.

1. How to check

The above malfunction codes do not indicate a malfunction of the product. All you have to do is change the temperature suitably for the limits shown in the manual. When the product malfunctions, if the actual situation does not match the above diagnosis, measure the temperature of incoming air with S-net to see if the measurement is the same as the actual outdoor temperature. If not, replace the temperature sensor.



### 4-3-16 Outdoor unit BLDC Fan1 or Fan2 error (E458 : Fan1 error, E475 : Fan2 error)

1. Checklist :

- 1) Isn't the fan locked?
- 2) Is the sensor placed correctly?
- 3) Does the both terminal of sensor satisfy the resistance value in accordance with temperature?
- 4) Is the resistance value of sensor connection pull\_up correct?

2. Troubleshooting procedure

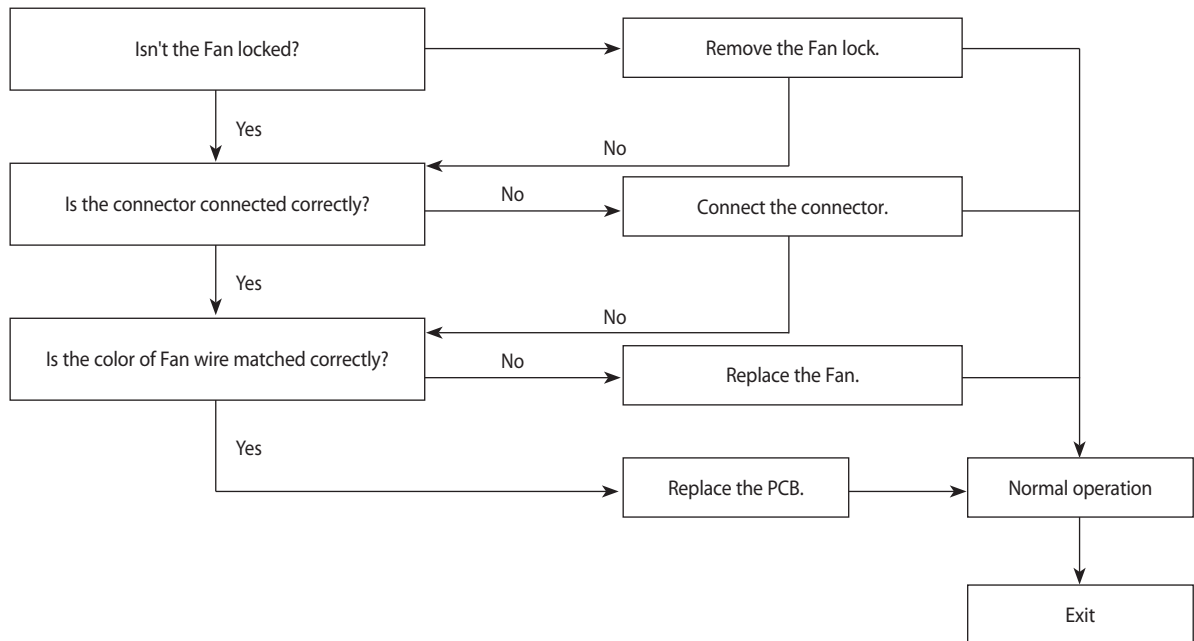

### 4-3-17 E461: Compressor start error E467: Compressor wire missing error

1. Checklist :
  - 1) Is the connection of cable for the compressor and power?
  - 2) Is the interphase resistance of compressor normal?
2. Troubleshooting procedure

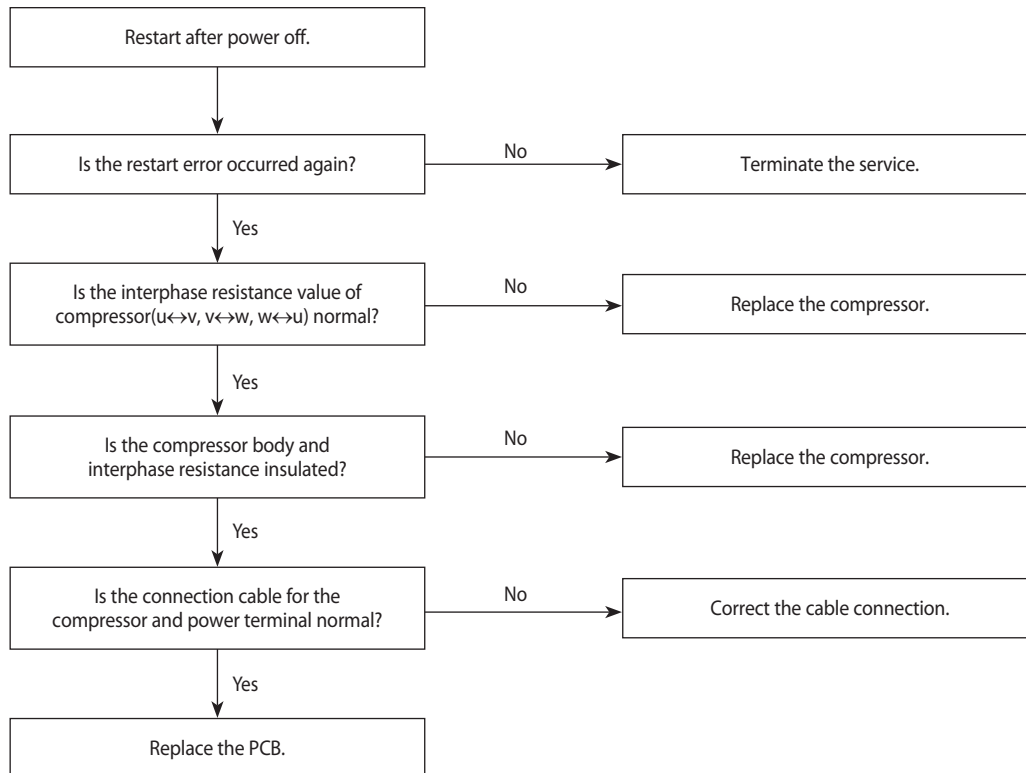

**4-3-18 E462 : Current protection control causes comp. down**  
**E484 : PFC overload error**

Outdoor unit display	E462,E484
Criteria	• The outdoor machine input current above I_Trip.
Cause of problem	•Check the compressor input voltage. (error for low voltage.) •Check the overcurrent option setting.

1. How to check

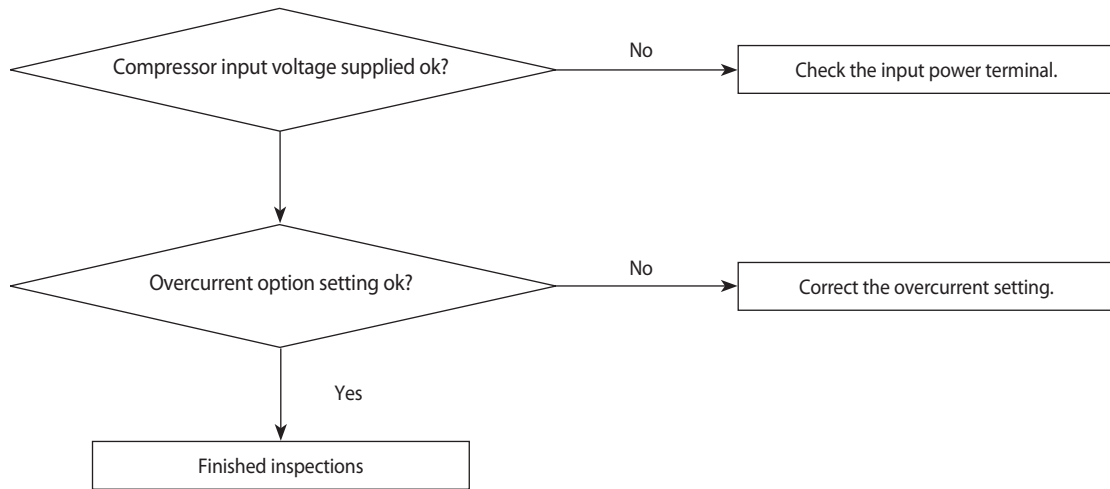

### 4-3-19 E463 : OLP protection control caused comp. down

Outdoor unit display	E463
Criteria	• OLP SENSOR temp above Trip_Dis.
Cause of problem	• See if the sub valve is open. • Check the amount of coolant. • Check the OLP sensor.

#### 1. How to check

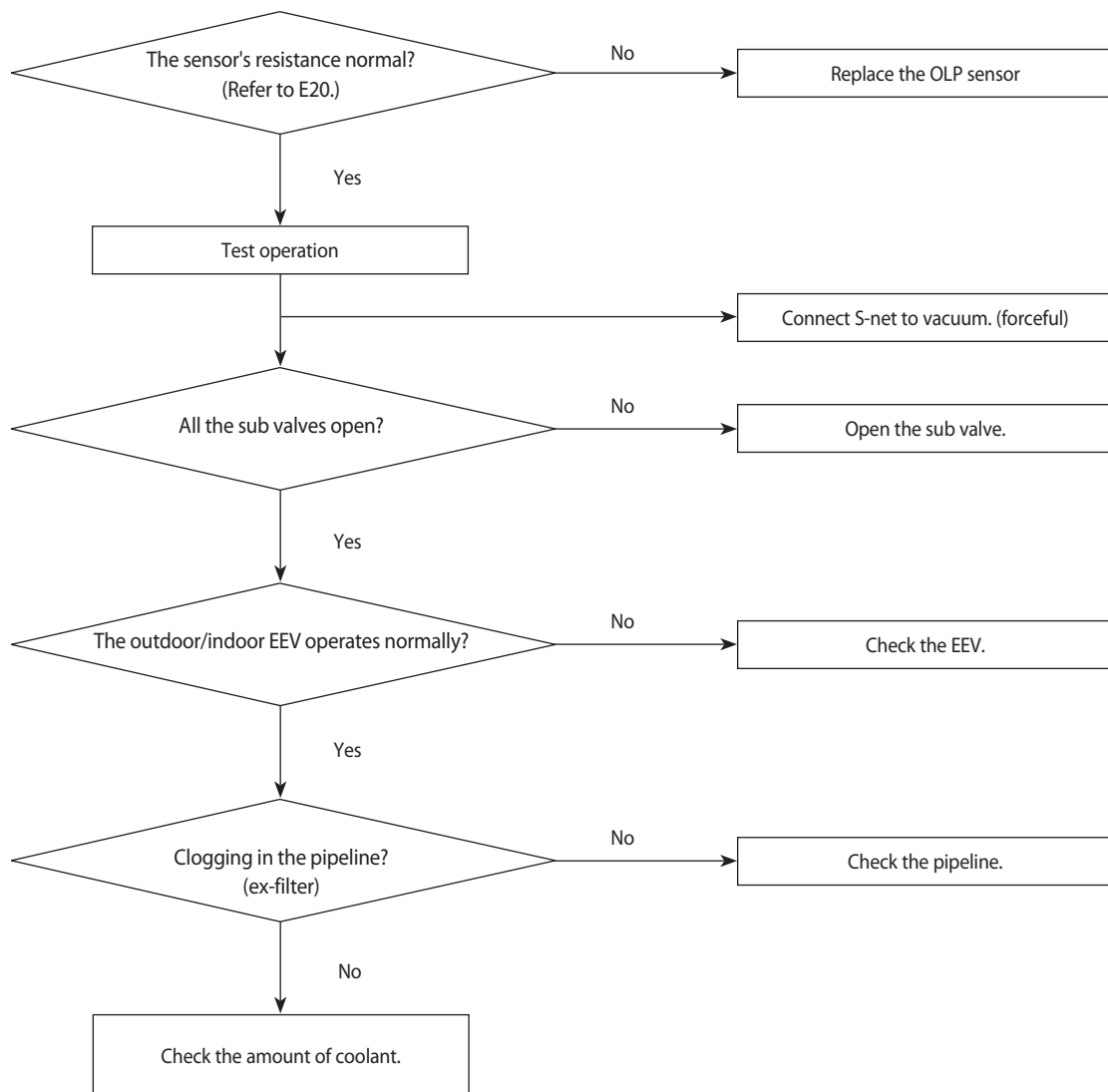

### 4-3-20 E464 : O.C. (Over Current) error

1. Checklist :

- 1) Is the refrigerant charged properly?
- 2) Does the compressor rotate normally?(Reverse rotation, Locking etc.)
- 3) Is connection of compressor wire normal?
- 4) Is compressor motor normal?(Insulation, Coil resistance etc.)
- 5) Does a temporary cycle overload condition happened?

2. Troubleshooting procedure

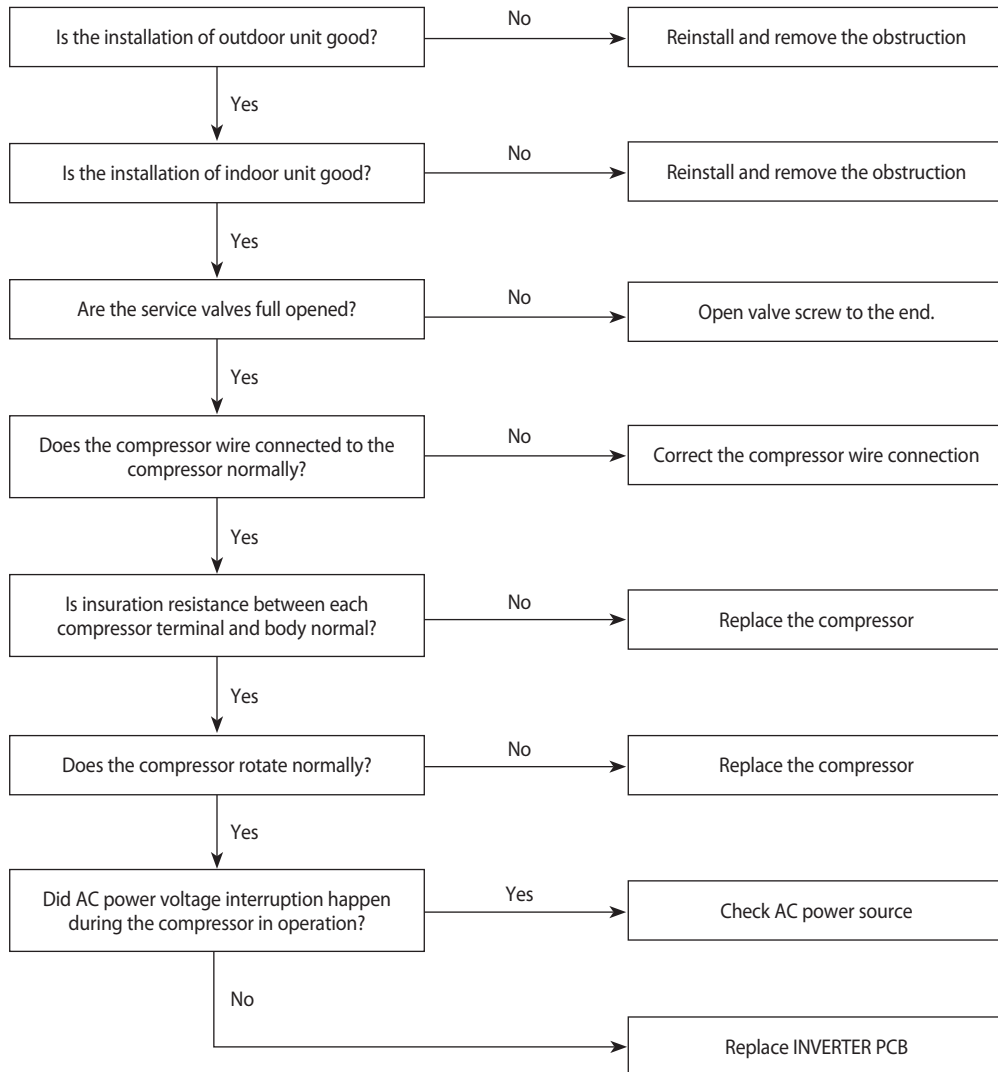

### 4-3-21 E466: DC Link Over voltage/ Low voltage error

1. Checklist :

- 1) Is the power voltage normal?(Lightning, Power interruption etc.)
- 2) Is AC Power cable connection normal?(Detaching the wire)

2. Troubleshooting procedure

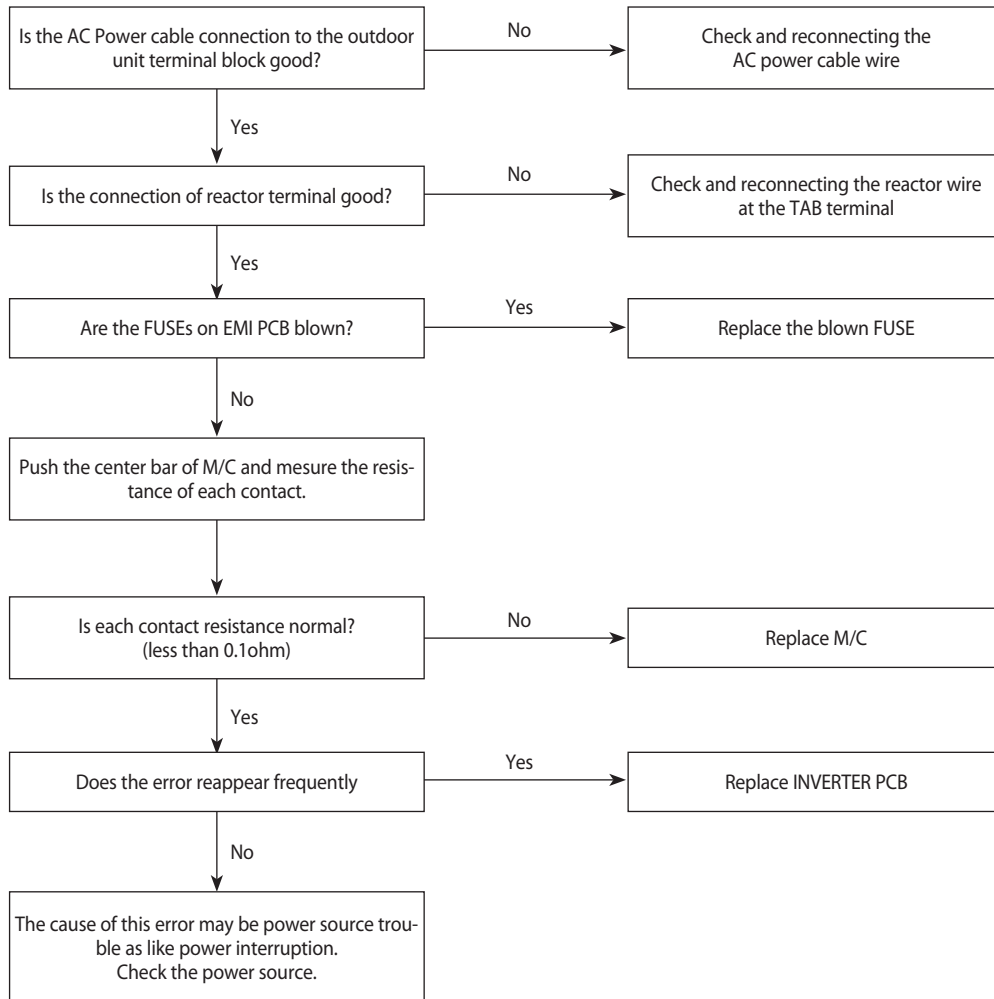

### 4-3-22 Pipe Blocking Error (Error Code: E422)

#### 1. Test Item

- 1) Check the open state of the outdoor unit service valve.
- 2) Check the connection of the pipe.
- 3) Check the operation of the EEV.
- 4) Check the refrigerant leakage.
- 5) Check the connection of the indoor unit PBA EVA sensor.
- 6) Check the fault in the indoor unit EVA sensor.

#### 2. Check procedure

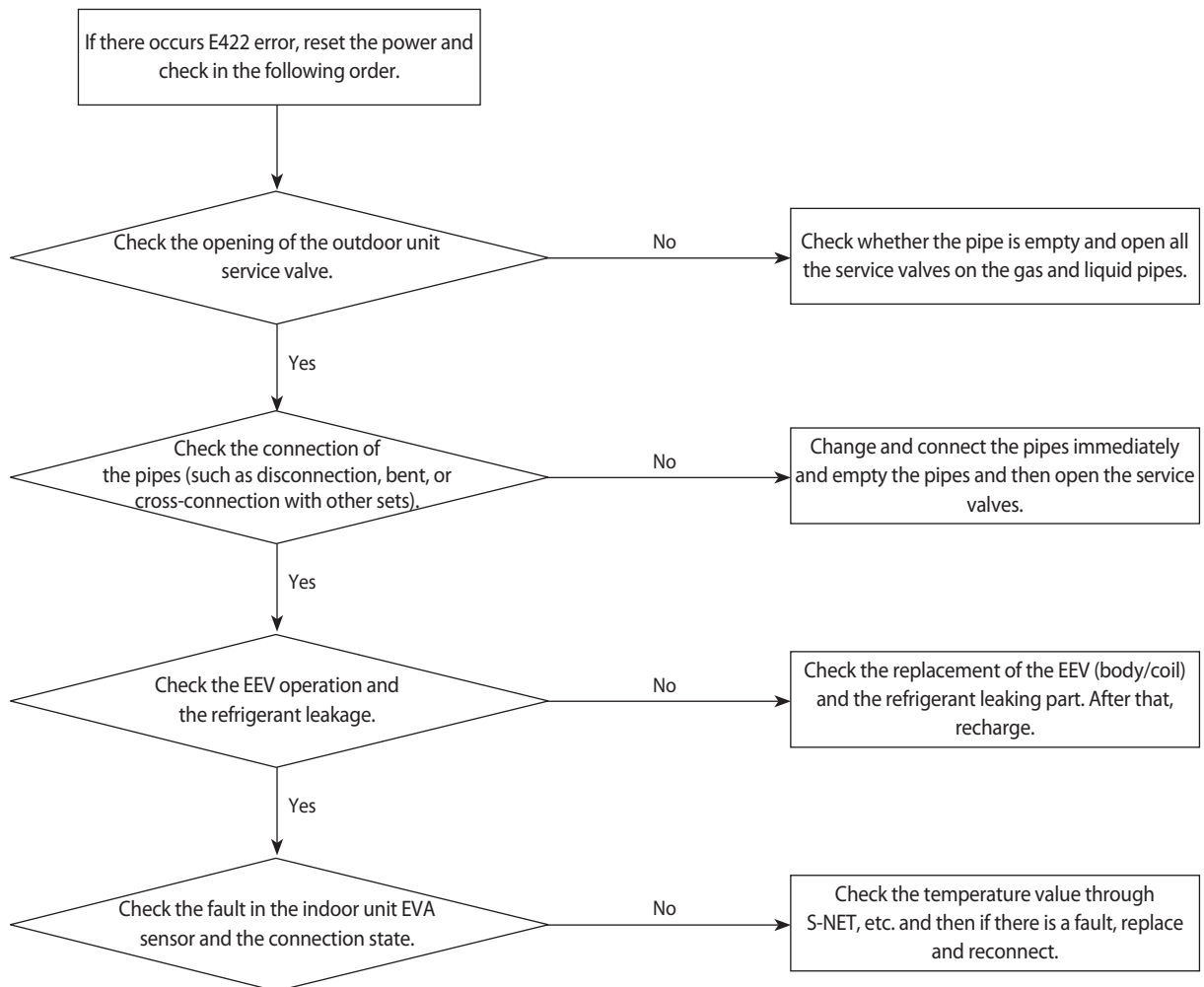

## 4-3-23 The others

### 1. E465 : Compressor over load error

- If a compressor works improperly, change the compressor and check if it works properly.
- If a compressor is normal, check the assembly between Heatsink-Inverter PBA. If it is fine, change Inverter PBA.

### 2. E468 : Current sensor error

- Check EEPROM data.
- Check PCB operates properly.

### 3. E471 : Outdoor EEPROM error

- Upload EEPROM on Outdoor unit Main PBA.

### 4. E474 : IPM(IGBT Module) or PFCM Temperature sensor Error

- E500 : IPM is over heated
- Check IPM is well assembled to heatsink
- Check whether inlet port is clogged.
- Change IPM if it is defective one

### 5. E554 : Gas leak error

- Check refrigerant charge
- Check Indoor EVA sensor
- Check Service valve is open.
- Check the pipes and wires correctly connected.

### 6. E556 : Capacity miss match between indoor and outdoor

- Check the model name of indoor and outdoor unit and set option code on indoor unit again.

### 7. Outdoor overload protection control (at the stop of the compressor) : E404

- Check whether the fan and the motor operate normally.
- Check the operation of EEV.
- Check the temperature sensor of the indoor unit heat Exchanger.
- Check the indoor unit inlet blocking.



## 4-4 Setting Option Setup Method

### ■ Setting Option Setup Method

In order to set the indoor unit option code use the wired remote controller and follow the directions below.

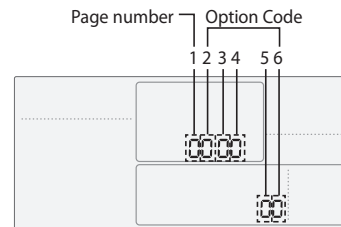
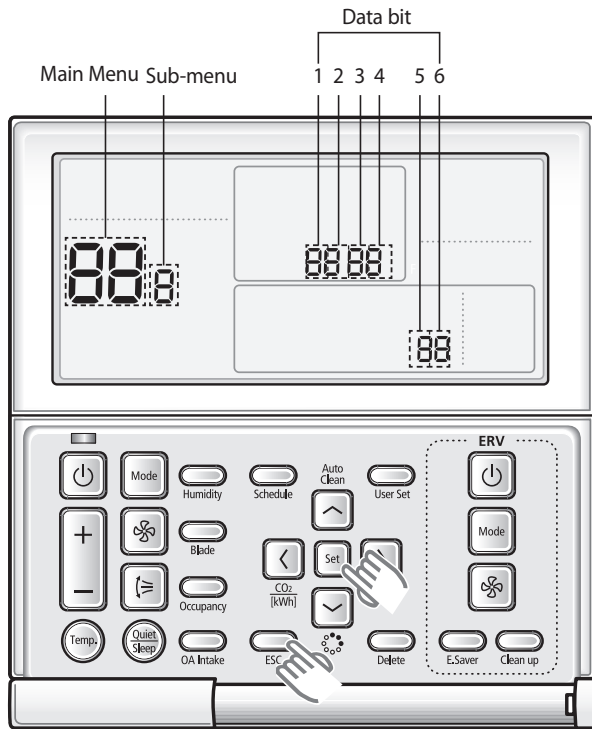

SEG1	SEG2	SEG3	SEG4	SEG5	SEG6
0	*	*	*	*	*

Page number

SEG7	SEG8	SEG9	SEG10	SEG11	SEG12
1	*	*	*	*	*

Page number

SEG13	SEG14	SEG15	SEG16	SEG17	SEG18
2	*	*	*	*	*

Page number

SEG19	SEG20	SEG21	SEG22	SEG23	SEG24
3	*	*	*	*	*

Page number

- 1) Press the **Set** and **ESC** buttons at the same time for more than 3 seconds and then a Main menu will be displayed.
- 2) Press the **▲/▼** button to select **4** and then press **▶** button to enter a Sub-menu setting screen.
- 3) Press the **▲/▼** button to select **2** and then press **▶** button to enter a Indoor unit option code setting screen.



NOTE

- The first digit represents the page number and the remaining five digits are option codes.
- The option code which is currently setting will flicker.

- 4) Press the **▲/▼** button to set the option code in order. Press **▶** button to go to the next page.
- 5) Press the **Set** button to save and complete the option setting.
- 6) Press the **ESC** button to exit to normal mode.



NOTE

- Press the **ESC** button anytime during setup to exit without setting.



CAUTION

- Option code will not be applied if you don't press the **Set**
- Setting indoor unit option code is only possible in Master wired remote controller. You can only check the indoor unit option code in Slave wired remote controller.
- Setting indoor unit option code is possible when one indoor unit is connected. If more than 2 indoor units are connected, you can only check the Master indoor unit option code.

# Setting an indoor unit address and installation option

Set the indoor unit address and installation option with remote controller option. Set the each option separately since you cannot set the ADDRESS setting and indoor unit installation setting option at the same time. You need to set twice when setting indoor unit address and installation option.

## Setting an indoor unit address

- 1) Press the **Set** and **ESC** buttons at the same time for more than 3 seconds and then a Main menu will be displayed.
- 2) Press the **↑**/**↓** button to select **4** and then press **→** button to enter a Sub-menu setting screen.
- 3) Press the **↑**/**↓** button to select **1** and then press **→** button to enter a Indoor Address setting screen.

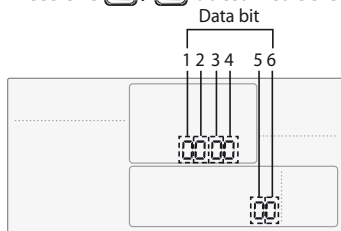

NOTE

- The Main/RMC Address which is currently setting will flicker.
- Data bit 1 and 2 present Indoor unit main address checking
- Data bit 3 and 4 present Indoor unit main address setting(outdoor unit reset is needed to set).
- Data bit 5 and 6 present Indoor unit RMC address setting/checking.

- 4) Press the **↑**/**↓** button to set the Indoor unit Main/RMC Address.
- 5) Press the **Set** button to save and complete the option setting.
- 6) Press the **ESC** button to exit to normal mode.









NOTE

- Press the **ESC** button anytime during setup to exit without setting.
- Address will not be applied if you don't press **Set** button.
- Setting Main/RMC Address of an Indoor unit is available only with a master wired remote controller.

## Setting an indoor unit installation option



In order to check and set the indoor unit installation option code use the wired remote controller and follow the directions below.

- 1) Press the  and  buttons at the same time for more than 3 seconds and then a Main menu will be displayed.
- 2) Press the  button to select **4** and then press  button to enter a Sub-menu setting screen.
- 3) Press the  button to select **3** and then press  button to enter a Indoor unit installation option code setting screen.



NOTE

- The first digit represents the page number and the remaining five digits are installation option.
- The total option codes are 24 digits. You can set six digits at a time and it is distinguished by page number (0, 1, 2, 3).

- 4) Press the  button to set the installation option code in order. Press  button to go to the next page.

SEG1	SEG2	SEG3	SEG4	SEG5	SEG6
0	2	RESERVED	Exterior temperature sensor	Central control	RESERVED
SEG7	SEG8	SEG9	SEG10	SEG11	SEG12
1	Drain pump	Use of Hot Coil	RESERVED	RESERVED	RESERVED
SEG13	SEG14	SEG15	SEG16	SEG17	SEG18
2	External control	External control output	S-Plasma ion	Buzzer	Number of hours using filter
SEG19	SEG20	SEG21	SEG22	SEG23	-
3	Individual control of a remote controller	Heating setting compensation	RESERVED	RESERVED	-



Option No. : 02XXXX-1XXXXX-2XXXXX-3XXXXX

Option	SEG1		SEG2		SEG3		SEG4		SEG5		SEG6	
Explanation	PAGE		MODE		RESERVED		Use of external temperature sensor		Use of central control		RESERVED	
Indication and Details	Indication	Details	Indication	Details			Indication	Details	Indication	Details		
	0		2				0	Disuse	0	Disuse		
					1	Use	1	Use				
Option	SEG7		SEG8		SEG9		SEG10		SEG11		SEG12	
Explanation	PAGE		Use of drain pump		RESERVED		RESERVED		RESERVED		RESERVED	
Indication and Details	Indication	Details	Indication	Details								
	1		0	Disuse								
			1	Use								
			2	Use + 3minute delay								
Option	SEG13		SEG14		SEG15		SEG16		SEG17		SEG18	
Explanation	PAGE		Use of external control		Setting the output of external control		Virus doctor		Buzzer control		Number of hours using filter	
Indication and Details	Indication	Details	Indication	Details	Indication	Details	Indication	Details	Indication	Details	Indication	Details
	2		0	Disuse	0	Thermo on	0	Disuse	0	Use of buzzer	2	1000 Hour
			1	ON/OFF Control	1	Operation on	1	Use	1	Non use of buzzer	6	2000 Hour
2			OFF Control									
Option	SEG19		SEG20		SEG21		-		-		-	
Explanation	PAGE		control of a remote controller		Heating setting compensation		-		-		-	
Indication and Details	Indication	Details	Indication	Details	Indication	Details	-		-		-	
	3		0 or 1	Indoor 1	0	Disuse	-		-		-	
			2	Indoor 2	1	2°C						
			3	Indoor 3	2	5°C						
4			Indoor 4									

5. Press the  button to save and complete the option setting.

6. Press the  button to exit to normal mode.

 NOTE

- Press  button anytime during setup to exit without setting.
- Option code will not be applied if you don't press  button.
- Setting Installation option code is available only with a master wired remote controller.
- Setting Installation option code is available when there is one on one connection between a wired remote controller and an indoor unit.

# Adjusting air flow

## Automatic Air-Volume

**When DPM is installed, Automatic Air-Volume function cannot be performed simultaneously for all indoor units. Automatic Air-Volume function must be performed for each indoor unit with the wired remote control attached. With its BLDC motor, you can use smart adjust the indoor unit fan speed depending on the installation condition. If the external static pressure is high so that the duct becomes longer or if the external static pressure is low so that the duct becomes shorter, Using the Automatic Air-Volume function, the volume of exhaust air has been adjusted to the rated volume flow rate automatically.**

### Performing the Automatic Air-Volume function.

- Check the air conditioning unit stop.

Press the Power button to stop the air conditioner

- Go to Service setting mode with remote controller.

### Performing the Automatic Air-Volume function.

- Check the air conditioning unit stop.

Press the Power button to stop the air conditioner

- Go to Service setting mode with remote controller.

- 1). Press the **Set** and **ESC** buttons at the same time for more than 3 seconds and then a Main menu will be displayed.
- 2). Press the **▲/▼** button to select **8** and then press **▶** button to enter a Sub-menu setting screen.
- 3). Press the **▲/▼** button to select **2** and then press **▶** button to enter a automatic air-volume setting screen.
- 4). Press the **▲/▼** button to select 1 to enable automatic air-volume operation.
- 5). Select mode No. 8.2, and set to "1".

- 6). Press the **Set** button, then the air conditioning unit will start the fan operation for Automatic Air-Volume adjustment.

\* Do not adjust the dampers during fan operation for Automatic Air-Volume adjustment.

- 7). Press **ESC** button to escape setting mode.

(During the automatic air-volume adjustment, [Main Menu] will be displayed **8** → **2** → **1** → **1** (repetitively))

- 8). After 1 to 8 minutes, the air conditioning unit stops operating automatically when Automatic Air-Volume adjustment has been carried out (fan operation icon will be off.)

- 9). When the air conditioning unit has stopped, check the Mode No. 8.1 is "1" for completion of Automatic Air-Volume.

If the Mode No. 8.1 is "0", Automatic Air-Volume adjustment is fail. Then adjust the fan speed by referring the E. S. P (External Static Pressure) setting table.

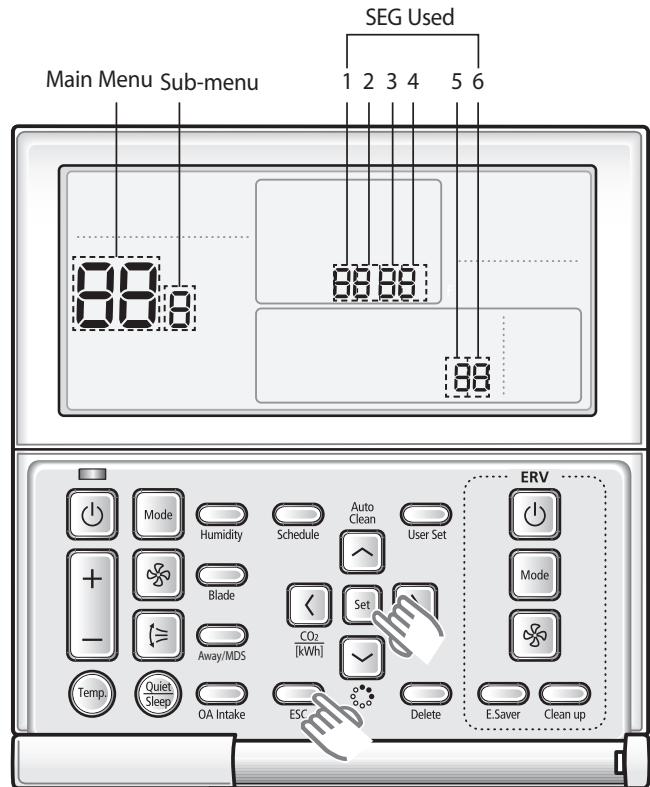

Main menu	Sub menu	Functions	SEG used	Default	Range
8	1	Automatic Air-Volume State Return	1	0	0 - OFF (Fail or Disable) 1 - Completion. 2 - Running Automatic Air-Volume.
	2	Automatic Air-Volume Operation	1	0	0 - Disable 1 - Enable
	3	Automatic Air-Volume Voltage Setting	1	-	-



- If the coil is not dry, run the unit for 2 hours with fan only to dry the coil.
- The air filter is properly attached into the air passage on the air suction side of the air conditioning unit.
- Adjust the dampers so that each air inlet and outlet exhusts the designed airflow rate.
- If using booster fans(an outdoor air processing unit or ERV via duct), do not use Automatic Air-Volume function.
- If the duct configurations have been changed, automatic air-volume function perform again.
- The product can be used within the range of rated voltage 220 V/230 V/240 V ± 5 V. If the product needs to be installed in the condition that is out of the rated voltage stated above, additional setting with installation option is required.

### E. S. P(External Static Pressure) setting for phase control motor

*With its phase control motor, you can adjust the indoor unit fan speed depending on the installation condition. If the external static pressure is high so that the duct becomes longer or if the external static pressure is low so that the duct becomes shorter, adjust the fan speed by referring the following table.*

Model	AC200KNHPKH	AC250KNHPKH
Static Pressure(mmAq)	Option code for indoor unit	
5≤ESP<7.5	011074-1C50C0-27C8E6-372000	011074-1C50F0-270014-373800
7.5≤ESP<10	011074-1C50E3-27C8E6-372000	011074-1C50F3-270014-373800
10≤ESP<12.5	011074-1C50F5-27C8E6-372000	011074-1C5435-270014-373800
12.5≤ESP<15	011074-1C5436-27C8E6-372000	011074-1C5466-270014-373800
15≤ESP<17.5	011074-1C5458-27C8E6-372000	011074-1C5487-270014-373800
17.5≤ESP≤20	011074-1C548E-27C8E6-372000	011074-1C54BB-270014-373800



- represents E. S. P(External Static Pressure) range of factory setting. You don't have to adjust the fan speed separately if the external static pressure of the installation place is in . When it is out of , input the appropriate option code.
- If you input the inappropriate option code, error may occur or the air conditioner is out of order. The option code must be inputted correctly by the installation specialist or service agent.

# Easy Tuning

## EASY Tuning

If the more cooling and heating airflow rate which set up when installing is wanted, or if the more Silent operation which sets up when installing is wanted, air conditioner is tuned for comfort.

Indoor unit airflow rate for high, mid, low mode increases or decreases for +2 ~ -2 Steps with wired remotecon.

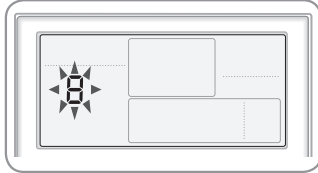

### 1. Press the User Set button.

▶ (Main Menu) will be displayed, and you can press the [▲]/[▼] buttons to select No. 8, which will set the Easy Tuning.

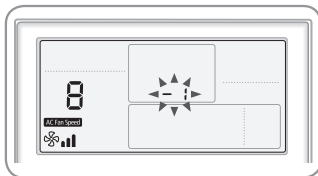

### 2. Press the [>] button to select airflow step.

▶ Press the [▲]/[▼] buttons to select airflow step(-2,-1,0,1,2) tuning (During the Easy Tuning setting, AC Fan Speed icon will be displayed)

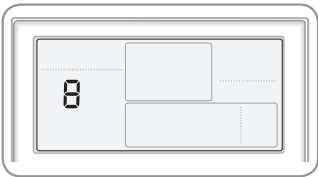

### 3) Press the [Set] button to complete the Easy Tuning.

(When the Easy Tuning setting complete, AC Fan Speed icon will be off)

### 4) Press the [ESC] button to to exit to normal mode.

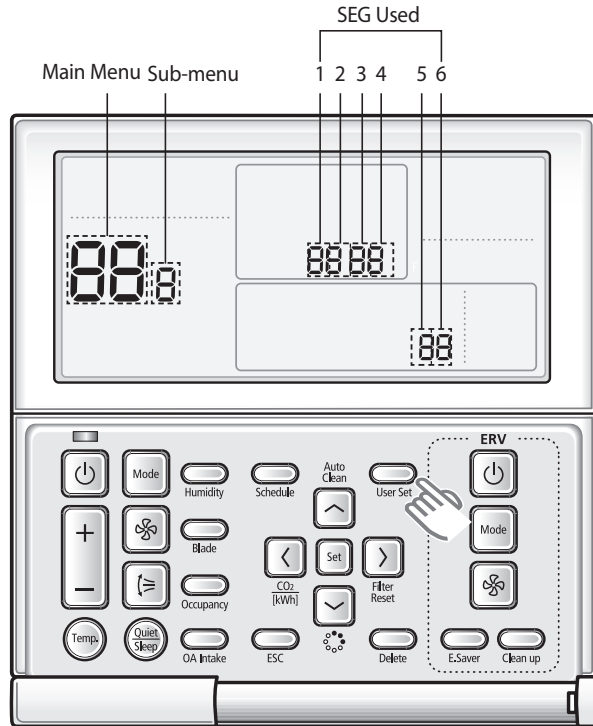

Main menu	Sub menu	Functions	SEG used	Default	Range
8	-	Easy Tuning	1,2	0	-2 : -2 Step -1 : -1 Step 0 : No Use 1 : +1 Step 2 : +2 Step



- Press the [ESC] button anytime during setup to exit without setting.
- According to airflow changed from the Easy Tuning, Air conditioning performance reducing is possible.

## 4-5 Items to be checked first

1. The input voltage should be rating voltage  $\pm 10\%$  range.  
The air conditioner may not operate properly if the voltage is out of this range.
2. Is the link cable linking the indoor unit and the outdoor unit linked properly?  
The indoor unit and the outdoor unit shall be linked by 4 cables.  
Check the terminals if the indoor unit and outdoor unit are properly linked by the same number of cables.  
Otherwise the air conditioner may not operate properly.
3. When a problem occurs due to the contents illustrated in the table below it is a symptom not related to the malfunction of the air conditioner.

No	Operation of air conditioner	Explanation
1	In a COOL operation mode, the compressor does not operate at a room temperature higher than the setting temperature that the INDOOR FAN should operate. [In case of heat pump model] In a HEAT operation mode, the compressor does not operate at a room temperature lower than the setting temperature that indoor fan should operate.	In happens after a delay of 3 minutes when the compressor is reoperated. The same phenomenon occurs when a power is on. As a phenomenon that the compressor is reoperated after a delay of 3 minutes, the indoor fan is adjusted automatically with reference to a temperature of the air blew.
2	Compressor stops operation intermittently in DRY(☼) mode.	Compressor operation is controlled automatically in DRY mode depending on the room temperature and humidity.
3	[In case of heat pump model] Compressor of the outdoor unit is operating although it is turned off in a HEAT mode.	When the unit is turned off while de-ice is activated, the compressor continues operation for up to 12 minutes(maximum) until the deice is completed.
4	[In case of heat pump model] The compressor and indoor fan stop intermittently in HEAT mode.	The compressor and indoor fan stop intermittently if room temperature exceeds a setting temperature in order to protect the compressor from overheated air in a HEAT mode.
5	[In case of heat pump model] Indoor fan and outdoor fan stop operation intermittently in a HEAT mode.	The compressor operates in a reverse cycle to remove exterior ice in a HEAT mode, and indoor fan and outdoor fan do not operate intermittently for within 20% of the total heater operation



## 5. PCB Diagram and Part List

### 5-1 INDOOR UNIT

#### MAIN PBA

#### AC200KNHPKH / AC250KNHPKH

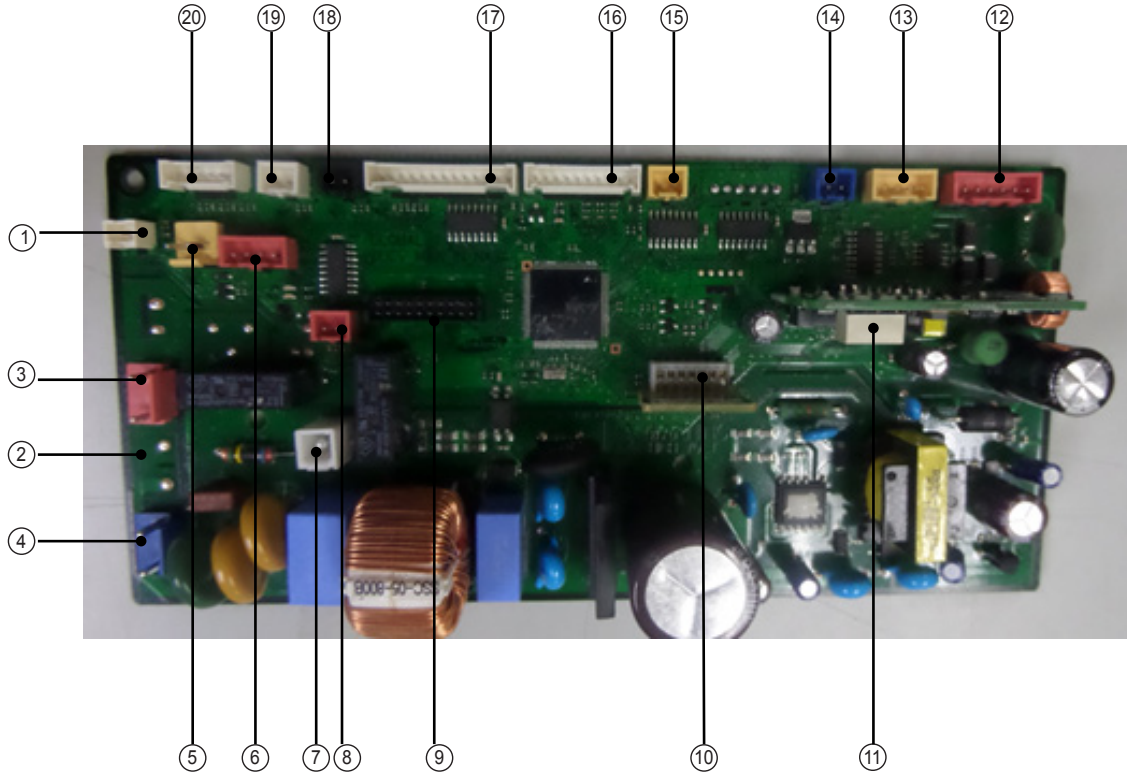

No	Part Code	Local	Function	Description
1	3711-003942	CN140	Fuse Check	SMW200-02P WHT
2	3711-000203	CN906	BLDC POWER	YW396-03AV WHT
3	3711-003407	CN702	Comp Signal	YW396-03AV RED
4	3711-003404	CN101	MAIN POWER	YW396-03AV BLU
5	3711-000179	CN701	DRAIN	YW396-02V YEL
6	3711-000939	CN81	COMP ERROR	SMW250-04 RED
7	3711-000744	CN1	EARTH	YDW236-01WHT
8	3711-000796	CN83	EXT-T	SMW250-02 RED
9	3711-002001	CN301	DOWNLOAD	YDW200-20
10	3711-007817	CN201	EPPROM	B7P-MQ WHT
11	3711-004773	CN311	2 WIRE	BMW200-12 WHT
12	3711-001037	CN302	COMM	SMW250-06 RED
13	3711-000941	CN801	SPI	SMW250-04 YEL
14	3711-000795	CN804	VEN	SMW250-02 BLU
15	3711-000798	CN907	UART COMM	UART Port
16	3711-004182	CN905	FAN MOTOR COMM	SMW200-10P WHT
17	3711-003895	CN501	DISPLAY	SMW200-13P WHT
18	3711-000794	CN411	FLOAT-SW	SMW250-02 BLK
19	3711-000015	CN412	ROOM SENSOR	SMW250-02 WHT
20	3711-004236	CN413	EVA DIS/OUT SENSOR	SMW200-06P WHT

**EMI PBA**  
**AC200KNHPKH / AC250KNHPKH**

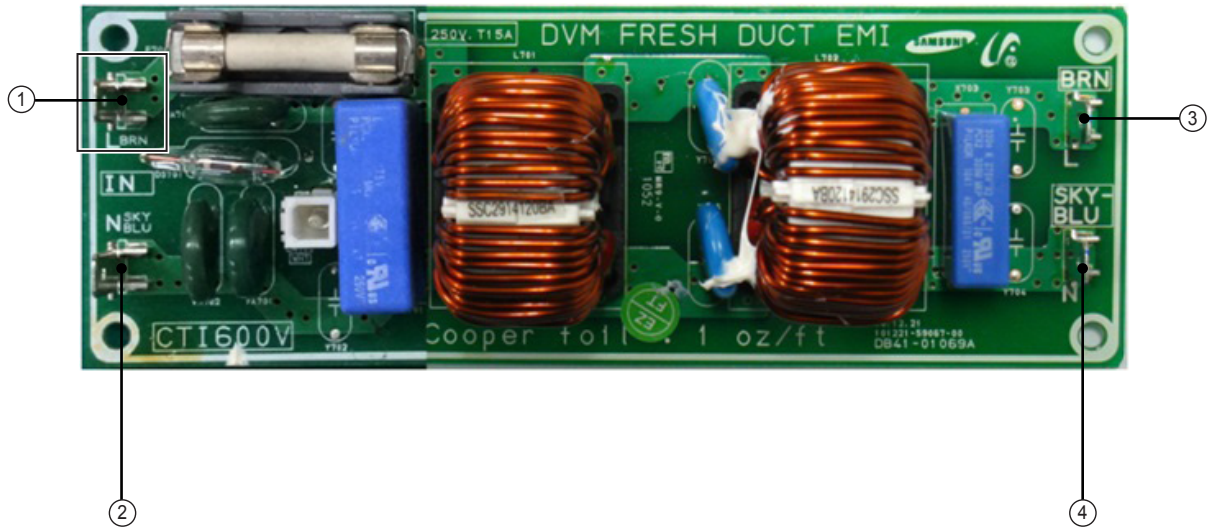

No.	part code	location No.	Function	Description
1	3712-001139	L	IN-L	TAB,MALE,6.35x0.8mm
2	3712-001139	N	IN-N	TAB,MALE,6.35x0.8mm
3	3712-001139	L	OUT-L	TAB,MALE,6.35x0.8mm
4	3712-001139	N	OUT-N	TAB,MALE,6.35x0.8mm

**BLDC PBA**  
**AC200KNHPKH / AC250KNHPKH**

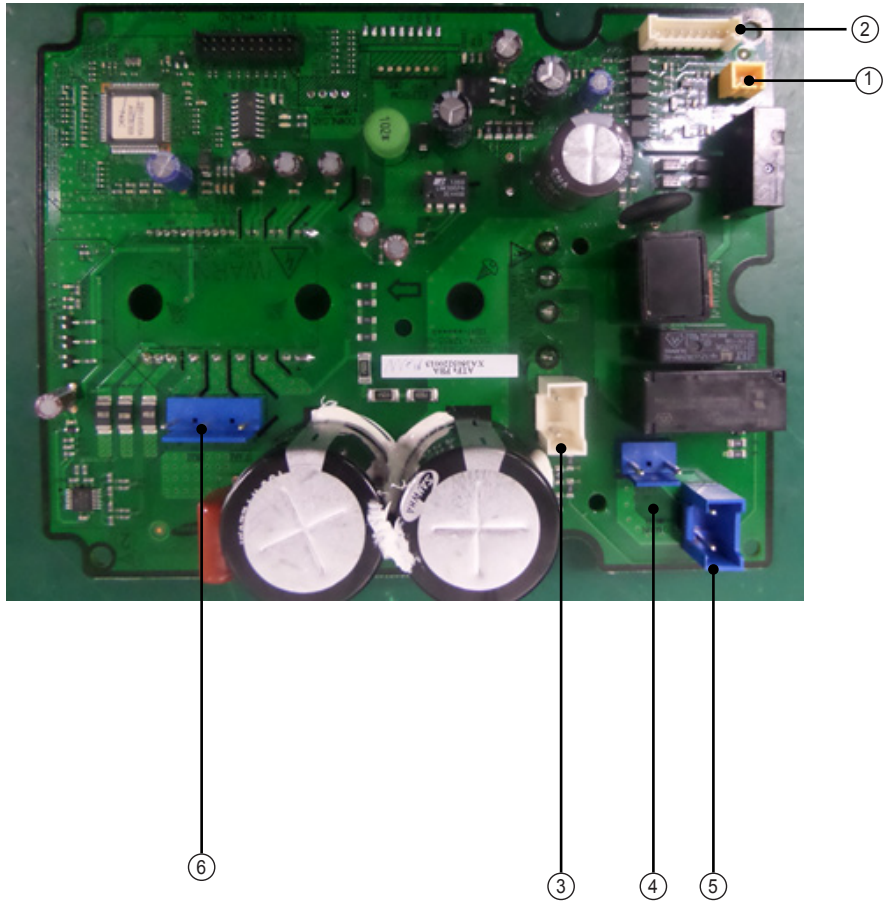

No	Part Code	Local	Description
1	3711-000798	CN12	COMM,UART Port
2	3711-004712	CN11	Main to BLDC signal
3	3711-005852	CN15	Reactor connect
4	3711-003404	CN10	BLDC PBA power
5	3711-006048	CN14	Main PBA power
6	3711-000260	CN13	Motor power

5-2-1MAIN (cont.)

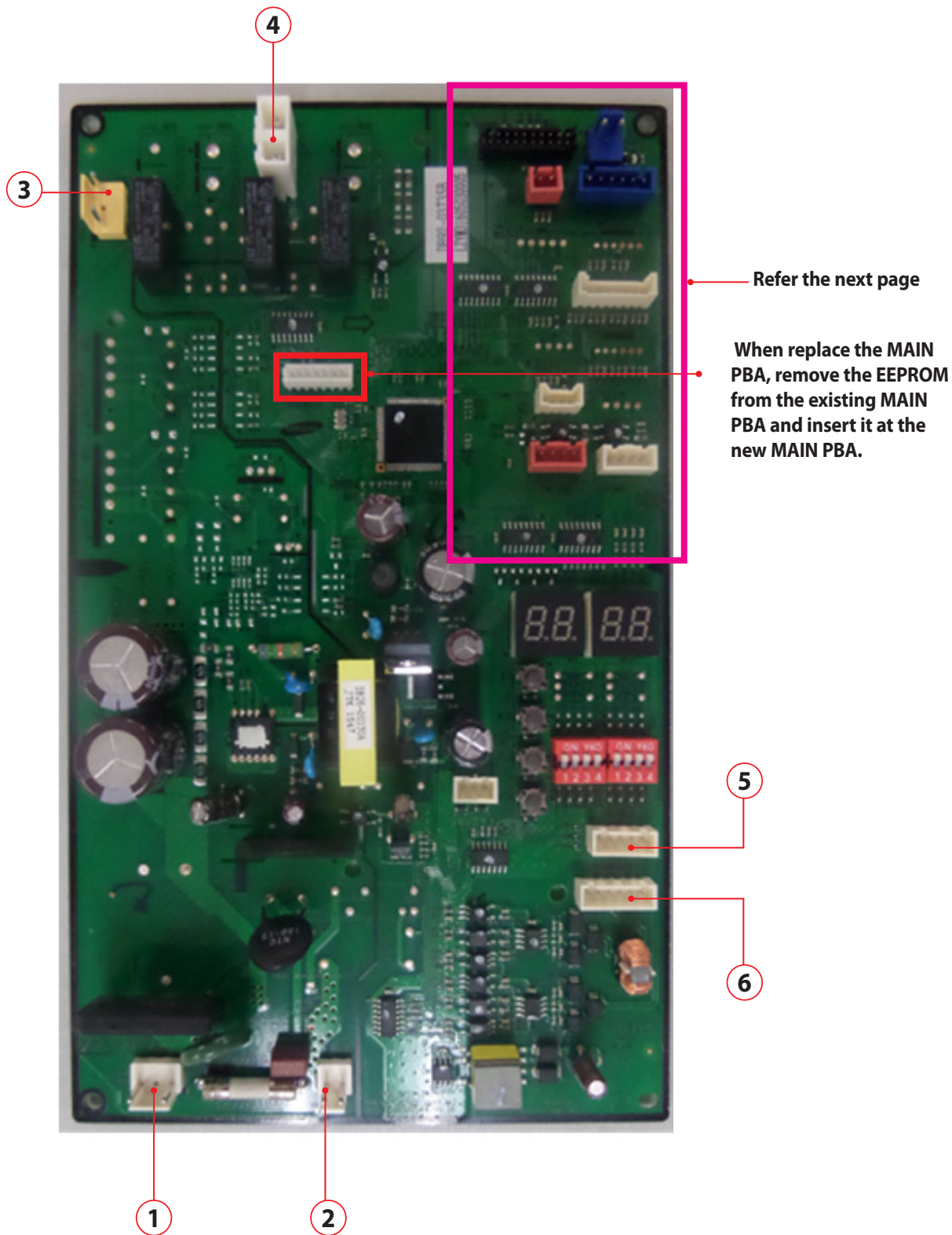

**MAIN (cont.)**

No.	Description	
1	CN70-AC POWER	
	1	LIVE
	2	-
	3	NEUTRAL
2	CN71-HIGH PRESSURE S/W	
	1	S/W
	2	S/W
3	CN708-4WAY VALVE	
	1	Valve
	2	-
	3	NEUTRAL

No.	Description	
4	CN714-CCH 1 OUT	
	1	NEUTRAL
	2	LIVE
5	CN901-DRED	
	1	DRED1
	2	DRED2
	3	DRED3
	4	GND
	5	VCC

No.	Description	
6	CN55-COMM PBA	
	1	F1
	2	F2
	3	OF1
	4	OF2
	5	R1
	6	R2

# MAIN

---

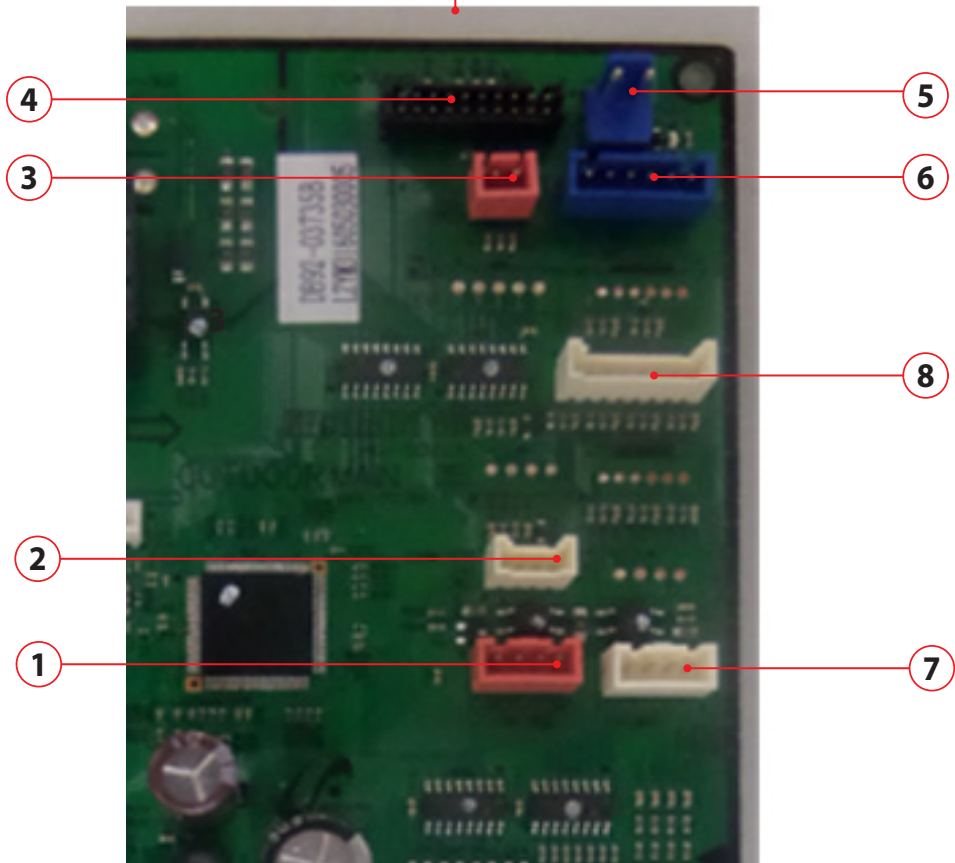
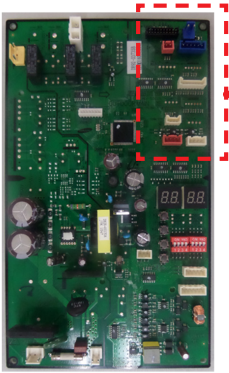



## MAIN (cont.)

No.	Description	
1	CN85-STATUS CHECK	
	1	12V
	2	ERROR CHECK
	3	12V
2	CN92-COMM TEST	
	1	VCC
	2	RXD INVERTER
	3	INV COMM
	4	GND

No.	Description	
3	CN86-EXT-CTL	
	1	EXTERNAL CONTROL SIGNAL
	2	GND

No.	Description	
4	CN23-DOWNLOAD	
	1	RXD IN
	2	TXD IN
	3	nTRST
	4	TDO
	5	TCK
	6	TDI
	7	TMS
	8	TRACE CLK
	9	GND
	10	VCC
	11	VCC
	12	MODE 0
	13	RESET
	14	TRACE 3
	15	F SCLK
	16	F SDAT
	17	GND
	18	TRACE 2
	19	TRACE 1
20	TRACE 0	

No.	Description	
5	CN12-TRANSMITTER DC POWER 12V	
	1	12V
	2	GND
6	CN81-EEV	
	1	EEV1 SIGNAL 1
	2	EEV1 SIGNAL 2
	3	EEV1 SIGNAL 3
	4	EEV1 SIGNAL 4
	5	12V
6	12V	

No.	Description	
7	CN41-LOW PRESSURE SENSOR	
	1	-
	2	LOW PRESS SENSOR
	3	GND
4	VCC	

No.	Description	
8	CN43-TEMP. SENSOR	
	#1 : Comp1 disachrge	
	#2 : comp1 discharge	
	#3 : Comp1 top	
	#4 : Comp1 Top	
	#5 : Cond out	
	#6 : Cond out	
	#7 : Outdoor Temp.	
#8 : Outdoor Temp.		

## 5-2-2 Inverter

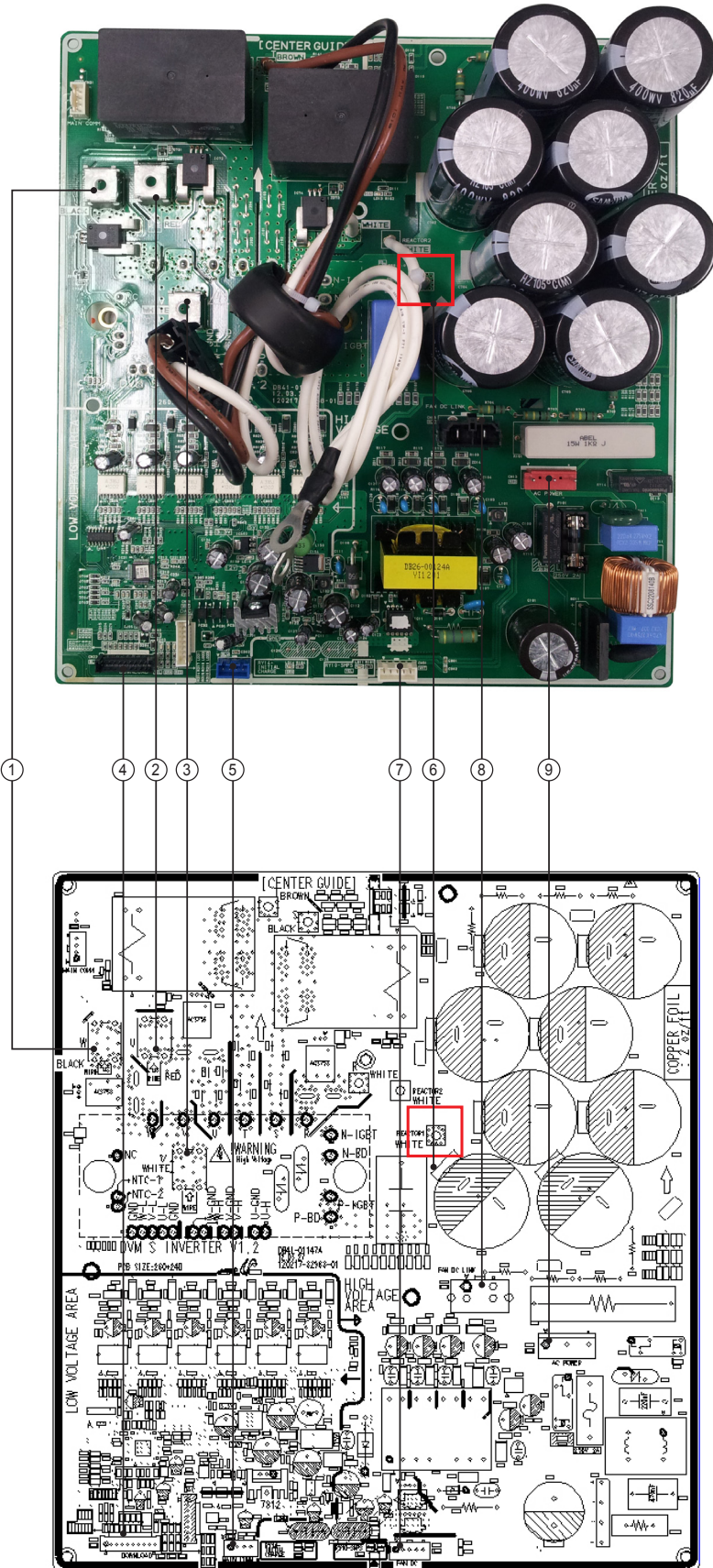



## ASS'Y PCB SUB-DRIVER (cont.)

<p>① <b>W-COMP W</b></p> <p>#1:COMP W</p>	<p>② <b>U-COMP U</b></p> <p>#1:COMP U</p>	<p>③ <b>V-COMP V</b></p> <p>#1:COMP V</p>	<p>④ <b>CN22-DOWNLOAD</b></p> <p>#1:RX-DOWN            #2:TX-DOWN            #3:N-TRST            #4:TDO            #5:TCK            #6:TDI            #7:TMS            #8:            #9:GND            #10:VCC</p>
<p>⑤ <b>CN32 - MAIN COMM</b></p> <p>#1:12V-MAIN            #2:IN-SMPS-RELAY            #3:COMM-IN            #4:GND-MAIN</p>	<p>⑥ <b>REACTOR (WIRE CONNECTION)</b></p> <p>#1:REACTOR            #2:REACTOR</p>	<p>⑦ <b>CN91-FAN DC</b></p> <p>#1:18V            #2:GND            #3:5V-FAN            #4:AD-SELECT</p>	<p>⑧ <b>CN15-FAN DC LINK</b></p> <p>#1:500V            #2:GND(500V)</p>
<p>⑨ <b>CN13-ACPOWER</b></p> <p>#1:AC            #2:            #3:AC</p>			

## 5-2-3 EMI

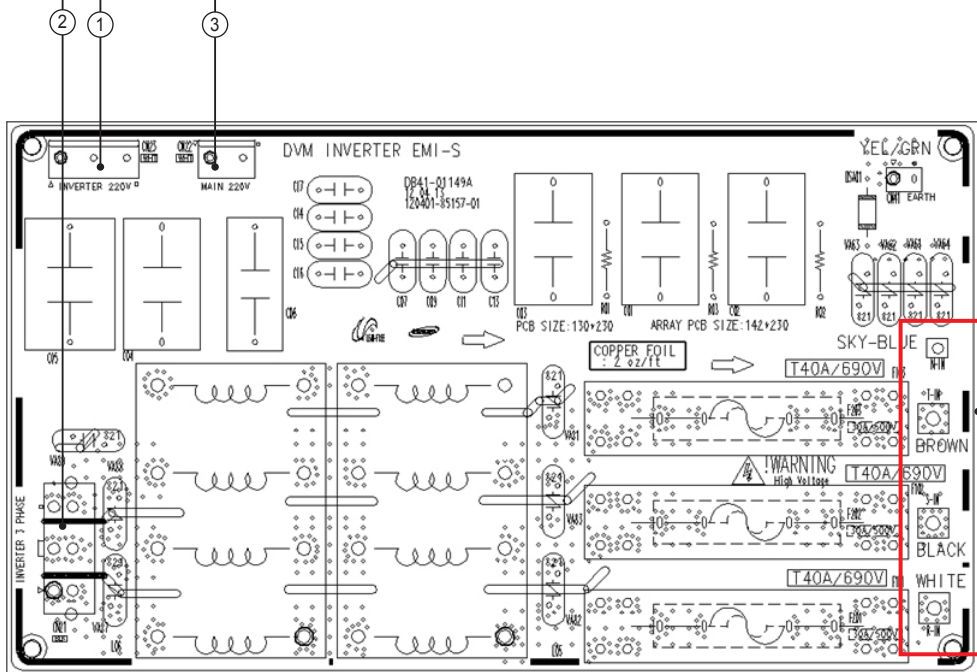
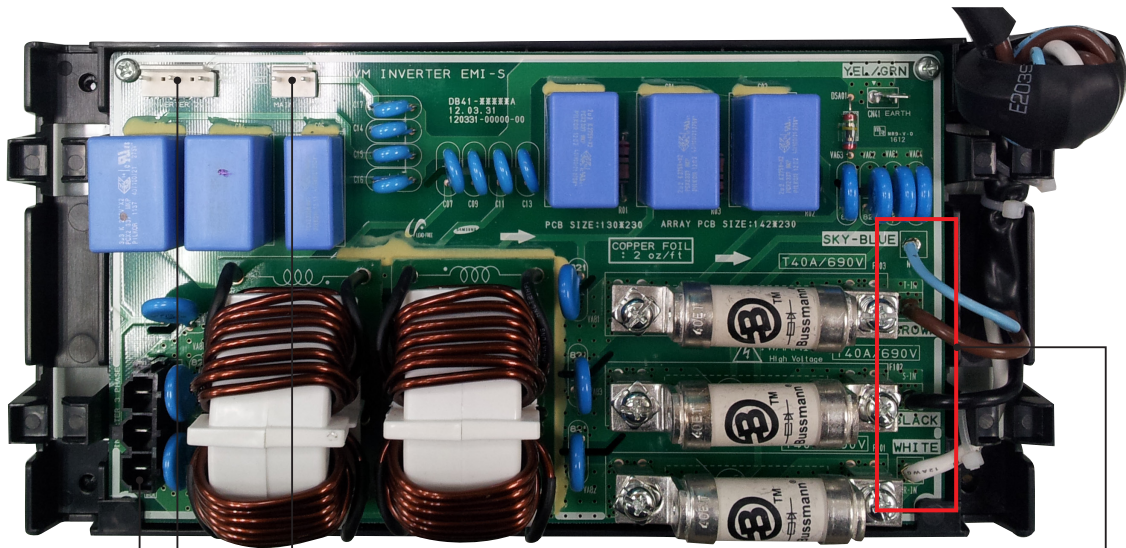

<p>① CN23-INVERTER 220V</p> <p>#1:AC #2: #3:AC</p>	<p>② CN21-FAN A</p> <p>#1:R #2:S #3:T</p>	<p>③ CN22-MAIN 220</p> <p>#1:AC #2:AC</p>	<p>④ RST-RST INPUT</p> <p>T-IN S-IN R-IN</p>
--	---	---	--

## 5-2-4 Fan

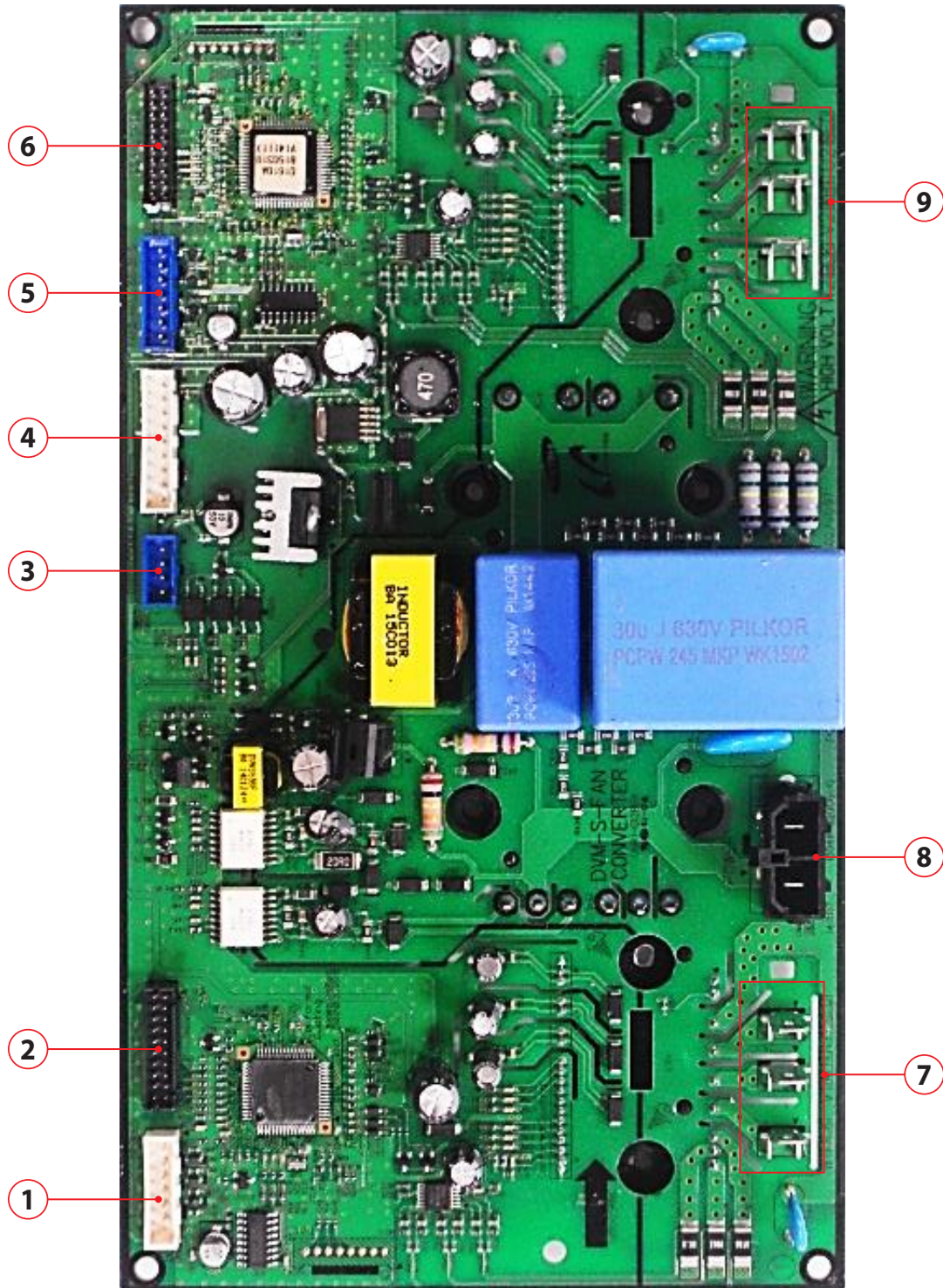

## Fan (cont.)

No.	Description	
1	CN102-FAN1 HALL SENSING	
	1	HALL-U
	2	5 V
	3	HALL-V
	4	GND
	5	HALL-W
	6	MOTOR-TEMP
7	GND	
2	CN202-DOWNLOAD1	
	1	RX-DEBUG
	2	TX-DEBUG
	3	BOOT
	4	TDO
	5	TCK
	6	TDI
	7	TMS
	9	GND
	10	5 V

No.	Description	
3	CN502-COMMUNICATION	
	1	12 V-MAIN
	2	INV SMPS RELAY-MAIN
	3	COMM-MAIN
4	GND-MAIN	
4	CN501-COMMUNICATION	
	1	18 V-INV
	2	GND-MAIN
	4	GND-MAIN
	6	12 V-INV
	7	INV SMPS RELAY-INV
	8	COMM-INV
	9	GND-INV
	5	CN101-FAN2 HALL SENSING
1		HALL - U
2		5 V
3		HALL - V
4		GND
5		HALL - W
6		MOTOR - TEMP
7	GND	

No.	Description	
6	CN301-DOWNLOAD2	
	1	RX-DEBUG
	2	TX-DEBUG
	3	BOOT
	4	TDO
	5	TCK
	6	TDI
	7	TMS
	9	GND
	10	5 V
7	U1-V1-W1	
	1	FAN1-U
	2	FAN1-V
3	FAN1-W	
8	CN401-POWER	
	1	DC 540 V
2	GND	
9	U2-V2-W2	
	1	FAN2-U
	2	FAN2-V
3	FAN2-W	



## 5-2-5 Communication

---

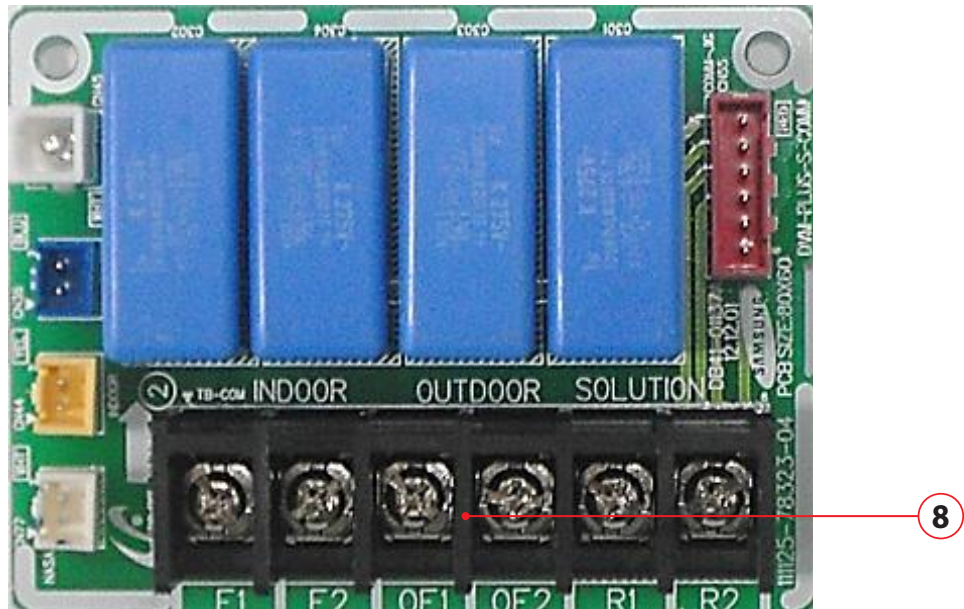

No.	Description
1	TB-COMM
1	F1
2	F2
3	OF1
4	OF2
5	R1
6	R2

# 6. Wiring Diagram

## 6-1 Indoor Unit

### AC200KNHPKH / AC250KNHPKH

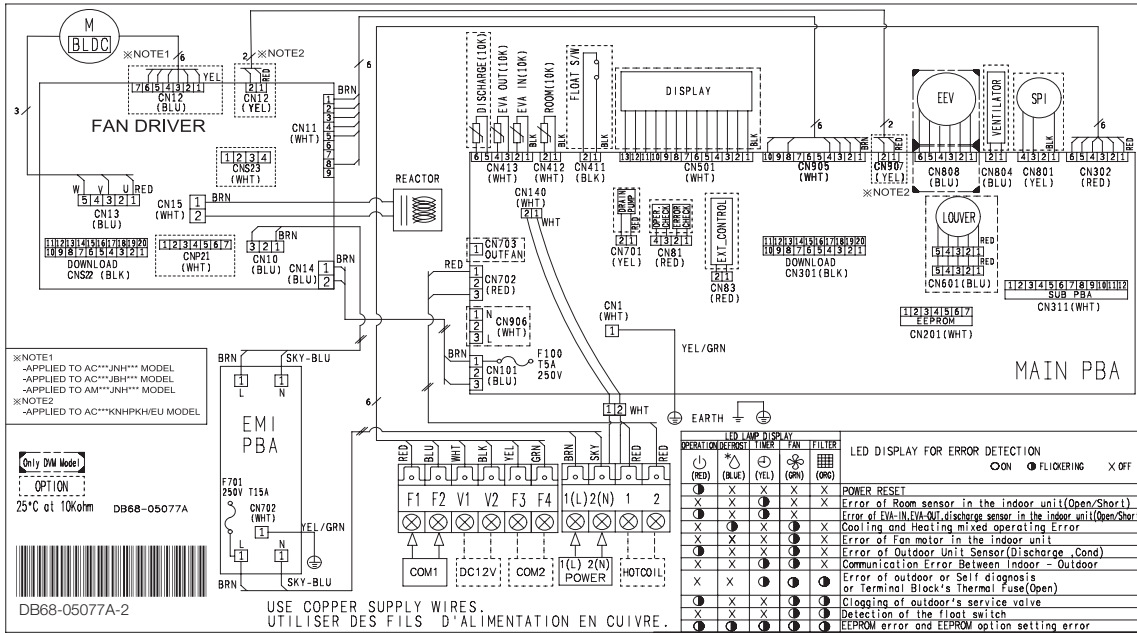

This Document can not be used without Samsung's authorization.

# 6-2 Outdoor Unit

## AC200KXAPHN / AC250KXAPHN

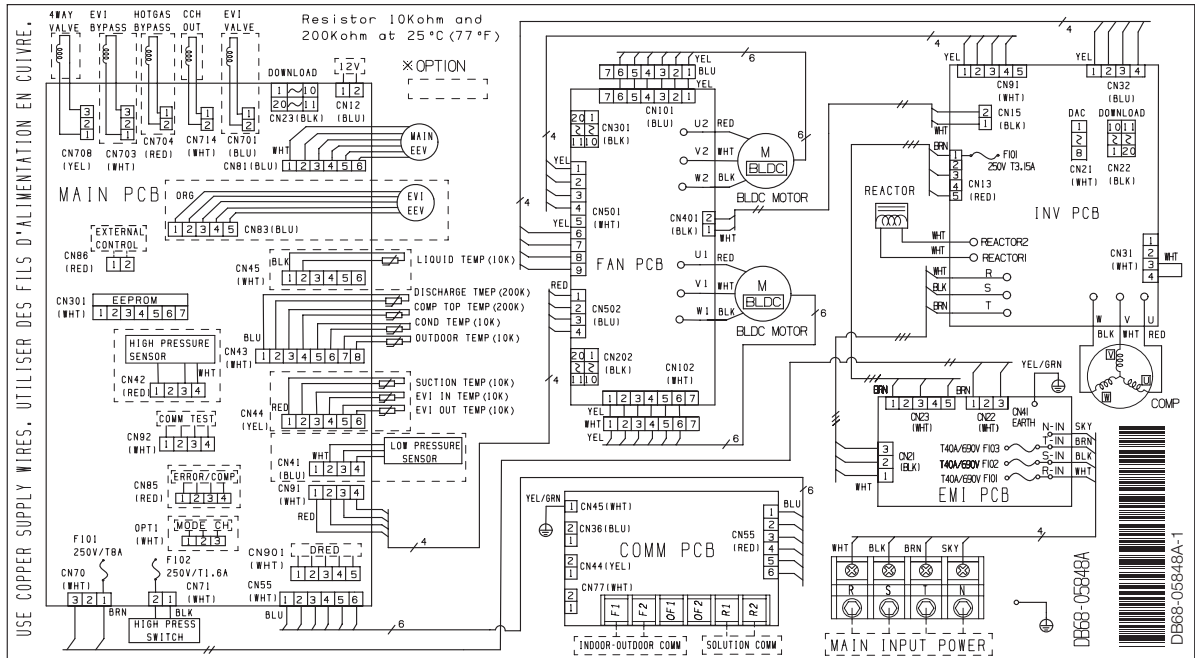

This Document can not be used without Samsung's authorization.

## 7. Reference Sheet

### 7-1 Refrigerating Cycle Diagram

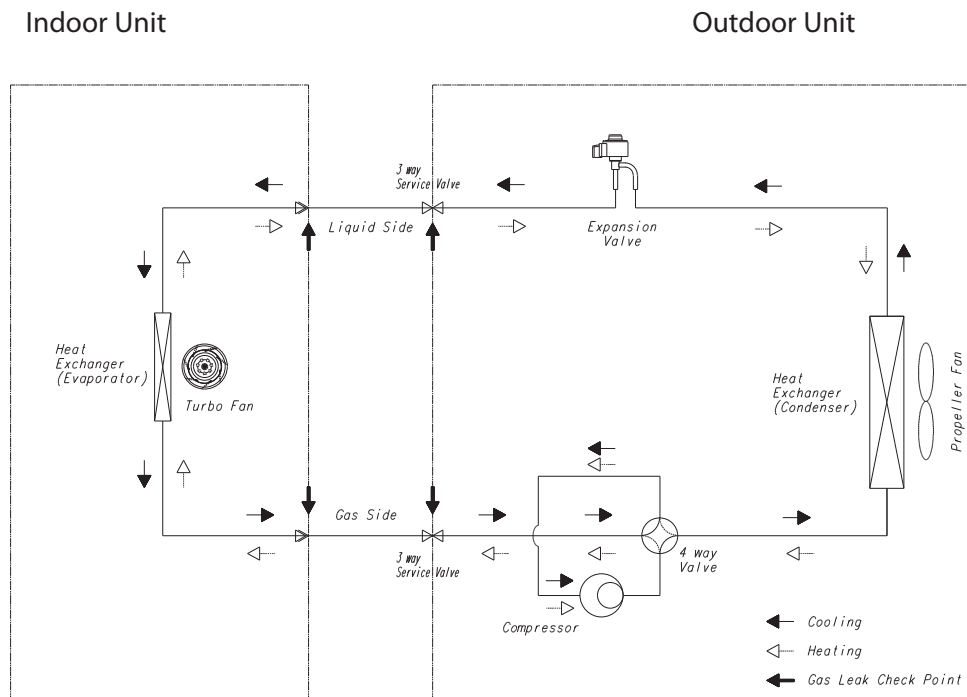

#### ■ CONDENSER

High temperature and high pressure gas state coolant discharged from the compressor is converted to a liquid state as it is cooled down by the heat emission in the outdoor condenser unit, and sent to the evaporator.

#### ■ COMPRESSOR

Low temperature and low pressure coolant is compressed and sent to the cycling system.

#### ■ EVAPORATOR

Liquid coolant sucked in through the capillary tubes cools down the room by absorbing the surrounding heat as it evaporates (converting from liquid to gas). (Absorbing heat required for evaporation)

#### ■ SERVICE VALVE

You can open the valve by turning the need valve counterclockwise using hex wrench, and it is used for vacuum, gas purging, coolant injection, coolant purging, and indoor-outdoor unit connection.

#### ■ ACCUMULATOR

Accumulator prevents the flow of liquid-state coolant into the compressor. (Liquid-state coolant flowing into the compressor will overload the compressor.)



# 7-2 Index of Model Name

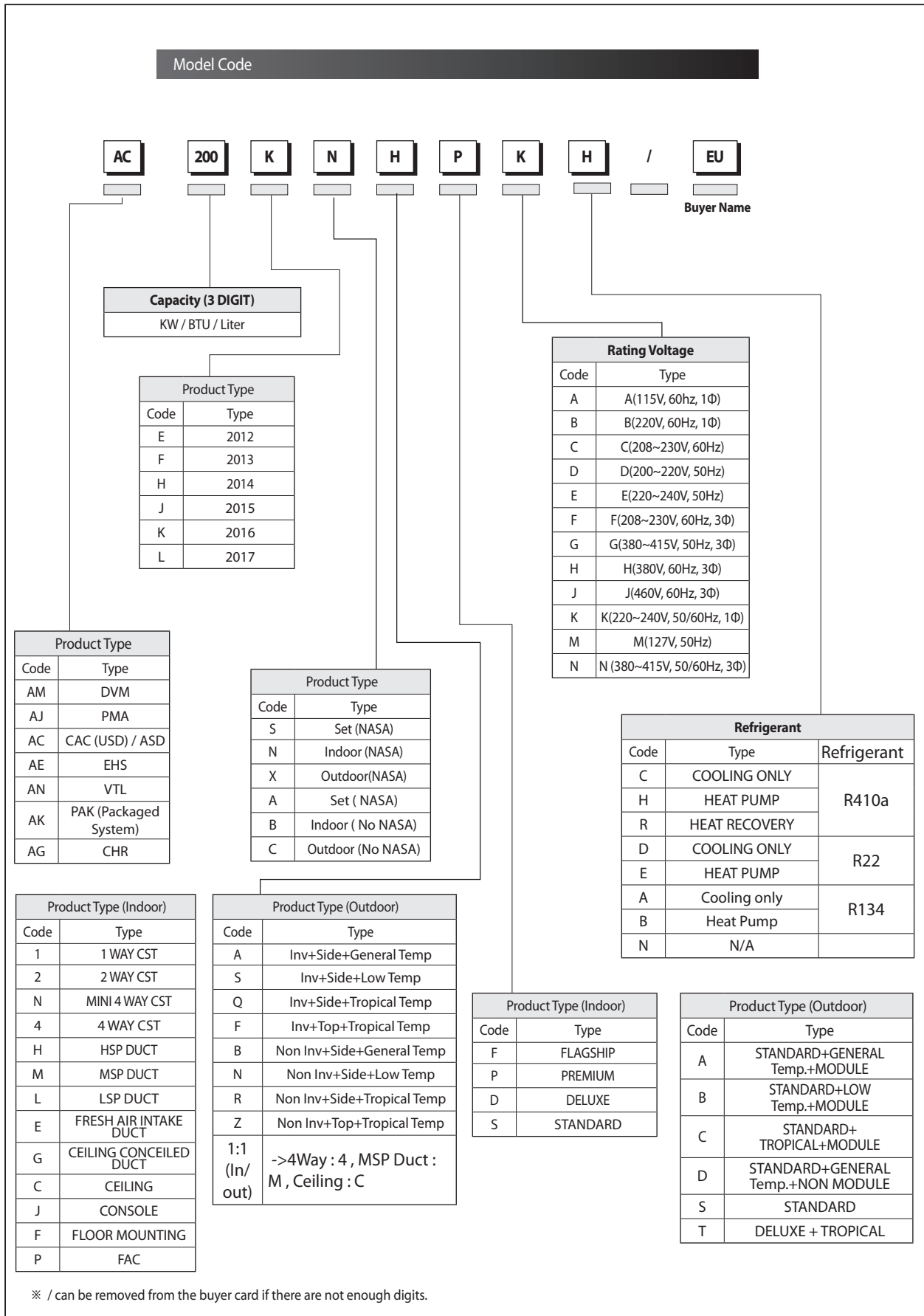



This Service Manual is a property of Samsung Electronics Co., Ltd.  
Any unauthorized use of Manual can be punished under applicable  
International and/or domestic law.

© Samsung Electronics Co., Ltd Apr. 2016.  
Printed in China.  
Code No. DB68-00000A (1)

---