

# TOSHIBA

## SERVICE MANUAL

# AIR-CONDITIONER

## SPLIT TYPE

**Indoor Unit**

**<Console, Heat Pump Type>**

***RAS-B10U2FVG-E,-TR***

***RAS-B13U2FVG-E,-TR***

***RAS-B18U2FVG-E,-TR***

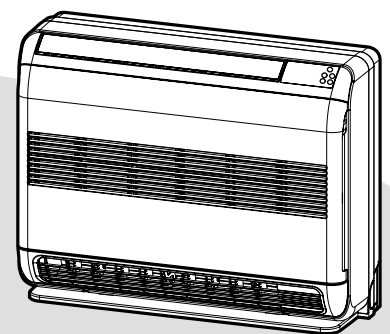

**R32**

**INVERTER**



# CONTENTS



1. SAFETY PRECAUTIONS .....	3
2. SPECIFICATIONS .....	7
3. REFRIGERANT R410A .....	9
4. CONSTRUCTION VIEWS .....	17
5. WIRING DIAGRAM .....	18
6. SPECIFICATIONS OF ELECTRICAL PARTS .....	19
7. REFRIGERANT CYCLE DIAGRAM .....	20
8. CONTROL BLOCK DIAGRAM .....	22
9. OPERATION DESCRIPTION .....	23
10. INSTALLATION PROCEDURE .....	57
11. HOW TO DIAGNOSE THE TROUBLE .....	65
12. HOW TO REPLACE THE MAIN PARTS .....	88
13. EXPLODED VIEWS AND PARTS LIST .....	95

## 1. SAFETY PRECAUTIONS

### SAFETY PRECAUTIONS



The important contents concerned to the safety are described on the product itself and on this Service Manual. Please read this Service Manual after understanding the described items thoroughly in the following contents (Indications/Illustrated marks), and keep them.





#### [Explanation of indications]

Indication	Explanation
 <b>DANGER</b>	Indicates contents assumed that an imminent danger causing a death or serious injury of the repair engineers and the third parties when an incorrect work has been executed.
 <b>WARNING</b>	Indicates possibilities assumed that a danger causing a death or serious injury of the repair engineers, the third parties, and the users due to troubles of the product after work when an incorrect work has been executed.
 <b>CAUTION</b>	Indicates contents assumed that an injury or property damage (*) may be caused on the repair engineers, the third parties, and the users due to troubles of the product after work when an incorrect work has been executed.

\* Property damage : Enlarged damage concerned to property, furniture, and domestic animal/pet

#### [Explanation of illustrated marks]

Mark	Explanation
	Indicates prohibited items (Forbidden items to do) The sentences near an illustrated mark describe the concrete prohibited contents.
	Indicates mandatory items (Compulsory items to do) The sentences near an illustrated mark describe the concrete mandatory contents.
	Indicates cautions (including danger/warning) The sentences or illustration near or in an illustrated mark describe the concrete cautious contents.

	Read the precautions in this manual carefully before operating the unit.		This appliance is filled with R32. (Flammable Material)
	Information included in the Operation Manual and/or Installation Manual.		Service personnel should be handling this equipment with reference to the Installation Manual.

### For general public use

Power supply cord of outdoor unit shall be more than 1.5 mm<sup>2</sup> (H07RN-F or 60245IEC66) polychloroprene sheathed flexible cord.

- Read this "SAFETY PRECAUTIONS" carefully before servicing.
- The precautions described below include the important items regarding safety. Observe them without fail.
- After the servicing work, perform a trial operation to check for any problem.
- Turn off the main power supply switch (or breaker) before the unit maintenance.

#### ■ Important information regarding the refrigerant used

This product contains fluorinated greenhouse gases covered by the Kyoto Protocol. Do not vent gases into the atmosphere. Refrigerant type: **R32**

GWP<sup>(1)</sup> value: **675\***

<sup>(1)</sup>GWP = global warming potential

The refrigerant quantity is indicated on the unit name plate.

\* This value is based on F gas regulation 517/2014

## CAUTION

### New Refrigerant Air Conditioner Installation

- **THIS AIR CONDITIONER ADOPTS THE NEW HFC REFRIGERANT (R32) WHICH DOES NOT DESTROY OZONE LAYER.**

R32 refrigerant is apt to be affected by impurities such as water, oxidizing membrane, and oils because the working pressure of R32 refrigerant is approx. 1.6 times of refrigerant R22. Accompanied with the adoption of the new refrigerant, the refrigeration machine oil has also been changed. Therefore, during installation work, be sure that water, dust, former refrigerant, or refrigeration machine oil does not enter into the new type refrigerant R32 air conditioner circuit.

To prevent mixing of refrigerant or refrigerating machine oil, the sizes of connecting sections of charging port on main unit and installation tools are different from those used for the conventional refrigerant units.

Accordingly, special tools are required for the new refrigerant (R32) units. For connecting pipes, use new and clean piping materials with high pressure fittings made for R32 only, so that water and/or dust does not enter. Moreover, do not use the existing piping because there are some problems with pressure fittings and possible impurities in existing piping.

## CAUTION

### TO DISCONNECT THE APPLIANCE FROM THE MAIN POWER SUPPLY

This appliance must be connected to the main power supply by a circuit breaker or a switch with a contact separation of at least 3 mm.



**DANGER**

- **ASK AN AUTHORIZED DEALER OR QUALIFIED INSTALLATION PROFESSIONAL TO INSTALL/MAINTAIN THE AIR CONDITIONER.**

INAPPROPRIATE SERVICING MAY RESULT IN WATER LEAKAGE, ELECTRIC SHOCK OR FIRE.

- **TURN OFF MAIN POWER SUPPLY BEFORE ATTEMPTING ANY ELECTRICAL WORK. MAKE SURE ALL POWER SWITCHES ARE OFF. FAILURE TO DO SO MAY CAUSE ELECTRIC SHOCK.**

**DANGER: HIGH VOLTAGE**

The high voltage circuit is incorporated.

Be careful to do the check service, as the electric shock may be caused in case of touching parts on the P.C. board by hand.

- **CORRECTLY CONNECT THE CONNECTING CABLE. IF THE CONNECTING CABLE IS INCORRECTLY CONNECTED, ELECTRIC PARTS MAY BE DAMAGED.**
- **CHECK THAT THE EARTH WIRE IS NOT BROKEN OR DISCONNECTED BEFORE SERVICE AND INSTALLATION. FAILURE TO DO SO MAY CAUSE ELECTRIC SHOCK.**
- **DO NOT INSTALL NEAR CONCENTRATIONS OF COMBUSTIBLE GAS OR GAS VAPORS. FAILURE TO FOLLOW THIS INSTRUCTION CAN RESULT IN FIRE OR EXPLOSION.**
- **TO PREVENT THE INDOOR UNIT FROM OVERHEATING AND CAUSING A FIRE HAZARD, PLACE THE UNIT WELL AWAY (MORE THAN 2 M) FROM HEAT SOURCES SUCH AS RADIATORS, HEAT REGISTORS, FURNACE, STOVES, ETC.**
- **WHEN MOVING THE AIR-CONDITIONER FOR INSTALLATION IN ANOTHER PLACE, BE VERY CAREFUL NOT TO ALLOW THE SPECIFIED REFRIGERANT (R410A) TO BECOME MIXED WITH ANY OTHER GASEOUS BODY INTO THE REFRIGERATION CIRCUIT. IF AIR OR ANY OTHER GAS IS MIXED IN THE REFRIGERANT, THE GAS PRESSURE IN THE REFRIGERATION CIRCUIT WILL BECOME ABNORMALLY HIGH AND IT MAY RESULT IN THE PIPE BURSTING AND POSSIBLE PERSONNEL INJURIES.**
- **IN THE EVENT THAT THE REFRIGERANT GAS LEAKS OUT OF THE PIPE DURING THE SERVICE WORK AND THE INSTALLATION WORK, IMMEDIATELY LET FRESH AIR INTO THE ROOM. IF THE REFRIGERANT GAS IS HEATED, SUCH AS BY FIRE, GENERATION OF POISONOUS GAS MAY RESULT.**

**WARNING**

- **Never modify this unit by removing any of the safety guards or bypass any of the safety interlock switches.**
- **Do not install in a place which cannot bear the weight of the unit. Personal injury and property damage can result if the unit falls.**
- **After the installation work, confirm that refrigerant gas does not leak.**  
If refrigerant gas leaks into the room and flows near a fire source, such as a cooking range, noxious gas may generate.
- **The electrical work must be performed by a qualified electrician in accordance with the Installation Manual. Make sure the air conditioner uses an exclusive circuit.**  
An insufficient circuit capacity or inappropriate installation may cause fire.
- **When wiring, use the specified cables and connect the terminals securely to prevent external forces applied to the cable from affecting the terminals.**
- **Be sure to provide grounding.**  
Do not connect ground wires to gas pipes, water pipes, lightning rods or ground wires for telephone cables.
- **Conform to the regulations of the local electric company when wiring the power supply.**  
Inappropriate grounding may cause electric shock.
- **Manufacturer pay no responsibility to any damage, caused by heating cable, being outside of unit.**

- Do not pierce or burn as the appliance is pressurized. Do not expose the appliance to heat, flame, sparks, or other sources or ignition. Else, it may explode and cause injury or death.
- For R32 model, use pipes, flare nut and tools which is specified for R32 refrigerant. Using of existing (R22) piping, flare nut and tools may cause abnormally high pressure in the refrigerant cycle (piping), and possibly result in explosion and injury.
- Thickness of copper pipes used R32 must be more than 0.8mm. Never use copper pipes thinner than 0.8mm.
- Do not perform flare connection inside a building or dwelling or room, when joining the heat exchanger of indoor unit with interconnection piping. Refrigerant connection inside a building or dwelling or room must be made by brazing or welding. Joint connection of indoor unit by flaring method can only be made at outdoor or at outside of building or dwelling or room. Flare connection may cause gas leak and flammable atmosphere.
- After completion of installation or service, confirm there is no leakage of refrigerant gas. It may generate toxic gas when the refrigerant contacts with fire.
- Appliance and pipe-work shall be installed, operated and stored in a room with a floor area large than  $A_{min}$  m<sup>2</sup>  
How to get  $A_{min}$  m<sup>2</sup> :  $A_{min} = (M / (2.5 \times 0.22759 \times h_0))^2$   
M is the refrigerant charge amount in appliance in kg.  $h_0$  is the installation height of the appliance in m : 0.6 m for floor standing/1.8m for wall mounted/1.0 m for window mounted/2.2 m for ceiling mounted.
- Comply with national gas regulations.

### CAUTION

- Exposure of unit to water or other moisture before installation may result in an electrical short. Do not store in a wet basement or expose to rain or water.
- Do not install in a place that can increase the vibration of the unit. Do not install in a place that can amplify the noise level of the unit or where noise or discharged air might disturb neighbors.
- To avoid personal injury, be careful when handling parts with sharp edges.
- **Perform the specified installation work to guard against an earthquake.**  
If the air conditioner is not installed appropriately, accidents may occur due to the falling unit.

#### For Reference:

If a heating operation would be continuously performed for a long time under the condition that the outdoor temperature is 0°C or lower, drainage of defrosted water may be difficult due to freezing of the bottom plate, resulting in a trouble of the cabinet or fan.

It is recommended to procure an antifreeze heater locally for a safe installation of the air conditioner.

For details, contact the dealer.

## 2. SPECIFICATIONS

### 2-1. Specifications

Unit model	Indoor		<b>RAS-B10U2FVG-E,-TR</b>	<b>RAS-B13U2FVG-E,-TR</b>	<b>RAS-B13U2FVG-E,-TR</b>				
	Outdoor		*	*	*				
Cooling capacity	(kW)		*	*	*				
Cooling capacity range	(kW)		*	*	*				
Heating capacity	(kW)		*	*	*				
Heating capacity range	(kW)		*	*	*				
Power supply			1Ph/50Hz/220-240V 1Ph/60Hz/220-230V	1Ph/50Hz/220-240V 1Ph/60Hz/220-230V	1Ph/50Hz/220-240V 1Ph/60Hz/220-230V				
Electric characteristic	Indoor	Operation mode	<b>Cooling</b>	<b>Heating</b>	<b>Cooling</b>	<b>Heating</b>	<b>Cooling</b>	<b>Heating</b>	
		Running current (A)	0.17-0.15	0.20-0.19	0.20-0.19	0.24-0.22	0.27-0.24	0.30-0.28	
		Power consumption (W)	20	25	25	30	35	40	
			Power factor (%)	54	56	56	57	60	60
	Outdoor	Operation mode	<b>Cooling</b>	<b>Heating</b>	<b>Cooling</b>	<b>Heating</b>	<b>Cooling</b>	<b>Heating</b>	
		Running current (A)	*	*	*	*	*	*	
		Power consumption (W)	*	*	*	*	*	*	
		Power factor (%)	*	*	*	*	*	*	
			Starting current (A)	3.04-2.78		5.06-4.65		8.49-7.78	
	COP (Cooling / Heating)			4.20/4.27		3.33-3.36		3.01/3.21	
Operating noise	Indoor	High (Cooling / Heating) (dB-A)	39/39		40/40		46/46		
		Medium (Cooling / Heating) (dB-A)	32/32		33/33		40/40		
		Low (Cooling / Heating) (dB-A)	28/26		27/27		34/34		
	Outdoor (Cooling / Heating) (dB-A)	*		*		*			
Indoor unit	Unit model		<b>RAS-B10U2FVG-E,-TR</b>	<b>RAS-B13U2FVG-E,-TR</b>	<b>RAS-B13U2FVG-E,-TR</b>				
Dimension	Height (mm)	600		600					
	Width (mm)	700		700					
	Depth (mm)	220		220					
Net weight (kg)	16		16						
Fan motor output (W)	41		41						
Air flow rate (Cooling / Heating) (m <sup>3</sup> / min)	7.8/8.5		8.5/9.2		10.0/10.7				
Outdoor unit	Unit model		*	*	*				
Dimension	Height (mm)	*		*					
	Width (mm)	*		*					
	Depth (mm)	*		*					
Net weight (kg)	*		*						
Compressor	Motor output (W)	*		*					
	Type	*		*					
	Model	*		*					
Fan motor output (W)	*		*						
Air flow rate (Cooling / Heating) (m <sup>3</sup> / min)	*		*						
Piping connection	Type		Flare connection		Flare connection				
Indoor unit	Liquid side (mm)	∅6.35		∅6.35					
	Gas side (mm)	∅9.52		∅9.52					
Outdoor unit	Liquid side (mm)	*		*					
	Gas side (mm)	*		*					
Maximum length (m)	*		*						
Maximum charge-less length (m)	*		*						
Maximum height difference (m)	*		*						
Refrigerant	Name of refrigerant		R32		R32				
	Weight (kg)		*		*				
Wiring connection	Power supply		*		*				
	Interconnection		4 Wires:Includes earth		4 Wires:Includes earth				
Usable temperature range	Indoor (Cooling / Heating) (°C)	21-32/0-28		21-32/0-28					
	Outdoor (Cooling / Heating) (°C)	-10-46/-15-24		-10-46/-15-24					
Accessory	Indoor unit	Installation plate	1		1				
		Wireless remote controller	1		1				
		Batteries	2		2				
		Toshiba New IAQ Filter	2		2				
		Install screw	8		8				
		Remote controller holder	1		1				
		Pan head wood screw for Remote control holder	2		2				
		Insulate pipe	1		1				
		Installation manual	1		1				
	Owner's manual	1		1					
Outdoor unit	Drain nipple	*		*					
	Water-proof rubber cap	*		*					

\* The specification may be subject to change without notice for purpose of improvement.

## 2-2. Combined multi-split outdoor unit

The multi-split outdoor units, which can be combined with B\*\*U2FVG series indoor unit are as described below:

Outdoor unit type	Combined outdoor unit model name	Indoor unit model name		
		B18U2FVG	B13U2FVG	B10U2FVG
2-room Multi outdoor unit	RAS-2M10U2AVG-E,-TR	X	X	○
	RAS-2M14U2AVG-E,-TR	X	○	○
	RAS-2M18U2AVG-E,-TR	X	○	○
3-room Multi outdoor unit	RAS-3M18U2AVG-E,-TR	X	○	○
	RAS-3M26U2AVG-E,-TR	○	○	○
4-room Multi outdoor unit	RAS-4M27U2AVG-E,-TR	○	○	○
5-room Multi outdoor unit	RAS-5M34U2AVG-E,-TR	○	○	○

○ : Combination available

X : Combination unavailable

This service manual describes about B\*\*U2FVG series indoor units only.

For the multi-split outdoor unit to be combined, refer to the service manual.

Outdoor unit	File name
Heat Pump Model	
RAS-2M10U2AVG-E,-TR	SVM-18005
RAS-2M14U2AVG-E,-TR	SVM-18020
RAS-2M18U2AVG-E,-TR	
RAS-3M18U2AVG-E,-TR	
RAS-3M26U2AVG-E,-TR	SVM-18051
RAS-4M27U2AVG-E,-TR	SVM-18052
RAS-5M34U2AVG-E,-TR	SVM-18053

### 3. REFRIGERANT R32

This air conditioner adopts the new refrigerant HFC (R32) which does not damage the ozone layer.

The next section describes the precautions for air conditioner using the new refrigerant. Conforming to contents of the next section together with the general cautions included in this manual, perform the correct and safe work.

#### 3-1. Safety During Installation/Service

The basic installation servicing work procedures are the same as conventional R410A models.

As R32's pressure is about 1.6 times higher than that of R22, improper installation/servicing may cause a serious trouble. By using tools and materials exclusive for R32, it is necessary to carry out installation/servicing safely while taking the following precautions into consideration.

1. Never use refrigerant other than R32 in an air conditioner which is designed to operate with R32. If other refrigerant than R32 is mixed, pressure in the refrigeration cycle becomes abnormally high, and it may cause personal injury, etc. by a rupture.
2. Confirm the used refrigerant name, and use tools and materials exclusive for the refrigerant. The refrigerant name R32 is indicated on the visible place of the outdoor unit of the air conditioner using R32 as refrigerant. To prevent mischarging, the diameter of the service port differs from that of R22. R32 and other HFCs are heavier than air, and therefore they are inclined to settle near the floor surface. If the gas fills up the room or the bottom part of a room, it may also cause oxygen deficiency and may reach its combustion concentration.

**In order to prevent oxygen deficiency and R32 combustion, keep the room well-ventilated for a healthy work environment.**

In particular, using HFCs in a basement room or confined area creates a higher risk; be sure to furnish the room with local exhaust ventilation. If a refrigerant leak is confirmed in a room an inadequately ventilated location, do not use a flame until the area has been ventilated appropriately and the work environment has been improved.

**The same applies in case of brazing, ensure appropriate ventilation to prevent oxygen deficiency and R32 combustion.**

Check that there are no dangerous or combustible items nearby, and ensure a fire extinguisher is close at hand.

Keep a sufficient distance away from causes of fire (ignition sources) such as gas-burning equipment and electric heaters in places where installation, repairs, or similar work on air-conditioning equipment is performed.

3. If a refrigeration gas leakage occurs during installation/servicing, be sure to ventilate fully. If the refrigerant gas comes into contact with fire, a poisonous gas may occur.
4. When installing or removing an air conditioner, do not allow air moisture dust or oil to remain in the refrigeration cycle. Otherwise, pressure in the refrigeration cycle may become abnormally high so that a rupture or personal injury may be caused.
5. After completion of installation work, check to make sure that there is no refrigeration gas leakage. If the refrigerant gas leaks into the room, coming into contact with fire in the fan-driven heater, space heater, etc., a poisonous gas may occur
6. When an air conditioning system charged with a large volume of refrigerant is installed in a small room, it is necessary to exercise care so that, even when refrigerant leaks, its concentration does not exceed the marginal level. If the refrigerant gas leakage occurs and its concentration exceeds the marginal level, an oxygen starvation accident may result.
7. Be sure to carry out installation or removal according to the installation manual. Improper installation may cause refrigeration trouble, water leakage, electric shock, fire, etc.
8. Unauthorized modifications to the air conditioner may be dangerous. If a breakdown occurs please call a qualified air conditioner technician or electrician. Improper repair's may result in water leakage, electric shock and fire, etc.

#### 3-2. Refrigerant Piping Installation

##### 3-2-1. Piping Materials and Joints Used

For the refrigerant piping installation, copper pipes and joints are mainly used. Copper pipes and joints suitable for the refrigerant must be chosen and installed. Furthermore, it is necessary to use clean copper pipes and joints whose interior surfaces are less affected by contaminants.

##### 1. Copper Pipes

It is necessary to use seamless copper pipes which are made of either copper or copper alloy and it is desirable that the amount of residual oil is less than 40 mg/10 m. Do not use copper pipes having a collapsed, deformed or discolored portion (especially on the interior surface).

Otherwise, the expansion valve or capillary tube may become blocked with contaminants.

As an air conditioner using R32 incurs pressure higher than when using R22, it is necessary to choose adequate materials.

Thicknesses of copper pipes used with R32 are as shown in Table 3-2-1. Never use copper pipes thinner than 0.8 mm even when it is available on the market.

**Table 3-2-1 Thicknesses of annealed copper pipes**

		Thickness (mm)	
Nominal diameter	Outer diameter (mm)	R32	R22
1/4	6.35	0.80	0.80
3/8	9.52	0.80	0.80
1/2	12.70	0.80	0.80
5/8	15.88	1.00	1.00

## 2. Joints

For copper pipes, flare joints or socket joints are used. Prior to use, be sure to remove all contaminants.

### a) Flare Joints

Flare joints used to connect the copper pipes cannot be used for pipings whose outer diameter exceeds 20 mm. In such a case, socket joints can be used.

Sizes of flare pipe ends, flare joint ends and flare nuts are as shown in Tables 3-2-3 to 3-2-6 below.

### b) Socket Joints

Socket joints are such that they are brazed for connections, and used mainly for thick pipings whose diameter is larger than 20 mm.

Thicknesses of socket joints are as shown in Table 3-2-2.

**Table 3-2-2 Minimum thicknesses of socket joints**

Nominal diameter	Reference outer diameter of copper pipe jointed (mm)	Minimum joint thickness (mm)
1/4	6.35	0.50
3/8	9.52	0.60
1/2	12.70	0.70
5/8	15.88	0.80

## 3-2-2. Processing of Piping Materials

When performing the refrigerant piping installation, care should be taken to ensure that water or dust does not enter the pipe interior, that no other oil than lubricating oils used in the installed air-water heat pump is used, and that refrigerant does not leak. When using lubricating oils in the piping processing, use such lubricating oils whose water content has been removed. When stored, be sure to seal the container with an airtight cap or any other cover.

### 1. Flare processing procedures and precautions

#### a) Cutting the Pipe

By means of a pipe cutter, slowly cut the pipe so that it is not deformed.

#### b) Removing Burrs and Chips

If the flared section has chips or burrs, refrigerant leakage may occur.

Carefully remove all burrs and clean the cut surface before installation.

#### c) Insertion of Flare Nut

d) Flare Processing

Make certain that a clamp bar and copper pipe have been cleaned.

By means of the clamp bar, perform the flare processing correctly.

Use either a flare tool for R32 or conventional flare tool.

Flare processing dimensions differ according to the type of flare tool. When using a conventional flare tool, be sure to secure "dimension A" by using a gauge for size adjustment.

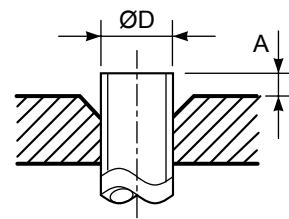

Fig. 3-2-1 Flare processing dimensions

Table 3-2-3 Dimensions related to flare processing for R32

Nominal diameter	Outer diameter (mm)	Thickness (mm)	A (mm)		
			Flare tool for R32 clutch type	Conventional flare tool	
				Clutch type	Wing nut type
1/4	6.35	0.8	0 to 0.5	1.0 to 1.5	1.5 to 2.0
3/8	9.52	0.8	0 to 0.5	1.0 to 1.5	1.5 to 2.0
1/2	12.70	0.8	0 to 0.5	1.0 to 1.5	2.0 to 2.5
5/8	15.88	1.0	0 to 0.5	1.0 to 1.5	2.0 to 2.5

Table 3-2-4 Dimensions related to flare processing for R22

Nominal diameter	Outer diameter (mm)	Thickness (mm)	A (mm)		
			Flare tool for R22 clutch type	Conventional flare tool	
				Clutch type	Wing nut type
1/4	6.35	0.8	0 to 0.5	0.5 to 1.0	1.0 to 1.5
3/8	9.52	0.8	0 to 0.5	0.5 to 1.0	1.0 to 1.5
1/2	12.70	0.8	0 to 0.5	0.5 to 1.0	1.5 to 2.0
5/8	15.88	1.0	0 to 0.5	0.5 to 1.0	1.5 to 2.0

Table 3-2-5 Flare and flare nut dimensions for R32

Nominal diameter	Outer diameter (mm)	Thickness (mm)	Dimension (mm)				Flare nut width (mm)
			A	B	C	D	
1/4	6.35	0.8	9.1	9.2	6.5	13	17
3/8	9.52	0.8	13.2	13.5	9.7	20	22
1/2	12.70	0.8	16.6	16.0	12.9	23	26
5/8	15.88	1.0	19.7	19.0	16.0	25	29

Table 3-2-6 Flare and flare nut dimensions for R22

Nominal diameter	Outer diameter (mm)	Thickness (mm)	Dimension (mm)				Flare nut width (mm)
			A	B	C	D	
1/4	6.35	0.8	9.0	9.2	6.5	13	17
3/8	9.52	0.8	13.0	13.5	9.7	20	22
1/2	12.70	0.8	16.2	16.0	12.9	20	24
5/8	15.88	1.0	19.7	19.0	16.0	23	27
3/4	19.05	1.0	23.3	24.0	19.2	34	36

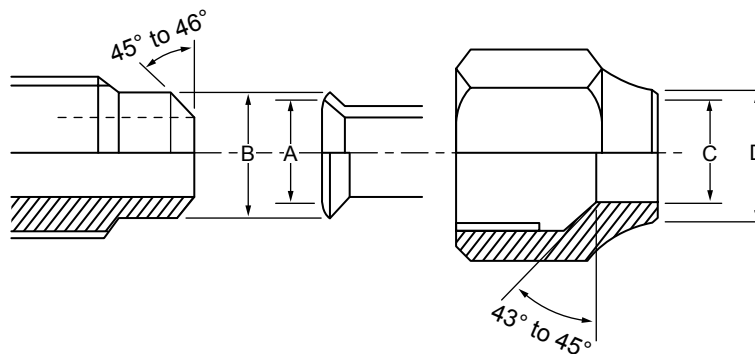

Fig. 3-2-2 Relations between flare nut and flare seal surface

## 2. Flare Connecting Procedures and Precautions

- Make sure that the flare and union portions do not have any scar or dust, etc.
- Correctly align the processed flare surface with the union axis.
- Tighten the flare with designated torque by means of a torque wrench. The tightening torque for R32 is the same as that for conventional R22. Incidentally, when the torque is weak, the gas leakage may occur. When it is strong, the flare nut may crack and may be made non-removable. When choosing the tightening torque, comply with values designated by manufacturers. Table 3-2-7 shows reference values.

### NOTE :

When applying oil to the flare surface, be sure to use oil designated by the manufacturer. If any other oil is used, the lubricating oils may deteriorate and cause the compressor to burn out.

Table 3-2-7 Tightening torque of flare for R32 [Reference values]

Nominal diameter	Outer diameter (mm)	Tightening torque N•m (kgf•cm)	Tightening torque of torque wrenches available on the market N•m (kgf•cm)
1/4	6.35	14 to 18 (140 to 180)	16 (160), 18 (180)
3/8	9.52	33 to 42 (330 to 420)	42 (420)
1/2	12.70	50 to 62 (500 to 620)	55 (550)
5/8	15.88	63 to 77 (630 to 770)	65 (650)



### 3-3. Tools

#### 3-3-1. Required Tools

The service port diameter of packed valve of the outdoor unit in the air-water heat pump using R32 is changed to prevent mixing of other refrigerant. To reinforce the pressure-resisting strength, flare processing dimensions and opposite side dimension of flare nut (For Ø12.7 copper pipe) of the refrigerant piping are lengthened.

The used refrigerating oil is changed, and mixing of oil may cause a trouble such as generation of sludge, clogging of capillary, etc. Accordingly, the tools to be used are classified into the following three types.

1. Tools exclusive for R32 (Those which cannot be used for conventional refrigerant (R22))
2. Tools exclusive for R32, but can be also used for conventional refrigerant (R22)
3. Tools commonly used for R32 and for conventional refrigerant (R22)

The table below shows the tools exclusive for R32 and their interchangeability.

#### Tools exclusive for R410A (The following tools for R32 are required.)

Tools whose specifications are changed for R32 and their interchangeability

No.	Used tool	Usage	R32 air-water heat pump installation		Conventional air-water heat pump installation
			Existence of new equipment for R32	Whether conventional equipment can be used	Whether new equipment can be used with conventional refrigerant
1	Flare tool	Pipe flaring	Yes	*(Note 1)	○
2	Copper pipe gauge for adjusting projection margin	Flaring by conventional flare tool	Yes	*(Note 1)	*(Note 1)
3	Torque wrench (For Ø12.7)	Connection of flare nut	Yes	×	×
4	Gauge manifold	Evacuating, refrigerant charge, run check, etc.	Yes	×	×
5	Charge hose				
6	Vacuum pump adapter	Vacuum evacuating	Yes	×	○
7	Electronic balance for refrigerant charging	Refrigerant charge	Yes	×	○
8	Refrigerant cylinder	Refrigerant charge	Yes	×	×
9	Leakage detector	Gas leakage check	Yes	×	○
10	Charging cylinder	Refrigerant charge	(Note 2)	×	×

**(Note 1)** When flaring is carried out for R32 using the conventional flare tools, adjustment of projection margin is necessary. For this adjustment, a copper pipe gauge, etc. are necessary.

**(Note 2)** Charging cylinder for R32 is being currently developed.

#### General tools (Conventional tools can be used.)

In addition to the above exclusive tools, the following equipments which serve also for R22 are necessary as the general tools.

- |   |                             |  |
|---|-----------------------------|--|
| 1. Vacuum pump<br>Use vacuum pump by attaching vacuum pump adapter. | 4. Reamer                   | 9. Hole core drill (Ø65)               |
| 2. Torque wrench (For Ø6.35, Ø9.52)                                 | 5. Pipe bender              | 10. Hexagon wrench (Opposite side 4mm) |
| 3. Pipe cutter  | 6. Level vial               | 11. Tape measure                       |
|   | 7. Screwdriver (+, -)       | 12. Metal saw                          |
|   | 8. Spanner or Monkey wrench |  |

Also prepare the following equipments for other installation method and run check.

- |                |                                 |
|----------------|---------------------------------|
| 1. Clamp meter | 3. Insulation resistance tester |
| 2. Thermometer | 4. Electroscop                  |

### 3-4. Recharging of Refrigerant

When it is necessary to recharge refrigerant, charge the specified amount of new refrigerant according to the following steps.

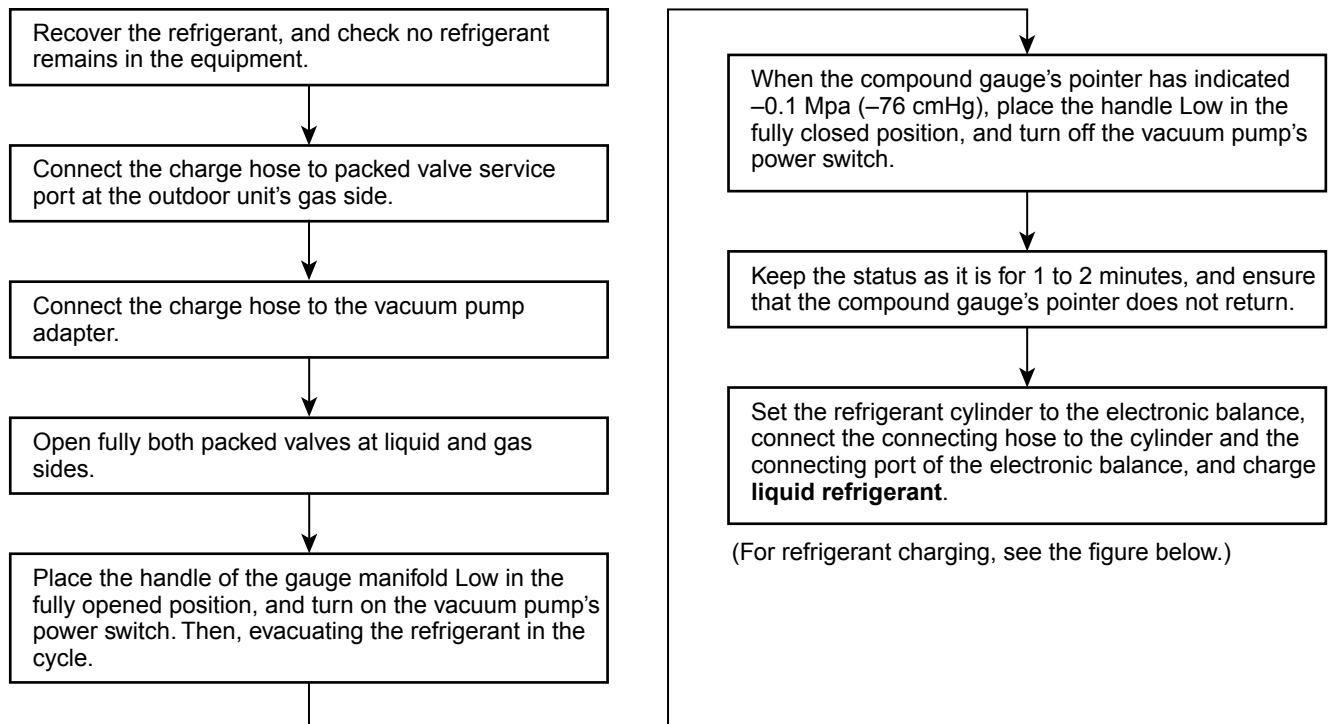

1. Never charge refrigerant exceeding the specified amount.
2. If the specified amount of refrigerant cannot be charged, charge refrigerant **bit by bit** in COOL mode.
3. Do not carry out additional charging.

When additional charging is carried out if refrigerant leaks, the refrigerant composition changes in the refrigeration cycle, that is characteristics of the air conditioner changes, refrigerant exceeding the specified amount is charged, and working pressure in the refrigeration cycle becomes abnormally high pressure, and may cause a rupture or personal injury.

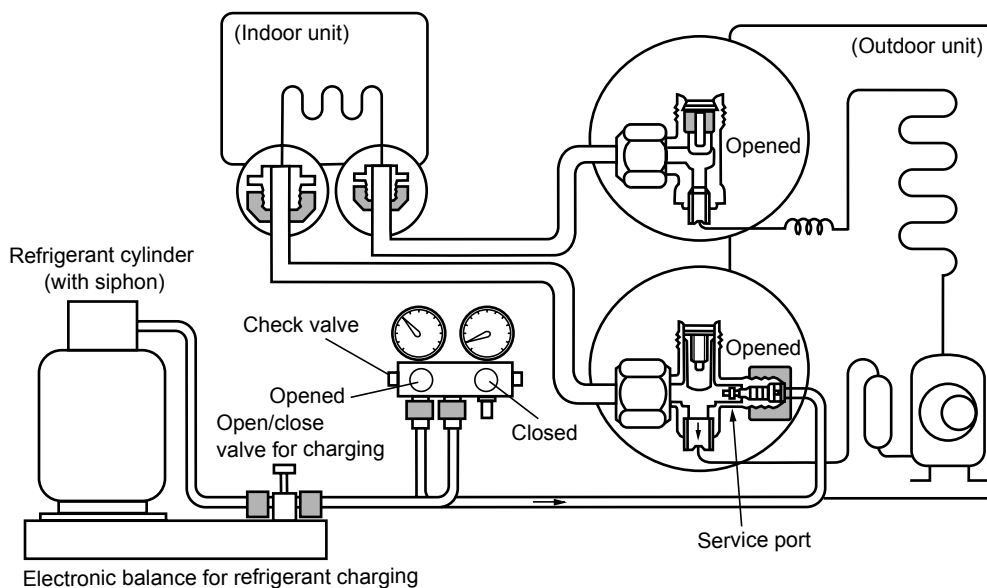
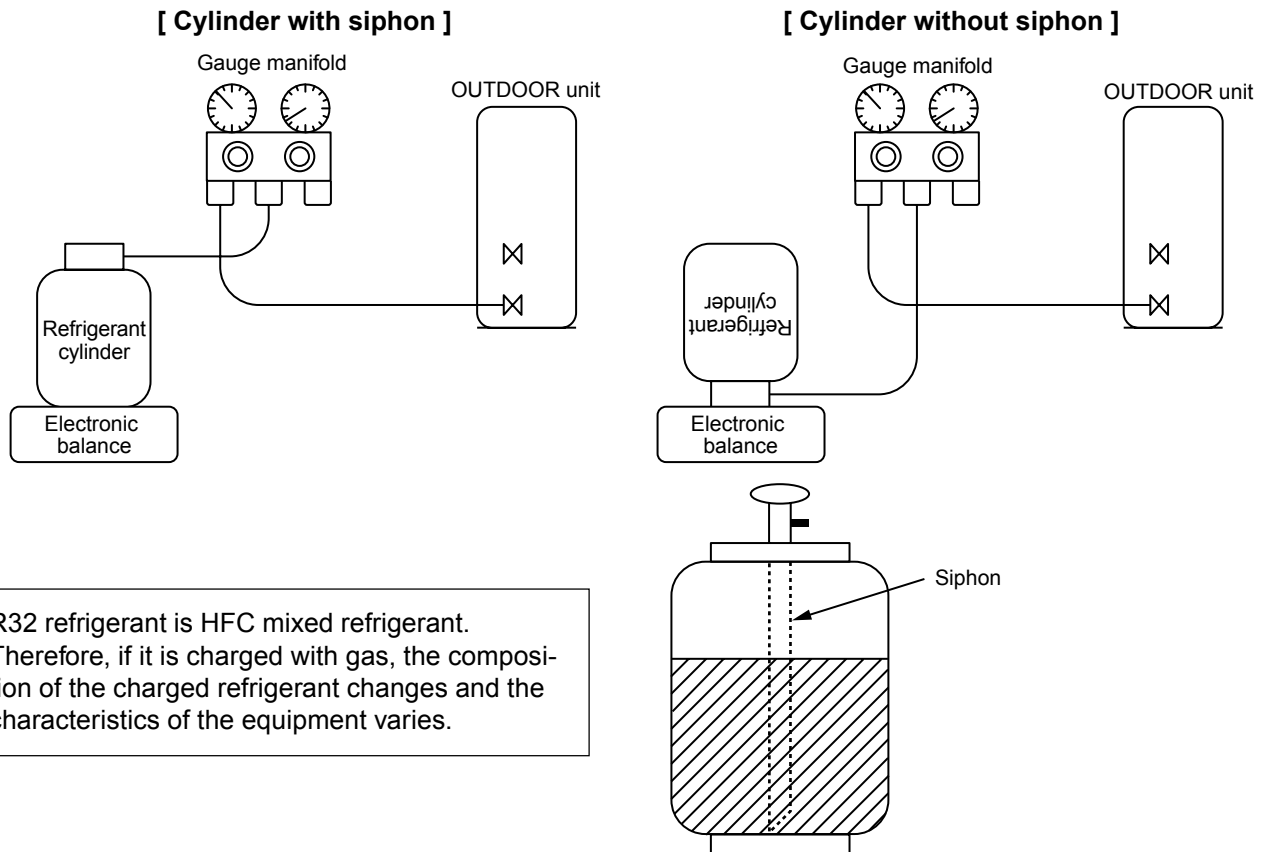

Fig. 3-4-1 Configuration of refrigerant charging

1. Be sure to make setting so that **liquid** can be charged.
2. When using a cylinder equipped with a siphon, liquid can be charged without turning it upside down.

It is necessary for charging refrigerant under condition of liquid because R32 is mixed type of refrigerant. Accordingly, when charging refrigerant from the refrigerant cylinder to the equipment, charge it turning the cylinder upside down if cylinder is not equipped with siphon.



R32 refrigerant is HFC mixed refrigerant. Therefore, if it is charged with gas, the composition of the charged refrigerant changes and the characteristics of the equipment varies.

Fig. 3-4-2

### 3-5. Brazing of Pipes

#### 3-5-1. Materials for Brazing

##### 1. Silver brazing filler

Silver brazing filler is an alloy mainly composed of silver and copper. It is used to join iron, copper or copper alloy, and is relatively expensive though it excels in solderability.

##### 2. Phosphor bronze brazing filler

Phosphor bronze brazing filler is generally used to join copper or copper alloy.

##### 3. Low temperature brazing filler

Low temperature brazing filler is generally called solder, and is an alloy of tin and lead. Since it is weak in adhesive strength, do not use it for refrigerant pipes.

1. Phosphor bronze brazing filler tends to react with sulfur and produce a fragile compound water solution, which may cause a gas leakage. Therefore, use any other type of brazing filler at a hot spring resort, etc., and coat the surface with a paint.
2. When performing brazing again at time of servicing, use the same type of brazing filler.

#### 3-5-2. Flux

##### 1. Reason why flux is necessary

- By removing the oxide film and any foreign matter on the metal surface, it assists the flow of brazing filler.
- In the brazing process, it prevents the metal surface from being oxidized.
- By reducing the brazing filler's surface tension, the brazing filler adheres better to the treated metal.

**2. Characteristics required for flux**

- Activated temperature of flux coincides with the brazing temperature.
- Due to a wide effective temperature range, flux is hard to carbonize.
- It is easy to remove slag after brazing.
- The corrosive action to the treated metal and brazing filler is minimum.
- It excels in coating performance and is harmless to the human body.

As the flux works in a complicated manner as described above, it is necessary to select an adequate type of flux according to the type and shape of treated metal, type of brazing filler and brazing method, etc.

**3. Types of flux**

**• Noncorrosive flux**

Generally, it is a compound of borax and boric acid.

It is effective in case where the brazing temperature is higher than 800°C.

**• Activated flux**

Most of fluxes generally used for silver brazing are this type.

It features an increased oxide film removing capability due to the addition of compounds such as potassium fluoride, potassium chloride and sodium fluoride to the borax-boric acid compound.

**4. Piping materials for brazing and used brazing filler/flux**

Piping material	Used brazing filler	Used flux
Copper - Copper	Phosphor copper	Do not use
Copper - Iron	Silver	Paste flux
Iron - Iron	Silver	Vapor flux

1. Do not enter flux into the refrigeration cycle.
2. When chlorine contained in the flux remains within the pipe, the lubricating oil deteriorates. Therefore, use a flux which does not contain chlorine.
3. When adding water to the flux, use water which does not contain chlorine (e.g. distilled water or ion-exchange water).
4. Remove the flux after brazing.

**3-5-3. Brazing**

As brazing work requires sophisticated techniques, experiences based upon a theoretical knowledge, it must be performed by a person qualified.

In order to prevent the oxide film from occurring in the pipe interior during brazing, it is effective to proceed with brazing while letting dry Nitrogen gas (N<sub>2</sub>) flow.

**Never use gas other than Nitrogen gas.**

**1. Brazing method to prevent oxidation**

- 1) Attach a reducing valve and a flow-meter to the Nitrogen gas cylinder.
- 2) Use a copper pipe to direct the piping material, and attach a flow-meter to the cylinder.
- 3) Apply a seal onto the clearance between the piping material and inserted copper pipe for Nitrogen in order to prevent backflow of the Nitrogen gas.
- 4) When the Nitrogen gas is flowing, be sure to keep the piping end open.
- 5) Adjust the flow rate of Nitrogen gas so that it is lower than 0.05 m<sup>3</sup>/Hr or 0.02 MPa (0.2kgf/cm<sup>2</sup>) by means of the reducing valve.
- 6) After performing the steps above, keep the Nitrogen gas flowing until the pipe cools down to a certain extent (temperature at which pipes are touchable with hands).
- 7) Remove the flux completely after brazing.

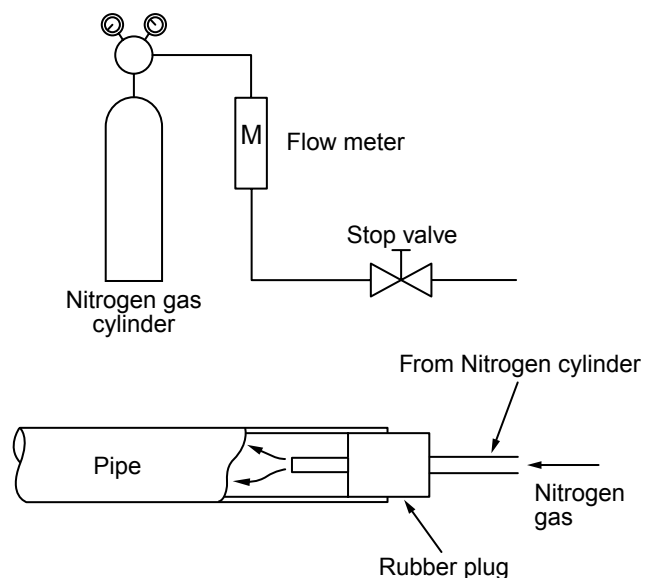

**Fig. 3-5-1 Prevention of oxidation during brazing**

### 4. CONSTRUCTION VIEWS

#### 4-1. Indoor Unit

RAS-B10 U2FVG-E,-TR

RAS-B13 U2FVG-E,-TR

RAS-B18 U2FVG-E,-TR

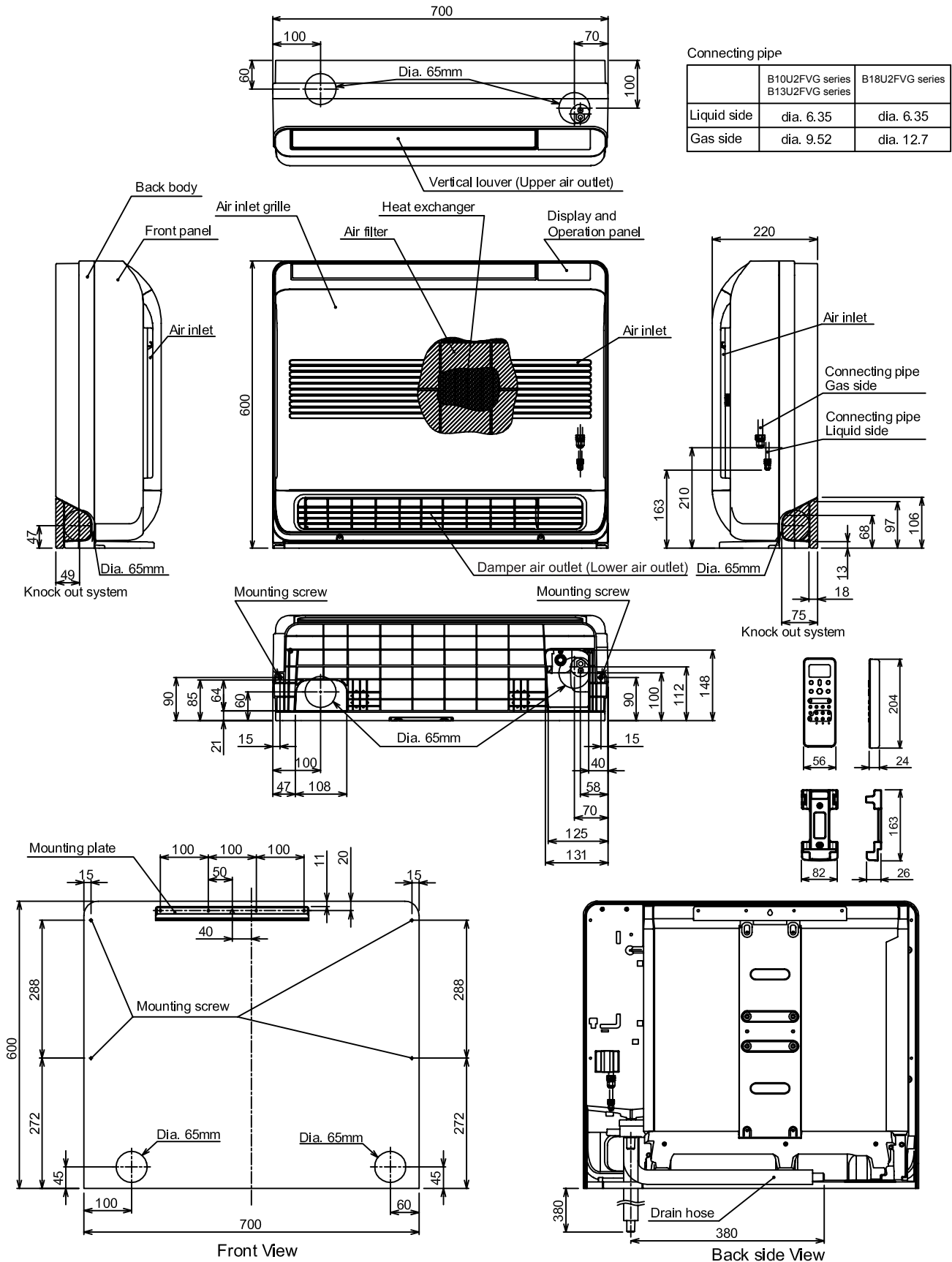

Connecting pipe

	B10U2FVG series B13U2FVG series	B18U2FVG series
Liquid side	dia. 6.35	dia. 6.35
Gas side	dia. 9.52	dia. 12.7

### 5. WIRING DIAGRAM

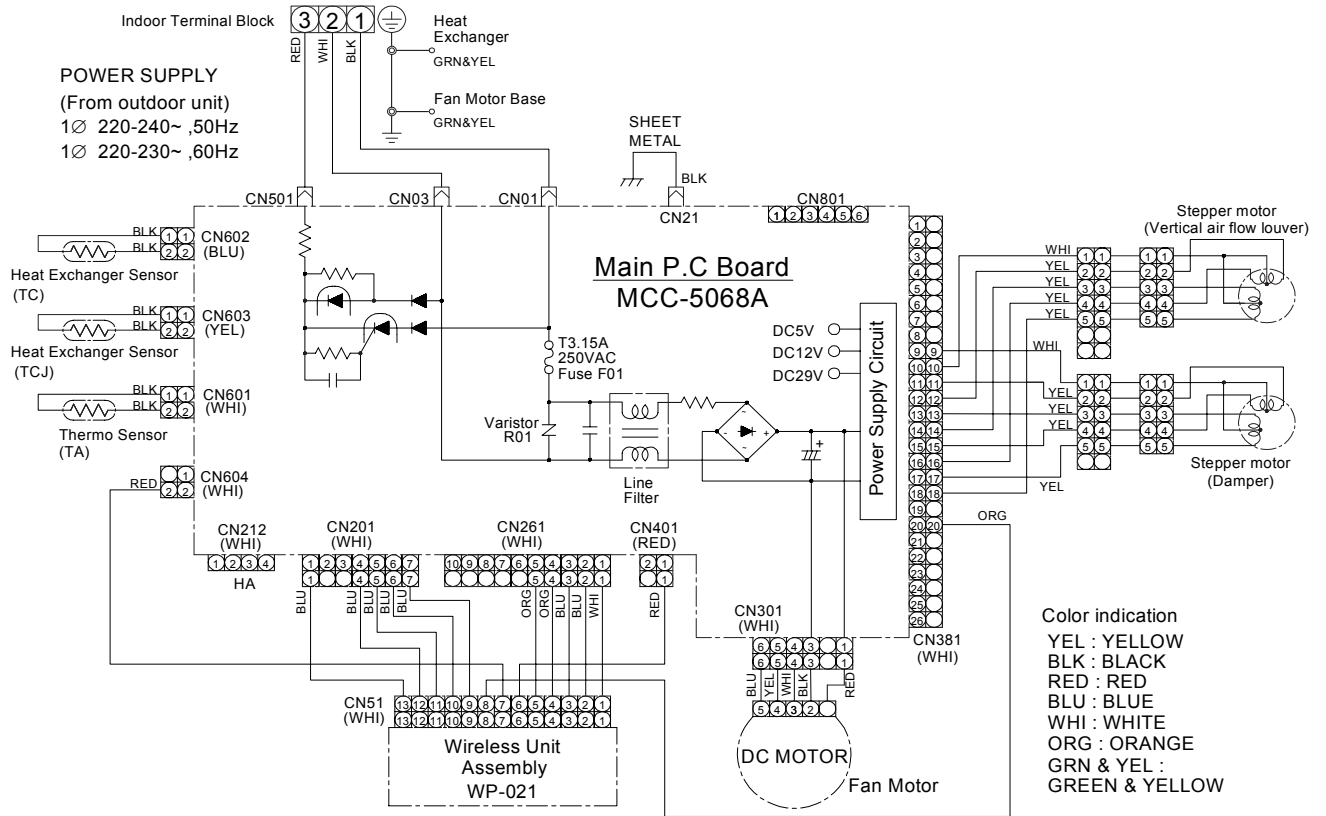

## 6. SPECIFICATIONS OF ELECTRICAL PARTS

### 6-1. Indoor Unit

No.	Parts name	Type	Specifications
1	Fan motor (for indoor)	ICF-340-41-1	DC340, 41W
2	Room temp. sensor (TA-sensor)	( - )	10k $\Omega$ at 25°C
3	Heat exchanger temp. sensor (TC-sensor)	( - )	10k $\Omega$ at 25°C
4	Heat exchanger temp. sensor (TCJ-sensor)	( - )	10k $\Omega$ at 25°C
5	Louver motor	MP24Z3N	Output (Rated), 16 poles, DC12V
6	Dumper motor	MP24Z3N	Output (Rated), 16 poles, DC12V

## 7. REFRIGERANT CYCLE DIAGRAM

### 7-1. Refrigerant Cycle Diagram

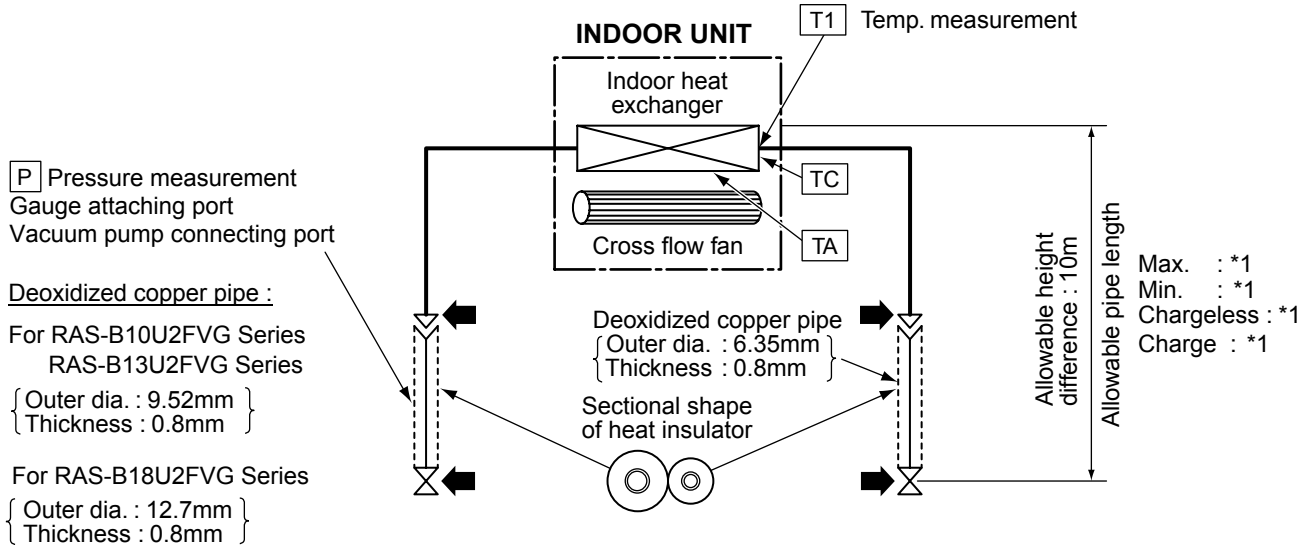

\*1 : Refer to the service manual of multi outdoor unit to be combined.



**7-2. Operation Data****<Cooling>**

Temperature condition(°C)		Model name RAS-	Standard pressure P (MPa)	Heat exchanger pipe temp.		Indoor fan mode	Outdoor fan mode	Compressor revolution (rps)
Indoor	Outdoor			T1 (°C)	T2 (°C)			
27/19	35/-	B10U2FVG-E,-TR	*	*	*	*	*	*
		B13U2FVG-E,-TR	*	*	*	*	*	*
		B18U2FVG-E,-TR	*	*	*	*	*	*

**<Heating>**

Temperature condition(°C)		Model name RAS-	Standard pressure P (MPa)	Heat exchanger pipe temp.		Indoor fan mode	Outdoor fan mode	Compressor revolution (rps)
Indoor	Outdoor			T1 (°C)	T2 (°C)			
20/-	7/6	B10U2FVG-E,-TR	*	*	*	*	*	*
		B13U2FVG-E,-TR	*	*	*	*	*	*
		B18U2FVG-E,-TR	*	*	*	*	*	*

**NOTES :**

\* Refer to service manual of outdoor unit which combined.

## 8. CONTROL BLOCK DIAGRAM

### 8-1. Indoor Unit

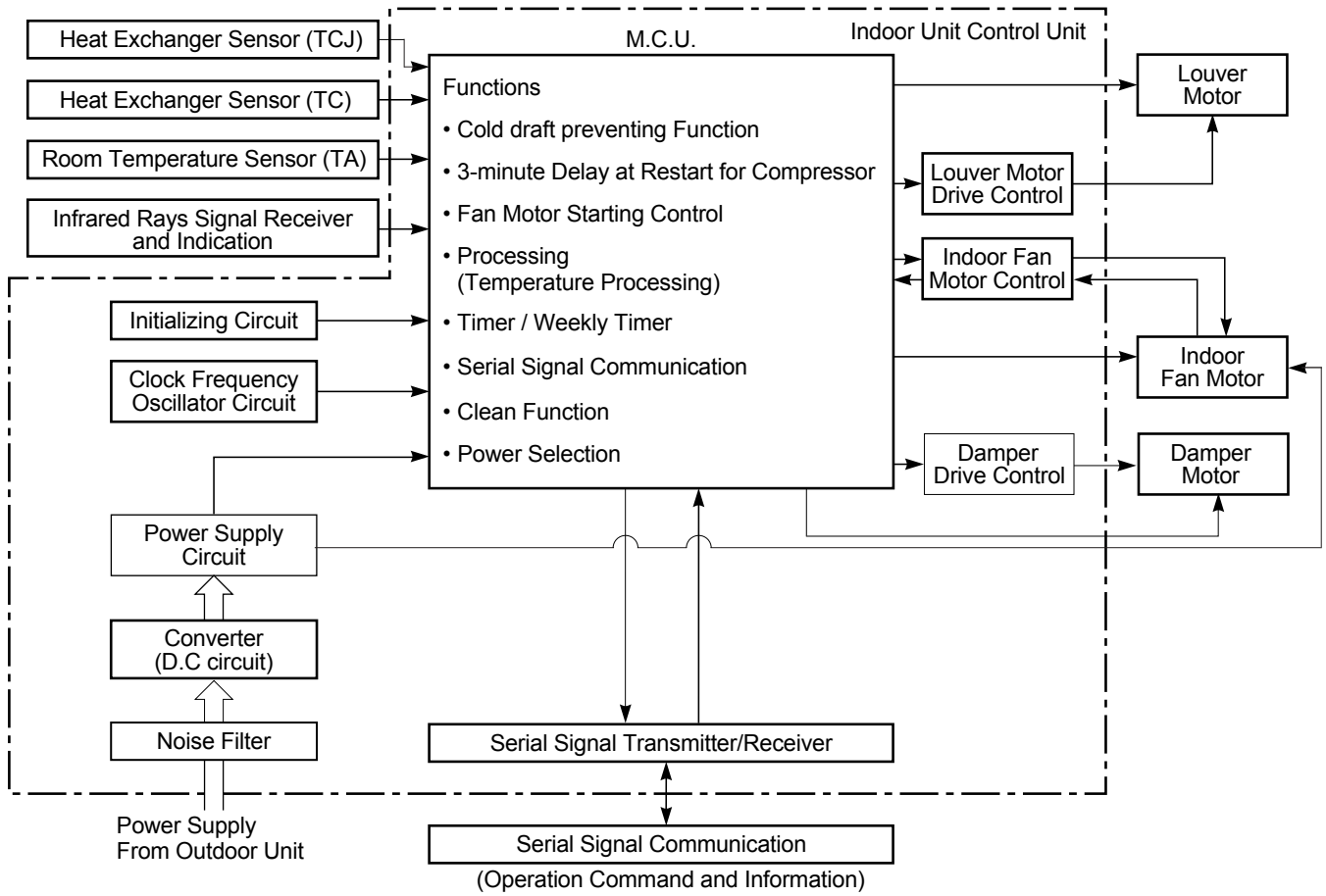

### REMOTE CONTROL

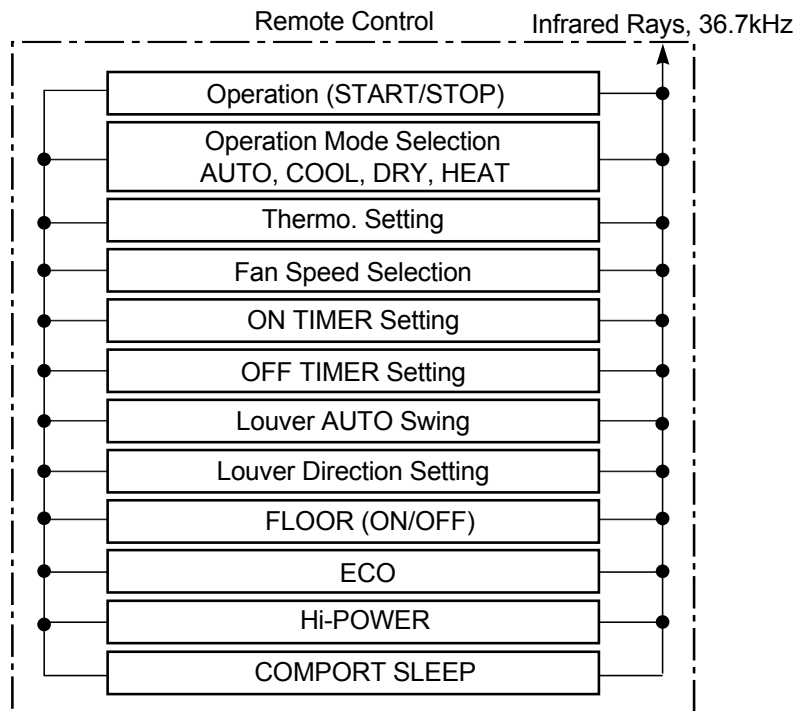

## 9. OPERATION DESCRIPTION

### 9-1. Outline of Air Conditioner Control

This air conditioner is a capacity-variable type air conditioner, which uses DC motor for the indoor fan motor and the outdoor fan motor. And the capacity-proportional control compressor which can change the motor speed is mounted. The DC motor drive circuit is mounted to the indoor unit. The compressor and the inverter to control fan motor are mounted to the outdoor unit.

The entire air conditioner is mainly controlled by the indoor unit controller.

The indoor unit controller drives the indoor fan motor based upon command sent from the remote controller or indoor unit display buttons and transfers the operation command to the outdoor unit controller.

The outdoor unit controller receives operation command from the indoor unit side, and controls the outdoor fan and the pulse Modulating valve. (P.M.V) Besides, detecting revolution position of the compressor motor, the outdoor unit controller controls speed of the compressor motor by controlling output voltage of the inverter and switching timing of the supply power (current transfer timing) so that motors drive according to the operation command.

And then, the outdoor unit controller transfers reversely the operating status information of the outdoor unit to control the indoor unit controller.

#### NOTE :

**As the compressor adopts four-pole brushless DC motor, the frequency of the supply power from inverter to compressor is two-times cycles of the actual number of revolution.**

#### 1. Role of indoor unit controller

The indoor unit controller judges the operation commands from the remote control or indoor unit display buttons, and assumes the following functions.

- Judgment of suction air temperature of the indoor heat exchanger by using the indoor temp. sensor. (TA sensor)
- Judgment of the indoor heat exchanger temperature by using heat exchanger sensor (TC sensor) (Prevent-freezing control, etc.)
- Louver motor control
- Indoor fan motor operation control
- LED (Light Emitting Diode) display control
- Transferring of operation command signal (Serial signal) to the outdoor unit
- Reception of information of operation status (Serial signal including outside temp. data) to the outdoor unit and judgment/display of error

#### 2. Role of outdoor unit controller

Receiving the operation command signal (Serial signal) from the indoor unit controller, the outdoor unit performs its role.

- Compressor operation control
- Operation control of outdoor fan motor
- P.M.V. control
- 4-way valve control
- Operations followed to judgment of serial signal from indoor side.

- Detection of inverter input current and current release operation
- Over-current detection and prevention operation to IGBT module (Compressor stop function)
- Compressor and outdoor fan stop function when serial signal is off (when the serial signal does not reach the board assembly of outdoor control by trouble of the signal system)
- Transferring of operation information (Serial signal) from outdoor unit controller to indoor unit controller
- Detection of outdoor temperature and operation revolution control
- Defrost control in heating operation (Temp. measurement by outdoor heat exchanger and control for 4-way valve and outdoor fan)

#### 3. Contents of operation command signal (Serial signal) from indoor unit controller to outdoor unit controller

The following three types of signals are sent from the indoor unit controller.

- Operation mode set on the remote controller
- Compressor revolution command signal defined by indoor temperature and set temperature (Correction along with variation of room temperature and correction of indoor heat exchanger temperature are added.)
- Temperature of indoor heat exchanger
- For these signals ([Operation mode] and [Compressor revolution] indoor heat exchanger temperature), the outdoor unit controller monitors the input current to the inverter, and performs the followed operation within the range that current does not exceed the allowable value.

#### 4. Contents of operation command signal (Serial signal) from outdoor unit controller to indoor unit controller

The following signals are sent from the outdoor unit controller.





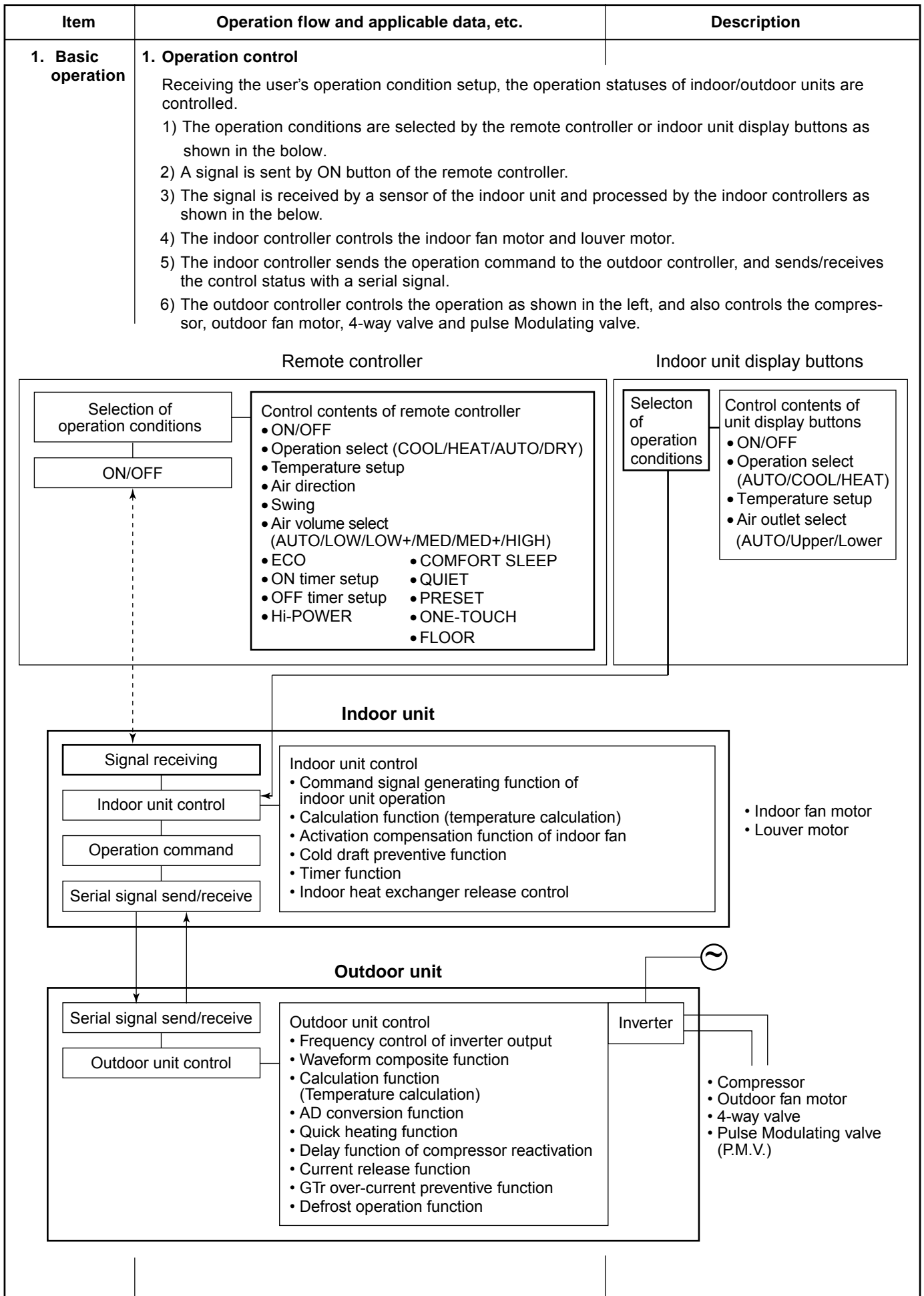

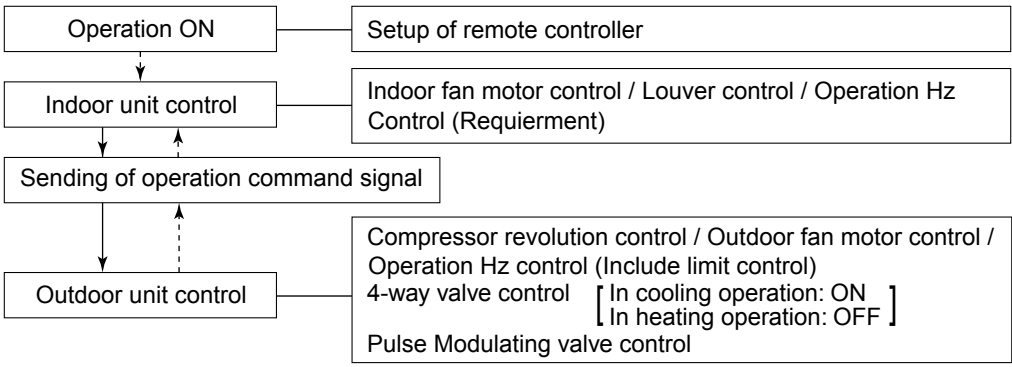
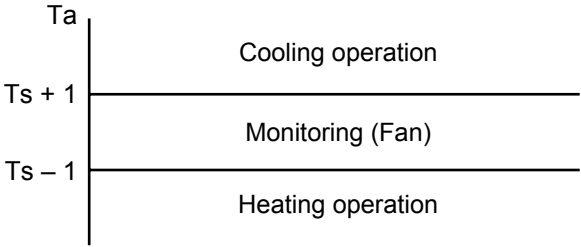



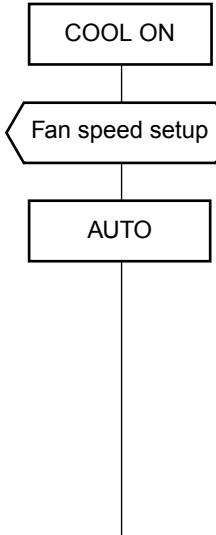





- The current operation mode
  - The current compressor revolution
  - Outdoor temperature
  - Existence of protective circuit operation
- For transferring of these signals, the indoor unit controller monitors the contents of signals, and judges existence of trouble occurrence. Contents of judgment are described below.
- Whether distinction of the current operation status meets to the operation command signal
  - Whether protective circuit operates
- When no signal is received from the outdoor unit controller, it is assumed as a trouble.

<b>9-2. Operation Description</b>	
1. Basic operation .....	25
1. Operation control .....	25
2. Cooling/Heating operation .....	26
3. AUTO operation .....	26
4. DRY operation .....	27
2. Indoor fan motor control .....	28
3. Capacity control .....	31
4. Current release control .....	31
5. Defrost control (Only in heating operation) .....	31
6. Release protective control by temperature of indoor heat exchanger .....	31
7. Air outlet selection .....	33
8. Lower air outlet louver control .....	34
9. Upper air outlet louver control .....	35
10. ECO operation .....	36
11. Test operation .....	37
12. Discharge temperature control .....	37
13. Pulse Modulating valve (P.M.V.) control .....	38
14. Self-Cleaning function .....	39
15. Self-Cleaning function release .....	40
16. Remote-A or B selection .....	41
17. QUIET mode .....	42
18. COMFORT SLEEP .....	42
19. Short Timer .....	42
20. One-Touch Comfort .....	43
21. Hi-POWER Mode .....	43
22. FILTER Indicator .....	43
23. Set temp. correction .....	44
24. Outdoor Quiet control .....	45
<b>9-3. Auto Restart Function</b> .....	47
9-3-1. How to Set the Auto Restart Function .....	47
9-3-2. How to Cancel the Auto Restart Function .....	48
9-3-3. Power Failure During Timer Operation .....	48
<b>9-4. Remote Control</b> .....	49
9-4-1. Remote control and its functions .....	49
9-4-2. Operation of remote control .....	49
9-4-3. Name and Functions of Indications on Remote Controller .....	55
<b>9-5. Indoor Unit Display &amp; Unit Operation Panel</b> .....	56



Item	Operation flow and applicable data, etc.	Description
<p><b>1. Basic operation</b></p>	<p><b>2. Cooling/Heating operation</b></p> <p>The operations are performed in the following parts by controls according to cooling/heating conditions.</p> <ol style="list-style-type: none"> <li>1) Receiving the operation ON signal of the remote controller, the cooling or heating operation signal starts being transferred from the indoor controller to the outdoor unit.</li> <li>2) At the indoor unit side, the indoor fan is operated according to the contents of “<b>2. Indoor fan motor control</b>” and the louver according to the contents of “<b>9. Louver control</b>”, respectively.</li> <li>3) The outdoor unit controls the outdoor fan motor, compressor, pulse Modulating valve and 4-way valve according to the operation signal sent from the indoor unit.</li> </ol> 	
	<p><b>3. AUTO operation</b></p> <p>Selection of operation mode As shown in the following figure, the operation starts by selecting automatically the status of room temperature (TA) when starting AUTO operation.</p> <p>*1. When reselecting the operation mode, the fan speed is controlled by the previous operation mode.</p> 	<ol style="list-style-type: none"> <li>1) Detects the room temperature (TA) when the operation started.</li> <li>2) Selects an operation mode from TA in the left figure.</li> <li>3) Fan operation continues until an operation mode is selected.</li> <li>4) When AUTO operation has started within 2 hours after heating operation stopped and if the room temperature is 20°C or more, the fan operation is performed with "Super Ultra LOW" mode for 3 minutes. Then, select an operation mode.</li> <li>5) If the status of compressor-OFF continues for 15 minutes the room temperature after selecting an operation mode (COOL/HEAT), reselect an operation mode.</li> </ol>

Item	Operation flow and applicable data, etc.	Description																																																																															
<p><b>1. Basic operation</b></p>	<p><b>4. DRY operation</b></p> <p>DRY operation is performed according to the difference between room temperature and the setup temperature as shown below.</p> <p>In DRY operation, fan speed is controlled in order to prevent lowering of the room temperature.</p> <table border="1" data-bbox="643 696 1342 1319"> <thead> <tr> <th rowspan="2">Zone</th> <th colspan="3">Compressor speed (rps)</th> <th rowspan="2">Fan speed</th> <th rowspan="2">Time correction</th> </tr> <tr> <th>B10U2FVG Series</th> <th>B13U2FVG Series</th> <th>B18U2FVG Series</th> </tr> </thead> <tbody> <tr> <td>12</td> <td>35</td> <td>37</td> <td>49</td> <td>W8</td> <td rowspan="6">+1 zone</td> </tr> <tr> <td>11</td> <td>32</td> <td>34</td> <td>42</td> <td>W6</td> </tr> <tr> <td>10</td> <td>30</td> <td>31</td> <td>36</td> <td></td> </tr> <tr> <td>9</td> <td>27</td> <td>28</td> <td>30</td> <td></td> </tr> <tr> <td>8</td> <td>25</td> <td>26</td> <td>24</td> <td></td> </tr> <tr> <td>7</td> <td>22</td> <td>23</td> <td>18</td> <td></td> </tr> <tr> <td>6</td> <td>20</td> <td>20</td> <td>11</td> <td></td> <td rowspan="3">±0</td> </tr> <tr> <td>5</td> <td></td> <td></td> <td></td> <td>W5</td> </tr> <tr> <td>4</td> <td></td> <td></td> <td></td> <td>W4</td> </tr> <tr> <td>3</td> <td></td> <td></td> <td></td> <td></td> <td rowspan="2">-1 zone (min 1)</td> </tr> <tr> <td>2</td> <td></td> <td></td> <td></td> <td></td> </tr> <tr> <td>1</td> <td></td> <td></td> <td></td> <td></td> <td></td> </tr> <tr> <td>0</td> <td>OFF</td> <td>OFF</td> <td>OFF</td> <td></td> <td></td> </tr> </tbody> </table>	Zone	Compressor speed (rps)			Fan speed	Time correction	B10U2FVG Series	B13U2FVG Series	B18U2FVG Series	12	35	37	49	W8	+1 zone	11	32	34	42	W6	10	30	31	36		9	27	28	30		8	25	26	24		7	22	23	18		6	20	20	11		±0	5				W5	4				W4	3					-1 zone (min 1)	2					1						0	OFF	OFF	OFF			<ol style="list-style-type: none"> <li>1) Detects the room temperature (TA) when the DRY operation started.</li> <li>2) Starts operation under conditions in the left figure according to the temperature difference between the room temperature and the setup temperature (Tsc). Setup temperature (Tsc) = Set temperature on remote controller (Ts) + (-1.0 to 0.0)</li> <li>3) When the room temperature is lower 2°C or less than the setup temperature, turn off the compressor.</li> <li>4) The time correction is performed every 8 minutes.</li> </ol>
Zone	Compressor speed (rps)			Fan speed	Time correction																																																																												
	B10U2FVG Series	B13U2FVG Series	B18U2FVG Series																																																																														
12	35	37	49	W8	+1 zone																																																																												
11	32	34	42	W6																																																																													
10	30	31	36																																																																														
9	27	28	30																																																																														
8	25	26	24																																																																														
7	22	23	18																																																																														
6	20	20	11		±0																																																																												
5				W5																																																																													
4				W4																																																																													
3					-1 zone (min 1)																																																																												
2																																																																																	
1																																																																																	
0	OFF	OFF	OFF																																																																														

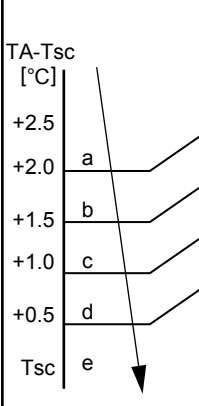
Item	Operation flow and applicable data, etc.	Description																																																																																																																																																																								
<p><b>2. Indoor fan motor control</b></p> 	<p><b>&lt;In cooling operation&gt;</b>                      (This operation controls the fan speed at indoor unit side.)                      The indoor fan (cross flow fan) is operated by the phase-control induction motor. The fan rotates in 5 stages in MANUAL mode, and in 5 stages in AUTO mode, respectively. (Table 1)</p> <p style="text-align: right;">(Fig. 1)</p> <table border="1" data-bbox="475 645 1007 898"> <thead> <tr> <th>Indication</th> <th>Fan speed</th> <th>Hi-POWER</th> </tr> </thead> <tbody> <tr> <td>L </td> <td>W7</td> <td>W8</td> </tr> <tr> <td>L+ </td> <td>(L + M) / 2</td> <td>(L + M) / 2</td> </tr> <tr> <td>M </td> <td>WA</td> <td>WC</td> </tr> <tr> <td>M+ </td> <td>(M + H) / 2</td> <td>(M + H) / 2</td> </tr> <tr> <td>H </td> <td>WD</td> <td>WE</td> </tr> </tbody> </table> <p style="text-align: right;">(Fig. 2)</p>	Indication	Fan speed	Hi-POWER	L 	W7	W8	L+ 	(L + M) / 2	(L + M) / 2	M 	WA	WC	M+ 	(M + H) / 2	(M + H) / 2	H 	WD	WE	<div style="border: 1px solid black; padding: 5px; margin-bottom: 10px;"> <p><b>* Symbols</b></p> <p>UH : Ultra High                      H : High                      M+ : Medium+                      M : Medium                      L+ : Low+                      L : Low                      L- : Low-                      UL : Ultra Low                      SUL : Super Ultra Low</p> </div> <p>* The fan speed broadly varies due to position of the louver, etc.                      The described value indicates one under condition of inclining downward blowing.</p> <p>1) When setting the fan speed to L, L+, M, M+ or H on the remote controller, the operation is performed with the constant speed shown in Fig. 1.</p> <p>2) When setting the fan speed to AUTO on the remote controller, revolution of the fan motor is controlled to the fan speed level shown in Fig. 2 and Table 1 according to the setup temperature, room temperature, and heat exchanger temperature.</p>																																																																																																																																																						
Indication	Fan speed	Hi-POWER																																																																																																																																																																								
L 	W7	W8																																																																																																																																																																								
L+ 	(L + M) / 2	(L + M) / 2																																																																																																																																																																								
M 	WA	WC																																																																																																																																																																								
M+ 	(M + H) / 2	(M + H) / 2																																																																																																																																																																								
H 	WD	WE																																																																																																																																																																								
	<table border="1" data-bbox="438 1003 646 1388"> <thead> <tr> <th>Fan speed</th> <th>Hi Power</th> </tr> </thead> <tbody> <tr> <td>M+(WC)</td> <td>H+(WD)</td> </tr> <tr> <td>*3</td> <td>*6</td> </tr> <tr> <td>*4</td> <td>*7</td> </tr> <tr> <td>*5</td> <td>*8</td> </tr> <tr> <td>L(W7)</td> <td>L+(W8)</td> </tr> </tbody> </table> <p>*3 : Fan speed = (M + L) x 3/4 + L                      *4 : Fan speed = (M + L) x 2/4 + L                      *5 : Fan speed = (M + L) x 1/4 + L                      (Linear approximation from M+ and L)                      *6 : Fan speed = (H - L+) x 3/4 + L+                      *7 : Fan speed = (H - L+) x 2/4 + L+                      *8 : Fan speed = (H - L+) x 1/4 + L+                      (Linear approximation from H and L+)</p>	Fan speed	Hi Power	M+(WC)	H+(WD)	*3	*6	*4	*7	*5	*8	L(W7)	L+(W8)																																																																																																																																																													
Fan speed	Hi Power																																																																																																																																																																									
M+(WC)	H+(WD)																																																																																																																																																																									
*3	*6																																																																																																																																																																									
*4	*7																																																																																																																																																																									
*5	*8																																																																																																																																																																									
L(W7)	L+(W8)																																																																																																																																																																									
<p><b>(table 1) Indoor fan air flow rate &lt;Cooling&gt;</b></p>																																																																																																																																																																										
<table border="1" data-bbox="156 1507 295 2067"> <thead> <tr> <th>Fan speed level</th> <th>Cool</th> </tr> </thead> <tbody> <tr><td>WF</td><td></td></tr> <tr><td>WE</td><td>UH</td></tr> <tr><td>WD</td><td>H</td></tr> <tr><td>WC</td><td>M+</td></tr> <tr><td>WB</td><td></td></tr> <tr><td>WA</td><td>M</td></tr> <tr><td>W9</td><td></td></tr> <tr><td>W8</td><td>L+</td></tr> <tr><td>W7</td><td>L</td></tr> <tr><td>W6</td><td>L-</td></tr> <tr><td>W5</td><td>UL</td></tr> <tr><td>W4</td><td></td></tr> <tr><td>W3</td><td>SUL</td></tr> <tr><td>W2</td><td></td></tr> <tr><td>W1</td><td></td></tr> </tbody> </table>	Fan speed level	Cool	WF		WE	UH	WD	H	WC	M+	WB		WA	M	W9		W8	L+	W7	L	W6	L-	W5	UL	W4		W3	SUL	W2		W1		<table border="1" data-bbox="368 1507 1098 2067"> <thead> <tr> <th colspan="2"></th> <th colspan="2">RAS-B10U2FVG Series</th> <th colspan="2">RAS-B13U2FVG Series</th> <th colspan="2">RAS-B18U2FVG Series</th> </tr> <tr> <th>Fan speed (rpm)</th> <th>Air flow rate (m3/h)</th> <th>Fan speed (rpm)</th> <th>Air flow rate (m3/h)</th> <th>Fan speed (rpm)</th> <th>Air flow rate (m3/h)</th> <th>Fan speed (rpm)</th> <th>Air flow rate (m3/h)</th> </tr> </thead> <tbody> <tr><td>530</td><td>498</td><td>560</td><td>528</td><td>650</td><td>624</td><td></td><td></td></tr> <tr><td>530</td><td>498</td><td>560</td><td>528</td><td>650</td><td>624</td><td></td><td></td></tr> <tr><td>500</td><td>468</td><td>540</td><td>510</td><td>630</td><td>600</td><td></td><td></td></tr> <tr><td>450</td><td>414</td><td>490</td><td>459</td><td>560</td><td>528</td><td></td><td></td></tr> <tr><td>450</td><td>414</td><td>490</td><td>459</td><td>560</td><td>528</td><td></td><td></td></tr> <tr><td>400</td><td>366</td><td>440</td><td>408</td><td>500</td><td>468</td><td></td><td></td></tr> <tr><td>360</td><td>324</td><td>390</td><td>354</td><td>450</td><td>414</td><td></td><td></td></tr> <tr><td>350</td><td>315</td><td>390</td><td>354</td><td>450</td><td>414</td><td></td><td></td></tr> <tr><td>300</td><td>258</td><td>340</td><td>300</td><td>400</td><td>366</td><td></td><td></td></tr> <tr><td>260</td><td>216</td><td>270</td><td>228</td><td>360</td><td>324</td><td></td><td></td></tr> <tr><td>260</td><td>216</td><td>270</td><td>228</td><td>340</td><td>300</td><td></td><td></td></tr> <tr><td>240</td><td>198</td><td>250</td><td>210</td><td>320</td><td>282</td><td></td><td></td></tr> <tr><td>240</td><td>198</td><td>240</td><td>198</td><td>300</td><td>258</td><td></td><td></td></tr> <tr><td>240</td><td>198</td><td>240</td><td>198</td><td>300</td><td>258</td><td></td><td></td></tr> <tr><td>240</td><td>198</td><td>240</td><td>198</td><td>300</td><td>258</td><td></td><td></td></tr> </tbody> </table>			RAS-B10U2FVG Series		RAS-B13U2FVG Series		RAS-B18U2FVG Series		Fan speed (rpm)	Air flow rate (m3/h)	Fan speed (rpm)	Air flow rate (m3/h)	Fan speed (rpm)	Air flow rate (m3/h)	Fan speed (rpm)	Air flow rate (m3/h)	530	498	560	528	650	624			530	498	560	528	650	624			500	468	540	510	630	600			450	414	490	459	560	528			450	414	490	459	560	528			400	366	440	408	500	468			360	324	390	354	450	414			350	315	390	354	450	414			300	258	340	300	400	366			260	216	270	228	360	324			260	216	270	228	340	300			240	198	250	210	320	282			240	198	240	198	300	258			240	198	240	198	300	258			240	198	240	198	300	258			
Fan speed level	Cool																																																																																																																																																																									
WF																																																																																																																																																																										
WE	UH																																																																																																																																																																									
WD	H																																																																																																																																																																									
WC	M+																																																																																																																																																																									
WB																																																																																																																																																																										
WA	M																																																																																																																																																																									
W9																																																																																																																																																																										
W8	L+																																																																																																																																																																									
W7	L																																																																																																																																																																									
W6	L-																																																																																																																																																																									
W5	UL																																																																																																																																																																									
W4																																																																																																																																																																										
W3	SUL																																																																																																																																																																									
W2																																																																																																																																																																										
W1																																																																																																																																																																										
		RAS-B10U2FVG Series		RAS-B13U2FVG Series		RAS-B18U2FVG Series																																																																																																																																																																				
Fan speed (rpm)	Air flow rate (m3/h)	Fan speed (rpm)	Air flow rate (m3/h)	Fan speed (rpm)	Air flow rate (m3/h)	Fan speed (rpm)	Air flow rate (m3/h)																																																																																																																																																																			
530	498	560	528	650	624																																																																																																																																																																					
530	498	560	528	650	624																																																																																																																																																																					
500	468	540	510	630	600																																																																																																																																																																					
450	414	490	459	560	528																																																																																																																																																																					
450	414	490	459	560	528																																																																																																																																																																					
400	366	440	408	500	468																																																																																																																																																																					
360	324	390	354	450	414																																																																																																																																																																					
350	315	390	354	450	414																																																																																																																																																																					
300	258	340	300	400	366																																																																																																																																																																					
260	216	270	228	360	324																																																																																																																																																																					
260	216	270	228	340	300																																																																																																																																																																					
240	198	250	210	320	282																																																																																																																																																																					
240	198	240	198	300	258																																																																																																																																																																					
240	198	240	198	300	258																																																																																																																																																																					
240	198	240	198	300	258																																																																																																																																																																					



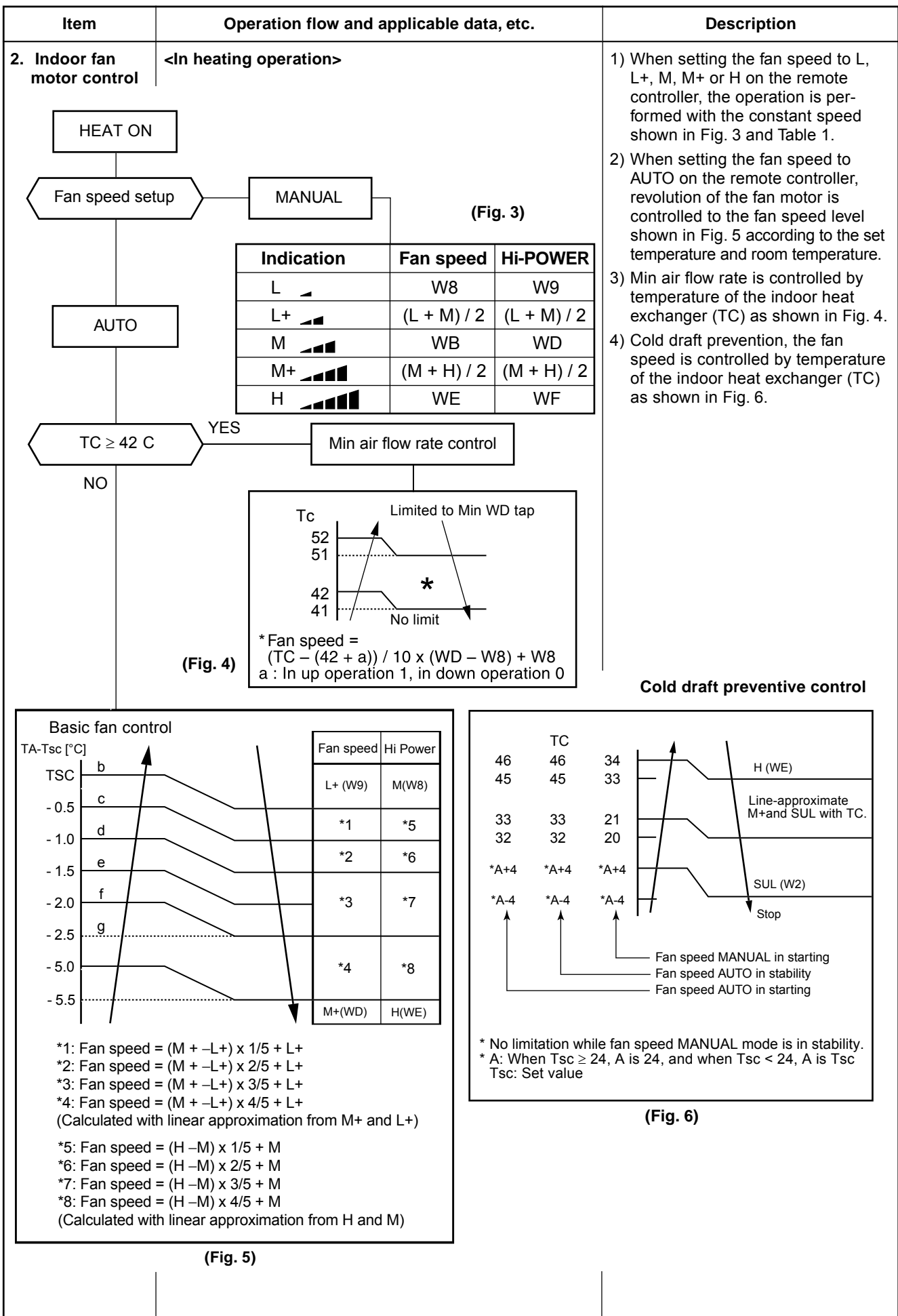

Item	Operation flow and applicable data, etc.	Description
<b>[In starting and in stability]</b>		
	<b>In starting</b>	<b>In stability</b>
FAN AUTO	<ul style="list-style-type: none"> <li>• Until 12 minutes passed after operation start</li> <li>• When 12 to 25 minutes passed after operation start and room temp. is 3°C or lower than set temp.</li> </ul>	<ul style="list-style-type: none"> <li>• When 12 to 25 minutes passed after operation start and room temp. is higher than (set temp. -3°C)</li> <li>• When 25 minutes or more passed after operation start</li> </ul>
FAN Manual	• Room temp. < Set temp. -4°C	• Room temp. = Set temp. -3.5°C

**(Table 2) Indoor fan air flow rate <Heating>**

Fan speed level	HEAT	RAS-B10U2FVG Series		RAS-B13U2FVG Series		RAS-B18U2FVG Series	
		Fan speed (rpm)	Air flow rate (m3/h)	Fan speed (rpm)	Air flow rate (m3/h)	Fan speed (rpm)	Air flow rate (m3/h)
WF	UH	560	528	600	570	690	666
WE	H	540	510	580	552	670	642
WD	M+	480	443	520	486	590	570
WC		440	408	470	435	570	540
WB	M	430	399	460	426	520	486
WA		380	342	410	376	460	426
W9	L+	370	334	400	366	460	426
W8	L	320	282	340	300	400	366
W7	L-	260	216	270	228	360	324
W6		260	216	270	228	340	300
W5	UL	260	216	270	228	340	300
W4		260	216	270	228	340	300
W3		260	216	270	228	340	300
W2	SUL	240	198	250	210	320	282
W1		240	198	240	198	240	198

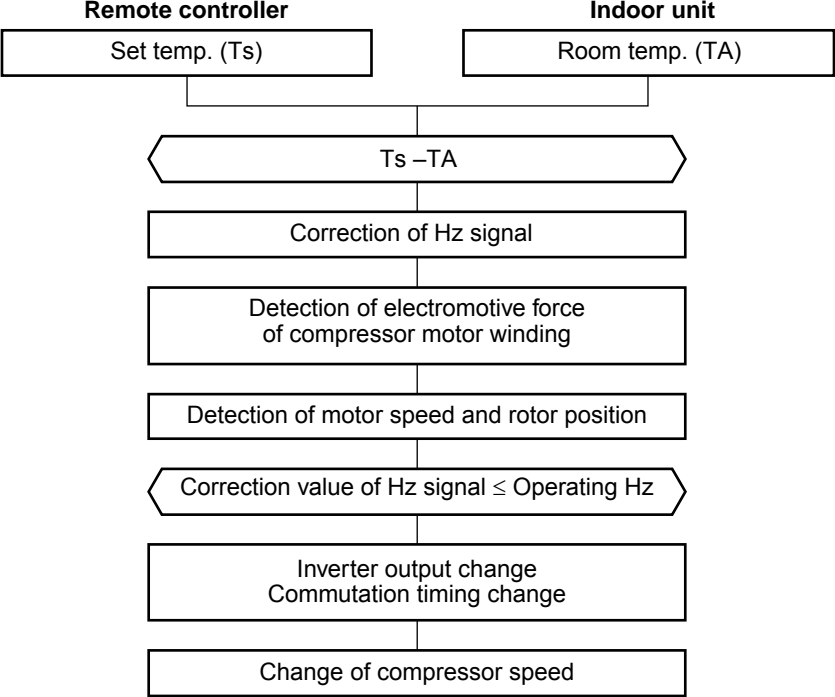
Item	Operation flow and applicable data, etc.	Description
<p><b>3. Capacity control</b></p>	<p>The cooling or heating capacity depending on the load is adjusted.</p> <p>According to difference between the setup value of temperature and the room temperature, the capacity is adjusted by the compressor revolution.</p>  <pre> graph TD     subgraph Remote_controller [Remote controller]         Ts[Set temp. (Ts)]     end     subgraph Indoor_unit [Indoor unit]         TA[Room temp. (TA)]     end     Ts --- Diff[Ts - TA]     TA --- Diff     Diff --&gt; Hz[Correction of Hz signal]     Hz --&gt; EMF[Detection of electromotive force of compressor motor winding]     EMF --&gt; Speed[Detection of motor speed and rotor position]     Speed --&gt; Hz2[Correction value of Hz signal ≤ Operating Hz]     Hz2 --&gt; Inverter[Inverter output change Commutation timing change]     Inverter --&gt; Speed2[Change of compressor speed]     </pre>	<ol style="list-style-type: none"> <li>1) The difference between set temperature on remote controller (Ts) and room temperature (TA) is calculated.</li> <li>2) According to the temperature difference, the correction value of Hz signal which determines the compressor speed is set up.</li> <li>3) The rotating position and speed of the motor are detected by the electromotive force occurred on the motor winding with operation of the compressor.</li> <li>4) According to the difference resulted from comparison of the correction value of Hz signal with the present operation Hz, the inverter output and the commutation timing are varied.</li> <li>5) Change the compressor motor speed by outputting power to the compressor.</li> </ol> <p>* The contents of control operation are same in cooling operation and heating operation</p>
<p><b>4. Current release control</b></p>	<p>Please refer "Current release control" of outdoor unit service manual.</p>	
<p><b>5. Defrost control (Only in heating operation)</b></p>	<p>* Refer to the service manual of multi outdoor unit to be combined.</p>	

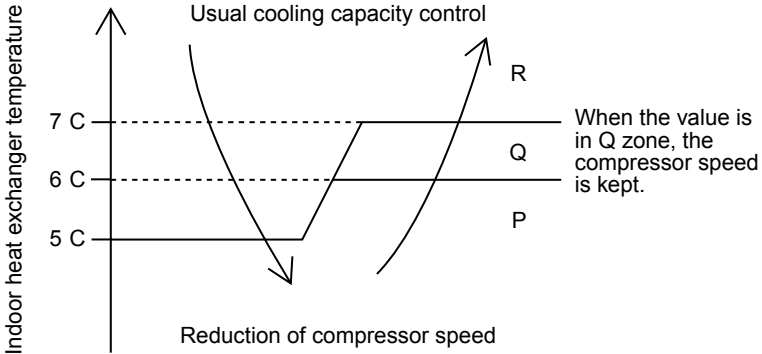
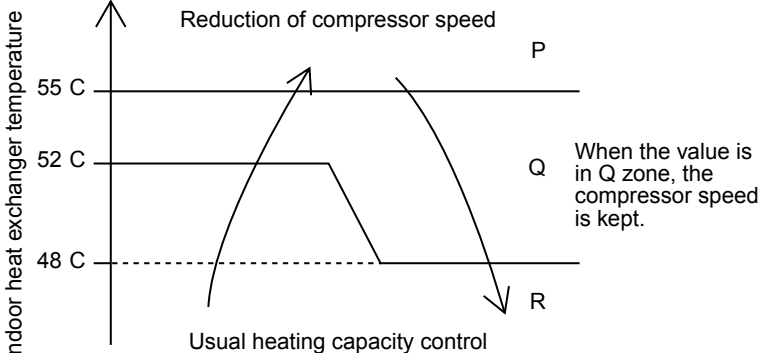
Item	Operation flow and applicable data, etc.	Description
<p><b>6. Release protective control by temperature of indoor heat exchanger</b></p>	<p><b>&lt;In cooling/dry operation&gt;</b>                      (Prevent-freezing control for indoor heat exchanger)                      In cooling/dry operation, the sensor of indoor heat exchanger detects evaporation temperature and controls the compressor speed so that temperature of the heat exchanger does not exceed the specified value.</p> 	<ol style="list-style-type: none"> <li>1) When temperature of the indoor heat exchanger drops below 5°C, the compressor speed is reduced. (P zone)</li> <li>2) When temperature of the indoor heat exchanger rises in the range from 6°C to under 7°C, the compressor speed is kept. (Q zone)</li> <li>3) When temperature of the indoor heat exchanger rises to 7°C or higher, the capacity control operation returns to the usual control in cooling operation. (R zone)</li> </ol>
	<p><b>&lt;In heating operation&gt;</b>                      (Prevent-overpressure control for refrigerating cycle)                      In heating operation, the sensor of indoor heat exchanger detects condensation temperature and controls the compressor speed so that temperature of the heat exchanger does not exceed the specified value.</p> 	<ol style="list-style-type: none"> <li>1) When temperature of the indoor heat exchanger rises in the range from 50°C to 55°C, the compressor speed is kept. (Q zone)                      When temperature of the indoor heat exchanger drops in the range from 46°C to under 55°C, the compressor speed is kept. (Q zone)</li> <li>2) When temperature of the indoor heat exchanger rises to 55°C or higher, the compressor speed is reduced. (P zone)</li> <li>3) When temperature of the indoor heat exchanger does not rise to 50°C, or when it drops below to 46°C, the capacity control operation returns to the usual control in heating operation. (R zone)</li> </ol>

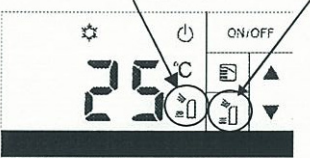
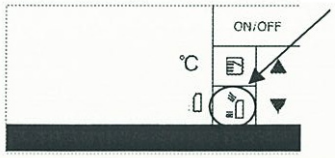
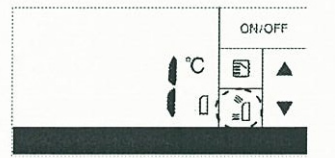
Item	Operation flow and applicable data,etc	Description																												
<p><b>7. Air outlet selection</b></p>	<p>&lt; How to change air outlet selection &gt;</p> <ol style="list-style-type: none"> <li>Operate the air conditioner and select cooling or heating mode. (Air outlet selection can't be changed at standby mode.)</li> <li>Push AIR OUTLET SELECT button on the unit operation panel to change air outlet selection.</li> </ol> <p>AIR OUTLET indication      AIR OUTLET SELECT button</p>  <p>Air outlet is controlled as below.</p> <table border="1" data-bbox="159 728 981 1400"> <thead> <tr> <th rowspan="2">AIR OUTLET indicator</th> <th colspan="4">Mode</th> </tr> <tr> <th colspan="2">Cooling</th> <th>Dry mode</th> <th colspan="2">Heating</th> </tr> </thead> <tbody> <tr> <td>Bi-flow</td> <td><math>TA &gt; T_{sc} + 1^{\circ}C</math></td> <td><math>TA \leq T_{sc} + 1^{\circ}C</math> or (<math>TA \leq T_{sc} + 1.5</math> and after 1 hour running)</td> <td>/</td> <td><math>TC &lt; 33^{\circ}C</math></td> <td><math>TC \geq 33^{\circ}C</math></td> </tr> <tr> <td>Upper flow</td> <td></td> <td></td> <td></td> <td></td> <td></td> </tr> <tr> <td>Lower-flow</td> <td>/</td> <td>/</td> <td>/</td> <td></td> <td></td> </tr> </tbody> </table>	AIR OUTLET indicator	Mode				Cooling		Dry mode	Heating		Bi-flow	$TA > T_{sc} + 1^{\circ}C$	$TA \leq T_{sc} + 1^{\circ}C$ or ( $TA \leq T_{sc} + 1.5$ and after 1 hour running)	/	$TC < 33^{\circ}C$	$TC \geq 33^{\circ}C$	Upper flow						Lower-flow	/	/	/			<ol style="list-style-type: none"> <li>Purpose</li> <li>Description</li> </ol> <ul style="list-style-type: none"> <li>In Cooling operation, only lower-flow can't be selected.</li> <li>In Dry mode operation, bi-flow and lower-flow can't be selected.</li> <li>In heating operation and bi-flow setting, the air outlet is set only upper flow for preventing cold draft when the indoor heat exchanger sensor temperature (TC) is lower than 33 degrees.</li> <li>In cooling operation and bi-flow setting, the air outlet is set only upper flow for preventing the room from overcooling when the room temperature (TA) is nearing the setup temperature. This function can be cancelled to change setting.</li> </ul>
AIR OUTLET indicator	Mode																													
	Cooling		Dry mode	Heating																										
Bi-flow	$TA > T_{sc} + 1^{\circ}C$	$TA \leq T_{sc} + 1^{\circ}C$ or ( $TA \leq T_{sc} + 1.5$ and after 1 hour running)	/	$TC < 33^{\circ}C$	$TC \geq 33^{\circ}C$																									
Upper flow																														
Lower-flow	/	/	/																											
	<p>&lt; How to cancel to change upper-flow at Bi-flow setting in cooling &gt;</p> <ol style="list-style-type: none"> <li>Stop operation.</li> <li>Push and hold AIR OUTLET SELECT button on the unit operation panel over 10seconds (less than 20seconds).</li> </ol> <p>AIR OUTLET SELECT button</p>  <ol style="list-style-type: none"> <li>After holding 10seconds, 4 beep sounds in heard and TEMPERATURE indicator displays "1" for 5seconds. Release AIR OUTLET SELECT button.</li> </ol> 																													

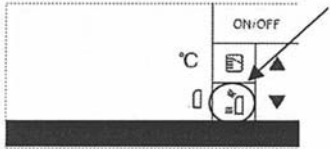
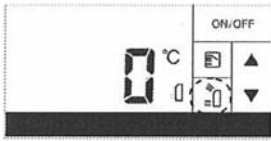
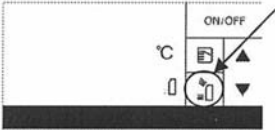
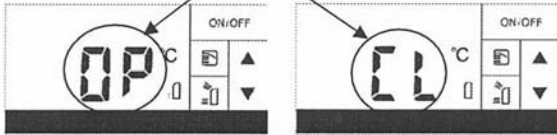
Item	Operation flow and applicable data,etc	Description															
<p><b>7. Air outlet selection</b></p>	<p>&lt; How to set to change upper-flow at Bi-flow setting in cooling</p> <ol style="list-style-type: none"> <li>1. Stop operation.</li> <li>2. Push and hold AIR OUTLET SELECT button on the unit operation panel over 10seconds (less than 20seconds).</li> </ol> <p style="text-align: center;">AIR OUTLET SELECT button</p>  <ol style="list-style-type: none"> <li>3. After holding 10seconds, 4 beep sounds in heard and TEMPERATURE indicator displays "1" for 5seconds. Release AIR OUTLET SELECT button.</li> </ol> 																
<p><b>8. Lower air outlet louver control</b></p>	<p>&lt; How to open or close the lower louver at standby mode &gt;</p> <ol style="list-style-type: none"> <li>1. Push AIR OUTLET SELECT button on the unit operation panel.</li> </ol> <p style="text-align: center;">AIR OUTLET SELECT button</p>  <ol style="list-style-type: none"> <li>2. When lower louver is closed, lower louver moves to open position and TEMPERATURE indicator displays "OP" (OPEN) during louver moving.</li> </ol> <p>When lower louver is opened, lower louver moves to open position and TEMPERATURE indicator displays "CL" (CLOSE) during louver moving.</p> <p>&lt;Close-&gt;Open&gt;                      &lt;Open-&gt;Close&gt;</p> <p style="text-align: center;">TEMPERATURE indicator</p>  <p>&lt; Louver position in operation &gt;</p> <p>Lower louver is controlled in operation as below.</p> <table border="1" data-bbox="395 1816 900 2069"> <thead> <tr> <th rowspan="2">Louver Position</th> <th colspan="3">Air outlet</th> </tr> <tr> <th>Bi-flow</th> <th>Upper-flow</th> <th>Lower-flow</th> </tr> </thead> <tbody> <tr> <td>OPEN</td> <td></td> <td></td> <td></td> </tr> <tr> <td>CLOSE</td> <td></td> <td></td> <td></td> </tr> </tbody> </table>	Louver Position	Air outlet			Bi-flow	Upper-flow	Lower-flow	OPEN				CLOSE				<ol style="list-style-type: none"> <li>1. Purpose When something is dropped to inside of the unit from upper air outlet, this function helps to remove something from lower air outlet</li> </ol>
Louver Position	Air outlet																
	Bi-flow	Upper-flow	Lower-flow														
OPEN																	
CLOSE																	

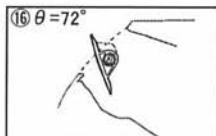
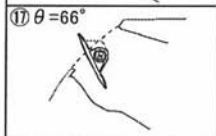
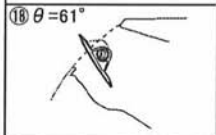
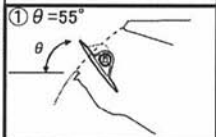
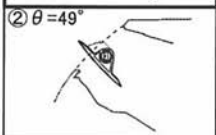
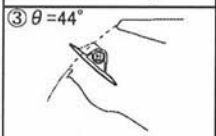
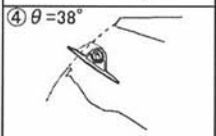
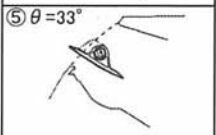
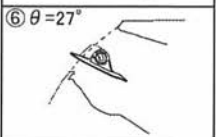
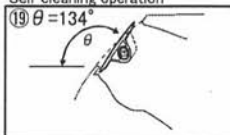
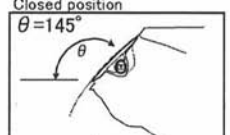
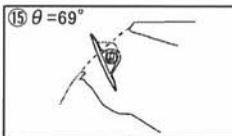
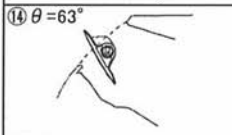
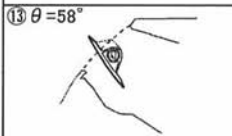
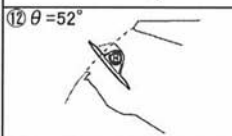
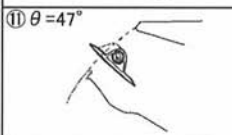
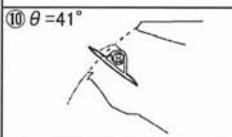
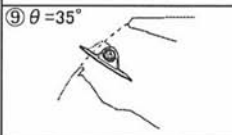
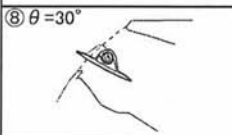
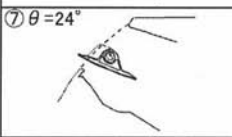
Item	Operation flow and applicable data,etc	Description												
<p><b>9. Upper air outlet louver control</b></p>	<p>Upper louver position can be arbitrarily set pu by pushing [FIX] button of the remote control.</p> <p>The position is controlled as below.</p>	<p>1. Description</p> <ul style="list-style-type: none"> <li>Upper louver position is stored in memory by the microcomputer, and the louver returns to the stored position when the next operation is performed. (Cooling/heating memory position)</li> </ul>												
<table border="1" style="width:100%; border-collapse: collapse;"> <thead> <tr> <th style="width:30%;">Mode</th> <th>louver position</th> </tr> </thead> <tbody> <tr> <td>Cooling</td> <td>①→②→③→④→⑤→⑥→⑦→⑧→⑨→⑩→⑪→⑫→①.....</td> </tr> <tr> <td>Heating</td> <td>①→②→③→④→⑤→⑥→⑦→⑧→⑨→⑩→⑪→⑫→⑬→⑭→⑮→⑯→⑰→⑱→①...</td> </tr> <tr> <td>Cooling (Consealed setting)</td> <td>②→③→④→⑤→⑥→⑦→⑧→⑨→⑩→⑪→⑫→②.....</td> </tr> <tr> <td>Heating (Consealed setting)</td> <td>②→③→④→⑤→⑥→⑦→⑧→⑨→⑩→⑪→⑫→②.....</td> </tr> <tr> <td>Self cleaning</td> <td>⑱</td> </tr> </tbody> </table>			Mode	louver position	Cooling	①→②→③→④→⑤→⑥→⑦→⑧→⑨→⑩→⑪→⑫→①.....	Heating	①→②→③→④→⑤→⑥→⑦→⑧→⑨→⑩→⑪→⑫→⑬→⑭→⑮→⑯→⑰→⑱→①...	Cooling (Consealed setting)	②→③→④→⑤→⑥→⑦→⑧→⑨→⑩→⑪→⑫→②.....	Heating (Consealed setting)	②→③→④→⑤→⑥→⑦→⑧→⑨→⑩→⑪→⑫→②.....	Self cleaning	⑱
Mode	louver position													
Cooling	①→②→③→④→⑤→⑥→⑦→⑧→⑨→⑩→⑪→⑫→①.....													
Heating	①→②→③→④→⑤→⑥→⑦→⑧→⑨→⑩→⑪→⑫→⑬→⑭→⑮→⑯→⑰→⑱→①...													
Cooling (Consealed setting)	②→③→④→⑤→⑥→⑦→⑧→⑨→⑩→⑪→⑫→②.....													
Heating (Consealed setting)	②→③→④→⑤→⑥→⑦→⑧→⑨→⑩→⑪→⑫→②.....													
Self cleaning	⑱													
<div style="display: flex; justify-content: space-between; align-items: flex-start;"> <div style="width: 45%;"> <p>Upper limit (Heating) ⑱ <math>\theta = 72^\circ</math></p>  <p>⑰ <math>\theta = 66^\circ</math></p>  <p>⑱ <math>\theta = 61^\circ</math></p>  <p>Upper limit (Cooling) Cooling position Heating position ① <math>\theta = 55^\circ</math></p>  <p>Upper limit (Consealed) ② <math>\theta = 49^\circ</math></p>  <p>③ <math>\theta = 44^\circ</math></p>  <p>Maximum Air flow volume ④ <math>\theta = 38^\circ</math></p>  <p>⑤ <math>\theta = 33^\circ</math></p>  <p>⑥ <math>\theta = 27^\circ</math></p>  </div> <div style="width: 45%; text-align: center;"> <p>Heating</p> <p>Cooling</p> <p>Consealed setting</p> <p>Lower limit</p> </div> <div style="width: 45%; text-align: right;"> <p>Self cleaning operation ⑱ <math>\theta = 134^\circ</math></p>  <p>Closed position <math>\theta = 145^\circ</math></p>  </div> </div> <div style="display: flex; justify-content: space-around; margin-top: 20px;"> <div style="width: 45%;"> <p>⑮ <math>\theta = 69^\circ</math></p>  <p>⑭ <math>\theta = 63^\circ</math></p>  <p>⑬ <math>\theta = 58^\circ</math></p>  <p>⑫ <math>\theta = 52^\circ</math></p>  <p>⑪ <math>\theta = 47^\circ</math></p>  <p>⑩ <math>\theta = 41^\circ</math></p>  <p>⑨ <math>\theta = 35^\circ</math></p>  <p>⑧ <math>\theta = 30^\circ</math></p>  <p>⑦ <math>\theta = 24^\circ</math></p>  </div> </div>														

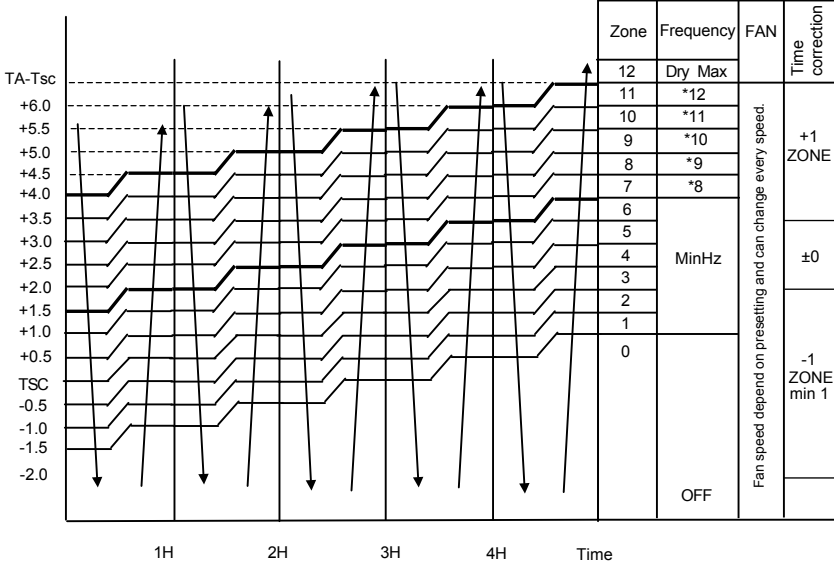
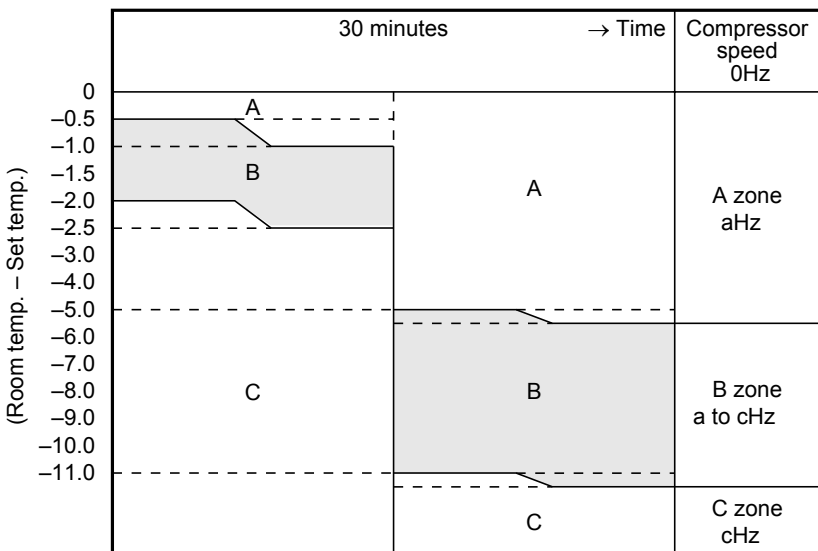
Item	Operation flow and applicable data, etc.	Description																								
<p><b>10. ECO operation</b></p>	<p>When pressing [ECO] button on the remote controller, a Economic operation is performed.</p> <p><b>&lt;Cooling operation&gt;</b></p> <p>This function operates the air conditioner with the difference between the set and the room temperature as shown in the following figure.</p>  <p style="text-align: center;">1H      2H      3H      4H      Time</p> <p style="text-align: center;">* 12 (DRY max - COOL min) /6 x 5 + COOL min                      * 11 (DRY max - COOL min) /6 x 4 + COOL min                      * 10 (DRY max - COOL min) /6 x 3 + COOL min                      * 9 (DRY max - COOL min) /6 x 2 + COOL min                      * 8 (DRY max - COOL min) /6 x 1 + COOL min</p> <table border="1" data-bbox="475 1198 1005 1332"> <thead> <tr> <th>Hz</th> <th>RAS-B10U2FVG Series</th> <th>RAS-B13U2FVG Series</th> <th>RAS-B18U2FVG Series</th> </tr> </thead> <tbody> <tr> <td>Cool min</td> <td>20</td> <td>20</td> <td>11</td> </tr> <tr> <td>DRY max</td> <td>35</td> <td>37</td> <td>49</td> </tr> </tbody> </table> <p><b>&lt;Heating operation&gt;</b></p>  <table border="1" data-bbox="481 1937 1005 2072"> <thead> <tr> <th>Hz</th> <th>RAS-B10U2FVG Series</th> <th>RAS-B13U2FVG Series</th> <th>RAS-B18U2FVG Series</th> </tr> </thead> <tbody> <tr> <td>a</td> <td>20</td> <td>20</td> <td>15</td> </tr> <tr> <td>c</td> <td>50</td> <td>50</td> <td>68</td> </tr> </tbody> </table>	Hz	RAS-B10U2FVG Series	RAS-B13U2FVG Series	RAS-B18U2FVG Series	Cool min	20	20	11	DRY max	35	37	49	Hz	RAS-B10U2FVG Series	RAS-B13U2FVG Series	RAS-B18U2FVG Series	a	20	20	15	c	50	50	68	<p><b>&lt;Cooling operation&gt;</b></p> <ol style="list-style-type: none"> <li>1) The control target temperature increase 0.5°C per hour up to 2°C starting from the set temperature when ECONO has been received.</li> <li>2) The indoor fan speed is depend on presetting and can change every speed after setting ECO operation.</li> <li>3) The compressor speed is controlled as shown in the left figure.</li> <li>4) The time correction is performed every 8minutes.</li> </ol> <p><b>&lt;Heating operation&gt;</b></p> <ol style="list-style-type: none"> <li>1) Setting the compressor speed to Max. aHz, the temperature zone in which the operation can be performed with Max. cHz is gradually widened after 30 minutes passed when starting ECO operation.</li> <li>2) The indoor fan speed is depend on presetting and can change every speed after setting ECO operation.</li> </ol>
Hz	RAS-B10U2FVG Series	RAS-B13U2FVG Series	RAS-B18U2FVG Series																							
Cool min	20	20	11																							
DRY max	35	37	49																							
Hz	RAS-B10U2FVG Series	RAS-B13U2FVG Series	RAS-B18U2FVG Series																							
a	20	20	15																							
c	50	50	68																							



Item	Operation flow and applicable data, etc.	Description
<p><b>11. Test operation</b></p>	<p>When keeping [OPERATION] button pressed for 10 seconds or more, the temporary [COOL] operation is performed.</p> <pre> graph TD     A[Filter lamp ON] -- YES --&gt; B[Press [OPERATION] button.]     B --&gt; A     A -- NO --&gt; C{Did you press [OPERATION] button for 3 seconds or more?}     C -- NO --&gt; D[Previous setting operation]     C -- YES --&gt; E{Did you press [OPERATION] button for 10 seconds or more?}     E -- YES --&gt; F[Test [COOL] Operation]     E -- NO --&gt; G[Switch to [AUTO RESTART] control.]     </pre>	<ol style="list-style-type: none"> <li>1) When pressing [OPERATION] button, the previous setting operation starts.</li> <li>2) When keeping [OPERATION] button pressed for 3 seconds or more, Pi, Pi, Pi sound is heard and [AUTO RESTART] control is changed.</li> <li>3) When keeping [OPERATION] button pressed for 10 seconds or more, "Pi" sound is heard and the test [COOL] operation starts.</li> <li>4) If the filter lamp goes on, press [OPERATION] button to go off the filter lamp, and then press [OPERATION] button again.</li> <li>5) To stop the test operation, press the button again.</li> </ol>
<p><b>12. Discharge temperature control</b></p> <p style="text-align: center;">* Refer to the service manual of multi outdoor unit to be combined.</p>		

Item	Operation flow and applicable data, etc.	Description
<p><b>13. Pulse Modulating value (P.M.V.) control</b></p>	<p>This function controls throttle amount of the refrigerant in the refrigerating cycle. According to operating status of the air conditioner, this function also controls the open degree of valve with an expansion valve with pulse Modulation.</p> <pre> graph TD     Start[Starting up] --&gt; Init[Initialize]     Init --&gt; Move[Move to initial position]     Move --&gt; Comp[Compressor ON]     Comp --&gt; SH[*SH control]     Comp --&gt; Td[Td release control]     SH --&gt; PMV[*PMV open degree control]     Td --&gt; PMV     PMV --&gt; Remote[Stop by remote controller]     PMV --&gt; Room[Room temp. sensor (Ta sensor) control]     Remote --&gt; Power[Power OFF]     Room --&gt; Defrost[Defrost]     Defrost --&gt; Move     </pre> <p>* SH (Super Heat amount) = TS (Temperature of suction pipe of the compressor) – TC or TE (Heat exchanger temperature at evaporation side)</p> <p>* PMV: Pulse Modulating Valve</p>	<ol style="list-style-type: none"> <li>1) When starting the operation, move the valve once until it fits to the stopper. (Initialize) In this time, "Click" sound may be heard.</li> <li>2) Adjust the open degree of valve by super heat amount. (SH control)</li> <li>3) If the discharge temperature was excessively up, adjust the open degree of valve so that it is in the range of set temperature. (Discharge temp. control)</li> <li>4) When defrost operation is performed, the open degree of valve is adjusted according to each setup conditions during preparation for defrost and during defrost operation (4-way valve is inverted.).</li> <li>5) To turn off the compressor while the air conditioner stops by control of the thermostat or by remote controller, adjust the open degree of valve to the setup value before stop of the compressor.</li> </ol>

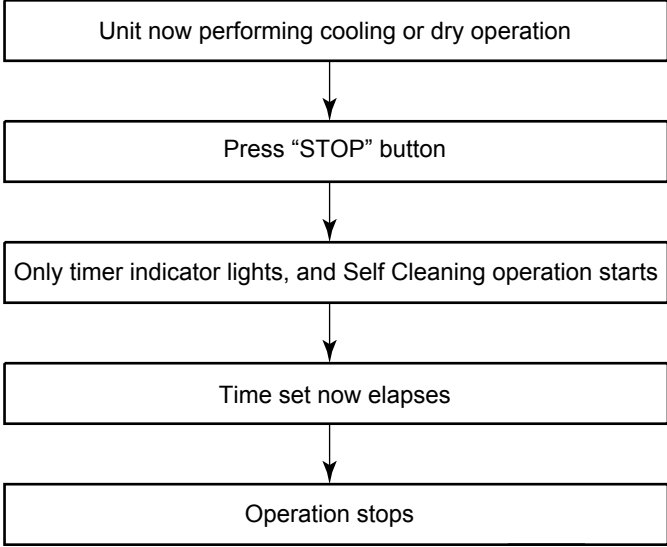
Item	Operation flow and applicable data, etc.	Description													
<p><b>14. Self-Cleaning function</b></p>	 <pre> graph TD     A[Unit now performing cooling or dry operation] --&gt; B[Press "STOP" button]     B --&gt; C[Only timer indicator lights, and Self Cleaning operation starts]     C --&gt; D[Time set now elapses]     D --&gt; E[Operation stops]             </pre> <ul style="list-style-type: none"> <li>• During Self-Cleaning operations: The louver opens slightly. The indoor fan operates continuously at a speed of 240 rpm.</li> </ul> <p>Self-Cleaning operation times</p> <table border="1" data-bbox="397 1227 1262 1576"> <thead> <tr> <th></th> <th>Operation time</th> <th>Self-Cleaning operation time</th> </tr> </thead> <tbody> <tr> <td rowspan="2">Cooling: Auto (cooling) Dry</td> <td>Up to 10 minutes</td> <td>No Self-Cleaning operation performed (0 minutes)</td> </tr> <tr> <td>10 minutes or longer</td> <td>30 mins.</td> </tr> <tr> <td>Heating: Auto (heating)</td> <td colspan="2" rowspan="3">No Self-Cleaning operation performed</td> </tr> <tr> <td>Auto (fan only)</td> </tr> <tr> <td>Shutdown</td> </tr> </tbody> </table> <ul style="list-style-type: none"> <li>• To stop an ongoing Self-Cleaning operation at any time Press the start/stop button on the remote controller twice during the Self-Cleaning operation. (After pressing the button for the first time, press it for the second time without delay (within 10 minutes).)</li> </ul>		Operation time	Self-Cleaning operation time	Cooling: Auto (cooling) Dry	Up to 10 minutes	No Self-Cleaning operation performed (0 minutes)	10 minutes or longer	30 mins.	Heating: Auto (heating)	No Self-Cleaning operation performed		Auto (fan only)	Shutdown	<p><b>1. Purpose</b></p> <p>The Self-Cleaning operation is to minimize the growth of mold, bacteria etc. by running the fan and drying so as to keep the inside of the air conditioner clean.</p> <p><b>Self-Cleaning operation</b></p> <p>When the cooling or dry operation shuts down, the unit automatically starts the Self-Cleaning operation which is then performed for the specified period based on duration of the operation which was performed prior to the shutdown, after which the Self-Cleaning operation stops. (The Self-Cleaning operation is not performed after a heating operation.)</p> <p><b>2. Operation</b></p> <ol style="list-style-type: none"> <li>1) When the stop signal from the remote controller or timer-off function is received, only the timer indicator light.</li> <li>2) The period of the Self-Cleaning operation is determined by the duration of the operation performed prior to the reception of the stop code.</li> <li>3) After the Self-Cleaning operation has been performed for the specified period, the unit stops operating.</li> </ol>
	Operation time	Self-Cleaning operation time													
Cooling: Auto (cooling) Dry	Up to 10 minutes	No Self-Cleaning operation performed (0 minutes)													
	10 minutes or longer	30 mins.													
Heating: Auto (heating)	No Self-Cleaning operation performed														
Auto (fan only)															
Shutdown															

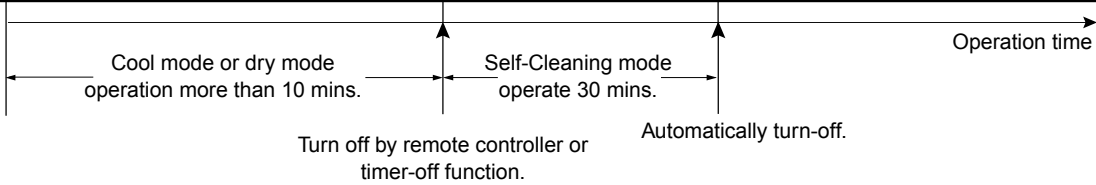
Item	Operation flow and applicable data, etc.	Description																												
<p><b>14. Self-Cleaning function</b></p> <table border="1" data-bbox="156 271 1433 719"> <tr> <td>Operation display</td> <td>ON</td> <td>OFF</td> <td>OFF</td> </tr> <tr> <td>FCU fan</td> <td>ON rpm is depend on presetting.</td> <td>ON (240RPM)</td> <td>OFF</td> </tr> <tr> <td>Upper airoutlet</td> <td>OPEN</td> <td>OPEN (11°)</td> <td>CLOSE</td> </tr> <tr> <td>Lower airoutlet</td> <td>OPEN or CLOSE depend on airoutlet selection</td> <td>OPEN or CLOSE depend on airoutlet selection</td> <td>OPEN or CLOSE depend on airoutlet selection</td> </tr> <tr> <td>Timer display</td> <td>ON or OFF depend on presetting of timer function.</td> <td>ON</td> <td>ON or OFF depend on presetting of timer function.</td> </tr> <tr> <td>Compressor</td> <td>ON or OFF depend on presetting per room temperature.</td> <td>OFF</td> <td>OFF</td> </tr> <tr> <td>CDU fan</td> <td>ON or OFF depend on presetting per room temperature.</td> <td>OFF</td> <td>OFF</td> </tr> </table> 	Operation display	ON	OFF	OFF	FCU fan	ON rpm is depend on presetting.	ON (240RPM)	OFF	Upper airoutlet	OPEN	OPEN (11°)	CLOSE	Lower airoutlet	OPEN or CLOSE depend on airoutlet selection	OPEN or CLOSE depend on airoutlet selection	OPEN or CLOSE depend on airoutlet selection	Timer display	ON or OFF depend on presetting of timer function.	ON	ON or OFF depend on presetting of timer function.	Compressor	ON or OFF depend on presetting per room temperature.	OFF	OFF	CDU fan	ON or OFF depend on presetting per room temperature.	OFF	OFF	<ul style="list-style-type: none"> <li>• Self-Cleaning diagram</li> </ul>	
Operation display	ON	OFF	OFF																											
FCU fan	ON rpm is depend on presetting.	ON (240RPM)	OFF																											
Upper airoutlet	OPEN	OPEN (11°)	CLOSE																											
Lower airoutlet	OPEN or CLOSE depend on airoutlet selection	OPEN or CLOSE depend on airoutlet selection	OPEN or CLOSE depend on airoutlet selection																											
Timer display	ON or OFF depend on presetting of timer function.	ON	ON or OFF depend on presetting of timer function.																											
Compressor	ON or OFF depend on presetting per room temperature.	OFF	OFF																											
CDU fan	ON or OFF depend on presetting per room temperature.	OFF	OFF																											
<p><b>15. Self-Cleaning function release</b></p>	<p><b>How to cancel Self-Cleaning function</b> To cancel the Self-Cleaning function, proceed as follows:</p> <p>Press and hold [MODE] button on operation panel for more than 10 seconds. (less than 20 seconds)</p> <p>After holding about 10 seconds, the air conditioner beep 4 times without any blinking of display.</p> <p>After releasing [Mode] button, Self-Cleaning function is cancelled.</p> <p><b>How to set Self-Cleaning function</b> To set the Self-Cleaning function, proceed as follows:</p> <p>Press and hold [MODE] button on operation panel for more than 10 seconds. (less than 20 seconds)</p> <p>After holding about 10 seconds, the air conditioner beep 4 times and OPERATION display blinks 5 seconds.</p> <p>After releasing [Mode] button, Self-Cleaning function is set.</p>																													

Item	Operation flow and applicable data, etc.	Description
<p><b>16. Remote-A or B selection</b></p>	<p>To separate using of remote control for each indoor unit in case of 2 air conditioner are installed nearby.</p> <p><b>Remote Control B Setup.</b></p> <ol style="list-style-type: none"> <li>1. Push and hold <b>CHK</b> button on the Remote Control by the tip of the pencil. "00" will be shown on the display (Picture ①).</li> <li>2. Press <b>MODE</b> during pushing <b>CHK</b>. "B" will show on the display and "00" will disappear and the air conditioner will turn OFF. The Remote Control B is memorized (Picture ②).</li> </ol> <p>Note : 1. Repeat above step to reset Remote Control to be A. 2. Remote Control A has not "A" display. 3. Default setting of Remote Control from factory is A.</p> <div data-bbox="395 808 911 943" style="text-align: center;"> </div> <p><b>Unit B setup.</b></p> <p>Press and hold <b>MODE</b> button for more than 20 seconds.</p> <p>When A setup changed to B setup : 5 beeps will sound and operation lamp blinks for 5 seconds.</p> <p>When B setup changed to A setup : 5 beep will sound.</p>	<ol style="list-style-type: none"> <li><b>1. Purpose</b> This operation is to operate only one indoor unit using one remote controller.</li> <li><b>2. Description</b> When operating one indoor unit in a situation where two indoor units have been installed in the same room or nearby rooms, this operation prevents the remote control signal from being received simultaneously by both units, thus preventing both units from operating.</li> <li><b>3. Operation</b> The indoor unit on which the remote control selection has been set to B receives the signal of the remote control also set to B. (At the factory the remote controller selection is set to A on all the indoor units. There is no A setting display.)</li> </ol>

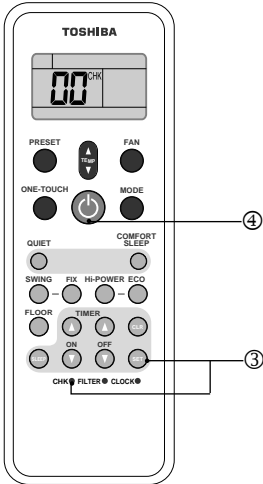
Item	Operation flow and applicable data, etc.	Description
<p><b>17. QUIET mode</b></p>	<p>When the [QUIET] button is pressed, the fan of the indoor unit will be restricted the revolving speed at speed L – until the [QUIET] button is pressed once again (cancel Quiet mode).</p>	<p>Quiet mode is the system which, control the revolving speed of indoor fan to work constantly at lower than speed L. In addition, noise level of indoor unit is less than usual.</p> <p>Remarks :</p> <ol style="list-style-type: none"> <li>1. Quiet mode is unable to work in dry mode.</li> <li>2. Quiet mode is appropriate to work with less cooling load and less heating load condition. Because of the fan speed L- may cause not enough the cooling capacity or heating capacity.</li> </ol>
<p><b>18. COMFORT SLEEP</b></p>	<p><b>Cooling mode</b></p> <ul style="list-style-type: none"> <li>• The preset temperature will increase as show on ECO operation (Item No. 9)</li> <li>• Press the [COMFORT SLEEP] button to choose the operating hours. Repeat pressing to select the hours. (1hr, 3hr, 5hr or 9hr)</li> <li>• If the [COMFORT SLEEP] button is pressed again means cancel comfort sleep mode.</li> </ul> <p><b>Heating mode</b></p> <ul style="list-style-type: none"> <li>• The preset temperature will drop down as show on ECO operation (Item No. 9)</li> <li>• Press the [COMFORT SLEEP] button to choose the operating hours. Repeat pressing to select the hours. (1hr, 3hr, 5hr or 9 hr)</li> <li>• If the [COMFORT SLEEP] button is pressed again means cancel comfort sleep mode.</li> </ul>	<p>The principles of comfort sleep mode are:</p> <ul style="list-style-type: none"> <li>• Quietness for more comfortable. When room temperature reach setting temperature</li> <li>• Save energy by changing room temperature automatically.</li> <li>• The air condition can shut down by itself automatically.</li> </ul> <p>Remarks:</p> <ol style="list-style-type: none"> <li>1. Comfort sleep mode will not operate in dry mode.</li> </ol>
<p><b>19. Short Timer</b></p>	<p>In the normal condition, after switching one circuit breaker, 3-minutes delay time for compressor is set for the maintenance of the unit.</p> 	<p><b>Purpose</b></p> <p>To start the unit immediately for the purpose of testing, trial...etc, short timer can be used. maintenance of the unit.</p> <p><b>Short Timer Setting</b></p> <ol style="list-style-type: none"> <li>① Press [⏻] button to turn the unit OFF.</li> <li>② Set the operation mode on the remote control without sending the signal to the unit.</li> <li>③ Use the tip of the pencil to push the [CHK] button and hold, "00" will show on display, then press [SET] button to make "00" disappear.</li> <li>④ Press [⏻] button to turn the unit ON.</li> <li>⑤ When short timer is activated, all setting on the remote operates immediately, besides, all indications on front panel turns ON continuously for 3 seconds.</li> </ol>

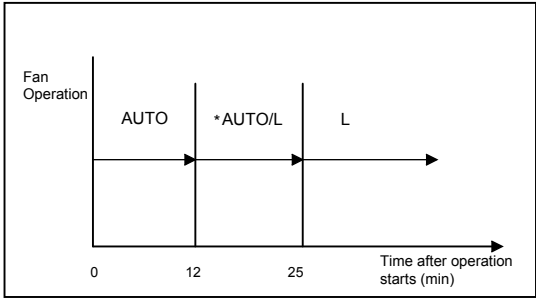
Item	Operation flow and applicable data, etc.	Description
<p><b>20. One-Touch Comfort</b></p>	<p>One touch comfort is the fully automated operation that is set according to the preferable condition in a region.</p>  <p>*AUTO/L: Fan operates depends on the setting temperature and room temperature.</p> <p>During the One Touch Comfort mode if the indoor unit receives any signal with other operation mode, the unit will cancel the comfort mode and operates according to the signal received.</p>	<p><b>Operation condition for model to Europe market</b></p> <p>When an indoor unit receives "One Touch Comfort Signal" from the remote controller, the indoor unit operates as following.</p> <ol style="list-style-type: none"> <li>1) Air conditioner starts to operation when the signal is received, even if the air conditioner was OFF.</li> <li>2) Operation mode is set according to room temperature, the same as AUTO mode.</li> <li>3) Target temperature is 24°C.</li> <li>4) Louver position is set as stored position of the operating mode.</li> <li>5) Fan is controlled as followings.</li> </ol>
<p><b>21. Hi-POWER Mode</b></p>	<p><b>([Hi-POWER] button on the remote controller is pressed)</b></p> <p>When [Hi-POWER] button is pressed while the indoor unit is in Auto, Cooling or Heating operation, Hi-POWER mark is indicated on the display of the remote controller and the unit operates as follows.</p> <ol style="list-style-type: none"> <li><b>1. Automatic operation</b> <ul style="list-style-type: none"> <li>• The indoor unit operates in according to the current operation.</li> </ul> </li> <li><b>2. Cooling operation</b> <ul style="list-style-type: none"> <li>• The preset temperature drops 1°C (The value of the preset temperature on the remote controller does not change.) The indoor unit's fan speed level increase 1 tap</li> </ul> </li> <li><b>3. Heating operation</b> <ul style="list-style-type: none"> <li>• The preset temperature increases 2°C (The value of the preset temperature on the remote controller does not change.) The indoor unit's fan speed level increase 1 tap</li> </ul> </li> <li><b>4. The Hi-POWER mode can not be set in Dry operation</b></li> </ol>	
<p><b>22. FILTER Indicator</b></p>	<p>When the elapsed time reaches 1000 hours after operation, the FILTER indicator lights. After cleaning the filters, turn off the FILTER indicator.</p> <p><b>How to Turn Off FILTER Indicator</b> Press [OPERATION] button on the indoor unit.</p>	

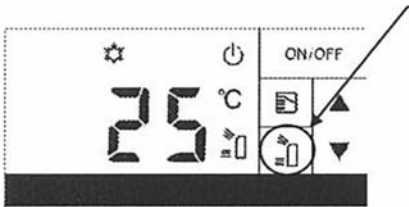
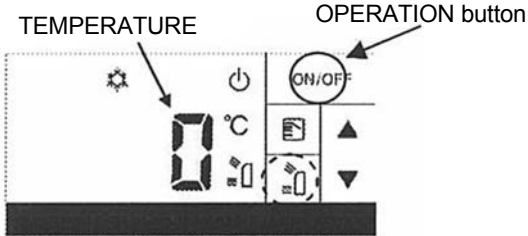
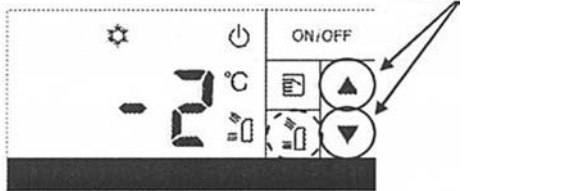
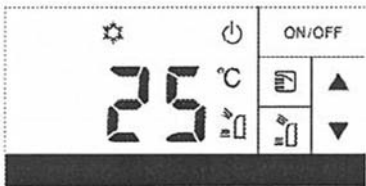
Item	Operation flow and applicable data,etc	Description						
<p><b>23. Set temp. correction</b></p>	<p>Set temp. can be corrected by changing the set temp. correction value. Initial setting of the set temp. correction value is 0.</p> <p>Set temp. = Set temp. (TS)+ Set temp. correction Set temp. (TS) : remote control or indoor unit display setting</p> <table border="1" data-bbox="357 389 892 535"> <thead> <tr> <th colspan="2">Set temp. correction</th> </tr> </thead> <tbody> <tr> <td>Cooling (Dry mode)</td> <td>-5 ~ +5°C</td> </tr> <tr> <td>Heating</td> <td>-5 ~ +5°C</td> </tr> </tbody> </table> <p>&lt; How to change the set temp. correction &gt;</p> <ol style="list-style-type: none"> <li>Operate the air conditioner and select cooling or heating mode. (The set temp. correction can't be changed at standby mode.)</li> <li>Push and hold AIR OUTLET SELECT button on the unit operation panel</li> </ol> <p style="text-align: center;">AIR OUTLET SELECT button</p>  <ol style="list-style-type: none"> <li>Push OPERATION button on the unit operation panel 10 times. Set temp. correction value is displayed on the TEMPERATURE indicator.</li> </ol> <p style="text-align: center;">TEMPERATURE      OPERATION button</p>  <ol style="list-style-type: none"> <li>Push TEMPERATURE button (UP or DOWN) to change set temp. correction.</li> </ol> <p style="text-align: center;">TEMPERATURE button</p>  <ol style="list-style-type: none"> <li>Release AIR OUTLET SELECT button. Set temp. correction is memorized and set temp. value is displayed on the TEMPERATURE indicator again.</li> </ol> 	Set temp. correction		Cooling (Dry mode)	-5 ~ +5°C	Heating	-5 ~ +5°C	<ol style="list-style-type: none"> <li>Purpose When the difference between the set temperature of the remote control and the room temperature is wide due to the installation condition, etc, the set temperature can be corrected.</li> <li>Description For example, when set temp. is 25°C but room temp. is stable 27°C at cooling mode, change set temp. correction (Cooling) from 0 to -2°C</li> </ol> <ul style="list-style-type: none"> <li>Continue to push and hold AIR OUTLET SELECT button.</li> <li>Continue to push and hold AIR OUTLET SELECT button.</li> </ul>
Set temp. correction								
Cooling (Dry mode)	-5 ~ +5°C							
Heating	-5 ~ +5°C							

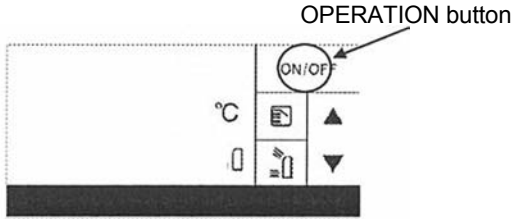
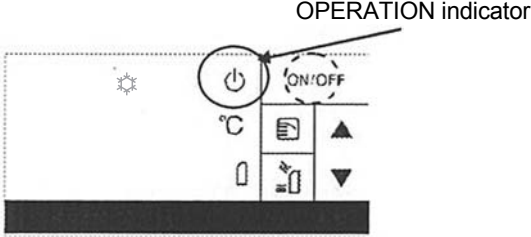
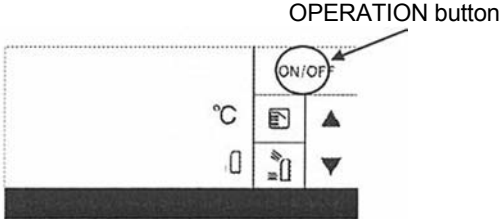
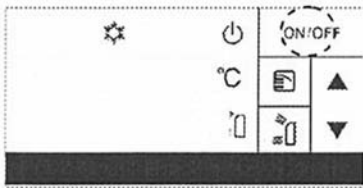

Item	Operation flow and applicable data,etc	Description																											
<p><b>24. Outdoor Quiet control</b> <b>(for only 1:1 outdoor unit)</b></p>	<p>As shown in the table, the max. revolution number of compressor can be reduced. As the max. number of revolution of compressor is restricted, the rise-up performance at the start time is weakened. This function is disable with multi-outdoor unit connecting.</p> <table border="1" data-bbox="341 383 981 528"> <thead> <tr> <th rowspan="2">MODE</th> <th colspan="2">B10U2FVG-E,-TR</th> <th colspan="2">B13U2FVG-E,-TR</th> <th colspan="2">B18U2FVG-E,-TR</th> </tr> <tr> <th>Normal (rps)</th> <th>Normal (rps)</th> <th>Normal (rps)</th> <th>Normal (rps)</th> <th>Normal (rps)</th> <th>Normal (rps)</th> </tr> </thead> <tbody> <tr> <td>Cooling</td> <td>*</td> <td>*</td> <td>*</td> <td>*</td> <td>*</td> <td>*</td> </tr> <tr> <td>Heating</td> <td>*</td> <td>*</td> <td>*</td> <td>*</td> <td>*</td> <td>*</td> </tr> </tbody> </table> <p>* Refer to CDU service manual combined).</p> <p>When air conditioner is on standby before setting. &lt; How to set Outdoor Quiet control &gt;</p> <ol style="list-style-type: none"> <li>1. Push and hold OPERATION button for 20seconds.</li> </ol>  <ol style="list-style-type: none"> <li>2. After holding 20seconds, beep sounds is heard and OPERATION indicator flashes for 5seconds. Release OPERATION button.</li> </ol>  <ol style="list-style-type: none"> <li>3. Push OPERATION button to stop temporary operation. (Set Auto restart function again)</li> </ol> <p>&lt; How to cancel Outdoor Quiet control &gt;</p> <ol style="list-style-type: none"> <li>1. Push and hold OPERATION button for 20seconds.</li> </ol>  <ol style="list-style-type: none"> <li>2. After holding 20seconds, beep sounds is heard. (OPERATION indicator doesn't flash). Release OPERATION button.</li> </ol>  <ol style="list-style-type: none"> <li>3. Push OPERATION button to stop temporary operation. (Set Auto restart function again)</li> </ol>	MODE	B10U2FVG-E,-TR		B13U2FVG-E,-TR		B18U2FVG-E,-TR		Normal (rps)	Normal (rps)	Normal (rps)	Normal (rps)	Normal (rps)	Normal (rps)	Cooling	*	*	*	*	*	*	Heating	*	*	*	*	*	*	<ol style="list-style-type: none"> <li>1. Purpose For the users who concern about noise of the outdoor unit, this control controls the max. revolution number of the compressor to reduce the noise.</li> <li>2. Description <ul style="list-style-type: none"> <li>• It can be change setting whether air conditioner is operating or not.</li> <li>• After pushing OPERATION button, air conditioner starts operation.</li> <li>• After 3seconds, 3 beeps are heard. (Auto restart setting is changed.)</li> <li>• After 10seconds, a beep is heard. (Temporary operation starts and Auto restart function is cancelled.)</li> </ul> </li> </ol> <ul style="list-style-type: none"> <li>• After pushing OPERATION button, air conditioner starts operation.</li> <li>• After 3seconds, 3 beeps are heard. (Auto restart setting is changed.)</li> <li>• After 10seconds, a beep is heard. (Temporary operation starts and Auto restart function is cancelled.)</li> </ul>
MODE	B10U2FVG-E,-TR		B13U2FVG-E,-TR		B18U2FVG-E,-TR																								
	Normal (rps)	Normal (rps)	Normal (rps)	Normal (rps)	Normal (rps)	Normal (rps)																							
Cooling	*	*	*	*	*	*																							
Heating	*	*	*	*	*	*																							

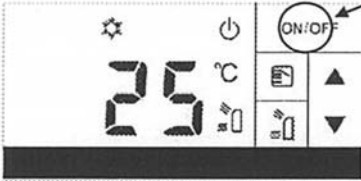
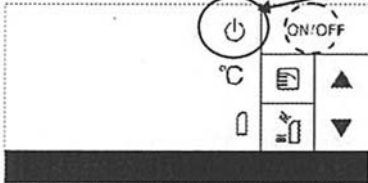
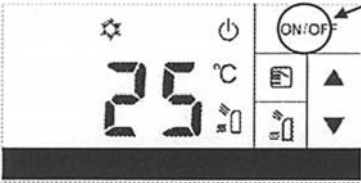
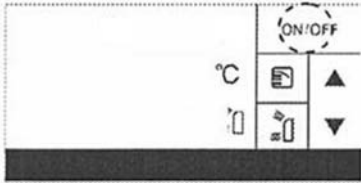
Item	Operation flow and applicable data,etc	Description
<p><b>24. Outdoor Quiet control</b> (for only 1:1 outdoor unit)</p>	<p>When air conditioner is in operation before setting.</p> <p>&lt; How to set Outdoor Quiet control &gt;</p> <p>1. Push and hold OPERATION button for 20seconds.</p> <p style="text-align: center;">OPERATION button</p>  <p>2. After holding 20seconds, beep sounds is heard and OPERATION indicator flashes for 5seconds. Release OPERATION button.</p> <p style="text-align: center;">OPERATION indicator</p>  <p>&lt; How to cancel Outdoor Quiet control &gt;</p> <p>1. Push and hold OPERATION button for 20seconds.</p> <p style="text-align: center;">OPERATION button</p>  <p>2. After holding 20seconds, beep sounds is heard. (OPERATION indicator doesn't flash). Release OPERATION button.</p> 	<ul style="list-style-type: none"> <li>• After pushing OPERATION button, air conditioner stops operation.</li> <li>• After 3seconds, 3 beeps are heard. (Auto restart setting is changed.)</li> </ul> <ul style="list-style-type: none"> <li>• After pushing OPERATION button, air conditioner starts operation.</li> <li>• After 3seconds, 3 beeps are heard. (Auto restart setting is changed.)</li> </ul>

### 9-3. Auto Restart Function

This indoor unit is equipped with an automatic restarting function which allows the unit to restart operating with the set operating conditions in the event of a power supply being accidentally shut down.

The operation will resume without warning three minutes after power is restored.

This function is not set to work when shipped from the factory. Therefore it is necessary to set it to work.

#### 9-3-1. How to Set the Auto Restart Function

To set the auto restart function, proceed as follows:

The power supply to the unit must be on ; the function will not set if the power is off.

Press the [OPERATION] button located in the display of the indoor unit continuously for three seconds.

The unit receives the signal and beeps three times.

The unit then restarts operating automatically in the event of power supply being accidentally shut down.

#### • When the unit is standby (Not operating)

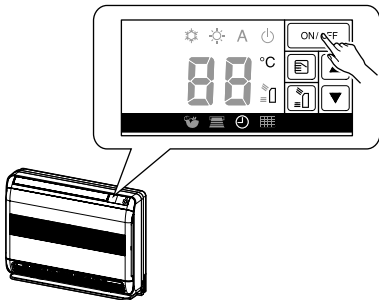
Operation	Motions
<p>Press [OPERATION] button for more than three seconds. (Less than 10 seconds)</p> 	<p>The unit is on standby.</p> <p style="text-align: center;">↓</p> <p>The unit starts to operate.                      The operation indicator is on.</p> <p style="text-align: center;">↓                      After approx. three seconds,</p> <p>The unit beeps three times and continues to operate.                      <b>The operation indicator flashes for 5 seconds.</b></p> <p>If the unit is not required to operate at this time, press [OPERATION] button once more or use the remote control to turn it off.</p>

#### • When the unit is in operation

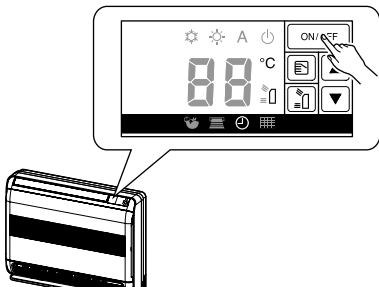
Operation	Motions
<p>Press [OPERATION] button for more than three seconds. (Less than 10 seconds)</p> 	<p>The unit is in operation.                      The operation indicator is on.</p> <p style="text-align: center;">↓</p> <p>The unit stops operating.                      The operation indicator is turned off.</p> <p style="text-align: center;">↓                      After approx. three seconds,</p> <p>The unit beeps three times.                      <b>The operation indicator flashes for 5 seconds.</b></p> <p>If the unit is required to operate at this time, press [OPERATION] button once more or use the remote control to turn it on.</p>

• While the filter check indicator is on, OPERATION button has the function of filter reset button.

### 9-3-2. How to Cancel the Auto Restart Function

To cancel auto restart function, proceed as follows :

Repeat the setting procedure : the unit receives the signal and beeps three times.

The unit will be required to be turned on with the remote control after the main power supply is turned off.

#### • When the system is on stand-by (not operating)

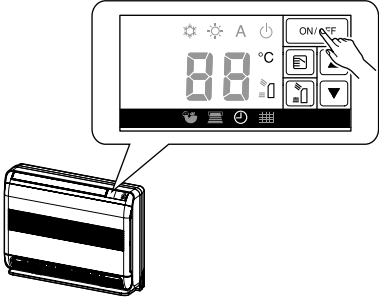
Operation	Motions
<p>Press [OPERATION] button for more than three seconds. (Less than 10 seconds)</p> 	<p>The unit is on standby.</p> <p>↓</p> <p>The unit starts to operate.                      The operation indicator is on.</p> <p>↓                      After approx. three seconds,</p> <p>The unit beeps three times and continues to operate.</p> <p>If the unit is not required to operate at this time, press [OPERATION] button once more or use the remote control to turn it off.</p>

#### • When the system is operating

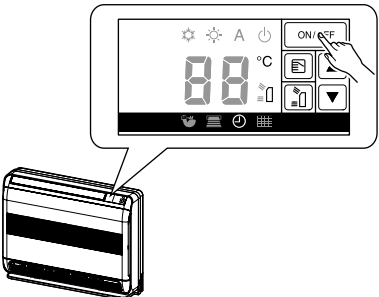
Operation	Motions
<p>Press [OPERATION] button for more than three seconds. (Less than 10 seconds)</p> 	<p>The unit is in operation.                      The operation indicator is on.</p> <p>↓</p> <p>The unit stops operating.                      The operation indicator is turned off.</p> <p>↓                      After approx. three seconds,</p> <p>The unit beeps three times.</p> <p>If the unit is required to operate at this time, press [OPERATION] button once more or use the remote control to turn it on.</p>

### 9-3-3. Power Failure During Timer Operation

When the unit is turned off because of power failure during timer operation, the timer operation is cancelled. In that case, set the timer operation again.

#### NOTE :

The Everyday Timer is reset while a command signal can be received from the remote control even if it stopped due to a power failure.

## 9-4. Remote control

### 9-4-1. Remote control and its functions

- ① Infrared signal emitter
- ② Start/Stop button
- ③ Mode select button (MODE)
- ④ Temperature button (TEMP)
- ⑤ Fan speed button (FAN)
- ⑥ Swing louver button (SWING)
- ⑦ Set louver button (FIX)
- ⑧ On timer button (ON)
- ⑨ Off timer button (OFF)
- ⑩ Sleep timer button (SLEEP)
- ⑪ Setup button (SET)
- ⑫ Clear button (CLR)
- ⑬ Memory and Preset button (PRESET)
- ⑭ One Touch button (ONE-TOUCH)
- ⑮ High power button (Hi-POWER)
- ⑯ Economy button (ECO)
- ⑰ Quiet button (QUIET)
- ⑱ Comfort sleep button (COMFORT SLEEP)
- ⑲ Filter reset button (FILTER)
- ⑳ Clock Reset button (CLOCK)
- ㉑ Check button (CHK)
- ㉒ Floor warming mode button (FLOOR)

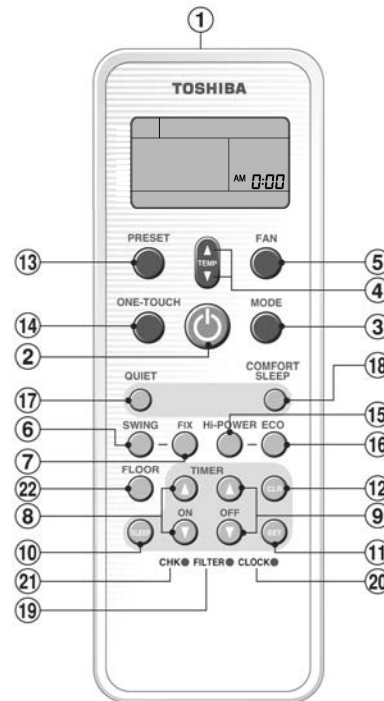

### 9-4-2. Operation of remote control

#### 1. ONE-TOUCH

Press the "ONE-TOUCH" button for fully automated operation that is customised to the typical consumer preferences in your region of the world. The customised settings control temperature air flow strength, air flow direction and other settings to provide you alternate contact with "ONE-TOUCH" of the button. If you prefer other settings you can select from the many other operation functions of your Toshiba unit

Press ● ONE-TOUCH : Start the operation.

#### 2. AUTOMATIC OPERATION

To automatically select cooling, heating operation.

1. Press ● MODE : Select A.
2. Press ⏴ MODE : Select A.



#### 3. COOLING / HEATING / FAN ONLY\* OPERATION

1. Press ● MODE : Select Cool ❄️, Heat ☀️ or Fan only 🌀.
2. Press ⏴ MODE : Set the desired temperature.  
Cooling : Min 17°C - Max 30°C. (Fan Only: No temperature indication)
3. Press ● FAN : Select AUTO, LOW 📉, LOW+ 📈, MED 📊, MED+ 📌, or HIGH 📏.

\* The remote controller that be had Fan only operation.

**4. DRY OPERATION (COOLING ONLY)**

For dehumidification, a moderate cooling performance is controlled automatically.

1. Press  MODE : Select Dry  .
2. Press  MODE : Set the desired temperature.

**Note:** Dry Mode fan speed is set to Auto only.

**5. HI-POWER OPERATION**

To automatically control room temperature and airflow for faster cooling or heating operation (except in DRY and FAN ONLY mode)

Press  HI-POWER : Start and stop the operation.

**6. FLOOR WARMING OPERATION**

Heating will operate with downward blowing only.  
Temperature of air outlet will be higher than usual.

**7. ECO OPERATION**

To automatically control room temperature to save energy (except in DRY and FAN ONLY mode)

Press  ECO : Start and stop the operation.

**Note:** Cooling operation; the set temperature will increase automatically 0.5 degree/hour for 4 hours (maximum 2 degrees increase).







Heating operation; the set temperature will decrease.

**8. TEMPORARY OPERATION**

In case of the misplaced or discharged remote control





- Pressing the RESET button, the unit can start or stop without using the remote control.
- Operation mode is set on AUTOMATIC operation, preset temperature is 24°C and fan operation is automatic speed.

**9. TIMER OPERATION**

Setting the ON Timer		Setting the OFF Timer	
1	Press  : Set the desired ON timer.	Press  : Set the desired OFF timer.	
2	Press  : Set the timer	Press  : Set the timer.	
3	Press  : Cancel the timer	Press  : Cancel the timer.	

Everyday timer allows the user to set both the ON & OFF timers and will be activated on a daily basis.

**Setting Everyday Timer**

1	Press  : Set the ON timer .	3	Press  .
2	Press  : Set the OFF timer .	4	Press  button during the (↑ or ↓) mark flashing.

- During the every day timer is activation, both arrows (↑ or ↓) are indicated.

**Note:**

- Keep the remote control in accessible transmission to the indoor unit; otherwise, the time lag of up to 15 minutes will occur.
- The setting will be saved for the next same operation.

**10. PRESET OPERATION**

Set your preferred operation for future use. The setting will be memorized by the unit for future operation (except air flow direction).

1. Select your preferred operation.
2. Press and hold ● PRESET for 3 seconds to memorize the setting. The ● mark displays.
3. Press ● PRESET : Operate the preset operation.

**11. AUTO RESTART OPERATION**

To automatically restart the conditioner after the power failure (Power of the unit must be on.)

**Setting**

1. Press and hold the RESET button on the indoor unit for 3 seconds to set the operation. (3 beep sound and OPERATION lamp blink 5 time/sec for 5 seconds)
  - Do not operate ON timer and OFF timer.
2. Press and hold the RESET button on the indoor unit for 3 seconds to cancel the operation. (3 beep sound but OPERATION lamp does not blink)
  - In case of timer are set, AUTO RESTART OPERATION does not activate.

**12. QUIET OPERATION**

To operate at super low fan speed for quiet operation (except in DRY mode)

Press ● QUIET : Start and stop the operation.

**Note:** Under certain conditions, QUIET operation may not provide adequate cooling or heating due to low sound features.

**13. COMFORT SLEEP OPERATION**

To save energy while sleeping, automatically control air flow and automatically turn OFF.

Press ● COMFORT SLEEP : Select 1, 3, 5 or 9 hrs for OFF timer operation.

**Note:** Cooling operation; the set temperature will increase automatically 0.5 degree/hour for 4 hours (maximum 2 degrees increase).

Heating operation; the set temperature will decrease.

**14. SLEEP TIMER OPERATION**

To start the sleep timer (OFF timer) operation

Press ● SLEEP : Select 1, 3, 5 or 9 hrs for OFF timer operation.

Press ● CLR to cancel the sleep timer operation.

**15. FILTER RESET**

△ Firstly, turn off the circuit breaker.

FILTER lamp lights on; the filter must be cleaned.

To turn off the lamp, push OPERATION button on the indoor unit or the FILTER button on the remote control.

**Note:** The filter indicator turns on after turns on after about 1000 hours.

**Indoor Unit and Remote Control**

- Clean the indoor unit and the remote control with a wet cloth when needed.
- No benzene, thinner, polishing powder or chemically-treated duster.

**16. SELF CLEANING OPERATION (COOL AND DRY OPERATION ONLY)****Cleaning operation**

This function is used to dry the inside of the air conditioner to reduce the growth of mold, etc. inside the air conditioner.

- When the unit shuts down after having operated for 10 or more minutes in the cooling or dry mode, the cleaning operation is started automatically, and the TIMER indicator on the unit's display panel turns on.

**Cleaning operation duration**

- The cleaning operation lasts for 30 minutes if the unit has been operating in the cooling or dry mode for 10 minutes or more.

**Note:**

- SELF CLEANING operation is default setting from factory.
- How to cancel SELF CLEANING operation.  
Press and hold MODE button on operation panel for more than 10 seconds (less than 20 seconds). When canceling, 4 beeps sound.
- How to activate SELF CLEANING operation.  
Press and hold MODE button on operation panel for more than 10 seconds (less than 20 seconds). Then, 4 beeps will sound and operation lamp will blink for 5 seconds.

**17. OPERATION AND PERFORMANCE**

1. Three-minute protection feature: To prevent the unit from being activated for 3 minutes when suddenly restarted or switched to ON.
2. Preheating operation: Warm up the unit for 5 minutes before blowing warm air.
3. Warm air control: When the room temperature reaches the set temperature, the fan speed is automatically reduced and the outdoor unit will stop.
4. Automatic defrosting: Fans will stop during defrost operation.
5. Heating capacity: heat is absorbed from outdoor and released into the room.  
When the outdoor temperature is too low, use another recommended heating apparatus in combination with the air conditioner.
6. Consideration for accumulated snow: Select the position for outdoor unit when it will not be subjected to snow drifts, accumulation of leaves or other seasonal debris.
7. Some minor cracking sound may occur when unit operating. This is normal because the cracking sound may be caused by expansion/contraction of plastic.

Operation \ Temp.	Outdoor Temperature	Room Temperature
Heating	*	*
Cooling	*	*
Dry	*	*

\* Refer to the service manual of multi outdoor unit to be combined.



**18. TROUBLESHOOTING (CHECK POINT)**

The unit does not operate.	Cooling or Heating is abnormally low
<ul style="list-style-type: none"> <li>• The power main switch is turned off.</li> <li>• The circuit breaker is activated to cut off the power supply.</li> <li>• Stoppage of electric current.</li> <li>• ON timer is set.</li> </ul>	<ul style="list-style-type: none"> <li>• The filters are blocked with dust.</li> <li>• The temperature has been set improperly.</li> <li>• The windows or doors are opened.</li> <li>• The air inlet or outlet of the outdoor unit is blocked.</li> <li>• The fan speed is too low.</li> <li>• The operation mode is DRY.</li> </ul>

**Note:** When there is an abnormality in the product, abnormal code (2 digits) will be displayed on the unit display panel. Please contact the dealership.

**In case of multiple connection**

- Check whether the operation mode is different from what has been selected for the units in the other rooms (The following combinations of operations cannot be performed: COOL and HEAT, DRY and HEAT).
- Select the same operation mode as for the other rooms.

**19. REMOTE CONTROL A-B SELECTION**

To separate using of remote control for each indoor unit in case of 2 air conditioners are installed nearby.

**Remote Control B Setup.**

1. Push and hold CHK · button on the Remote Control by the tip of the pencil.  
"00" will be shown on the display (Picture ①).
2. Press ● MODE : during pushing CHK ·. "B" will show on the display and "00" will disappear and the air conditioner will turn OFF. The Remote Control B is memorized (Picture ②).

- Note:**
1. Repeat above step to reset Remote Control to be A.
  2. Remote Control A has not "A" display.
  3. Default setting of Remote Control from factory is A.

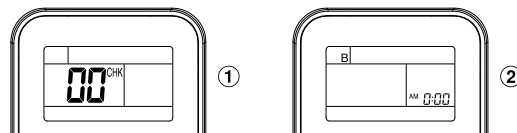
**Unit B setup.**

- Press and hold MODE button for more than 20 seconds.  
When A setup changed to B setup : 5 beeps will sound and operation lamp blinks for 5 seconds.  
When B setup changed to A setup : 5 beeps will sound.

**20. ADJUSTING BRIGHTNESS OF UNIT DISPLAY PANEL**

1. Press and hold AIR OUTLET SELECT button then press MODE button for 3 times (All lamp of the unit display panel will be switched on).  
(At that time, please press and hold the AIR OUTLET SELECT button)
2. Press and hold AIR OUTLET SELECT button on Unit display panel, then press TEMPERATION button (Up), (Down) for select the desired brightness.
3. Brightness will be settled when AIR OUTLET SELECT button is released. Although the temperature indicator is switched off, if press the temperature button (up) and (down), the set temperature will be indicated, and then can adjust the temperature.  
10 seconds after stopped pressing the button, the temperature indication will be switched off.

**4 stages of brightness can be changed.**

	<b>Temperature indicator</b>	<b>Other lamp</b>
1	Usual	Usual
2	Darkness	Darkness
3	Turn off	Darkness
4	Turn off	Turn off

**21. CHANGE AIR OUTLET GRILLE ON STABLE TIME (COOLING ONLY)**

On cooling operation, whichever air outlet is set, only Upper is used when the room temperature approaches the set temperature.

In case to keep up/down blowing, operate as below;

Press and hold AIR OUTLET SELECT button for more than 10 seconds (less than 20 seconds) (4 beeps will sound then "1" indication at TEMPERATURE indicator will light up for 5 seconds).

For return to the former status, press and hold AIR OUTLET SELECT button for more than 4 seconds once again (In this time, 4 beeps will sound then "0" indication at TEMPERATURE indicator will blinks for 5 seconds).

**22. AIR INLET GRILLE MAINTENANCE**

**Wash the air inlet grille with water using the soft sponge or towel.**

- Dry it well in a shadow area after washing.
- Scour heavy dirt with neutral detergent for kitchen, and rinse it with the water (Do not use the wire wool).
- Do not press the front panel strongly. It may be cracked.

### 9-4-3. Name and Functions of Indications on Remote Controller



#### [Display]

All indications, except for the clock time indicator, are displayed by pressing the  button.

#### 1 Transmission mark

This transmission mark  indicates when the remote controller transmits signals to the indoor unit.

#### 2 Mode indicator





Indicates the current operation mode.  
(A : Auto changeover control,  
 : Cool,  : Dry,  : Heat)

#### 3 Temperature indicator

Indicates the temperature setting.  
(17°C to 30°C)

#### 4 FAN speed indicator

Indicates the selected fan speed.

AUTO or five fan speed levels  
(LOW , LOW+ , MED , MED+ , HIGH ) can be shown.

Indicates AUTO when the operating mode is  : Dry.

#### 5 TIMER and clock time indicator

The time setting for timer operation or the clock time is indicated.

The current time is always indicated except during TIMER operation.

#### 6 Hi-POWER indicator

Indicates when the Hi-POWER operation starts.  
Press the Hi-POWER button to start and press it again to stop the operation.

#### 7 (PRESET) indicator

Flashes for 3 seconds when the PRESET button is pressed during operation.

The  mark is shown when holding down the button for more than 3 seconds while the mark is flashing.

Press another button to turn off the mark.

#### 8 ECO indicator

Indicates when the ECO is in activated.

Press the ECO button to start and press it again to stop operation.

#### 9 A, B change indicator remote controller

When the remote controller switching function is set, "B" appears in the remote controller display.  
(When the remote controller setting is "A", there is no indication at this position.)

#### 10 Comfort sleep

Indicates when comfort sleep is activated.  
Press comfort sleep button to selectter

#### 11 Quiet

Indicates when quiet is activated.  
Press quiet button to start and press it again to stop operation.

#### 12 One-Touch

Indicates when one touch comfort is activated.  
Press one-touch button to start the operation.

#### 13 Swing

Indicates when louver is swing.  
Press swing button to start the swing operation and press it again to stop the swing operation.

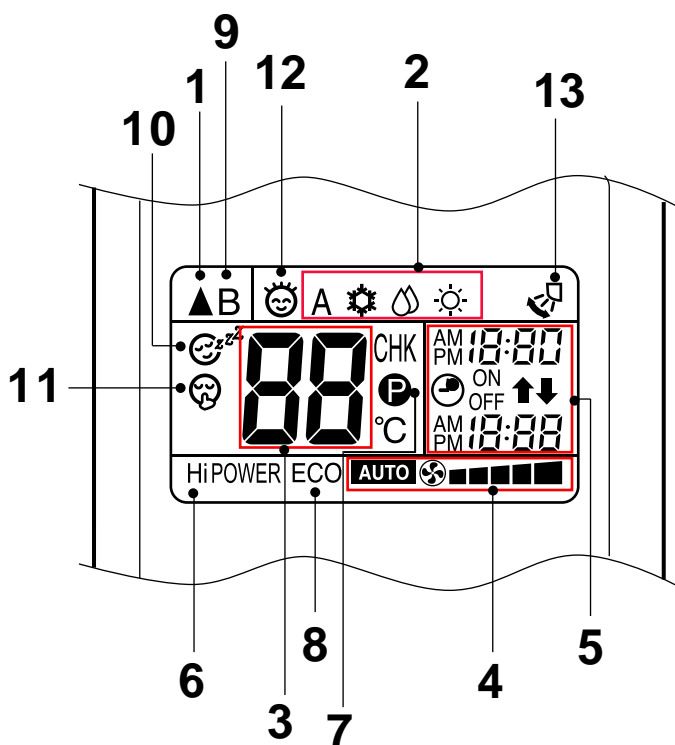

## 9-5. Indoor Unit Display & Unit Operation Panel

This indoor unit can be operated with the unit operation panel or using remote control.

Operational contents will be followed the one which was operated later.

If change the set temperature with operation panel of unit, temperature indication will be changed, but the temperature display on the remote control will not change.

If set the air flow only with the upper port, a little air flow may happen at the lower port.

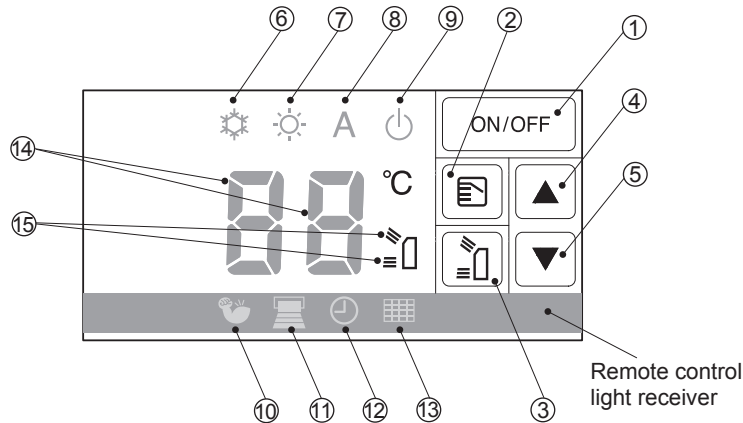

- ① OPERATION button : Unit operation ON/OFF button, turn off FILTER CHECK indicator.
- ② MODE button : Operation mode (Auto→Cooling→Heating→Auto→•••)
- \* CHILD LOCK function : Press MODE button for 3 seconds. (It is possible to operate even when stopping.)  
To cancel CHILD LOCK function, press MODE button for 3 seconds once again.  
When CHILD LOCK function is activated, 3 beeps will sound.  
When press MODE button to cancel the function, a beep will sound and then 3 seconds later 3 beep sound may occur.  
The indicator button will be invalid while the child lock function is activated.  
(When press the button, 1 beep will sound).  
Operation with remote control during the CHILD LOCK function works.  
This function is cancelled when the power supply is off or failure.
- ③ AIR OUTLET SELECT button : Cooling, Auto (Upper & Lower→Upper→Upper & Lower→•••)  
Dry (upper only)  
Heating (Upper & Lower→Upper→Upper & Lower→•••)  
On cooling operation, whichever air outlet is set, only Upper is used when the room temperature approaches the set temperature.  
During stop operation : Open/Close the lower air outlet grille.  
When the TEMPERATURE indicator display "CL" the lower air outlet grille will be in closed status.  
When the TEMPERATURE indicator display "OP" the lower air outlet grille will be in open status.
- ④ TEMPERATURE button (Up) : Setting temperature increase by 1°C (17°C→18°C••• 30°C)
- ⑤ TEMPERATURE button (Down) : Setting temperature decrease by 1°C (30°C→ 29°C••• 17°C)
- ⑥ COOL and DRY indicator (Blue)
- ⑦ HEAT indicator (Orange)
- ⑧ AUTO indicator (Green)
- ⑨ OPERATION indicator (Green)
- ⑩ HI-POWER indicator (Green)
- ⑪ FLOOR indicator (Orange)
- ⑫ TIMER indicator (Yellow)
- ⑬ FILTER CHECK indicator (Red)
- ⑭ TEMPERATURE indicator (Blue)
- ⑮ AIR OUTLET indicator (Green)

## 10. INSTALLATION PROCEDURE

### 10-1. Installation Diagram of Indoor and Outdoor Units

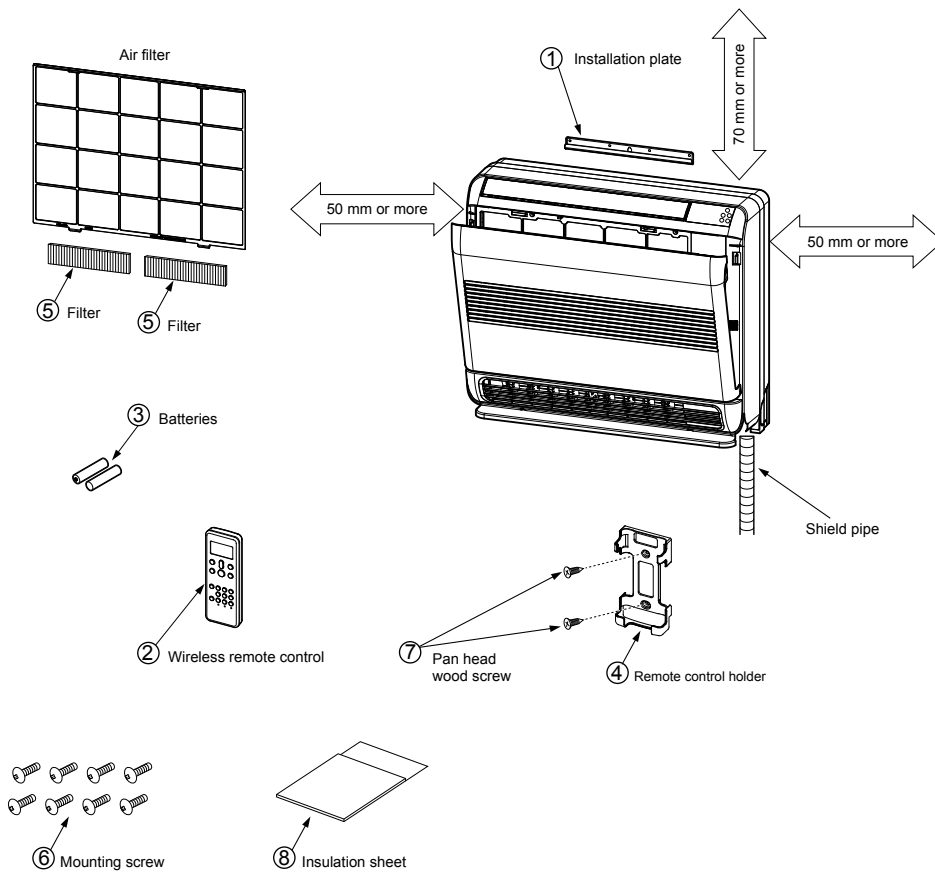

Do not allow the drain hose to get slack.

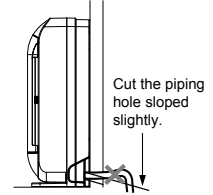

Make sure to run the drain hose sloped downward.

The auxiliary piping can be connected to the left, rear left, rear right, right, bottom right or bottom left.

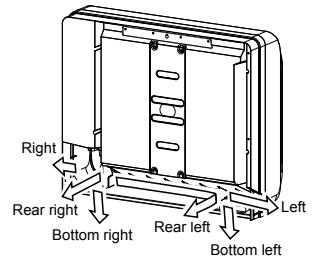

Insulate the refrigerant pipes separately with insulation, not together.

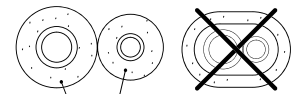

8 mm thick heat resisting polyethylene foam

In case of right or left piping

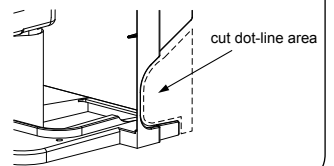

Heat insulation block can cut to an appropriate size and use for completely fill pipe hole to protect water dew.

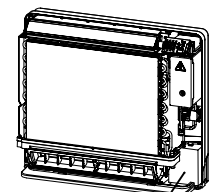

Before installing the wireless remote controller

- Loading Batteries
  1. Remove the battery cover.
  2. Insert 2 new batteries (AAA type) following the (+) and (-) positions.



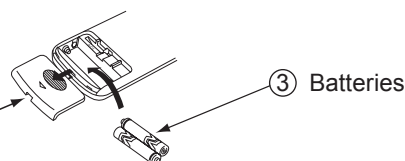





② Wireless remote controller

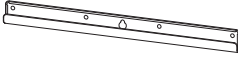

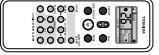
**10-2. Optional Parts, Accessories and Tools****10-2-1. Optional Installation Parts**

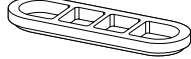
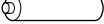
Part Code	Parts name	Q'ty
Ⓐ	Refrigerant piping Liquid side : Ø6.35 mm Gas side : Ø9.52 mm (RAS-B10,13U2FVG Series) Ø12.70 mm (RAS-B18U2FVG Series)	One each
Ⓑ	Pipe insulating material (polyethylene foam, 8 mm thick)	1
Ⓒ	Putty, PVC tapes	One each

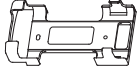
**10-2-2. Accessory and installation parts**

Part No.	Part name (Q'ty)	Part No.	Part name (Q'ty)	Part No.	Part name (Q'ty)
①	 Installation plate x 1	⑤	 Filter* x 2	⑨	 Drain nipple*** x 1
②	 Wireless remote control x 1	⑥	 Mounting screw $\varnothing$ 4 x 25 l x 8	⑩	 Cap waterproof*** x 2
③	 Battery x 2	⑦	 Flat head wood screw $\varnothing$ 3.1 x 16 l x 2	⑪	 B Label x 2 (for Multi model)
④	 Remote control holder x 1	⑧	 Insulation sheet x 1	* The part may differ from that shown. ** The number of parts may differ by model. *** The part is packed with the outdoor unit.	

**Others**

Name
Owner's manual
Installation manual







### 10-2-3. Installation/Serviceing Tools

#### Changes in the product and components

In the case of an air conditioner using R32, in order to prevent any other refrigerant from being charged accidentally, the service port diameter of the outdoor unit control valve (3 way valve) has been changed. (1/2 UNF 20 threads per inch)

- In order to increase the pressure resisting strength of the refrigerant piping flare processing diameter and size of opposite side of flare nuts has been changed. (for copper pipes with nominal dimensions 1/2 and 5/8)

#### New tools for R32(R410A)

New tools for R32(R410A)	Applicable to R22 model		Changes
Gauge manifold	×		As pressure is high, it is impossible to measure by means of conventional gauge. In order to prevent any other refrigerant from being charged, each port diameter has been changed.
Charge hose	×		In order to increase pressure resisting strength, hose materials and port size have been changed (to 1/2 UNF 20 threads per inch). When purchasing a charge hose, be sure to confirm the port size.
Electronic balance for refrigerant charging	○		As pressure is high and gasification speed is fast, it is difficult to read the indicated value by means of charging cylinder, as air bubbles occur.
Torque wrench (nominal diam. 1/2, 5/8)	×		The size of opposite sides of flare nuts have been increased. Incidentally, a common wrench is used for nominal diameters 1/4 and 3/8.
Flare tool (clutch type)	○		By increasing the clamp bar's receiving hole, strength of spring in the tool has been improved.
Gauge for projection adjustment	—	—	Used when flare is made by using conventional flare tool.
Vacuum pump adapter	○		Connected to conventional vacuum pump. It is necessary to use an adapter to prevent vacuum pump oil from flowing back to the charge hose. The charge hose connecting part has two ports-one for conventional refrigerant (7/16 UNF 20 threads per inch) and one for R32(R410A). If the vacuum pump oil (mineral) mixes with R32(R410A) a sludge may occur and damage the equipment.
Gas leakage detector	×		Exclusive for HFC refrigerant.

- Incidentally, the “refrigerant cylinder” comes with the refrigerant designation R32(R410A) and protector coating in the U.S's ARI specified rose color (ARI color code: PMS 507).
- Also, the “charge port and packing for refrigerant cylinder” require 1/2 UNF 20 threads per inch corresponding to the charge hose's port size.



### 10-3. Indoor Unit

#### 10-3-1. Installation Place

- A place which provides the spaces around the indoor unit as shown in the diagram.
- A place where there are no obstacles near the air inlet and outlet.
- A place which allows easy installation of the piping to the outdoor unit.
- A place which allows the front panel to be opened.

#### CAUTION

- Direct sunlight to the indoor unit's wireless receiver should be avoided.
- The microprocessor in the indoor unit should not be too close to RF noise sources.  
(For details, see the owner's manual)

#### Remote control

- A place where there are no obstacles such as a curtain that may block the signal from the remote control.
- Do not install the remote control in a place exposed to direct sunlight or close to a heating source such as a stove.
- Keep the remote control at least 1 m apart from the nearest TV set or stereo equipment (This is necessary to prevent image disturbances or noise interference).
- The location of the remote control should be determined as shown below.

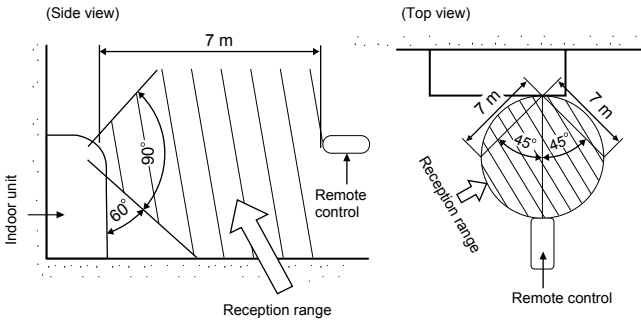

\* : Axial distance

#### 10-3-2. Cutting a Hole and Mounting Installation Plate

#### Cutting a hole

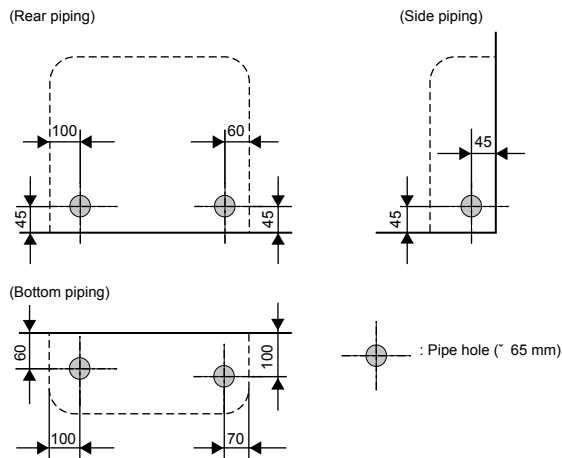

1. After determining the pipe hole position, drill the pipe hole (Ø65 mm) at a slight downward slant to the outdoor side.

#### NOTE

- When drilling a wall that contains a metal lath, wire lath or metal plate, be sure to use a pipe hole brim ring sold separately.

#### Mounting the installation plate and screw position

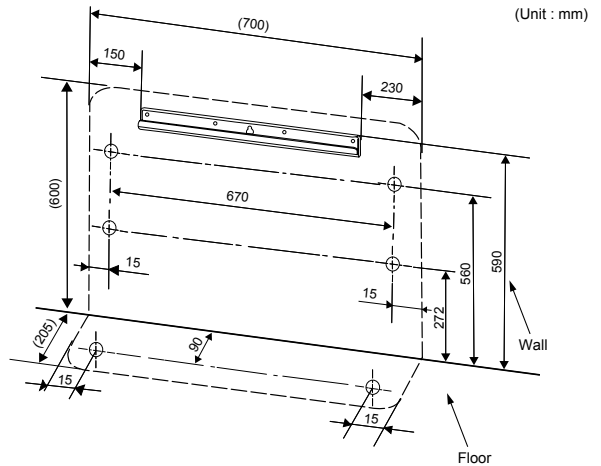

#### When the installation plate is directly mounted on the wall

1. Securely fit the installation plate onto the wall by screwing it in the upper and lower parts to hook up the indoor unit.
2. To mount the installation plate on a concrete wall with anchor bolts, use the anchor bolt holes as illustrated in the below figure.
3. Install the installation plate horizontally in the wall.

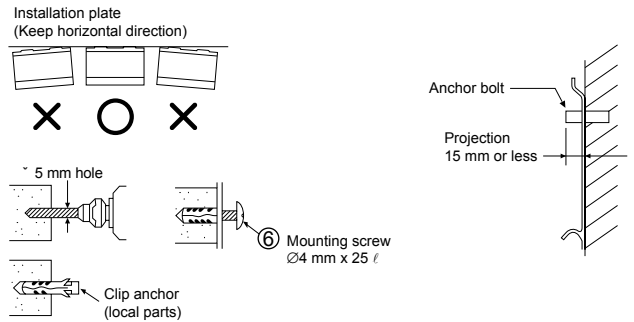

#### CAUTION

Failure to firmly install the unit may result in personal injury and property damage if the unit falls.

- In case of block, brick, concrete or similar type walls, make Ø5 mm holes in the wall.
- Insert clip anchors for appropriate mounting screws ⑥.

### 10-3-3. How to Install Indoor Unit

1. Remove the air inlet grille. Open the air inlet grille and remove the strap.
2. Remove the front panel (Remove the 4 screws).

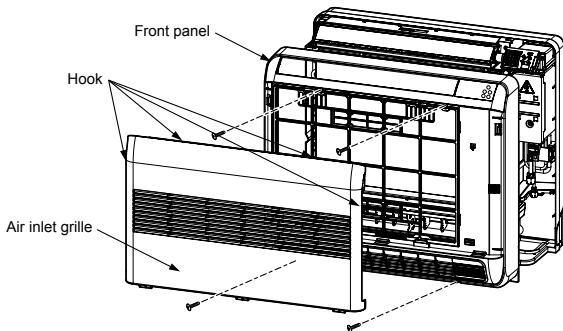

#### Layout of connection piping

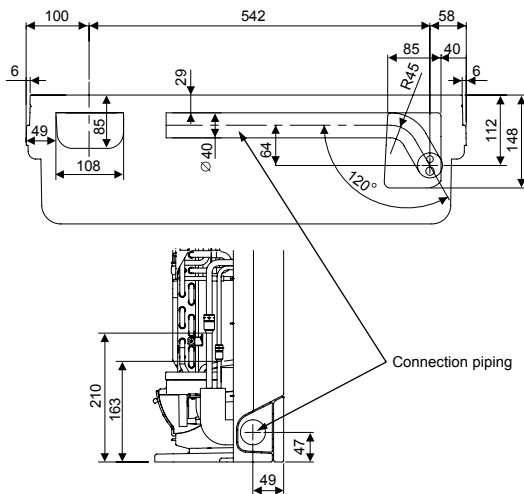

#### Treatment of piping connection

- 1) Check the flare nut connections for the gas leak with a gas leak detector or soap water.
- 2) To prevent gap in slit, fasten top and bottom with tape.
- 3) Slit is covered with tape.
- 4) Fasten with supplied Insulate sheet to prevent gap on the top of slit.

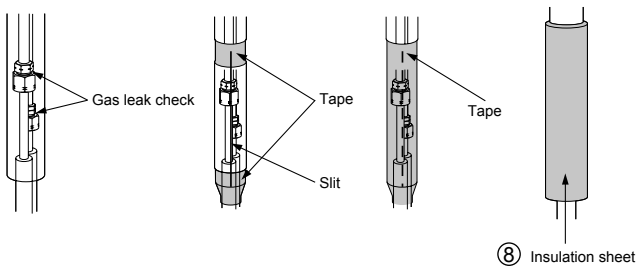

#### Drainage

1. Run the drain hose sloped downwards.

#### NOTE

- The hole should be made at a slight downward slant on the outdoor side.

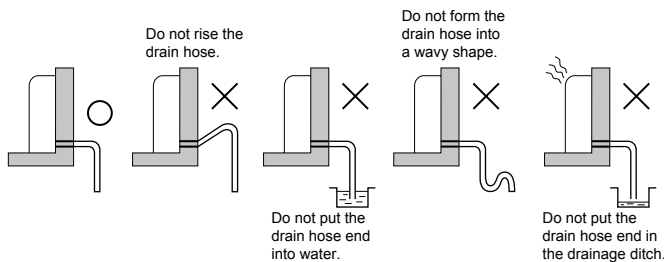

2. Put water in the drain pan and make sure that the water is drained out of doors.
3. When connecting extension drain hose, insulate the connecting part of extension drain hose with shield pipe.

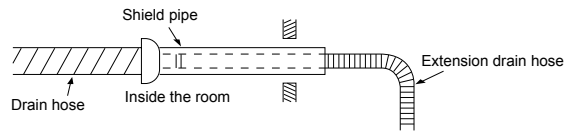

#### CAUTION

Arrange the drain pipe for proper drainage from the unit. Improper drainage can result in dew-dropping.

#### Wiring connection

Wiring of the connection cable is necessary to remove the front panel.

1. Remove the terminal cover and cord clamp.
2. Insert the connecting cable (according to the local rule) into the pipe hole on the wall.
3. Take out the connecting cable through the cable slot on the rear panel so that it protrudes about 50 cm from the front.
4. Insert the connecting cable fully into the terminal block and secure it tightly with screws.
5. Tightening torque : 1.2 N·m (0.12 kgf·m)
6. Secure the connecting cable with the cord clamp.
7. Fix the terminal cover, install the front panel and grille inlet.

#### CAUTION

- Be sure to refer to the wiring system diagram labeled inside the front panel.
- Check local electrical cords and also any specific wiring instructions or limitations.

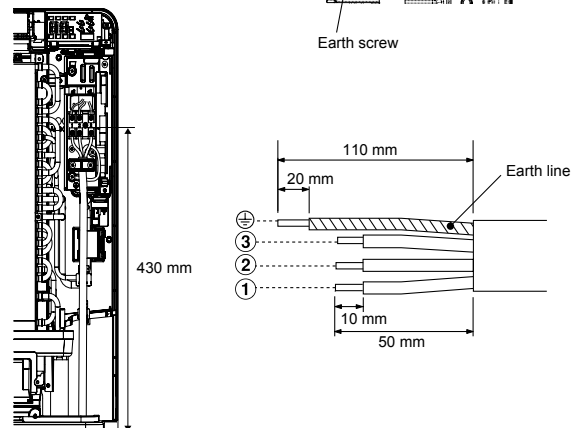
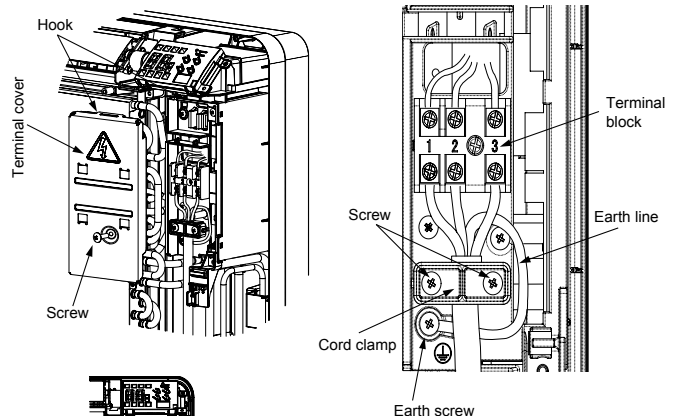

Stripping length of the connecting cable

#### NOTE

- Use stranded wire only.
- Wire type : H07RN-F or 60245 IEC66 (1.0 mm<sup>2</sup> or more)

**Mounting directly on the floor**

- 1) Fix the leg of indoor unit on the floor with 2 mounting screws.
- 2) Fix the upper part of indoor unit on the wall with 4 mounting screws.

(Floor installation)

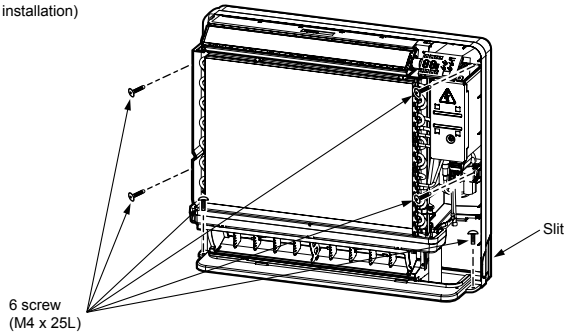

**NOTE**

- In case the plinth is fixed to the wall, please make sure to cut out the slit on the left and right side of the main part.

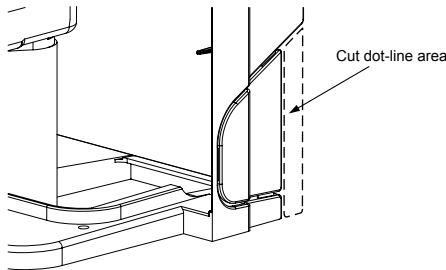

**Installation on the wall**

- 1) Fix the installation plate on the wall with 4 mounting screws.
- 2) Hook the indoor unit on the installation plate.
- 3) Fix the upper part of indoor unit on the wall with 4 mounting screws.

(Wall installation)

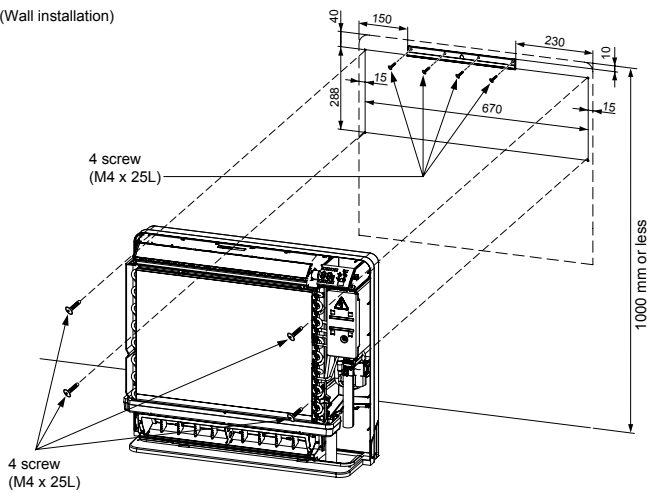

**CAUTION**

Make sure to fix it at a designated position with the screws. Failure may result the damage of piping by the turning over of a set.

**10-3-4. Concealed Installation**

The special method to install the indoor unit bury in the wall is shown here. Please make sure to change to wall burying mode.

1. To switch to the wall burying mode
  - To switch to the wall burying mode, press and hold AIR OUTLET SELECT button for 20 seconds.
  - When the operation set up and 5 beep sounds. Then indication at Temperature indicator will light up for 5 seconds.
  - To cancel, press AIR OUTLET SELECT button for 20 seconds then, 5 beep sounds. Then indication at Temperature indicator will blinks for 5 seconds.
  - To prevent dewfall, above plate angle should be narrow.

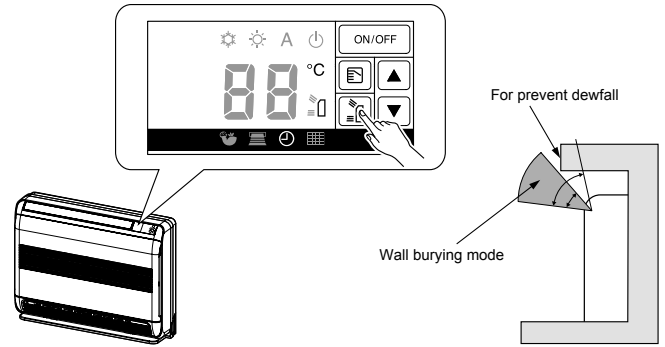

**2. Wall hole size**

Wall hole size should be enough to keep the distance with indoor unit as shown in the following figure.

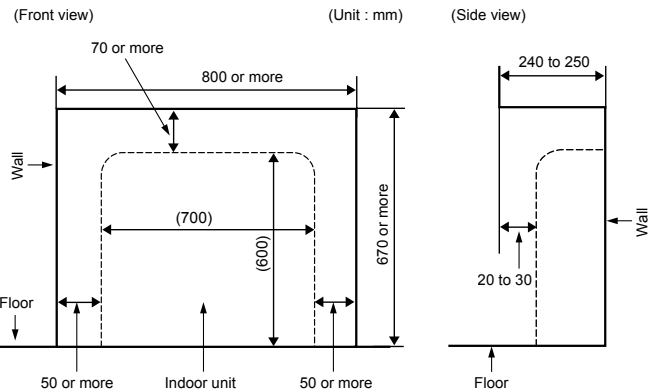

**3. Installation using the supporting plate**

- To install into the existing wall hole, if it is impossible to keep 20-30 mm of depth, use the supporting plate for securing the distance.
- Arrange the screw positions and supporting plate as shown in the figure.
- Be sure to switch to wall burying mode.

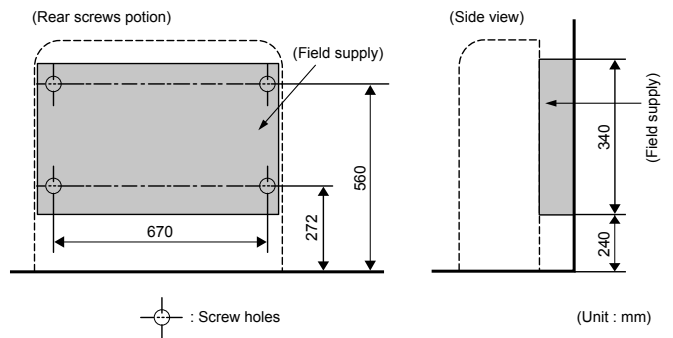

**4. In case of lattice establishment**

- Follow the following figure, make sure to keep enough distance between lattice, frame and wall.
- Be sure to switch to wall burying mode.
- The lattice should be made of wood.
- Between the air inlet and outlet, should be divided with partition board.
- Be sure to establish the open part for RECEIVER.
- The open part of lattice must be 70% or more of the wall hole.
- The open part of lattice must be arranged uniformly.

(Top view) (Unit : mm)

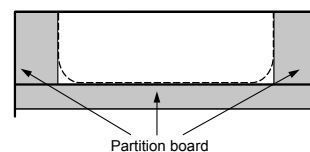

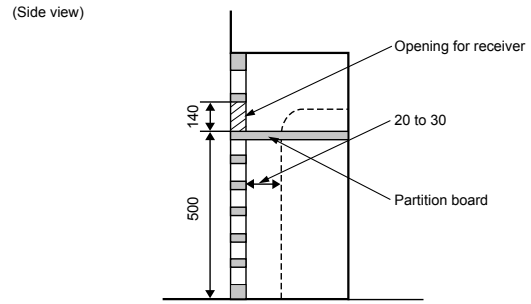
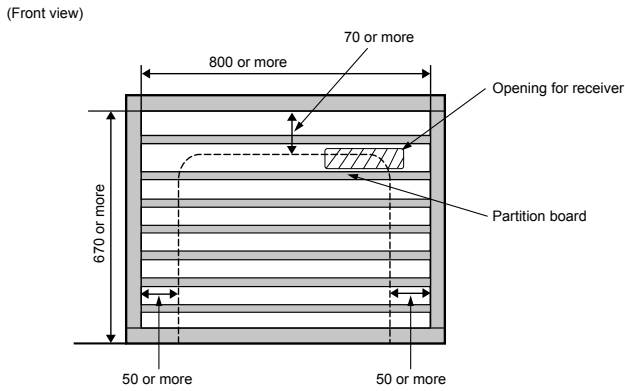

## 10-4. OTHERS

### 10-4-1. Setting of Remote Control Selector Switch

When two indoor units are installed in the separated rooms, it is not necessary to change the selector switches.

#### Remote control selector switch

- When two indoor units are installed in the same room or adjacent two rooms, if operating a unit, two units may receive the remote control signal simultaneously and operate. In this case, the operation can be preserved by setting either one indoor unit or remote control to B setting (Both are set to A setting in factory shipment).
- The remote control signal is not received when the settings of indoor unit and remote control are different.
- There is no relation between A setting/B setting and A room/B room when connecting the piping and cables.

### 10-4-2. Remote Control A-B Selection

To separate using of remote control for each indoor unit in case of 2 air conditioners are installed nearby.

#### Remote Control B Setup.

1. Push and hold **CHK** button on the Remote Control by the tip of the pencil. "00" will be shown on the display (Picture ①).
2. Press **MODE** during pushing **CHK**. "B" will show on the display and "00" will disappear and the air conditioner will turn OFF. The Remote Control B is memorized (Picture ②).

Note : 1. Repeat above step to reset Remote Control to be A.  
2. Remote Control A has not "A" display.  
3. Default setting of Remote Control from factory is A.

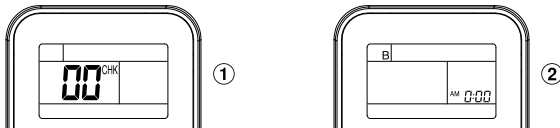

#### Unit B setup.

Press and hold **MODE** button for more than 20 seconds.

When A setup changed to B setup : 5 beeps will sound and operation lamp blinks for 5 seconds.

When B setup changed to A setup : 5 beep will sound.

### 10-4-3. Test Operation

To switch the TEST RUN (COOL) mode, press **OPERATION** button for 10 seconds (The beeper will make a short beep).

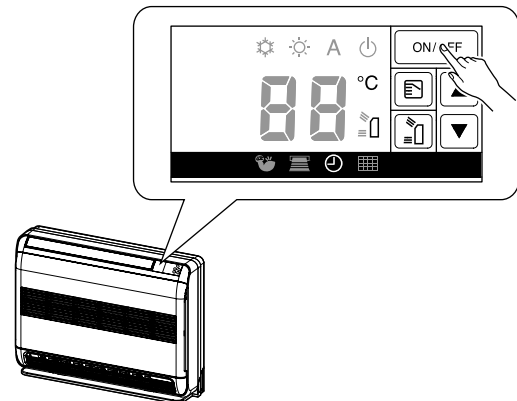

### 10-4-4. Auto Restart Setting

This product is designed so that, after a power failure, it can restart automatically in the same operating mode as before the power failure.

#### Information

The product are shipped with Auto Restart function in the off position. Turn it on as required.

#### How to set the Auto Restart

1. Press and hold **OPERATION** button on the indoor unit for 3 seconds to set the operation (3 beep sound and **OPERATION** lamp blink 5 time/sec for 5 seconds).
2. Press and hold **OPERATION** button on the indoor unit for 3 seconds to cancel the operation (3 beep sound but **OPERATION** lamp does not blink).
  - In case of ON timer or OFF timer are set, it does not activate.

## 11. HOW TO DIAGNOSE THE TROUBLE

The pulse motor circuits are mounted to both indoor and outdoor units. Therefore, diagnose troubles according to the trouble diagnosis procedure as described below. (Refer to the check points in servicing written on the wiring diagrams attached to the indoor/outdoor units.)

**Table 11-1**

No.	Troubleshooting Procedure
1	First Confirmation
2	Primary Judgment
3	Judgment by Flashing LED of Indoor Unit
4	Self-Diagnosis by Remote Controller
5	Judgment of Trouble by Every Symptom

No.	Troubleshooting Procedure
6	Check Code 1C and 1E
7	How to Diagnose Trouble in Outdoor Unit
8	How to Check Simply the Main Parts
9	How to Simply Judge Whether Outdoor Fan Motor is Good or Bad

## 11-1. First Confirmation

### 11-1-1. Confirmation of Power Supply

Confirm that the power breaker operates (ON) normally.

### 11-1-2. Confirmation of Power Voltage

Confirm that power voltage is AC 220–230–240 ± 10%.

If power voltage is not in this range, the unit may not operate normally.

### 11-1-3. Operation Which is not a Trouble (Program Operation)

For controlling the air conditioner, the program operations are built in the microcomputer as described in the following table.

If a claim is made for running operation, check whether or not it meets to the contents in the following table.

When it does, we inform you that it is not trouble of equipment, but it is indispensable for controlling and maintaining of air conditioner.

Table 11-1-1

No.	Operation of air conditioner	Description
1	When power breaker is turned "ON", the operation indicator (Green) of the indoor unit flashes.	The operation indicator of the indoor unit flashes when power source is turned on. If [START/STOP] button is operated once, flashing stops. (Flashes also in power failure)
2	Compressor may not operate even if the room temperature is within range of compressor-ON.	The compressor does not operate while compressor restart delay timer (3-minutes timer) operates. The same phenomenon is found after power source has been turned on because 3-minutes timer operates.
3	In Dry and ECO mode, FAN (air flow) display does not change even though FAN (air flow select) button is operated.	The air flow indication is fixed to [AUTO].
4	Increasing of compressor motor speed stops approx. 30 seconds after operation started, and then compressor motor speed increases again approx. 30 seconds after.	For smooth operation of the compressor, the compressor motor speed is restricted to Max. 41 rps for 2 minutes, and Max.91 rps for 2 minutes to 3 minutes, respectively after the operation has started.
5	In AUTO mode, the operation mode is changed.	After selecting Cool or Heat mode, select an operation mode again if the compressor keeps stop status for 15 minutes.
6	In HEAT mode, the compressor motor speed does not increase up to the maximum speed or decreases before the temperature arrives at the set temperature.	The compressor motor speed may decrease by high-temp. release control (Release protective operation by temp.-up of the indoor heat exchanger) or current release control.

## 11-2. Primary Judgment

To diagnose the troubles, use the following methods.

- 1) Judgment by flashing LED of indoor unit
- 2) Self-diagnosis by service check remote controller
- 3) Judgment of trouble by every symptom

Firstly use the method 1) for diagnosis. Then, use the method 2) or 3) to diagnose the details of troubles.

## 11-3. Judgment by Flashing LED of Indoor Unit

While the indoor unit monitors the operation status of the air conditioner, if the protective circuit operates, the contents of self-diagnosis are displayed with block on the indoor unit indication section.

Table 11-3-1

	Item	Check code	Block display	Description for self-diagnosis
<div style="border: 1px solid black; padding: 5px; width: fit-content;">Indoor indication lamp flashes.</div> <div style="margin-left: 20px;">↓</div> <div style="border: 1px solid black; padding: 5px; width: fit-content;">Which lamp does flash?</div> <div style="margin-left: 20px;">↓</div> <div style="margin-left: 20px;">→</div>	A	—	OPERATION (Green) Flashing display (1 Hz)	Power failure (when power is ON)
	B	00	OPERATION (Green) Flashing display (5 Hz)	Protective circuit operation for indoor P.C. board
	C	01	OPERATION (Green) TIMER (Yellow) Flashing display (5 Hz)	Protective circuit operation for connecting cable and serial signal system
	D	02	OPERATION (Green) FILTER (Orange) Flashing display (5 Hz)	Protective circuit operation for outdoor P.C. board
	E	03	OPERATION (Green) TIMER (Yellow) FILTER (Orange) Flashing display (5 Hz)	Protective circuit operation for others (including compressor)

### NOTES :

1. The contents of items B and C and a part of item E are displayed when air conditioner operates.
2. When item B and C, and item B and a part of item E occur concurrently, priority is given to the block of item B.
3. The check codes can be confirmed on the remote controller for servicing.

### 11-4. Self-Diagnosis by Remote Controller (Check Code)

1. If the lamps are indicated as shown B to E in Table 11-3-1, execute the self-diagnosis by the remote controller.
2. When the remote controller is set to the service mode, the indoor controller diagnoses the operation condition and indicates the information of the self-diagnosis on the display of the remote controller with the check codes. If a fault is detected, all lamps on the indoor unit will flash at 5Hz and it will beep for 10 seconds (Beep, Beep, Beep ... ). The timer lamp usually flashes (5Hz) during self-diagnosis.

#### 11-4-1. How to Use Remote Controller in Service Mode

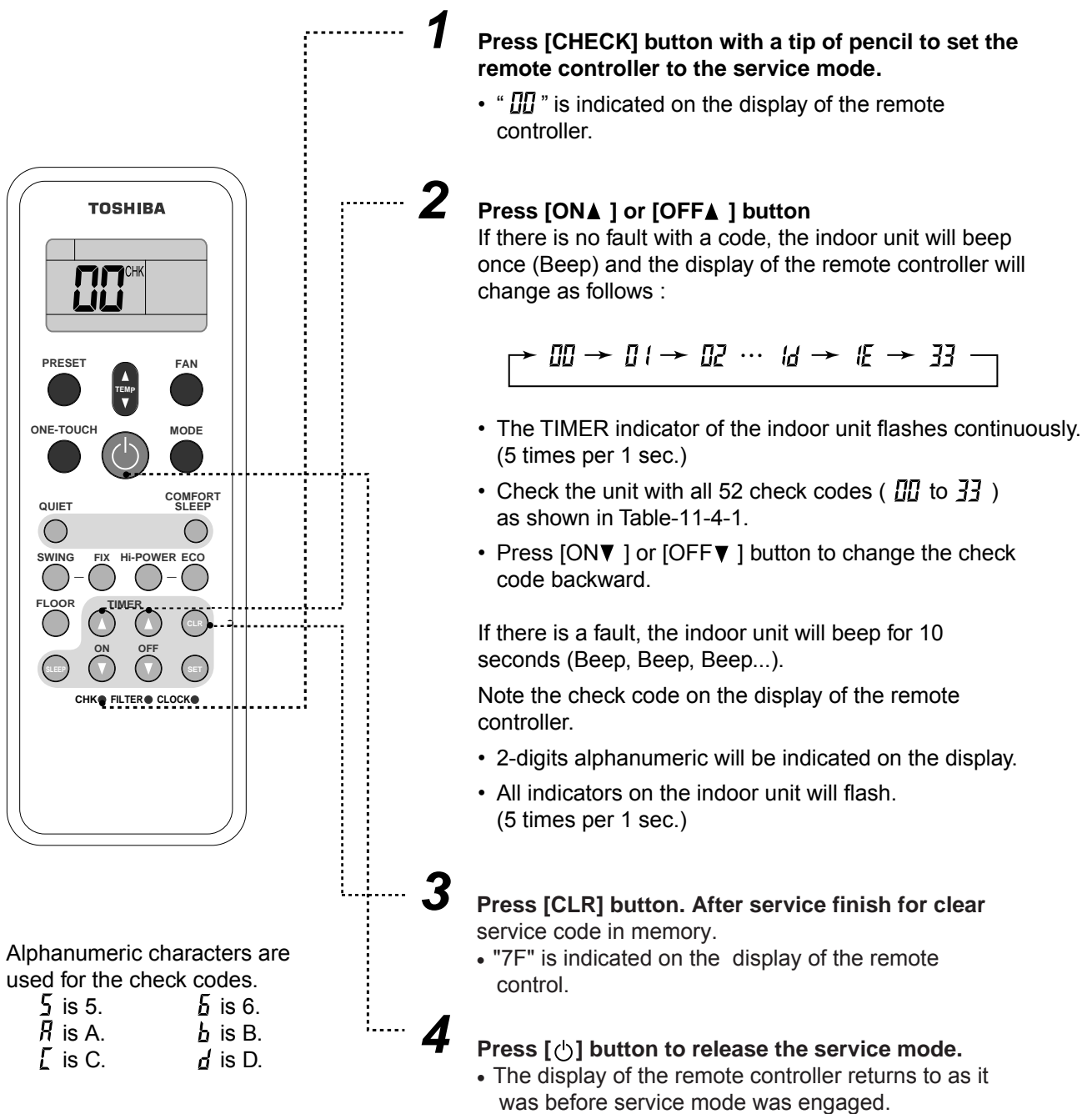

Fig. 11-4-1



**11-4-2 Caution at Servicing**

1. After using the service mode of remote controller finished, press the [⏻] button to reset the remote controller to normal function.
2. After finished the diagnosis by the remote controller, turn OFF power supply and turn its ON again to reset the air conditioner to normal operation. However, the check codes are not deleted from memory of the microcomputer.
3. After servicing finished, press [CLR] button of remote controller under service mode status to send code "7F" to the indoor unit. The check code stored in memory is cleared.

Table 11-4-1

Block distinction		Operation of diagnosis function				Action and Judgment
Check code	Block	Check code	Cause of operation	Air conditioner status	Display flashing error	
00	Indoor P.C. board.	01	TA sensor ; The room temperature sensor is short-Circuit or disconnection.	Operation continues.	Flashes when error is detected.	1. Check the sensor TA and connection. 2. In case of the sensor and its connection is normal, check the P.C. board.
		02	TC sensor ; The heat exchanger temperature sensor of the indoor unit is out of place, disconnection, short-circuit or migration.	Operation continues.	Flashes when error is detected.	1. Check the sensor TC and connection. 2. In case of the sensor and its connection is normal, check the P.C. board.
		11	Fan motor of the indoor unit is failure, lock-rotor, short-circuit, disconnection, etc. Or its circuit on P.C. board has problem.	All OFF	Flashes when error is detected.	1. Check the fan motor and connection. 2. In case of the motor and its connection is normal, check the P.C. board.
		12	Other trouble on the indoor P.C. board.	Depend on cause of failure.	Depend on cause of failure.	Replace P.C. board.

Block distinction		Operation of diagnosis function				Action and Judgment
Check code	Block	Check code	Cause of operation	Air conditioner status	Display flashing error	
01	Serial signal and connecting cable.	04	1) Defective wiring of the connecting cable or miss-wiring. 2) Operation signal has not send from the indoor unit when operation start. 3) Outdoor unit has not send return signal to the indoor unit when operation started. 4) Return signal from the outdoor unit is stop during operation. <ul style="list-style-type: none"> <li>• Some protector (hardware, if exist) of the outdoor unit open circuit of signal.</li> <li>• Signal circuit of indoor P.C. board or outdoor P.C. board is failure in some period.</li> </ul>	Indoor unit operates continue. Outdoor unit stop.	Flashes when error is detected. Flashing stop and outdoor unit start to operate when the return signal from the outdoor unit is normal.	1) to 3) The outdoor unit never operate. <ul style="list-style-type: none"> <li>• Check connecting cable and correct if defective wiring.</li> <li>• Check 25A fuse of inverter P.C. board.</li> <li>• Check 3.15A fuse of inverter P.C. board.</li> <li>• Check operation signal of the indoor unit by using diode. Measure voltage at terminal block of the indoor unit between No.2 and No.3 (or L2 and S)</li> </ul> If signal is varied 15-60V continuously, replace inverter P.C. board. If signal is not varied, replace indoor P.C. board. 4) The outdoor unit abnormal stop at some time. <ul style="list-style-type: none"> <li>• If the other check codes are found concurrently, check them together.</li> <li>• Check protector (hardware) such as Hi-Pressure switch, Thermal-Relay, etc.</li> <li>• Check refrigerant amount or any possibility case which may caused high temperature or high pressure.</li> <li>• Check operation signal of the indoor unit by using diode. Measure voltage at terminal block of the indoor unit between No.2 and No.3 (or L2 and S)</li> </ul> If signal is varied 15-60V continuously, replace inverter P.C. board. If signal is not varied, replace indoor P.C. board.

**Note : Operation signal of the indoor unit shall be measured in the sending period as picture below.**

**Sending signal of the indoor unit when have not return signal from the outdoor unit.**

\* Signal send only 1 minute and stop. Because of return signal from outdoor unit has not received.  
 \*\* Signal resend again after 3 minutes stop. And the signal will send continuously.  
 \*\*\* 1 minute after resending, the indoor unit display flashes error.

Block distinction		Operation of diagnosis function				Action and Judgment
Check code	Block	Check code	Cause of operation	Air conditioner status	Display flashing error	
02	Outdoor P.C. board	14	Current on inverter circuit is over limit in short time. <ul style="list-style-type: none"> <li>• Inverter P.C. board is failure, IGBT shortage, etc.</li> <li>• Compressor current is higher than limitation, lock rotor, etc.</li> </ul>	All OFF	Flashes after error is detected 8 times*.	<ol style="list-style-type: none"> <li>1. Remove connecting lead wire of the compressor, and operate again.</li> <li>2. If outdoor fan does not operate or operate but stop after some period, replace the inverter P.C. board.</li> <li>3. If outdoor fan operates normally, measure 3-Phase output of inverter P.C. board (150-270VAC) at the connecting lead wire of compressor.</li> <li>4. If 3-Phase output is abnormal, replace inverter P.C.Board.</li> <li>5. If 3-Phase output is normal, replace compressor. (lock rotor, etc.)</li> </ol>
		15	Compressor position-detect circuit error or short-circuit between winding of compressor.	All OFF	Flashes after error is detected 8 times*.	<ol style="list-style-type: none"> <li>1. Remove connecting lead wire of the compressor, and operate again.</li> <li>2. If outdoor fan does not operate or operation but stop after some period, replace the inverter P.C. board.</li> <li>3. If outdoor fan operates normally, measure resistance of compressor winding. If circuit is shortage, replace the compressor.</li> </ol>
		17	Current-detect circuit of inverter P.C. board error.	All OFF	Flashes after error is detected 4 times*.	Even if trying to operate again, all operations stop, replace inverter P.C. board.
		18	TE or TS sensor; abnormal. Out of place, disconnection, shortage, or misconnection (TE sensor is connected to TS connector, TS sensor is connected to TE sensor connector)  TE sensor; Outdoor heat exchanger temperature sensor  TS sensor; Suction pipe temperature sensor	All OFF	Flashes after error is detected 4 times*.	<ol style="list-style-type: none"> <li>1. Check sensors, TE, TS connection. In case of sensors and it's connection is normal, check the inverter P.C. board</li> <li>2. Check 4way valve operation/position. In case TE, TS detected temperature relationship are different from normal operation, "18" might be detected.</li> </ol>
		19	TD sensor ; Discharge pipe temperature sensor is disconnection or shortage.	All OFF	Flashes after error is detected 4 times*.	<ol style="list-style-type: none"> <li>1. Check sensors TD and connection.</li> <li>2. In case of the sensor and its connection is normal, check the inverter P.C. board.</li> </ol>
		1A	Outdoor fan failure or its drive-circuit on the inverter P.C. board failure.	All OFF	Flashes after error is detected 8 times*.	<ol style="list-style-type: none"> <li>1. Check the motor, measure winding resistance, shortage or lock rotor.</li> <li>2. Check the inverter P.C. board.</li> </ol>
		1b	TO sensor ; The outdoor temperature sensor is disconnection or shortage.	Operation continues.	Record error after detected 4 times*. But does not flash display.	<ol style="list-style-type: none"> <li>1. Check sensors TO and connection.</li> <li>2. In case of the sensor and its connection is normal, check the inverter P.C. board.</li> </ol>

Block distinction		Operation of diagnosis function				Action and Judgment
Check code	Block	Check code	Cause of operation	Air conditioner status	Display flashing error	
02	Outdoor P.C. board	11	<p>Compressor drive output error. (Relation of voltage, current and frequency is abnormal)</p> <ul style="list-style-type: none"> <li>Overloading operation of compressor caused by over-charge refrigerant, P.M.V. failure, etc.</li> <li>Compressor failure (High current).</li> </ul>	All OFF	Flashes after error is detected 8 times*.	<ol style="list-style-type: none"> <li>Check installation conditions such as packed valve opening, refrigerant amount and power supply (rate <math>\pm 10\%</math>, both of operation and non operation condition).</li> <li>(In case of P.M.V. exists) Check P.M.V. by measure the resistance of the coil and confirm its operation (sound of initial operation, etc.)</li> <li>Observe any possibility cause which may affect operation load of compressor.</li> <li>Operate again. If compressor operation is failure when 20 seconds passed (count time from operation starting of compressor), replace compressor.</li> </ol>
<p>* 4 or 8 times ; When first error is detected, error is count as 1 time, then once operation is stop and re-started.</p> <p>After re-starting operation within 6 minutes, if same error is detected, error count is add (count become 2 times)</p> <p>When error count comes 4, 8, 11 or 18 times, record error to check code. But after re-starting operation, if no error is detected and air conditioner can operate more than 6 minutes, error count is cleared.</p>						
03	The others (including compressor)	07	<p>Return signal of the outdoor unit has been sent when operation start. But after that, signal is stop some time.</p> <ul style="list-style-type: none"> <li>Instantaneous power failure.</li> <li>Some protector (hardware) of the outdoor unit open circuit of signal.</li> <li>Signal circuit of indoor P.C. board or outdoor P.C. board is failure in some period.</li> </ul>	Indoor unit operates continue. Outdoor unit stop.	Flashes when error is detected. Flashing stop and outdoor unit start to operate when the return signal from the outdoor unit is normal.	<ol style="list-style-type: none"> <li>Check power supply (Rate <math>\pm 10\%</math>)</li> <li>If the air conditioner repeat operates and stop with interval of approx. 10 to 40 minutes. <ul style="list-style-type: none"> <li>(In case of these exist) Check protector (hardware) such as Hi-Pressure switch, Thermal-Relay, etc.</li> <li>Check refrigerant amount, packed valve opening and any possibility cause which may affect high temperature or high pressure.</li> </ul> </li> <li>Check operation signal of the indoor unit by using diode. Measure voltage at terminal block of the indoor unit between No.2 and No.3 (or L2 and S) If signal is varied 15-60V continuously, replace inverter P.C. board. If signal is not varied, replace indoor P.C. board.</li> </ol>

Block distinction		Operation of diagnosis function				Action and Judgment
Check code	Block	Check code	Cause of operation	Air conditioner status	Display flashing error	
03	The others (including compressor)	1d	Compressor does not rotate. Because of missed wiring, missed phase or shortage.	All OFF	Flashes after error is detected 8 times*.	<ol style="list-style-type: none"> <li>1. Remove connecting lead wire of the compressor, and operate again.</li> <li>2. If outdoor fan does not operate or operation but stop after some period, replace the inverter P.C. board.</li> <li>3. If outdoor fan operates normally, measure 3-Phase output of inverter P.C. board (150-270VAC) at the connecting lead wire of compressor.</li> <li>4. If 3-Phase output is abnormal, replace inverter P.C.Board.</li> <li>5. If 3-Phase output is normal, measure resistance of compressor winding.</li> <li>6. If winding is shortage, replace the compressor.</li> </ol>
		1E	Discharge temperature exceeded 117°C.	All OFF	Flashes after error is detected 4 times*.	<ol style="list-style-type: none"> <li>1. Check sensors TD.</li> <li>2. Check refrigerant amount.</li> <li>3. (In case of P.M.V. exists) Check P.M.V. by measure the resistance of the coil and confirm its operation (sound of initial operation, etc.)</li> <li>4. Observe any possibility cause which may affect high temperature of compressor.</li> </ol>
		1F	Compressor is high current though operation Hz is decreased to minimum limit. <ul style="list-style-type: none"> <li>● Installation problem.</li> <li>● Instantaneous power failure.</li> <li>● Refrigeration cycle problem.</li> <li>● Compressor break down.</li> <li>● Compressor failure (High current).operation, etc.)</li> </ul>	All OFF	Flashes after error is detected 8 times*.	<ol style="list-style-type: none"> <li>1. Check installation conditions such as packed valve opening, refrigerant amount and power supply (rate <math>\pm 10\%</math>, both of operation and non operation condition).</li> <li>2. (In case of P.M.V. exists) Check P.M.V. by measure the resistance of the coil and confirm its operation (sound of initial operation, etc.)</li> <li>3. Observe any possibility cause which may affect high current of compressor.</li> <li>4. If 1, 2 and 3 are normal, replace compressor.</li> </ol>

Block distinction		Operation of diagnosis function				Action and Judgment
Check code	Block	Check code	Cause of operation	Air conditioner status	Display flashing error	
03	The others (including compressor)	21	<p>Return signal of the outdoor unit has been sent when operation start. But after that, signal is stop some time.</p> <ul style="list-style-type: none"> <li>Instantaneous power failure.</li> <li>Some protector (hardware) of the outdoor unit open circuit of signal.</li> <li>Signal circuit of indoor P.C. board or outdoor P.C. board is failure in some period.</li> <li>TE, TC high temperature TE for cooling operation TC for heating operation. (TE only exists in the Heat Pump system)</li> <li>TE or TS sensor; abnormal. Out of place, disconnection, shortage, or misconnection (TE sensor is connected to TS connector, TS sensor is connected to TE sensor connector)</li> </ul> <p>TE sensor; Outdoor heat exchanger temperature sensor TS sensor; Suction pipe temperature sensor</p>	Indoor unit operates continue. Outdoor unit stop.	Flashes when error is detected 11 times*. Flashing stop and outdoor unit start to operate when the return signal from the outdoor unit is normal.	<ol style="list-style-type: none"> <li>Check power supply (Rate <math>\pm 10\%</math>)</li> <li>If the air conditioner repeat operat and stop with interval of approx. 10 to 40 minutes. <ul style="list-style-type: none"> <li>(In case of these exist) Check protector (hardware) such as Hi-Pressure switch, Thermal-Relay, etc.</li> <li>Check refrigerant amount, packed valve opening and any possibility cause which may affect high temperature or high pressure.</li> </ul> </li> <li>Check operation signal of the indoor unit by using diode. Measure voltage at terminal block of the indoor unit between No.2 and No.3 (or L2 and S) If signal is varied 15-60V continuously, replace inverter P.C. board. If signal is not varied, replace indoor P.C. board.</li> <li>Check and clean heat exchanger area Indoor and Outdoor unit.</li> <li>Check sensors, TE, TS connection. In case of sensors and it's connection is normal, check the inverter P.C. board.</li> <li>Check 4way valve operation/position. In case TE, TS detected temperature relationship are different from normal operation, "18" might be detected.</li> </ol>
<p>* 4, 8 or 11 times ; When first error is detected, error is count as 1 time, then once operation is stop and re-started. After re-starting operation within 6 minutes, if same error is detected, error count is add (count become 2 times) When error count comes 4, 8, 11 or 18 times, record error to check code. But after re-starting operation, if no error is detected and air conditioner can operate more than 6 minutes, error count is cleared.</p>						

### 11-5. Judgment of Trouble by Every Symptom

#### 11-5-1. Indoor Unit (Including Remote Controller)

##### (1) Power is not turned on (Does not operate entirely)

###### <Primary check>

1. Is the supply voltage normal?
2. Is the normal voltage provided to the outdoor unit?
3. Is the crossover cable connected properly?
4. Is the fuse (F01) blown?

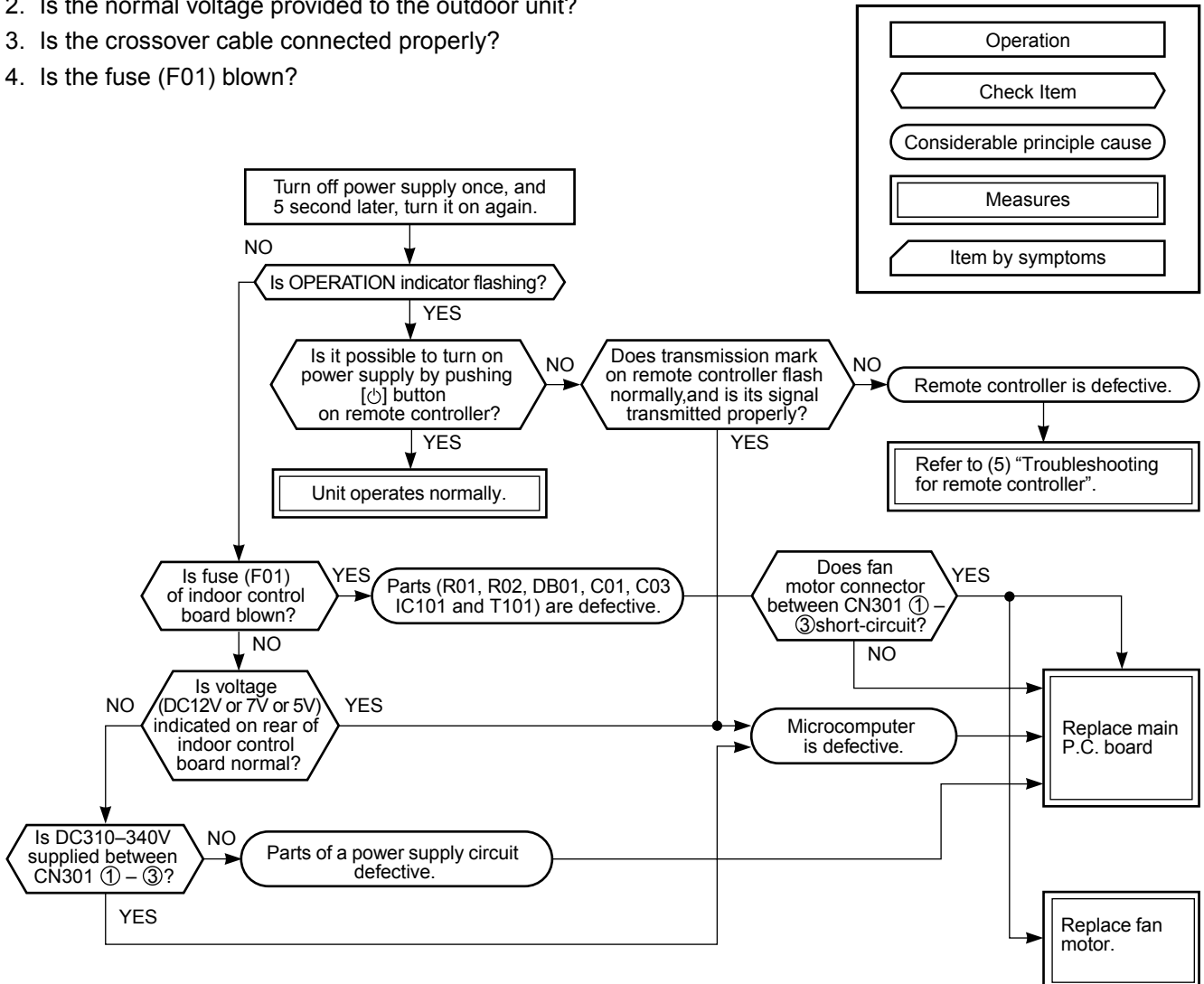

- Be sure to disconnect the motor connector CN301 after shut off the power supply, or it will be a cause of damage of the motor.

##### (2) Power is not turned on though Indoor P.C. board is replaced

###### <Confirmation procedure>

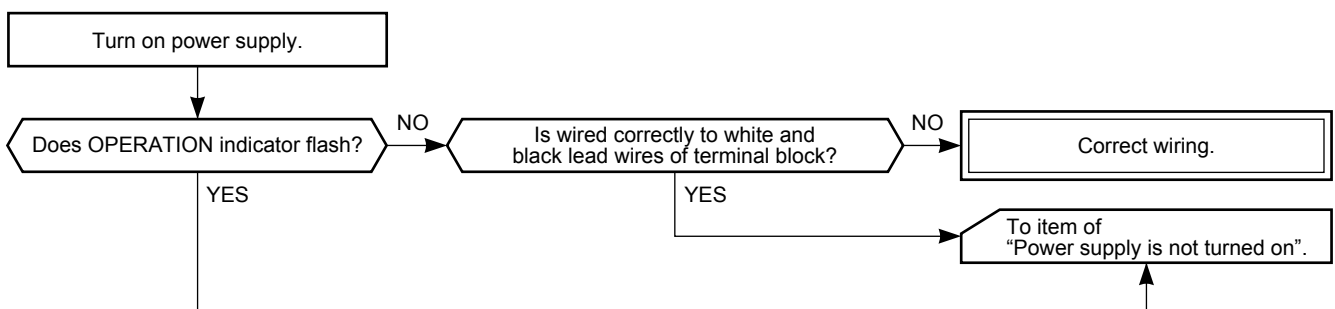

**(3) Only the indoor motor fan does not operate**

**<Primary check>**

1. Is it possible to detect the power supply voltage (AC220–240V) between ① and ② on the terminal block?
2. Does the indoor fan motor operate in cooling operation?  
(In heating operation, the indoor fan motor does not operate for approximately 10 minutes after it is turned on, to prevent a cold air from blowing in.)

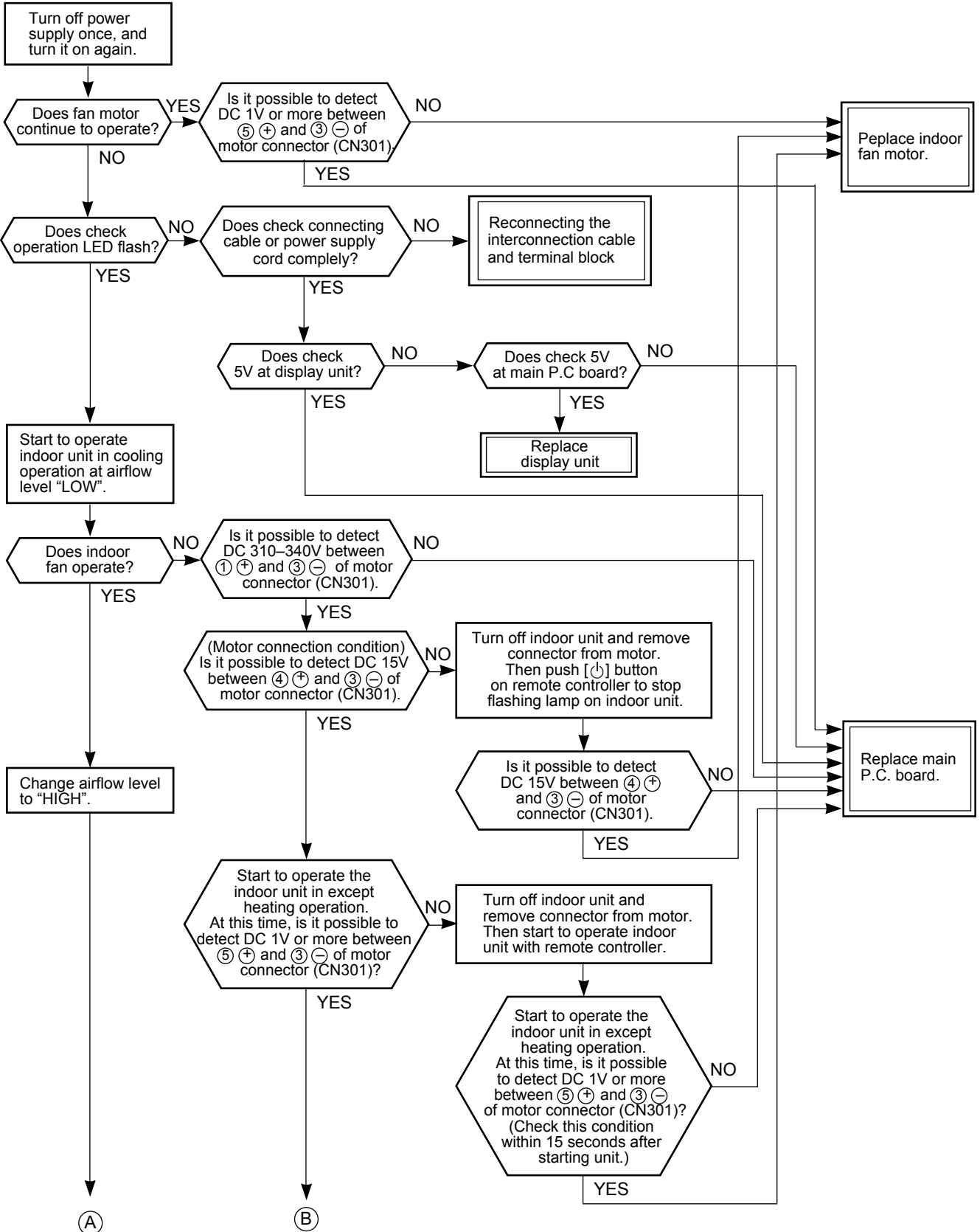



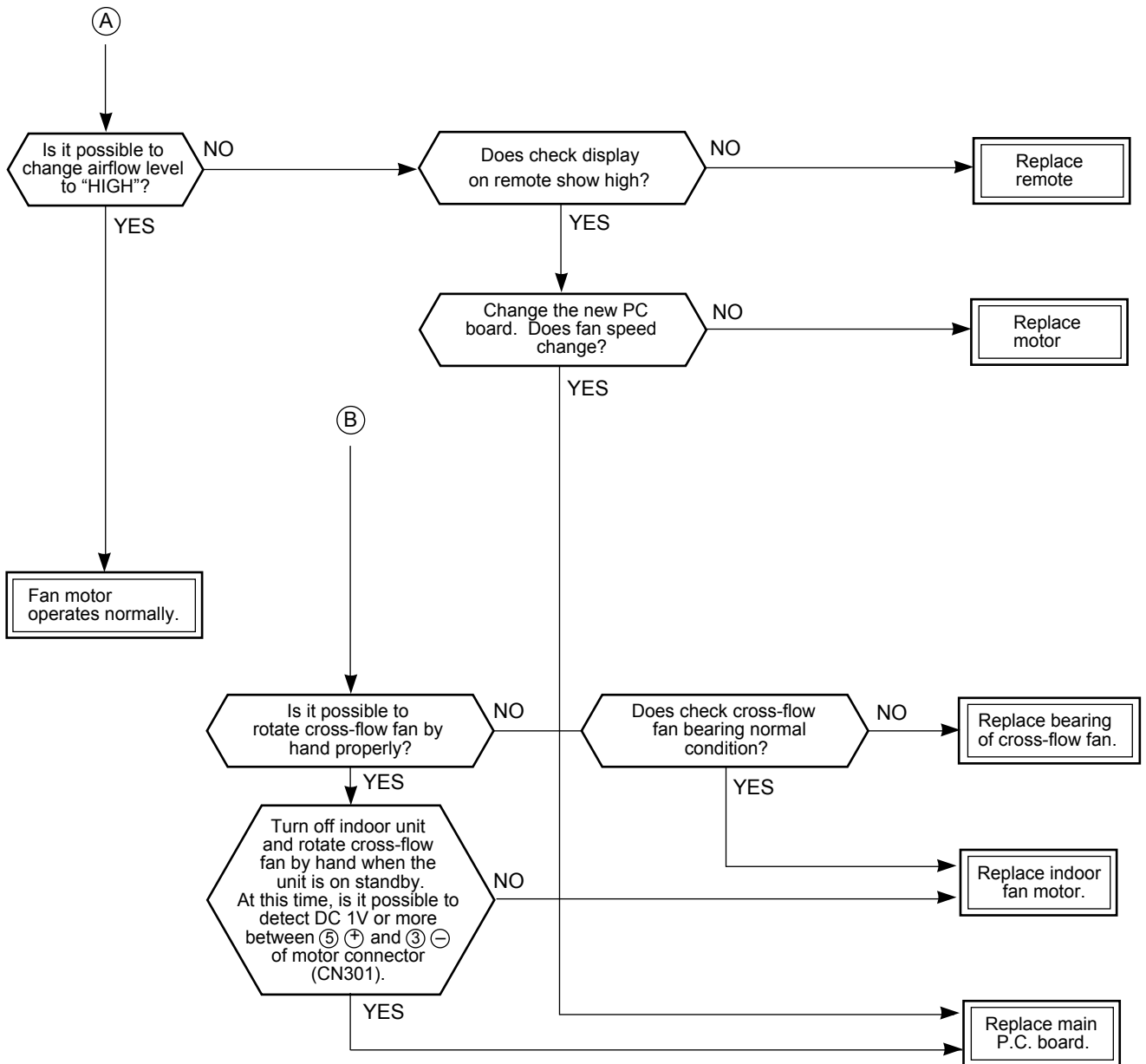

**(4) Indoor fan motor automatically starts to rotate by turning on power supply**

**<Cause>**

The IC is built in the indoor fan motor. Therefore the P.C. board is also mounted to inside of the motor.

If the P.C. board is soldered imperfectly or the IC is defective, the fan motor may automatically rotate by turning on power supply.

**<Inspection procedure>**

1. Remove the front panel. (Remove 4 screws.)
2. Remove the cover of the indoor unit controller. (remove 1 screw.)
3. Check DC voltage with CN301 connector while the fan motor is rotating.

**NOTE :**

- Do not disconnect the connector while the fan motor is rotating.
- Use a thin test rod.

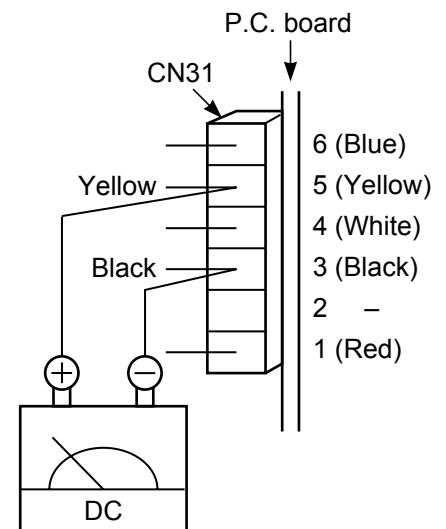
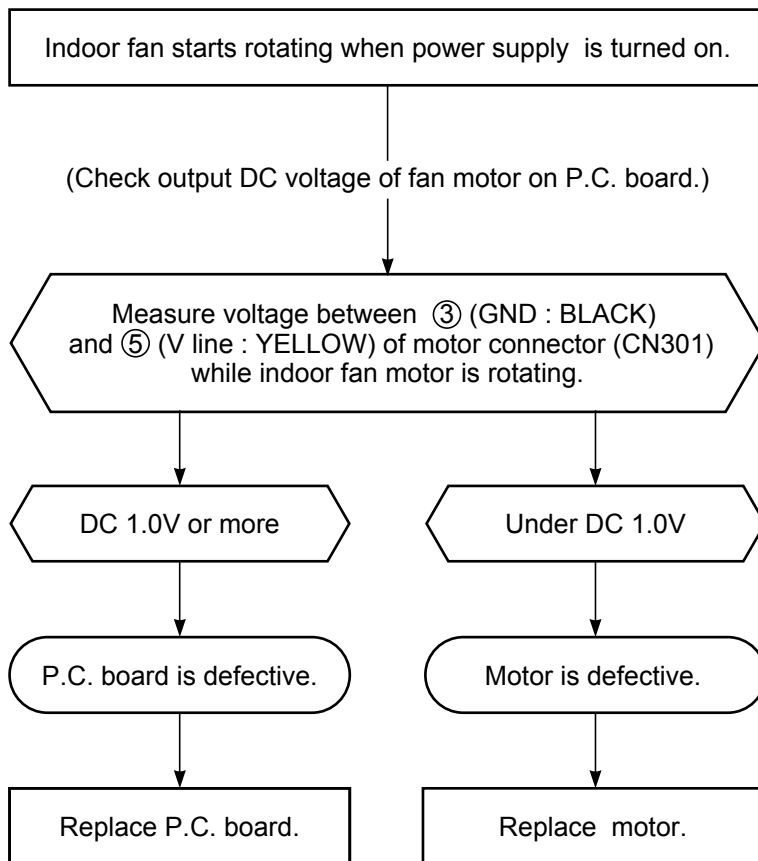

**(5) Troubleshooting for remote control**

**<Primary check>**

Check that A or B selected on the main unit is matched with A or B selected on the remote control.

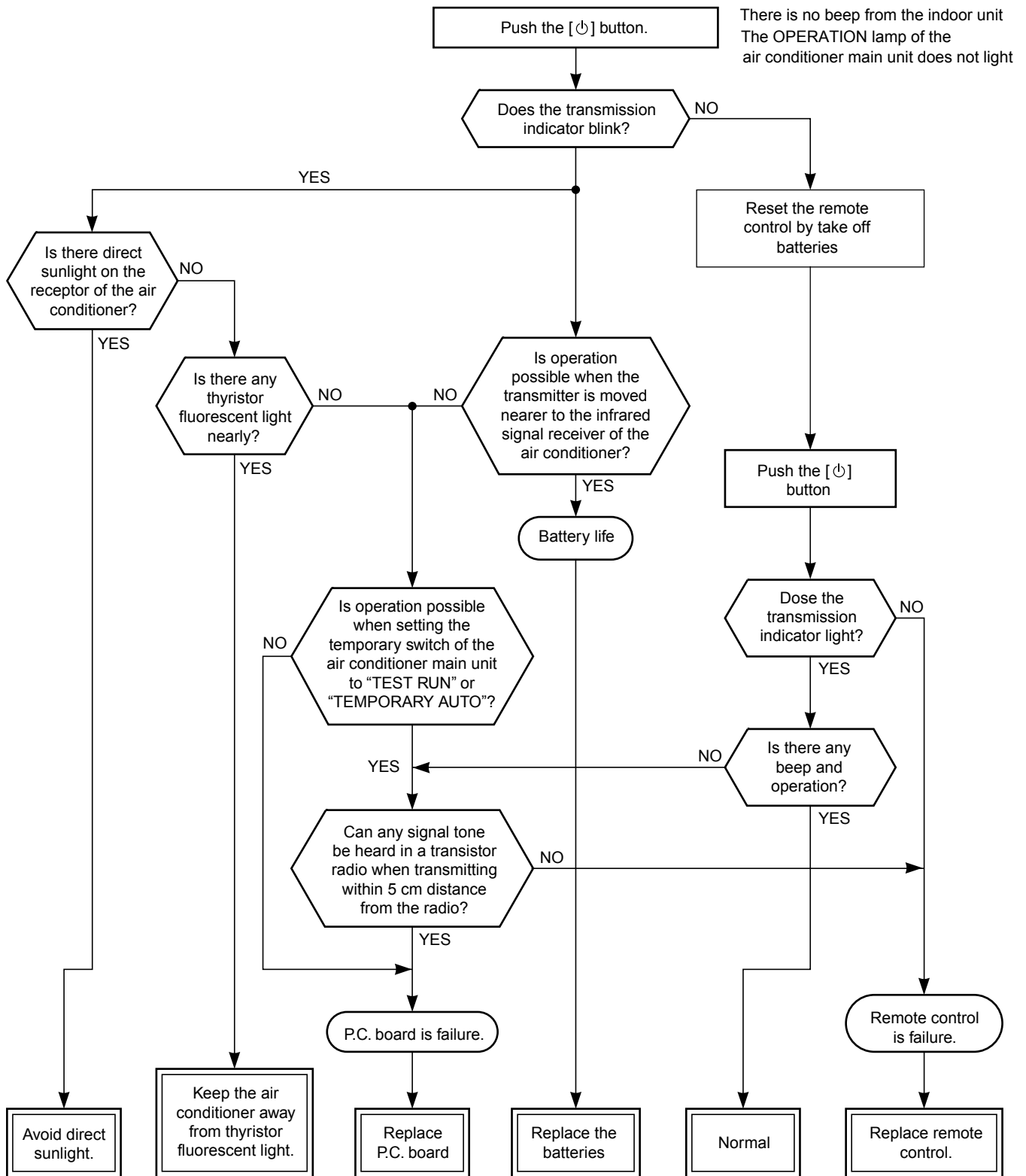

**11-5-2. Wiring Failure (Interconnecting and Serial Signal Wire)**

**(1) Outdoor unit does not operate**

1) Is the voltage between ② and ③ of the indoor terminal block varied?

Confirm that transmission from indoor unit to outdoor unit is correctly performed based upon the following diagram.

**NOTE:**

- Measurement should be performed 2 minutes and 30 seconds after starting of the operation.
- Be sure to prepare a diode for judgment.

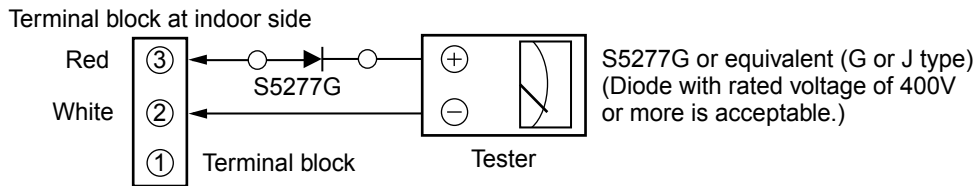

Normal time : Voltage swings between DC15 and 60V. .... Inverter Assembly check (11-7-1.)

Abnormal time : Voltage does not vary.

**(2) Outdoor unit stops in a little while after operation started**

**<Check procedure> Select phenomena described below.**

1) The outdoor unit stops 10 to 20 minutes after operation started, and 10 minutes or more are required to restart the unit.

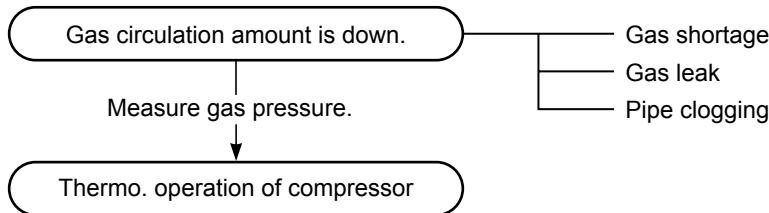

2) If the unit stops once, it does not operate until the power will be turned on again.

To item of Outdoor unit does not operate.

3) The outdoor unit stops 10 minutes to 1 hour after operation started, and an alarm is displayed. (Discharge temp. error check code 03, 1E Sensor temp. error check code 02, 1C)

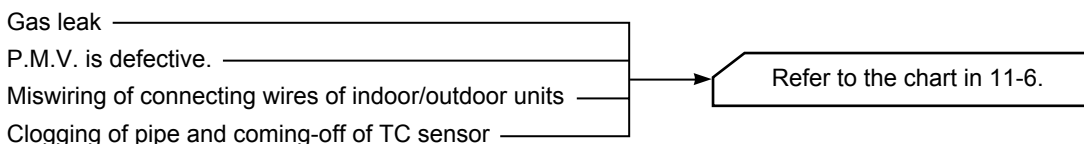

## 11-6. Check Code 1C (Miswiring in indoor/outdoor units) and 1E

<Check procedure>

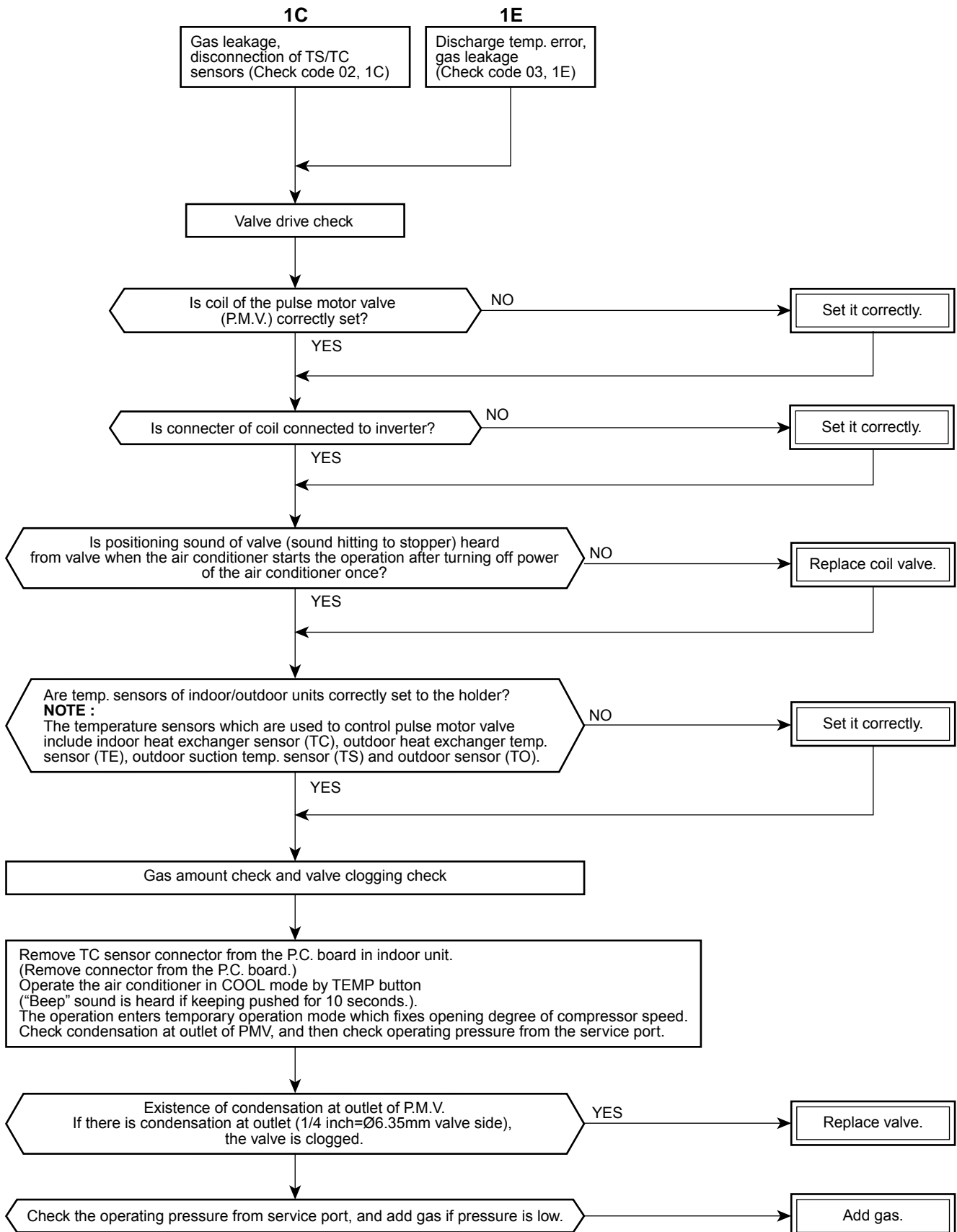

### 11-7. How to Diagnose Trouble in Outdoor Unit

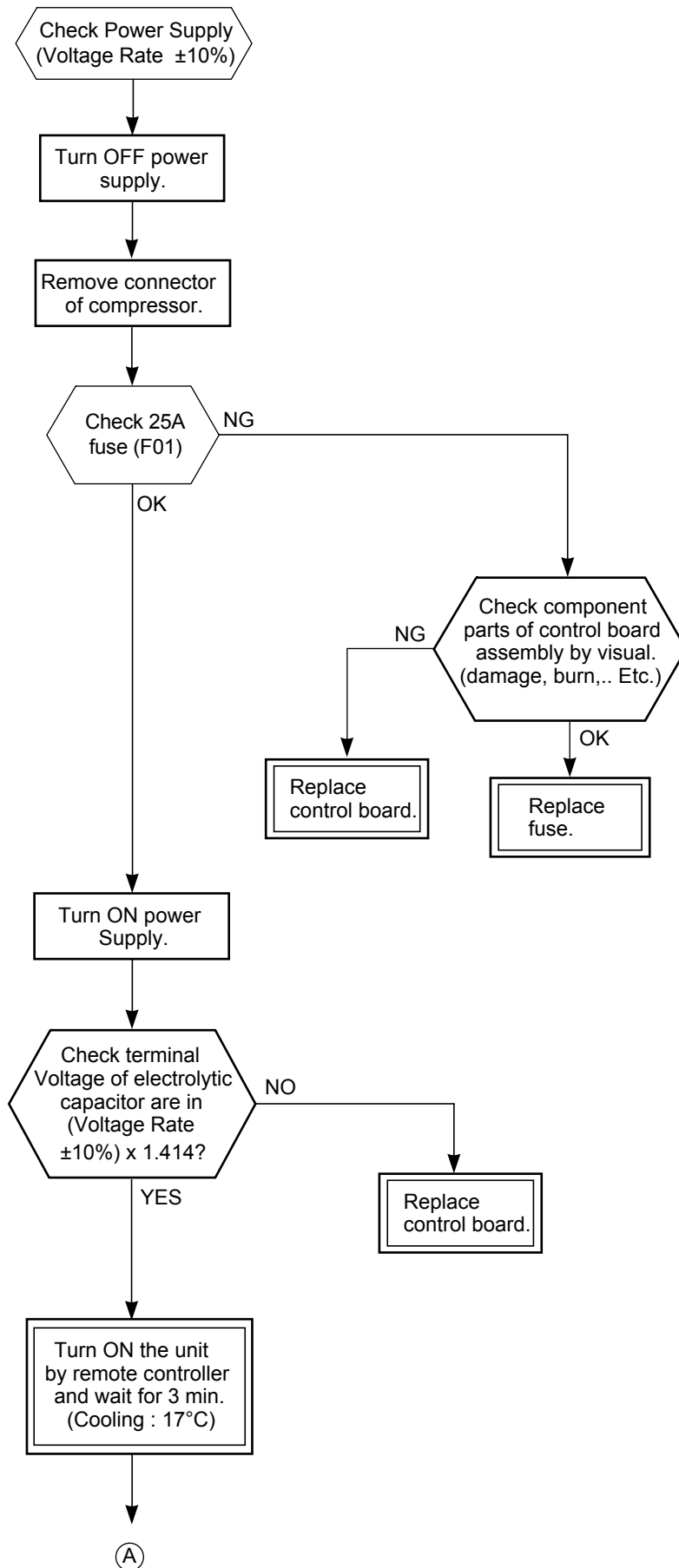

- Connect discharge resistance (approx. 100Ω, 40W) or soldering iron (plug) between +, – terminals of the electrolytic capacitor (500μF or 760μF)

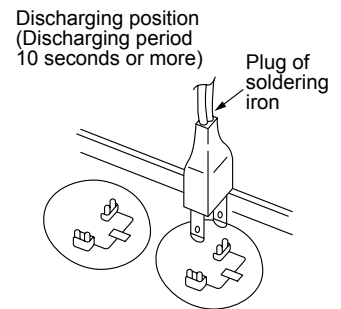

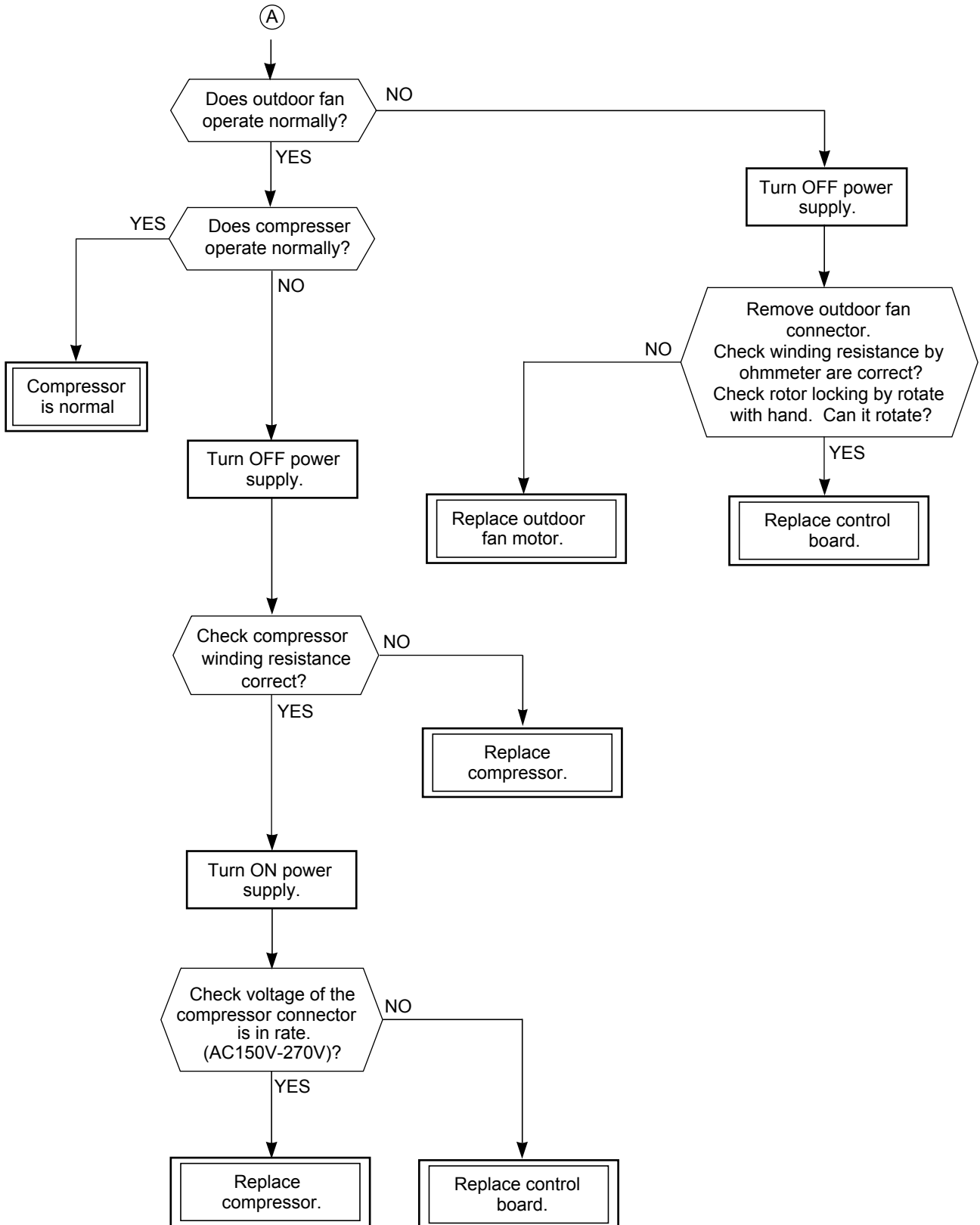

## **11-8. How to Check Simply the Main Parts**

### **8-1. How to Check the P.C. Board (Indoor Unit)**

#### **(1) Operating precautions**

- 1) When removing the front panel or the P.C. board, be sure to shut off the power supply breaker.
- 2) When removing the P.C. board, hold the edge of the P.C. board and do not apply force to the parts.
- 3) When connecting or disconnecting the connectors on the P.C. board, hold the whole housing. Do not pull at the lead wire.

#### **(2) Inspection procedures**

- 1) When a P.C. board is judged to be defective, check for disconnection, burning, or discoloration of the copper foil pattern or this P.C. board.
- 2) The P.C. board consists of the following 2 parts

##### **a. Main P.C. board part :**

DC power supply circuit, Indoor fan motor control circuit, CPU and peripheral circuits, buzzer, and Driving circuit of louver.

##### **b. Indication unit of infrared ray receiving infrared ray receiving circuit, LED :**

To check defect of the P.C. board, follow the procedure described below.



## (3) Check procedures

Table 11-8-1

No.	Procedure	Check points	Causes
1	Turn off the power supply breaker and remove the P.C. board assembly from electronic parts base. Remove the connecting cables from the terminal block.	Check whether or not the fuse (F01) is blown.	Impulse voltage was applied or the indoor fan motor short-circuited.
2	Remove the connector of the motor and turn on the power supply breaker. If OPERATION indicator flashes (once per second), it is not necessary to check steps (1 to 3) in the right next column.	Check power supply voltage : 1. Between CN01 and No. 3 of CN301 (AC 220–240V) 2. Between ⊕ and ⊖ of C03 (DC 310–340V) 3. Between ⊖ of IC122 and output side of IC122 (DC15V) 4. Between 12V and GND 5. Between 5V and GND	1. The terminal block or the crossover cable is connected wrongly. 2. The fuse (F01), line filter (L01), resistor (R02), of the diode (DB01) is defective. 3. TC122 and T101 are defective. 4. D122, TC124 and T101 are defective 5. IC121, IC124, IC102, D121 and T101 are defective.
3	Push [⏻] button once to start the unit. (Do not set the mode to On-Timer operation.)	Check power supply voltage : 1. Between CN01 and CN501 (DC 15–60V)	IC501 and IC502 are defective.
4	Shorten the restart delay timer and start unit.	Check whether or not all indicators (OPERATION, TIMER, FILTER) are lit for 3 seconds and they return to normal 3 seconds later.	The indicators are defective or the housing assembly (CN51) display PCB is defective.
5	Push [⏻] button once to start the unit, • Shorten the restart delay timer. • Set the operation mode to COOL. • Set the fan speed level to AUTO. • Set the preset temperature much lower than the room temperature. (The unit (compressor) operates continuously in the above condition.)	1. Check whether or not the compressor operates. 2. Check whether or not the OPERATION indicator flashes.	1. The temperature of the indoor heat exchanger is extremely low. 2. The connection of the heat exchanger sensor is loose. (The connector is disconnected.) (CN602 and CN603) 3. The heat exchanger sensor and the P.C. board are defective. (Refer to Table 11-4-1.) 4. The main P.C. board is defective.
6	If the above condition (No. 5) still continues, start the unit in the following condition. • Set the operation mode to HEAT. • Set the preset temperature much higher than room temperature.	1. Check whether or not the compressor operates. 2. Check whether or not the OPERATION indicator flashes.	1. The temperature of the indoor heat exchanger is extremely high. 2. The connection of the heat exchanger sensor short-circuited. (CN602 and CN603) 3. The heat exchanger sensor and the P.C. board are defective. (Refer to Table 11-4-1.) 4. The main P.C. board is defective
7	Connect the motor connector to the motor and turn on the power supply. Start the unit the following condition. • Set the fan speed level to HIGH. (The unit (compressor) operates continuously in the above condition in No. 5.)	1. Check it is impossible to detect the voltage (AC120V or higher voltage) between red and black lead of the motor. 2. The motor does not operate or the fan motor does not rotate with high speed. (But it is possible to receive the signal from the remote controller.) 3. The motor rotates but vibrates strongly.	1. The indoor fan motor is defective. (Protected operation of P.C. board.) 2. The P.C. board is defective. 3. The connection of the motor connector is loose.

11-8-2. P.C . Board Layout

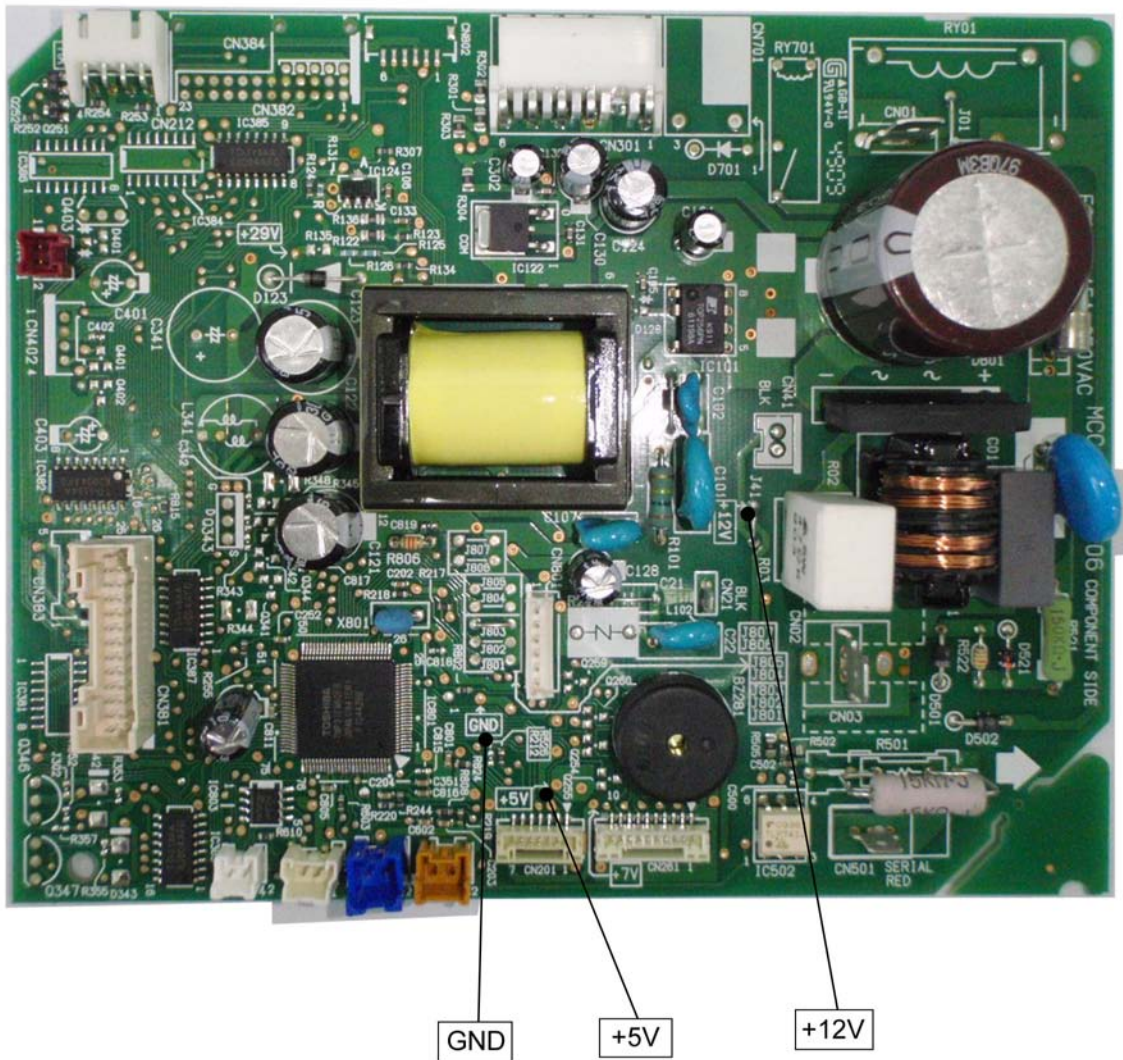

[1] Sensor characteristic table

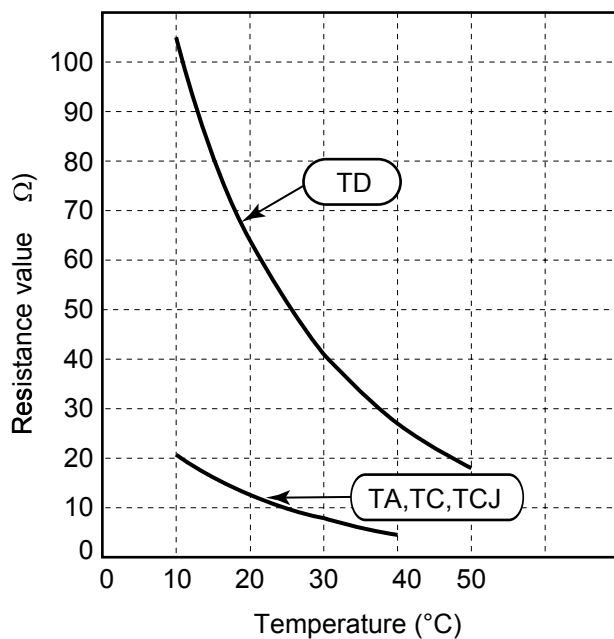

TD : Discharge temp. sensor  
 TA : Room temp. sensor  
 TC and TCJ : Heat exchanger temp. sensor

**11-8-3. Indoor Unit (Other Parts)**

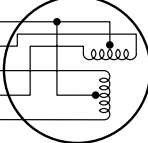
No.	Part name	Checking procedure																						
1	Room temp. (TA) sensor Heat exchanger (TC) sensor Heat exchanger (TCJ)sensor	Disconnect the connector and measure the resistance value with tester. (Normal temp.) <table border="1" data-bbox="603 320 1423 416"> <thead> <tr> <th data-bbox="603 320 932 353">Temperature</th> <th data-bbox="936 320 1034 353">10°C</th> <th data-bbox="1038 320 1136 353">20°C</th> <th data-bbox="1141 320 1238 353">25°C</th> <th data-bbox="1243 320 1340 353">30°C</th> <th data-bbox="1345 320 1423 353">40°C</th> </tr> </thead> <tbody> <tr> <td data-bbox="603 353 932 387">Sensor</td> <td data-bbox="936 353 1034 387"></td> <td data-bbox="1038 353 1136 387"></td> <td data-bbox="1141 353 1238 387"></td> <td data-bbox="1243 353 1340 387"></td> <td data-bbox="1345 353 1423 387"></td> </tr> <tr> <td data-bbox="603 387 932 416">TA, TC, TCJ (k. )</td> <td data-bbox="936 387 1034 416">20.7</td> <td data-bbox="1038 387 1136 416">12.6</td> <td data-bbox="1141 387 1238 416">10.0</td> <td data-bbox="1243 387 1340 416">7.9</td> <td data-bbox="1345 387 1423 416">4.5</td> </tr> </tbody> </table>	Temperature	10°C	20°C	25°C	30°C	40°C	Sensor						TA, TC, TCJ (k. )	20.7	12.6	10.0	7.9	4.5				
Temperature	10°C	20°C	25°C	30°C	40°C																			
Sensor																								
TA, TC, TCJ (k. )	20.7	12.6	10.0	7.9	4.5																			
2	Remote controller	Refer to 11-5-1. (5).																						
3	Louver motor & Damper motor MP24Z3N	Measure the resistance value of each winding coil by using the tester. (Under normal temp. 25°C) <div style="display: flex; align-items: center; margin-top: 10px;"> <div style="margin-right: 20px;"> <table border="0"> <tr><td>White</td><td>①</td><td>①</td></tr> <tr><td>Yellow</td><td>②</td><td>②</td></tr> <tr><td>Yellow</td><td>③</td><td>③</td></tr> <tr><td>Yellow</td><td>④</td><td>④</td></tr> <tr><td>Yellow</td><td>⑤</td><td>⑤</td></tr> </table> </div>  <div style="margin-left: 20px;"> <table border="1" data-bbox="991 564 1423 707"> <thead> <tr> <th data-bbox="991 564 1190 598">Position</th> <th data-bbox="1195 564 1423 598">Resistance value</th> </tr> </thead> <tbody> <tr> <td data-bbox="991 598 1190 631">1 to 2</td> <td data-bbox="1195 598 1423 631" rowspan="4" style="text-align: center; vertical-align: middle;">250 ± 20.</td> </tr> <tr> <td data-bbox="991 631 1190 665">1 to 3</td> </tr> <tr> <td data-bbox="991 665 1190 698">1 to 4</td> </tr> <tr> <td data-bbox="991 698 1190 707">1 to 5</td> </tr> </tbody> </table> </div> </div>	White	①	①	Yellow	②	②	Yellow	③	③	Yellow	④	④	Yellow	⑤	⑤	Position	Resistance value	1 to 2	250 ± 20.	1 to 3	1 to 4	1 to 5
White	①	①																						
Yellow	②	②																						
Yellow	③	③																						
Yellow	④	④																						
Yellow	⑤	⑤																						
Position	Resistance value																							
1 to 2	250 ± 20.																							
1 to 3																								
1 to 4																								
1 to 5																								
4	Indoor fan motor ICF-340-41-1	Refer to 11-5-1. (3) and (4).																						

## 12. HOW TO REPLACE THE MAIN PARTS

### WARNING

- Since high voltages pass through the electrical parts, turn off the power without fail before proceeding with the repairs.

Electric shocks may occur if the power plug is not disconnected.

- After the repairs have been completed (after the front panel and cabinet have been installed), perform a test run, and check for smoking, unusual sounds and other abnormalities.

If this check is omitted, a fire and/or electric shocks may occur.

Before proceeding with the test run, install the front panel and cabinet.

- Ensure that the following steps are taken when doing repairs on the refrigerating cycle.

1. Do not allow any naked flames in the surrounding area.  
If a gas stove or other appliance is being used, extinguish the flames before proceeding.  
If the flames are not extinguished, they may ignite any oil mixed with the refrigerant gas.

2. Do not use welding equipment in an airtight room.

Carbon monoxide poisoning may result if the room is not properly ventilated.

3. Do not bring welding equipment near flammable objects.

Flames from the equipment may cause the flammable objects to catch fire.



- **If keeping the power on is absolutely unavoidable while doing a job such as inspecting the circuitry, wear rubber gloves to avoid contact with the live parts.**



Electric shocks may be received if the live parts are touched.

High-voltage circuits are contained inside this unit.

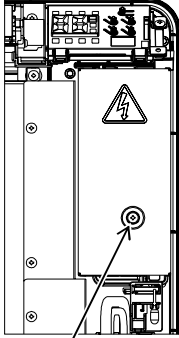
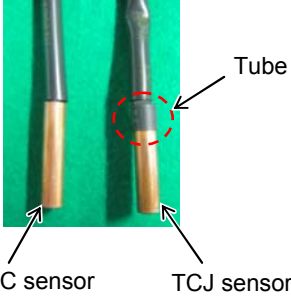
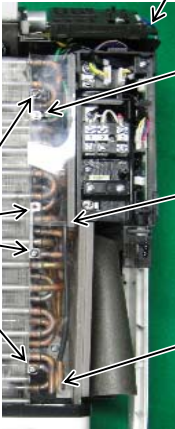
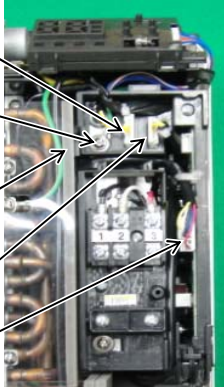
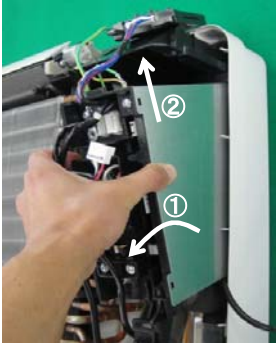

Proceed very carefully when conducting checks since directly touching the parts on the control circuit board may result in electric shocks.

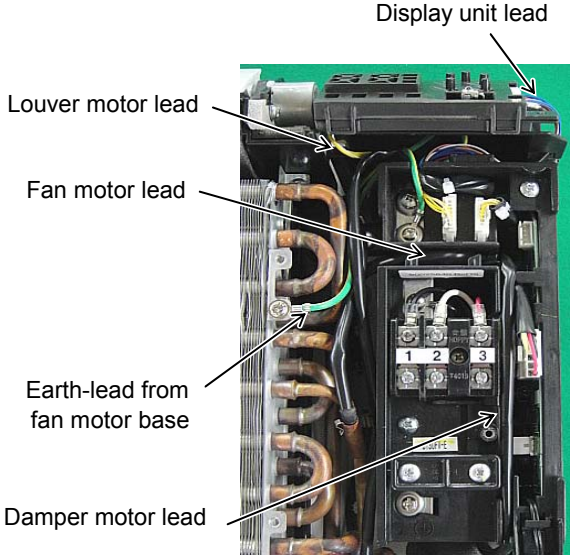
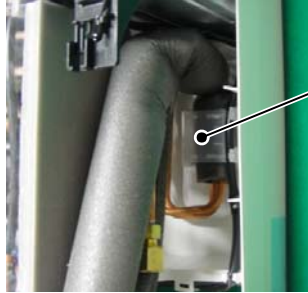
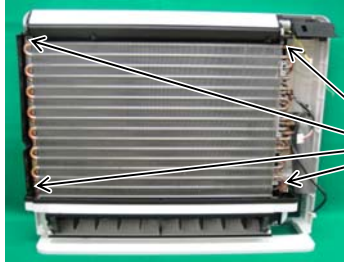
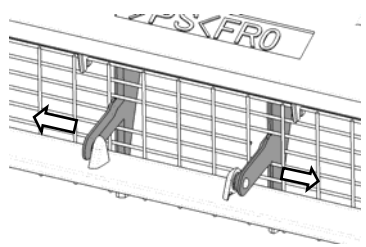



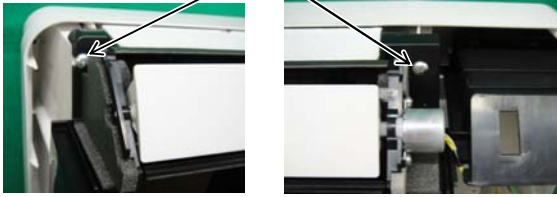
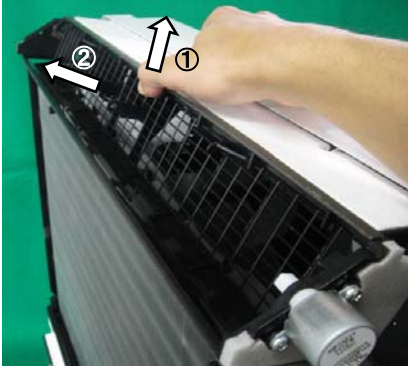

No.	Part name	Procedure	Remarks
①	Front panel	<p>1) Stop operation of the air conditioner and turn off the main power supply.</p> <p>2) Grip the air inlet grille by two hands at the handle positions.</p> <p>3) Pull the air inlet grille as the arrow direction and remove the rope from the hook of front panel.</p> <p>4) Remove screws for front panel. (4 pcs)</p>	

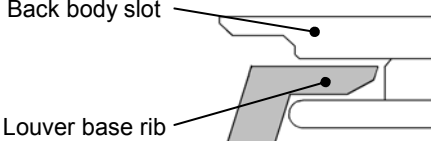
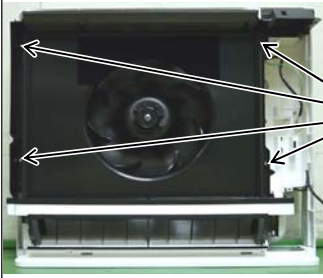
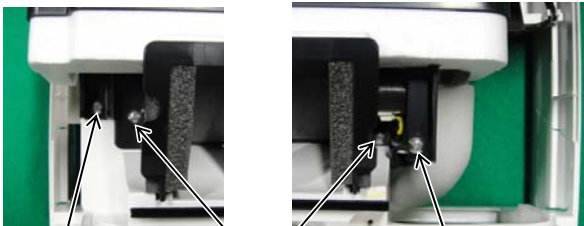
No.	Part name	Procedure	Remarks
②	Electrical parts Box assembly (E-box)	<p>1) Remove screw for E-box cover.</p> <p>2) Remove screw for drain guide. (4 pcs)</p> <p>3) Remove screw for earth-lead.</p> <p>4) Remove screw for display base.</p> <p>5) Pull off the TC, TCJ sensor.</p> <p>6) Take off fan motor connector.</p> <p>7) Take off louver motor connector.</p> <p>8) Take off damper motor connector.</p> <p>9) Remove screw for earth-lead from fan motor base.</p> <p>10) Remove screw for E-box</p> <p>11) - ① Pull the upper part of the E-box.</p> <p>11) - ② Lift a E-box in the upward for take off from the hook.</p>	  <p>1) Screw for E-box cover</p> <p>4) The screw for display base</p>  <p>2) Screws for drain guide (4 pcs)</p> <p>3) Screw for earth-lead</p> <p>5) TCJ sensor</p> <p>5) TC sensor</p>  <p>7) Louver motor connector</p> <p>9) Screw for earth-lead from fan motor base</p> <p>10) Screw for E-box</p> <p>8) Damper motor connector</p> <p>6) Fan motor connector</p>   <p>Hook for locking E-box</p>

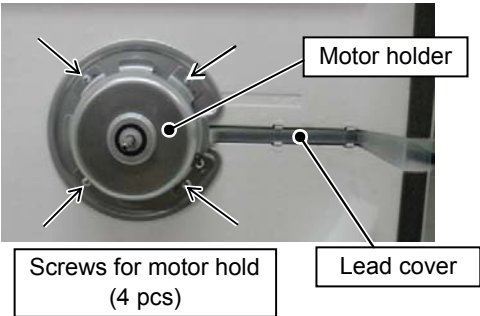
No.	Part name	Procedure	Remarks
②	Electrical parts Box assembly (E-box)	<How to arrange the lead> Shown in the picture.	 <p>Display unit lead</p> <p>Louver motor lead</p> <p>Fan motor lead</p> <p>Earth-lead from fan motor base</p> <p>Damper motor lead</p>
③	Heat exchanger (Refrigerant cycle assembly)	<p>1) Take off the pipe holder.</p> <p>2) Remove screws for heat exchanger. (4 pcs)</p>	 <p>Pipe holder</p>  <p>Screws for heat exchanger (4 pcs)</p>
④	Horizontal 1) louver	Open a horizontal louver outward and stretch the arm of louver base same as the direction in the picture.	 

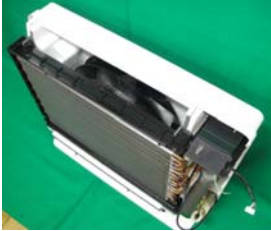

No.	Part name	Procedure	Remarks
⑤	Louver base assembly	<p>1) Remove screws for louver base. (2 pcs)</p> <p>2) - ① Pull the upper part of the louver base to upward.</p> <p>2) - ② Take off the louver base by pull out in the front direction.</p> <p>&lt;Attention for louver base assemble&gt; Insert the rib of the louver base into the slot of back body same as the picture.</p>	<p>Screws for louver base (2 pcs)</p>    <p>Back body slot</p> <p>Louver base rib</p> 
⑥	Bell mouth	<p>1) Remove screws for bell mouth. (4 pcs)</p>	 <p>Screws for bell mouth (4 pcs)</p>
⑦	Drain pan and damper base	<p>1) Remove screws for drain pan. (2 pcs)</p> <p>2) Remove screws for damper base. (2 pcs)</p>	 <p>Screws for damper base (2 pcs)</p> <p>Screw for drain pan</p> <p>Screw for drain pan</p>

No.	Part name	Procedure	Remarks
⑧	Turbo fan	<p>1) Turn the flange nut (M10) in the counter-clockwise direction and take it off.</p> <p>2) Pull out the turbo fan from the fan motor shaft.</p> <p>&lt;Attention for turbo fan assemble&gt; The tightening torque of the flange nut is 5N·m.</p>	
⑨	Fan motor	<p>1) Remove screws for motor holder, and take off the motor holder.</p> <p>2) Take off the lead cover.</p> <p>&lt;Attention for motor holder assemble&gt; 1. Arrange the earth lead and fan motor lead. 2. Adjust the motor axis to the center of the motor holder then fix screws 4 pcs.</p>	   
⑩	Fan motor	<p>A method to take off a fan motor in a condition taking on a heat exchanger.</p> <p>1) Take off pipe holder and remove screws for heat exchanger. (refer to ③)</p> <p>2) Remove screws for the bell mouth. (refer to ⑥)</p>	 



No.	Part name	Procedure	Remarks
⑩	Fan motor	<p>3) Remove the flange nut and turbo fan. (refer to ⑧)</p> <p>4) Remove screws for motor holder and lead cover. (refer to ⑨)</p>	

12-2. Microcomputer

No.	Part name	Procedure	Remarks
①	Common procedure	1) Turn the power supply off to stop the operation of air-conditioner. 2) Remove the front panel. • Remove the 2 fixing screws. 3) Remove the electrical part base.	Replace terminal block, microcomputer ass'y and the P.C. board ass'y.

<P.C. board layout>

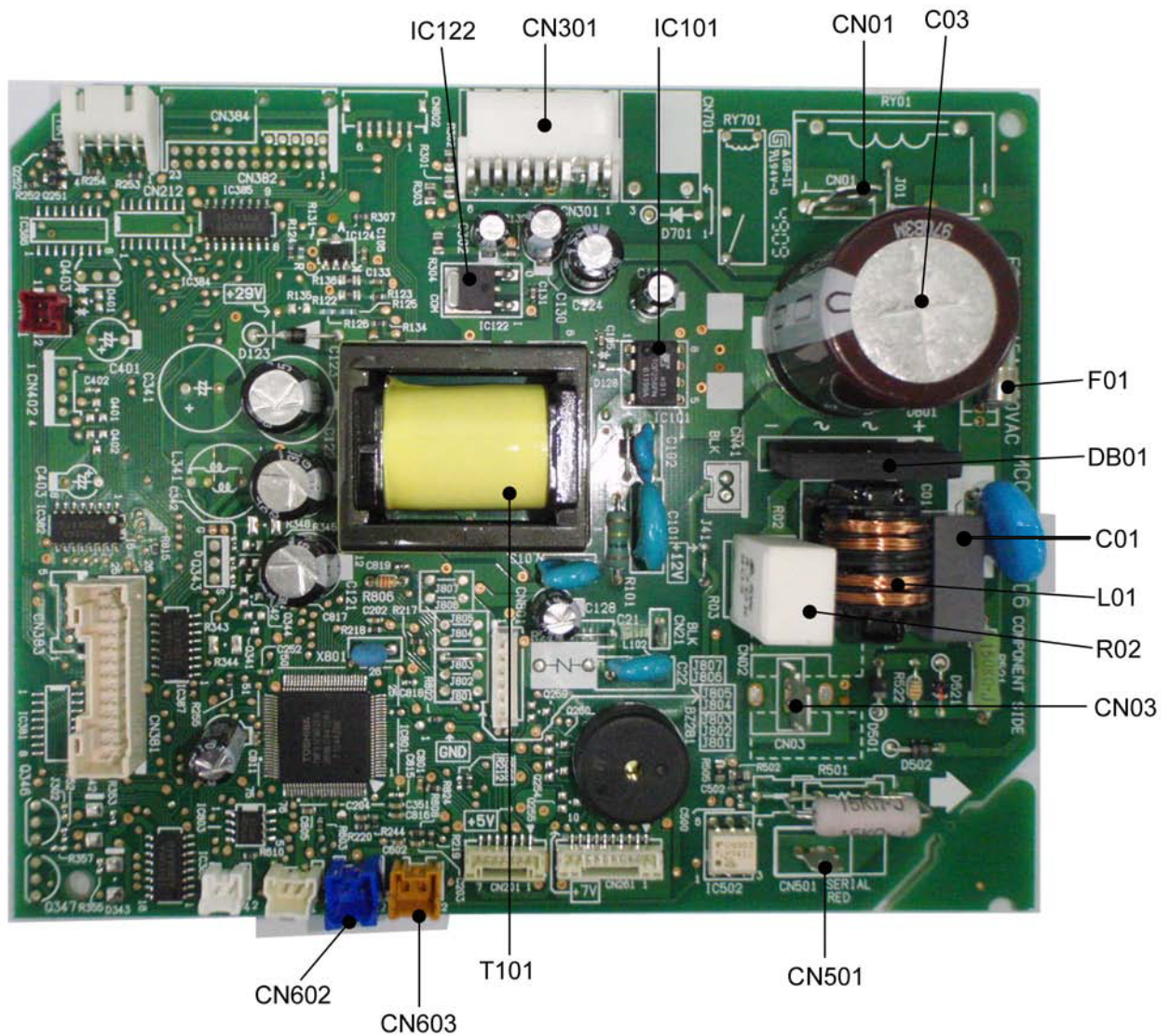

### 13. EXPLODED VIEWS AND PARTS LIST

#### 13-1. Indoor Unit

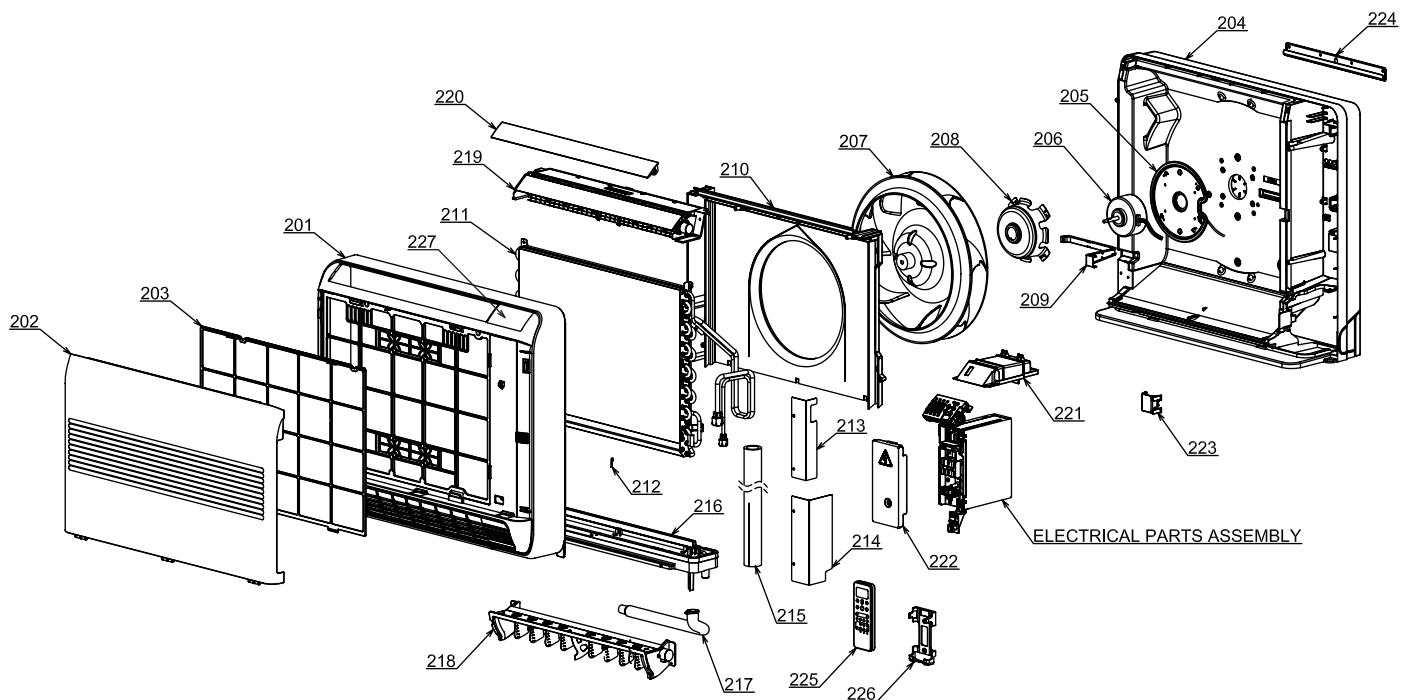

Location No.	Part No.	Description	Location No.	Part No.	Description
201	43T00553	FRONT PANEL ASSY	212	43T19333	HOLDER, SENSOR
202	43T09460	INLET GRILLE ASSY	213	43T79314	DRAIN GUIDE (UP)
203	43T80325	AIR FILTER	214	43T79315	DRAIN GUIDE (DOWN)
204	43T03379	BACK BODY ASSY	215	43T49341	SHIELD PIPE
205	43T39340	MOTOR BASE ASSY	216	43T72310	DRAIN PAN ASSY
206	43T21424	FAN MOTOR ASSY	217	43T70313	HOSE, DRAIN
207	43T20330	TURBO FAN ASSY	218	43T22317	DAMPER ASSY
208	43T60408	MOTOR HOLDER	219	43T22316	UPPER LOUVER ASSY
209	43T63331	LEAD COVER	220	43T22315	HORIZONTAL LOUVER
210	43T22314	BELL MOUTH ASSY	221	43T63333	DISPLAY BASE
211	43T44632	REFRIGERANT CYCLE ASSY (FOR RAS-B10U2FVG-E,-TR)	222	43T62339	TERMINAL COVER ASSY
211	43T44633	REFRIGERANT CYCLE ASSY (FOR RAS-B13U2FVG-E,-TR)	223	43T49340	PIPE HOLDER
211	43T44634	REFRIGERANT CYCLE ASSY (FOR RAS-B18U2FVG-E,-TR)	224	43T82316	PLATE MOUNTING
			225	43T66309	WIRELESS REMOTE CONTROLLER
			226	43T83003	HOLDER, REMOTE CONTROL
			227	43T08425	SHEET-DISPLAY

13-2. Indoor Unit (E-Part)

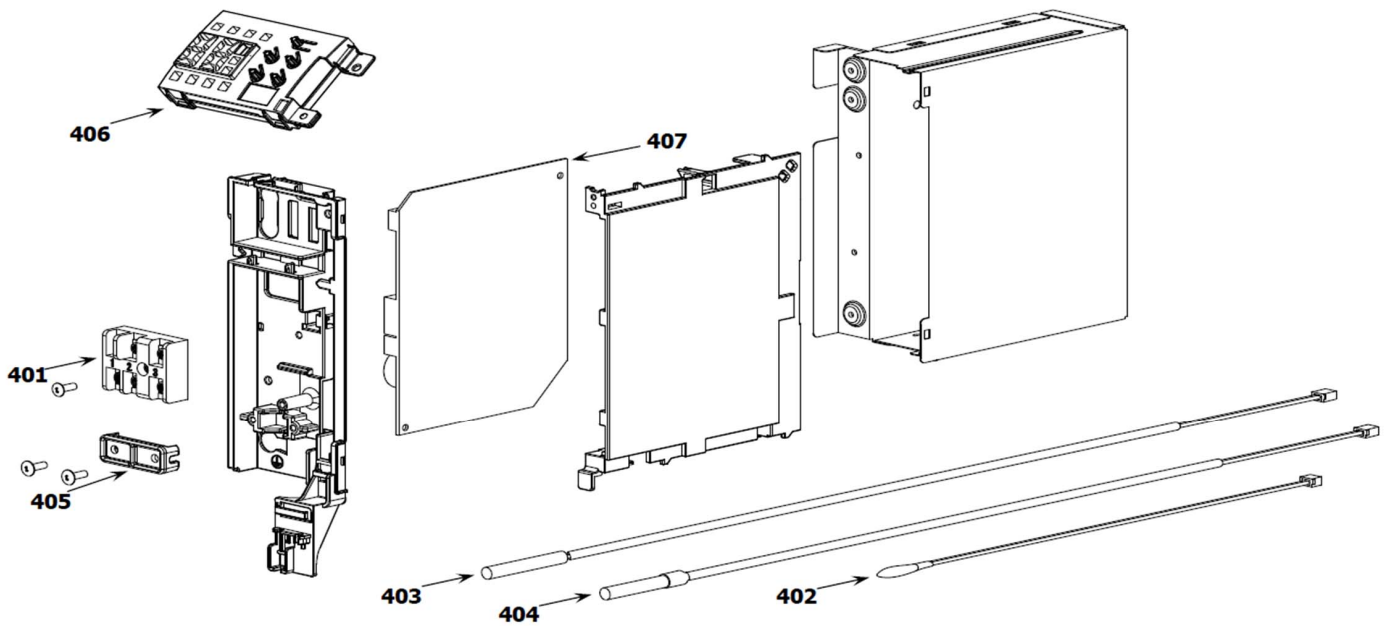

Location No.	Part No.	Description	Location No.	Part No.	Description
401	43T60406	TERMINAL 3P	406	43T69865	PC BOARD ASSY,WRS-LED
402	43T50321	SENSOR;THERMOSTAT	407	43T6V567	PC BOARD (FOR RAS-B10U2FVG-E,-TR)
403	43T50332	SENSOR:HEAT EXCHANGER	407	43T6V568	PC BOARD (FOR RAS-B13U2FVG-E,-TR)
404	43T50333	SENSOR:HEAT EXCHANGER	407	43T6V569	PC BOARD (FOR RAS-B18U2FVG-E,-TR)
405	43T62003	CORD CLAMP			

**TOSHIBA CARRIER (THAILAND) CO., LTD.**

**144/9 MOO 5, BANGKADI INDUSTRIAL PARK, TIVANON ROAD, TAMBOL BANGKADI,  
AMPHUR MUANG, PATHUMTHANI 12000, THAILAND.**