

SERVICE MANUAL

AIR-CONDITIONER (MULTI-SPLIT TYPE)

INDOOR UNIT

<Compact 4-way Cassette type>

RAS-M10U2MUVG-E (TR)

RAS-M13U2MUVG-E (TR)

RAS-M16U2MUVG-E (TR)

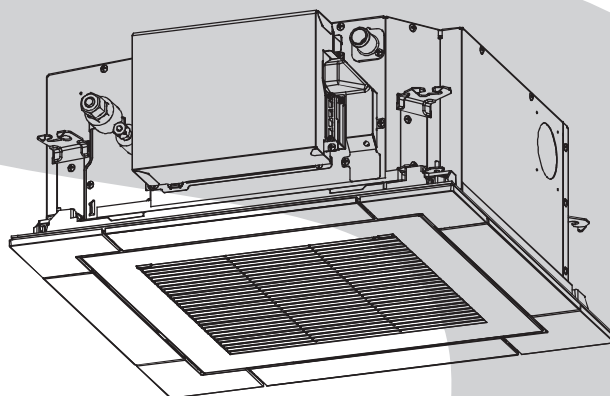

CONTENTS

1. SAFETY PRECAUTIONS	3
2. SPECIFICATIONS	13
3. REFRIGERANT R32	14
4. CONSTRUCTION VIEWS (EXTERNAL VIEWS)	17
5. WIRING DIAGRAMS	19
6. SPECIFICATIONS OF ELECTRICAL PARTS	20
7. REFRIGERANT CYCLE DIAGRAM	21
8. CONTROL BLOCK DIAGRAM	22
9. OPERATION DESCRIPTION	24
10. HOW TO DIAGNOSE THE TROUBLE	47
11. HOW TO REPLACE THE MAIN PARTS	61
12. EXPLODED VIEWS AND PARTS LIST	69
13. APPENDIX	77

1. SAFETY PRECAUTIONS

Original instruction

Please read carefully through these instructions that contain important information and ensure that you understand them.

Generic Denomination: Air Conditioner

Definition of Qualified Installer or Qualified Service Person

The air conditioner must be installed, maintained, repaired and removed by a qualified installer or qualified service person. When any of these jobs is to be done, ask a qualified installer or qualified service person to do them for you.

A qualified installer or qualified service person is an agent who has the qualifications and knowledge described in the table below.

Agent	Qualifications and knowledge which the agent must have
Qualified installer	<ul style="list-style-type: none"> • The qualified installer is a person who installs, maintains, relocates and removes the air conditioners made by Toshiba Carrier Corporation. He or she has been trained to install, maintain, relocate and remove the air conditioners made by Toshiba Carrier Corporation or, alternatively, he or she has been instructed in such operations by an individual or individuals who have been trained and is thus thoroughly acquainted with the knowledge related to these operations. • The qualified installer who is allowed to do the electrical work involved in installation, relocation and removal has the qualifications pertaining to this electrical work as stipulated by the local laws and regulations, and he or she is a person who has been trained in matters relating to electrical work on the air conditioners made by Toshiba Carrier Corporation or, alternatively, he or she has been instructed in such matters by an individual or individuals who have been trained and is thus thoroughly acquainted with the knowledge related to this work. • The qualified installer who is allowed to do the refrigerant handling and piping work involved in installation, relocation and removal has the qualifications pertaining to this refrigerant handling and piping work as stipulated by the local laws and regulations, and he or she is a person who has been trained in matters relating to refrigerant handling and piping work on the air conditioners made by Toshiba Carrier Corporation or, alternatively, he or she has been instructed in such matters by an individual or individuals who have been trained and is thus thoroughly acquainted with the knowledge related to this work. • The qualified installer who is allowed to work at heights has been trained in matters relating to working at heights with the air conditioners made by Toshiba Carrier Corporation or, alternatively, he or she has been instructed in such matters by an individual or individuals who have been trained and is thus thoroughly acquainted with the knowledge related to this work.
Qualified service person	<ul style="list-style-type: none"> • The qualified service person is a person who installs, repairs, maintains, relocates and removes the air conditioners made by Toshiba Carrier Corporation. He or she has been trained to install, repair, maintain, relocate and remove the air conditioners made by Toshiba Carrier Corporation or, alternatively, he or she has been instructed in such operations by an individual or individuals who have been trained and is thus thoroughly acquainted with the knowledge related to these operations. • The qualified service person who is allowed to do the electrical work involved in installation, repair, relocation and removal has the qualifications pertaining to this electrical work as stipulated by the local laws and regulations, and he or she is a person who has been trained in matters relating to electrical work on the air conditioners made by Toshiba Carrier Corporation or, alternatively, he or she has been instructed in such matters by an individual or individuals who have been trained and is thus thoroughly acquainted with the knowledge related to this work. • The qualified service person who is allowed to do the refrigerant handling and piping work involved in installation, repair, relocation and removal has the qualifications pertaining to this refrigerant handling and piping work as stipulated by the local laws and regulations, and he or she is a person who has been trained in matters relating to refrigerant handling and piping work on the air conditioners made by Toshiba Carrier Corporation or, alternatively, he or she has been instructed in such matters by an individual or individuals who have been trained and is thus thoroughly acquainted with the knowledge related to this work. • The qualified service person who is allowed to work at heights has been trained in matters relating to working at heights with the air conditioners made by Toshiba Carrier Corporation or, alternatively, he or she has been instructed in such matters by an individual or individuals who have been trained and is thus thoroughly acquainted with the knowledge related to this work.

Definition of Protective Gear

When the air conditioner is to be transported, installed, maintained, repaired or removed, wear protective gloves and 'safety' work clothing.

In addition to such normal protective gear, wear the protective gear described below when undertaking the special work detailed in the table below.



Failure to wear the proper protective gear is dangerous because you will be more susceptible to injury, burns, electric shocks and other injuries.

Work undertaken	Protective gear worn
All types of work	Protective gloves 'Safety' working clothing
Electrical-related work	Gloves to provide protection for electricians Insulating shoes Clothing to provide protection from electric shock
Work done at heights (50 cm or more)	Helmets for use in industry
Transportation of heavy objects	Shoes with additional protective toe cap
Repair of outdoor unit	Gloves to provide protection for electricians

The important contents concerned to the safety are described on the product itself and on this Service Manual.



Please read this Service Manual after understanding the described items thoroughly in the following contents (Indications / Illustrated marks), and keep them.

[Explanation of indications]

Indication	Explanation
 DANGER	Indicates contents assumed that an imminent danger causing a death or serious injury of the repair engineers and the third parties when an incorrect work has been executed.
 WARNING	Indicates possibilities assumed that a danger causing a death or serious injury of the repair engineers, the third parties, and the users due to troubles of the product after work when an incorrect work has been executed.
 CAUTION	Indicates contents assumed that an injury or property damage (*) may be caused on the repair engineers, the third parties, and the users due to troubles of the product after work when an incorrect work has been executed.

* Property damage: Enlarged damage concerned to property, furniture, and domestic animal / pet

[Explanation of illustrated marks]















Indication	Explanation
	Indicates prohibited items (Forbidden items to do) The sentences near an illustrated mark describe the concrete prohibited contents.
	Indicates mandatory items (Compulsory items to do) The sentences near an illustrated mark describe the concrete mandatory contents.
	Indicates cautions (Including danger / warning) The sentences or illustration near or in an illustrated mark describe the concrete cautious contents.

Warning Indications on the Air Conditioner Unit

[Confirmation of warning label on the main unit]

Confirm that labels are indicated on the specified positions



If removing the label during parts replace, stick it as the original.

Warning indication	Description			
<table border="1"> <tr> <td data-bbox="172 434 304 658" rowspan="2">  </td> <td data-bbox="304 434 660 510"> <p>WARNING</p> </td> </tr> <tr> <td data-bbox="304 510 660 658"> <p>ELECTRICAL SHOCK HAZARD Disconnect all remote electric power supplies before servicing.</p> </td> </tr> </table>		<p>WARNING</p>	<p>ELECTRICAL SHOCK HAZARD Disconnect all remote electric power supplies before servicing.</p>	<p>WARNING</p> <p>ELECTRICAL SHOCK HAZARD Disconnect all remote electric power supplies before servicing.</p>
		<p>WARNING</p>		
	<p>ELECTRICAL SHOCK HAZARD Disconnect all remote electric power supplies before servicing.</p>			
<table border="1"> <tr> <td data-bbox="172 716 304 940" rowspan="2">  </td> <td data-bbox="304 716 660 792"> <p>WARNING</p> </td> </tr> <tr> <td data-bbox="304 792 660 940"> <p>Moving parts. Do not operate unit with grille removed. Stop the unit before the servicing.</p> </td> </tr> </table>		<p>WARNING</p>	<p>Moving parts. Do not operate unit with grille removed. Stop the unit before the servicing.</p>	<p>WARNING</p> <p>Moving parts. Do not operate unit with grille removed. Stop the unit before the servicing.</p>
		<p>WARNING</p>		
	<p>Moving parts. Do not operate unit with grille removed. Stop the unit before the servicing.</p>			
<table border="1"> <tr> <td data-bbox="172 999 304 1223" rowspan="2">  </td> <td data-bbox="304 999 660 1075"> <p>CAUTION</p> </td> </tr> <tr> <td data-bbox="304 1075 660 1223"> <p>High temperature parts. You might get burned when removing this panel.</p> </td> </tr> </table>		<p>CAUTION</p>	<p>High temperature parts. You might get burned when removing this panel.</p>	<p>CAUTION</p> <p>High temperature parts. You might get burned when removing this panel.</p>
		<p>CAUTION</p>		
	<p>High temperature parts. You might get burned when removing this panel.</p>			
<table border="1"> <tr> <td data-bbox="172 1281 304 1505" rowspan="2">  </td> <td data-bbox="304 1281 660 1357"> <p>CAUTION</p> </td> </tr> <tr> <td data-bbox="304 1357 660 1505"> <p>Do not touch the aluminum fins of the unit. Doing so may result in injury.</p> </td> </tr> </table>		<p>CAUTION</p>	<p>Do not touch the aluminum fins of the unit. Doing so may result in injury.</p>	<p>CAUTION</p> <p>Do not touch the aluminium fins of the unit. Doing so may result in injury.</p>
		<p>CAUTION</p>		
	<p>Do not touch the aluminum fins of the unit. Doing so may result in injury.</p>			
<table border="1"> <tr> <td data-bbox="172 1563 304 1787" rowspan="2">  </td> <td data-bbox="304 1563 660 1639"> <p>CAUTION</p> </td> </tr> <tr> <td data-bbox="304 1639 660 1787"> <p>BURST HAZARD Open the service valves before the operation, otherwise there might be the burst.</p> </td> </tr> </table>		<p>CAUTION</p>	<p>BURST HAZARD Open the service valves before the operation, otherwise there might be the burst.</p>	<p>CAUTION</p> <p>BURST HAZARD Open the service valves before the operation, otherwise there might be the burst.</p>
		<p>CAUTION</p>		
	<p>BURST HAZARD Open the service valves before the operation, otherwise there might be the burst.</p>			



Precaution for Safety







The appliance shall be installed in accordance with national wiring regulations. Capacity shortages of the power circuit or an incomplete installation may cause an electric shock or fire.





DANGER







 Check earth wires.	<p>Before carrying out the installation, maintenance, repair or removal work, be sure to set the circuit breaker to the OFF position. Otherwise, electric shocks may result.</p> <p>Before opening the intake grille of the indoor unit or service panel of the outdoor unit, set the circuit breaker to the OFF position. Failure to set the circuit breaker to the OFF position may result in electric shocks through contact with the interior parts. Only a qualified installer (*1) or qualified service person (*1) is allowed to remove the intake grille of the indoor unit or service panel of the outdoor unit and do the work required.</p> <p>Before opening the electric cover set the circuit breaker to the OFF position. Failure to set the circuit breaker to the OFF position may result in injury through contact with the rotation parts.</p> <p>When cleaning the filter or other parts of the indoor unit, set the circuit breaker to OFF without fail, and place a "Work in progress" sign near the circuit breaker before proceeding with the work.</p> <p>When you have noticed that some kind of trouble (such as when a check code display has appeared, there is a smell of burning, abnormal sounds are heard, the air conditioner fails to cool or heat or water is leaking) has occurred in the air conditioner, do not touch the air conditioner yourself but set the circuit breaker to the OFF position, and contact a qualified service person. Take steps to ensure that the power will not be turned on (by marking "out of service" near the circuit breaker, for instance) until qualified service person arrives. Continuing to use the air conditioner in the trouble status may cause mechanical problems to escalate or result in electric shocks or other failure.</p>
 Electric shock hazard.	<p>When checking the electric parts, removing the cover of the electric parts box of Indoor Unit and/or service panel of Outdoor Unit inevitably to determine the failure, use gloves to provide protection for electricians, insulating shoes, clothing to provide protection from electric shock and insulating tools. Be careful not to touch the live part. Electric shock may result. Only "Qualified service person" is allowed to do this work.</p>
 Prohibition	<p>Do not turn ON the circuit breaker under the condition of removing a cabinet, a panel, etc. Otherwise, it leads to an electric shock with a high voltage, resulting in loss of life.</p>





 **WARNING**

 General	<p>Before starting to repair the air conditioner, read carefully through the Service Manual, and repair the air conditioner by following its instructions.</p>
	<p>Only qualified service person (*1) is allowed to repair the air conditioner. Repair of the air conditioner by unqualified person may give rise to a fire, electric shocks, injury, water leaks and/or other problems.</p>
	<p>Only a qualified installer (*1) or qualified service person (*1) is allowed to carry out the electrical work of the air conditioner. Under no circumstances must this work be done by an unqualified individual since failure to carry out the work properly may result in electric shocks and/or electrical leaks.</p>
	<p>Wear protective gloves and safety work clothing during installation, servicing and removal.</p>
	<p>Do not use any refrigerant different from the one specified for complement or replacement. Otherwise, abnormally high pressure may be generated in the refrigeration cycle, which may result in a failure or explosion of the product or an injury to your body.</p>
	<p>When connecting the electrical wires, repairing the electrical parts or undertaking other electrical jobs, wear gloves to provide protection for electricians, insulating shoes and clothing to provide protection from electric shocks. Failure to wear this protective gear may result in electric shocks.</p>
	<p>When the air conditioner is to be transported, installed, maintained, repaired or removed, wear protective gloves and safety work clothing.</p>
	<p>To connect the electrical wires, repair the electrical parts or undertake other electrical jobs, wear gloves to provide protection for electricians, insulating shoes and clothing to provide protection from electric shocks. Failure to wear this protective gear may result in electric shocks.</p>
	<p>Electrical wiring work shall be conducted according to law and regulation in the community and installation manual. Failure to do so may result in electrocution or short circuit.</p>
	<p>Use wiring that meets the specifications in the Installation Manual and the stipulations in the local regulations and laws. Use of wiring which does not meet the specifications may give rise to electric shocks, electrical leakage, smoking and/or a fire.</p>
	<p>Only a qualified installer (*1) or qualified service person (*1) is allowed to undertake work at heights using a stand of 50 cm or more.</p>
	<p>When working at heights, use a ladder which complies with the ISO 14122 standard, and follow the procedure in the ladders instructions. Also wear a helmet for use in industry as protective gear to undertake the work.</p>
	<p>When working at heights, put a sign in place so that no-one will approach the work location, before proceeding with the work. Parts and other objects may fall from above, possibly injuring a person below.</p>
	<p>When executing address setting, test run, or troubleshooting through the checking window on the electric parts box, put on insulated gloves to provide protection from electric shock. Otherwise you may receive an electric shock.</p>
	<p>Do not touch the aluminum fin of the outdoor unit. You may injure yourself if you do so. If the fin must be touched for some reason, first put on protective gloves and safety work clothing, and then proceed.</p>
	<p>Do not climb onto or place objects on top of the outdoor unit. You may fall or the objects may fall off of the outdoor unit and result in injury.</p>
	<p>When transporting the air conditioner, wear shoes with additional protective toe caps.</p>
<p>When transporting the air conditioner, do not take hold of the bands around the packing carton. You may injure yourself if the bands should break.</p>	
<p>Be sure that a heavy unit (10 kg or heavier) such as a compressor is carried by four persons.</p>	
<p>This air conditioner has passed the pressure test as specified in IEC 60335-2-40 Annex EE.</p>	
 Electric shock hazard	<p>When you access inside of the electric cover to repair electric parts, wait for about five minutes after turning off the breaker. Do not start repairing immediately. Otherwise you may get electric shock by touching terminals of high-voltage capacitors. Natural discharge of the capacitor takes about five minutes.</p>
 Prohibition	<p>Place a "Work in progress" sign near the circuit breaker while the installation, maintenance, repair or removal work is being carried out. There is a danger of electric shocks if the circuit breaker is set to ON by mistake.</p> <p>When checking the electric parts, removing the cover of the electric parts box of Indoor Unit and/ or front panel of Outdoor Unit inevitably to determine the failure, put a sign "Do not enter" around the site before the work. Failure to do this may result in third person getting electric shock.</p> <p>Before operating the air conditioner after having completed the work, check that the electrical parts box cover of the indoor unit and service panel of the outdoor unit are closed, and set the circuit breaker to the ON position. You may receive an electric shock if the power is turned on without first conducting these checks.</p>



 Stay on protection	If, in the course of carrying out repairs, it becomes absolutely necessary to check out the electrical parts with the electrical parts box cover of one or more of the indoor units and the service panel of the outdoor unit removed in order to find out exactly where the trouble lies, wear insulated heat-resistant gloves, insulated boots and insulated work overalls, and take care to avoid touching any live parts. You may receive an electric shock if you fail to heed this warning. Only qualified service person (*1) is allowed to do this kind of work.
 Check earth wires.	Before troubleshooting or repair work, check the earth wire is connected to the earth terminals of the main unit, otherwise an electric shock is caused when a leak occurs. If the earth wire is not correctly connected, contact an electric engineer for rework. After completing the repair or relocation work, check that the earth wires are connected properly. Be sure to connect earth wire. (Grounding work) Incomplete grounding causes an electric shock. Do not connect earth wires to gas pipes, water pipes, and lightning rods or earth wires for telephone wires.
 Prohibition of modification.	Do not modify the products. Do not also disassemble or modify the parts. It may cause a fire, electric shock or injury.
 Use specified parts.	When any of the electrical parts are to be replaced, ensure that the replacement parts satisfy the specifications given in the Service Manual (or use the parts contained on the parts list in the Service Manual). Use of any parts which do not satisfy the required specifications may give rise to electric shocks, smoking and/or a fire. Replace components only with parts specified by the manufacturer. Other parts may result in the ignition of refrigerant in the atmosphere from a leak.
 Do not bring a child close to the equipment.	If, in the course of carrying out repairs, it becomes absolutely necessary to check out the electrical parts with the electrical parts box cover of one or more of the indoor units and the service panel of the outdoor unit removed in order to find out exactly where the trouble lies, place Keep out signs around the work site before proceeding. Third-party individuals may enter the work site and receive electric shocks if this warning is not heeded.
 Insulating measures	Connect the cut-off lead wires with crimp contact, etc., put the closed end side upward and then apply a water-cut method, otherwise a leak or production of fire is caused at the users' side. Under no circumstances, the power supply wire or the indoor and outdoor connecting wire must not be connected in the middle (Connection using a solder less terminal etc.) Connection trouble in the places where the wire is connected in the middle may give rise to smoking and/or a fire.
 No fire	When performing repairs using a gas burner, replace the refrigerant with nitrogen gas because the oil that coats the pipes may otherwise burn. When repairing the refrigerating cycle, take the following measures. 1) Be attentive to fire around the cycle. When using a gas stove, etc., be sure to put out fire before work; otherwise the oil mixed with refrigerant gas may catch fire. 2) Do not use a welder in the closed room. When using it without ventilation, carbon monoxide poisoning may be caused. 3) Do not bring inflammables close to the refrigerant cycle, otherwise fire of the welder may catch the inflammables.

 Refrigerant	<p>This Air Conditioner has adopted a refrigerant HFC R32 or R410A. Be sure to check the refrigerant type for outdoor unit to be combined. In case that refrigerant type is R32, this unit uses a flammable refrigerant. If refrigerant leaks and comes in contact with fire or heating part, it will create harmful gas and there is risk of fire.</p>
	<p>Check the used refrigerant name and use tools and materials of the parts which match with it. For the products which use R32 refrigerant, the refrigerant name is indicated at a position on the outdoor unit where is easy to see. To prevent miss-charging, the route of the service port is changed from one of the former R22. Be careful for miss-charging since a charging port of R32 is the same diameter as that of R410A.</p>
	<p>Do not use any refrigerant different from the one specified for complement or replacement. Otherwise, abnormally high pressure may be generated in the refrigeration cycle, which may result in a failure or explosion of the product or an injury to your body.</p>
	<p>Be sure to use the refrigerant (R32 or R410A) specified on the combined outdoor unit. If different types of refrigerant are mixed, abnormal high pressure generates in the refrigerating cycle and an injury due to breakage may be caused. If the different type of refrigerants are mixed in, be sure to recharge the refrigerant</p>
	<p>When the air conditioner has been installed or relocated, follow the instructions in the Installation Manual and purge the air completely so that no gases other than the refrigerant will be mixed in the refrigerating cycle. Failure to purge the air completely may cause the air conditioner to malfunction.</p>
	<p>Do not charge refrigerant additionally. If charging refrigerant additionally when refrigerant gas leaks, the refrigerant composition in the refrigerating cycle changes resulted in change of air conditioner characteristics or refrigerant over the specified standard amount is charged and an abnormal high pressure is applied to the inside of the refrigerating cycle resulted in cause of breakage or injury. Therefore if the refrigerant gas leaks, recover the refrigerant in the air conditioner, execute vacuuming, and then newly recharge the specified amount of liquid refrigerant. In this time, never charge the refrigerant over the specified amount.</p>
	<p>When recharging the refrigerant in the refrigerating cycle, do not mix the other refrigerant into the specified refrigerant. If air or others is mixed with the refrigerant, abnormal high pressure generates in the refrigerating cycle resulted in cause of injury due to breakage.</p>
	<p>After the installation work, confirm that refrigerant gas does not leak. If refrigerant gas leaks into the room and flows near a fire source, such as a cooking range, it may generate noxious gases, causing a fire. Never recover the refrigerant into the outdoor unit. When the equipment is moved or repaired, be sure to recover the refrigerant with recovering device. The refrigerant cannot be recovered in the outdoor unit; otherwise a serious accident such as breakage or injury is caused.</p>
<p>When the air conditioner has been installed or relocated, follow the instructions in the Installation Manual and purge the air completely so that no gases other than the refrigerant will be mixed in the refrigerating cycle. Failure to purge the air completely may cause the air conditioner to malfunction.</p>	
 Assembly/ Wiring	<p>After repair work, surely assemble the disassembled parts, and connect and lead the removed wires as before. Perform the work so that the cabinet or panel does not catch the inner wires. If incorrect assembly or incorrect wire connection was done, a disaster such as a leak or fire is caused at user fs side.</p>
 Insulator check	<p>After the work has finished, be sure to use an insulation tester set (500V Megger) to check the resistance is 1MΩ or more between the charge section and the non-charge metal section (Earth position). If the resistance value is low, a disaster such as a leak or electric shock is caused at user fs side.</p>
 Ventilation	<p>When the refrigerant gas leaks during work, execute ventilation. If the refrigerant gas touches to a fire, it may generate noxious gases, causing a fire. A case of leakage of the refrigerant and the closed room full with gas is dangerous because a shortage of oxygen occurs. Be sure to execute ventilation.</p> <p>If refrigerant gas has leaked during the installation work, ventilate the room immediately. If the leaked refrigerant gas comes in contact with fire, it may generate noxious gases, causing a fire.</p>

 Compulsion	<p>When the refrigerant gas leaks, find up the leaked position and repair it surely. If the leaked position cannot be found up and the repair work is interrupted, pump-down and tighten the service valve, otherwise the refrigerant gas may leak into the room. When gas touches to fire such as fan heater, stove or cooking stove, it may generate noxious gases, causing a fire though the refrigerant gas itself is innocuous. When installing equipment which includes a large amount of charged refrigerant such as a multi air conditioner in a sub-room, it is necessary that the density does not the limit even if the refrigerant leaks. If the refrigerant leaks and exceeds the limit density, an accident of shortage of oxygen is caused.</p>
	<p>Tighten the flare nut with a torque wrench in the specified manner. Excessive tighten of the flare nut may cause a crack in the flare nut after a long period, which may result in refrigerant leakage.</p>
	<p>Nitrogen gas must be used for the airtight test.</p>
	<p>The charge hose must be connected in such a way that it is not slack.</p>
	<p>For the installation/moving/reinstallation work, follow to the Installation Manual. If an incorrect installation is done, a trouble of the refrigerating cycle, water leak, electric shock or fire is caused.</p>
	<p>Install the outdoor unit properly in a location that is durable enough to support the weight of the outdoor unit. Insufficient durability may cause the outdoor unit to fall, which may result in injury.</p>
 Check after repair	<p>Once the repair work has been completed, check for refrigerant leaks, and check the insulation resistance and water drainage. Then perform a trial run to check that the air conditioner is running properly.</p>
	<p>After repair work has finished, check there is no trouble. If check is not executed, a fire, electric shock or injury may be caused. For a check, turn off the power breaker.</p>
	<p>After repair work (installation of front panel and cabinet) has finished, execute a test run to check there is no generation of smoke or abnormal sound. If check is not executed, a fire or an electric shock is caused. Before test run, install the front panel and cabinet.</p>
 Do not operate the unit with the valve closed.	<p>Check the following matters before a test run after repairing piping.</p> <ul style="list-style-type: none"> • Connect the pipes surely and there is no leak of refrigerant. • The valve is opened. <p>Running the compressor under condition that the valve closes causes an abnormal high pressure resulted in damage of the parts of the compressor and etc. and moreover if there is leak of refrigerant at connecting section of pipes, the air is suctioned and causes further abnormal high pressure resulted in burst or injury.</p>
	<p>Only a qualified installer (*1) or qualified service person (*1) is allowed to relocate the air conditioner. It is dangerous for the air conditioner to be relocated by an unqualified individual since a fire, electric shocks, injury, water leakage, noise and/or vibration may result.</p>
 Check after reinstallation	<p>Check the following items after reinstallation.</p> <ol style="list-style-type: none"> 1) The earth wire is correctly connected. 2) The power cord is not caught in the product. 3) There is no inclination or unsteadiness and the installation is stable. <p>If check is not executed, a fire, an electric shock or an injury is caused.</p>
	<p>When the service panel of the outdoor unit is to be opened in order for the compressor or the area around this part to be repaired immediately after the air conditioner has been shut down, set the circuit breaker to the OFF position, and then wait at least 10 minutes before opening the service panel. If you fail to heed this warning, you will run the risk of burning yourself because the compressor pipes and other parts will be very hot to the touch. In addition, before proceeding with the repair work, wear the kind of insulated heat-resistant gloves designed to protect electricians.</p>
 Cooling check	<p>When the service panel of the outdoor unit is to be opened in order for the fan motor, reactor, inverter or the areas around these parts to be repaired immediately after the air conditioner has been shut down, set the circuit breaker to the OFF position, and then wait at least 10 minutes before opening the service panel. If you fail to heed this warning, you will run the risk of burning yourself because the fan motor, reactor, inverter heat sink and other parts will be very hot to the touch. In addition, before proceeding with the repair work, wear the kind of insulated heat-resistant gloves designed to protect electricians.</p>
	<p>Take care not to get burned by compressor pipes or other parts when checking the cooling cycle while running the unit as they get heated while running. Be sure to put on gloves providing protection for heat.</p>
 Cooling	

 Installation	<p>Only a qualified installer (*1) or qualified service person (*1) is allowed to install the air conditioner. If the air conditioner is installed by an unqualified individual, a fire, electric shocks, injury, water leakage, noise and/or vibration may result.</p>
	<p>Before starting to install the air conditioner, read carefully through the Installation Manual, and follow its instructions to install the air conditioner.</p>
	<p>Be sure to use the company-specified products for the separately purchased parts. Use of no specified products may result in fire, electric shock, water leakage or other failure. Have the installation performed by a qualified installer.</p>
	<p>Do not supply power from the power terminal block equipped on the outdoor unit to another outdoor unit. Capacity overflow may occur on the terminal block and may result in fire.</p>
	<p>Do not install the air conditioner in a location that may be subject to a risk of expire to a combustible gas. If a combustible gas leaks and becomes concentrated around the unit, a fire may occur.</p>
	<p>Install the indoor unit at least 2.5 m above the floor level since otherwise the users may injure themselves or receive electric shocks if they poke their fingers or other objects into the indoor unit while the air conditioner is running.</p>
	<p>Install a circuit breaker that meets the specifications in the installation manual and the stipulations in the local regulations and laws.</p>
	<p>When transporting the air conditioner, use a forklift and when moving the air conditioner by hand, move the unit with 4 people.</p>
	<p>Install a circuit breaker that meets the specifications in the installation manual and the stipulations in the local regulations and laws.</p>
	<p>Install the circuit breaker where it can be easily accessed by the agent.</p>
 Compulsion	<p>If you install the unit in a small room, take appropriate measures to prevent the refrigerant from exceeding the limit concentration even if it leaks. Consult the dealer from whom you purchased the air conditioner when you implement the measures. Accumulation of highly concentrated refrigerant may cause an oxygen deficiency accident.</p>
	<p>Do not place any combustion appliance in a place where it is directly exposed to the wind of air conditioner, otherwise it may cause imperfect combustion.</p>
 Compulsion	<p>When carrying out the pump-down work shut down the compressor before disconnecting the refrigerant pipe. Disconnecting the refrigerant pipe with the service valve left open and the compressor still operating will cause air, etc. to be sucked in, raising the pressure inside the refrigeration cycle to an abnormally high level, and possibly resulting in reputing, injury, etc.</p>
	<p>When removing the welding parts of suction and discharge pipe for the compressor, remove them at the place ventilated well after recovering the refrigerant. Improper recovering may cause the spurt of the refrigerant and the refrigeration oil, causing an injury.</p>
 Prohibition	<p>Do not vent gases to the atmosphere. Venting gases to the atmosphere is prohibited by the law.</p>

CAUTION

 Wearing of gloves	<p>Ensure wearing of gloves when performing any work in order to avoid injury from parts, etc. Failure to wear the proper protective gloves cause an injury due to the parts, etc.</p>
 Confirm	<p>When performing the welding work, check whether refrigerant leaks or remains. If the leakage refrigerant gas touches a fire source, it may generate noxious gases, causing a fire.</p>

Explanations given to user

If you have discovered that the fan grille is damaged, do not approach the outdoor unit but set the circuit breaker to the OFF position, and contact a qualified service person to have the repairs done.

Do not set the circuit breaker to the ON position until the repairs are completed.

Relocation

- Only a qualified installer (*1) or qualified service person (*1) is allowed to relocate the air conditioner.

It is dangerous for the air conditioner to be relocated by an unqualified individual since a fire, electric shocks, injury, water leakage, noise and / or vibration may result.

- When carrying out the pump-down work, shut down the compressor before disconnecting the refrigerant pipe.

Disconnecting the refrigerant pipe with the service valve left open and the compressor still operating will cause air, etc. to be sucked in, raising the pressure inside the refrigeration cycle to an abnormally high level, and possibly resulting in reputing, injury, etc.

(*1) Refer to the “Definition of Qualified Installer or Qualified Service Person”

Specifications

Model	Sound pressure level (dB(A))		Weight (kg) Main unit (Ceiling panel)
	Cooling	Heating	
RAS-M10U2MUVG-E	*	*	15 (2.5)
RAS-M13U2MUVG-E	*	*	15 (2.5)
RAS-M16U2MUVG-E	*	*	15 (2.5)
RAS-M10U2MUVG-TR	*	*	15 (2.5)
RAS-M13U2MUVG-TR	*	*	15 (2.5)
RAS-M16U2MUVG-TR	*	*	15 (2.5)

※: Under 70 (dB(A))

2. SPECIFICATIONS

Model Name		RAS-M10U2MUVG-E			RAS-M13U2MUVG-E			RAS-M16U2MUVG-E			
		RAS-M10U2MUVG-TR			RAS-M13U2MUVG-TR			RAS-M16U2MUVG-TR			
Cooling capacity (Rated) [kW] *1		2.7			3.7			4.5			
Cooling Capacity range [kW]		*2			*2			*2			
Heating Capacity (Rated) [kW] *1		4.0			5.0			5.5			
Heating Capacity range [kW]		*2			*2			*2			
Power supply		1Phase, 50Hz, 220-240V / 1Phase, 60Hz, 220V									
Electric characteristics in usual use *3	Voltage [V]	220	230	240	220	230	240	220	230	240	
	Running current [A]	0.22	0.21	0.20	0.24	0.23	0.22	0.26	0.25	0.24	
	Power Consumption [W]	24			26			29			
	Power Factor [%]	50			50			50			
Electric characteristics in NP *4	Maximum current [A]	0.22			0.24			0.40			
	Maximum power input [W]	24			26			44			
Air flow [m ³ /h]	Cooling	HH	590			620			660		
		H+	550			550			620		
		H	490			520			580		
		L+	460			490			520		
	Heating	L	430			480			480		
		HH	590			620			660		
		H+	560			560			620		
		H	500			520			570		
Sound pressure level [dBA]	Cooling	L+	460			490			520		
		L	430			480			480		
		HH	37			39			41		
		H+	35			37			39		
	Heating	H	33			35			37		
		L+	32			34			35		
		L	30			33			33		
		HH	37			39			41		
Sound power level [dBA]	Cooling	H+	35			37			39		
		H	33			34			37		
		L+	32			33			35		
		L	30			32			32		
	Heating	HH	52			54			56		
		H+	50			52			54		
		H	48			50			52		
		L+	47			49			50		
	L	45			48			48			
	HH	52			54			56			
	H+	50			52			54			
	H	48			49			52			
	L+	47			48			50			
	L	45			47			47			
	Fan Unit	Fan			Turbo fan						
		Motor Output [W]			60						
Dimensions *5	Height [mm]			256							
	Width [mm]			575							
	Depth [mm]			575							
Net weight [kg]				15							
Piping connection	Type			Flare connection							
	Liquid side [mm]			Ø6.35							
	Gas side [mm]			Ø9.52			Ø12.7				
	Drain port			VP20 (Polyvinyl chloride tube)							
Air filter				Standard filter (Long life filter)							
Usable indoor temperature rang (Cooling / Heating)				21 ~ 32°C / 0 ~ 28°C							
Manufacturer	Name			Toshiba Carrier Co.,Ltd							
	Address, city, country			336 Tadehara, Fuji-shi, Shizuoka-ken 416-8521 JAPAN							
Connecting cable				More than H07RN-F or 60245 IEC66 (1.5 mm ² or more)							
(Option) Ceiling panel				RBC-UM21PG(W)-E							
(Option) Wireless remote controller kit				RBC-AX32UM(W)-E							
(Option) Wired remote controller				RB-RWS21-E							
(Option) Occupancy sensor				TCB-SIR41UM-E							
Conformity Standards	-E	IEC EEN ,CE Mark ,LVD EEMC Certification ,RoHS ,WEEE ,ErP ,AS/NZS ,RCM Mark									
	-TR	IEC EEN ,CE Mark ,LVD EEMC Certification ,RoHS ,WEEE ,ErP									

*1 ... The Cooling and Heating capacity are measured under the Rated conditions.

Rated conditions Cooling : Indoor air temperature 27°CDB/ 19 °CWB, Outdoor air temperature 35°CDB
Heating : Indoor air temperature 20°CDB, Outdoor air temperature 7°CDB/ 6 °CWB

*2 ... Refer to the service manual of the outdoor unit to be combined.

*3 ... Electrical characteristics in usual use is under FAN ONLY mode HH tap.

*4 ... Electrical characteristics in NP is under the maximum load condition.

*5 ... Unit external dimensions (except hanging hook)

3. REFRIGERANT R32

This air conditioner adopts a new HFC type refrigerant (R32) which does not deplete the ozone layer.

1. Safety Caution Concerned to Refrigerant R32

Be sure that water, dust, the former refrigerant or the former refrigerating oil is not mixed into the refrigerating cycle of the air conditioner with refrigerant R32 during installation work or service work. If an incorrect work or incorrect service is performed, there is a possibility to cause a serious accident. Use the tools and materials exclusive to R32 to purpose a safe work.

2. Safety and Cautions on Installation/Service

<Safety items>

When gas concentration and ignition energy are happened at the same time, R32 has a slight possibility of burning. Although it will not ignite under normal work environment conditions, be aware that the flame spreads if ignition should occur.

It is necessary to carry out installation/servicing safely while taking the following precautions into consideration.

- 1) Never use refrigerant other than specified refrigerant (R32) in an air conditioner which is designed to operate with the specified refrigerant (R32).
If other refrigerant than R32 is used, it may cause personal injury, etc. by a malfunction, a fire, a rupture.
- 2) Since R32 is heavier than air, it tends to accumulate on the bottom (near the floor).
Ventilate properly for the working environment to prevent its combustion.
Especially in a basement or a closed room where is the high risk of the accumulation, ventilate the room with a local exhaust ventilation.
If refrigerant leakage is confirmed in the room or the place where the ventilation is insufficient, do not work until the proper ventilation is performed and the work environment is improved.
- 3) When performing brazing work, be sure to check for leakage refrigerant or residual refrigerant.
If the leakage refrigerant comes into contact with fire, a poisonous gas may occur or it may cause a fire.
Keep adequate ventilation during the work.
- 4) When refrigerant gas leaks during work, execute ventilation. If the leakage refrigerant comes into contact with a fire, a poisonous gas may occur or it may cause a fire.
- 5) In places where installing / repairing air-conditioning equipment, etc., keep the source of ignition such as gas combustion equipment, petroleum combustion equipment, electric heater etc. away. Do not smoke in the place.
- 6) When installing or removing an air conditioner, do not mix air in the refrigerant cycle.
If air or others is mixed with the refrigerant, abnormal high pressure generates in the refrigerating cycle, causing injury due to the breakage.
- 7) After installation work complete, confirm that refrigerant gas is not leaking on the flare connection part or others. If leaked refrigerant comes to contact with a fire, toxic gas may occur, causing a fire.
- 8) Perform the installation work and re-installation according to the installation manual.
Pay attention especially to the area of application. Improper installation may cause refrigeration trouble or water leakage, electric shock and fire etc.
- 9) Unauthorized modifications to the air conditioner may be dangerous. If a breakdown occurs please call a qualified air conditioner technician or electrician.
Improper repair may result in water leakage, electric shock and fire, etc.
- 10) Carry out the airtight test with nitrogen at a specified pressure. Do not use oxygen or acetylene gas absolutely as it may cause an explosion.
- 11) Always carry a refrigerant leakage detection sensor during the work and work while checking that no refrigerant leaks around working environment.
- 12) If the leakage refrigerant comes into contact with fire, it may cause a fire.
Have a dry powder or CO₂ fire extinguisher adjacent to the charging area.

<Caution items>

- 1) The opposite side dimension of the air-conditioner's flared nut using R32 and the shape of the charge port are the same as those of R410A.
- 2) Be careful not to charge refrigerant by mistake. Should the different type of refrigerant mix in, be sure to recharge the refrigerant
- 3) Do not mix the other refrigerant or refrigerating oil with the refrigerant.
- 4) Since the pressure of R32 is high 1.6 times of that of the former refrigerant (R22), use tools and parts with high pressure withstand specification similar to R410A.
- 5) In the installation time, use clean pipe materials and work with great attention so that water and others do not mix in because pipes are affected by impurities such as water, oxide film, oil, etc. Use the clean pipes. Be sure to braze while flowing nitrogen gas in the pipe. (Never use gas other than nitrogen gas.)
- 6) For the earth protection, use a vacuum pump for air purge.
- 7) R32 refrigerant is Single-component refrigerant that does not change its composition. Although it is possible to charge the refrigerant with either liquid or gas, charge it with liquid. (If using gas for charging, composition of the refrigerant changes and then characteristics of the air conditioner change.)

3. Pipe Materials

For the refrigerant pipes, copper pipe and joints are mainly used.
 It is necessary to select the most appropriate pipes to conform to the standard.
 Use clean material in which impurities adhere inside of pipe or joint to a minimum.

1) Copper pipe

<Piping>
 The pipe thickness, flare finishing size, flare nut and others differ according to a refrigerant type. When using a long copper pipe for R32, it is recommended to select "Copper or copper-base pipe without seam" and one with bonded oil amount 40mg/10m or less. Also do not use crushed, deformed, discolored (especially inside) pipes. (Impurities cause clogging of expansion valves and capillary tubes.)

<Flare nut>
 Use the flare nuts which are attached to the air conditioner unit.

Be sure to select the pipes with copper thickness in the table below since the pressure of an air conditioner using R32 is higher than that of R22.

Nominal diameter	Outer diameter (mm)	Thickness (mm) R410A or R32
1/2	6.4	0.80
3/8	9.5	0.80
1/2	12.7	0.80
5/8	15.9	1.00

Make sure not to use a thin copper pipe such as 0.7 mm copper thickness in the market.

2) Joint

The flare joint and socket joint are used for joints of the copper pipe. The joints are rarely used for installation of the air conditioner. However clear impurities when using them.

4. Tools

Tools exclusive for R410A (The following tools for R410A are required.)

○: R410A tools available

△: Partly unavailable, ×: R410A tools unavailable

No.	Installation/service tools		Use	Applicability to R32 air conditioner or not	Applicability to R22 air conditioner or not
	Tools / Equipment	specification			
1	Flare tool	Clutch type	Pipe flaring	○	○
2	Copper pipe gauge for adjusting projection margin	—	Flaring by conventional flare tool	○	—
3	Torque wrench	—	Tightening of flare nut	○	×
4	Gauge manifold	Port size 1/2"-20UNF (5/16" Flare)	Evacuating, refrigerant charge, run check, etc.	○ Note 2	×
5	Charge hose	High-voltage		○	×
6	Vacuum pump	—	Vacuum drying	○ Note 3 1/2"-20UNF(5/16" Flare)	△ Connection diameter 1/4"
7	Vacuum pump adapter	—	Vacuum drying	○ Note 4 1/2"-20UNF(5/16" Flare)	△ Connection diameter 1/4"
8	Electronic balance for refrigerant charging	For 10 kg or 20 kg cylinder	Refrigerant charge	○	○
9	Leakage detector	—	Gas leakage check	○ Note 5	○ Note 5
10	Refrigerant cylinder	—	Refrigerant charge	× Note 6	×
11	Refrigerant recovery cylinder	Exclusive for R32	Refrigerant recovery container	× Note 7	×
12	Refrigerant recovery device	—	Refrigerant recovery device	○ Note 8	△ Connection diameter 1/4"

Note 1 When flaring is carried out for R410A or R32 using the conventional flare tools, adjustment of projection margin is necessary. For this adjustment, a copper pipe gauge, etc. are necessary.

Note 2 When saturation temperature is described, the gauge manifold differs for R410A and R32. If saturation temperature reading is required, special tools exclusive for R32 are required.

Note 3 Since R32 has a slight possibility of burning, be sure to use the tools corresponding to R32.

Note 4 Like R410, a Vacuum pump adapter needs installing to prevent a Vacuum pump oil (mineral oil) from flowing backward into the Charge hose. Mixing of the Vacuum pump oil into R32 refrigerant may cause a trouble such as generation of sludge, clogging of capillary, etc.

Note 5 Be sure to use those tools after confirming they correspond to each refrigerant.

Note 6 For a refrigerant cylinder exclusive for R32, the paint color (or label color) of the cylinder is set to the specified color (light blue) together with the indication of the refrigerant name.

Note 7 Although the container specification is the same as R410A, use a recovering container exclusive for R32 to avoid mixing with other refrigerants.

Note 8 Be careful for miss-charging of the refrigerant during work. Miss-charging of the refrigerant type may cause not only damage of the equipments but also a fire etc.

General tools

In addition to the above exclusive tools, the following equipments are necessary as the general tools.

- | | |
|-----------------------|-----------------------------|
| 1) Pipe cutter | 6) Spanner or Monkey wrench |
| 2) Reamer | 7) Hole core drill |
| 3) Pipe bender | 8) Tape measure |
| 4) Level vial | 9) Metal saw |
| 5) Screwdriver (+, -) | |

Also prepare the following equipments for other installation method and run check.

- | | |
|----------------|--|
| 1) Clamp meter | 3) Insulation resistance tester (Megger) |
| 2) Thermometer | 4) Electroscopes |

4. CONSTRUCTION VIEWS (EXTERNAL VIEWS)

4-1. RAS-M10U2MUVG*, M13U2MUVG*

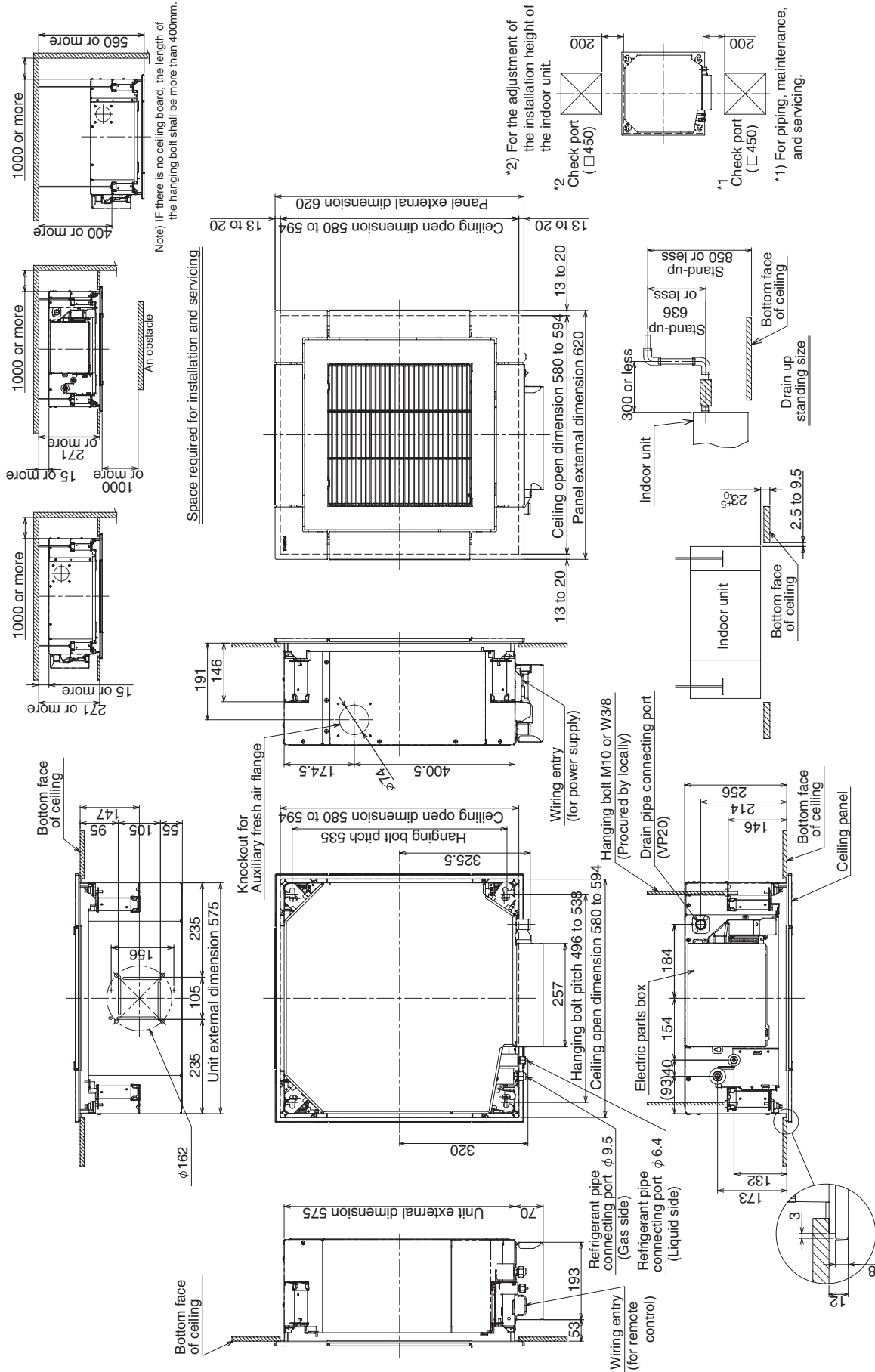

(Unit:mm)

4-2. RAS-M16U2MUVG*

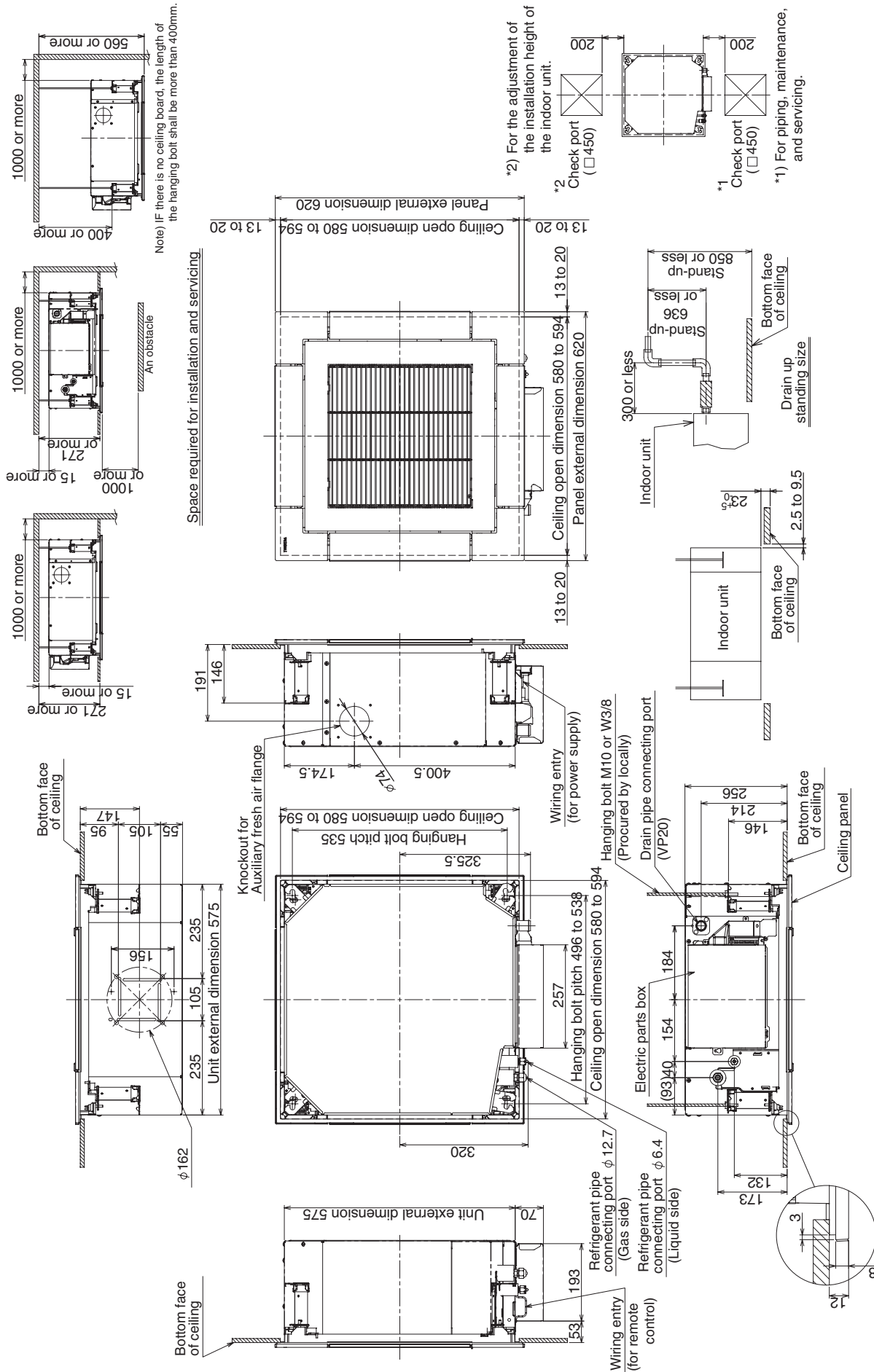

(Unit:mm)

6. SPECIFICATIONS OF ELECTRICAL PARTS

Indoor unit

Model	RAS-	M10*	M13*	M16*
Fan motor		ICF-340D60-1		
Louver motor		MSBPC20F04		
Float switch		FS-0218-102		
Drain pump motor		MDP-1401		
TA sensor		Lead wire length: 818 mm Vinyl tube		
TC sensor		Ø6 size lead wire length: 500 mm Vinyl tube (Black)		
TCJ sensor		Ø6 size lead wire length: 400 mm Vinyl tube (Red)		

7. REFRIGERANT CYCLE DIAGRAM

RAS-M10,13U2MUVG*

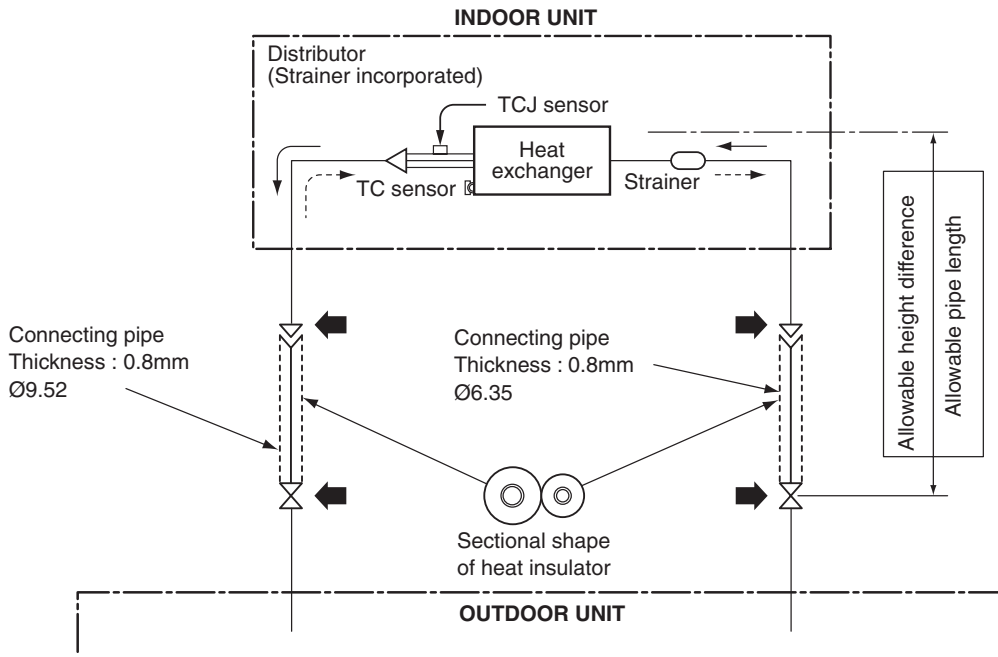

RAS-M16U2MUVG*

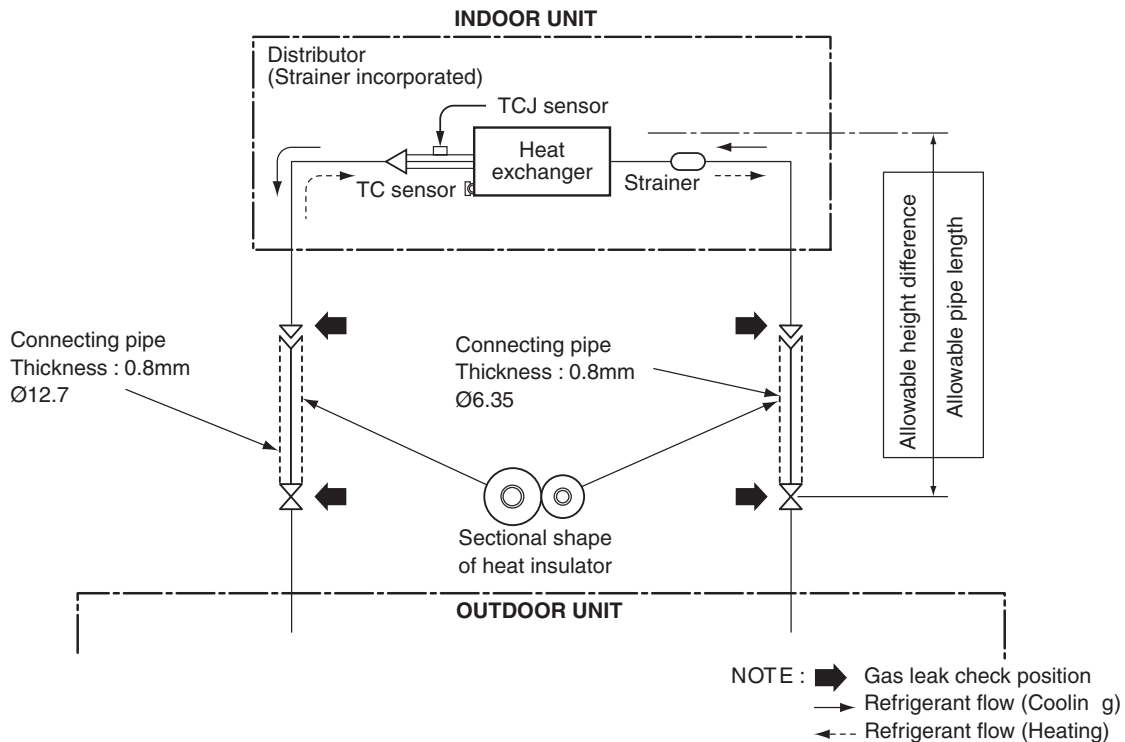

- The allowable pipe length, charge amount of refrigerant, and allowable height difference differ according to the outdoor unit to be combined. For details, refer to the service manual of the outdoor unit to be combined.

Indoor unit	Outer diameter of refrigerant pipe	
	Gas side ØA	Liquid side ØB
M10, 13 type	9.5	6.4
M16 type	12.7	6.4

8. CONTROL BLOCK DIAGRAM

8-1. Connection of Wired Remote Controller

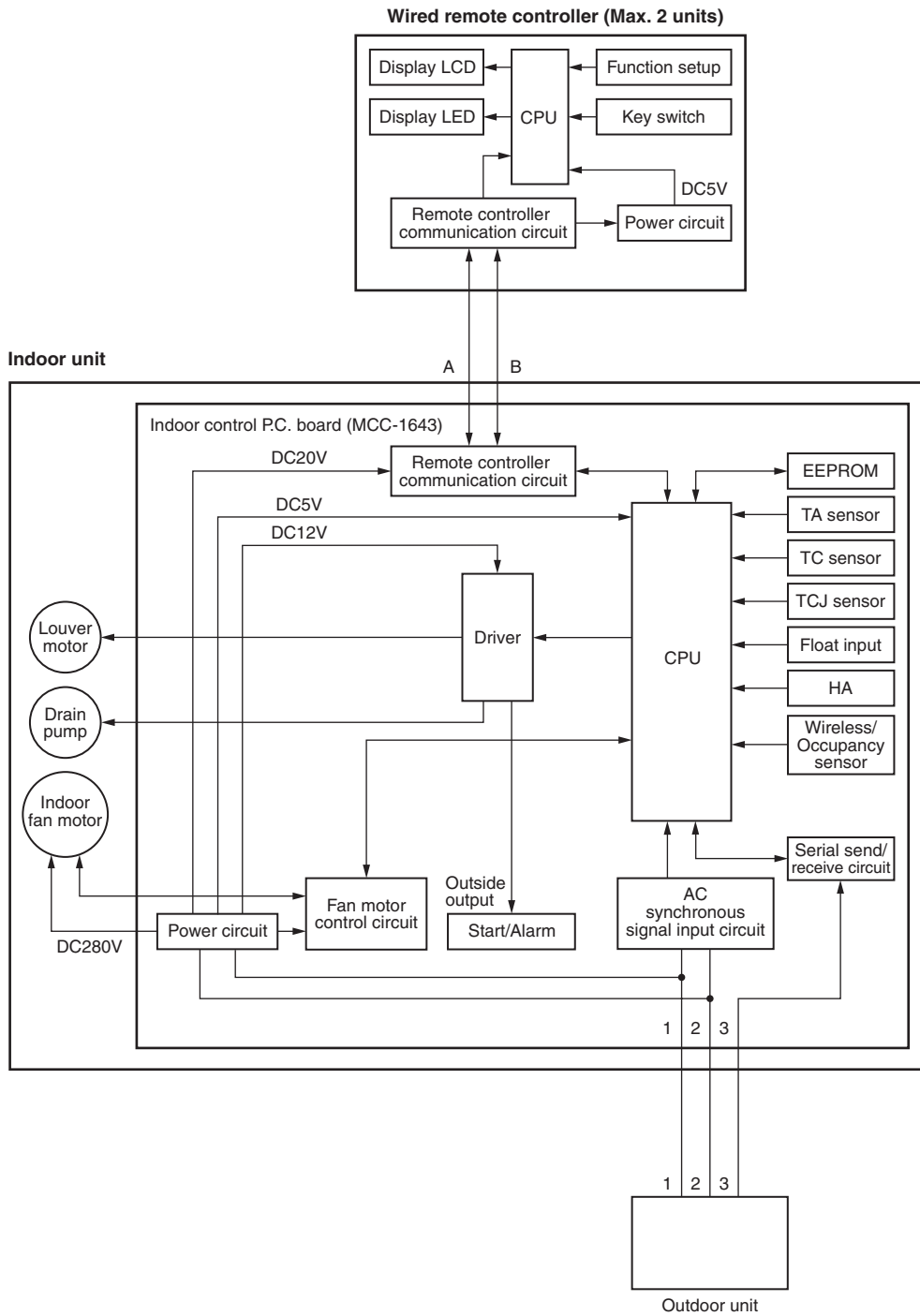

8-2. Connection of Wireless Remote Controller Kit

Indoor unit

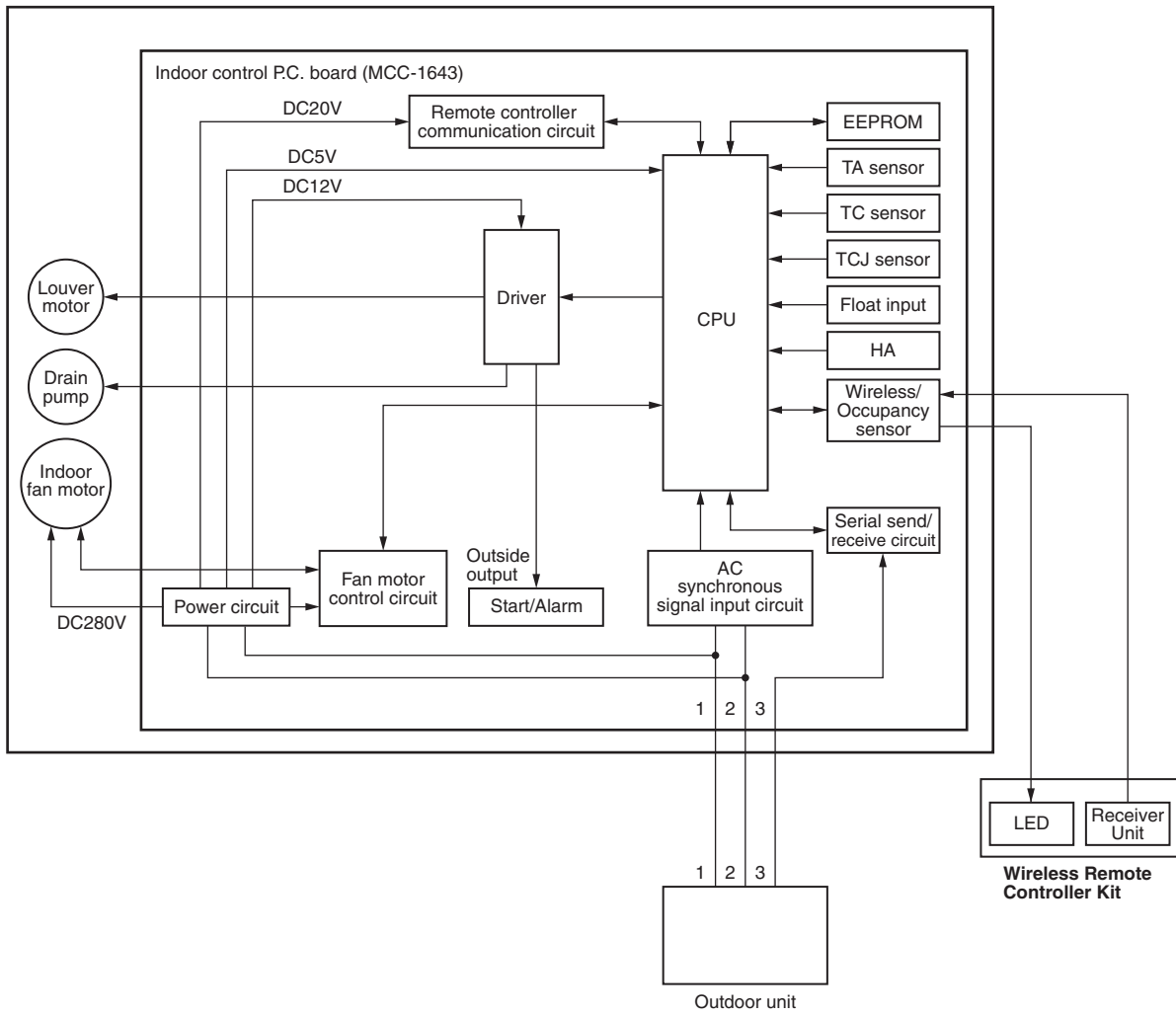

9. OPERATION DESCRIPTION

9-1. Outline of Air Conditioner Control	25
9-2. Operation Description	26
1. Basic operation	26
1-1. Operation control	26
1-2. When power supply is reset	27
1-3. Operating mode selection when performing 2-room operation	27
1-4. Room temp.control	27
1-5. Automatic capacity control (GA control)	28
1-6. Cooling/Heating operation	28
1-7. AUTO operation	29
2. Indoor fan motor control	30
3. Capacity control	32
4. Release protective control by temperature of indoor heat exchanger	33
5. Drain pump contro	33
6. After-heat elimination	33
7. Intermittent Operation Control for Indoor Fans of the Indoor Unit at Thermo-off Side in Heating Operation	34
8. Louver control	35
9. Filter sign display (Except wireless type)	38
10. DC motor	38
11. Drain pump delay operation	38
12. Occupancy sensor	38
13. Additional Operation	39
14. Remote-A or B selection	40
15. Temporary operation	40
16. Short Timer	41
17. High ceiling select switch	41
9-3. Auto Restart Function	42
1. How to Set the Auto Restart Function	42
2. How to Cancel the Auto Restart Function	43
3. Power Failure During Timer Operation	43
9-4. Wireless remote controller	44
1. Remote controller	44
2. Names and functions of indications on wireless remote controller	45
3. Signal receiving unit	46

9-1. Outline of Air Conditioner Control

This air conditioner is a capacity-variable type air conditioner, which uses DC motor for the indoor fan motor and the outdoor fan motor.

The DC motor drive circuit is mounted to the indoor unit. The capacity proportional control compressor and the inverter to control fan motor are mounted to the outdoor unit.

The entire air conditioner is mainly controlled by the indoor unit controller.

The indoor unit controller drives the indoor fan motor based upon command sent from the remote controller, and transfers the operation command to the outdoor unit controller.

The outdoor unit controller receives operation command from the indoor unit side, and controls the outdoor fan and the pulse motor valve. (P.M.V)

Besides, detecting revolution position of the compressor motor, the outdoor unit controller controls speed of the compressor motor by controlling output voltage of the inverter and switching timing of the supply power (current transfer timing) so that motors drive according to the operation command.

And then, the outdoor unit controller transfers reversely the operating status information of the outdoor unit to control the indoor unit controller.

As the compressor adopts four-pole brushless DC motor, the frequency of the supply power from inverter to compressor is two-time cycles of the actual number of revolution.

1. Role of indoor unit controller

The indoor unit controller judges the operation commands from the remote controller and assumes the following functions.

- Judgment of suction air temperature of the indoor heat exchanger by using the room temp. sensor. (TA sensor)
- Judgment of the indoor heat exchanger temperature by using heat exchanger sensor (TC sensor) (Prevent-freezing control, etc.)
- Indoor fan motor operation control
- LED (Light Emitting Diode) display control
- Transferring of operation command signal (Serial signal) to the outdoor unit
- Reception of information of operation status (Serial signal including outside temp. data) to the outdoor unit and judgment/display of trouble

2. Role of outdoor unit controller

Receiving the operation command signal (Serial signal) from the indoor unit controller, the outdoor unit performs its role.

- Compressor operation control
- Outdoor fan motor operation control
- P.M.V. control
- 4-way valve control

} Operations followed to judgment of serial signal from indoor side.

- Detection of inverter input current and current release operation
- Over-current detection and prevention operation to IGBT module (Compressor stop function)
- Compressor and outdoor fan stop function when serial signal is off (when the serial signal does not reach the board assembly of outdoor control by trouble of the signal system)
- Transferring of operation information (Serial signal) from outdoor unit controller to indoor unit controller
- Detection of outdoor temperature and operation revolution control
- Defrost control in heating operation (Temp. measurement by outdoor heat exchanger and control for 4-way valve and outdoor fan)

3. Contents of operation command signal (Serial signal) from indoor unit controller to outdoor unit controller

The following three types of signals are sent from the indoor unit controller.

- Operation mode set on the remote controller
- Compressor revolution command signal defined by indoor temperature and set temperature (Correction along with variation of room temperature and correction of indoor heat exchanger temperature are added.)
- Temperature of indoor heat exchanger
- For these signals ([Operation mode] [Compressor revolution] [indoor heat exchanger temperature]), the outdoor unit controller monitors the input current to the inverter, and performs the followed operation within the range that current does not exceed the allowable value.

4. Contents of operation command signal (Serial signal) from outdoor unit controller to indoor unit controller

The following signals are sent from the outdoor unit controller.

- The current operation mode
- The current compressor revolution
- Outdoor temperature
- Existence of protective circuit operation
- For transferring of these signals, the indoor unit controller monitors the contents of signals, and judges existence of trouble occurrence.
- Contents of judgment are described below.
- Whether distinction of the current operation status meets to the operation command signal
- Whether protective circuit operates
- When no signal is received from the outdoor unit controller, it is assumed as a trouble.

9-2. Operation Description

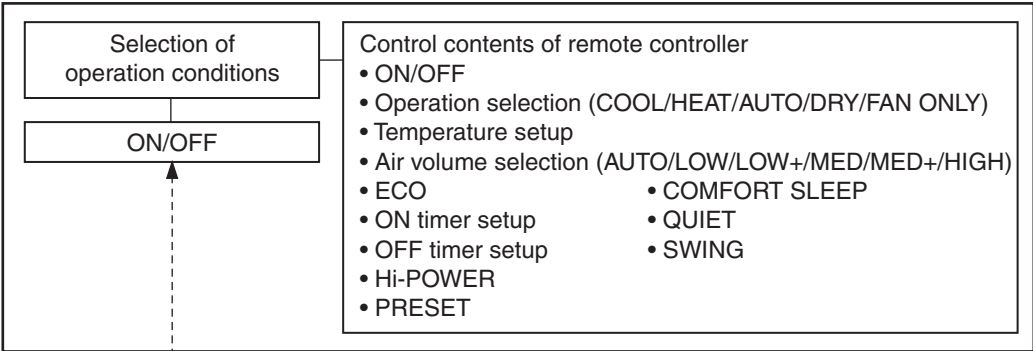
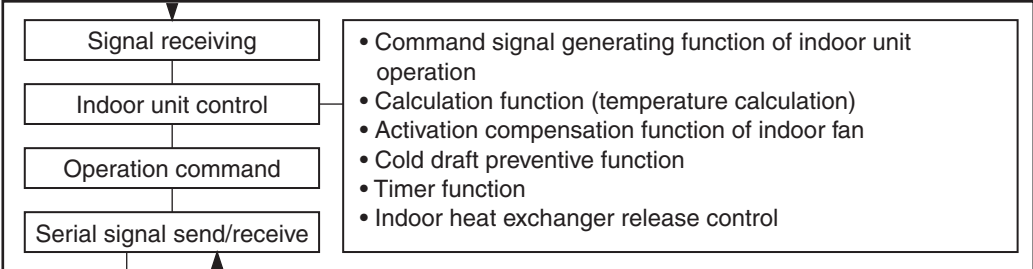
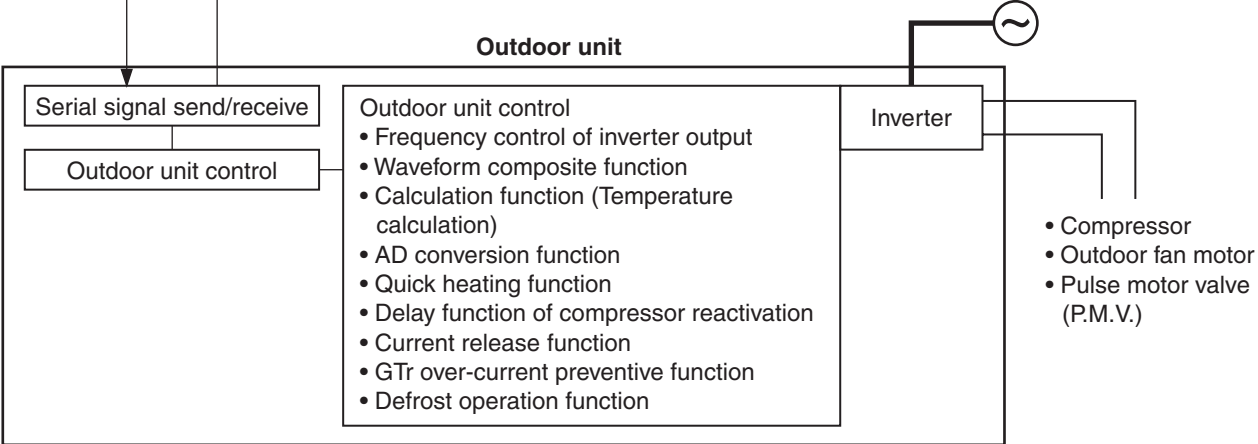
Item	Operation flow and applicable data, etc.	Description
<p>1. Basic operation</p>	<p>1-1. Operation control</p> <p>Receiving the user's operation condition setup, the operation statuses of indoor/outdoor units are controlled.</p> <ol style="list-style-type: none"> 1) The operation conditions are selected by the remote controller as shown below. 2) A signal is sent by ON button of the remote controller. 3) The signal is received by a sensor of the indoor unit and processed by the indoor controllers as shown below. 4) The indoor controller controls the indoor fan motor and louver motor. 5) The indoor controller sends the operation command to the outdoor controller, and sends/receives the control status with a serial signal. 6) The outdoor controller controls the operation as shown on the previous page, and also controls the compressor, outdoor fan motor, 4-way valve and pulse motor valve. <div style="text-align: center; margin-top: 20px;"> <p>Remote controller</p>  </div> <div style="text-align: center; margin-top: 20px;"> <p>Indoor unit</p>  </div> <div style="text-align: center; margin-top: 20px;"> <p>Outdoor unit</p>  </div>	

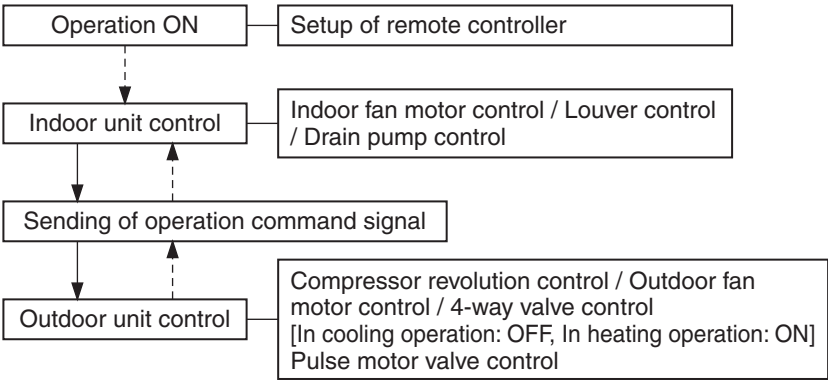

Item	Operation flow and applicable data, etc.	Description																																																																												
1. Basic operation (continued)	<p>1-2. When power supply is reset</p> <p>1) Distinction of outdoor unit When the power supply is reset, the outdoors are distinguished and the control is selected according to the distinguished result.</p> <p>2) Setting of indoor fan speed and existence of air direction adjustment Based on EEPROM data, select setting of the indoor fan speed and the existence of air direction adjustment.</p>	Air speed (rpm)/ Air direction adjustment																																																																												
	<p>1-3. Operating mode selection when performing 2-room operation</p> <p>1) The outdoor unit operation mode conforms to the instructions of the indoor unit that was pressed first.</p> <p>2) When combined operation consisting of cooling (dry) ,heating or fan only is performed, operation conforms to the instructions of the indoor unit that was pressed first as shown in the following table.</p> <p>3) The indoor fan stops for the indoor unit that was pressed last and which instructions are ignored.</p> <p>4) When three or four indoor units are operated concurrently, the priority is also given to operating mode of the indoor unit which was pressed first as same as the case when two indoor units are operated concurrently.</p> <table border="1" data-bbox="331 719 1434 1285"> <thead> <tr> <th>No.</th> <th>Indoor unit</th> <th>Set operating mode</th> <th>Actual indoor unit operation</th> <th>Actual outdoor unit operation</th> </tr> </thead> <tbody> <tr> <td rowspan="2">1</td> <td>Pressed first</td> <td>Cooling (dry)</td> <td>Cooling (dry)</td> <td rowspan="2">Cooling</td> </tr> <tr> <td>Pressed last</td> <td>Cooling (dry)</td> <td>Cooling (dry)</td> </tr> <tr> <td rowspan="2">2</td> <td>Pressed first</td> <td>Heating</td> <td>Heating</td> <td rowspan="2">Heating</td> </tr> <tr> <td>Pressed last</td> <td>Heating</td> <td>Heating</td> </tr> <tr> <td rowspan="2">3</td> <td>Pressed first</td> <td>Fan only</td> <td>Fan only</td> <td rowspan="2">Stopped</td> </tr> <tr> <td>Pressed last</td> <td>Fan only</td> <td>Fan only</td> </tr> <tr> <td rowspan="2">4</td> <td>Pressed first</td> <td>Cooling(dry)</td> <td>Cooling (dry)</td> <td rowspan="2">Cooling</td> </tr> <tr> <td>Pressed last</td> <td>Heating</td> <td>Fan stopped</td> </tr> <tr> <td rowspan="2">5</td> <td>Pressed first</td> <td>Cooling (dry)</td> <td>Cooling (dry)</td> <td rowspan="2">Cooling</td> </tr> <tr> <td>Pressed last</td> <td>Fan only</td> <td>Fan only</td> </tr> <tr> <td rowspan="2">6</td> <td>Pressed first</td> <td>Heating</td> <td>Heating</td> <td rowspan="2">Heating</td> </tr> <tr> <td>Pressed last</td> <td>Cooling(dry)</td> <td>Fan stopped</td> </tr> <tr> <td rowspan="2">7</td> <td>Pressed first</td> <td>Heating</td> <td>Heating</td> <td rowspan="2">Heating</td> </tr> <tr> <td>Pressed last</td> <td>Fan only</td> <td>Fan stopped</td> </tr> <tr> <td rowspan="2">8</td> <td>Pressed first</td> <td>Fan only</td> <td>Fan only</td> <td rowspan="2">Cooling</td> </tr> <tr> <td>Pressed last</td> <td>Cooling(dry)</td> <td>Cooling(dry)</td> </tr> <tr> <td rowspan="2">9</td> <td>Pressed first</td> <td>Fan only</td> <td>Fan only</td> <td rowspan="2">Stopped</td> </tr> <tr> <td>Pressed last</td> <td>Heating</td> <td>Fan stopped</td> </tr> </tbody> </table>	No.	Indoor unit	Set operating mode	Actual indoor unit operation	Actual outdoor unit operation	1	Pressed first	Cooling (dry)	Cooling (dry)	Cooling	Pressed last	Cooling (dry)	Cooling (dry)	2	Pressed first	Heating	Heating	Heating	Pressed last	Heating	Heating	3	Pressed first	Fan only	Fan only	Stopped	Pressed last	Fan only	Fan only	4	Pressed first	Cooling(dry)	Cooling (dry)	Cooling	Pressed last	Heating	Fan stopped	5	Pressed first	Cooling (dry)	Cooling (dry)	Cooling	Pressed last	Fan only	Fan only	6	Pressed first	Heating	Heating	Heating	Pressed last	Cooling(dry)	Fan stopped	7	Pressed first	Heating	Heating	Heating	Pressed last	Fan only	Fan stopped	8	Pressed first	Fan only	Fan only	Cooling	Pressed last	Cooling(dry)	Cooling(dry)	9	Pressed first	Fan only	Fan only	Stopped	Pressed last	Heating	Fan stopped
No.	Indoor unit	Set operating mode	Actual indoor unit operation	Actual outdoor unit operation																																																																										
1	Pressed first	Cooling (dry)	Cooling (dry)	Cooling																																																																										
	Pressed last	Cooling (dry)	Cooling (dry)																																																																											
2	Pressed first	Heating	Heating	Heating																																																																										
	Pressed last	Heating	Heating																																																																											
3	Pressed first	Fan only	Fan only	Stopped																																																																										
	Pressed last	Fan only	Fan only																																																																											
4	Pressed first	Cooling(dry)	Cooling (dry)	Cooling																																																																										
	Pressed last	Heating	Fan stopped																																																																											
5	Pressed first	Cooling (dry)	Cooling (dry)	Cooling																																																																										
	Pressed last	Fan only	Fan only																																																																											
6	Pressed first	Heating	Heating	Heating																																																																										
	Pressed last	Cooling(dry)	Fan stopped																																																																											
7	Pressed first	Heating	Heating	Heating																																																																										
	Pressed last	Fan only	Fan stopped																																																																											
8	Pressed first	Fan only	Fan only	Cooling																																																																										
	Pressed last	Cooling(dry)	Cooling(dry)																																																																											
9	Pressed first	Fan only	Fan only	Stopped																																																																										
	Pressed last	Heating	Fan stopped																																																																											
	<p>1-4. Room temp.control</p> <p>1) Adjustment range: Remote controller setup temperature (°C)</p> <table border="1" data-bbox="368 1384 1040 1476"> <thead> <tr> <th></th> <th>COOL/DRY</th> <th>HEAT</th> <th>AUTO</th> </tr> </thead> <tbody> <tr> <td>Wired type</td> <td>17 to 30</td> <td>17 to 30</td> <td>17 to 30</td> </tr> <tr> <td>Wireless type</td> <td>17 to 30</td> <td>17 to 30</td> <td>17 to 30</td> </tr> </tbody> </table> <p>2) Using the Item code FC [06] the setup temperature in heating operation can be corrected</p> <table border="1" data-bbox="368 1592 1040 1655"> <thead> <tr> <th>Setup</th> <th>0</th> <th>2</th> <th>4</th> <th>6</th> </tr> </thead> <tbody> <tr> <td>Setup temp. correction</td> <td>+0°C</td> <td>+2°C</td> <td>+4°C</td> <td>+6°C</td> </tr> </tbody> </table> <p>Setting at shipment</p> <table border="1" data-bbox="368 1718 702 1749"> <tbody> <tr> <td>Setup data</td> <td>2</td> </tr> </tbody> </table>		COOL/DRY	HEAT	AUTO	Wired type	17 to 30	17 to 30	17 to 30	Wireless type	17 to 30	17 to 30	17 to 30	Setup	0	2	4	6	Setup temp. correction	+0°C	+2°C	+4°C	+6°C	Setup data	2	Shift of suction temperature in heating operation																																																				
	COOL/DRY	HEAT	AUTO																																																																											
Wired type	17 to 30	17 to 30	17 to 30																																																																											
Wireless type	17 to 30	17 to 30	17 to 30																																																																											
Setup	0	2	4	6																																																																										
Setup temp. correction	+0°C	+2°C	+4°C	+6°C																																																																										
Setup data	2																																																																													

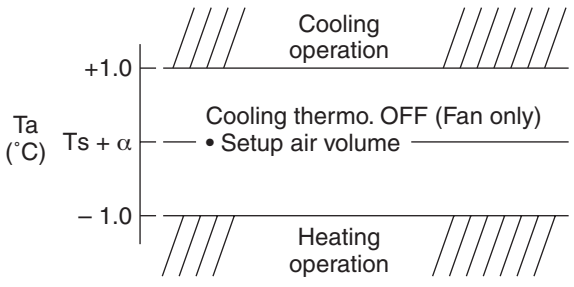
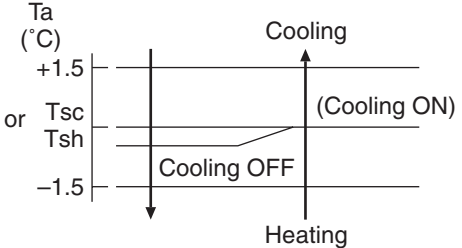
Item	Operation flow and applicable data, etc.	Description
1. Basic operation (continued)	<p>1-5. Automatic capacity control (GA control)</p> <p>1) Based on the difference between Ta and Ts, the operation frequency is instructed to the outdoor unit.</p> <p>2) Cooling operation Every 90 seconds, the room temperature difference between temperature detected by Ta and Ts and the varied room temperature value are calculated to obtain the correction value of the frequency command and then the present frequency command is corrected. Ta (n) – Ts (n) : Room temp. difference n : Counts of detection Ta (n-1) – Ts (n) : Varies room temp. value n – 1 : Counts of detection of 90 seconds before</p> <p>3) Heating operation Every 1 minute (60 sec.), the room temperature difference between temperature detected by Ta and Ts and the varied room temperature value are calculated to obtain the correction value of the frequency command and then the present frequency command is corrected. Ts (n) – Ta (n) : Room temp. difference n : Counts of detection Ta (n-1) – Ts (n – 1) : Varies room temp. value n – 1 : Counts of detection of 1 minute before</p> <p>4) Dry operation The frequency correction control is same as those of the cooling operation. However the maximum frequency is limited to approximately "S6".</p> <p>Note) When LOW is set up, the maximum frequency is limited to approximately "SB".</p>	
	<p>1-6. Cooling/Heating operation</p> <p>The operations are performed in the following parts by controls according to cooling/heating conditions.</p> <p>1) Receiving the operation ON signal of the remote controller, the cooling or heating operation signal starts being transferred from the indoor controller to the outdoor unit.</p> <p>2) At the indoor unit side, the indoor fan is operated according to the contents of "2. Indoor fan motor control" and the louver according to the contents of "8. Louver control", respectively.</p> <p>3) The outdoor unit controls the outdoor fan motor, compressor, pulse motor valve and 4-way valve according to the operation signal sent from the indoor unit.</p> <p>*1. The power coupler of 4-way valve is usually turned off, and it is turned on during defrost operation. (Only in heating)</p>  <pre> graph TD A[Operation ON] -.-> B[Indoor unit control] C[Setup of remote controller] --- A D[Indoor fan motor control / Louver control / Drain pump control] --- B B --> E[Sending of operation command signal] E --> F[Outdoor unit control] G[Compressor revolution control / Outdoor fan motor control / 4-way valve control / In cooling operation: OFF, In heating operation: ON / Pulse motor valve control] --- F F -.-> B </pre>	

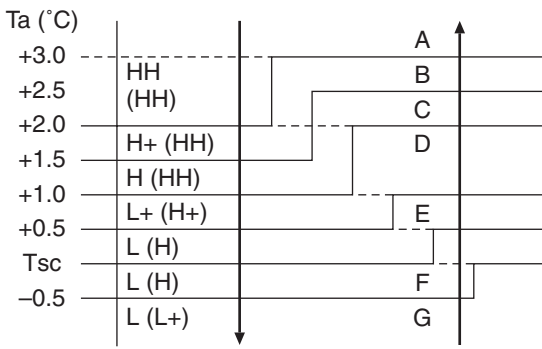
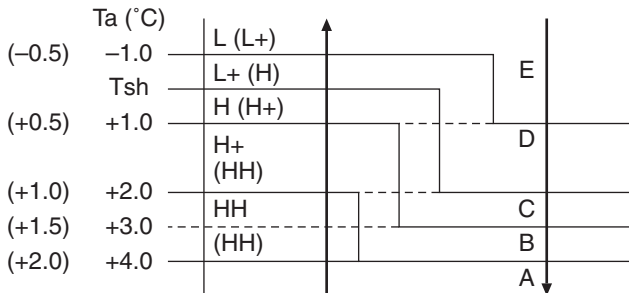
Item	Operation flow and applicable data, etc.	Description																
1. Basic operation (continued)	<p>1-7. AUTO operation</p> <table border="1" data-bbox="331 232 1118 1137"> <thead> <tr> <th data-bbox="336 232 614 293">Remote controller command</th> <th data-bbox="614 232 1114 293">Control outline</th> </tr> </thead> <tbody> <tr> <td data-bbox="336 293 614 524"> AUTO </td> <td data-bbox="614 293 1114 524"> <ul style="list-style-type: none"> • COOL/HEAT operation mode is automatically selected by Ta, Ts and To for operation. • The operation is performed as shown in the following figure according to Ta value at the first time only. (In the range of $T_s + \alpha - 1 < T_a < T_s + \alpha + 1$, Cooling thermo. OFF (Fan) /Setup air volume operation continues.) </td> </tr> </tbody> </table>  <p>• α is corrected according to the outside temperature.</p> <table border="1" data-bbox="347 913 901 1115"> <thead> <tr> <th data-bbox="352 913 582 943">Outside temp.</th> <th data-bbox="582 913 896 943">Correction value (α)</th> </tr> </thead> <tbody> <tr> <td data-bbox="352 943 582 972">No To</td> <td data-bbox="582 943 896 972">0K</td> </tr> <tr> <td data-bbox="352 972 582 1001">$T_o \geq 24^\circ\text{C}$</td> <td data-bbox="582 972 896 1001">-1K</td> </tr> <tr> <td data-bbox="352 1001 582 1030">$24 > T_o \geq 18^\circ\text{C}$</td> <td data-bbox="582 1001 896 1030">0K</td> </tr> <tr> <td data-bbox="352 1030 582 1059">$T_o < 18^\circ\text{C}$</td> <td data-bbox="582 1030 896 1059">+1K</td> </tr> <tr> <td data-bbox="352 1059 582 1088">To Trouble</td> <td data-bbox="582 1059 896 1088">0K</td> </tr> </tbody> </table>	Remote controller command	Control outline	AUTO	<ul style="list-style-type: none"> • COOL/HEAT operation mode is automatically selected by Ta, Ts and To for operation. • The operation is performed as shown in the following figure according to Ta value at the first time only. (In the range of $T_s + \alpha - 1 < T_a < T_s + \alpha + 1$, Cooling thermo. OFF (Fan) /Setup air volume operation continues.) 	Outside temp.	Correction value (α)	No To	0K	$T_o \geq 24^\circ\text{C}$	-1K	$24 > T_o \geq 18^\circ\text{C}$	0K	$T_o < 18^\circ\text{C}$	+1K	To Trouble	0K	<p>Ta: Room temp. Ts: Setup temp. To: Outside temp.</p> <p>K = deg</p>
Remote controller command	Control outline																	
AUTO	<ul style="list-style-type: none"> • COOL/HEAT operation mode is automatically selected by Ta, Ts and To for operation. • The operation is performed as shown in the following figure according to Ta value at the first time only. (In the range of $T_s + \alpha - 1 < T_a < T_s + \alpha + 1$, Cooling thermo. OFF (Fan) /Setup air volume operation continues.) 																	
Outside temp.	Correction value (α)																	
No To	0K																	
$T_o \geq 24^\circ\text{C}$	-1K																	
$24 > T_o \geq 18^\circ\text{C}$	0K																	
$T_o < 18^\circ\text{C}$	+1K																	
To Trouble	0K																	
	<p>1) The judgment of selecting COOL/HEAT is carried out as shown below. When +1.5 exceeds against Tsh 10 minutes and after thermo. -OFF, heating operation (Thermo. OFF) changes to cooling operation. Description in the parentheses shows an example of cooling ON/OFF.</p>  <p>When -1.5 lowers against Tsc 10 minutes and after thermo. OFF, cooling operation (Thermo. OFF) exchanges to heating operation.</p> <p>2) For the automatic capacity control after judgment of cooling/heating, see Item 1-5.</p> <p>3) For temperature correction of room temp. control in automatic heating, see Item 1-4.</p>	<p>Tsc: Setup temp. in cooling operation Tsh: Setup temp. in heating operation + temp. correction of room temp. control</p>																
	<p>1-8.DRY operation</p> <p>DRY operation is aimed to dehumidification. In order to prevent lowering of the room temperature,</p> <ul style="list-style-type: none"> • Indoor fan speed is fixed to cooling L tap. • Cooling capacity is restricted to low. When the room temperature is lower than the setup temperature, the compressor is turned off. 																	

Item	Operation flow and applicable data, etc.	Description
2. Indoor fan motor control	<p>1) Operation with (HH), (H+), (H), (L+), (L) or [AUTO] mode is carried out by the command from the remote controller.</p> <p>2) When the air speed mode [AUTO] is selected, the air speed varies by the difference between Ta and Ts.</p> <p><COOL></p>  <ul style="list-style-type: none"> Controlling operation in case when thermostat of remote controller works is same as a case when thermostat of the indoor unit works. If the air speed has been changed once, it cannot be changed for 3 minutes. However when the air volume is changed, the air speed also changed. When cooling operation has started, follow the downward arrow for the air speed. If the temperature is just on the boundary, the air speed does not change. Mode in the parentheses indicates one in AUTO(cooling) operation. <p><HEAT></p>  <p>Value in the parentheses indicates one when thermostat of the remote controller works. Value without parentheses indicates one when thermostat of the indoor unit works.</p> <ul style="list-style-type: none"> If the air speed has been changed once, cannot be changed for 1 minute. However when the air volume is changed, the air speed also changes. When heating operation has started, follow the upward arrow for the air speed. If the temperature is just on the boundary, the air speed does not change. Mode in the parentheses indicates one in AUTO(heating) operation. If $T_c \geq 60^\circ\text{C}$, the air speed increases by 1 step. 	<p>HH > H+ > H > L+ > L > LL</p> <p>Tc: Indoor heat exchanger sensor temperature</p>

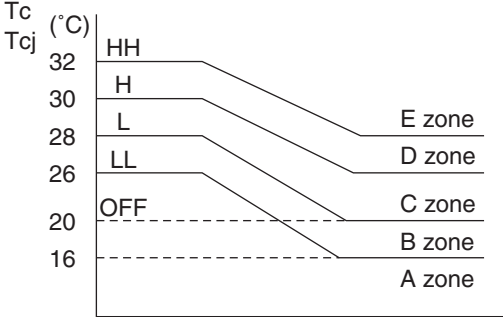
Item	Operation flow and applicable data, etc.					Description	
2. Indoor fan motor control (continued)	Revolution speed of indoor fan (rpm)					Selection of High ceiling type by changing CODE(FC)[5d] or SW501 on P.C. board.	
	■ RAS-M10U2MUVG-E						
	tap	COOL	HEAT	Standard	High Ceiling(1)		High Ceiling(3)
	F1		HH	670	N/A		N/A
	F2	HH		670	N/A		N/A
	F3		H+	640	N/A		N/A
	F4	H+		630	N/A		N/A
	F5		H	580	N/A		N/A
	F6	H		570	N/A		N/A
	F7		L+	540	N/A		N/A
	F8	L+		540	N/A		N/A
	F9		L	510	N/A		N/A
	FA	L		510	N/A		N/A
	FB			500	N/A		N/A
	FC			500	N/A		N/A
	FD	LL	LL	400	N/A		N/A
	■ RAS-M13U2MUVG-E						
	tap	COOL	HEAT	Standard	High Ceiling(1)		High Ceiling(3)
	F1		HH	700	N/A		N/A
	F2	HH		700	N/A		N/A
	F3		H+	640	N/A		N/A
	F4	H+		630	N/A		N/A
	F5		H	600	N/A		N/A
	F6	H		600	N/A		N/A
	F7		L+	570	N/A		N/A
	F8	L+		570	N/A		N/A
	F9		L	560	N/A		N/A
	FA	L		560	N/A		N/A
	FB			550	N/A		N/A
	FC			550	N/A		N/A
	FD	LL	LL	400	N/A		N/A
	■ RAS-M16U2MUVG-E						
	tap	COOL	HEAT	Standard	High Ceiling(1)		High Ceiling(3)
	F1		HH	740	880		880
F2	HH		740	880	880		
F3		H+	700	840	840		
F4	H+		700	840	840		
F5		H	650	780	840		
F6	H		650	780	840		
F7		L+	600	690	790		
F8	L+		600	690	790		
F9		L	560	640	690		
FA	L		560	640	690		
FB			550	630	680		
FC			500	630	680		
FD	LL	LL	400	400	400		
<p>3) In heating operation, the mode changes to [LL] if thermostat is turned off.</p> <p>4) If Ta ≥ 25°C when heating operation has started and when defrost operation has been cleared, the air conditioner operates with (H) mode or higher mode for 1 minute after Tc entered in E zone of cool air discharge preventive control.</p>							

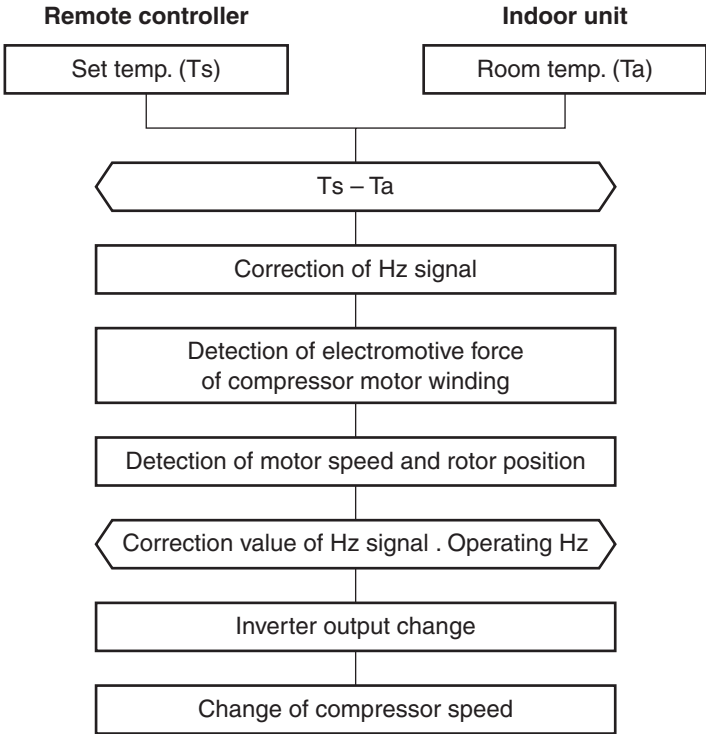
Item	Operation flow and applicable data, etc.	Description
2. Indoor fan motor control (continued)	<p>Cool air discharge preventive control</p> <p>1) In heating operation, the indoor fan is controlled based on the detected temperature of Tc sensor or Tcj sensor. As shown below, the upper limit of the fan speed is restricted.</p> <p>However B zone is assumed as C zone for 6 minutes after compressor was activated. In defrost operation, the control value of Tc is shifted up by 6°C.</p> 	<p>In D and E zones, the priority is given to air volume selection setup of remote controller.</p> <p>In A zone while thermo is ON, [PRE-HEAT  (Heating ready)] is displayed.</p> <p>Tcj: Indoor heat exchanger sensor temperature</p>
3. Capacity control	<p>The cooling or heating capacity depending on the load is adjusted. According to difference between the setup value of temperature and the room temperature, the capacity is adjusted by the compressor revolution.</p> 	<ol style="list-style-type: none"> 1) The difference between set temperature on remote controller (Ts) and room temperature (Ta) is calculated. 2) According to the temperature difference, the correction value of Hz signal which determines the compressor speed is set up. 3) The rotating position and speed of the motor are detected by the electromotive force occurred on the motor winding with operation of the compressor. 4) According to the difference resulted from comparison of the correction value of Hz signal with the present operation Hz, the inverter output is varied. 5) Change the compressor motor speed by outputting power to the compressor. <p>* The contents of control operation are same in cooling operation and heating operation</p>

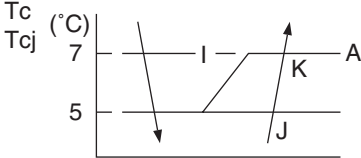
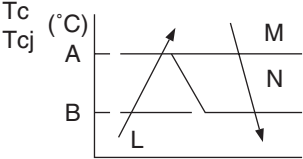
Item	Operation flow and applicable data, etc.	Description						
<p>4. Release protective control by temperature of indoor heat exchanger</p>	<p>Freeze preventive control (Low temperature release)</p> <p>1) The cooling operation (including Dry operation) is performed as follows based on the detected temperature of Tc sensor or Tcj sensor. When [J] zone is detected for 6 minutes (Following figure), the commanded frequency is decreased from the real operation frequency. After then the commanded frequency changes every 30 seconds while operation is performed in [J] zone. In [K] zone, time counting is interrupted and the operation is held. When [I] zone is detected, the timer is cleared and the operation returns to the normal operation. If the commanded frequency becomes S0 because the operation continues in [J] zone, the return temperature A is raised from 7°C to 12°C until [I] zone is detected and the indoor fan operates with [L] mode.</p>  <p>High-temp. release control</p> <p>1) The heating operation is performed as follows based on the detected temperature of Tc sensor or Tcj sensor.</p> <ul style="list-style-type: none"> • When [M] zone is detected, the commanded frequency is decreased from the real operation frequency. After then the commanded frequency changes every 30 seconds while operation is performed in [M] zone. • In [N] zone, the commanded frequency is held. • When [L] zone is detected, the commanded frequency is returned to the original value by approx. 6Hz every 60 seconds. <p>Setup at shipment</p> <table border="1" data-bbox="320 1093 710 1200"> <thead> <tr> <th colspan="2">Control temp. (°C)</th> </tr> <tr> <th>A</th> <th>B</th> </tr> </thead> <tbody> <tr> <td>53(51)</td> <td>51(49)</td> </tr> </tbody> </table>  <p>NOTE: When the operation has started or when Tc or Tcj < 30°C at start of the operation or after operation start, temperature is controlled between values in parentheses of A and B.</p>	Control temp. (°C)		A	B	53(51)	51(49)	<p>Same status as that when "thermostat-OFF" (status that the air conditioner enters in the room temp. monitor mode when the temperature reached the setup temperature on the remote controller)</p>
Control temp. (°C)								
A	B							
53(51)	51(49)							
<p>5. Drain pump control</p>	<p>1) In cooling operation (including Dry operation), the drain pump is usually operated.</p> <p>2) If the float switch works while drain pump drives, the compressor stops, the drain pump continues the operation, and a check code is output.</p> <p>3) If the float switch works while drain pump stops, the compressor stops and the drain pump operates. If the float switch keeps operating for approx. 4 minutes, a check code is output.</p> <p>4) The drain pump doesn't stop immediately to decrease the drain water in the drain pan when the cooling operation (including Dry operation) was stopped and drive the drain pump for five minutes.</p>	<p>Check code [0B]</p>						
<p>6. After-heat elimination</p>	<p>When heating operation stops, in some cases, the indoor fan operates with [LL] for approx. 30 seconds.</p>							

7. Intermittent Operation Control for Indoor Fans of the Indoor Unit at Thermo-off Side in Heating Operation

While heating operation is executed in two rooms, if room temperature reached the setup temperature in one room and thermo-off occurred, the following operations start. (Refer to the figure below.)





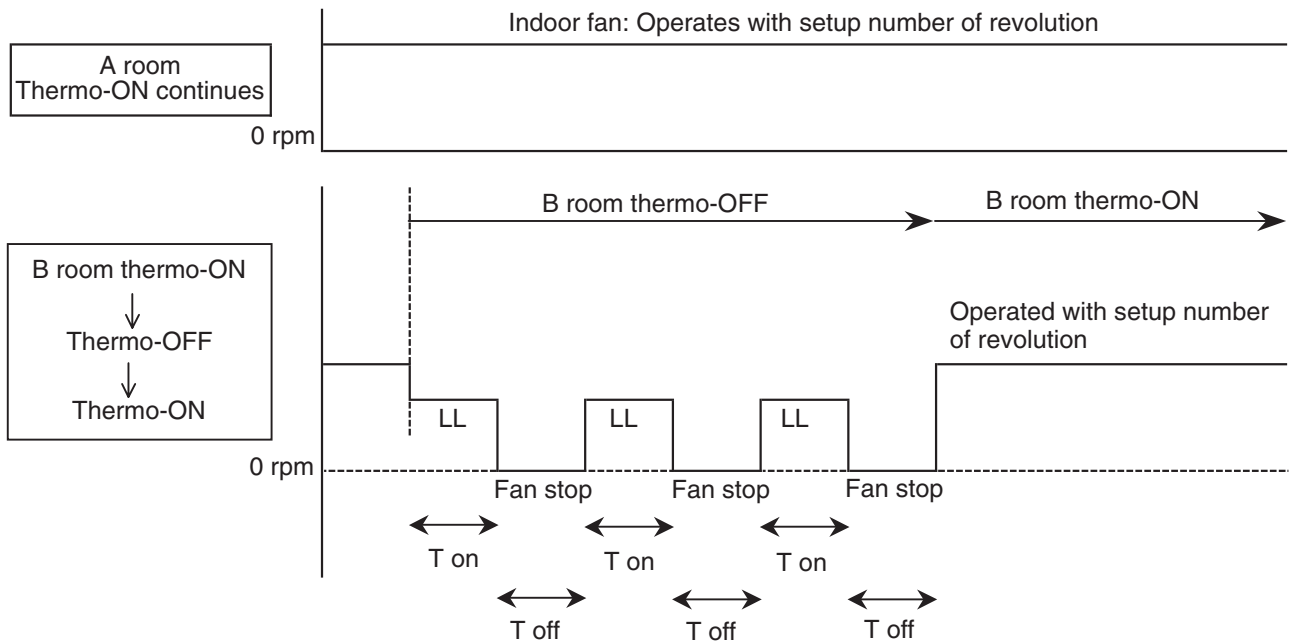





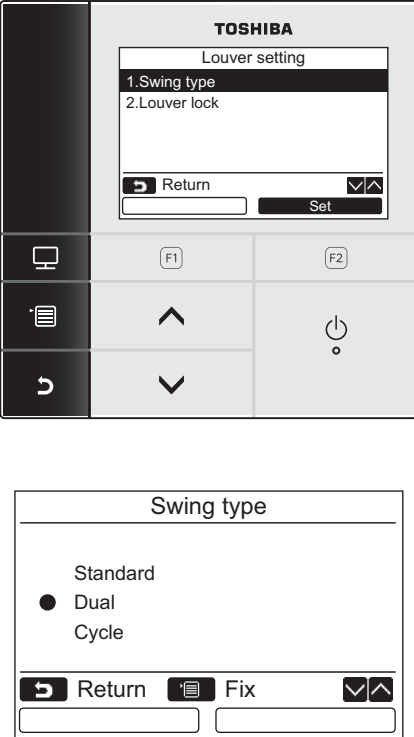



1. The indoor unit of the room (A room) in which thermo-off did not occur starts a continuous operation with the setup number of revolution.
2. The indoor unit of the room (B room) in which thermo-off occurred starts intermittent operation of the indoor fan.
The indoor fan operates with number of revolution of LL. Fan-ON time is 2 minutes and Fan-OFF time is 2 to 4 minutes.











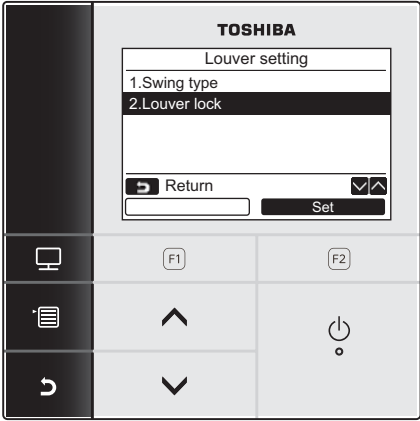
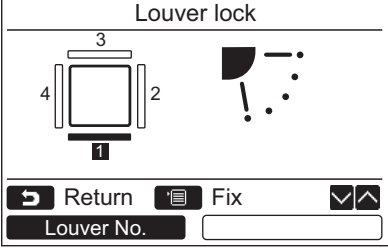
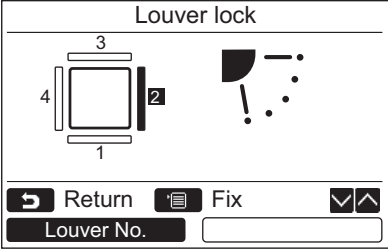









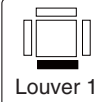
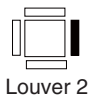
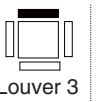

While heating operation is executed in two rooms, if room temperature reached the setup temperature in both room had thermo-off occurred, both indoor units start intermittent operation of the indoor fan.

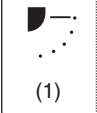
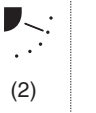

T on=2 min.

T off time	
To < 5°C	2 min.
5 ≤ To < 10	3 min.
10 ≤ To	4 min.

Item	Operation flow and applicable data, etc	Description
<p>8. Louver control (Continued)</p>	<p><<Selection of Swing mode>> * Select the louver swing type from the standard swing, dual swing or cyclic swing. Carry out the setting operation while the indoor unit is stopped. (Turn off the air conditioning unit before starting the setting operation.)</p> <p>Before setting</p>  <p>The diagram shows two screens from the Toshiba remote control. The top screen is titled 'TOSHIBA Louver setting' and lists '1.Swing type' and '2.Louver lock'. It has a 'Return' button and a 'Set' button. The bottom screen is titled 'Swing type' and shows three options: 'Standard', 'Dual' (which is selected with a radio button), and 'Cycle'. It has 'Return' and 'Fix' buttons.</p> <ol style="list-style-type: none"> 1 Push the [ ^] / [ v] button to select “3. Louver setting” on the menu screen, then push the “  Set” [ F2] button. 2 Push the [ ^] / [ v] button to select “1.Swing type”, then push the “  Set” [ F2] button. 3 Push the [ ^] / [ v] button on the “Swing type” screen to select the swing type. → Refer to the Owner’s Manual supplied with the indoor unit about the swing type. 4 Push the [ MENU] button. → “  Setting” appears on the display. → The unit selection screen appears when the group control is used. Push the [ CANCEL] button on the unit selection screen to finish the setting operation. “  Setting” appears on the display. 	<p>Selection of Swing mode can be set up by wired remote controller.</p>

Item	Operation flow and applicable data, etc	Description
8. Louver control (Continued)	<p><<Louver lock (Louver fix)>> * The direction of the louver can be locked individually. Carry out the setting operation while the indoor unit is stopped. (Turn off the air conditioning unit before starting the setting operation.) Before setting</p> <div style="display: flex; justify-content: space-around;">    </div> <ol style="list-style-type: none"> 1 Push the [] / [] button to select "3. Louver setting" on the menu screen, then push the "  Set" [ F2] button. 2 Push the [] / [] button to select "2.Louver lock", then push the "  Set" [ F2] button. 3 Push the " Louver No." [ F1] button to select the louver to set. → The display changes as follows each time the button is pushed. <div style="display: flex; justify-content: center; align-items: center; gap: 10px;">      </div> <ol style="list-style-type: none"> 4 Push the [] / [] button to select the louver (wind) direction. → Push the [] button to move the louver upward. Push the [] button to move it downward. <div style="display: flex; justify-content: center; align-items: center; gap: 10px;">       </div> <ol style="list-style-type: none"> 5 Push the [ MENU] button. → "⌘ Setting" appears on the display. 	Louver lock can be set up by wired remote controller.

Item	Operation flow and applicable data, etc	Description																		
8. Louver control (Continued)	<ul style="list-style-type: none"> If there is the locked louver in the unit, [] goes on the remote controller screen. While the following controls are performed, the louvers operate even if executing the louver lock. <table border="1" data-bbox="336 331 1147 546"> <thead> <tr> <th></th> <th>Control which ignores lock</th> <th>Objective louver No.</th> </tr> </thead> <tbody> <tr> <td>①</td> <td>Operation stop</td> <td>Full-close position</td> </tr> <tr> <td>②</td> <td>When heating operation start</td> <td>Horizontal discharge position</td> </tr> <tr> <td>③</td> <td>Heating thermo-OFF</td> <td>Horizontal discharge position</td> </tr> <tr> <td>④</td> <td>During defrost operation</td> <td>Horizontal discharge position</td> </tr> <tr> <td>⑤</td> <td>Initialize operation</td> <td>Full-close position</td> </tr> </tbody> </table> <ul style="list-style-type: none"> The real louver swing corresponding to the louver No. displayed on the remote controller screen during setting of louver lock operates swinging. 		Control which ignores lock	Objective louver No.	①	Operation stop	Full-close position	②	When heating operation start	Horizontal discharge position	③	Heating thermo-OFF	Horizontal discharge position	④	During defrost operation	Horizontal discharge position	⑤	Initialize operation	Full-close position	For the setting operation, refer to [Louver lock] of Owner's Manual supplied with the wired remote controller.
	Control which ignores lock	Objective louver No.																		
①	Operation stop	Full-close position																		
②	When heating operation start	Horizontal discharge position																		
③	Heating thermo-OFF	Horizontal discharge position																		
④	During defrost operation	Horizontal discharge position																		
⑤	Initialize operation	Full-close position																		
9. Filter sign display (Except wireless type)	<ol style="list-style-type: none"> The operation time of the indoor fan is calculated, the filter reset signal is sent to the remote controller when the specified time (2500H) has passed, and it is displayed on LCD. When the filter reset signal has been received from the remote controller, time of the calculation timer is cleared. In this case, the measurement time is reset if the specified time has passed, and display on LCD disappears. 	[FILTER] goes on.																		
10. DC motor	<ol style="list-style-type: none"> When the fan operation has started, positioning of the stator and the rotor are performed. (Moves slightly with tap sound) The motor operates according to the command from the indoor controller. <p>Notes)</p> <ul style="list-style-type: none"> When the fan rotates while the air conditioner stops due to entering of outside air, etc, the air conditioner may operate while the fan motor stops. When a fan lock is found, the air conditioner stops, and a trouble is displayed. 	Check code [11]																		
11. Drain pump delay operation	When a cooling operation (including dry operation) is stopped, the drain pump continues operating for 5 minutes to reduce drain water in drain pan.																			
12. Occupancy sensor	<ol style="list-style-type: none"> During the Occupancy sensor operation (FC code: [B5] [0001] and [B6] [0001 to 0005]), when there is no people in the Occupancy sensor range, it is automatically switched to the operation for the absence. The Occupancy sensor operation can change by [FC code : B6] as follows, and operates according to the operation at absent time, if time or absence of the setting contents continues. However time counting starts after the room temperature is stabilized. (after for 30 minutes operation) <table border="1" data-bbox="467 1552 959 1688"> <thead> <tr> <th>FC [B6]</th> <th>Data</th> <th>Setting contents</th> </tr> </thead> <tbody> <tr> <td></td> <td>0000</td> <td>Invalid</td> </tr> <tr> <td></td> <td>0001 to 0005</td> <td>30 minutes to 150 minutes (30 minutes each)</td> </tr> </tbody> </table> <ol style="list-style-type: none"> The operation at absent time can be changed by [FC code : B7]. <table border="1" data-bbox="467 1765 959 1870"> <thead> <tr> <th>FC [B7]</th> <th>Data</th> <th>Operation at absent time</th> </tr> </thead> <tbody> <tr> <td></td> <td>0000</td> <td>Circulation mode</td> </tr> <tr> <td></td> <td>0001</td> <td>Operation stop</td> </tr> </tbody> </table>	FC [B6]	Data	Setting contents		0000	Invalid		0001 to 0005	30 minutes to 150 minutes (30 minutes each)	FC [B7]	Data	Operation at absent time		0000	Circulation mode		0001	Operation stop	The Occupancy sensor can be set up by wired remote controller.
FC [B6]	Data	Setting contents																		
	0000	Invalid																		
	0001 to 0005	30 minutes to 150 minutes (30 minutes each)																		
FC [B7]	Data	Operation at absent time																		
	0000	Circulation mode																		
	0001	Operation stop																		

Item	Operation flow and applicable data, etc	Description
13. Additional Operation	<p>1. QUIET mode When the [QUIET] button is pushed, the fan of the indoor unit will be restricted the revolving speed at speed L until the [QUIET] button is pushed once again (cancel Quiet mode).</p>	<p>Quiet mode is the system which, control the revolving speed of indoor fan to work constantly at speed L.</p> <p>Remarks :</p> <ol style="list-style-type: none"> 1. Quiet mode is unable to work in dry mode. 2. Quiet mode is appropriate to work with less cooling load and less heating load condition. Because of the fan speed L may cause not enough the cooling capacity or heating capacity.
	<p>2. Hi-POWER Mode ([Hi-POWER] button on the remote controller is pushed) When [Hi-POWER] button is pushed while the indoor unit is in Auto, Cooling or Heating operation, Hi-POWER mark is indicated on the display of the remote controller and the unit operates as follows.</p> <p>1. Automatic operation</p> <ul style="list-style-type: none"> • The indoor unit operates in according to the current operation. <p>2. Cooling operation</p> <ul style="list-style-type: none"> • The preset temperature drops 1°C (The value of the preset temperature on the remote controller does not change.) <p>3. Heating operation</p> <ul style="list-style-type: none"> • The preset temperature increases 2°C (The value of the preset temperature on the remote controller does not change.) <p>4. The Hi-POWER mode can not be set in Dry operation</p>	<p>Quiet mode is the system which, control the revolving speed of indoor fan to work constantly at speed L.</p> <p>Remarks :</p> <ol style="list-style-type: none"> 1. Quiet mode is unable to work in dry mode. 2. Quiet mode is appropriate to work with less cooling load and less heating load condition. Because of the fan speed L may cause not enough the cooling capacity or heating capacity.
	<p>3. ECO mode When pushing [ECO] button on the remote controller, an Economic operation is performed.</p>	<ol style="list-style-type: none"> 1) Temperature control Cooling operation The control target temperature increase 1°C per hour up to 2°C starting from the set temperature when ECO has been received. Heating operation The control target temperature decrease 1°C per hour up to 2°C starting from the set temperature when ECO has been received. 2) The indoor fan speed : presetting [AUTO] fan speed changes to L, [MANUAL] fan speed does not change. 3) Compressor speed is restricted to silent mode max. Hz.
	<p>4. COMFORT SLEEP mode</p> <p>Cooling mode</p> <ul style="list-style-type: none"> • The preset temperature will increase as ECO operation (Item ECO mode) • Push the [COMFORT SLEEP] button to choose the operating hours. Repeat pushing to select the hours. (1hr, 3hr, 5hr or 9hr) • If the [COMFORT SLEEP] button is pushed again means cancel comfort sleep mode. <p>Heating mode</p> <ul style="list-style-type: none"> • The preset temperature will drop down as ECO operation (Item ECO mode) • Push the [COMFORT SLEEP] button to choose the operating hours. Repeat pushing to select the hours. (1hr, 3hr, 5hr or 9 hr) • If the [COMFORT SLEEP] button is pushed again means cancel comfort sleep mode. 	<p>The principles of comfort sleep mode are:</p> <ul style="list-style-type: none"> • Quietness for more comfortable. • Save energy by changing room temperature automatically. • The air condition can shut down by itself automatically. <p>Remarks :</p> <ol style="list-style-type: none"> 1. Comfort sleep mode will not operate in dry mode and fan only mode.

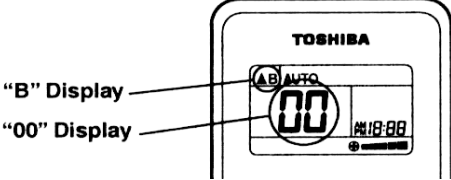
Item	Operation flow and applicable data, etc	Description
14. Remote-A or B selection	<p>Setting the remote controller To separate using of remote control for each indoor unit in case of 2 air conditioner are installed nearby.</p> <p>Remote Control B Setup.</p> <ol style="list-style-type: none"> 1) Push the STAR/STOP button to operate the air conditioner. Push it again to stop the air conditioner. 2) Push TEMPORARY button on the signal receiving unit to turn the air conditioner ON. 3) Point the remote control at the signal receiving unit. 4) Push and hold CHECK • button on the Remote Control by the tip of the pencil. "00" will be shown on the display. 5) Push MODE • during pushing CHECK •. "B" will show on the display and "00" will disappear and the air conditioner will turn OFF. The Remote Control B is memorized. <p>Note : 1. Repeat above step to reset Remote Control to be A. 2. Remote Control A has not "A" display. 3. Default setting of Remote Control from factory is A.</p> <div style="text-align: center;">  </div>	<p>1. Purpose This operation is to operate only one indoor unit using one remote controller.</p> <p>2. Description When operating one indoor unit in a situation where two indoor units have been installed in the same room or nearby rooms, this operation prevents the remote controller signal from being received simultaneously by both units, thus preventing both units from operating.</p> <p>3. Operation The indoor unit on which the remote controller selection has been set to B receives the signal of the remote controller also set to B. (At the factory the remote controller selection is set to A on all the indoor units. There is no A setting display.)</p>

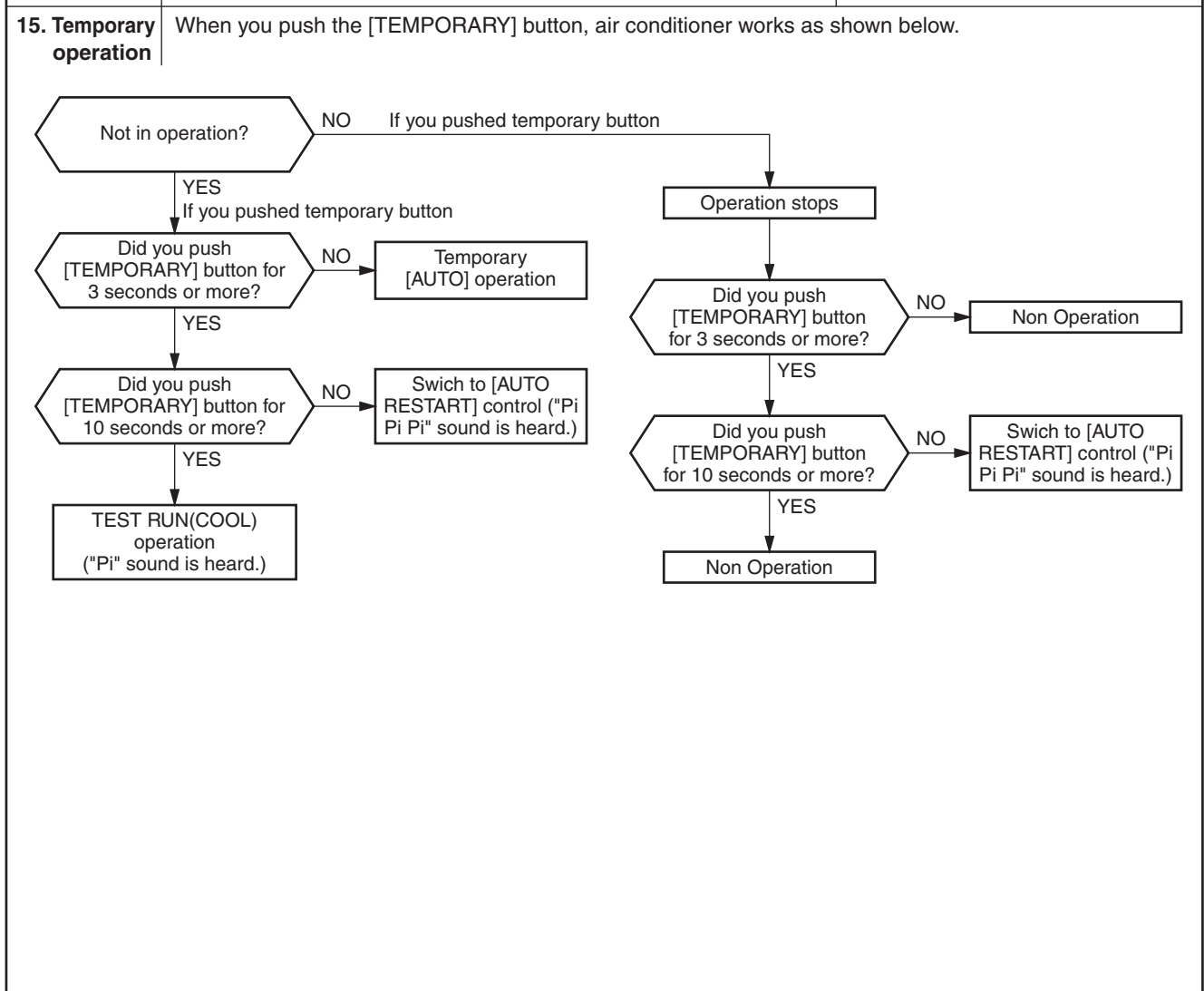

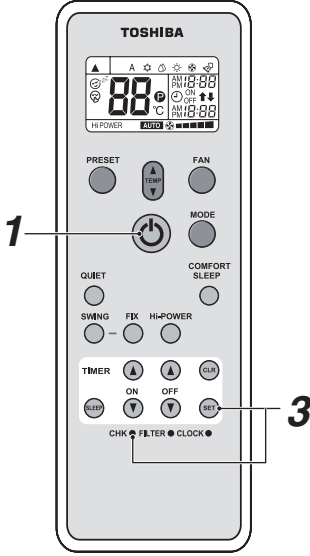
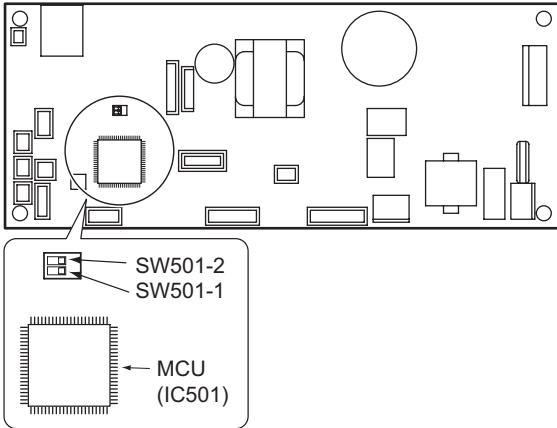
Item	Operation flow and applicable data, etc	Description																																				
16. Short Timer	<p>In the normal condition, after switching one circuit breaker, 3-minute delay time for compressor is set for the maintenance of the unit.</p> 	<p>Purpose To start the unit immediately for the purpose of testing, trial...etc, short timer can be used. maintenance of the unit.</p> <p>Short Timer Setting</p> <ol style="list-style-type: none"> 1 Push [⏻] button to turn the unit OFF. 2 Set the operation mode on the remote control without sending the signal to the unit. 3 Use the tip of the pencil to push the [CHECK] button and hold, "00" will show on display, then push [SET] button to make "00" disappear. 4 Push [⏻] button to turn the unit ON. 5 When short timer is activated, all setting on the remote operates immediately, besides, all indications on the signal receiving unit turns ON continuously for 3 seconds. 																																				
17. High ceiling select switch	<p><How to set the High ceiling switch></p> <ul style="list-style-type: none"> • Remove the cover of the electric parts box by taking off the mounting screws and pushing the hooking section. • There are the selector switches (SW501) on the P.C. board of the electric parts box. No.1 and No.2 of the selector switches (SW501) are provided to select the height of the ceiling. According to the ceiling height in the following table, select No.1 or No.2 of the selector switches (SW501). <table border="1" data-bbox="320 1128 764 1274"> <thead> <tr> <th>Model RAS-</th> <th>Possible installed ceiling height</th> </tr> </thead> <tbody> <tr> <td>M10,M13 type</td> <td>Up to 2.7 m</td> </tr> <tr> <td>M16 type</td> <td>Up to 3.5 m</td> </tr> </tbody> </table> <div data-bbox="831 1128 1275 1263" style="border: 1px solid black; padding: 5px; margin-top: 10px;"> <p style="text-align: center;">REMARKS</p> <p>When using the high ceiling (1) or (3), cold air may be felt due to the temperature drop of discharge air.</p> </div> <p><Height list of ceiling possible to be installed> Unit : m</p> <table border="1" data-bbox="320 1346 1398 1572"> <thead> <tr> <th>Indoor unit Capacity type</th> <th>M10, M13 type</th> <th>M16 type</th> <th>Setup of high ceiling</th> <th>SW501-1</th> <th>SW501-2</th> </tr> </thead> <tbody> <tr> <td>Discharge direction</td> <td>4-way</td> <td>4-way</td> <td>Setup data</td> <td></td> <td></td> </tr> <tr> <td>Standard (Factory default)</td> <td>2.7</td> <td>2.9</td> <td>0000</td> <td>OFF</td> <td>OFF</td> </tr> <tr> <td>High ceiling (1)</td> <td>—</td> <td>3.2</td> <td>0001</td> <td>ON</td> <td>OFF</td> </tr> <tr> <td>High ceiling (3)</td> <td>—</td> <td>3.5</td> <td>0003</td> <td>OFF</td> <td>ON</td> </tr> </tbody> </table> 	Model RAS-	Possible installed ceiling height	M10,M13 type	Up to 2.7 m	M16 type	Up to 3.5 m	Indoor unit Capacity type	M10, M13 type	M16 type	Setup of high ceiling	SW501-1	SW501-2	Discharge direction	4-way	4-way	Setup data			Standard (Factory default)	2.7	2.9	0000	OFF	OFF	High ceiling (1)	—	3.2	0001	ON	OFF	High ceiling (3)	—	3.5	0003	OFF	ON	
Model RAS-	Possible installed ceiling height																																					
M10,M13 type	Up to 2.7 m																																					
M16 type	Up to 3.5 m																																					
Indoor unit Capacity type	M10, M13 type	M16 type	Setup of high ceiling	SW501-1	SW501-2																																	
Discharge direction	4-way	4-way	Setup data																																			
Standard (Factory default)	2.7	2.9	0000	OFF	OFF																																	
High ceiling (1)	—	3.2	0001	ON	OFF																																	
High ceiling (3)	—	3.5	0003	OFF	ON																																	

9-3. Auto Restart Function

This indoor unit is equipped with an automatic restarting function which allows the unit to restart operating with the set operating conditions in the event of a power supply being accidentally shut down.
 The operation will resume without warning three minutes after power is restored.
 This function is not set to work when shipped from the factory. Therefore it is necessary to set it to work.

1. How to Set the Auto Restart Function

Before setting, push the START/STOP button to operate the air conditioner and push it again to stop.

To set the auto restart function, proceed as follows:

The power supply to the unit must be on ; the function will not set if the power is off.

Push and hold the TEMPORARY button on the signal receiving unit for 3 seconds to set the operation (3 beep sound and OPERATION lamp blink 5 time/sec for 5 seconds).

The unit then restarts operating automatically in the event of power supply being accidentally shut down.

• When the unit is standby (Not operating)

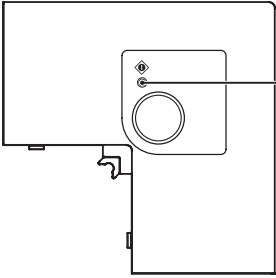
Operation	Motions
<p>Push [TEMPORARY] button for more than three seconds. (Less than 10 seconds)</p>  <p>TEMPORARY button</p>	<p>The unit is on standby.</p> <p>↓</p> <p>The unit starts to operate. The green indicator is on.</p> <p>↓</p> <p>After approx. three seconds, release [TEMPORARY] button from being pushed.</p> <p>The unit beeps three times and continues to operate. The green indicator flashes for 5 seconds.</p> <p>If the unit is not required to operate at this time, push [TEMPORARY] button once more or use the remote controller to turn it off.</p>

• When the unit is in operation

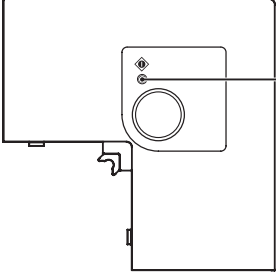
Operation	Motions
<p>Push [TEMPORARY] button for more than three seconds. (Less than 10 seconds)</p>  <p>TEMPORARY button</p>	<p>The unit is in operation. The green indicator is on.</p> <p>↓</p> <p>The unit stops operating. The green indicator is turned off.</p> <p>↓</p> <p>After approx. three seconds, release [TEMPORARY] button from being pushed.</p> <p>The unit beeps three times. The green indicator flashes for 5 seconds.</p> <p>If the unit is required to operate at this time, push [TEMPORARY] button once more or use the remote controller to turn it on.</p>

2. How to Cancel the Auto Restart Function

To cancel auto restart function, proceed as follows :

Repeat the setting procedure : the unit receives the signal and beeps three times.

The unit will be required to be turned on with the remote controller after the main power supply is turned off.

• When the system is on stand-by (not operating)

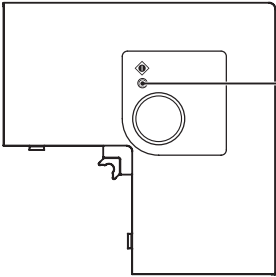
Operation	Motions
<p>Push [TEMPORARY] button for more than three seconds. (Less than 10 seconds)</p>  <p>TEMPORARY button</p>	<p>The unit is on standby.</p> <p>↓</p> <p>The unit starts to operate. The green indicator is on.</p> <p>↓</p> <p>After approx. three seconds, release [TEMPORARY] button from being pushed.</p> <p>The unit beeps three times and continues to operate.</p> <p>If the unit is not required to operate at this time, push [TEMPORARY] button once more or use the remote controller to turn it off.</p>

• When the system is operating

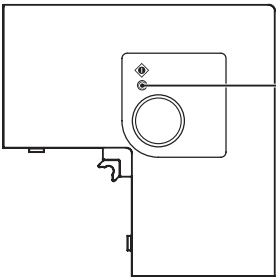
Operation	Motions
<p>Push [TEMPORARY] button for more than three seconds. (Less than 10 seconds)</p>  <p>TEMPORARY button</p>	<p>The unit is in operation. The green indicator is on.</p> <p>↓</p> <p>The unit stops operating. The green indicator is turned off.</p> <p>↓</p> <p>After approx. three seconds, release [TEMPORARY] button from being pushed.</p> <p>The unit beeps three times.</p> <p>If the unit is required to operate at this time, push [TEMPORARY] button once more or use the remote controller to turn it on.</p>

3. Power Failure During Timer Operation

When the unit is turned off because of power failure during timer operation, the timer operation is cancelled. In that case, set the timer operation again.

NOTE :

The Daily Timer is reset while a command signal can be received from the remote controller even if it stopped due to a power failure.

9-4. Wireless remote controller

1. Remote controller

- Illustration of LCD shown below is for explanation. It may differ from the actual LCD.

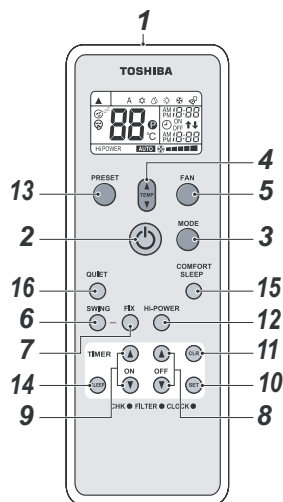

1 Infrared signal emitter

Transmits a signal to the indoor unit.

2 START/STOP button

Push the button to start operation.
(A receiving beep is heard.)
Push the button again to stop operation.
(A receiving beep is heard.)
If no receiving sound is heard from the indoor unit, push the button twice.

3 Mode select button (MODE)

Push this button to select a mode.
Each time you push the button, a mode is selected in a sequence that goes from A : Auto changeover control,
☀ : Cool, 💧 : Dry, ☀ : Heat, 🌀 : Fan only, and back to A. (A receiving beep is heard.)

4 Temperature button ()

▲...The set temperature is increased up to 30 °C.
▼...The set temperature is dropped down to 17 °C.
(A receiving beep is heard.)

5 Fan speed button (FAN)

Push this button to select fan speed. When you select AUTO, the fan speed is automatically adjusted according to the room temperature. You can also manually select the desired fan speed.
(LOW ■, LOW+ ■■, MED ■■■, MED+ ■■■■, HIGH ■■■■■)
(A receiving beep is heard.)

6 Auto louver button (SWING)

Push this button to swing the louver.
(A receiving beep is heard.)
Push the SWING button to stop the louver swinging.
(A receiving beep is heard.)

7 Set louver button (FIX)

Push this button to adjust the airflow direction. (A receiving beep is heard.) It cannot be operated by holding down the button. Push the button with some interval.

8 Off timer button (OFF)

Push this button to set the OFF timer.

9 On timer button (ON)

Push this button to set the ON timer.

10 Reserve button (SET)

Push this button to reserve time settings.
(A receiving beep is heard.)

11 Cancel button (CLR)

Push this button to cancel ON timer and OFF timer. (A receiving beep is heard.)

12 High power button (Hi-POWER)

Push this button to start the high power operation.

13 PRESET button

Push this button to change the operation mode to the preferred operation mode memorized previously. To memorize the operation mode, push this button for at least 3 seconds during the preferred operation mode.
Ⓟ is displayed and the operation mode is memorized.

14 SLEEP button

Push this button to start the OFF timer operation that automatically adjusts the room temperature and the fan speed.
You can select the OFF timer time from four durations
(1, 3, 5 or 9 hours).

15 COMFORT SLEEP button

Push this button to start the OFF timer operation that automatically adjusts the room temperature and the fan speed.
You can select the OFF timer time from four durations
(1, 3, 5 or 9 hours).

16 QUIET button

Push this button to start quiet operation.
Pushing this button again will restore normal operation.

2. Names and functions of indications on wireless remote controller

Display

All indications, except for clock time indication, are indicated by pushing the START/STOP button.

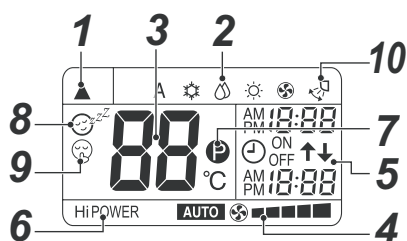

- In the illustration, all indications are indicated for explanation. During operation, only the relevant indications will be indicated on the remote controller.

1 Transmission mark

This transmission mark (▲) indicates when the remote controller transmits signals to the indoor unit.

2 Mode display

Indicates the current operation mode.
 (A : Auto changeover control, ☀ : Cool, 💧 : Dry, 🔥 : Heat, 🌀 : Fan only)

3 Temperature display

Indicates the temperature setting (17 °C to 30 °C).
 When you set the operating mode to 🌀 : Fan only, no temperature setting is indicated.

4 FAN speed display

Indicates the selected fan speed. AUTO or one of five fan speed levels (LOW ■, LOW+ ■■, MED ■■■, MED+ ■■■■, HIGH ■■■■■) can be indicated.
 Indicates **AUTO** when the operating mode is 💧 : Dry.

5 TIMER and clock time display

The time set for timer operation or clock time is indicated.
 The present time is always indicated except for TIMER operation.

6 Hi POWER display

Indicates when the high power operation starts.
 Push the Hi-POWER button to start and push it again to stop the operation.

7 P (PRESET) display

Indicated when memorizing the preferred operation mode or when it has been memorized.
 Also, this icon is indicated when the memorized preferred operation is displayed.

8 zzz (COMFORT SLEEP) display

Indicated during the OFF timer operation that automatically adjusts the room temperature and the fan speed. Each time you push the COMFORT SLEEP button, the display changes in the sequence of 1h, 3h, 5h, and 9h.

9 🤫 (QUIET) display

Indicated during the quiet operation.

10 Swing display

Indicated during the swinging operation where the horizontal louver automatically moves up and down.

NOTE

When both wired remote controller or central controller and wireless remote controller are used, display on the screen of wireless remote controller may differ from the actual operation in some cases.

3. Signal receiving unit

The signal receiving unit is attached to the indoor unit.

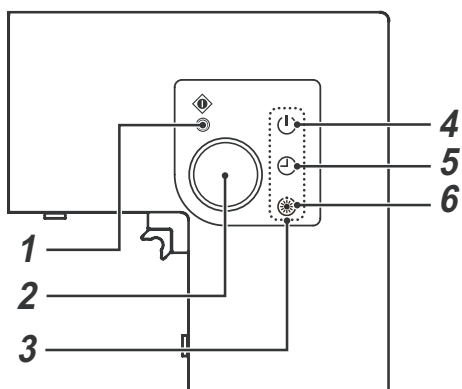

1 Temporary operation button

2 Signal receiving part

The signal sent from the remote controller is received.

3 Display lamp

One of displays flashed while a trouble occurs.
When the display lamp flashes, refer to “Before asking for repair work”.

4 lamp (Green)

This lamp illuminates when unit is on.

5 lamp (Green)



This lamp illuminates while the timer is reserved.

6 lamp (Orange)

- In heating operation this lamp illuminates in the following cases;
The operation has started.
The temp. controller has worked.
The unit is under defrost operation.
- This lamp flashes while a trouble occurs.

CAUTION

Disagreement in operation mode

- If “pi, pi” sound is heard, the display lamp goes on, and the  lamp and  lamp flash alternately, the operation is not performed with the desired mode.
 - Even if you push START/STOP, MODE, TEMPERATURE buttons when remote controller operation is disabled by the central control or other means, “pi” is heard 5 times and the button operation is not accepted.
-

10. HOW TO DIAGNOSE THE TROUBLE

The pulse motor circuits are mounted to both indoor and outdoor units. Therefore, diagnose troubles according to the trouble diagnosis procedure as described below. (Refer to the check points in servicing written on the wiring diagrams attached to the indoor/outdoor units.)

Table 10-1

No.	Troubleshooting Procedure	No.	Troubleshooting Procedure
1	First Confirmation	6	How to Check Simply the Main Parts
2	Primary Judgment	7	Troubleshooting
3	Judgment by Flashing LED of the signal receiving unit	8	How to Diagnose Trouble in Outdoor Unit
4	Self-Diagnosis by Remote Controller	9	How to Check Simply the Main Parts
5	Judgment of Trouble by Every Symptom	10	How to Simply Judge Whether Outdoor Fan Motor is Good or Bad

10-1. First Confirmation

10-1-1. Confirmation of Power Supply

Confirm that the power breaker operates (ON) normally.

10-1-2. Confirmation of Power Voltage

Confirm that power voltage is AC 220–230–240 ± 10%.
If power voltage is not in this range, the unit may not operate normally.

10-1-3. Operation Which is not a Trouble (Program Operation)

For controlling the air conditioner, the program operations are built in the microcomputer as described in the following table.

If a claim is made for running operation, check whether or not it meets to the contents in the following table. When it does, we inform you that it is not trouble of equipment, but it is indispensable for controlling and maintaining of air conditioner.

Table 10-1-1

No.	Operation of air conditioner	Description
1	When power breaker is turned "ON", the operation indicator (Green) of the signal receiving unit flashes.	The OPERATION lamp of the signal receiving unit flashes when power source is turned on. If [⏻] button is operated once, flashing stops. (Flashes also in power failure)
2	Compressor may not operate even if the room temperature is within range of compressor-ON.	The compressor does not operate while compressor restart delay timer (3-minutes timer) operates. The same phenomenon is found after power source has been turned on because 3-minutes timer operates.
3	In Dry and ECO mode, FAN (air flow) display does not change even though FAN (air flow select) button is operated.	The air flow indication is fixed to [AUTO].
4	In AUTO mode, the operation mode is changed.	After selecting Cool or Heat mode, select an operation mode again if the compressor keeps stop status for 15 minutes.

10-2. Primary Judgment

To diagnose the troubles, use the following methods.

- 1) Judgment by flashing LED of the signal receiving unit
- 2) Self-diagnosis by service check remote controller
- 3) Judgment of trouble by every symptom

Firstly use the method 1) for diagnosis. Then, use the method 2) or 3) to diagnose the details of troubles.

10-3. Judgment by Flashing LED of the signal receiving unit

While the indoor unit monitors the operation status of the air conditioner, if the protective circuit operates, the contents of self-diagnosis are displayed with block on the indoor unit indication section.

Table 10-3-1

	Item	Check code	Block display	Description for self-diagnosis
<div style="border: 1px solid black; padding: 5px; width: fit-content; margin-bottom: 5px;">the signal receiving unit indication lamp flashes.</div> <div style="text-align: center;">↓</div> <div style="border: 1px solid black; padding: 5px; width: fit-content; margin-bottom: 5px;">Which lamp does flash?</div> <div style="display: flex; justify-content: space-between;"> <div style="width: 15%;"></div> <div style="width: 15%; text-align: center;">↓</div> <div style="width: 15%;"></div> <div style="width: 15%; text-align: center;">→</div> <div style="width: 40%;"></div> </div>	A	—	OPERATION (Green) Flashing display (1 Hz)	Power failure (when power is ON)
	B	00	OPERATION (Green) Flashing display (1 Hz)	Protective circuit operation for indoor P.C. board
	C	01	OPERATION (Green) TIMER (Orange) Flashing display (1 Hz)	Protective circuit operation for connecting cable and serial signal system
	D	02	OPERATION (Green) PRE.DEF (Orange) Flashing display (1 Hz)	Protective circuit operation for outdoor P.C. board
	E	03	OPERATION (Green) TIMER (Orange) PRE.DEF (Orange) Flashing display (1 Hz)	Protective circuit operation for others (including compressor)

NOTES :

1. The contents of items B and C and a part of item E are displayed when air conditioner operates.
2. When item B and C, and item B and a part of item E occur concurrently, priority is given to the block of item B.
3. The check codes can be confirmed on the remote controller for servicing.

10-4. Self-Diagnosis by Remote Controller (Check Code)

1. If the lamps are indicated as shown B to E in Table 10-3-1, execute the self-diagnosis by the remote controller.
2. When the remote controller is set to the service mode, the indoor controller diagnoses the operation condition and indicates the information of the self-diagnosis on the display of the remote controller with the check codes.
If a fault is detected, all lamps on the signal receiving unit flash at 5Hz and it will beep for 10 seconds (Beep, Beep, Beep ...). The timer lamp usually flashes (5Hz) during self-diagnosis.

10-4-1. How to Use Remote Controller in Service Mode

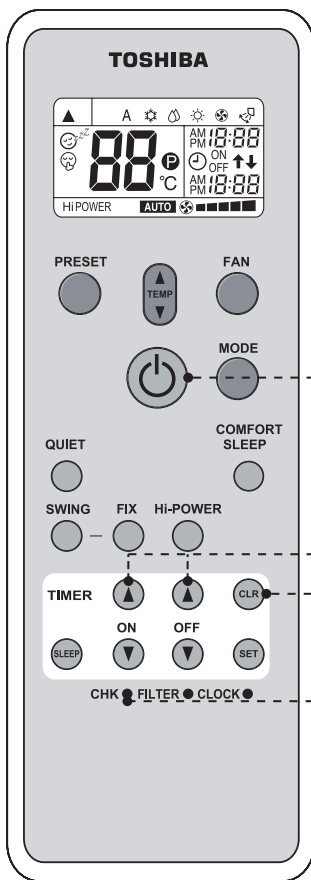

1 Press [CHK] button with a tip of pencil to set the remote controller to the service mode.

- "00" is indicated on the display of the remote controller.

2 Press [ON ▲] or [OFF ▲] button

If there is no fault with a code, the indoor unit will beep once (Beep) and the display of the remote controller will change as follows :

➤ 00 → 01 → 02 ... 1d → 1E → 33

- The TIMER indicator of the signal receiving unit flashes continuously. (5 times per 1 sec.)
- Check the unit with all 52 check codes (00 to 33) as shown in Table-10-4-2.
- Press [ON ▼] or [OFF ▼] button to change the check code backward.

If there is a fault, the indoor unit will beep for 10 seconds (Beep, Beep, Beep...).

Note the check code on the display of the remote controller.

- 2-digits alphanumeric will be indicated on the display.
- All indicators on the signal receiving unit will flash. (5 times per 1 sec.)

3 Press [CLR] button. After service finish for clear service code in memory.

- "7F" is indicated on the display of the remote control.

4 Press [⏻] button to release the service mode.

- The display of the remote controller returns to as it was before service mode was engaged.

Alphanumeric characters are used for the check codes.

5 is 5.	6 is 6.
A is A.	B is B.
C is C.	D is D.

Fig. 10-4-1

10-4-2. Caution at Servicing

1. After servicing, press the [CLR] button to return to the normal mode.
2. After servicing by the check code, turn off breaker of the power supply, and turn on breaker of the power supply again so that memory in the microcomputer returns the initial status.
However, the check codes are not deleted even if the power supply is turned off because they are stored in the fixed memory.
3. After servicing, press [CLR] button under check mode status and then send the check code "7F" to the indoor unit. The check code stored in memory is cleared.

Table 10-4-2

Block distinction		Operation of diagnosis function				Judgment and action
Check code	Block	Check code	Cause of operation	Air conditioner status	Remarks	
00	Indoor P.C. board etc.	0C	Short-circuit or disconnection of the room temperature sensor (TA sensor).	Operation continues.	Displayed when trouble is detected.	1. Check the room temp. sensor. 2. When the room temp. sensor is normal, check P.C. board.
		0d	Being out of place, disconnection, shortcircuit, or migration of heat exchanger sensor (TC sensor)	Operation continues.	Displayed when trouble is detected.	1. Check heat exchanger sensor. 2. When heat exchanger sensor is normal, check P.C. board.
		0F	Being out of place, disconnection, short-circuit, or migration of heat exchanger sensor (TCJ sensor).	Operation continues.	Displayed when trouble is detected.	1. Check heat exchanger sensor. 2. When heat exchanger sensor is normal, check P.C. board.
		11	Lock of indoor fan or trouble on the indoor fan circuit	All off	Displayed when trouble is detected.	1. Check the motor. 2. When the motor is normal, check P.C. board.
		0b	Float SW operation	Operation continues. (Outdoor units stop.)	Displayed when trouble is detected.	1. Check the drainage. 1) Amount of residual drain. 2) Drain water piping installation situation. 2. Float SW operation check 3. Check disconnection of connector.
	Not displayed	12	Trouble on other indoor P.C. boards	Operation continues.	Displayed when trouble is detected.	Replace P.C. board.
	Wired Remote Controller	30	Communication with wired remote controller is trouble.		Displayed when trouble is detected.	Check wired remote controller connection.
	Indoor P.C. board	31	Capacity Date is not set.		Displayed when trouble is detected.	Set Function Code 11 properly.
Indoor P.C. board	32	Disconnection of the occupancy sensor.	Operation continues.	Displayed when trouble is detected.	1. Check power supply / communication harness. 2. Check P.C. board.	
01	Connecting cable and serial signal	04	Return serial signal is not sent to indoor side from operation started. 1) Defective wiring of connecting cable 2) Operation of compressor thermo Gas shortage Gas leak	Operation continues.	Flashes when trouble is detected on Return serial signal, and normal status when signal is reset.	1. When the outdoor unit never operate: 1) Check connecting cable, and correct if defective wiring. 2) Check fuse of inverter P.C. board. 2. To display [Other] block during operation, check compressor thermo. operation and supply gas (check gas leak also). 3. Unit operates normally during check. If return serial signal does not stop between indoor terminal 2 and 3, replace inverter P.C. board. If signal stops between indoor terminal 2 and 3, replace indoor P.C. board.

Block distinction		Operation of diagnosis function				Judgment and action
Check code	Block	Check code	Cause of operation	Air conditioner status	Remarks	
02	Outdoor P.C. board	14	Inverter over-current protective circuit operates. (Short time)	All off	Displayed when trouble is detected.	Even if trying operation again, all operations stop immediately. : Replace P.C. board.
		15	Position-detect circuit trouble or short-circuit between windings of compressor	All off	Displayed when trouble is detected.	1. Even if connecting lead wire of compressor is removed, position-detect circuit trouble occurred. : Replace P.C. board. 2. Measure resistance between wires of compressor, and perform short-circuit. : Replace compressor.
		17	Current-detect circuit trouble	All off	Displayed when trouble is detected.	Even if trying operation again, all operations stop immediately. : Replace P.C. board.
		18	Being out of place, disconnection or shortcircuit of the outdoor heat exchanger sensor (TE) or suction temp. sensor (Ts)	All off	Displayed when trouble is detected.	1. Check sensors (TE, TS). 2. Check P.C. board.
		19	Disconnection or shortcircuit of discharge temp. sensor (Td)	All off	Displayed when trouble is detected.	1. Check discharge temp. sensor (TD). 2. Check P.C. board
		1A	Outdoor fan drive system trouble	All off	Displayed when trouble is detected.	Position-detect trouble, over-current protective operation of outdoor fan drive system, fan lock, etc. : Replace P.C. board or fan motor.
	Not displayed	1b	Outdoor heat exchanger temp. sensor trouble	Operation continues	—	1. Check outdoor temp. sensor (TO). 2. Check P.C. board.
	Outdoor P.C. board	1c	Compressor drive output trouble, Compressor trouble (lock, missing, etc.), Break down	All off	Displayed when trouble is detected.	When 20 seconds passed after start-up, position-detect circuit trouble occurred. : Replace compressor. Trouble on P.M.V.

Block distinction		Operation of diagnosis function				Judgment and action
Check code	Block	Check code	Cause of operation	Air conditioner status	Remarks	
03	Others (including compressor)	07	Return serial signal has been sent when operation started, but it is not sent from halfway. 1) Compressor thermo. operation Gas shortage Gas leak 2) Instantaneous power failure	Operation continues	Flashes when trouble is detected on return serial signal, and normal status when signal is reset.	1. Repeat Start and Stop with interval of approx. 10 to 40 minutes. (Code is not displayed during operation.) Supply gas. (Check also gas leak). 2. Unit operates normally during check. If return serial signal does not stop between indoor terminal block 2 and 3, replace inverter P.C. board. If signal stops between indoor terminal block 2 and 3, replace indoor P.C. board.
		1d	Compressor does not rotate. (Current protective circuit does not operate when a specified time passed after compressor had been activated.)	All off	Displayed when trouble is detected.	1. Trouble on compressor 2. Trouble on wiring of compressor (Missed phase)
		1E	Discharge temp. exceeded 117°C	All off	Displayed when trouble is detected.	1. Check discharge temp. sensor (TD). 2. Gas leakage 3. Trouble on P.M.V.
		1F	Break down of compressor	All off	Displayed when trouble is detected.	1. Check power voltage. (220–230–240 V +10%) 2. Overload operation of refrigeration cycle Check installation condition (Short-circuit of outdoor diffuser).

10-5. Judgment of Trouble by Every Symptom

10-5-1. Indoor Unit (Including Remote Controller)

(1) Power is not turned on (Does not operate entirely)

<Primary check>

1. Is the supply voltage normal?
2. Is the normal voltage provided to the outdoor unit?
3. Is the crossover cable connected properly?
4. Is the fuse (F01) blown?

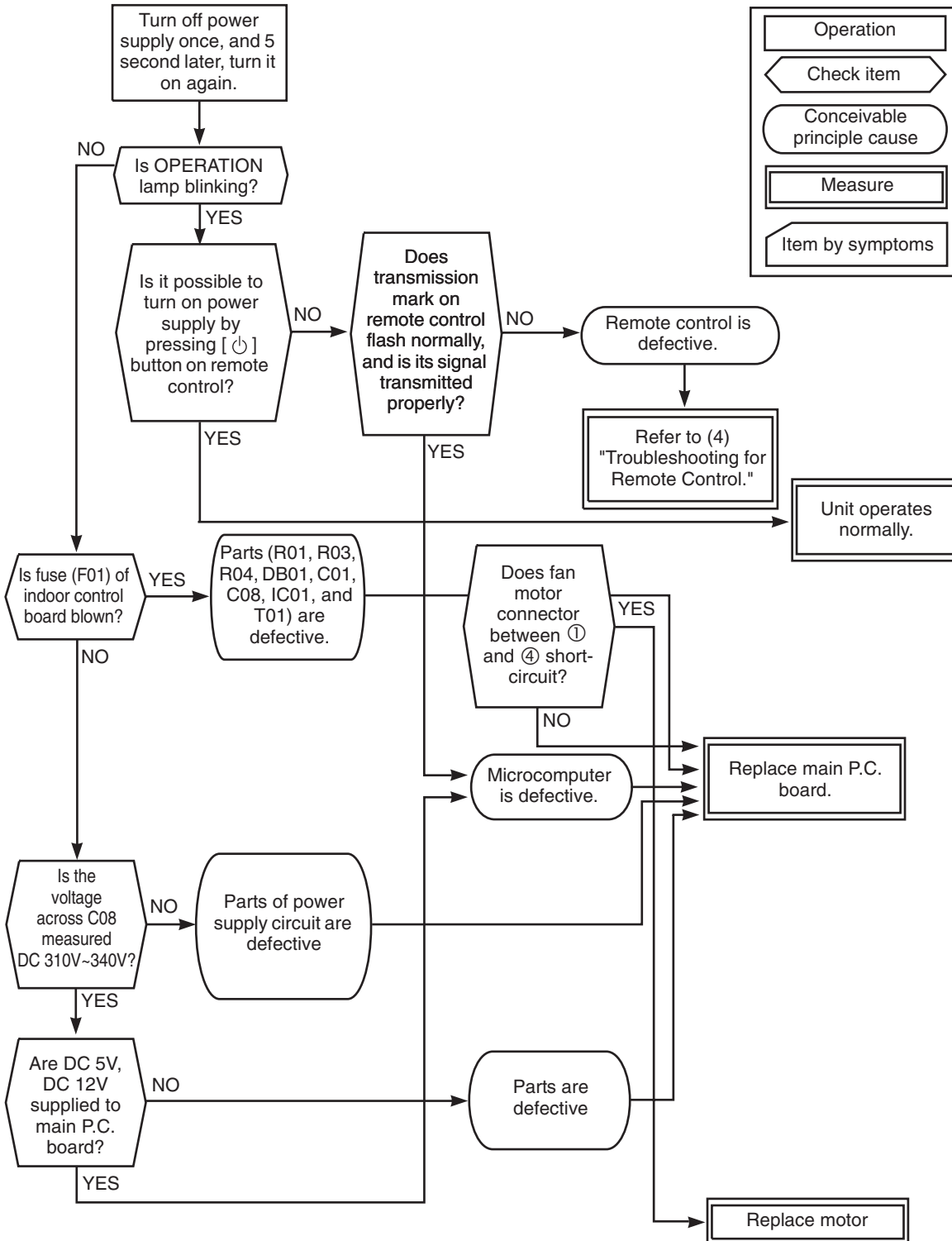

- Be sure to disconnect the motor connector CN210 after shut off the power supply, or it will be a cause of damage of the motor.

(2) Power is not turned on though Indoor P.C. board is replaced
<Confirmation procedure>

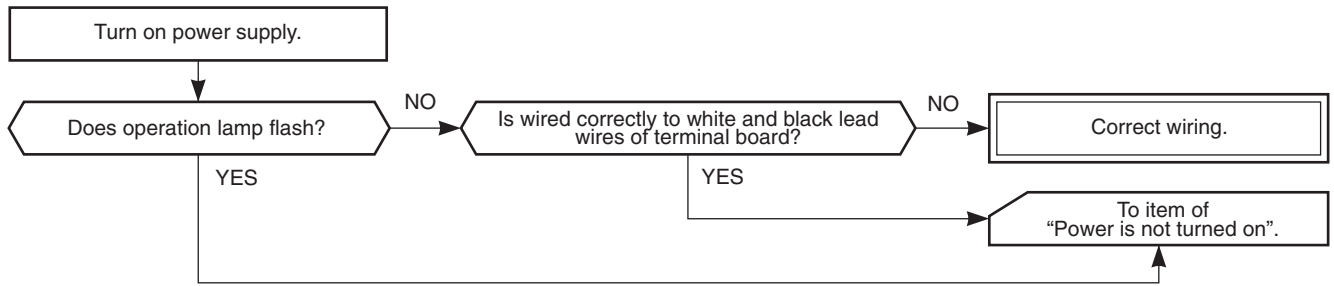

(3) Only the indoor motor fan does not operate

<Primary check>

1. Is it possible to detect the power supply voltage (AC220–240V) between ① and ② on the terminal block?
2. Does the indoor fan motor operate in cooling operation?
(In heating operation, the indoor fan motor does not operate for approximately 10 minutes after it is turned on, to prevent a cold air from blowing in.)

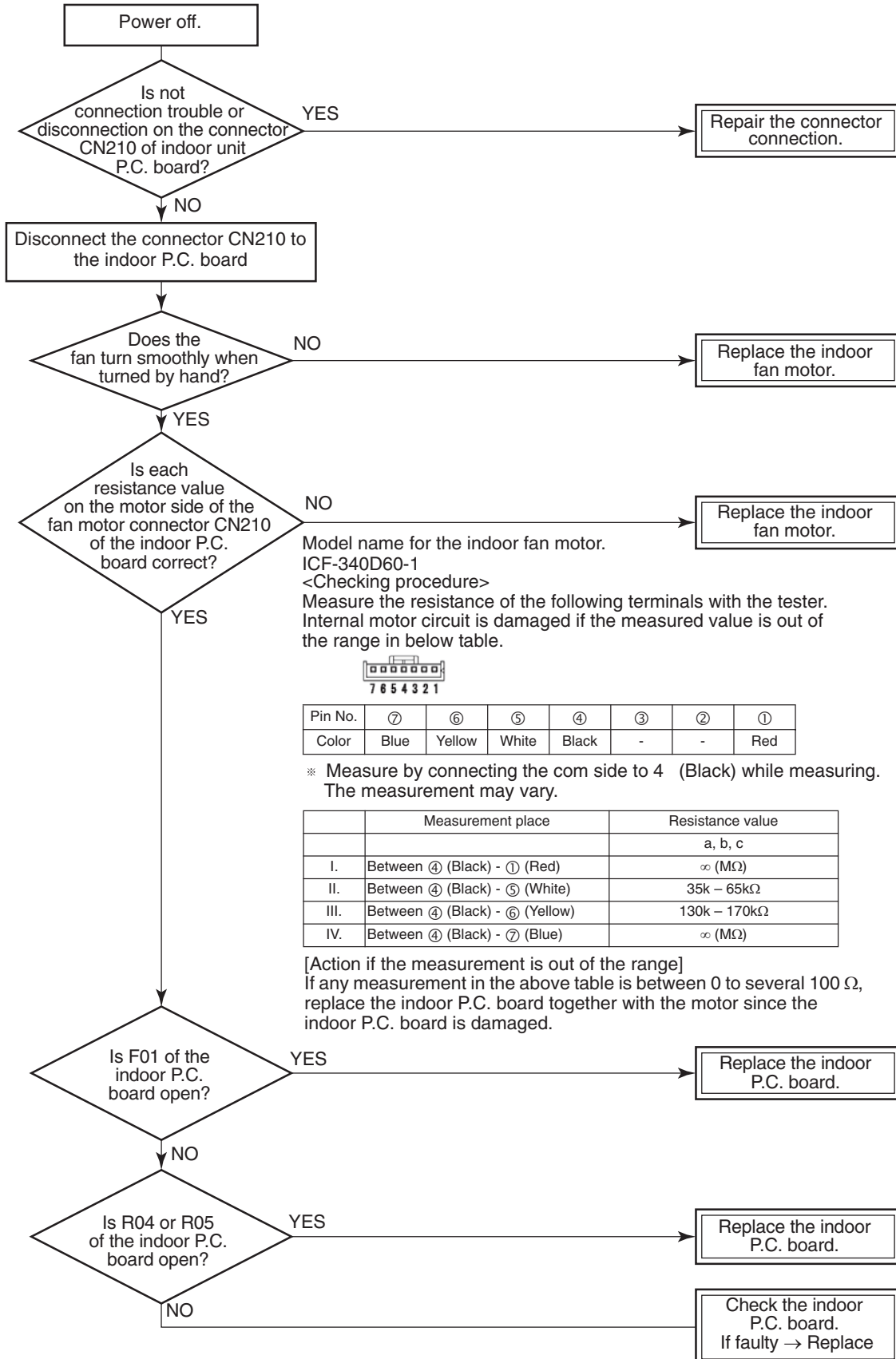

(4) Troubleshooting for remote control

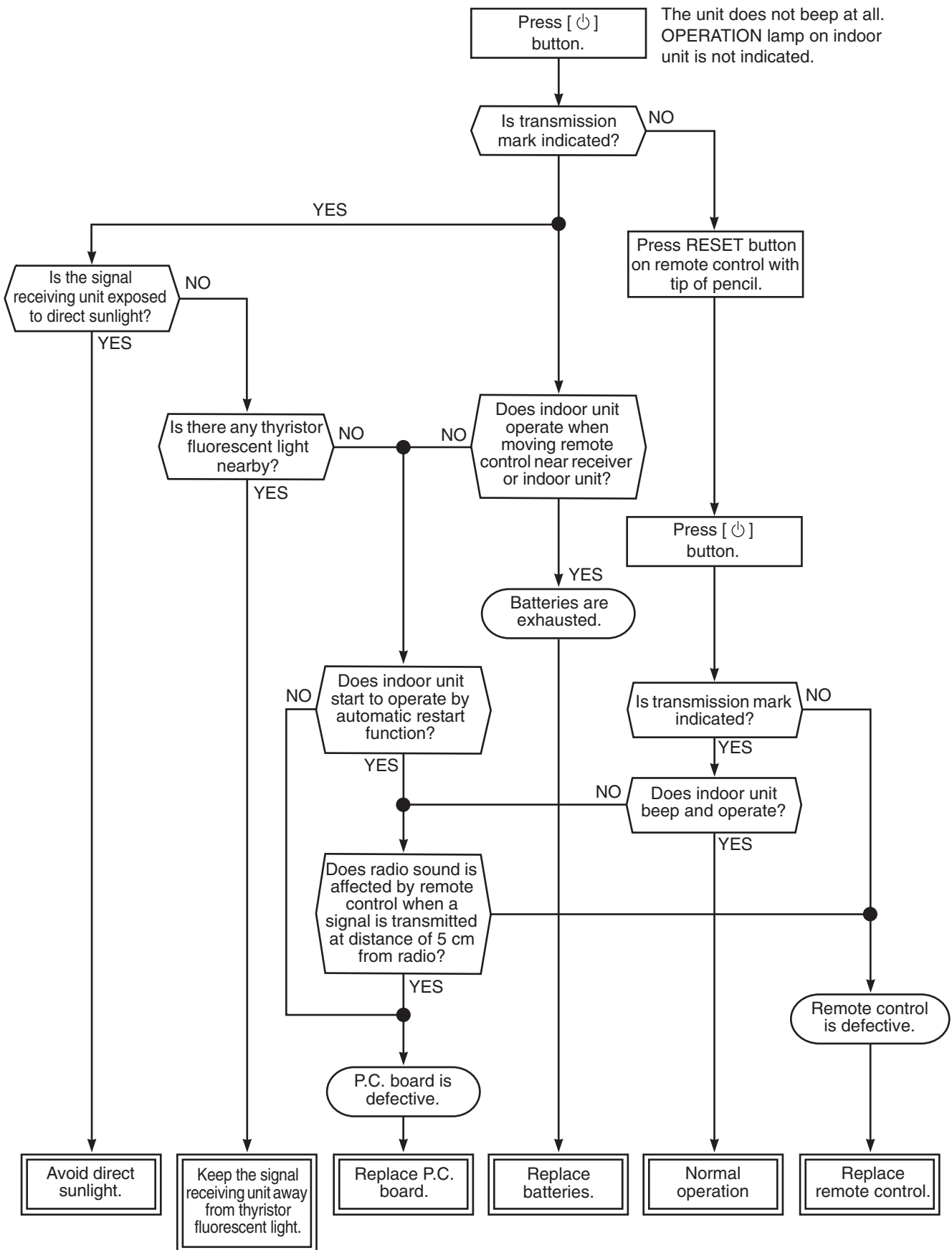

10-6. How to Check Simply the Main Parts

10-6-1. How to Check the P.C. Board (Indoor Unit)

(1) Operating precautions

- 1) When removing the P.C. board, be sure to shut off the power supply breaker.
- 2) When removing the P.C. board, hold the edge of the P.C. board and do not apply force to the parts.
- 3) When connecting or disconnecting the connectors on the P.C. board, hold the whole housing.
Do not pull at the lead wire.

(2) Inspection procedures

- 1) When a P.C. board is judged to be defective, check for disconnection, burning, or discoloration of the copper foil pattern on this P.C. board.
- 2) The P.C. board consists of the following 2 parts
 - a. **Main P.C. board part :**
DC power supply circuit, Indoor fan motor control circuit, CPU and peripheral circuits, buzzer.
 - b. **The signal receiving unit of infrared ray receiving circuit, LED :**
To check defect of the P.C. board, follow the procedure described below.

(3) Check procedures

Table 10-6-1

No.	Procedure	Check points	Causes
1	Turn off the power supply breaker and remove the P.C. board assembly from electronic parts base. Remove the connecting cables from the terminal block.	Check whether or not the fuse (F01) is blown.	Impulse voltage was applied or the indoor fan motor short-circuited.
2	Remove the connector of the motor and turn on the power supply breaker. If OPERATION indicator flashes (once per second), it is not necessary to check steps (1 to 3) in the right next column.	Check power supply voltage : 1. Between No. 1 and No. 3 of CN67 (AC 220–240V) 2. Between ⊕ and ⊖ of CN08 (DC 310–340V) 3. Between 12V and GND 4. Between 5V and GND	1. The terminal block or the crossover cable is connected wrongly. 2. The capacitor (C01) Varistor (R01), line filter (L01), resistor (R03,R04), or the diode (DB01) is defective. 3. T01 is defective. 4. IC01,IC02 and T01 are defective.
3	Push [⏻] button once to start the unit. (Do not set the mode to On-Timer operation.)	Check power supply voltage : 1. Between No.1 and No.3 of CN67 (DC 15–60V)	IC08 and IC09 are defective.
4	Shorten the restart delay timer and start unit.	Check whether or not all indicators (OPERATION, TIMER, PRE. DEF, Hi POWER) are lit for 3 seconds and they return to normal 3 seconds later.	The indicators are defective or the housing assembly (CN214) is defective.
5	Push [⏻] button once to start the unit. • Shorten the restart delay timer. • Set the operation mode to COOL. • Set the fan speed level to AUTO. • Set the preset temperature much lower than the room temperature. (The unit (compressor) operates continuously in the above condition.)	1. Check whether or not the compressor operates. 2. Check whether or not the OPERATION indicator flashes.	1. The temperature of the indoor heat exchanger is extremely low. 2. The connection of the heat exchanger sensor is loose. (The connector is disconnected.) (CN101,CN102) 3. The heat exchanger sensor and the P.C. board are defective. (Refer to Table 10-4-1.) 4. The main P.C. board is defective.
6	Connect the motor connector to the motor and turn on the power supply. Start the unit the following condition. • Set the fan speed level to HIGH. (The unit (compressor) operates continuously in the above condition in No. 5.)	1. Check it is impossible to detect the voltage (DC15V) between No.4 and No.5 of the motor terminals. 2. The motor does not operate or the fan motor does not rotate with high speed. (But it is possible to receive the signal from the remote controller.) 3. The motor rotates but vibrates strongly.	1. The indoor fan motor is defective. (Protected operation of P.C. board.) 2. The P.C. board is defective. 3. The connection of the motor connector is loose.

11-6-2. P.C . Board Layout

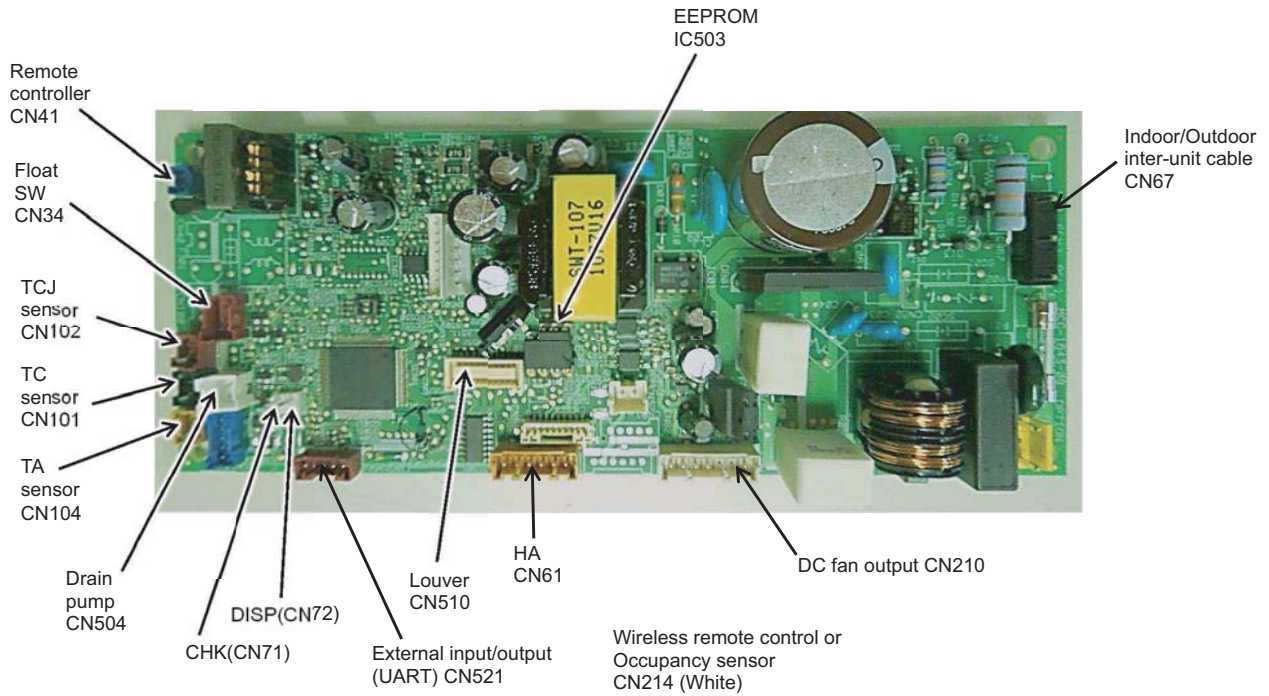

[1] Sensor characteristic table

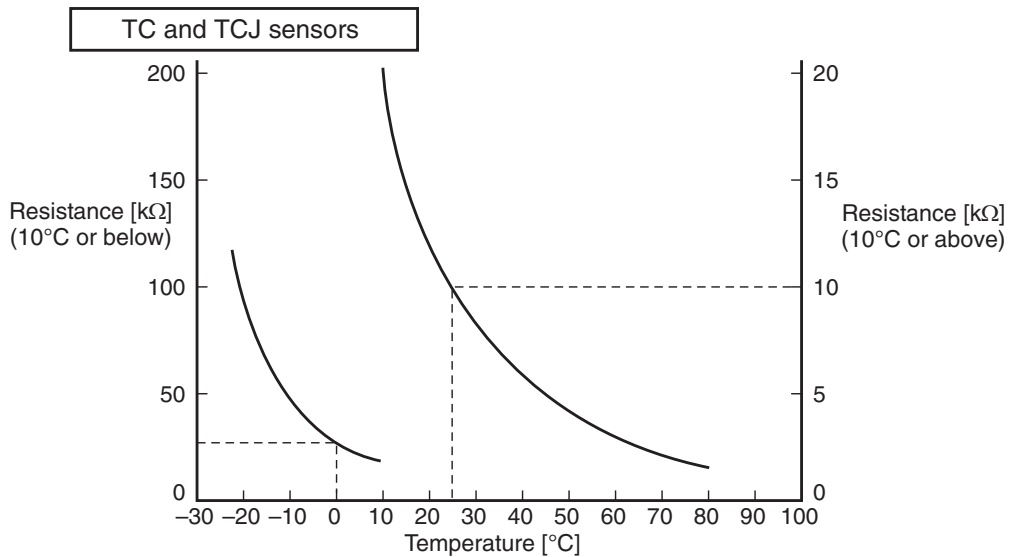
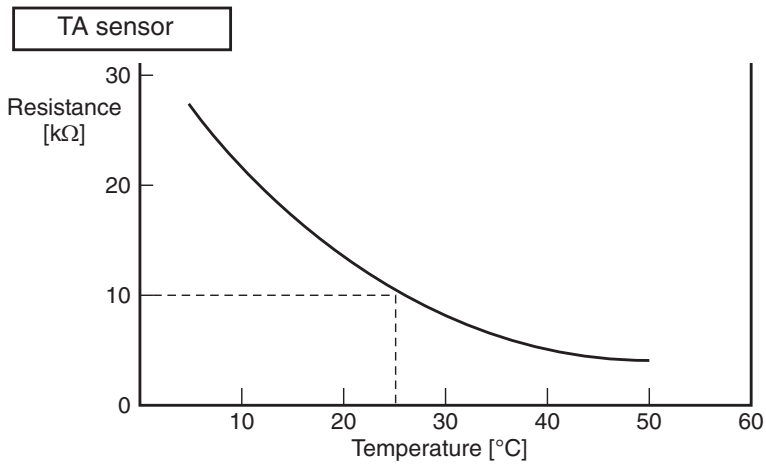

10-6-3. Indoor Unit (Other Parts)

No.	Part name	Checking procedure												
1	Room temp. (TA) sensor Heat exchanger (TC) sensor	Disconnect the connector and measure the resistance value with tester. (Normal temp.) <table border="1" data-bbox="576 353 1412 436"> <thead> <tr> <th>Sensor \ Temperature</th> <th>10°C</th> <th>20°C</th> <th>25°C</th> <th>30°C</th> <th>40°C</th> </tr> </thead> <tbody> <tr> <td>TA, TC (kΩ)</td> <td>20.7</td> <td>12.6</td> <td>10.0</td> <td>7.9</td> <td>4.5</td> </tr> </tbody> </table>	Sensor \ Temperature	10°C	20°C	25°C	30°C	40°C	TA, TC (kΩ)	20.7	12.6	10.0	7.9	4.5
Sensor \ Temperature	10°C	20°C	25°C	30°C	40°C									
TA, TC (kΩ)	20.7	12.6	10.0	7.9	4.5									
2	Remote controller	Refer to 10-5-1. (4).												
3	Indoor fan motor	Refer to 10-5-1. (3).												



11. HOW TO REPLACE THE MAIN PARTS

⚠ WARNING

Be sure to stop operation of the air conditioner before work and then turn off switch of the breaker.

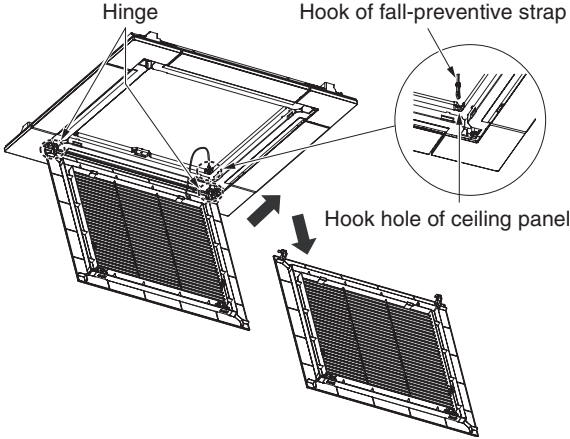
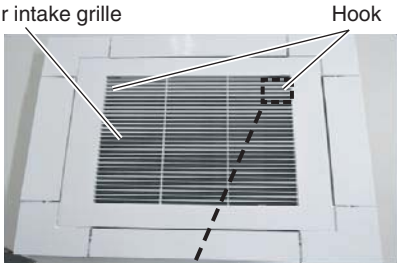
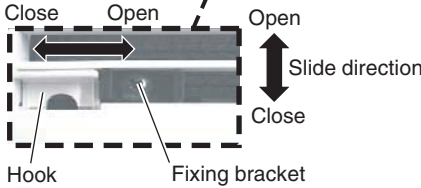
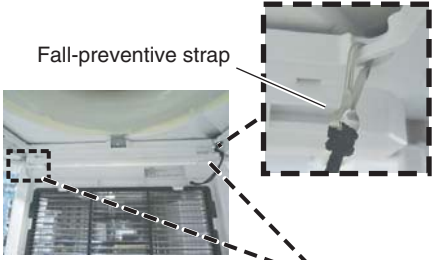
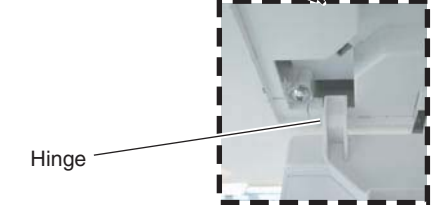

⚠ CAUTION

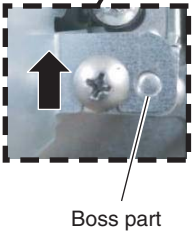
Be sure to put on gloves during working time; otherwise an injury will be caused by a part etc.

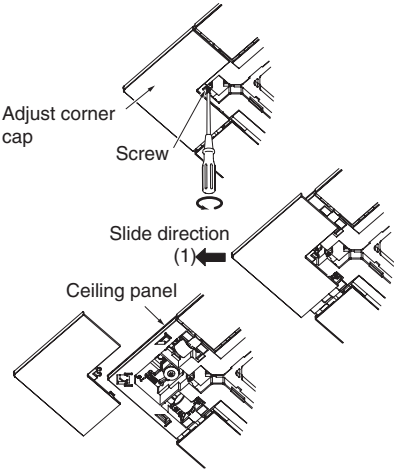

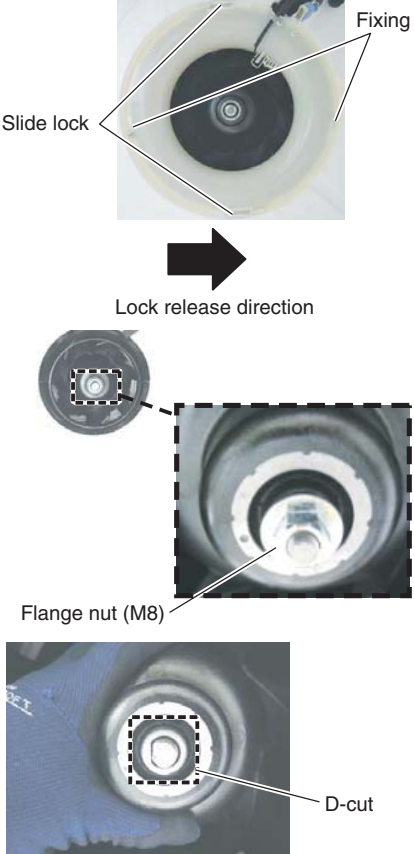
No.	Part name	Procedure	Remarks
①	Air intake grille	<p>1. Detachment</p> <ol style="list-style-type: none"> 1) Stop operation of the air conditioner and then turn off switch of the circuit breaker. 2) Loosen the fixing screw. And slide the fixing bracket toward the inside. (Ø4 × 8, 1 pcs.) 3) Holding the air intake grille, slide the hook in the direction of the arrow and slowly open the grille. 4) Remove the hook of the fall-preventive strap from the ceiling panel. Remove the hinge section of the air intake grille from the ceiling panel while the air intake grille is opened. <p>2. Attachment</p> <ol style="list-style-type: none"> 1) Hook the hinge of the air intake grille to the main panel, and then attach the fall-preventive strap. 2) Close the air intake grille, and then slide the hook. 3) Slide the grille fixing bracket to fix it with the screws. (Ø4 × 8, 1pc.) 	<p>Remarks</p>    
②	Electric parts cover	<p>1. Detachment</p> <ol style="list-style-type: none"> 1) Loosen the fixing screws (2 places) of the electric parts cover. (Ø4 × 8, 2 pcs.) 2) Slide the electric parts cover toward upper side to remove it. <p>2. Attachment</p> <ol style="list-style-type: none"> 1) Slide the electric parts cover to attach it. (Arrange the boss at the electric parts side just on the boss hole at the cover side.) 2) Tighten the screws of the electric parts cover (2 positions) to fix it. (Ø4 × 8, 2 pcs.) 	  

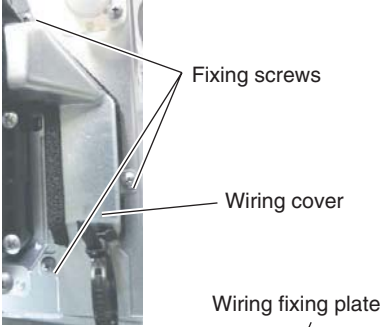
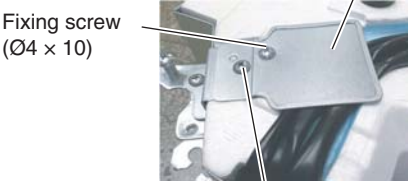
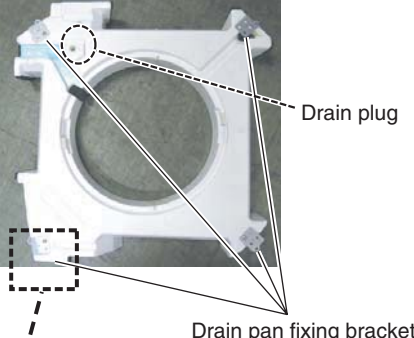
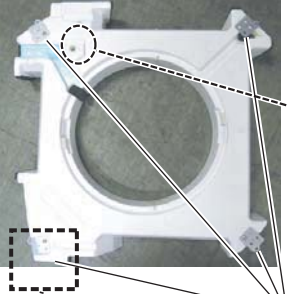
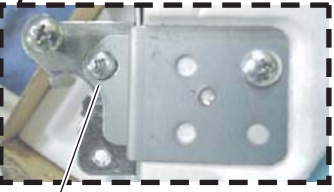
No.	Part name	Procedure	Remarks
③	Adjust corner cap	<p>1. Detachment</p> <ol style="list-style-type: none"> 1) Remove the air intake grille. (Refer to 1 of ①.) 2) Loosen the fixing screws on the adjust corner cap. (Ø4 × 12, 4 pcs.) 3) Slide the adjust corner cap to outside to remove it. <p>2. Attachment</p> <ol style="list-style-type: none"> 1) Matching claws (5 positions) of the adjust corner cap to holes of the panel main unit holes and attach them. 2) Tighten the fixing screws of the adjust corner cap (Ø4 × 12, 4 pcs.). <p>NOTE</p> <p>Tighten the screw with a hand screwdriver and do not use a tool such as an electric screwdriver. Tightening torque : 1 N•m or less</p>	
④	Ceiling panel	<p>1. Detachment</p> <ol style="list-style-type: none"> 1) Remove the air intake grille and the adjust corner cap. (Refer to 1 of ① and 1 of ③.) 2) Remove the louver motor connector. 3) By sliding the panel fixing bracket of the corner part, remove it from the fixing screws. (Total 4 positions) 4) Push the tentative hanging hook at the center part of the ceiling panel main body toward the outside of the ceiling panel, and then remove the ceiling panel from the indoor unit. <p>2. Attachment</p> <ol style="list-style-type: none"> 1) Match the louver motor connector of the ceiling panel so that it directs to the electric parts side, and then hook the tentative hanging hook at the center part of the ceiling panel main body to the bell mouth. 2) Connect the louver motor connectors at the ceiling panel side and the indoor unit side. 3) Lift up the panel corner part and put out the screw head of the panel fixed implement. Slide the panel fixed bracket, and then fix the indoor unit and the ceiling panel. (Total 4 positions). * In case of loosening screws of the panel fixed implement so that screw head is out under the panel fixed implement, retighten the screws after work. 4) Following to the works in items ③-2 and ①-2, attach the adjust corner cap and the air intake grille as original. <p>NOTE</p> <ul style="list-style-type: none"> • The ceiling panel aligns directionally with the indoor unit. Check that the lead wires of louver motor connector are on the electrical control box side. • When a clearance is found between the ceiling surface and the ceiling panel, readjust height of the indoor unit even if the screws have been tightened. 	

No.	Part name	Procedure	Remarks
⑤	Control P.C. board	<p>1. Detachment</p> <ol style="list-style-type: none"> 1) Remove the electric parts cover. (Refer to 1 of ②) 2) Remove connectors which are connected from the control P.C. board to the other parts and then remove wiring from the clamp. <p>NOTE</p> <hr/> <p>Unlock the lock of the housing part and then remove the connector.</p> <hr/> <p>CN34 : Float switch (3P, Red) CN41 : Remote controller (2P, Blue) CN67 : Power supply wires (5P, Black) CN101 : TC sensor (2P, Black) CN102 : TCJ sensor (2P, Red) CN104 : Room temp. (TA) sensor (2P, Yellow) CN510 : Louver motor (20P, White) CN504 : Drain pump (2P, White) CN210 : Fan motor (7P, White) CN22 : Earth wire (Tab terminal)</p> <ol style="list-style-type: none"> 3) Unlock the locks of the card edge spacer (4 positions) and remove the control P. C. board. <p>2. Attachment</p> <ol style="list-style-type: none"> 1) Fix the control board to the card edge spacer (4 positions). 2) Connect the removed connectors as original, which were unconnected in item 1. Detachment, and fix the wires with clamps. 3) Following to the work in ②-2, attach the electric parts covers as original. 	 <p>Clamp Card edge spacer</p>
⑥	Turbo fan	<p>1. Detachment</p> <ol style="list-style-type: none"> 1) Remove the air intake grille. (Refer to 1 of ①.) 2) Loosen the fix screws (2 positions) of the bell mouth, rotate the bell mouth, and then take off it. (Ø4 × 10, 2 pcs.) 3) Loosen the flange nut (M8) at the center part of the turbo fan, and then take off (Counter clockwise) * Supporting with hands, take off the turbo fan so that it will not fall down. <p>NOTE</p> <hr/> <p>Use a box wrench for attachment and detachment of the turbo fan. If using monkey wrench etc., the other parts may be damaged in work.</p> <hr/> <p>2. Attachment</p> <ol style="list-style-type: none"> 1) Match the D-cut of the motor shaft with the boss part D-cut of the turbo fan, and then insert the turbo fan into the motor shaft. 2) Tighten M8 nut with flange. (Tightening torque of the turbo fan: 5.4+0.5, -0.2N•m) 3) Slide the Bell mouth removed in item 1-2) and attach it then fix it with screws. (Ø4 × 10, 2 pcs.). 4) Following to the work in item ①-2, attach the air intake grille as original. <p>NOTE</p> <hr/> <p>(Tightening torque of the turbo fan: 5.4 (+0.5, -0.2)N•m)</p>	 <p>Slide lock Fixing</p> <p>Lock release direction</p> <p>Flange nut (M8)</p> <p>D-cut</p>

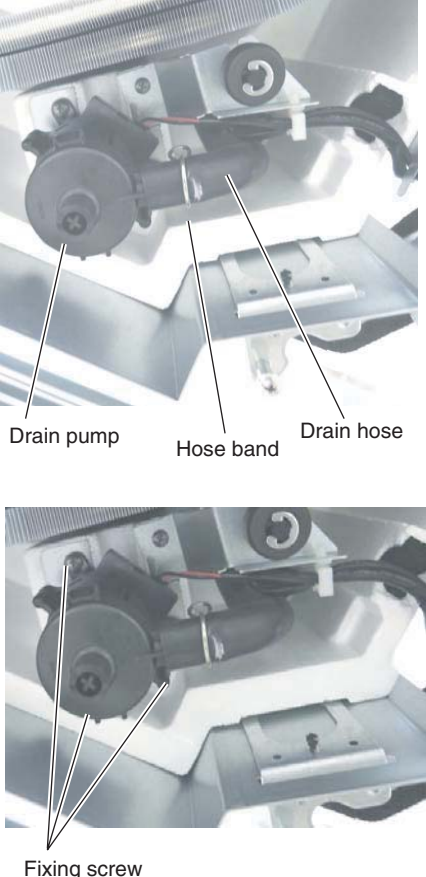
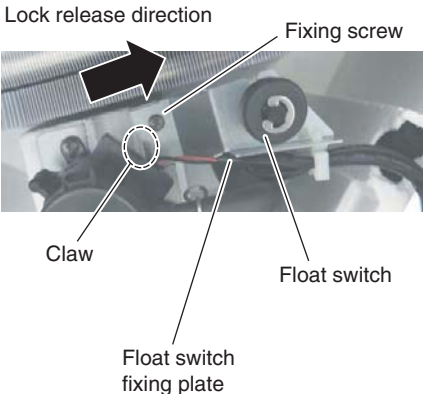
No.	Part name	Procedure	Remarks
⑦	Drain pan	<p>1. Detachment</p> <ol style="list-style-type: none"> 1) Remove the ceiling panel and the electrical parts covers. (Refer to items ④-1 and ②-1.) 2) Remove the wiring cover. (Fixing screw $\varnothing 4 \times 8$, 3pcs.) 3) Remove the wiring fixing plate. (Fixing screw $\varnothing 4 \times 8$, 1pc, $\varnothing 4 \times 10$, 1pc.) 4) Remove the connectors of the fan motor lead wire, louver motor lead wire, and room temperature (TA) sensor from the control P.C. board, and then remove the wiring from the clamp. * Pull out the wires from the hole at the side face of the electric parts. CN210: Fan motor (7P, White) CN510: Louver motor lead wire (20P, White) CN104: TA (Room temperature) sensor (2P, Yellow) 5) Remove the drain plug of the drain pan, and extract the stayed drain water. * Be careful that water is extracted at a stretch when taking off the drain plug. * When taking off the drain plug, be sure to prepare a bucket, etc. for spilled water. 6) Remove the fixing screws of the drain pan fixing bracket. ($\varnothing 4 \times 8$, 4 pcs.) 7) Using the both hands, hold the water-spilling port part of the drain pan and then slowly pull out the foaming parts firstly. * As there is remained water in the drain pan, clear it carefully. <p>2. Attachment</p> <ol style="list-style-type: none"> 1) Arrange direction of the drain pan directly to the foaming parts and insert it. * Pass the fan motor lead wire through the inner side of the drain pan. 2) Attach the fixing screws of the drain pan fixing implement which was taken off in item 1-6). ($\varnothing 4 \times 12$, 4 pcs.) 3) Insert the drain plug. (Put the tool with thin top in the hole of the drain plug, and then push the plug in.) 4) Perform wiring works to original arrangement, wiring of the fan motor, louver motor lead wires, and the room temperature (TA) sensor, and then attach the wiring fixing bracket and the wiring cover. 5) Following to works in items ④-2 and ②-2, attach the panel, electric parts cover as original. 	      <p>Push in the drain plug with the thin tip tool.</p>

No.	Part name	Procedure	Remarks
⑧	Drain pump	<p>1. Detachment</p> <ol style="list-style-type: none"> 1) Remove the drain pan. (Refer to ⑦-1.) 2) Remove the drain pump connector (CN504: 2P, White) connected to the control P.C. board and remove the lead wires from the clamp. 3) Remove the fixing screws to remove the drain pump. (Ø4 × 10, 3 pcs.) 4) Move the knob of the hose band which fixes the drain hose a little from pump connecting part to the hose side, and then remove the drain hose from the drain pump. * Be careful that water may be out. <p>2. Attachment</p> <ol style="list-style-type: none"> 1) Confirm the direction of the drain pump, and then fix it with screws. (Ø4 × 10, 3 pcs.) 2) Connect the drain hose to the drain pump. * For the drain hose, insert up to the root of the connecting part. * Attach a band to the marked position of the hose, and the knob of a hose band is attached to the deep side of a set. 3) Pass the drain pump wiring through side plate and clamp, and then connect the connector to the control P.C. board. 4) Following to work in ⑦-2, attach the drain pan, panel, and electrical parts covers as original. 	 <p>Drain pump Hose band Drain hose</p> <p>Fixing screw</p>
⑨	Float switch	<p>1. Detachment</p> <ol style="list-style-type: none"> 1) Remove the drain pan. (Refer to ⑦-1.) 2) Remove the float switch connector (CN34 3P, Red) connected to the control P.C. board, and then take off the lead wires from the clamp. 3) Remove the screws which fix the float switch. (Ø4 × 8, 1 pc.) 4) Slide the float switch fixed bracket as direction shown in the right figure, and then take off it from the claw. <p>2. Attachment</p> <ol style="list-style-type: none"> 1) Insert the float switch fixing plate into the claw, and tighten the fixing screw. 2) Pass the float switch lead wires through the side plate and the clamp, and then connect the connector to the control P.C. board. 3) Following to work in ⑦-2, attach the covers of the drain pan, panel, and electric parts box as original. 	 <p>Lock release direction Fixing screw</p> <p>Claw Float switch</p> <p>Float switch fixing plate</p>

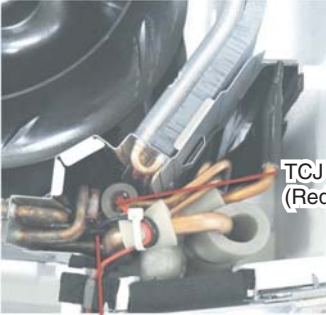
No.	Part name	Procedure	Remarks
⑩	Fan motor	<p>1. Detachment</p> <ol style="list-style-type: none"> 1) Remove the turbo fan, electric parts cover, wiring cover and wiring fixing plate. (Refer to ⑥-1, ②-1, ⑦-1-2, ⑦-1-3.) 2) Remove the fan motor connector (CN210, White, 7P) connected to the control P.C. board, and then take off the lead wires from the clamp. 3) Remove the shoulder screws (Black, 2pcs.) of the motor lead wiring cover, and separate the lead wires and the lead wire cover. 4) Remove the hexagon nuts (M6) which fix the motor, and the washers. (3 pcs. Each). * When taking off them, hold them with a hand so that motor will not fall down. 5) Remove the motor with rubber cushion from the bolt. <p>2. Attachment</p> <ol style="list-style-type: none"> 1) Pass rubber cushion of the motor in the bolt, put the washer and the hexagon nut in this order, and then tighten to fix them. (Tightening torque: $4.9 \pm 0.5N \cdot m$) 2) Pass the lead wire through the motor lead wire fixing plate removed in 1-3), and then fix it with shoulder screw. 3) Perform wiring of the motor lead wires as original, connect the connector to the control P.C. board, and then attach the wiring fixing plate and the wiring cover. 4) Following to works in ⑥-2 and ②-2, attach the turbo fan and the electric parts covers. 	 <p>Shoulder screws (Black)</p> <p>Motor lead wire cover</p>   <p>Bolt</p> <p>Hexagon nut</p> <p>Washer</p> <p>Rubber cushion</p>
⑪	TC TCJ Sensor	<p>1. Detachment</p> <ol style="list-style-type: none"> 1) Remove the drain pan. (Refer to ⑦-1.) 2) Pull out the sensor to be exchanged from the sensor holder. 3) Remove the connector connected to the control P.C. board, and take off wires from the clamp. (Refer to ⑤.) <p>2. Attachment</p> <ol style="list-style-type: none"> 1) Insert the sensor to be exchanged into the specified sensor. (Refer to the right figure.) 2) Perform wiring of the sensor as original. 	 <p>TCJ sensor (Red)</p> <p>TC sensor (Black)</p>

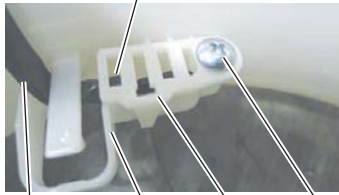
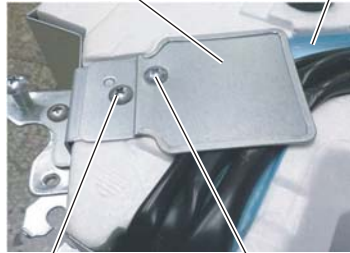
No.	Part name	Procedure	Remarks
⑫	TA sensor	<p>1. Detachment</p> <ol style="list-style-type: none"> 1) Remove the panel, electric parts box cover, wiring cover and wiring fixing plate. (Refer to ④-1, ②-1, ⑦-1-2, ⑦-1-3.) 2) Disconnect TA sensor connector (CN104 Yellow, 2P) which is connected to the control P.C. board, and take off the lead wire from the clamp. 3) Remove the screw of the TA sensor cover. ($\varnothing 4 \times 10$, 1pc.) 4) Remove TA sensor from the TA sensor fixed implement. <p>2. Attachment</p> <ol style="list-style-type: none"> 1) Fix TA sensor to TA sensor fixing implement, and fix the TA sensor cover with screw. ($\varnothing 4 \times 10$, 1 pcs, $\varnothing 4 \times 8$, 1 pcs.) 2) Perform wiring of TA sensor as original. 	<p>Adjust position of the tube so that the tube of TA sensor will be included in the cover.</p>  <p>TA sensor fixing bracket Fixing screw TA sensor TA sensor cover</p>  <p>Wiring fixing plate Groove for wiring of the drain pan</p> <p>Fixing screw ($\varnothing 4 \times 8$) Fixing screw ($\varnothing 4 \times 10$)</p>

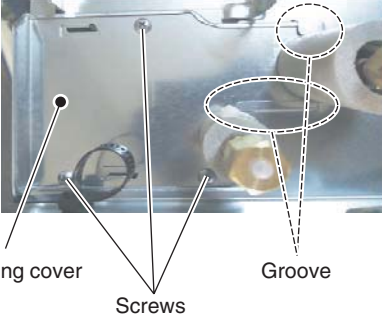
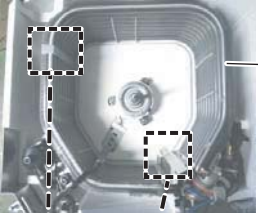
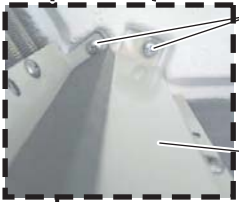
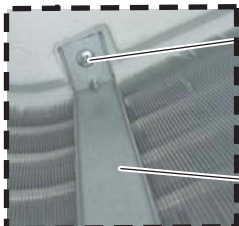
No.	Part name	Procedure	Remarks
⑬	Heat exchanger	<p>1. Detachment</p> <ol style="list-style-type: none"> 1) Recover refrigerant gas. 2) Remove the refrigerant pipe at indoor unit side. 3) Remove the drain pan. (Refer ⑦-1.) 4) Disconnect the heat exchanger sensor (TC1, TC2, TCJ), from the control P.C. board, and then remove their lead wires from the clamp. (Refer to ⑤-1.) 5) Remove the fixing screws of the piping cover and take off the piping cover. (Ø4 × 8, 3 pcs.) 6) Remove the shoulder screws of the separate plate (2 positions) and fixing plate (1 position), and then remove the heat exchanger. (3 shoulder screws) <p>NOTE</p> <hr/> <p>* Supporting with a hand, remove the heat exchanger so that it will not be fallen down.</p> <p>* Take note that you will not get hurt by touching to Aluminum fin. Be sure to put on the protective gloves and the safety working clothing.</p> <hr/> <p>2. Attachment</p> <ol style="list-style-type: none"> 1) Attach the heat exchanger as original with the separate plate and the fixing plate. 2) Slide the piping cover to the groove, fix it to the side plate, and then use the screws. (Ø4 × 8, 3 pcs.) 3) Perform wiring of the sensor wires as original. 4) Connect the refrigerant pipe as before and then apply vacuuming. 5) Following to the work in ⑦-2, attach the parts as original. 	 <p>Piping cover Screws Groove</p>  <p>Heat exchanger</p>  <p>Shoulder screw Separate plate</p>  <p>Shoulder screw Fixing plate</p>
<p>NOTE</p> <hr/> <p>After assembling, check if that there is no abnormal sound, vibration, or puncture. Check the exchange point when you have a problem.</p> <hr/>			

12. EXPLODED VIEWS AND PARTS LIST

12-1. RAS-M10U2MUVG-E, M13U2MUVG-E, M16U2MUVG-E

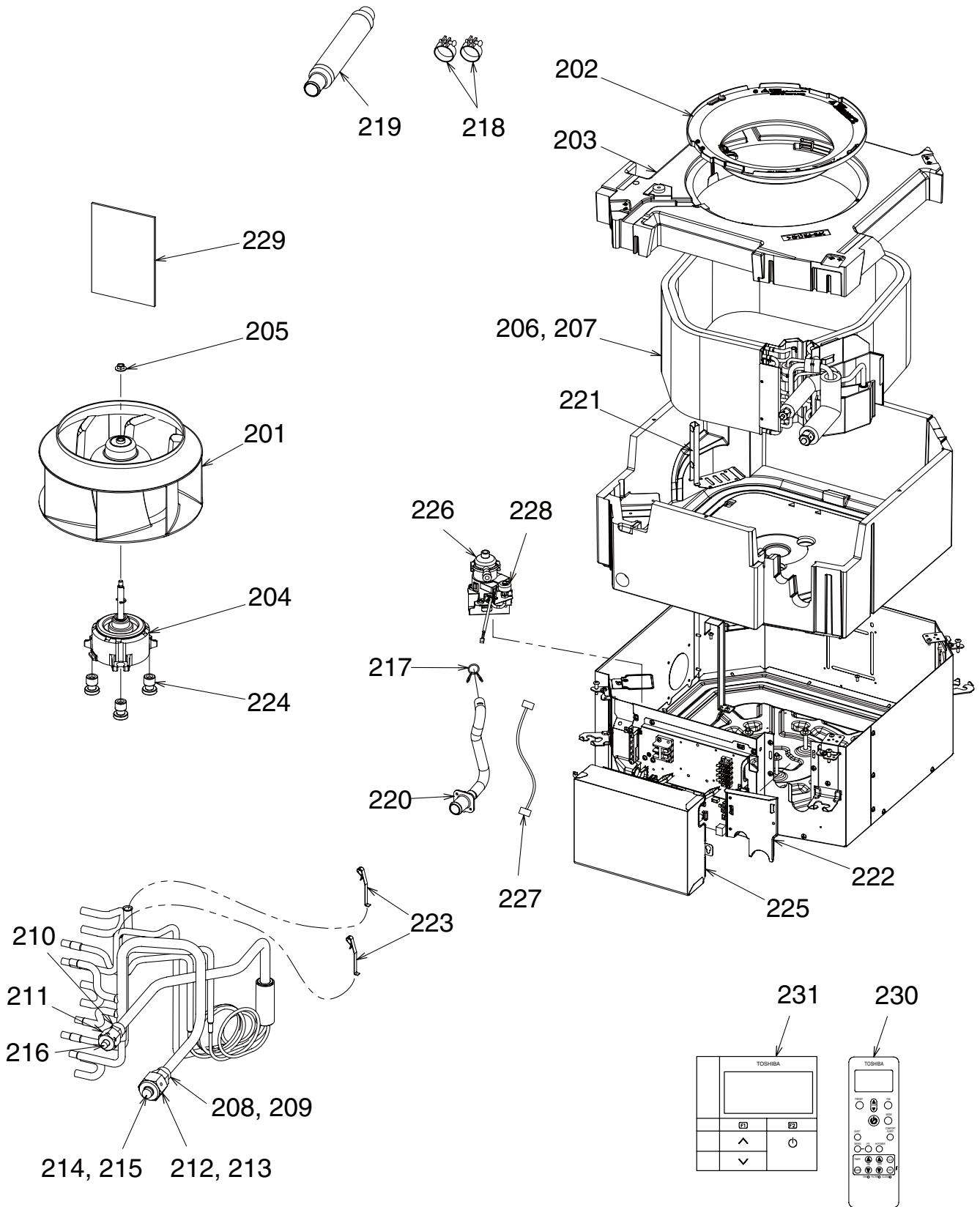

Location No.	Part No.	Description	Q'ty/Set		
			RAS-M 10U2 MUVG-E	RAS-M 13U2 MUVG-E	RAS-M 16U2 MUVG-E
201	43120277	FAN, ASSY TURBO	1	1	1
202	43122165	BELL MOUTH	1	1	1
203	43172259	PAN ASSY, DRAIN	1	1	1
204	4312C161	MOTOR, FAN	1	1	1
205	43F97212	NUT	1	1	1
206	4314J577	REFRIGERATION CYCLE ASSY	1	1	
207	4314J578	REFRIGERATION CYCLE ASSY			1
208	43149498	SOCKET	1	1	
209	43149504	SOCKET			1
210	43149497	SOCKET	1	1	1
211	43149499	NUT,FLARE,1/4,IN	1	1	1
212	43149500	NUT,FLARE,3/8,IN	1	1	
213	43149501	NUT,FLARE,1/2,IN			1
214	43F47609	BONNET	1	1	
215	43147195	BONNET, 1/2 IN			1
216	43F49697	BONNET	1	1	1
217	43079249	BAND, HOSE	1	1	1
218	43179170	BAND, HOSE	2	2	2
219	43170276	HOSE, DRAIN	1	1	1
220	43170277	HOSE, DRAIN	1	1	1
221	43163052	HOLDER, LEAD, FAN MOTOR	1	1	1
222	43119542	COVER, PIPE	1	1	1
223	43F19904	HOLDER, SENSOR (TS)	2	2	2
224	43139187	RUBBER, CUSHION	3	3	3
225	43162087	COVER, E-BOX	1	1	1
226	43177021	PUMP, DRAIN	1	1	1
227	43160663	LEAD, RELAY	1	1	1
228	43151323	SWITCH, FLOAT	1	1	1
229	431S8346	OWNER`S MANUAL, RAS-M10U2UVG-E	1	1	1
230	43166018	REMOTE CONTROLLER, WIRELESS	1	1	1
231	43166038	REMOTE CONTROLLER	1	1	1

12-2. RAS-M10U2MUVG-TR, M13U2MUVG-TR, M16U2MUVG-TR

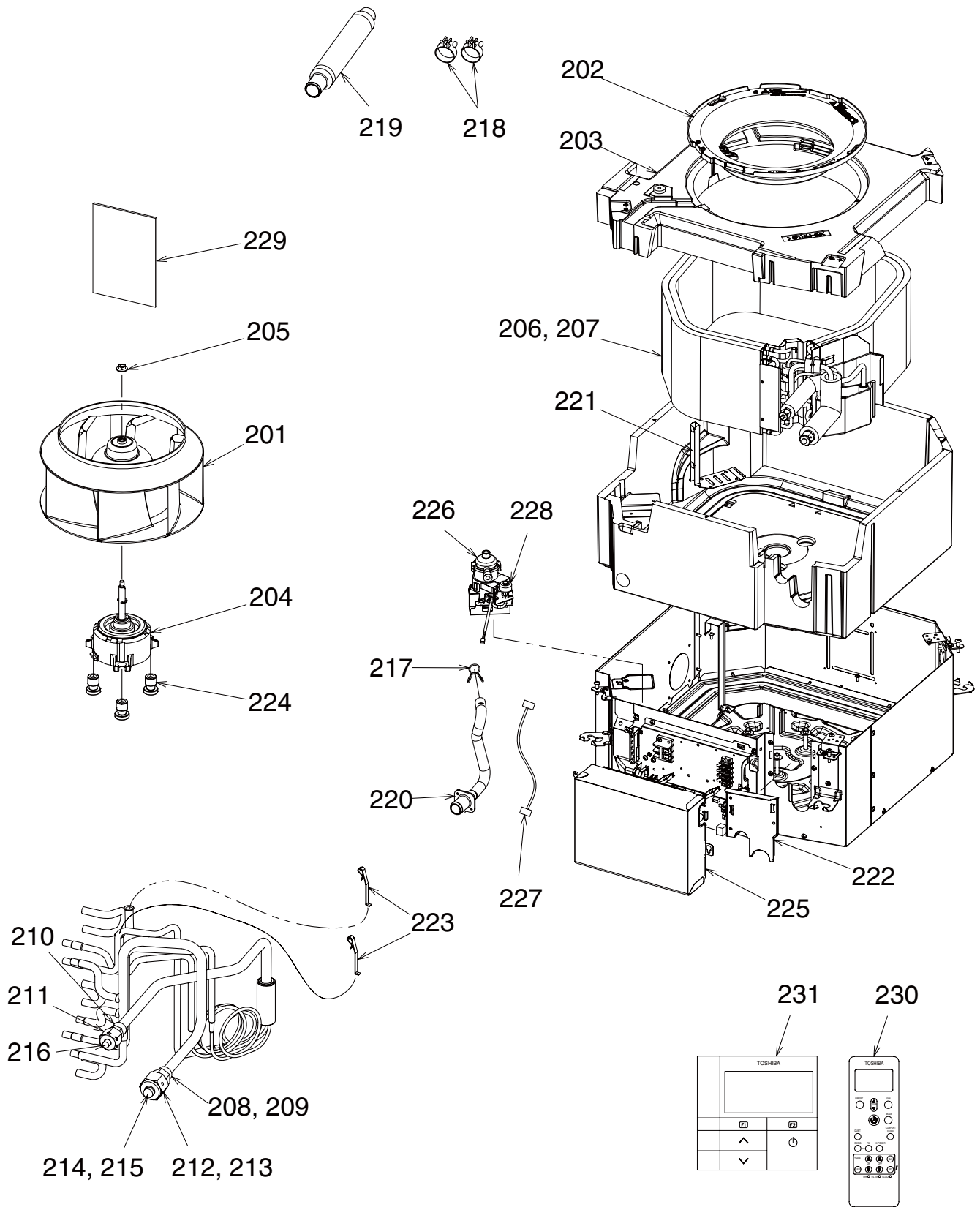

Location No.	Part No.	Description	Q'ty/Set		
			RAS-M 10U2 MUVG-TR	RAS-M 13U2 MUVG-TR	RAS-M 16U2 MUVG-TR
201	43120277	FAN, ASSY TURBO	1	1	1
202	43122165	BELL MOUTH	1	1	1
203	43172259	PAN ASSY, DRAIN	1	1	1
204	4312C161	MOTOR, FAN	1	1	1
205	43F97212	NUT	1	1	1
206	4314J577	REFRIGERATION CYCLE ASSY	1	1	
207	4314J578	REFRIGERATION CYCLE ASSY			1
208	43149498	SOCKET	1	1	
209	43149504	SOCKET			1
210	43149497	SOCKET	1	1	1
211	43149499	NUT,FLARE,1/4,IN	1	1	1
212	43149500	NUT,FLARE,3/8,IN	1	1	
213	43149501	NUT,FLARE,1/2,IN			1
214	43F47609	BONNET	1	1	
215	43147195	BONNET, 1/2 IN			1
216	43F49697	BONNET	1	1	1
217	43079249	BAND, HOSE	1	1	1
218	43179170	BAND, HOSE	2	2	2
219	43170276	HOSE, DRAIN	1	1	1
220	43170277	HOSE, DRAIN	1	1	1
221	43163052	HOLDER, LEAD, FAN MOTOR	1	1	1
222	43119542	COVER, PIPE	1	1	1
223	43F19904	HOLDER, SENSOR (TS)	2	2	2
224	43139187	RUBBER, CUSHION	3	3	3
225	43162087	COVER, E-BOX	1	1	1
226	43177021	PUMP, DRAIN	1	1	1
227	43160663	LEAD, RELAY	1	1	1
228	43151323	SWITCH, FLOAT	1	1	1
229	431S8354	OWNER`S MANUAL, RAS-M10U2UVG-TR	1	1	1
230	43166018	REMOTE CONTROLLER, WIRELESS	1	1	1
231	43166038	REMOTE CONTROLLER	1	1	1

E-Parts

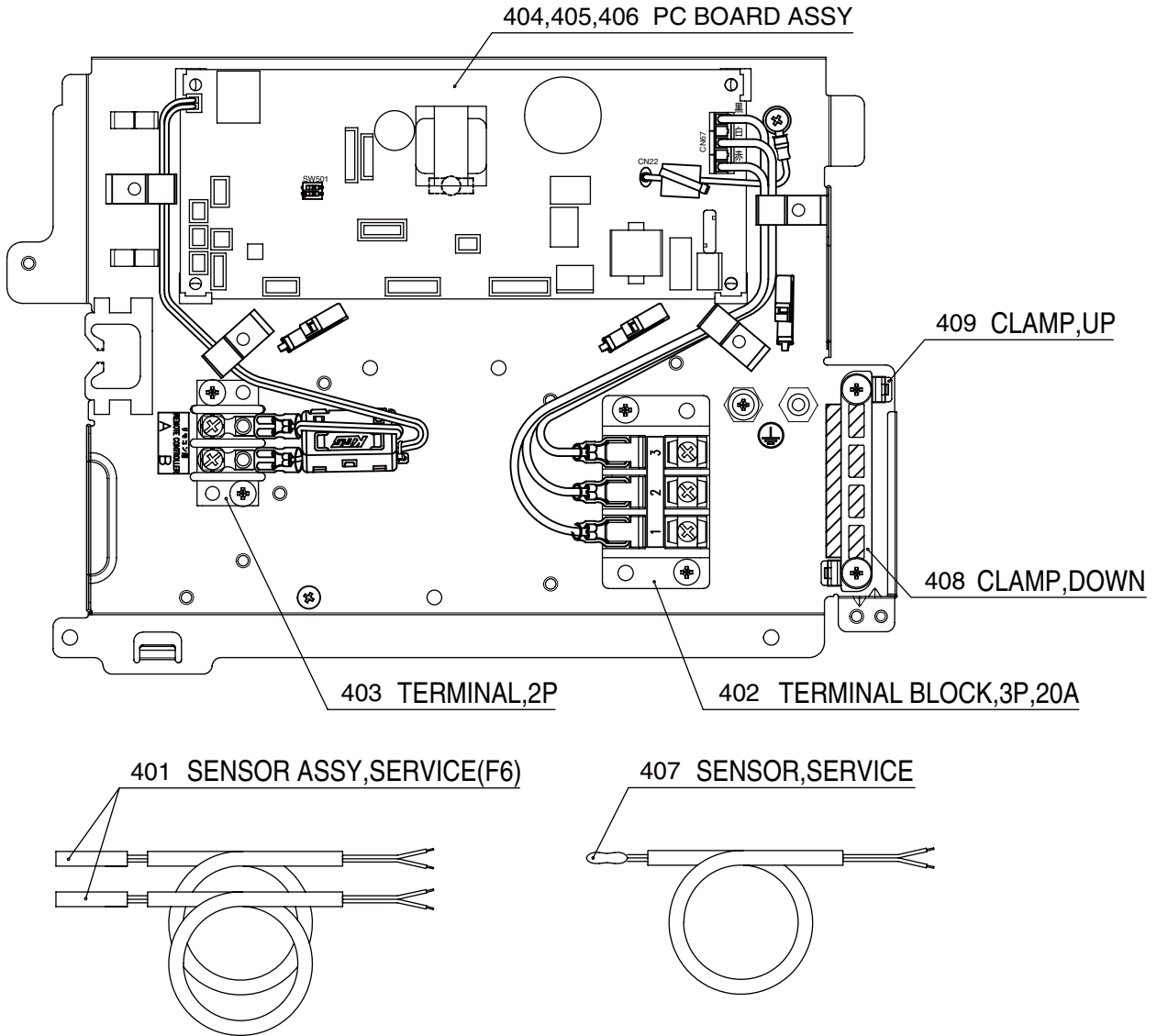

Location No.	Part No.	Description	Q'ty/Set RAS-M		
			10U2MUVG-E	13U2MUVG-E	16U2MUVG-E
			10U2MUVG-TR	13U2MUVG-TR	16U2MUVG-TR
401	43050425	SENSOR ASSY, SERVICE, TC(F6)	2	2	2
402	43160565	TERMINAL BLOCK, 3P, 20A	1	1	1
403	43160568	TERMINAL, 2P	1	1	1
404	4316V660	PC BOARD ASSY	1		
405	4316V663	PC BOARD ASSY		1	
406	4316V664	PC BOARD ASSY			1
407	43F50426	SENSOR, SERVICE, TA	1	1	1
408	43163057	CLAMP, DOWN	1	1	1
409	43163058	CLAMP, UP	1	1	1

◆ Ceiling panel

RBC-UM21PG (W)-E

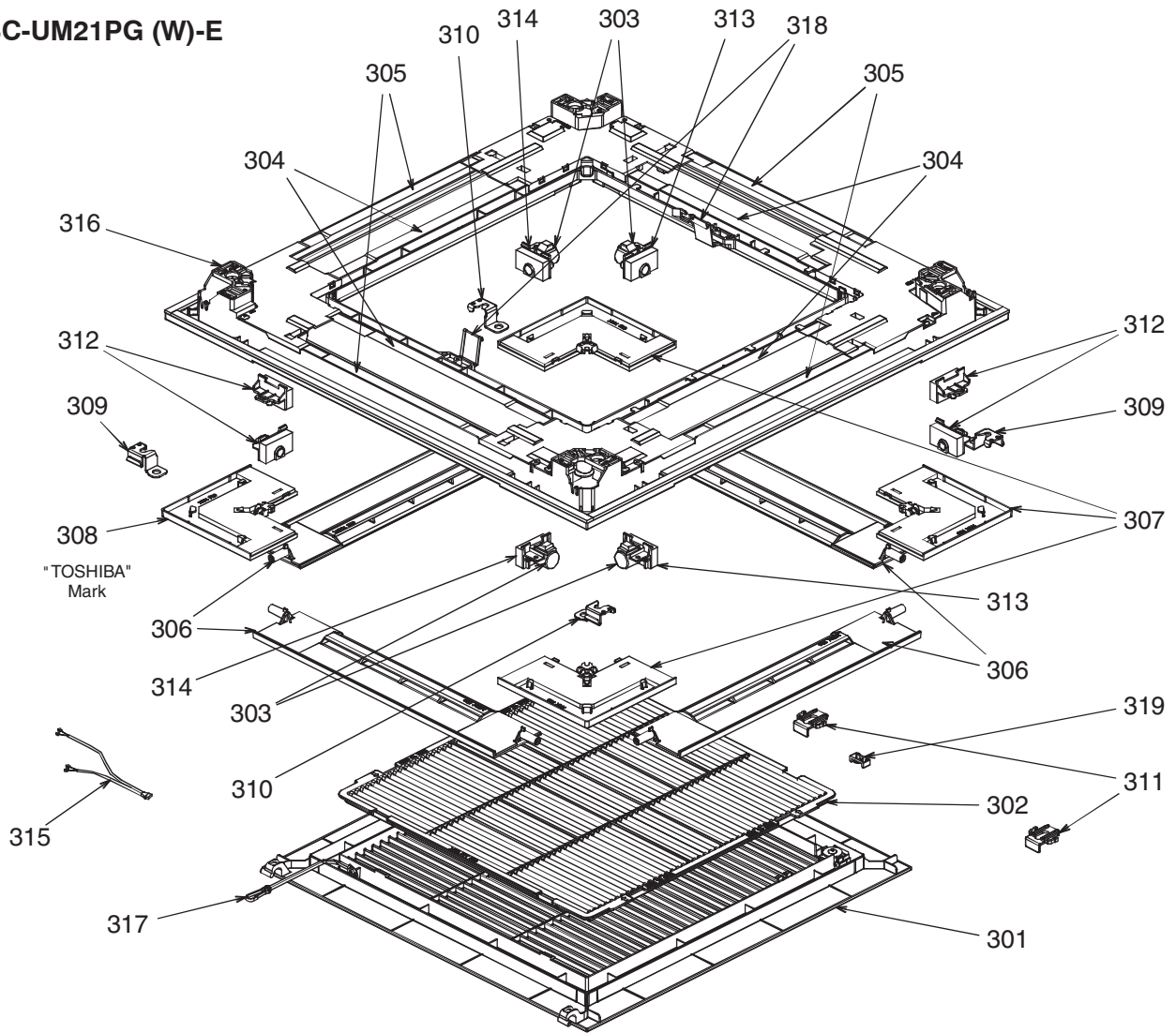

Location No.	Part No.	Description	Q'ty/Set RBC-UM21PG(W)-E
301	43109441	GRILLE, AIR INLET	1
302	43180361	AIR FILTER	1
303	4342D001	MOTOR, LOUVER, MSBPC20F04	4
304	43107296	OUTLET, AIR FORM	4
305	43107297	OUTLET, AIR FORM	4
306	43122166	LOUVER ASSY	4
307	4310A142	COVER, PANEL ASSY	3
308	4310A143	COVER, PANEL ASSY	1
309	43107298	PLATE, FIX PANEL (A)	2
310	43107299	PLATE, FIX PANEL (B)	2
311	43107300	HOOK	2
312	43107301	CAP, AXIS	4
313	43107302	FIX, MOTOR ASSY	2
314	43107303	FIX, MOTOR ASSY	2
315	43160664	LEAD, MOTOR	1
316	4310A144	PANEL, HINS ASSY	1
317	43419022	STRING	1
318	43107304	HANGER	2
319	43107305	FIX, GRILLE	1

◆ Wireless remote controller kit

RBC-AX32UM (W)-E

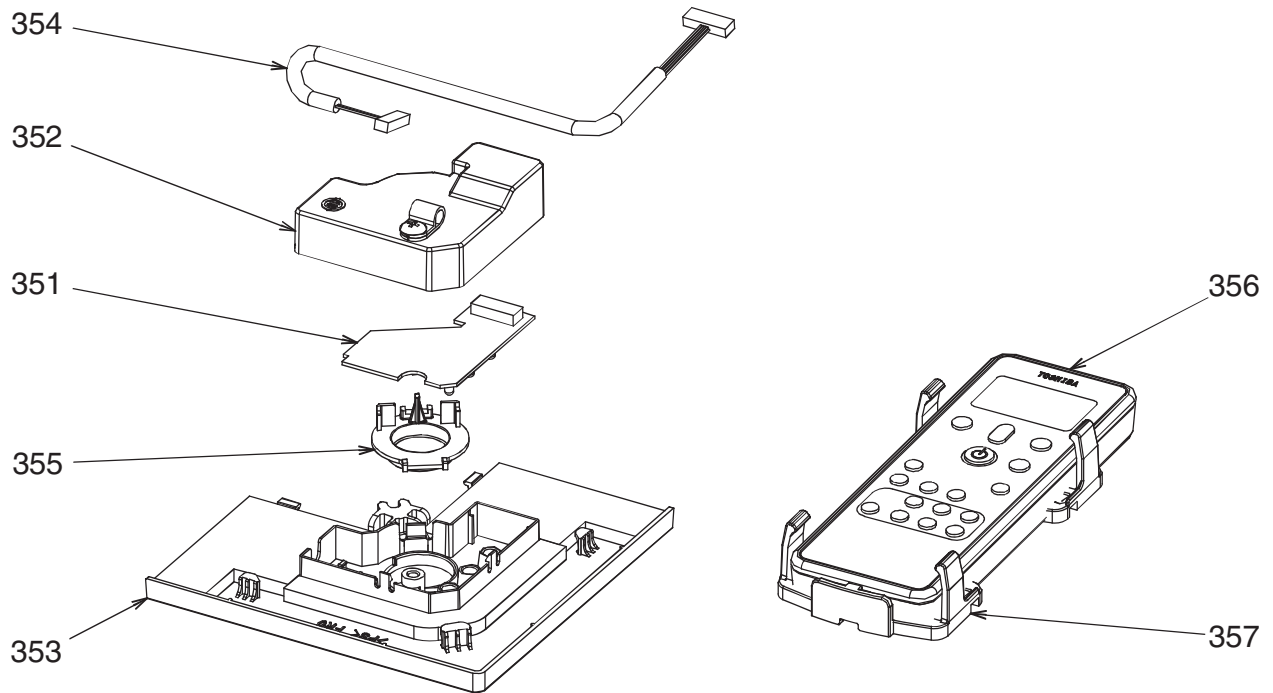

Location No.	Part No.	Description	Q'ty/Set RBC-AX32UM(W)-E
351	4316V616	PC BOARD ASSY, REMOTE RECIEVER	1
352	43162088	COVER, WRS	1
353	43108036	COVER, PANEL WRS	1
354	43160665	LEAD	1
355	43408061	COVER, WIRELESS	1
356	43166018	REMOTE CONTROLLER, WIRELESS, WH-L11SE	1
357	43F83071	HOLDER, REMOTE, CONTROLLER	1

◆ Occupancy sensor

TCB-SIR41UM-E

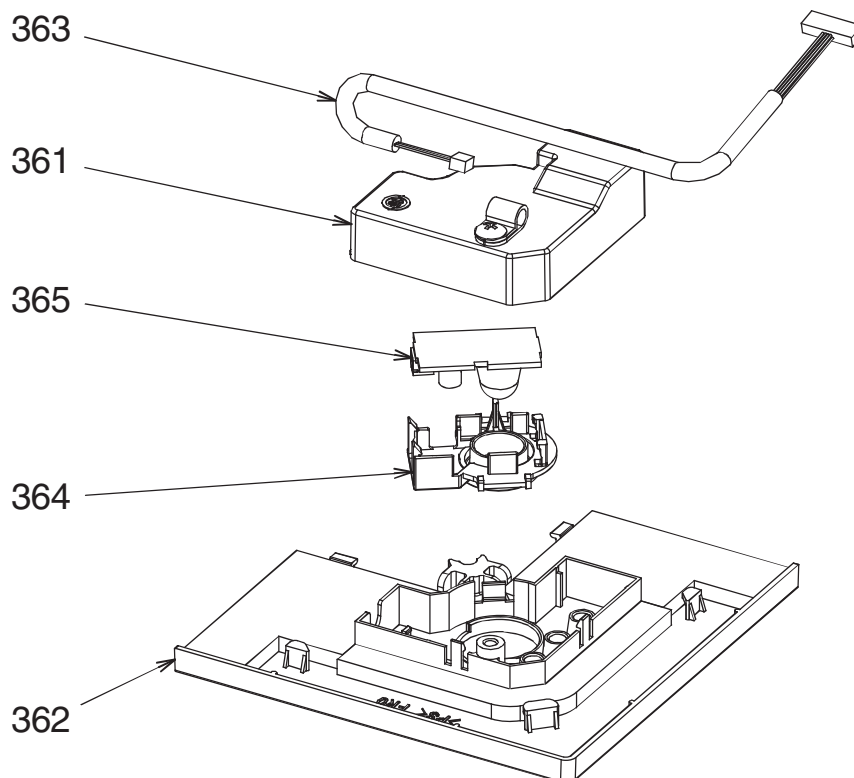

Location No.	Part No.	Description	Q'ty/Set TCB-SIR41UM-E
361	43162088	COVER, WRS	1
362	43108037	COVER, PANEL WRS	1
363	43160666	LEAD	1
364	43408062	COVER, SENSOR	1
365	43469067	THERMOSTAT	1

13. APPENDIX

Wired Remote Controller (RB-RWS21-E) setup

1. Test run setup <Procedure> Perform setting while the air conditioner stops.

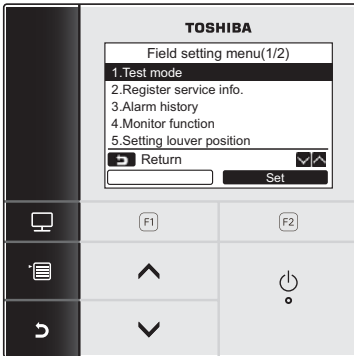

1 Push the [MENU] button to display the menu screen.

2 Push and hold the [MENU] button and the [v] button at the same time to display the “Field setting menu”.

→ Push and hold the buttons for more than 4 seconds.

3 Push the [CANCEL] button to return.

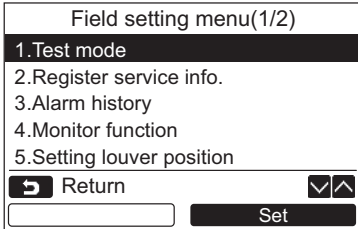

1 Push the [^] / [v] button to select “1. Test mode” on the “Field setting menu” screen, then push the “ Set” [F2] button.

→ Pushing the “ Yes” [F1] button sets the test mode and the screen returns to the “Field setting menu” screen.

Push [CANCEL] twice, the screen (2) appears.

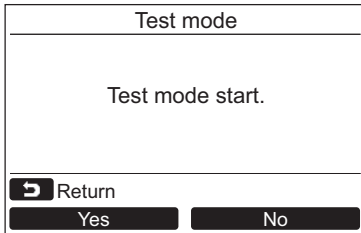

2 Push the [ON / OFF] button to start the test mode. The screen (1) shown in the left appears. (The screen (2) appears when the operation is stopped.)

→ Perform the test mode in the “Cool” or “Heat” mode.

→ Temperature setting cannot be adjusted during the test mode.

→ Check codes are displayed as usual.

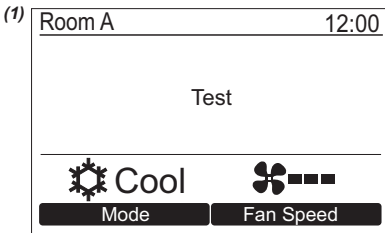

3 When the test mode is finished, push the [^] / [v] button to select “1. Test mode” on the “Field setting menu” screen, then push the “ Set” [F2] button. The screen (3) appears.

→ Pushing the “ Yes” [F1] button stops the test mode screen and continues the normal operation.

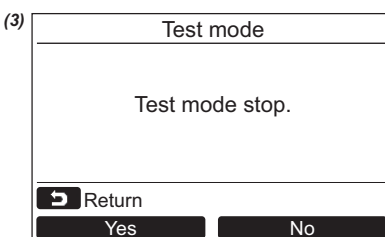
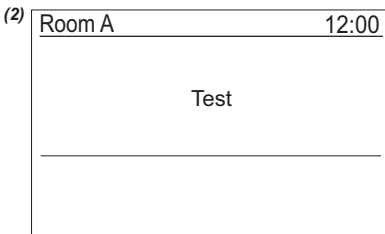

NOTE

The test mode stops after 60 minutes.

Using the Service monitor with the [MONITOR] button during the test mode

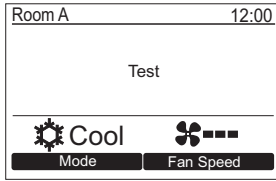

Push the [MONITOR] button

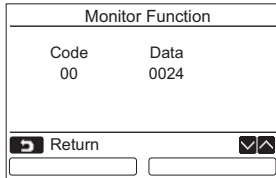

Refer to "3. Monitor function" for details.

2. Function selection setup

Perform the advanced settings for the air conditioner.

Carry out the setting operation while the indoor unit is stopped. (Turn off the air conditioning unit before starting the setting operation.)

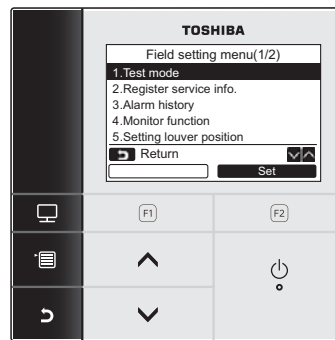
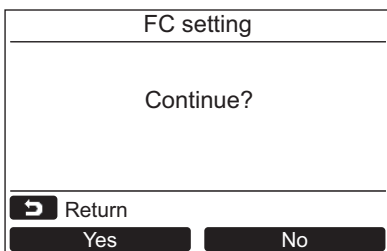
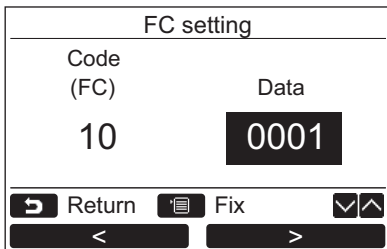
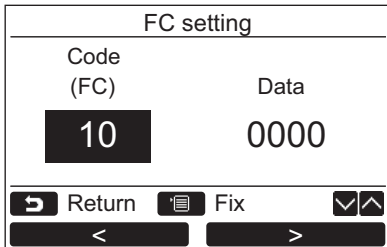
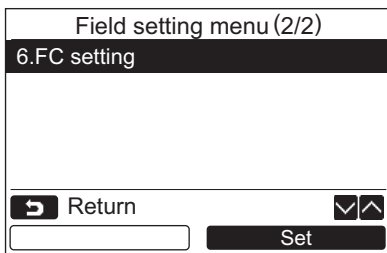

- 1 Push the [^ ^] / [v v] button to select "6. FC setting" on the "Field setting menu" screen, then push the "Set" [F2 F2] button.
 - The fan of the indoor unit operate.
 - Move the cursor to select "Function code" with the " < " [F1 F1] button, then set "Function code" with the [^ ^] / [v v] button.
 - Move the cursor to select "data" with the " > " [F2 F2] button, then set "data" with the [^ ^] / [v v] button.
- 2 Refer to the Installation Manual supplied with the indoor unit or service manual for details about the Function code and data.
- 3 Push the [MENU] button to set the other Function codes. After "Continue?" is displayed on the screen, push the "Yes" [F1 F1] button.
- 4 Push the "No" [F2 F2] button to finish the setting operation. "∞" appears on the screen for a while, then the screen returns to the "Field setting menu" screen.

Function selection item No. (FC) list

FC	Item	Description	At shipment																				
01	Filter sign lighting timer	0000: None 0002: 2500H 0004: 10000H 0001: 150H 0003: 5000H	0002 : 2500H																				
02	Dirty state of filter	0000: Standard 0001: High degree of dirt (Half of standard time)	0000: Standard																				
06	Heating temp shift	0000: 0 °C 0002: +2 °C 0001: +1 °C 0010: +10 °C (Up to +6 recommended)	0002 : +2 °C																				
10	Type	0001 : Compact 4-way Cassette	0001 : Compact 4-way Cassette																				
11	Indoor unit capacity	0000: Unfixed 0001 to 0034	According to capacity type M10:0003 M13:0005 M16:0007																				
1E	Temp difference of [AUTO] mode selection COOL → HEAT, HEAT → COOL	0000: 0 deg to 0010: 10 deg (For setup temperature, reversal of COOL / HEAT by } (Data value) / 2)	0003: 3 deg (Ts ±1.5)																				
28	Automatic restart of power failure	0000: None 0001: Restart	0000: None																				
5d	High-ceiling adjustment (Air flow selection)	<table border="1" style="width: 100%; border-collapse: collapse;"> <thead> <tr> <th>SET DATA</th> <th>Type</th> <th>M10,13</th> <th>M16</th> </tr> </thead> <tbody> <tr> <td>0000</td> <td colspan="3">Depends on DIPSW 501-1,-2</td> </tr> <tr> <td>0001</td> <td>Standard</td> <td>2.7m or less</td> <td>2.7m or less</td> </tr> <tr> <td>0002</td> <td>High-ceiling (1)</td> <td>—</td> <td>3.2m or less</td> </tr> <tr> <td>0004</td> <td>High-ceiling (2)</td> <td>—</td> <td>3.5m or less</td> </tr> </tbody> </table>	SET DATA	Type	M10,13	M16	0000	Depends on DIPSW 501-1,-2			0001	Standard	2.7m or less	2.7m or less	0002	High-ceiling (1)	—	3.2m or less	0004	High-ceiling (2)	—	3.5m or less	0000: Depends on DIPSW 501-1,-2
SET DATA	Type	M10,13	M16																				
0000	Depends on DIPSW 501-1,-2																						
0001	Standard	2.7m or less	2.7m or less																				
0002	High-ceiling (1)	—	3.2m or less																				
0004	High-ceiling (2)	—	3.5m or less																				
b5	Occupancy sensor/ Wireless remote controller	0000: None 0002: Wireless remote controller provided 0001: Occupancy sensor provided	0000: None																				
b6	Occupancy sensor Enable/Invalid (Absence time judgment time)	0000: Invalid 0002: 60min. 0005: 150min. 0001: 30min. 0004: 120min.	0002: Enable (60 min.)																				
b7	Occupancy sensor operation at absent	0000: Stand by 0001: operation stop	0000: Stand by																				
E6	Wireless remote controller A-B selection	0000: A 0001: B	0000: A																				
F0	Swing mode	0001 : Standard 0003 : Cycle swing 0002 : Dual swing	0001: Standard																				
F1	Louver fixed position (Louver No.1)	0000 : Release 0005 : Downward discharge position 0001 : Horizontal discharge position	0000: Not fixed																				
F2	Louver fixed position (Louver No.2)	0000 : Release 0005 : Downward discharge position 0001 : Horizontal discharge position	0000: Not fixed																				
F3	Louver fixed position (Louver No.3)	0000 : Release 0005 : Downward discharge position 0001 : Horizontal discharge position	0000: Not fixed																				
F4	Louver fixed position (Louver No.4)	0000 : Release 0005 : Downward discharge position 0001 : Horizontal discharge position	0000: Not fixed																				

3. Monitor function

The sensor temperature or operational status of indoor unit, outdoor unit, or remote controller can be monitored.

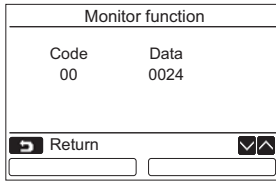

1 Push the [] / [] button to select “4. Monitor function” on the “Field setting menu” screen, then push the “ Set” [F2] button.

→ Push the [] / [] button to select the code to check data.

2 Push the [CANCEL] button to return to the “Field setting menu” screen.

	Item code	Data name	Unit
Indoor unit data	01	Room temperature (Remote controller)	°C
	02	Indoor suction temperature (TA)	°C
	03	Indoor heat exchanger (Coil) temperature (TCJ)	°C
	04	Indoor heat exchanger (Coil) temperature (TC)	°C
	07	Indoor fan revolution frequency	rpm
	F2	Indoor fan calculated operation time	×100h
	F3	Filter sign time	×1h

	Item code	Data name	Unit
Outdoor unit data	60	Outdoor heat exchanger (Coil) temperature (TE)	°C
	61	Outside temperature (TO)	°C
	62	Compressor discharge temperature (TD)	°C
	63	Compressor suction temperature (TS)	°C
	6A	Operation current (× 1/10)	A
	70	Compressor operation frequency	rps
	72	Outdoor fan revolution frequency	rpm
	F1	Compressor calculated operation time	×100h

4. Alarm history

List of latest 10 alarm data: trouble information of check code, date, time, and unit, is displayed.

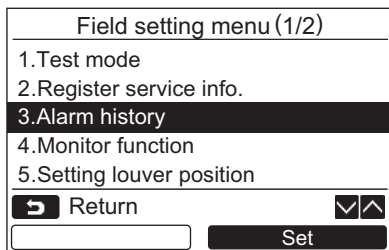

1 Push the [] / [] button to select “3. Alarm history” on the “Field setting menu” screen, then push the “ Set” [F2] button.

List of latest 10 Alarm data is displayed.

* The oldest data are deleted in order to record the new ones.

→ The date and time when the trouble occurred for the first time is displayed for the repeated alarm.

Alarm history				
	Unit	Code	Date	Time
1.	1-1	0B	01/01/2018	12:25
2.	-	-	-	-
3.	-	-	-	-
4.	-	-	-	-

Deleting the alarm history

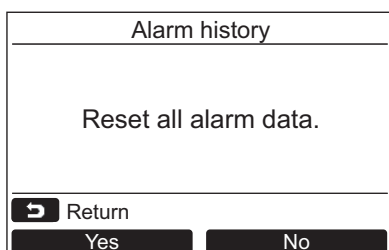

1 Push the “ Reset” [F2] button while the list of alarm history is displayed.

2 Push the “ Yes” [F1] button after the confirmation screen is displayed.

→ Delete the alarm history in each remote controller when the dual remote controller system is used.

TOSHIBA CARRIER CORPORATION

72-34 Horikawa-cho, Saiwai-ku, Kawasaki-shi, Kanagawa 212-8585, JAPAN

Copyright © 2018 TOSHIBA CARRIER CORPORATION, ALL Rights Reserved.