

**R32**

***INVERTER***

# TOSHIBA

## INSTALLATION MANUAL

### AIR CONDITIONER (MULTIPLE TYPE)

Indoor unit

**RAS-M10PKVPG-E**

**RAS-M13PKVPG-E**

**RAS-M16PKVPG-E**

ENGLISH

ESPAÑOL

FRANÇAIS

ITALIANO

DEUTSCH

PORTUGUÊS

POLSKI

ČESKY

HRVATSKI

MAGYAR

NEDERLANDS

ΕΛΛΗΝΙΚΑ

SVENSKA

SUOMI

NORSK

DANSK

ROMÂNĂ

БЪЛГАРСКИ

EESTI

LATVISKI

SLOVENČINA

SLOVENŠČINA

LIETUVIŲ

РУССКИЙ



1121451199

<b>PRECAUTIONS FOR SAFETY</b> .....	1
<b>ACCESSORY PARTS</b> .....	5
<b>INSTALLATION DIAGRAM OF INDOOR UNIT</b> .....	6
■ Optional Installation Parts .....	6
<b>INDOOR UNIT</b> .....	7
■ Installation Place .....	7
■ Cutting a Hole and Mounting Installation Plate .....	7
■ Piping and Drain Hose Installation .....	8
■ Indoor Unit Fixing .....	9
■ In case of Indoor unit is fixed to Installation plate with screws.....	9
■ Drainage .....	9
<b>ELECTRICAL WORKS</b> .....	10
■ Wiring Connection.....	10
■ Connecting Cable Connection .....	11
<b>OTHERS</b> .....	12
■ Gas Leak Test .....	12
■ Remote Control A-B Selection .....	12
■ Test Operation .....	12
■ Auto Restart Setting .....	12

## PRECAUTIONS FOR SAFETY



Read the precautions in this manual carefully before operating the unit.



This appliance is filled with R32.

EN

- Before installation, please read these precautions for safety carefully.
- Be sure to follow the precautions provided here to avoid safety risks. The symbols and their meanings are shown below.

**WARNING** : It indicates that incorrect use of this unit may cause severe injury or death.

**CAUTION** : It indicates that incorrect use of this unit may cause personal injury (\*1), or property damage (\*2).

\*1: Personal injury means a slight accident, burn, or electrical shock which does not require admission or repeated hospital treatment.

\*2: Property damage means greater damage which affects assets or resources.

### For general public use

Power supply cord and connecting cable of appliance use shall be at least polychloroprene sheathed flexible cord (design H07RN-F) or cord designation 60245 IEC66. (Shall be installed in accordance with national wiring regulations.)

### **CAUTION** To disconnect the appliance from the main power supply

This appliance must be connected to the main power supply by means of a circuit breaker or a switch with a contact separation of at least 3 mm in all poles.

## **DANGER**

- FOR USE BY QUALIFIED PERSONS ONLY.
- TURN OFF MAIN POWER SUPPLY BEFORE ATTEMPTING ANY ELECTRICAL WORK. MAKE SURE ALL POWER SWITCHES ARE OFF.  
FAILURE TO DO SO MAY CAUSE ELECTRIC SHOCK.
- CONNECT THE CONNECTING CABLE CORRECTLY. IF THE CONNECTING CABLE IS CONNECTED WRONGLY, ELECTRIC PARTS MAY BE DAMAGED.
- CHECK THE EARTH WIRE THAT IT IS NOT BROKEN OR DISCONNECTED BEFORE INSTALLATION.
- DO NOT INSTALL NEAR CONCENTRATIONS OF COMBUSTIBLE GAS OR GAS VAPORS.  
FAILURE TO FOLLOW THIS INSTRUCTION CAN RESULT IN FIRE OR EXPLOSION.
- TO PREVENT OVERHEATING THE INDOOR UNIT AND CAUSING A FIRE HAZARD, PLACE THE UNIT WELL AWAY (MORE THAN 2 M) FROM HEAT SOURCES SUCH AS RADIATORS, HEATERS, FURNACE, STOVES, ETC.
- WHEN MOVING THE AIR CONDITIONER FOR INSTALLING IT IN ANOTHER PLACE AGAIN, BE VERY CAREFUL NOT TO GET THE SPECIFIED REFRIGERANT (R32) WITH ANY OTHER GASEOUS BODY INTO THE REFRIGERATION CYCLE. IF AIR OR ANY OTHER GAS IS MIXED IN THE REFRIGERANT, THE GAS PRESSURE IN THE REFRIGERATION CYCLE BECOMES ABNORMALLY HIGH AND IT RESULTINGLY CAUSES BURST OF THE PIPE AND INJURIES ON PERSONS.
- IN THE EVENT THAT THE REFRIGERANT GAS LEAKS OUT OF THE PIPE DURING THE INSTALLATION WORK, IMMEDIATELY LET FRESH AIR INTO THE ROOM. IF THE REFRIGERANT GAS IS HEATED BY FIRE OR SOMETHING ELSE, IT CAUSES GENERATION OF POISONOUS GAS.

## **WARNING**

- Never modify this unit by removing any of the safety guards or bypassing any of the safety interlock switches.
- Do not install in a place which cannot bear the weight of the unit.  
Personal injury and property damage can result if the unit falls.
- Before doing the electrical work, attach an approved plug to the power supply cord.  
Also, make sure the equipment is properly earthed.
- Appliance shall be installed in accordance with national wiring regulations.  
If you detect any damage, do not install the unit. Contact your dealer immediately.

- Do not use any refrigerant different from the one specified for complement or replacement.  
Otherwise, abnormally high pressure may be generated in the refrigeration cycle, which may result in a failure or explosion of the product or an injury to your body.
- Do not use means to accelerate the defrosting process or to clean, other than those recommended by the manufacturer.
- The appliance shall be stored in a room without continuously operating ignition sources (for example: open flames, an operating gas appliance or an operating electric heater).
- Be aware that refrigerants may not contain an odour.
- Do not pierce or burn as the appliance is pressurized. Do not expose the appliance to heat, flame, sparks, or other sources or ignition. Else, it may explode and cause injury or death.
- For R32 model, use pipes, flare nut and tools which is specified for R32 refrigerant. Using of existing (R22) piping, flare nut and tools may cause abnormally high pressure in the refrigerant cycle (piping), and possibly result in explosion and injury.
- Thickness of copper pipes used R32 must be more than 0.8mm. Never use copper pipes thinner than 0.8mm.
- Do not perform flare connection inside a building or dwelling or room, when joining the heat exchanger of indoor unit with interconnection piping. Refrigerant connection inside a building or dwelling or room must be made by brazing or welding. Joint connection of indoor unit by flaring method can only be made at outdoor or at outside of building or dwelling or room. Flare connection may cause gas leak and flammable atmosphere.
- After completion of installation or service, confirm there is no leakage of refrigerant gas. It may generate toxic gas when the refrigerant contacts with fire.
- Appliance and pipe-work shall be installed, operated and stored in a room with a floor area larger than  $A_{\min}$  m<sup>2</sup>.  
How to get  $A_{\min}$  m<sup>2</sup> :  $A_{\min} = (M / (2.5 \times 0.22759 \times h_0))^2$   
M is the refrigerant charge amount in appliance in kg.  $h_0$  is the installation height of the appliance in m: 0.6 m for floor standing/1.8 m for wall mounted/1.0 m for window mounted/2.2 m for ceiling mounted (For these units recommend installation height 2.5 m.).
- Comply with national gas regulations.

## CAUTION

- Exposure of unit to water or other moisture before installation could result in electric shock.  
Do not store it in a wet basement or expose to rain or water.
- After unpacking the unit, examine it carefully for possible damage.
- Do not install the unit at place where leakage of flammable gas may occur. In case gas leaks and accumulates at surrounding of the unit, it may cause of fire.
- Do not install in a place that can increase the vibration of the unit. Do not install in a place that can amplify the noise level of the unit or where noise and discharged air might disturb neighbors.
- To avoid personal injury, be careful when handling parts with sharp edges.
- Please read this installation manual carefully before installing the unit. It contains further important instructions for proper installation.
- The manufacturer shall not assume any liability for the damage caused by not observing the description of this manual.

### REQUIREMENT OF REPORT TO THE LOCAL POWER SUPPLIER

Please make absolutely sure that the installation of this appliance is reported to the local power supplier before installation. If you experience any problems or if the installation is not accepted by the supplier, the service agency will take adequate countermeasures.

### ■ **Important information regarding the refrigerant used**

This product contains fluorinated greenhouse gases.

Do not vent gases into the atmosphere.

Refrigerant type: **R32**

GWP<sup>(1)</sup> value: **675** \* (ex. R32 ref. AR4)









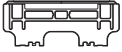

<sup>(1)</sup>GWP = global warming potential

The refrigerant quantity is indicated on the unit name plate.

\* This value is based on F gas regulation 517/2014

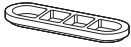
# ACCESSORY PARTS

EN

ACCESSORY AND INSTALLATION PARTS			
No.	Part name	No.	Part name
①	 Installation Plate* × 1	②	 Wireless remote control* × 1
③	 Battery × 2	④	 Remote control holder* × 1
⑤	 Mounting screw** Ø4 × 25 l × 6	⑥	 Flat head wood screw Ø3.1 × 16 l × 2
⑦	 Drain nipple*** × 1 (for heating model only)	⑧	 Cap water proof**,*** × 2 (for some models only)
⑨	 Owner's Manual	⑩	 Installation Manual
⑪	 B Label × 2 (for Multi model)		

\* The part may differ from that shown.

\*\* The number of parts may differ by model.

\*\*\* The part is packed with the outdoor unit.

## Filter Clean / Replacement

### Air filters

Clean every 2 weeks.

1. Open the air inlet grille.
2. Remove the air filters.
3. Vacuum or wash and then dry them.
4. Reinstall the air filters and close the air inlet grille.

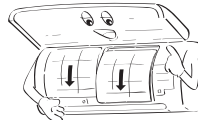

# INSTALLATION DIAGRAM OF INDOOR UNIT

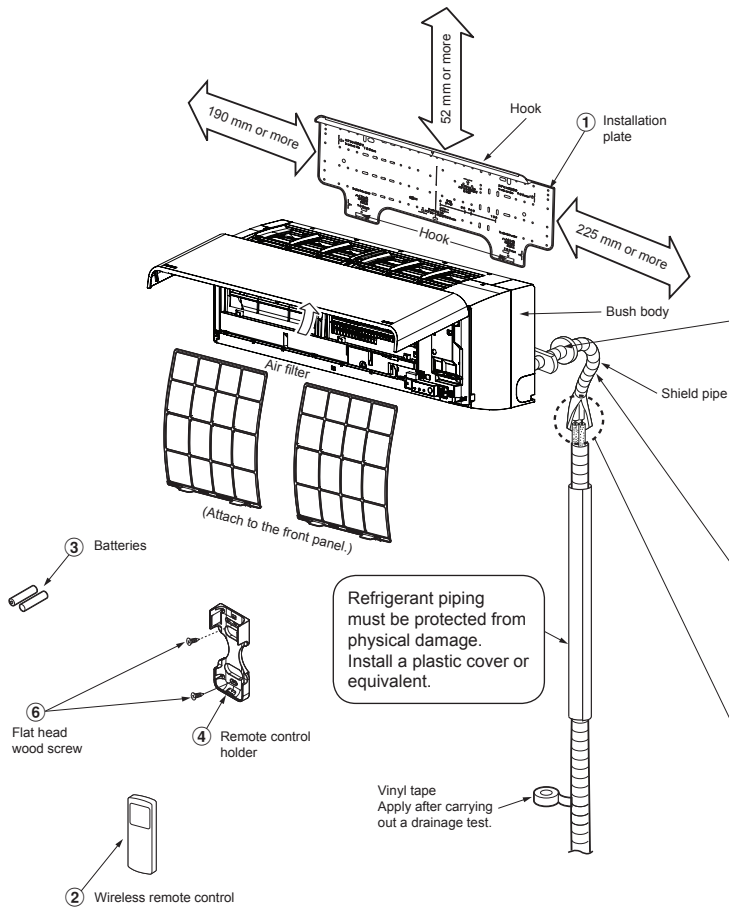

For the rear left and left piping

Wall

Insert the cushion between the indoor unit and wall, and tilt the indoor unit for better operation.

The auxiliary piping can be connected to the left, rear left, rear right, right, bottom right or bottom left.

Do not allow the drain hose to get slack.

Cut the piping hole sloped slightly.

Make sure to run the drain hose sloped downward.

The flare connection should be installed outdoors.

Insulate the refrigerant pipes separately with insulation, not together.

6 mm thick heat resisting polyethylene foam

## Optional Installation Parts

Part code	Parts name	Q'ty
Ⓐ	Refrigerant piping Liquid side : Ø6.35 mm Gas side : Ø9.52 mm (RAS-M10, 13PKVPG-E) : Ø12.7 mm (RAS-M16PKVPG-E)	One each
Ⓑ	Pipe insulating material (polyethylene foam, 6 mm thick)	1
Ⓒ	Putty, PVC tapes	One each



# INDOOR UNIT

## Installation Place

- A place which provides the spaces around the indoor unit as shown in the diagram
- A place where there are no obstacles near the air inlet and outlet
- A place which allows easy installation of the piping to the outdoor unit
- A place which allows the front panel to be opened
- The indoor unit shall be installed at least 2.5 m height. Also, it must be avoided to put anything on the top of the indoor unit.

### CAUTION

- Direct sunlight to the indoor unit's wireless receiver should be avoided.
- The microprocessor in the indoor unit should not be too close to RF noise sources.  
(For details, see the owner's manual.)

## Remote control

- A place where there are no obstacles such as a curtain that may block the signal from the indoor unit
- Do not install the remote control in a place exposed to direct sunlight or close to a heating source such as a stove.
- Keep the remote control at least 1 m apart from the nearest TV set or stereo equipment. (This is necessary to prevent image disturbances or noise interference.)
- The location of the remote control should be determined as shown below.

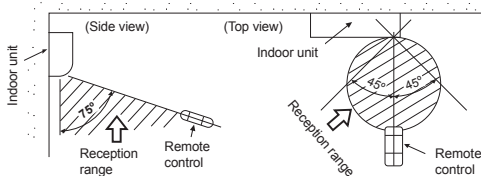

## Cutting a Hole and Mounting Installation Plate

### Cutting a hole

When installing the refrigerant pipes from the rear

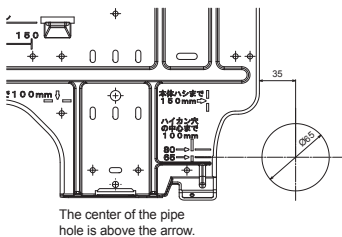

1. After determining the pipe hole position on the mounting plate (➡), drill the pipe hole (Ø65 mm) at a slight downward slant to the outdoor side.

### NOTE

- When drilling a wall that contains a metal lath, wire lath or metal plate, be sure to use a pipe hole brim ring sold separately.

## Mounting the installation plate

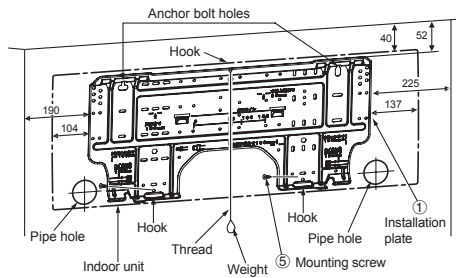

## When the installation plate is directly mounted on the wall

1. Securely fit the installation plate onto the wall by screwing it in the upper and lower parts to hook up the indoor unit.
2. To mount the installation plate on a concrete wall with anchor bolts, use the anchor bolt holes as illustrated in the below figure.
3. Install the installation plate horizontally in the wall.

### CAUTION

When installing the installation plate with a mounting screw, do not use the anchor bolt holes. Otherwise, the unit may fall down and result in personal injury and property damage.

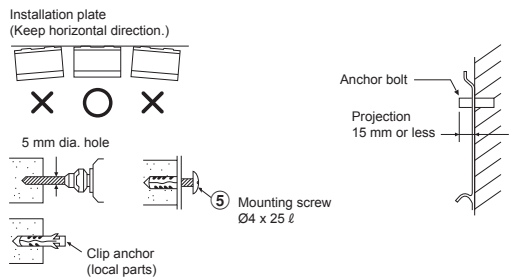

### CAUTION

Failure to firmly install the unit may result in personal injury and property damage if the unit falls.

- In case of block, brick, concrete or similar type walls, make 5 mm dia. holes in the wall.
- Insert clip anchors for appropriate mounting screws ⑤.

### NOTE

- Secure four corners and lower parts of the installation plate with 4 to 6 mounting screws to install it.

# Piping and Drain Hose Installation

## Piping and drain hose forming

\* Since dewing results in a machine trouble, make sure to insulate both connecting pipes. (Use polyethylene foam as insulating material.)

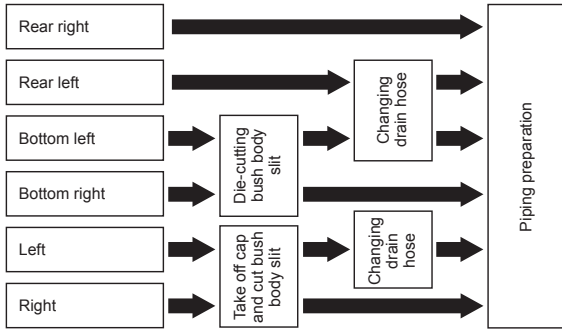

### 1. Die-cutting bush body slit

#### • For Bottom left or Bottom right

Cut out the slit on bottom left or right side of bush body for the bottom left or right connection with a pair of nippers.

#### • For Left or Right

Take off Cap and cut out the slit on left or right side of bush body for the left or right connection with a pair of nippers.

### 2. Changing drain hose

For leftward connection, bottom-leftward connection and rearleftward connection's piping, it is necessary to change the drain hose and drain cap.

### How to remove the drain hose

- The drain hose can be removed by removing the screw securing the drain hose and then pulling out the drain hose.
- When removing the drain hose, be careful of any sharp edges of steel plate. The edges can injuries.
- To install the drain hose, insert the drain hose firmly until the connection part contacts with heat insulator, and then secure it with original screw.

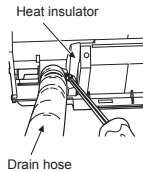

### How to remove the drain cap

Clip the drain cap by needle-nose pliers and pull out.

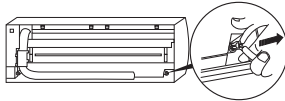

### How to fix the drain cap

- 1) Insert hexagon wrench (4 mm) in a center head.
- 2) Firmly insert the drain cap.

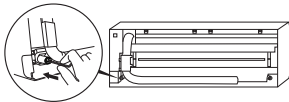

Do not apply lubricating oil (refrigerant machine oil) when inserting the drain cap. Application causes deterioration and drain leakage of the plug.

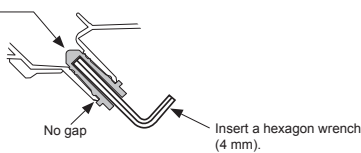

## CAUTION

Firmly insert the drain hose and drain cap; otherwise, water may leak.

## In case of right or left piping

- Take off the cap by hand and cut of the slit.
- After scribing slits of the bush body with a knife or a making-off pin, cut them with a pair of nippers or an equivalent tool.

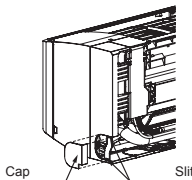

## In case of bottom right or bottom left piping

- After scribing slits of the bush body with a knife or a making-off pin, cut them with a pair of nippers or an equivalent tool.

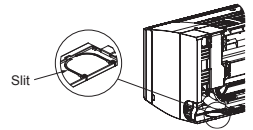

## Left-hand connection with piping

- Bend the connecting pipe so that it is laid within 43 mm above the wall surface. If the connecting pipe is laid exceeding 43 mm above the wall surface, the indoor unit may unstably be set on the wall. When bending the connecting pipe, make sure to use a spring bender so as not to crush the pipe.

### Bend the connecting pipe within a radius of 30 mm.

To connect the pipe after installation of the unit (figure)

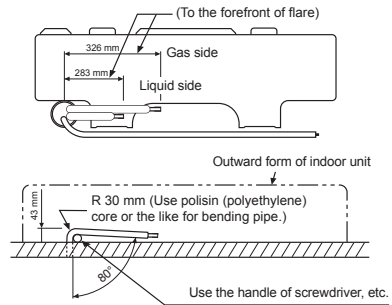

## WARNING

- Do not perform flare connection inside a building or dwelling or room, when joining the heat exchanger of indoor unit with interconnection piping. Refrigerant connection inside a building or dwelling or room must be made by brazing or welding. Joint connection of indoor unit by flaring method can only be made at outdoor or at outside of building or dwelling or room. Flare connection may cause gas leak and flammable atmosphere.

## NOTE

If the pipe is bent incorrectly, the indoor unit may unstably be set on the wall. After passing the connecting pipe through the pipe hole, connect the connecting pipes to the auxiliary pipes and wrap the facing tape around them.

## CAUTION

- Bind the auxiliary pipes (two) and connecting cable with facing tape tightly. In case of leftward piping and rear-leftward piping, bind the auxiliary pipes (two) only with facing tape.

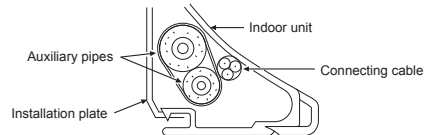

- Carefully arrange pipes so that any pipe does not stick out of the rear plate of the indoor unit.
- Carefully connect the auxiliary pipes and connecting pipes to one another and cut off the insulating tape wound on the connecting pipe to avoid double-taping at the joint; moreover, seal the joint with the vinyl tape, etc.
- Since dewing results in a machine trouble, make sure to insulate both connecting pipes. (Use polyethylene foam as insulating material.)
- When bending a pipe, carefully do it, not to crush it.

## Indoor Unit Fixing

1. Pass the pipe through the hole in the wall and hook the indoor unit on the installation plate at the upper hook.
2. Swing the indoor unit to right and left to confirm that it is firmly hooked up on the installation plate.
3. While pressing the indoor unit onto the wall, hook it at the lower part on the installation plate. Pull the indoor unit toward you to confirm that it is firmly hooked up on the installation plate.

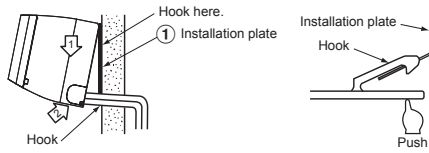

- For detaching the indoor unit from the installation plate, pull the indoor unit toward you while pushing its bottom up at the specified parts.

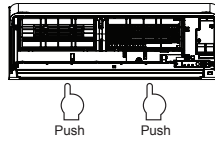

## In case of Indoor unit is fixed to Installation plate with screws

1. Remove 2 screw caps with flat screwdriver.
2. Fix them with  $\varnothing 4 \times 10 \sim 14L$ , 2 screws which are prepared at the site.
3. Cover screw caps as previous process.

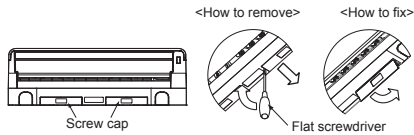

## Drainage

1. Run the drain hose sloped downwards.

### NOTE

- The hole should be made at a slight downward slant on the outdoor side.

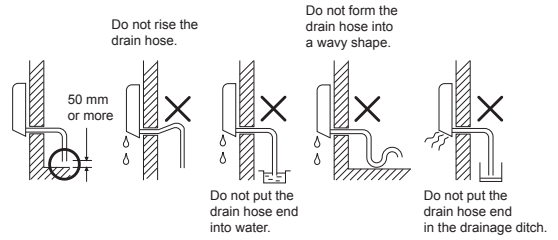

2. Put water in the drain pan and make sure that the water is drained out of doors.
3. When connecting extension drain hose, insulate the connecting part of extension drain hose with shield pipe.

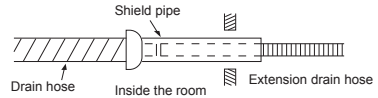

### CAUTION

Arrange the drain pipe for proper drainage from the unit. Improper drainage can result in dew-dropping.

This air conditioner has the structure designed to drain water collected from dew, which forms on the back of the indoor unit, to the drain pan. Therefore, do not store the power cord and other parts at a height above the drain guide.

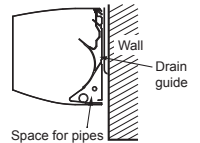

# ELECTRICAL WORKS

Model	RAS-M10PKVPG-E	RAS-M13PKVPG-E	RAS-M16PKVPG-E
Power source	50Hz, 220 – 240 V Single phase		
Maximum running current	*1	*1	*1
Circuit breaker rating	*1	*1	*1
Power supply cable	-		
Connecting cable	*1		

\*1: Refer to the installation manual of the outdoor unit to be combined.

## Wiring Connection

### Indoor unit

Wiring of the cable can be carried out without removing the main panel.

1. Remove the front panel.  
Pull and lift up front panel until it stops, move arms on left and right side to outward direction then pull toward you to remove front panel.  
\* Beware front panel fall down that may cause of injure or part damage.

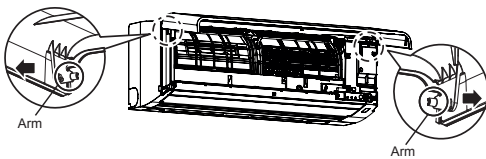

2. Remove the terminal cover and cord clamp.
3. Insert the cable (according to the local cords) into the pipe hole on the wall.
4. Take out the cable protrudes about 20 cm from the front.
5. Insert the cable fully into the terminal block and secure it tightly with screws.
6. Tightening torque : 1.2 N·m (0.12 kgf·m)
7. Secure the cable with the cord clamp.
8. Fix the terminal cover and attach front panel to the indoor unit.

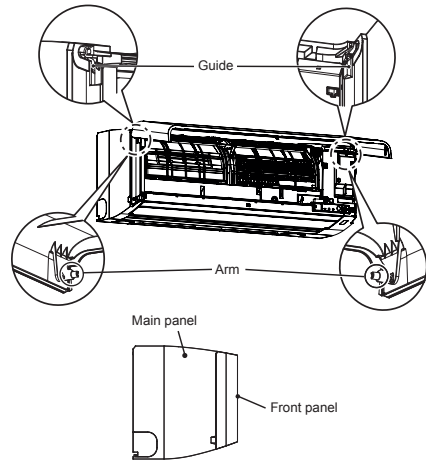
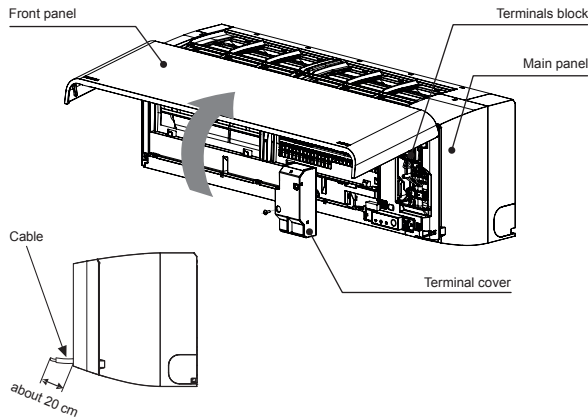

### CAUTION

- Be sure to refer to the wiring system diagram labeled inside the main panel.
- Check local electrical cords and also any specific wiring instructions or limitations.

### How to attach the front panel

Carry out attaching in the reverse order to removal.

- Keep front panel horizontally and put both arms into guides.  
Make sure both arms are inserted completely.  
If the gap between main panel and front panel isn't even, remove and attach again.

## Connecting Cable Connection

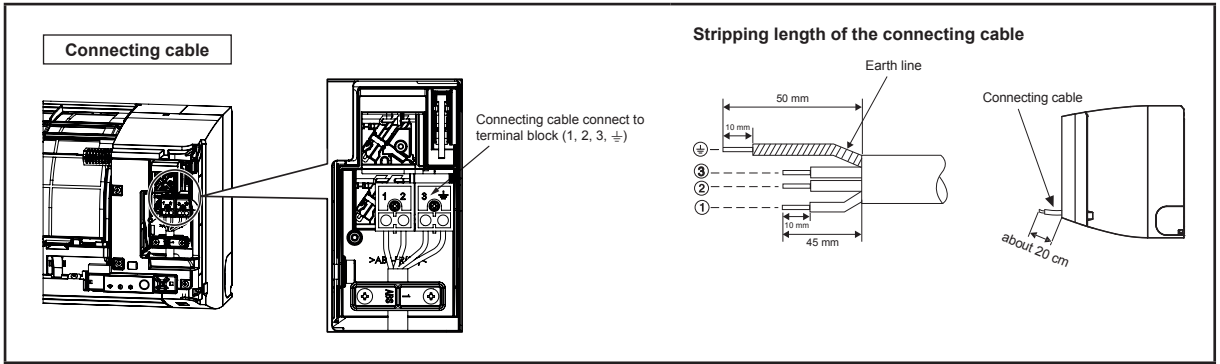

### CAUTION

Power supply must input at Outdoor Unit Terminal Block.

### Wiring Diagram

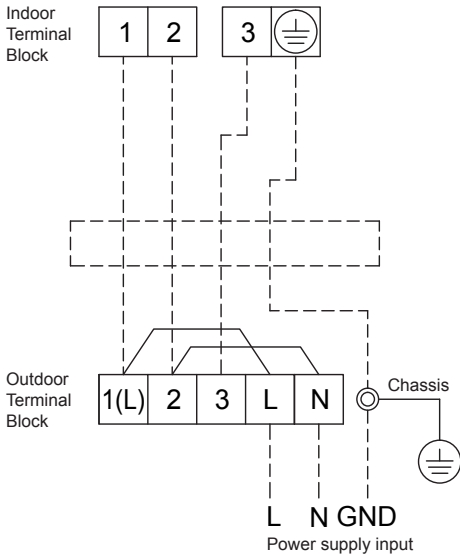

### CAUTION

1. The power supply must be same as the rated of air conditioner.
2. Prepare the power source for exclusive use with air conditioner.
3. Circuit breaker must be used for the power supply line of this air conditioner.
4. Be sure to comply power supply and connecting cable for size and wiring method.
5. Every wire must be connected firmly.
6. Perform wiring works so as to allow a general wiring capacity.
7. Wrong wiring connection may cause some electrical part burn out.
8. Incorrect or incomplete wiring is carried out, it will cause an ignition or smoke.

# OTHERS

## Gas Leak Test

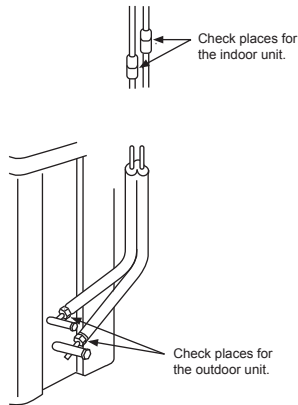

- Check the flare nut connections for the gas leak with a gas leak detector or soap water.

## Remote Control A-B Selection

- When two indoor units are installed in the same room or adjacent two rooms, if operating a unit, two units may receive the remote control signal simultaneously and operate. In this case, the operation can be preserved by setting either one remote control to B setting. (Both are set to A setting in factory shipment.)
- The remote control signal is not received when the settings of indoor unit and remote control are different.
- There is no relation between A setting/B setting and A room/B room when connecting the piping and cables.

To separate using of remote control for each indoor unit in case of 2 air conditioner are installed near.

### Remote Control B Setup.

1. Press RESET button on the indoor unit to turn the air conditioner ON.
2. Point the remote control at the indoor unit.
3. Push and hold **check** button on the Remote Control by the tip of the pencil. "00" will be shown on the display.
4. Press **MODE** during pushing **check**. "B" will show on the display and "00" will disappear and the air conditioner will turn OFF. The Remote Control B is memorized.

- Note :
1. Repeat above step to reset Remote Control to be A.
  2. Remote Control A has not "A" display.
  3. Default setting of Remote Control from factory is A.

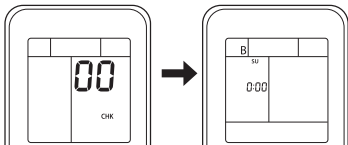

## Test Operation

To switch to the TEST RUN (COOL) mode, press Temporary switch for 10 seconds. (The unit will make a short Pi sound.)

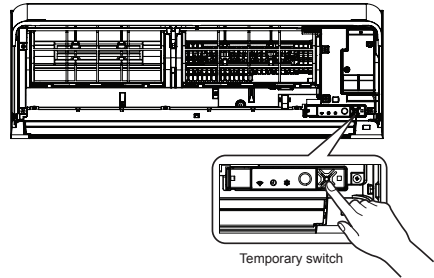

## Auto Restart Setting

This product is designed so that, after a power failure, it can restart automatically in the same operating mode as before the power failure.

### Information

The product was shipped with Auto Restart function in the off position. Turn it on as required.

### How to set the Auto Restart

1. Press and hold the Temporary switch on the indoor unit for 3 seconds to set the operation (3 Pi sound and OPERATION lamp blink 5 time/sec for 5 seconds).
2. Press and hold the Temporary switch on the indoor unit for 3 seconds to cancel the operation (3 Pi sound but OPERATION lamp does not blink).
  - In case of ON timer or OFF timer are set, AUTO RESTART OPERATION does not activate.