

# TOSHIBA

Leading Innovation >>>

**R32**

For commercial use

## *AIR CONDITIONER (SPLIT TYPE)* Installation Manual

Indoor Unit

Model name:

---

4-Way Smart Cassette

**RAV-GM561UT-E**

**RAV-GM801UT-E**

**RAV-GM1101UT-E**

**RAV-GM1401UT-E**

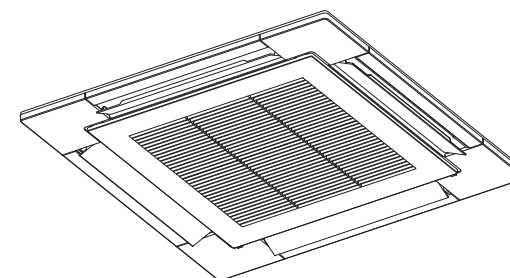

## Original instruction

Please read this Installation Manual carefully before installing the Air Conditioner.

- This Manual describes the installation method of the indoor unit.
- For installation of the outdoor unit, follow the Installation Manual attached to the outdoor unit.

### ADOPTION OF R32 REFRIGERANT

This Air Conditioner has adopted a refrigerant HFC (R32) which does not destroy the ozone layer.  
This indoor unit is for the R32 refrigerant. Be sure to combine with an outdoor unit for the R32 refrigerant.

**Product information of ecodesign requirements. (Regulation (EU) 2016/2281)**  
<http://ecodesign.toshiba-airconditioning.eu/en>

## Contents

1	Precautions for safety	3
2	Accessory parts	7
3	Selection of installation place	7
4	Installation	9
5	Drain piping	11
6	Refrigerant piping	13
7	Electrical connection	14
8	Applicable controls	18
9	Test run	24
10	Maintenance	25
11	Troubleshooting	27

Thank you for purchasing this Toshiba air conditioner.

Please read carefully through these instructions that contain important information which complies with the "Machinery" Directive (Directive 2006/42/EC), and ensure that you understand them.

After completing the installation work, hand over this Installation Manual as well as the Owner's Manual provided with the outdoor unit to the user, and ask the user to keep them in a safe place for future reference.

#### Generic denomination: Air conditioner

#### Definition of qualified installer or qualified service person

The air conditioner must be installed, maintained, repaired and removed by a qualified installer or qualified service person. When any of these jobs is to be done, ask a qualified installer or qualified service person to do them for you. A qualified installer or qualified service person is an agent who has the qualifications and knowledge described in the table below.

Agent	Qualifications and knowledge which the agent must have
Qualified installer	<ul style="list-style-type: none"> <li>The qualified installer is a person who installs, maintains, relocates and removes the air conditioners made by Toshiba Carrier Corporation. He or she has been trained to install, maintain, relocate and remove the air conditioners made by Toshiba Carrier Corporation or, alternatively, he or she has been instructed in such operations by an individual or individuals who have been trained and is thus thoroughly acquainted with the knowledge related to these operations.</li> <li>The qualified installer who is allowed to do the electrical work involved in installation, relocation and removal has the qualifications pertaining to this electrical work as stipulated by the local laws and regulations, and he or she is a person who has been trained in matters relating to electrical work on the air conditioners made by Toshiba Carrier Corporation or, alternatively, he or she has been instructed in such matters by an individual or individuals who have been trained and is thus thoroughly acquainted with the knowledge related to this work.</li> <li>The qualified installer who is allowed to do the refrigerant handling and piping work involved in installation, relocation and removal has the qualifications pertaining to this refrigerant handling and piping work as stipulated by the local laws and regulations, and he or she is a person who has been trained in matters relating to refrigerant handling and piping work on the air conditioners made by Toshiba Carrier Corporation or, alternatively, he or she has been instructed in such matters by an individual or individuals who have been trained and is thus thoroughly acquainted with the knowledge related to this work.</li> <li>The qualified installer who is allowed to work at heights has been trained in matters relating to working at heights with the air conditioners made by Toshiba Carrier Corporation or, alternatively, he or she has been instructed in such matters by an individual or individuals who have been trained and is thus thoroughly acquainted with the knowledge related to this work.</li> </ul>
Qualified service person	<ul style="list-style-type: none"> <li>The qualified service person is a person who installs, repairs, maintains, relocates and removes the air conditioners made by Toshiba Carrier Corporation. He or she has been trained to install, repair, maintain, relocate and remove the air conditioners made by Toshiba Carrier Corporation or, alternatively, he or she has been instructed in such operations by an individual or individuals who have been trained and is thus thoroughly acquainted with the knowledge related to these operations.</li> <li>The qualified service person who is allowed to do the electrical work involved in installation, repair, relocation and removal has the qualifications pertaining to this electrical work as stipulated by the local laws and regulations, and he or she is a person who has been trained in matters relating to electrical work on the air conditioners made by Toshiba Carrier Corporation or, alternatively, he or she has been instructed in such matters by an individual or individuals who have been trained and is thus thoroughly acquainted with the knowledge related to this work.</li> <li>The qualified service person who is allowed to do the refrigerant handling and piping work involved in installation, repair, relocation and removal has the qualifications pertaining to this refrigerant handling and piping work as stipulated by the local laws and regulations, and he or she is a person who has been trained in matters relating to refrigerant handling and piping work on the air conditioners made by Toshiba Carrier Corporation or, alternatively, he or she has been instructed in such matters by an individual or individuals who have been trained and is thus thoroughly acquainted with the knowledge related to this work.</li> <li>The qualified service person who is allowed to work at heights has been trained in matters relating to working at heights with the air conditioners made by Toshiba Carrier Corporation or, alternatively, he or she has been instructed in such matters by an individual or individuals who have been trained and is thus thoroughly acquainted with the knowledge related to this work.</li> </ul>

#### Definition of protective gear



When the air conditioner is to be transported, installed, maintained, repaired or removed, wear protective gloves and 'safety' work clothing.

In addition to such normal protective gear, wear the protective gear described below when undertaking the special work detailed in the table below.

Failure to wear the proper protective gear is dangerous because you will be more susceptible to injury, burns, electric shocks and other injuries.

Work undertaken	Protective gear worn
All types of work	Protective gloves 'Safety' working clothing
Electrical-related work	Gloves to provide protection for electricians Insulating shoes Clothing to provide protection from electric shock
Work done at heights (50 cm or more)	Helmets for use in industry
Transportation of heavy objects	Shoes with additional protective toe cap
Repair of outdoor unit	Gloves to provide protection for electricians

These safety cautions describe important matters concerning safety to prevent injury to users or other people and damages to property. Please read through this manual after understanding the contents below (meanings of indications), and be sure to follow the description.





Indication	Meaning of Indication
 <b>WARNING</b>	Text set off in this manner indicates that failure to adhere to the directions in the warning could result in serious bodily harm (*1) or loss of life if the product is handled improperly.
 <b>CAUTION</b>	Text set off in this manner indicates that failure to adhere to the directions in the caution could result in slight injury (*2) or damage (*3) to property if the product is handled improperly.

\*1: Serious bodily harm indicates loss of eyesight, injury, burns, electric shock, bone fracture, poisoning, and other injuries which leave aftereffect and require hospitalization or long-term treatment as an outpatient.





\*2: Slight injury indicates injury, burns, electric shock, and other injuries which do not require hospitalization or long-term treatment as an outpatient.

\*3: Damage to property indicates damage extending to buildings, household effects, domestic livestock, and pets.

#### MEANINGS OF SYMBOLS DISPLAYED ON THE UNIT

	<b>WARNING</b> (Risk of fire)	This mark is for R32 refrigerant only. Refrigerant type is written on nameplate of outdoor unit. In case that refrigerant type is R32, this unit uses a flammable refrigerant. If refrigerant leaks and comes in contact with fire or heating part, it will create harmful gas and there is risk of fire.
		Read the OWNER'S MANUAL carefully before operation.
		Service personnel are required to carefully read the OWNER'S MANUAL and INSTALLATION MANUAL before operation.
		Further information is available in the OWNER'S MANUAL, INSTALLATION MANUAL, and the like.

## ■ Warning indications on the air conditioner unit

Warning indication		Description
	<p><b>WARNING</b></p> <p><b>ELECTRICAL SHOCK HAZARD</b> Disconnect all remote electric power supplies before servicing.</p>	<p><b>WARNING</b></p> <p><b>ELECTRICAL SHOCK HAZARD</b> Disconnect all remote electric power supplies before servicing.</p>
	<p><b>WARNING</b></p> <p>Moving parts. Do not operate unit with grille removed. Stop the unit before the servicing.</p>	<p><b>WARNING</b></p> <p>Moving parts. Do not operate unit with grille removed. Stop the unit before the servicing.</p>
	<p><b>CAUTION</b></p> <p>High temperature parts. You might get burned when removing this panel.</p>	<p><b>CAUTION</b></p> <p>High temperature parts. You might get burned when removing this panel.</p>
	<p><b>CAUTION</b></p> <p>Do not touch the aluminum fins of the unit. Doing so may result in injury.</p>	<p><b>CAUTION</b></p> <p>Do not touch the aluminium fins of the unit. Doing so may result in injury.</p>
	<p><b>CAUTION</b></p> <p><b>BURST HAZARD</b> Open the service valves before the operation, otherwise there might be the burst.</p>	<p><b>CAUTION</b></p> <p><b>BURST HAZARD</b> Open the service valves before the operation, otherwise there might be the burst.</p>

# 1 Precautions for safety

The manufacturer shall not assume any liability for the damage caused by not observing the description of this manual.

## **WARNING**

### General

- Before starting to install the air conditioner, read through the Installation Manual carefully, and follow its instructions to install the air conditioner.
- Only a qualified installer or service person is allowed to do installation work. Inappropriate installation may result in water leakage, electric shock or fire.
- Do not use any refrigerant different from the one specified for complement or replacement. Otherwise, abnormally high pressure may be generated in the refrigeration cycle, which may result in a failure or explosion of the product or an injury to your body.
- Before opening the intake grille of the indoor unit or service panel of the outdoor unit, set the circuit breaker to the OFF position. Failure to set the circuit breaker to the OFF position may result in electric shocks through contact with the interior parts. Only a qualified installer (\*1) or qualified service person (\*1) is allowed to remove the intake grille of the indoor unit or service panel of the outdoor unit and do the work required.
- Before carrying out the installation, maintenance, repair or removal work, set the circuit breaker to the OFF position. Otherwise, electric shocks may result.
- Place a “Work in progress” sign near the circuit breaker while the installation, maintenance, repair or removal work is being carried out. There is a danger of electric shocks if the circuit breaker is set to ON by mistake.
- Only a qualified installer (\*1) or qualified service person (\*1) is allowed to undertake work at heights using a stand of 50 cm or more or to remove the intake grille of the indoor unit to undertake work.
- Wear protective gloves and safety work clothing during installation, servicing and removal.
- Do not touch the aluminium fin of the unit. You may injure yourself if you do so. If the fin must be touched for some reason, first put on protective gloves and safety work clothing, and then proceed.
- Do not climb onto or place objects on top of the outdoor unit. You may fall or the objects may fall off of the outdoor unit and result in injury.

- When work is performed at heights, use a ladder which complies with the ISO 14122 standard, and follow the procedure in the ladder's instructions. Also wear a helmet for use in industry as protective gear to undertake the work.
- Before cleaning the filter or other parts of the outdoor unit, set the circuit breaker to OFF without fail, and place a "Work in progress" sign near the circuit breaker before proceeding with the work.
- Before working at heights, put a sign in place so that no-one will approach the work location, before proceeding with the work. Parts and other objects may fall from above, possibly injuring a person below. While carrying out the work, wear a helmet for protection from falling objects.
- The refrigerant used by this air conditioner is the R32.
- The air conditioner must be transported in stable condition. If any part of the product is broken, contact the dealer.
- When the air conditioner must be transported by hand, carry it by two or more people.
- Do not move or repair any unit by yourself. There is high voltage inside the unit. You may get electric shock when removing the cover and main unit.
- This appliance is intended to be used by expert or trained users in shops, in light industry, or for commercial use by lay persons.

#### **Selection of installation location**

- When the air conditioner is installed in a small room, provide appropriate measures to ensure that the concentration of refrigerant leakage occur in the room does not exceed the critical level.
- Do not install in a location where flammable gas leaks are possible. If the gas leak and accumulate around the unit, it may ignite and cause a fire.
- To transport the air conditioner, wear shoes with additional protective toe caps.
- To transport the air conditioner, do not take hold of the bands around the packing carton. You may injure yourself if the bands should break.
- Install the indoor unit at least 2.5 m above the floor level since otherwise the users may injure themselves or receive electric shocks if they poke their fingers or other objects into the indoor unit while the air conditioner is running.
- Do not place any combustion appliance in a place where it is directly exposed to the wind of air conditioner, otherwise it may cause imperfect combustion.

- Appliance and pipe-work shall be installed, operated and stored in a room with a floor area larger than  $A_{\min} \text{ m}^2$ .  
How to get  $A_{\min} \text{ m}^2$ :  $A_{\min} = (M / (2.5 \times 0.22759 \times h_0))^2$   
M is the refrigerant charge amount in appliance in **kg**;  
 $h_0$  is the installation height of the appliance in **m**:  
0.6 m for floor standing / 1.8 m for wall mounted / 1.0 m for window mounted / 2.2 m for ceiling mounted.  
For detail, refer to Installation Manual of the outdoor unit.

#### **Installation**

- When the indoor unit is to be suspended, the designated hanging bolts (M10 or W3/8) and nuts (M10 or W3/8) must be used.
- Install the air conditioner securely in a location where the base can sustain the weight adequately. If the strength is not enough, the unit may fall down resulting in injury.
- Follow the instructions in the Installation Manual to install the air conditioner. Failure to follow these instructions may cause the product to fall down or topple over or give rise to noise, vibration, water leakage or other trouble.
- Carry out the specified installation work to guard against the possibility of high winds and earthquake. If the air conditioner is not installed appropriately, a unit may topple over or fall down, causing an accident.
- If refrigerant gas has leaked during the installation work, ventilate the room immediately. If the leaked refrigerant gas comes in contact with fire, noxious gas may generate.
- Use forklift to carry in the air conditioner units and use winch or hoist at installation of them.

#### **Refrigerant piping**

- Install the refrigerant pipe securely during the installation work before operating the air conditioner. If the compressor is operated with the valve open and without refrigerant pipe, the compressor sucks air and the refrigeration cycles is over pressurized, which may cause an injury.
- Tighten the flare nut with a torque wrench in the specified manner. Excessive tighten of the flare nut may cause a crack in the flare nut after a long period, which may result in refrigerant leakage.
- After the installation work, confirm that refrigerant gas does not leak. If refrigerant gas leaks into the room and flows near a fire source, such as a cooking range, noxious gas may be generated.

- When the air conditioner has been installed or relocated, follow the instructions in the Installation Manual and purge the air completely so that no gases other than the refrigerant will be mixed in the refrigerating cycle. Failure to purge the air completely may cause the air conditioner to malfunction.
- Nitrogen gas must be used for the airtight test.
- The charge hose must be connected in such a way that it is not slack.

### **Electrical wiring**

- Only a qualified installer (\*1) or qualified service person (\*1) is allowed to carry out the electrical work of the air conditioner. Under no circumstances must this work be done by an unqualified individual since failure to carry out the work properly may result in electric shocks and/or electrical leaks.
- To connect the electrical wires, repair the electrical parts or undertake other electrical jobs, wear gloves to provide protection for electricians, insulating shoes and clothing to provide protection from electric shocks. Failure to wear this protective gear may result in electric shocks.
- Use wiring that meets the specifications in the Installation Manual and the stipulations in the local regulations and laws. Use of wiring which does not meet the specifications may give rise to electric shocks, electrical leakage, smoking and/or a fire.
- Connect earth wire. (Grounding work)  
Incomplete earthing causes an electric shock.
- Do not connect earth wires to gas pipes, water pipes, and lightning conductor or telephone earth wires.
- After completing the repair or relocation work, check that the earth wires are connected properly.
- Install a circuit breaker that meets the specifications in the installation manual and the stipulations in the local regulations and laws.
- Install the circuit breaker where it can be easily accessed by the agent.
- When installing the circuit breaker outdoors, install one which is designed to be used outdoors.
- Under no circumstances, the power supply wire or the indoor and outdoor connecting wire must not be connected in the middle (Connection using a solderless terminal etc.)  
Connection trouble in the places where the wire is connected in the middle may give rise to smoking and/or a fire.

- Electrical wiring work shall be conducted according to law and regulation in the community and installation manual.  
Failure to do so may result in electrocution or short circuit.

### **Test run**

- Before operating the air conditioner after having completed the work, check that the electrical control box cover of the indoor unit and service panel of the outdoor unit are closed, and set the circuit breaker to the ON position. You may receive an electric shock if the power is turned on without first conducting these checks.
- If there is any kind of trouble (such as check code display has appeared, smell of burning, abnormal sounds, the air conditioner fails to cool or heat or water is leaking) has occurred in the air conditioner, do not touch the air conditioner yourself but set the circuit breaker to the OFF position, and contact a qualified service person. Take steps to ensure that the power will not be turned on (by marking “out of service” near the circuit breaker, for instance) until qualified service person arrives. Continuing to use the air conditioner in the trouble status may cause mechanical problems to escalate or result in electric shocks or other trouble.
- After the work has finished, use an insulation tester set (500 V Megger) to check the resistance is 1 MΩ or more between the charge section and the non-charge metal section (Earth section). If the resistance value is low, a disaster such as a leak or electric shock is caused at user's side.
- Upon completion of the installation work, check for refrigerant leaks and check the insulation resistance and water drainage. Then conduct a test run to check that the air conditioner is operating properly.

### **Explanations given to user**

- Upon completion of the installation work, tell the user where the circuit breaker is located. If the user does not know where the circuit breaker is, he or she will not be able to turn it off in the event that trouble has occurred in the air conditioner.
- After the installation work, follow the Owner's Manual to explain to the customer how to use and maintain the unit.

---

## Relocation

- Only a qualified installer (\*1) or qualified service person (\*1) is allowed to relocate the air conditioner. It is dangerous for the air conditioner to be relocated by an unqualified individual since a fire, electric shocks, injury, water leakage, noise and/or vibration may result.
  - When carrying out the pump-down work shut down the compressor before disconnecting the refrigerant pipe. Disconnecting the refrigerant pipe with the service valve left open and the compressor still operating will cause air or other gas to be sucked in, raising the pressure inside the refrigeration cycle to an abnormally high level, and possibly resulting in rupture, injury or other trouble.
- 

---











## CAUTION

**This Air Conditioner has adopted a refrigerant HFC (R32) which does not destroy the ozone layer.**

- As the R32 refrigerant is easily affected by impurities such as moisture, oxidized film, oil, etc., due to the high pressure, be careful not to allow the moisture, dirt, existing refrigerant, refrigerating machine oil, etc., to get mixed up in the refrigeration cycle during the installation work.
  - A special tool for the R32 or R410A refrigerant is required for installation.
  - Use a new and clean piping materials for the connecting pipe so that moisture and dirt are not mixed together during the installation work.
  - When using existing pipes, follow the installation manual enclosed with the outdoor unit.
- 

(\*1) Refer to the "Definition of qualified installer or qualified service person".

## 2 Accessory parts

Part name	Qty	Shape	Usage
Owner's Manual	1		(Hand over to customers) (For other languages that do not appear in this Installation Manual, please refer to the enclosed CD-R.)
Installation Manual	1	This manual	(Hand over to customers) (For other languages that do not appear in this Installation Manual, please refer to the enclosed CD-R.)
CD-ROM	1	—	Owner's Manual and Installation Manual
Heat insulating pipe	2		For heat insulation of the pipe connecting section
Installation pattern	1	—	For checking of ceiling opening and the main unit position
Installation gauge	2		For positioning of the ceiling position (To be used with the installation pattern)
Heat insulator	1		For heat insulation of drain connecting section
Eccentric washer	4		For unit hanging
Washer	4		For unit hanging
Hose band	1		For connecting drain pipe
Flexible hose	1		For adjusting core-out of drain pipe
Heat insulator	1		For sealing wiring connection port (for GM56 type)
Seal material	2		For sealing wiring connection port (for GM80, GM110, GM140 type)
Banding band	4		For securing heat insulating pipe

### ■ Separate sold parts

The Ceiling panel and remote controller are sold separately. For the installation of these products, follow the Installation Manuals supplied with them.

## 3 Selection of installation place

### ⚠ WARNING

- **Install the air conditioner securely in a location where the base can sustain the weight adequately.**  
If the strength is not enough, the unit may fall down resulting in injury.
- **Install the air conditioner at a height 2.5 m or more from the floor.**  
If you insert your hands or others directly into the unit while the air conditioner operates, it is dangerous because you may contact with revolving fan or active electricity.

### ⚠ CAUTION

- **Do not install in a location where flammable gas may leaks are possible.**  
If the gas leak and accumulate around the unit, it may ignite and cause a fire.

**Upon approval of the customer, install the air conditioner in a place that satisfies the following conditions.**

- Place where the unit can be installed horizontally.
- Place where a sufficient servicing space can be ensured for safety maintenance and check.
- Place where drained water will not cause any problem.

**Avoid installing in the following places.**

- Place exposed to air with high salt content (seaside area), or place exposed to large quantities of sulfide gas (hot spring).  
(The unit should be used in these places, special protective measures are needed.)
- A restaurant kitchen where a lot of oil is used or place near machines in a factory (Oil adhering to the heat exchanger and resin part (turbo fan) in the indoor unit may reduce the performance, generate mist or dew drop, or deform or damage resin parts.)
- Places where iron or other metal dust is present. If iron or other metal dust adheres to or collects on the interior of the air conditioner, it may spontaneously combust and start a fire.
- Place where organic solvent is used nearby.
- Place close to a machine generating high frequency.
- Place where the discharged air blows directly into the window of the neighbour house. (Outdoor unit)
- Place where noise of the outdoor unit is easily transmitted.  
(When the outdoor unit is installed on the boundary with the neighbour, pay due attention to the level of noise.)
- Place with poor ventilation. (Before air duct work, check whether value of fan speed, static pressure and duct resistance are correct.)
- Do not use the air conditioner for special purposes such as preserving food, precision instruments, or art objects, or where breeding animals or growing plants are kept. (This may degrade the quality of preserved materials.)
- Place where any of high-frequency appliances (including inverter devices, private power generators, medical equipment, and communication equipment) and inverter-type fluorescent light is installed.  
(A malfunction of the air conditioner, abnormal control, or problems due to noise to such appliances / equipment may occur.)
- When the wireless remote controller is used in a room equipped with an inverter-type fluorescent light or at a place exposed to direct sunlight, signals from the remote controller may not be received correctly.
- Place where organic solvent is used.
- Place near a door or window exposed to humid outside air (Dew drop may form.).
- Place where special spray is used frequently.



## ■ Installation space

Ensure there is sufficient space to install the unit and to perform maintenance work as and when required. Keep 15 mm or more for clearance between top plate of the indoor unit and the ceiling surface.

Unit: mm

Model RAV-	A mm
GM56 type	271 or more
GM80, GM110, GM140 type	334 or more

### <When taking in fresh air>

- When using a flange sold separately to take in fresh air, place the check port on the flange side.

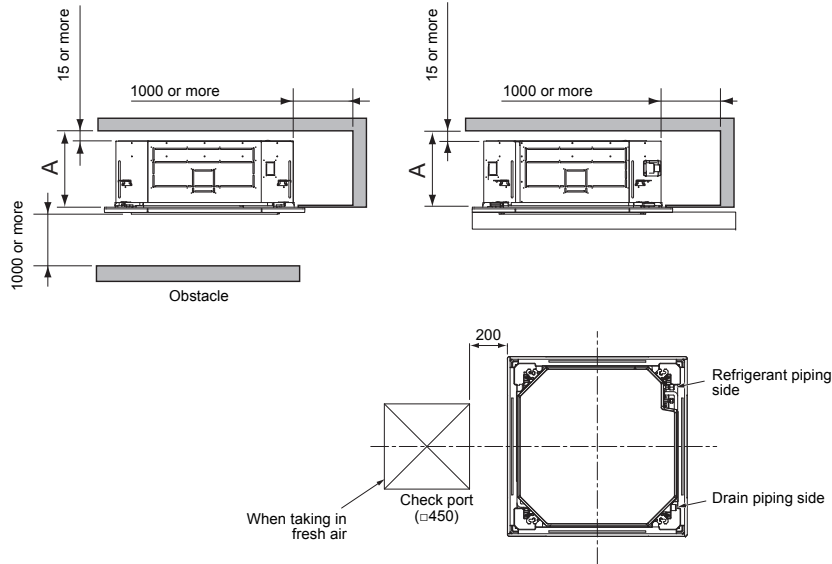

## ■ Selection of installation place

Continual operation of the indoor unit under high-humidity conditions as described below, dew may condense and water may drop.

Especially, high-humidity atmosphere (dew point temperature: 23°C or more) may generate dew inside the ceiling.

- Unit is installed inside the ceiling with slated roof.
- Unit is installed at a location using inside of the ceiling as fresh air intake path.
- Kitchen

### REQUIREMENT

When the humidity inside the ceiling seems to be higher than 80%, attach a heat insulator to the side (top) surface of the indoor unit. (Use a heat insulator with a thickness of 10 mm or more.)

## ■ Ceiling height

Unit : m

Model RAV-	Installable ceiling height
GM56, GM80 type	Up to 3.8
GM110, GM140 type	Up to 4.6

When the height of the ceiling exceeds the distance of the item Standard / 4-way in below table, the warm air is difficult to reach the floor.

It is necessary to change the setup value of the high ceiling setting or discharge direction.

### ▼ Height list of ceiling possible to be installed

Unit : m

Model RAV-	GM56			GM80			GM110, GM140			Setup of high ceiling
	4-way	3-way	2-way	4-way	3-way	2-way	4-way	3-way	2-way	
Standard (Factory default)	2.8	3.2	3.5	3.0	3.3	3.6	3.9	4.2	4.5	0000
High ceiling (1)	3.2	3.5	3.8	3.3	3.5	3.8	4.2	4.4	4.6	0001
High ceiling (3)	3.5	3.8	—	3.6	3.8	—	4.5	4.6	—	0003

### REQUIREMENT

- When using the air conditioner with 2-way / 3-way discharge system, a strong wind blows directly if the ceiling height is lower than the standard. Therefore, change the setting switch according to height of the ceiling.
- When high ceiling (1) or (3) is used with 4-way blowing, a draft is easily recognized due to drop of discharge temperature.

The lighting time of the filter sign (notification of filter cleaning) on the remote controller can be changed according to installation conditions.

When it is difficult to obtain satisfactory heating due to location place of the indoor unit or the structure of the room, the detection temperature of heating can be raised.

Refer to "8. Applicable controls" in this manual for the setting procedure.

## ■ Discharge direction

As shown in the figure below, air discharge directions can be selected according to the shape of the room and the location of the indoor unit installation.

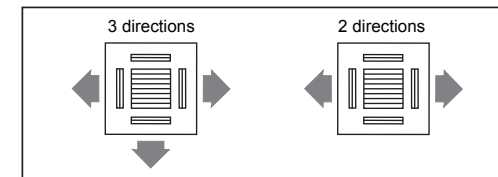

Use an Air discharge direction kit (sold separately) to change discharge directions.

This needs to be set with the wired remote controller during installation.

Discharge directions are limited. Follow the Installation Manual supplied with the Air discharge direction kit.

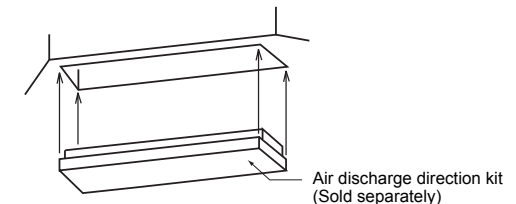



## ■ Opening a ceiling and installation of hanging bolts

- Consider the piping / wiring after the unit is hung to determine the location of the indoor unit installation and orientation.
- After the location of the indoor unit installation has been determined, open the ceiling and install hanging bolts.
- The dimensions of the ceiling opening and hanging bolt pitches are given in the outline drawing and the attached installation pattern.
- When a ceiling already exists, lay the drain pipe, refrigerant pipe, control wires, and remote controller wires to their connection locations before hanging the indoor unit.

Procure hanging bolts and nuts for installing the indoor unit (these are not supplied).

Hanging bolt	M10 or W3/8	4 pieces
Nut	M10 or W3/8	12 pieces

### Using the installation pattern (accessory)

The installation pattern is provided inside the packaging cap.

#### <For existing ceiling>

Use the installation pattern positioning a ceiling opening and hanging bolts.

#### <For new ceiling>

Use the installation pattern to position the ceiling opening when a ceiling is hanged.

- After the hanging bolts have been installed, install the indoor unit.
- After loosening the panel mounting screws of the indoor unit, hook them on the four holes in the installation pattern.
- When hanging a ceiling, open the ceiling along the outside dimensions of the installation pattern.

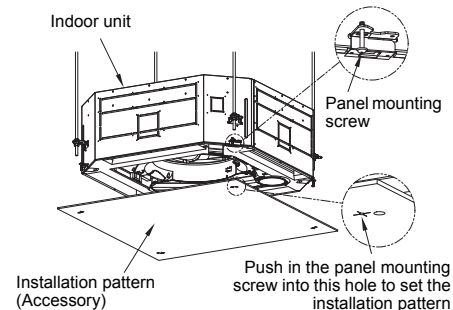

## Treatment of ceiling

The ceiling differs according to structure of building. For details, consult your constructor or interior finish contractor.

In the process after the ceiling board has been removed, it is important to reinforce ceiling foundation (frame) and to keep horizontal level of installed ceiling correctly in order to prevent vibration of ceiling board.

1. Cut and remove the ceiling foundation.
2. Reinforce the cut surface of ceiling foundation, and add ceiling foundation for fixing the end of ceiling board.

## Installation of hanging bolt

Use M10 hanging bolts (4 pcs, locally procured). Matching to the existing structure, set pitch according to size in the unit external view as shown below.

New concrete slab	
Install the bolts with insert brackets or anchor bolts.	
(Blade type bracket)	(Slide type bracket)
Anchor bolt (Pipe hanging anchor bolt)	
Steel flame structure	
Use existing angles or install new support angles.	
Hanging bolt, Support angle	
Existing concrete slab	
Use a hole-in anchors, hole-in plugs, or a hole-in bolts.	

## Installation of ceiling opening and hanging bolt

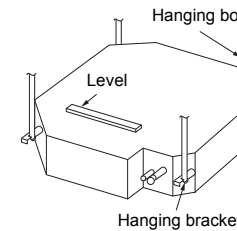

- Attach a nut (locally procured) and the washer (supplied) to each hanging bolt.
- Insert a washer on both sides of the T groove of the hanging bracket of the indoor unit, and hang the indoor unit.
- Check that the four sides of the indoor unit are level using a level gauge (levelness: 5 mm or less).
- Detach the installation gauge (accessory) from the installation pattern.
- Using the installation gauge, check and adjust the positional relation between the indoor unit and the ceiling opening (1) (10 - 35 mm: 4 sides) and the hanging-up height (2) (12 - 17 mm: 4 corners). (How to use the installation gauge is printed on the gauge.)

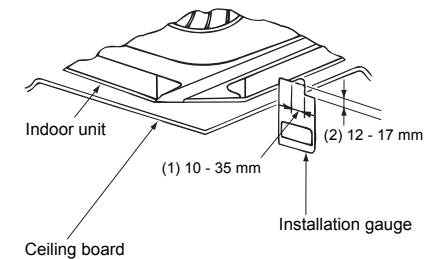
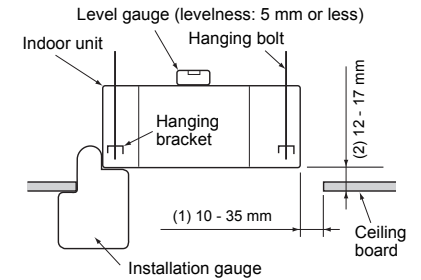
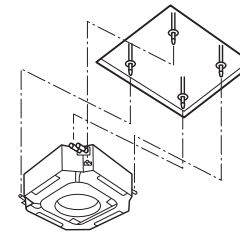
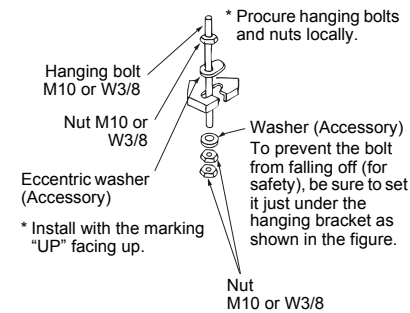

### CAUTION

Before installation of the indoor unit, remove the tape that holds the fan and bell mouth. Running the unit without removing the tape may damage the fan motor.

## ■ Installation of ceiling panel (Sold separately)

Install the ceiling panel according to Installation Manual attached with it after piping / wiring work has completed.

Check that installation of indoor unit and ceiling opening part is correct, and then install it.

### REQUIREMENT

- Joint the connecting sections of ceiling panel, ceiling surface, ceiling panel and indoor unit closely. Any gap between them will cause air leakage and the generate condensation or water leakage.
- Remove the adjust corner caps at the four corners of the ceiling panel, and then install the ceiling panel onto the indoor unit.  
Also, check that the claws are securely fit when returning the adjust corner caps to its original position.
- \* Improper fitting of the claws may cause water leakage.

## ■ Installation of wired remote controller (Sold separately)

For installation of the wired remote controller, follow the Installation Manual attached with the remote controller.

- Pull out the remote controller cord together with the refrigerant pipe or drain pipe.  
Pass the remote controller cord through upper side of the refrigerant pipe and drain pipe.
- Do not leave the remote controller at a place exposed to the direct sunlight and near a stove.

## ■ Installation of wireless remote controller (Sold separately)

The sensor of indoor unit with wireless remote controller can receive a signal by distance within approx. 7 m. Based upon it, determine a place where the remote controller is operated and the installation place.

- Operate the remote controller, confirm that the indoor unit receives a signal surely, and then install it.
- Keep 1 m or more from the devices such as television, stereo.  
(Disturbance of image or noise may generate.)
- To prevent a malfunction, select a place where is not influenced by a fluorescent light or direct sunlight.
- Two or more (Up to 6 units) indoor units with wireless type remote controller can be installed in the same room.

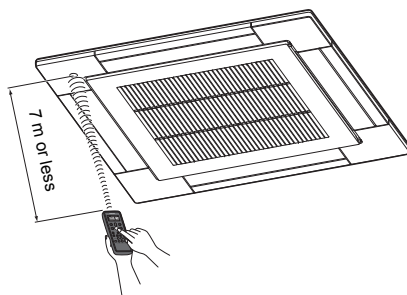

# 5 Drain piping

### ⚠ CAUTION

Following the Installation Manual, perform the drain piping work so that water is properly drained, and apply a heat insulation so as not to cause a dew drop.

Inappropriate piping work may result in water leakage in the room and wet of furniture.

## ■ Piping / Heat insulating material

Require the following materials for piping and heat insulating at site.

Piping	Hard polyvinyl chloride pipe socket for VP25
	Hard vinyl chloride pipe VP25 (Outer dia.: Ø32 mm)
Heat insulator	Foam polyethylene: Thickness 10 mm or more

## ■ Flexible hose

Use the attached flexible hose to adjust center discrepancy of the hard vinyl chloride pipe or to adjust the angle.

- Do not use the flexible hose as stretched, or do not deform it more extent than that in the following figure.
- Be sure to fix the soft end of the flexible hose with the attached hose band.
- Use the flexible hose on a horizontal level.

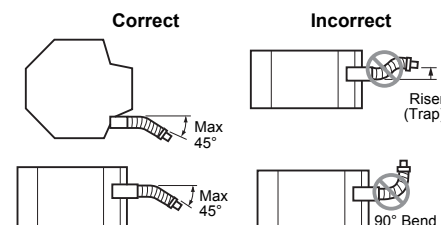

### REQUIREMENT

- Perform heat insulation of the drain pipes of the indoor unit.
- Perform heat insulation of the connecting part with the indoor unit.  
An incomplete heat insulation causes dew drop.
- Set the drain pipe with downward slope (1/100 or more), and do not make swelling or trap on the piping. It may cause an abnormal sound.
- For length of the traversing drain pipe, restrict to 20 m or less.  
In case of a long pipe, provide support brackets with interval of 1.5 - 2 m in order to prevent waving.

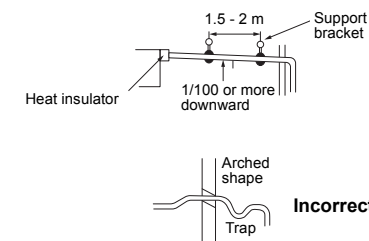

- Set the collective piping as shown in the below figure.

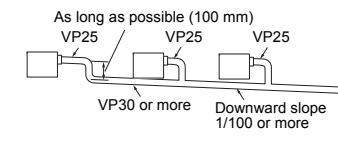

- Do not apply force to the connecting part of the drain pipe.
- The hard vinyl-chloride pipe cannot be directly connected to the drain pipe connecting port of the indoor unit.  
For connection with the drain pipe connecting port, fix the attached flexible hose with the hose band, otherwise a damage or water leak is caused on the drain pipe connecting port.

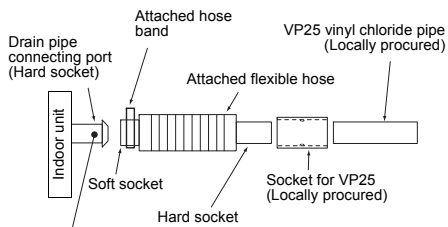

#### Adhesive inhibited:

Use the attached flexible hose and hose band for connecting the drain hose to the clear drain socket. If applying the adhesive, socket will be damaged and cause water leakage.

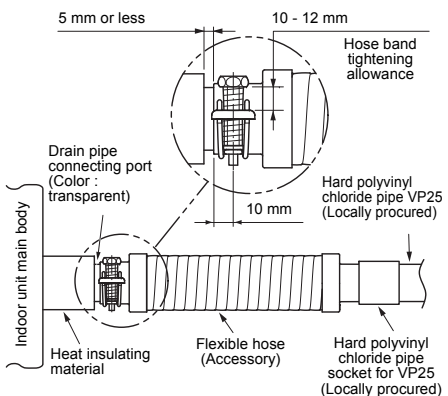

## ■ Connecting drain pipe

- Connect a hard socket (locally procured) to the hard socket of the attached supplied flexible hose.
- Connect a drain pipe (locally procured) to the connected hard socket.

#### REQUIREMENT

- Connect hard vinyl chloride pipes securely using an adhesive for vinyl chloride to avoid water leakage.
- It takes some time until the adhesive is dried and hardened (refer to the manual of the adhesive). Do not apply stress to the joint with the drain pipe during this time period.

## ■ Drain up

When a down-gradient cannot be secured for the drainpipe, drain-up piping is possible.

- The height of the drain pipe must be 850 mm or less from the bottom of the ceiling.
- Take the drain pipe out of the drain pipe joint with the indoor unit in 300 mm or less, and bend up the pipe vertically.
- Immediately after the pipe is bent up vertically, lay the pipe making a down-gradient.
- Set downward grading immediately after raising up vertically.

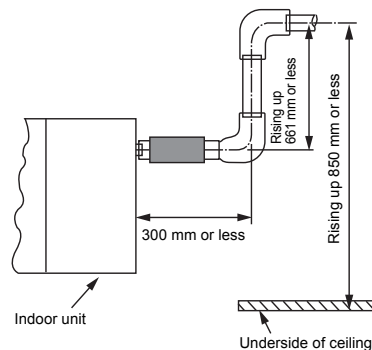

## ■ Check the draining

In the test run, check that water drain is properly performed and water does not leak from the connecting part of the pipes.

Check that there are no abnormal motor sounds from the drain pump as well.

Check draining also when installed in heating period.

By using a pitcher or hose, pour water (1500 - 2000 cc) into the discharge port before installation of the ceiling panel.

Pour water gradually so that water does not spread on the motor of the drain pump.

#### ⚠ CAUTION

Pour water gently so that it does not spread around inside the indoor unit, which may cause a malfunction.

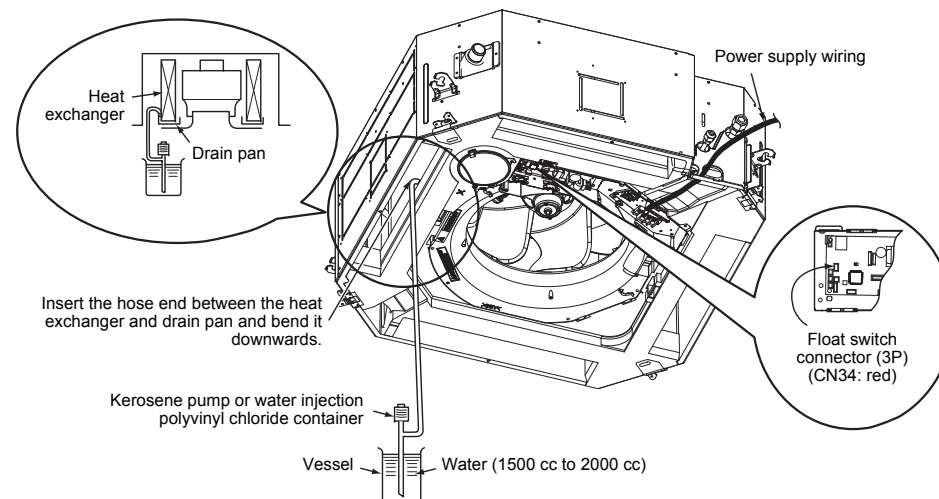

- After the electric work has finished, pour water during COOL mode operation.
- If the electric work has not yet finished, pull out the float switch connector (CN34: Red) from the electrical control box, and check draining by plugging the single phase 220 - 240 V power to the terminal blocks ① and ②. If doing so, the drain pump motor operates. (Never apply 220-240 V to ① or ②, otherwise a trouble of P.C. board occurs.)
- Test water drain while checking the operation sound of the drain pump motor.

(If the operation sound changes from continuous sound to intermittent sound, water is normally drained.)

After the check, the drain pump motor runs, connecting the float switch connector. (In case of check by pulling out the float switch connector, be sure to return the connector to the original position.)

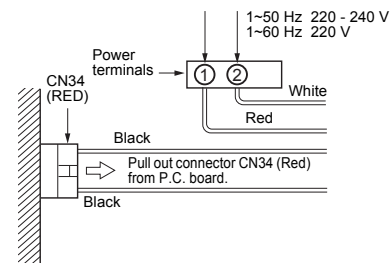

## ■ Perform heat insulating

- As shown in the figure, cover the flexible hose and hose band with the attached heat insulator up to the bottom of the indoor unit without gap.
- Cover the drain pipe seamlessly with a heat insulator to be procured locally so that it overlaps with the attached heat insulator of the drain connecting section.

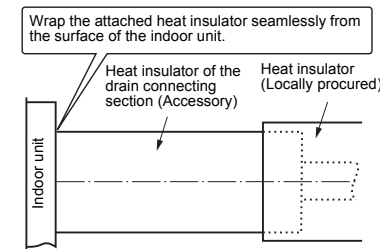

\* Direct the slits and seams of the heat insulator upward to avoid water leakage.

# 6 Refrigerant piping

## CAUTION

Use flare nuts that are included with the unit. Using different flare nuts may cause refrigerant gas leakage.

## Refrigerant piping

Use the following item for the refrigerant piping.  
Material: Seamless phosphorous deoxidized copper pipe.

Ø6.35, Ø9.52, Ø12.7 Wall thickness 0.8 mm or more  
Ø15.88 Wall thickness 1.0 mm or more

### REQUIREMENT

When the refrigerant pipe is long, provide support brackets at intervals of 2.5 - 3 m to clamp the refrigerant pipe. Otherwise, abnormal sound may be generated.

## CAUTION

### IMPORTANT 4 POINTS FOR PIPING WORK

1. Reusable mechanical connectors and flared joints are not allowed indoors. When mechanical connectors are reused indoors, sealing parts shall be renewed. When flared joints are reused indoors, the flare part shall be refabricated.
2. Tight connection (between pipes and unit)
3. Evacuate the air in the connecting pipes by using VACUUM PUMP.
4. Check the gas leakage. (Connected points)

## Pipe size

Model name	RAV-	GM56 type	GM80, GM110, GM140 type
Pipe size	Gas side	12.7 mm	15.9 mm
	Liquid side	6.4 mm	9.5 mm

## Permissible piping length and height difference

They vary according to the outdoor unit.  
For details, refer to the Installation Manual attached to the outdoor unit.

### Flaring

- Cut the pipe with a pipe cutter. Remove burrs completely. Remaining burrs may cause gas leakage.
- Insert a flare nut into the pipe, and flare the pipe. As the flaring sizes of R32 or R410A differ from those of refrigerant R22, the flare tools newly manufactured for R32 or R410A are recommended. However, the conventional tools can be used by adjusting projection margin of the copper pipe.

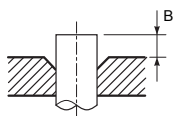

### Projection margin in flaring: B (Unit: mm)

Rigid (Clutch type)

Outer dia. of copper pipe	R32 or R410A tool used	Conventional tool used
6.4, 9.5	0 - 0.5	1.0 - 1.5
12.7, 15.9		

### Flaring dia. meter size: A (Unit: mm)

Outer dia. of copper pipe	A <sup>+0</sup> <sub>-0.4</sub>
6.4	9.1
9.5	13.2
12.7	16.6
15.9	19.7

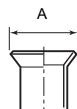

## CAUTION

- Do not scratch the inner surface of the flared part when removing burrs.
- Flare processing under the condition of scratches on the inner surface of flare processing part will cause refrigerant gas leak.
- Check that the flared part is not scratched, deformed, stepped, or flattened, and that there are no chips adhered or other problems, after flare processing.
- Do not apply refrigerating machine oil to the flare surface.

## Tightening connection

### CAUTION

Do not apply excessive torque. Otherwise, the nut may crack depending on the conditions.

Unit: N•m

Outer dia. of copper pipe	Tightening torque
6.4 mm	14 - 18
9.5 mm	34 - 42
12.7 mm	49 - 61
15.9 mm	68 - 82

### Tightening torque of flare pipe connections

Incorrect connections may cause not only a gas leak, but also a trouble of the refrigeration cycle. Align the centres of the connecting pipes and tighten the flare nut as far as possible with your fingers. Then tighten the nut with a spanner and torque wrench as shown in the figure.

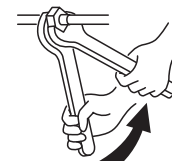

Work using two spanner

### REQUIREMENT

Tightening with an excessive torque may crack the nut depending on installation conditions. Tighten the nut within the specified tightening torque.

## Evacuation

Perform vacuuming from the charge port of valve of the outdoor unit by using a vacuum pump.

For details, follow to the Installation Manual attached to the outdoor unit.

- Do not use the refrigerant sealed in the outdoor unit for evacuation.

### REQUIREMENT

For the tools such as charge hose, use those manufactured exclusively for R32 or R410A.

### Refrigerant amount to be added

For addition of the refrigerant, add refrigerant "R32" referring to the attached Installation Manual of outdoor unit.

Use a scale to charge the refrigerant of specified amount.

### REQUIREMENT

- Charging an excessive or too little amount of refrigerant causes a trouble of the compressor. Charge the refrigerant of specified amount.
- A personnel who charged the refrigerant should write down the pipe length and the added refrigerant amount in the F-GAS label of the outdoor unit. It is necessary to fix the compressor and refrigeration cycle malfunction.

### Open the valve fully

Open the valve of the outdoor unit fully. A 4 mm-hexagonal wrench is required for opening the valve. For details, refer to the Installation Manual attached to the outdoor unit.

### Gas leak check

Check with a leak detector or soap water whether gas leaks or not, from the pipe connecting section or cap of the valve.

### REQUIREMENT

Use a leak detector manufactured exclusively for HFC refrigerant (R32, R410A, R134a).

### Heat insulation process

Apply heat insulation for the pipes separately at liquid side and gas side.

- For the heat insulation to the pipes at gas side, use the material with heat-resisting temperature 120°C or higher.
- Apply the attached heat insulation to the pipe connecting section of the indoor unit securely without gap.

#### REQUIREMENT

- Apply the heat insulation to the pipe connecting section of the indoor unit securely up to the root without exposure of the pipe. (The pipe exposed to the outside causes water leak.)
- Wrap heat insulator with its slits facing up (ceiling side).

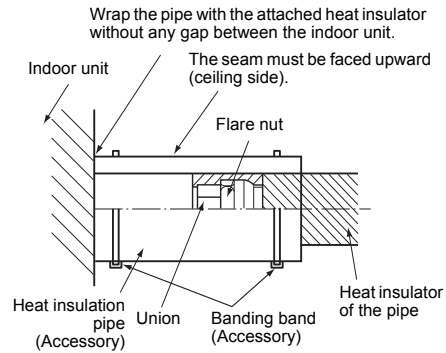

## 7 Electrical connection

### ⚠ WARNING

- **Use the specified wires for wiring connect the terminals. Securely fix them to prevent external forces applied to the terminals from affecting the terminals.**  
Incomplete connection or fixation may cause a fire or other trouble.
- **Connect earth wire. (grounding work)**  
Incomplete earthing cause an electric shock.  
Do not connect earth wires to gas pipes, water pipes, lightning conductor or telephone earth wires.
- **Appliance shall be installed in accordance with national wiring regulations.**  
Capacity shortage of power circuit or incomplete installation may cause an electric shock or a fire.
- **Under no circumstances, the power supply wire or the indoor and outdoor connecting wire must not be connected in the middle (Connection using a solderless terminal etc.)**  
Connection trouble in the places where the wire is connected in the middle may give rise to smoking and/or a fire.

### ⚠ CAUTION

- For power supply specifications, follow the Installation Manual of outdoor unit.
  - Do not connect 220 – 240 V power to the terminal blocks (Ⓐ, Ⓑ) for control wiring. Otherwise, the system will fail.
  - Do not damage or scratch the conductive core and inner insulator of power and system interconnection wires during peeling them.
  - Perform the electric wiring so that it does not come to contact with the high-temperature part of the pipe. The coating may melt resulting in an accident.
- Do not turn on the power of the indoor unit until vacuuming of the refrigerant pipes completes.

### ■ Wiring connection

#### Indoor / Outdoor connecting wires specifications

##### Indoor unit power supplied from outdoor unit

- The outdoor unit power supply patterns vary on models.

Indoor unit power supply	1~50 Hz 220 - 240 V 1~60 Hz 220 V
--------------------------	--------------------------------------

Indoor / Outdoor connecting wires*	4 × 1.5 mm <sup>2</sup> or more (H07 RN-F or 60245 IEC 66)*	Up to 70 m
------------------------------------	---	------------

\*Number of wire × wire size

\*Including earth line

#### Remote controller wiring

Remote controller wiring, remote controller inter-unit wiring	Wire size: 2 × 0.5 to 2.0 mm <sup>2</sup>
---	---

Total wire length of remote controller wiring and remote controller inter-unit wiring = L + L1 + L2 + ... Ln	In case of wired type only	Up to 500 m
	In case of wireless type included	Up to 400 m *1

Total wire length of remote controller inter-unit wiring = L1 + L2 + ... Ln	Up to 200 m
---	-------------

\* 1 For detail of the wired remote controller (RBC-AMS55E\*), follow the Installation Manual attached with the remote controller.

## ⚠ CAUTION

The remote controller wire and Indoor / Outdoor connecting wires cannot be parallel to contact each other and cannot be stored in the same conduits. If doing so, a trouble may be caused on the control system due to noise or other factor.

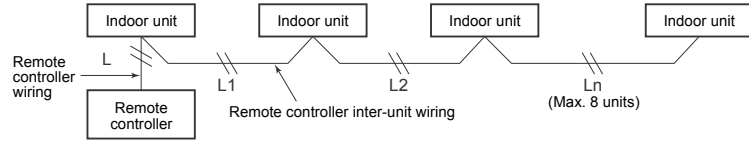

## ■ Wiring between indoor unit and outdoor unit

- Figure below shows the wiring connections between the indoor and outdoor units and between the indoor units and remote controller. The wires indicated by the broken lines or dot-and-dash lines are provided at the locally.
- Refer to the both indoor and outdoor unit wiring diagrams.
- The power of the indoor unit is supplied from the outdoor unit.

### Wiring diagram

#### Single system

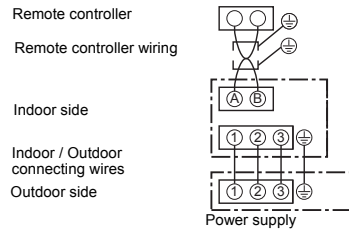

#### Simultaneous twin system

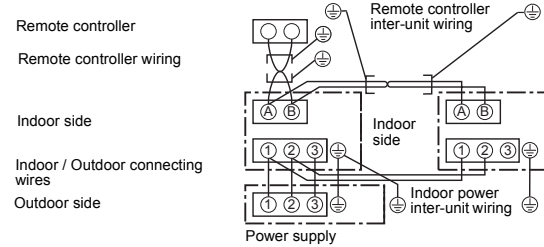

\* Use 2-core shield wire (MVVS 0.5 to 2.0 mm<sup>2</sup> or more) for the remote controller wiring in the simultaneous twin systems to prevent noise problems. Connect both ends of the shield wire to earth leads.

\* Connect earth wires for each indoor unit in the simultaneous twin systems.

## ■ Wire connection

### REQUIREMENT

- Connect the wires matching the terminal numbers. Incorrect connection causes a trouble.
- Route the wire through the wire connection port of the indoor unit.
- The low-voltage circuit is provided for the control wire and remote controller wire. (Do not connect the high-voltage circuit.)

### GM56 type

- Remove screw A for the fixation of the electrical control box cover and loosened screw B. Slide the cover inside so that the hook part can be removed (The electrical control box cover remain being hooked on the hinge.).
- Connect the indoor/outdoor connecting wire and remote controller wire to the terminal board of the electrical control box.
- Tighten the screws of the terminal board securely, and fix the wires with the cord clamp attached to the electrical control box. (Do not apply tension to the connecting section of the terminal board.)
- Seal the wiring connecting port with the attached heat insulation material. (Otherwise, this may result in condensation.)
- Attach the cover of the electrical control box without pinching the wires. (Mount the cover after wiring the ceiling panel.)

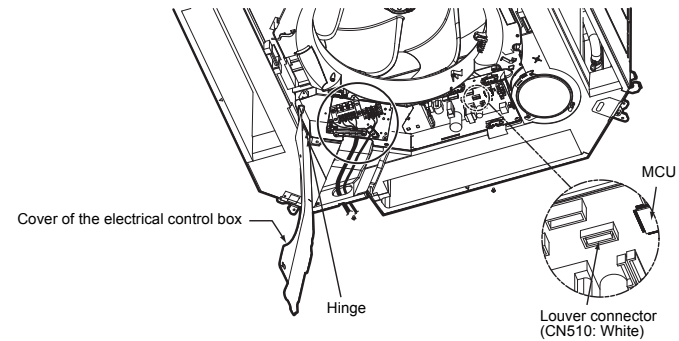
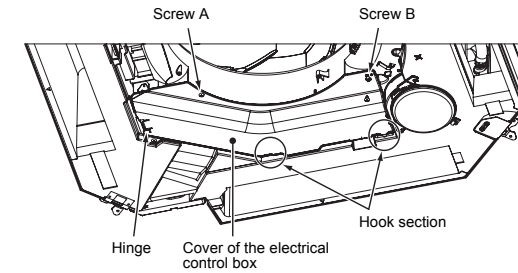



▼ Heat insulation of wiring connecting port

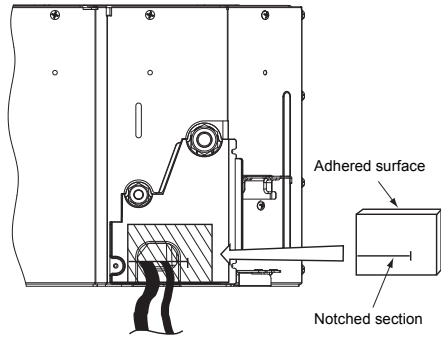

Side D (height: 8.5 mm)

Side C (height: 4 mm)

Power supply terminal board

Remote controller terminal board

Earth screw

Cord clamp

Clamp the power supply cable according to the table below based on the thickness and type.  
 \* The clamp can be mounted on the right or left reverse.  
 Clamp two cables side-by-side for twin connection.

Wire type	Specification	Cable clamping position
Cabtyre cable	4-core stranded wire 2.5 mm <sup>2</sup>	Side D
	4-core stranded wire 1.5 mm <sup>2</sup>	Side C

**GM80, GM110, GM140 type**

1. Remove screw A for the fixation of the electrical control box cover and loosened screw B. Slide the cover inside so that the hook part can be removed (The electrical control box cover remain being hooked on the hinge.)
2. Remove the wiring cover mounting screws (2 locations), and a wiring cover is removed.
3. Connect the indoor/outdoor connecting wire and remote controller wire to the terminal board of the electrical control box.
4. Tighten the screws of the terminal board securely, and fix the wires with the cord clamp attached to the electrical control box. (Do not apply tension to the connecting section of the terminal board.)
5. Seal the clearances of each wiring connecting port with the attached seal material. (Cut the redundant portion of the seal material.)
6. Attach the wiring cover to the original position and fix it with two screws without pinching the wires.
7. Attach the cover of the electrical control box without pinching the wires. (Mount the cover after wiring the ceiling panel.)

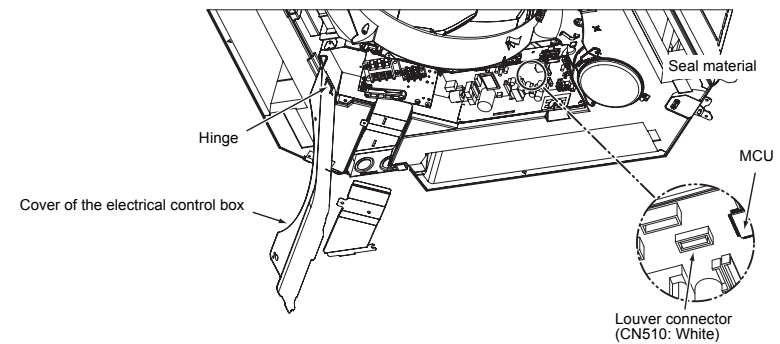
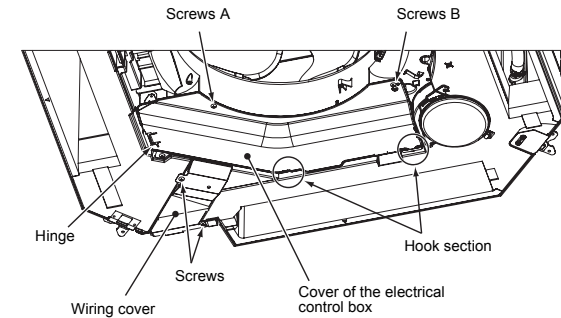

### ▼ Seal material of wiring connecting port

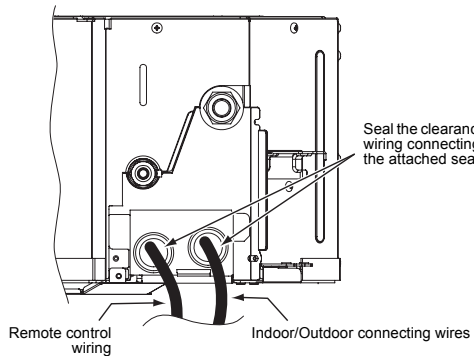

Seal the clearances of each wiring connecting port with the attached seal material.

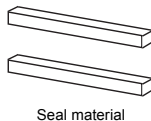

Seal material

Clamp the power supply cable according to the table below based on the thickness and type.  
 \* The clamp can be mounted on the right or left reverse.  
 Clamp two cables side-by-side for twin connection.

Wire type	Specification	Cable clamping position
Cabletyre cable	4-core stranded wire 2.5 mm <sup>2</sup>	Side D
	4-core stranded wire 1.5 mm <sup>2</sup>	Side C

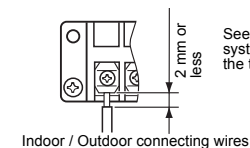
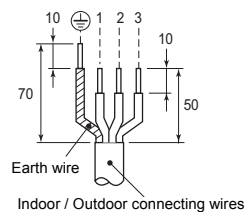
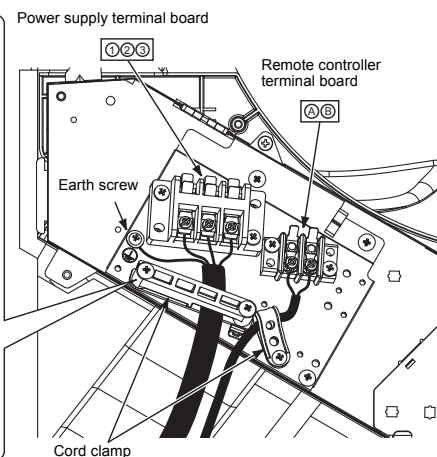

See the figure on the left for system interconnection wires to the terminal block.

### ■ Remote controller wiring

Strip off approx. 9 mm the wire to be connected.

#### Wiring diagram

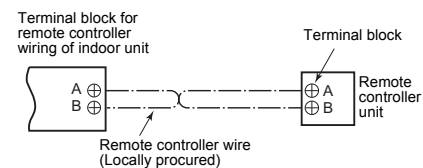

### ■ Wiring on the ceiling panel

As per the Installation Manual of the ceiling panel, connect the connector (20P: White) of the ceiling panel to the connector (CN510: White) onto the P.C. board within the electrical control box.

# 8 Applicable controls

- For using the wired remote controller RBC-AMS55E\*, refer to the Owner's Manual attached to the wired remote controller.

## REQUIREMENT

- When you use this air conditioner for the first time, it takes approx. 5 minutes until the remote controller becomes available after power-on. This is normal.  
**<When power is turned on for the first time after installation>**  
 It takes **approx. 5 minutes** until the remote controller becomes available.

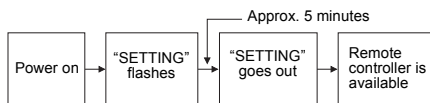

- <When power is turned on for the second (or later) time>**  
 It takes **approx. 1 minute** until the remote controller becomes available.



- Normal settings were made when the indoor unit was shipped from factory. Change the indoor unit settings as required.
- Use the wired remote controller to change the settings.
  - \* The settings cannot be changed using the wireless remote controller, sub remote controller, or remote-controller-less system (for central remote controller only). Therefore, install the wired remote controller to change the settings.

## Basic procedure for changing settings

Change the settings while the air conditioner is not working. **(Stop the air conditioner before making settings.)**

### CAUTION

Set only the CODE No. shown in the following table: Do NOT set any other CODE No. If a CODE No. not listed is set, it may not be possible to operate the air conditioner or other trouble with the product may result.

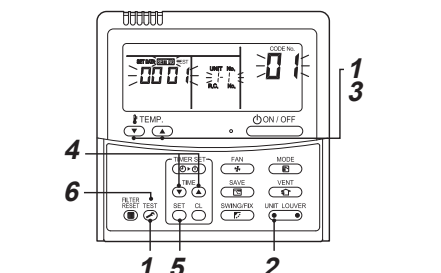

- Push and hold **TEST** button and "TEMP." button simultaneously for at least 4 seconds. After a while, the display flashes as shown in the figure. Confirm that the CODE No. is [01].
  - If the CODE No. is not [01], push **TEST** button to clear the display content, and repeat the procedure from the beginning. (No operation of the remote controller is accepted for a while after button is pushed.)  
 (While air conditioners are operated under the group control, "ALL" is displayed first. When **UNIT LOUVER** is pushed, the indoor unit number displayed following "ALL" is the header unit.)

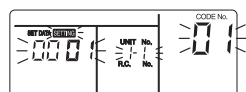

(\* Display content varies with the indoor unit model.)

- Each time **UNIT LOUVER** button is pushed, indoor unit numbers in the control group change cyclically. Select the indoor unit to change settings for.

The fan of the selected unit runs and the louvers start swinging. The indoor unit for change settings can be confirmed.



- Specify CODE No. [\*\*] with "TEMP." button.

- Select SET DATA [\*\*\*\*] with "TIME" button.

- Push **SET** button. When the display changes from flashing to lit, the setup is completed.

- To change settings of another indoor unit, repeat from Procedure 2.
- To change other settings of the selected indoor unit, repeat from Procedure 3.

Use **SET** button to clear the settings. To make settings after **SET** button was pushed, repeat from Procedure 2.

- When settings have been completed, push **TEST** button to determine the settings.

When **TEST** button is pushed, **SETTING** flashes and then the display content disappears and the air conditioner enters the normal stop mode. (While **SETTING** is flashing, no operation of the remote controller is accepted.)

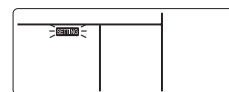

## Installing indoor unit on high ceiling

When an indoor unit is installed on a ceiling higher than the standard height, make the high-ceiling setting for fan speed adjustment.

Follow to the basic operation procedure (1 → 2 → 3 → 4 → 5 → 6).

- For the CODE No. in Procedure 3, specify [5d].
- Select the SET DATA for Procedure 4 from the "Height list of ceiling possible to be installed" table in this manual.

### Remote controller-less setting

Change the high-ceiling setting with the DIP switch on the receiver section P.C. board.

For details, refer to the manual of the wireless remote controller kit. The settings can also be changed with the switch on the indoor microcomputer P.C. board.

- \* Once the setting is changed, setting to 0001 or 0003 is possible, however setting to 0000 requires a setting data change to 0000 using the wired remote controller (separately sold) with the normal switch setting (factory default).

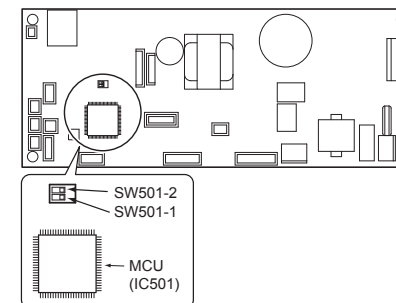

SET DATA	SW501-1	SW501-2
<b>0000</b> (Factory default)	OFF	OFF
<b>0001</b>	ON	OFF
<b>0003</b>	OFF	ON

### To restore the factory defaults

To return the DIP switch settings to the factory defaults, set SW501-1 and SW501-2 to OFF, connect a separately sold wired remote controller, and then set the data of CODE No. [5d] to "0000".

## Filter sign setting

According to the installation condition, the filter sign term (Notification of filter cleaning) can be changed. Follow to the basic operation procedure (1 → 2 → 3 → 4 → 5 → 6).

- For the CODE No. in Procedure 3, specify [01].
- For the [SET DATA] in Procedure 4, select the SET DATA of filter sign term from the following table.

SET DATA	Filter sign term
0000	None
0001	150 H
0002	2500 H (Factory default)
0003	5000 H
0004	10000 H

## To secure better effect of heating

When it is difficult to obtain satisfactory heating due to installation place of the indoor unit or structure of the room, the detection temperature of heating can be raised. Also use a circulator or other device to circulate heat air near the ceiling.

Follow to the basic operation procedure (1 → 2 → 3 → 4 → 5 → 6).

- For the CODE No. in Procedure 3, specify [06].
- For the set data in Procedure 4, select the SET DATA of shift value of detection temperature to be set up from the following table.

SET DATA	Detection temperature shift value
0000	No shift
0001	+1°C
0002	+2°C (Factory default)
0003	+3°C
0004	+4°C
0005	+5°C
0006	+6°C

## How to set up swing type

- Push for at least four seconds when the air conditioner is not working. flashes. Indicates CODE No. [F0].
- Select an indoor unit to be set by pushing (left side of the button). Each time you push the button, unit numbers change as follows:

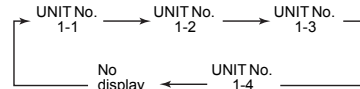

The fan of the selected unit runs and the louvers start swinging.

- Select a swing type by pushing "TIME" buttons.

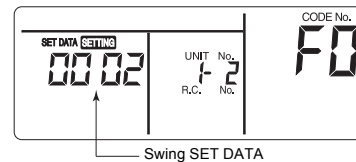

Swing SET DATA	Swing of louvers
0001	Standard swing (Factory default)
0002	Dual swing
0003	Cycle swing

### CAUTION

Do not set the swing SET DATA to "0000".  
(This setting may cause a failure of the louvers.)

- About "Dual swing"**  
"Dual" means that louvers 01 and 03 are directed and swing in one direction and louvers 02 and 04 are directed and swing in the opposite direction. (When louvers 01 and 03 are directed downward, louvers 02 and 04 are directed horizontally.)
- About "Cycle swing"**  
The four louvers swing independently at respective timings.

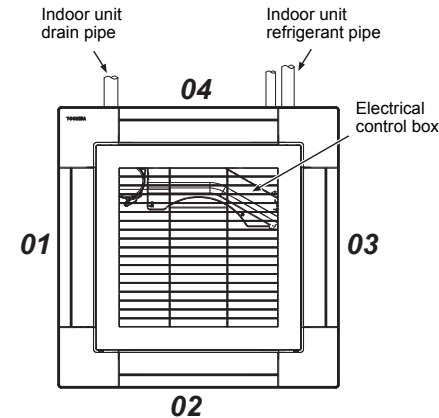

- Push button.
- Push button to complete the setting.

## How to set up louver lock (No swing)

- Push (right side of the button) for at least four seconds when the air conditioner is not working. flashes. Indicates CODE No. [F1].
- Select an indoor unit to be set by pushing (left side of the button). Each time you push the button, unit numbers change as follows: The fan of the selected unit runs and the louvers start swinging.

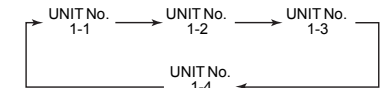

- Select a louver you want to lock by pushing "TEMP." buttons.
- Select the wind direction of the louver you do not want to swing by pushing "TIME" buttons.

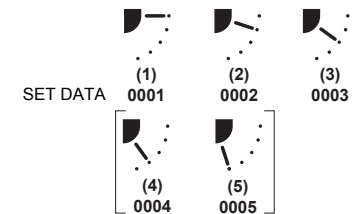

- \* When (4) or (5) is selected, dew drop may occur during cooling mode.
- Determine the setting by pushing button. When the setting has been determined, lights up.
  - Push button to complete the setting.

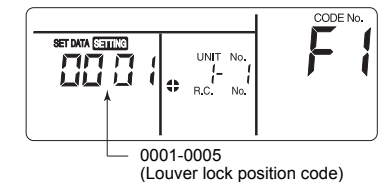

## How to cancel louver lock

Set the wind direction to "0000" of the louver lock setup procedure above.



Setting data 0000

- When the setting is canceled, goes out. Other operations are the same as those in "How to set up louver lock (No swing)".

## Remote controller sensor

The temperature sensor of the indoor unit senses room temperature usually. Set the remote controller sensor to sense the temperature around the remote controller. Select items following the basic operation procedure (1 → 2 → 3 → 4 → 5 → 6).

- Specify [32] for the CODE No. in Procedure 3.
- Select the following data for the SET DATA in Procedure 4.

SET DATA	0000	0001
Remote controller sensor	Not used (factory default)	Used

When flashes, the remote controller sensor is defective.

Select the SET DATA [0000] (not used) or replace the remote controller.

## To select horizontal wind direction

- Push and "TEMP." buttons for at least four seconds when the air conditioner is not working. flashes. Indicates CODE No. [01].
- Select an indoor unit to be set by pushing button (left side of the button). Indoor unit number changes each time you push the button.

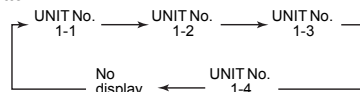

The fan of the selected unit runs and the louvers start swinging.

- Change the CODE No. to [45] with "TEMP." buttons.
- Select wind direction setting with "TIME" buttons.

Wind direction SET DATA	Wind direction setting
0000	Smudge reducing position (Air direction to reduce ceiling contamination) [Factory default]
0002	Cold draftless position (Air direction to control cold air fall)

- Push button to check the setting. The display state changes from flashing to lighting, and the setting is fixed.
  - Push button to end the setting.
- \* When the cold draft position is selected, ceiling contamination is less reduced.

## Power saving mode

### Performing settings of the power saving mode

- Push button for 4 seconds or more when the air conditioner is not working. flashes. Indicates CODE No. [C2.]

- Select an indoor unit to be set by pushing (left side of the button).

Each time the button is pushed, unit numbers change as follows:

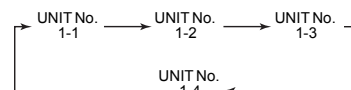

The fan of the selected unit runs.

- Adjust the power save setting by pushing TIME buttons.

Each push of the button changes the power level by 1% within the range from 100% to 50%.

\*The factory default is 75%.

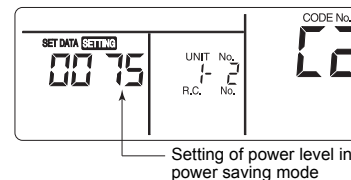

- Determine the setting by pushing button.

- Push button to complete the setting.

## Remote controller switch monitoring function

This function is available to call the service monitor mode from the remote controller during a test run to acquire temperatures of sensors of the remote controller, indoor unit, and outdoor unit.

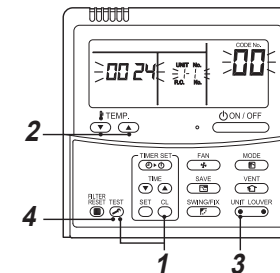

- Push and buttons simultaneously for at least 4 seconds to call the service monitor mode.

The service monitor indicator lights up and the header indoor unit number is displayed first. CODE No. is also displayed.

- Pushing TEMP. buttons, select the number of sensor (CODE No.) to be monitored. (See the following table.)

- Pushing (left side of the button), select an indoor unit to be monitored. The sensor temperatures of indoor units and their outdoor unit in the control group are displayed.

- Push button to return to the normal display.

Indoor unit data	
CODE No.	Data name
01	Room temperature (remote controller)
02	Indoor unit intake air temperature (TA)
03	Indoor unit heat exchanger (coil) temperature (TCJ)
04	Indoor unit heat exchanger (coil) temperature (TC)
F3	Indoor unit fan cumulative operating hours (×1 h)
F8	Indoor unit discharge air temperature

Outdoor unit data	
CODE No.	Data name
60	Outdoor unit heat exchanger (coil) temperature (TE)
61	Outside air temperature (TO)
62	Compressor discharge temperature (TD)
63	Compressor suction temperature (TS)
65	Heatsink temperature (THS)
6A	Operating current (×1/10)
6D	Outdoor heat exchange (coil) temperature (TL)
F1	Compressor cumulative operating hours (×100 h)

## ■ Group control

### Simultaneous twin system

A combination with an outdoor unit allows simultaneous ON / OFF operation of the indoor units.

The following system patterns are available.  
- Two indoor units for the twin system

### ▼ Twin system

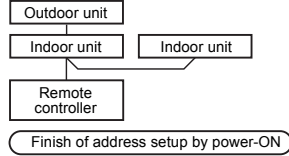

- For wiring procedure and wiring method, follow to the "Electrical connection" in this manual.
  - When the power supply has been turned on, the automatic address setup starts and which indicates that address is being set up flashes on the display part.
- During setup of automatic address, the remote controller operation is not accepted.

**Required time up to the finish of automatic addressing is approx. 5 minutes.**

## Group control for system of multiple units

One remote controller can control maximum 8 indoor units as a group.

### ▼ Group control in single system

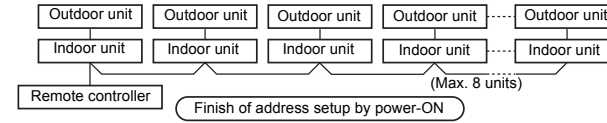

- For wiring procedure and wiring method of the individual line (Identical refrigerant line) system, follow to "Electrical connection".
- Wiring between lines is performed in the following procedure.  
Connect the terminal block (A/B) of the indoor unit connected with a remote controller to the terminal blocks (A/B) of the indoor units of other indoor units by wiring the inter-unit wire of the remote controller.
- When the power supply has been turned on, the automatic address setup starts and which indicates that address is being set up flashes on the display part in about 3 minutes. During setup of automatic address, the remote controller operation is not accepted.

**Required time up to the finish of automatic addressing is approx. 5 minutes.**

### NOTE

In some cases, it is necessary to change the address manually after setup of the automatic address according to the system configuration of the group control.

- The follow mentioned system configuration is a case when complex systems in which systems of the simultaneous twin unit is controlled as a group by a remote controller.

### (Example) Group control for complex system

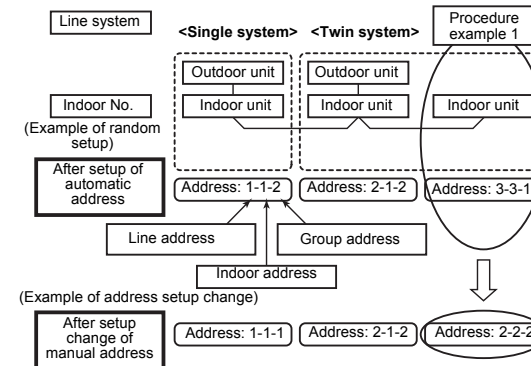

**The above address is set by the automatic addressing when the power is turned on. However, line addresses and indoor addresses are set randomly. For this reason, change the setting to match line addresses with indoor addresses.**

### [Procedure example]

### Manual address setup procedure

While the operation stops, change the setup.  
(Stop the operation of the unit.)

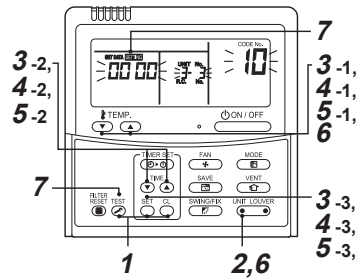

- 1** Push **SET** + **CL** + **TEST** buttons simultaneously for 4 seconds or more. After a while, the display part flashes as shown below. Check the displayed CODE No. is [10].

- When the CODE No. is other than [10], push **TEST** button to erase the display and repeat procedure from the first step.  
(After pushing **TEST** button, operation of the remote controller is not accepted for approx. 1 minute.)  
(For a group control, No. of the firstly displayed indoor unit becomes the header unit.)

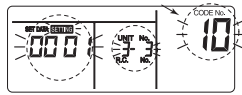

(\* Display changes according to the model No. of indoor unit.)

- 2** Every time **UNIT LOUVER** button is pushed, the indoor UNIT No. in the group control is displayed in order. Select the indoor unit of which setup is changed.

In this time, the position of the indoor unit of which setup is changed can be confirmed because fan of the selected indoor unit operate.

### 3

- Specify CODE No. [12] with TEMP.  $\downarrow$  /  $\uparrow$  buttons.  
(CODE No. [12]: Line address)
- Change the line address from [3] to [2] with TIME  $\downarrow$  /  $\uparrow$  buttons.
- Push **SET** button.  
In this time, the setup finishes when the display changes from flashing to lighting.

Indoor UNIT No. before setup change is displayed.

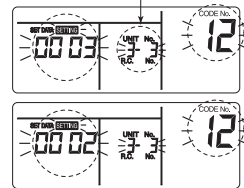

### 4

- Specify CODE No. [13] with TEMP.  $\downarrow$  /  $\uparrow$  buttons.  
(CODE No. [13]: Indoor address)
- Change the indoor address from [3] to [2] TIME  $\downarrow$  /  $\uparrow$  buttons.
- Push **SET** button.  
In this time, the setup finishes when the display changes from flashing to lighting.

Indoor UNIT No. before setup change is displayed.

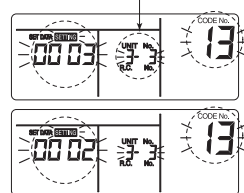

### 5

- Specify CODE No. [14] TEMP.  $\downarrow$  /  $\uparrow$  buttons.  
(CODE No. [14]: Group address)
- Change the SET DATA from [0001] to [0002] TIME  $\downarrow$  /  $\uparrow$  buttons.  
(SET DATA [Header unit: 0001] [Follower unit: 0002])
- Push **SET** button.  
In this time, the setup finishes when the display changes from flashing to lighting.

Indoor UNIT No. before setup change is displayed.

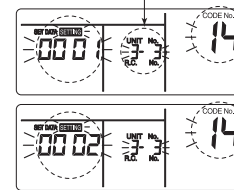

### 6

- If there is other indoor unit to be changed, repeat procedure 2 to 5 to change the setup.  
When the above setup has finished, push **UNIT LOUVER** button to select the indoor UNIT No. before change of setup, specify CODE No. [12], [13], [14] in order with TEMP.  $\downarrow$  /  $\uparrow$  buttons, and then check the changed contents.

Address change check Before change:  
[3-3-1] → After change: [2-2-2]

Pushing **UNIT LOUVER** button clears the contents of which setup was changed.  
(In this case, procedure from 2 is repeated.)

Indoor UNIT No. before setup change is displayed.

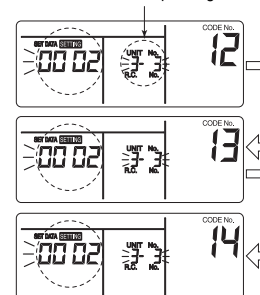

### 7

After check of the changed contents, push **TEST** button. (Setup is determined.) When **TEST** button is pushed, the display disappears and the status becomes the usual stop status. (When **TEST** button is pushed the operation from the remote controller is not accepted for approx. 1 minute.)

- If the operation from the remote controller is not accepted even 1 minute or more passed after pushing **TEST** button, it is considered that the address setup is incorrect.  
In this case, the automatic address must be again set up.  
Therefore repeat procedure of the setup change from the Procedure 1.

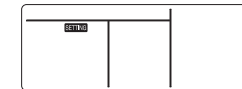

**To recognize the position of the corresponding indoor unit through the indoor UNIT No. is known**

Check the position during operation stop.  
(Stop operation of the set.)

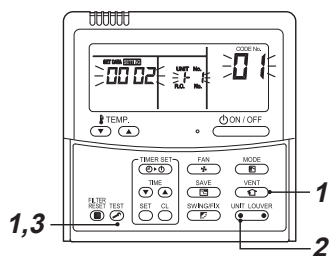

**1 Push TEST + VENT buttons simultaneously for 4 seconds or more.**

After a while, the display part flashes and the display appears as shown below.  
In this time, the position can be checked because fan of the indoor unit operate.

- For the group control, the indoor UNIT No. is displayed as [ALL] and fans of all the indoor units in the group control operate. Check the displayed CODE No. is [01].
- When the CODE No. is other than [01], push TEST button to erase the display and repeat procedure from the first step.  
(After pushing TEST button, operation of the remote controller is not accepted for approx. 1 minute.)

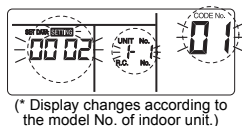

(\* Display changes according to the model No. of indoor unit.)

**2 In the group control, every time UNIT LOUVER button is pushed, the indoor UNIT No. in the group control is displayed in order.**

In this time, the position of the indoor unit can be confirmed because only fan of the selected indoor unit operate.

(For a group control, No. of the firstly displayed indoor unit becomes the header unit.)

**3 After confirmation, push TEST button to return the mode to the usual mode.**

When TEST button is pushed, the display disappears and the status becomes the usual stop status.  
(When TEST button is pushed the operation from the remote controller is not accepted for approx. 1 minute.)

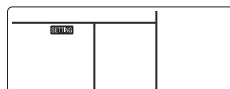

**8°C operation**

Pre-heating operation can be set for cold regions where room temperature drops to below zero.

**1 Push SET + CL + TEST buttons simultaneously for 4 seconds or more when the air conditioner is not working.**

After a while, the display part flashes as shown below. Check the Displayed CODE No. is [10].

- When the CODE No. is other than [10], push TEST button to erase the display and repeat procedure from the first step.  
(After pushing TEST button, operation of the remote controller is not accepted for approx. 1 minute.)

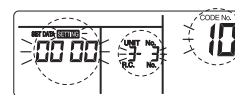

(\* Display changes according to the model No. of indoor unit.)

- 2 Every time UNIT LOUVER button is pushed, the indoor unit No. in the group control is displayed in order. Select the indoor unit of which setup is changed. In this time, the position of the indoor unit of which setup is changed can be confirmed because fan of the selected indoor unit operate.**

**3 Specify CODE No. [d1] TEMP. buttons.**

**4 Select SET DATA [0001] TIME buttons.**

SET DATA	8°C Operation setting
0000	None (Factory default)
0001	8°C Operation setting

**5 Push SET button. In this time, the setup finishes when the display changes from flashing to lighting.**

**6 Push TEST button.(Setup is determined.)**

When TEST button is pushed, the display disappears and the status becomes the usual stop status. (When TEST button is pushed the operation from the remote controller is not accepted for approx. 1 minute.)



# 9 Test run

## ■ Before test run

- Before turning on the power supply, carry out the following procedure.
  - 1) By using 500 V-megger, check that resistance of 1 MΩ or more exists between the terminal block 1 to 3 and the earth (grounding work). If resistance of less than 1 MΩ is detected, do not run the unit.
  - 2) Check the valve of the outdoor unit being opened fully.
- To protect the compressor at activation time, leave power-ON for 12 hours or more before operating.

## ■ Execute a test run

Operate the unit with the wired remote controller as usual.

For the procedure of the operation, refer to the attached Owner's Manual.

A forced test run can be executed in the following procedure even if the operation stops by thermostat-OFF.

In order to prevent a serial operation, the forced test run is released after 60 minutes have passed and returns to the usual operation.

### ⚠ CAUTION

Do not use the forced test run for cases other than the test run because it applies an excessive load to the devices.

## Wired remote controller

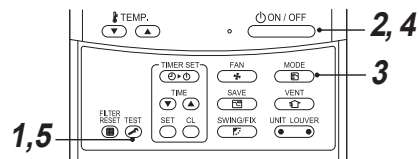

- 1 Push **TEST** button for 4 seconds or more. [TEST] is displayed on the display part and the selection of mode in the test mode is permitted.

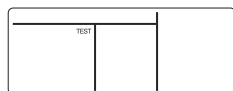

- 2 Push **ON/OFF** button.
- 3 Select the operation mode with button, [Cool] or [Heat].
  - Do not run the air conditioner in a mode other than [Cool] or [Heat].
  - The temperature controlling function does not work during test run.
  - The detection of trouble is performed as usual.

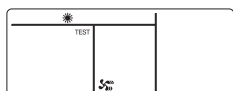

- 4 After the test run, push **ON/OFF** button to stop a test run. (Display part is same as procedure 1.)
- 5 Push **TEST** button to cancel (release from) the test run mode. ([TEST] disappears on the display and the status returns to a normal.)

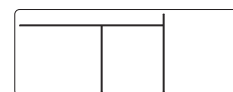

## Wireless remote controller

**Precaution: Test run method in wireless remote controller differs according to the models of indoor units.**

### RBC-AX41U(W)-E

- 1 Turn on the power of the air conditioner. When power is turned on for the first time after installation, it takes approx. 5 minutes until the remote controller becomes available. In the case of subsequent power-on, it takes approx. 1 minute until the remote controller becomes available. Execute a test run after the predetermined time has passed.
- 2 Push "ON/OFF" button on the remote controller, select [Cool] or [Heat] with "MODE" button, and then select [HIGH] with "FAN" button.

Cooling test run	Heating test run
Set the temperature to 17°C with the temp. setup buttons.	Set the temperature to 30°C with the temp. setup buttons.

Cooling test run	Heating test run
After confirming a signal receiving sound "beep" immediately set the temperature to 18°C with the temp. setup buttons.	After confirming a signal receiving sound "beep" immediately set the temperature to 29°C with the temp. setup buttons.

Cooling test run	Heating test run
After confirming a signal receiving sound "beep" immediately set the temperature to 17°C with the temp. setup buttons.	After confirming a signal receiving sound "beep" immediately set the temperature to 30°C with the temp. setup buttons.

- 6 Repeat procedures 4 → 5 → 4 → 5. Indicators "Operation" (green), "Timer" (green), and "Ready" (orange) in the wireless receiver section flash in approx. 10 seconds, and the air conditioner starts operation. If any of these indicators does not flash, repeat procedures 2 to 5.

- 7 Upon completion of the test run, push "ON/OFF" button to stop operation.

<Overview of test run operations using the wireless remote controller>

### ▼ Cooling test run:

ON/OFF → 17°C → 18°C → 17°C → 18°C → 17°C → 18°C → 17°C → (test run) → ON/OFF

### ▼ Heating test run:

ON/OFF → 30°C → 29°C → 30°C → 29°C → 30°C → 29°C → 30°C → (test run) → ON/OFF

## ■ When a test run is not performed properly

When a test run is not performed properly, refer to the check code and the part to be checked on "Troubleshooting".

# 10 Maintenance

## <Daily maintenance>

### ▼ Cleaning of air filter

- If  is displayed on the remote controller, maintain the air filter.

- 1 Push the  button to stop the operation, then turn off the circuit breaker.

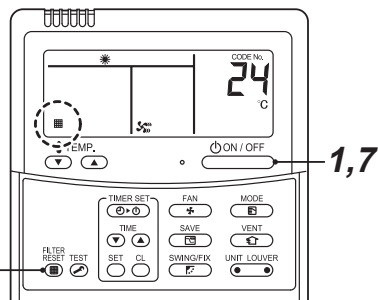

- 2 Open the air intake grille

- Push the corner of the air intake grille and then slide the two hooks toward inside while pushing its corner, hold the air intake grille and open it quietly.

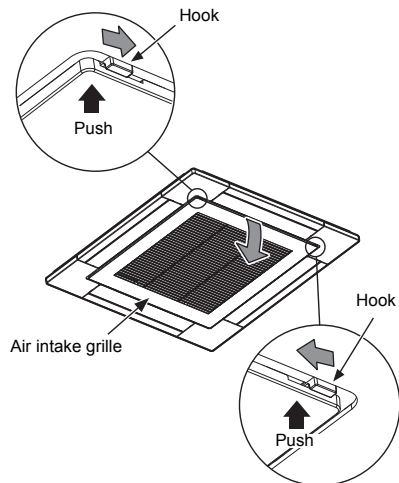

- 3 Remove the air filter

- Push the protruding section of the air filter towards the inside and pull it towards you to remove it.

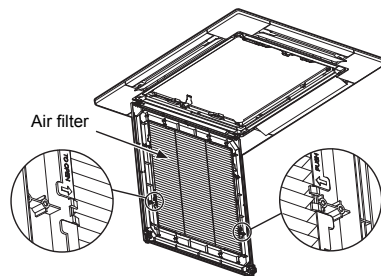

- 4 Suck up the dust with a vacuum cleaner or wash with water

- When the air filter is very dirty, the dirt can be removed effectively by washing with water or lukewarm water dissolved a neutral detergent.





- Dry well in the shade after washing with water.

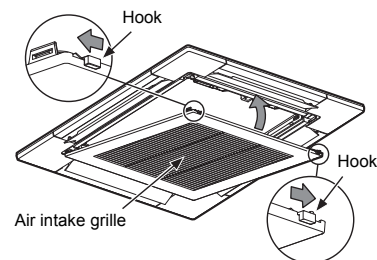

- 5 Attach the air filter

- 6 Close the air intake grille

- Close the air intake grille, slide the two hooks towards the outside, and secure it properly.



- 7 Turn on the circuit breaker, then push the  button on the remote controller to start the operation.

- 8 After cleaning, push .
  -  display disappears.

### ⚠ CAUTION

- Do not start the air conditioner while leaving air filter removed.
- Push the filter reset button. ( indication will be turn off.)

### ▼ Cleaning of discharge louver

- The discharge louver can be removed for cleaning.

- 1** • Remove the corner cap

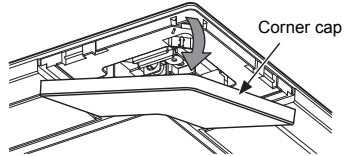

- 2** Remove the discharge louver

- Hold both ends of the discharge louver and deflect the center downwards to remove it.

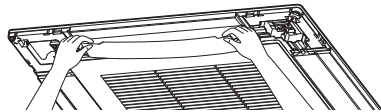

- 3** Wipe with a soft piece of cloth

- Do not wash with water. This will result in a failure.

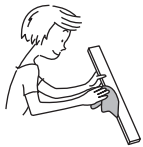

- 4** Mount the discharge louver

- First push in one side and then insert the other side while deflecting the center section downward.

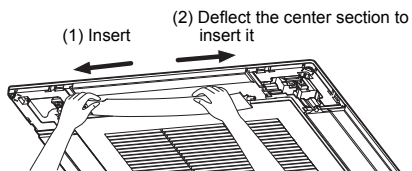

- 5** • First push the claws (2 locations) in the direction of the arrow to insert, push the corner section until it clicks into position, and then push the corner section of the corner cap to install it.

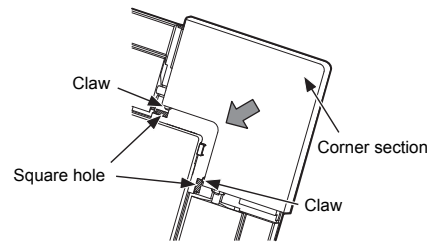

### ▼ Periodic Maintenance

- For environmental conservation, it is strongly recommended that the indoor and outdoor units of the air conditioner in use be cleaned and maintained regularly to ensure efficient operation of the air conditioner. When the air conditioner is operated for a long time, periodic maintenance (once a year) is recommended. Furthermore, regularly check the outdoor unit for rust and scratches, and remove them or apply rustproof treatment, if necessary.

As a general rule, when an indoor unit is operated for 8 hours or more daily, clean the indoor unit and outdoor unit at least once every 3 months. Ask a professional for this cleaning / maintenance work. Such maintenance can extend the life of the product though it involves the owner's expense. Failure to clean the indoor and outdoor units regularly will result in poor performance, freezing, water leakage, and even compressor failure.

### Inspection before maintenance

Following inspection must be carried out by a qualified installer or qualified service person.

Parts	Inspection method
Heat exchanger*	Open the air intake grille to remove the bell mouth and the fan, and then check the heat exchanger if there is any clogging or damages.
Fan motor	Check if any abnormal noise can be heard.
Fan	Open the air intake grille and check the fan if there are any waggles, damages or adhesive dust.
Filter	Open the air intake grille and check if there are any stains or breaks on the filter.
Drain pan*	Remove the panel, the bell mouth and the drain pan, and then check if there is any clogging, abnormal smell or drain water pollution.

\* Refer to the Service Manual for how to remove.

### ▼ Maintenance List

Part	Unit	Check (visual / auditory)	Maintenance
Heat exchanger	Indoor / outdoor	Dust / dirt clogging, scratches	Wash the heat exchanger when it is clogged.
Fan motor	Indoor / outdoor	Sound	Take appropriate measures when abnormal sound is generated.
Filter	Indoor	Dust / dirt, breakage	<ul style="list-style-type: none"> <li>Wash the filter with water when it is contaminated.</li> <li>Replace it when it is damaged.</li> </ul>
Fan	Indoor	<ul style="list-style-type: none"> <li>Vibration, balance</li> <li>Dust / dirt, appearance</li> </ul>	<ul style="list-style-type: none"> <li>Replace the fan when vibration or balance is terrible.</li> <li>Brush or wash the fan when it is contaminated.</li> </ul>
Air intake / discharge grilles	Indoor / outdoor	Dust / dirt, scratches	Fix or replace them when they are deformed or damaged.
Drain pan	Indoor	Dust / dirt clogging, drain contamination	Clean the drain pan and check the downward slope for smooth drainage.
Ceiling panel, louvres	Indoor	Dust / dirt, scratches	Wash them when they are contaminated or apply repair coating.
Exterior	Outdoor	<ul style="list-style-type: none"> <li>Rust, peeling of insulator</li> <li>Peeling / lift of coat</li> </ul>	Apply repair coating.

# 11 Troubleshooting

## Confirmation and check

When a problem occurred in the air conditioner, the check code and indoor UNIT No. appear on the display part of the remote controller.

The check code is only displayed during the operation. If the display disappears, operate the air conditioner according to the following "Confirmation of check code" for confirmation.

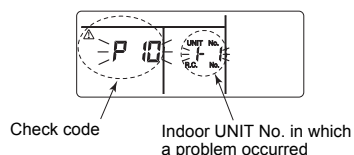

## Confirmation of check code

When a problem occurred on the air conditioner, the check code can be confirmed with the following procedure. (The check code is stored in memory up to 4 check codes.)

The check code can be confirmed from both operating status and stop status.

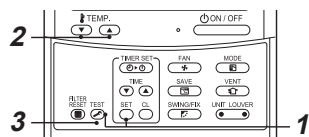

**1** When **SET** and **TEST** buttons are pushed simultaneously for 4 seconds or more, the following display appears.

If **P** is displayed, the mode enters in the check code mode.

- [01: Order of check code] is displayed in CODE No..
- [Check code] is displayed in CHECK.
- [Indoor unit address in which a problem occurred] is displayed in Unit No..

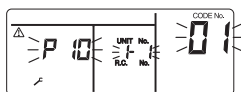

**2** Every pushing of **TEMP.** button used to set temperature, the check code stored in memory is displayed in order.

The numbers in CODE No. indicate CODE No. [01] (latest) → [04] (oldest).

### REQUIREMENT

Do not push **CL** button because all the check code of the indoor unit will be deleted.

**3** After confirmation, push **TEST** button to return to the usual display.

## Check codes and parts to be checked

Wired remote controller display	Wireless remote controller Sensor block display of receiving unit		Main defective parts	Judging device	Parts to be checked / trouble description	Air conditioner status
	Indication	Operation Timer Ready GR GR OR				
E01	◎ ● ●		No header remote controller Remote controller communication trouble	Remote controller	Incorrect remote controller setting --- The header remote controller has not been set (including two remote controllers). No signal can be received from the indoor unit.	*
E02	◎ ● ●		Remote controller transmission trouble	Remote controller	Indoor / outdoor connecting wires, indoor P.C. board, remote controller --- No signal can be sent to the indoor unit.	*
E03	◎ ● ●		Indoor unit-remote controller regular communication trouble	Indoor	Remote controller, network adapter, indoor P.C. board --- No data is received from the remote controller or network adapter.	Auto-reset
E04	● ● ◎		Indoor unit-outdoor unit serial communication trouble IPDU-CDB communication trouble	Indoor	Indoor / outdoor connecting wires, indoor P.C. board, outdoor P.C. board --- Serial communication trouble between indoor unit and outdoor unit	Auto-reset
E08	◎ ● ●		Duplicated indoor addresses ★	Indoor	Indoor address setting trouble --- The same address as the self-address was detected.	Auto-reset
E09	◎ ● ●		Duplicated header remote controllers	Remote controller	Remote controller address setting trouble --- Two remote controllers are set as header in the double-remote controller control. (* The header indoor unit stops raising alarm and follower indoor units continue to operate.)	*
E10	◎ ● ●		CPU-CPU communication trouble	Indoor	Indoor P.C. board --- Communication trouble between main MCU and motor microcomputer MCU	Auto-reset
E11	◎ ● ●		Communication trouble between Application control kit and Indoor unit	Indoor	Communication trouble between Application control kit and Indoor unit	Entire stop
E18	◎ ● ●		Header unit follower unit regular communication trouble	Indoor	Indoor P.C. board --- Regular communication is not possible between header and follower indoor units or between twin header (main) and follower (sub) units.	Auto-reset
E31	● ● ◎		IPDU communication trouble	Outdoor	Communication trouble between IPDU and CDB	Entire stop
F01	◎ ◎ ●	ALT	Indoor unit heat exchanger sensor (TCJ) trouble	Indoor	Heat exchanger sensor (TCJ), indoor P.C. board --- Open-circuit or short-circuit of the heat exchanger sensor (TCJ) was detected.	Auto-reset
F02	◎ ◎ ●	ALT	Indoor unit heat exchanger sensor (TC) trouble	Indoor	Heat exchanger sensor (TC), indoor P.C. board --- Open-circuit or short-circuit of the heat exchanger sensor (TC) was detected.	Auto-reset
F04	◎ ◎ ○	ALT	Outdoor unit discharge temp. sensor (TD) trouble	Outdoor	Outdoor temp. sensor (TD), outdoor P.C. board --- Open-circuit or short-circuit of the discharge temp. sensor was detected.	Entire stop
F06	◎ ◎ ○	ALT	Outdoor unit temp. sensor (TE / TS) trouble	Outdoor	Outdoor temp. sensors (TE / TS), outdoor P.C. board --- Open-circuit or short-circuit of the heat exchanger temp. sensor was detected.	Entire stop
F07	◎ ◎ ○	ALT	TL sensor trouble	Outdoor	TL sensor may be displaced, disconnected or short-circuited.	Entire stop
F08	◎ ◎ ○	ALT	Outdoor unit outside air temp. sensor trouble	Outdoor	Outdoor temp. sensor (TO), outdoor P.C. board --- Open-circuit or short-circuit of the outdoor air temp. sensor was detected.	Operation continued
F10	◎ ◎ ●	ALT	Indoor unit room temp. sensor (TA) trouble	Indoor	Room temp. sensor (TA), indoor P.C. board --- Open-circuit or short-circuit of the room temp. sensor (TA) was detected.	Auto-reset

Wired remote controller display	Wireless remote controller Sensor block display of receiving unit		Main defective parts	Judging device	Parts to be checked / trouble description	Air conditioner status
	Indication	Operation Timer Ready GR GR OR				
F12	⊙ ⊙ ○	ALT	TS sensor trouble	Outdoor	TS sensor may be displaced, disconnected or short-circuited.	Entire stop
F13	⊙ ⊙ ○	ALT	Heat sink sensor trouble	Outdoor	Abnormal temperature was detected by the temp. sensor of the IGBT heat sink.	Entire stop
F15	⊙ ⊙ ○	ALT	Temp. sensor connection trouble	Outdoor	Temp. sensor (TE / TS) may be connected incorrectly.	Entire stop
F29	⊙ ⊙ ●	SIM	Indoor unit, other P.C. board trouble	Indoor	Indoor P.C. board --- EEPROM trouble	Auto-reset
F30	⊙ ⊙ ○	SIM	Occupancy sensor trouble	Indoor	Abnormality was detected from occupancy sensor.	Operation continued
F31	⊙ ⊙ ○	SIM	Outdoor unit P.C. board	Outdoor	Outdoor P.C. board ---- In the case of EEPROM trouble.	Entire stop
H01	● ⊙ ●		Outdoor unit compressor breakdown	Outdoor	Current detect circuit, power voltage --- Minimum frequency was reached in the current releasing control or short-circuit current (Idc) after direct excitation was detected	Entire stop
H02	● ⊙ ●		Outdoor unit compressor lock	Outdoor	Compressor circuit --- Compressor lock was detected.	Entire stop
H03	● ⊙ ●		Outdoor unit current detect circuit trouble	Outdoor	Current detect circuit, outdoor unit P.C. board --- Abnormal current was detected in AC-CT or a phase loss was detected.	Entire stop
H04	● ⊙ ●		Case thermostat operation	Outdoor	Malfunction of the case thermostat	Entire stop
H06	● ⊙ ●		Outdoor unit low-pressure system trouble	Outdoor	Current, high-pressure switch circuit, outdoor P.C. board --- Pressure sensor trouble was detected or low-pressure protective operation was activated.	Entire stop
L03	⊙ ● ⊙	SIM	Duplicated header indoor units ★	Indoor	Indoor address setting trouble --- There are two or more header units in the group.	Entire stop
L07	⊙ ● ⊙	SIM	Group line in individual indoor unit ★	Indoor	Indoor address setting trouble --- There is at least one group-connected indoor unit among individual indoor units.	Entire stop
L08	⊙ ● ⊙	SIM	Indoor group address not set ★	Indoor	Indoor address setting trouble --- Indoor address group has not been set.	Entire stop
L09	⊙ ● ⊙	SIM	Indoor unit capacity not set	Indoor	Indoor unit capacity has not been set.	Entire stop
L10	⊙ ○ ⊙	SIM	Outdoor unit P.C. board	Outdoor	In the case of outdoor P.C. board jumper wire (for service) setting trouble	Entire stop
L20	⊙ ○ ⊙	SIM	LAN communication trouble	Network adapter central control	Address setting, central control remote controller, network adapter --- Duplication of address in central control communication	Auto-reset
L29	⊙ ○ ⊙	SIM	Other outdoor unit trouble	Outdoor	Other outdoor unit trouble	Entire stop
					1) Communication trouble between IPDU MCU and CDB MCU	Entire stop
					2) Abnormal temperature was detected by the heat sink temp. sensor in IGBT.	Entire stop
L30	⊙ ○ ⊙	SIM	Abnormal external input into indoor unit (interlock)	Indoor	External devices, outdoor unit P.C. board --- Abnormal stop due to incorrect external input into CN80	Entire stop
L31	⊙ ○ ⊙	SIM	Phase sequence trouble, etc.	Outdoor	Power supply phase sequence, outdoor unit P.C. board --- Abnormal phase sequence of the 3-phase power supply	Operation continued (thermostat at OFF)
P01	● ⊙ ⊙	ALT	Indoor unit fan trouble	Indoor	Indoor fan motor, indoor P.C. board --- Indoor AC fan trouble (fan motor thermal relay activated) was detected.	Entire stop
P03	⊙ ● ⊙	ALT	Outdoor unit discharge temp. trouble	Outdoor	An trouble was detected in the discharge temp. releasing control.	Entire stop

Wired remote controller display	Wireless remote controller Sensor block display of receiving unit		Main defective parts	Judging device	Parts to be checked / trouble description	Air conditioner status
	Indication	Operation Timer Ready GR GR OR				
P04	⊙ ● ⊙	ALT	Outdoor unit high-pressure system trouble	Outdoor	High-pressure switch --- The IOL was activated or an trouble was detected in the high-pressure releasing control using the TE.	Entire stop
P05	⊙ ● ⊙	ALT	Open phase detected	Outdoor	The power wire may be connected incorrectly. Check open phase and voltages of the power supply.	Entire stop
P07	⊙ ● ⊙	ALT	Heat sink overheat	Outdoor	Abnormal temperature was detected by the temp. sensor of the IGBT heat sink.	Entire stop
P10	● ⊙ ⊙	ALT	Indoor unit water overflow detected	Indoor	Drain pipe, clogging of drainage, float switch circuit, indoor P.C. board --- Drainage is out of order or the float switch was activated.	Entire stop
P12	● ⊙ ⊙	ALT	The fan trouble of the indoor unit	Indoor	Abnormal operation of the indoor fan motor, indoor P.C. board, or indoor DC fan (over current or lock, etc.) is detected.	Entire stop
P15	⊙ ● ⊙	ALT	Gas leakage detected	Outdoor	There may be gas leakage from the pipe or connecting part. Check for gas leakage.	Entire stop
P19	⊙ ● ⊙	ALT	4-way valve trouble	Outdoor (Indoor)	4-way valve, indoor temp. sensors (TC / TCJ) --- An trouble was detected due to temperature drop of the indoor unit heat exchanger sensor when heating.	Auto-reset
P20	⊙ ● ⊙	ALT	High-pressure protective operation	Outdoor	High-pressure protection	Entire stop
P22	⊙ ● ⊙	ALT	Outdoor unit fan trouble	Outdoor	Outdoor unit fan motor, outdoor unit P.C. board --- An trouble (overcurrent, locking, etc.) was detected in the outdoor unit fan drive circuit.	Entire stop
P26	⊙ ● ⊙	ALT	Outdoor unit inverter Idc activated	Outdoor	IGBT, outdoor unit P.C. board, inverter wiring, compressor --- Short-circuit protection for compressor drive circuit devices (G-Tr / IGBT) was activated.	Entire stop
P29	⊙ ● ⊙	ALT	Outdoor unit position trouble	Outdoor	Outdoor unit P.C. board, high-pressure switch --- Compressor motor position trouble was detected.	Entire stop
P31	⊙ ● ⊙	ALT	Other indoor unit trouble	Indoor	Another indoor unit in the group is raising an alarm.	Entire stop
					E03/L07/L03/L08 alarm check locations and trouble description	Auto-reset

○ : Lighting ⊙ : Flashing ● : OFF ★ : The air conditioner automatically enters the auto-address setting mode.  
ALT: When two LEDs are flashing, they flash alternately. SIM: When two LEDs are flashing, they flash in synchronization.  
Receiving unit display OR: Orange GR: Green

**TOSHIBA CARRIER CORPORATION**

336 TADEHARA, FUJI-SHI, SHIZUOKA-KEN 416-8521 JAPAN

**EB99819501**