

# TOSHIBA

Leading Innovation >>>

*AIR CONDITIONER (SPLIT TYPE)*  
**Installation Manual**

Outdoor Unit

Model name: \_\_\_\_\_

**RAV-GP561ATP-E**  
**RAV-GP561ATJP-E**

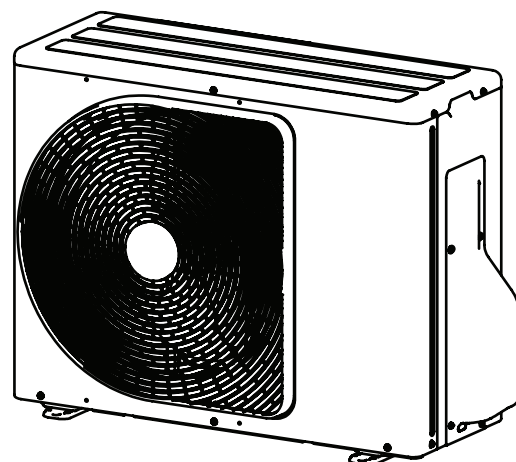

**R32**

For commercial use

English

Original instruction

**ADOPTION OF R32 REFRIGERANT**

This air conditioner adopts the HFC refrigerant (R32) which does not destroy the ozone layer.  
This outdoor unit is designed exclusively for use with R32 refrigerant. Be sure to use in combination with a R32 refrigerant indoor unit.

## Contents

1	Precautions for safety .....	5
2	Accessory parts .....	10
3	Installation of R32 refrigerant air conditioner .....	10
4	Installation conditions .....	11
5	Refrigerant piping .....	14
6	Air purging .....	16
7	Electrical work .....	18
8	Earthing .....	19
9	Finishing .....	19
10	Test run .....	19
11	Annual maintenance .....	19
12	Air conditioner operating conditions .....	20
13	Functions to be implemented locally .....	20
14	Troubleshooting .....	22
15	Appendix .....	23
16	Specifications .....	25

Thank you for purchasing this Toshiba air conditioner.

Please read carefully through these instructions that contain important information which complies with the Machinery Directive (Directive 2006/42/EC), and ensure that you understand them.

After reading these instructions, be sure to keep them in a safe place together with the Owner's Manual and Installation Manual supplied with your product.

### Generic Denomination: Air Conditioner

#### Definition of Qualified Installer or Qualified Service Person

The air conditioner must be installed, maintained, repaired and removed by a qualified installer or qualified service person. When any of these jobs is to be done, ask a qualified installer or qualified service person to do them for you. A qualified installer or qualified service person is an agent who has the qualifications and knowledge described in the table below.

Agent	Qualifications and knowledge which the agent must have
Qualified installer	<ul style="list-style-type: none"> <li>• The qualified installer is a person who installs, maintains, relocates and removes the air conditioners made by Toshiba Carrier Corporation. He or she has been trained to install, maintain, relocate and remove the air conditioners made by Toshiba Carrier Corporation or, alternatively, he or she has been instructed in such operations by an individual or individuals who have been trained and is thus thoroughly acquainted with the knowledge related to these operations.</li> <li>• The qualified installer who is allowed to do the electrical work involved in installation, relocation and removal has the qualifications pertaining to this electrical work as stipulated by the local laws and regulations, and he or she is a person who has been trained in matters relating to electrical work on the air conditioners made by Toshiba Carrier Corporation or, alternatively, he or she has been instructed in such matters by an individual or individuals who have been trained and is thus thoroughly acquainted with the knowledge related to this work.</li> <li>• The qualified installer who is allowed to do the refrigerant handling and piping work involved in installation, relocation and removal has the qualifications pertaining to this refrigerant handling and piping work as stipulated by the local laws and regulations, and he or she is a person who has been trained in matters relating to refrigerant handling and piping work on the air conditioners made by Toshiba Carrier Corporation or, alternatively, he or she has been instructed in such matters by an individual or individuals who have been trained and is thus thoroughly acquainted with the knowledge related to this work.</li> <li>• The qualified installer who is allowed to work at heights has been trained in matters relating to working at heights with the air conditioners made by Toshiba Carrier Corporation or, alternatively, he or she has been instructed in such matters by an individual or individuals who have been trained and is thus thoroughly acquainted with the knowledge related to this work.</li> </ul>

Qualified service person	<ul style="list-style-type: none"> <li>• The qualified service person is a person who installs, repairs, maintains, relocates and removes the air conditioners made by Toshiba Carrier Corporation. He or she has been trained to install, repair, maintain, relocate and remove the air conditioners made by Toshiba Carrier Corporation or, alternatively, he or she has been instructed in such operations by an individual or individuals who have been trained and is thus thoroughly acquainted with the knowledge related to these operations.</li> <li>• The qualified service person who is allowed to do the electrical work involved in installation, repair, relocation and removal has the qualifications pertaining to this electrical work as stipulated by the local laws and regulations, and he or she is a person who has been trained in matters relating to electrical work on the air conditioners made by Toshiba Carrier Corporation or, alternatively, he or she has been instructed in such matters by an individual or individuals who have been trained and is thus thoroughly acquainted with the knowledge related to this work.</li> <li>• The qualified service person who is allowed to do the refrigerant handling and piping work involved in installation, repair, relocation and removal has the qualifications pertaining to this refrigerant handling and piping work as stipulated by the local laws and regulations, and he or she is a person who has been trained in matters relating to refrigerant handling and piping work on the air conditioners made by Toshiba Carrier Corporation or, alternatively, he or she has been instructed in such matters by an individual or individuals who have been trained and is thus thoroughly acquainted with the knowledge related to this work.</li> <li>• The qualified service person who is allowed to work at heights has been trained in matters relating to working at heights with the air conditioners made by Toshiba Carrier Corporation or, alternatively, he or she has been instructed in such matters by an individual or individuals who have been trained and is thus thoroughly acquainted with the knowledge related to this work.</li> </ul>
--------------------------	--

### Definition of Protective Gear

When the air conditioner is to be transported, installed, maintained, repaired or removed, wear protective gloves and "safety" work clothing.

In addition to such normal protective gear, wear the protective gear described below when undertaking the special work detailed in the table below.

Failure to wear the proper protective gear is dangerous because you will be more susceptible to injury, burns, electric shocks and other injuries.

Work undertaken	Protective gear worn
All types of work	Protective gloves 'Safety' working clothing
Electrical-related work	Gloves to provide protection for electricians Insulating shoes Clothing to provide protection from electric shock
Work done at heights (50 cm or more)	Helmets for use in industry
Transportation of heavy objects	Shoes with additional protective toe cap
Repair of outdoor unit	Gloves to provide protection for electricians

### ■ Center of gravity

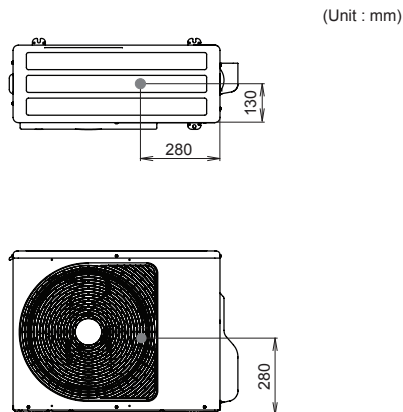







These safety cautions describe important matters concerning safety to prevent injury to users or other people and damages to property. Please read through this manual after understanding the contents below (meanings of indications), and be sure to follow the description.



Indication	Meaning of Indication
<b>WARNING</b>	Text set off in this manner indicates that failure to adhere to the directions in the warning could result in serious bodily harm (*1) or loss of life if the product is handled improperly.
<b>CAUTION</b>	Text set off in this manner indicates that failure to adhere to the directions in the caution could result in slight injury (*2) or damage (*3) to property if the product is handled improperly.

- \*1: Serious bodily harm indicates loss of eyesight, injury, burns, electric shock, bone fracture, poisoning, and other injuries which leave aftereffect and require hospitalization or long-term treatment as an outpatient.
- \*2: Slight injury indicates injury, burns, electric shock, and other injuries which do not require hospitalization or long-term treatment as an outpatient.
- \*3: Damage to property indicates damage extending to buildings, household effects, domestic livestock, and pets.

■ Warning indications on the air conditioner unit

	<b>WARNING</b> (Risk of fire)	This mark is for R32 refrigerant only. Refrigerant type is written on nameplate of outdoor unit. In case that refrigerant type is R32, this unit uses a flammable refrigerant. If refrigerant leaks and comes in contact with fire or heating part, it will create harmful gas and there is risk of fire.
	Read the OWNER'S MANUAL carefully before operation.	
	Service personnel are required to carefully read the OWNER'S MANUAL and INSTALLATION MANUAL before operation.	
	Further information is available in the OWNER'S MANUAL, INSTALLATION MANUAL, and the like.	

Warning indication	Description		
 <table border="1"> <tr> <td><b>WARNING</b></td> </tr> <tr> <td><b>ELECTRICAL SHOCK HAZARD</b> Disconnect all remote electric power supplies before servicing.</td> </tr> </table>	<b>WARNING</b>	<b>ELECTRICAL SHOCK HAZARD</b> Disconnect all remote electric power supplies before servicing.	<b>WARNING</b>  <b>ELECTRICAL SHOCK HAZARD</b> Disconnect all remote electric power supplies before servicing.
<b>WARNING</b>			
<b>ELECTRICAL SHOCK HAZARD</b> Disconnect all remote electric power supplies before servicing.			
 <table border="1"> <tr> <td><b>WARNING</b></td> </tr> <tr> <td>Moving parts. Do not operate unit with grille removed. Stop the unit before the servicing.</td> </tr> </table>	<b>WARNING</b>	Moving parts. Do not operate unit with grille removed. Stop the unit before the servicing.	<b>WARNING</b>  <b>Moving parts.</b> Do not operate unit with grille removed. Stop the unit before the servicing.
<b>WARNING</b>			
Moving parts. Do not operate unit with grille removed. Stop the unit before the servicing.			
 <table border="1"> <tr> <td><b>CAUTION</b></td> </tr> <tr> <td>High temperature parts. You might get burned when removing this panel.</td> </tr> </table>	<b>CAUTION</b>	High temperature parts. You might get burned when removing this panel.	<b>CAUTION</b>  High temperature parts. You might get burned when removing this panel.
<b>CAUTION</b>			
High temperature parts. You might get burned when removing this panel.			

 <table border="1"> <tr> <td><b>CAUTION</b></td> </tr> <tr> <td>Do not touch the aluminum fins of the unit. Doing so may result in injury.</td> </tr> </table>	<b>CAUTION</b>	Do not touch the aluminum fins of the unit. Doing so may result in injury.	<b>CAUTION</b>  Do not touch the aluminium fins of the unit. Doing so may result in injury.
<b>CAUTION</b>			
Do not touch the aluminum fins of the unit. Doing so may result in injury.			
 <table border="1"> <tr> <td><b>CAUTION</b></td> </tr> <tr> <td><b>BURST HAZARD</b> Open the service valves before the operation, otherwise there might be the burst.</td> </tr> </table>	<b>CAUTION</b>	<b>BURST HAZARD</b> Open the service valves before the operation, otherwise there might be the burst.	<b>CAUTION</b>  <b>BURST HAZARD</b> Open the service valves before the operation, otherwise there might be the burst.
<b>CAUTION</b>			
<b>BURST HAZARD</b> Open the service valves before the operation, otherwise there might be the burst.			

# 1 Precautions for safety

The manufacturer shall not assume any liability for the damage caused by not observing the description of this manual.

## WARNING

### General

- Before starting to install the air conditioner, read carefully through the Installation Manual, and follow its instructions to install the air conditioner.
- Only a qualified installer(\*1) or qualified service person(\*1) is allowed to install the air conditioner. If the air conditioner is installed by an unqualified individual, a fire, electric shocks, injury, water leakage, noise and/or vibration may result.
- Do not use any refrigerant different from the one specified for complement or replacement. Otherwise, abnormally high pressure may be generated in the refrigeration cycle, which may result in a failure or explosion of the product or an injury to your body.
- When transporting the air conditioner, use a forklift and when moving the air conditioner by hand, move the unit with 4 people.
- Before opening the intake grille of the indoor unit or service panel of the outdoor unit, set the circuit breaker to the OFF position. Failure to set the circuit breaker to the OFF position may result in electric shocks through contact with the interior parts. Only a qualified installer(\*1) or qualified service person(\*1) is allowed to remove the intake grille of the indoor unit or service panel of the outdoor unit and do the work required.
- Before carrying out the installation, maintenance, repair or removal work, be sure to set the circuit breaker to the OFF position. Otherwise, electric shocks may result.
- Place a “Work in progress” sign near the circuit breaker while the installation, maintenance, repair or removal work is being carried out. There is a danger of electric shocks if the circuit breaker is set to ON by mistake.
- Only a qualified installer(\*1) or qualified service person(\*1) is allowed to undertake work at heights using a stand of 50 cm or more.
- Wear protective gloves and safety work clothing during installation, servicing and removal.
- Do not touch the aluminum fin of the outdoor unit. You may injure yourself if you do so. If the fin must be touched for some reason, first put on protective gloves and safety work clothing, and then proceed.
- Do not climb onto or place objects on top of the outdoor unit. You may fall or the objects may fall off of the outdoor unit and result in injury.
- When working at heights, use a ladder which complies with the ISO 14122 standard, and follow the procedure in the ladder’s instructions. Also wear a helmet for use in industry as protective gear to undertake the work.
- When cleaning the filter or other parts of the outdoor unit, set the circuit breaker to OFF without fail, and place a “Work in progress” sign near the circuit breaker before proceeding with the work.
- When working at heights, put a sign in place so that no-one will approach the work location, before proceeding with the work. Parts and other objects may fall from above, possibly injuring a person below.
- You shall ensure that the air conditioner is transported in stable condition. If any part of the product is broken, contact the dealer.
- Do not modify the products. Do not also disassemble or modify the parts. It may cause a fire, electric shock or injury.
- This appliance is intended to be used by expert or trained users in shops, in light industry, or for commercial use by lay persons.

## About the refrigerant

- This product contains fluorinated greenhouse gases.
- Do not vent gases to the atmosphere.
- The appliance shall be stored in a room without continuously operating ignition sources (for example: open flames, an operating gas appliance or an operating electric heater).
- Do not pierce or burn refrigerant cycle parts.
- Do not use means to accelerate the defrosting process or to clean, other than those recommended by the manufacturer.
- Be aware that refrigerants may not contain an odour.
- The refrigerant inside the unit is flammable. If the refrigerant leaks in the room and comes in contact with fire from a burner, a heater, or a cooker, it may result in fire or the formation of a harmful gas.
- Turn off any combustible heating devices, ventilate the room, and contact the dealer from which you purchased the unit.
- Do not use the unit until a service person confirms that the portion from which the refrigerant leaked is repaired.
- When installing, relocating, or servicing the air conditioner, use only the specified refrigerant (R32) to charge the refrigerant lines. Do not mix it with any other refrigerant and do not allow air to remain in the lines.
- Pipe-work shall be protected from physical damage.
- Compliance with national gas regulations shall be observed.

## Selection of installation location

- If you install the unit in a small room, take appropriate measures to prevent the refrigerant from exceeding the limit concentration even if it leaks. Consult the dealer from whom you purchased the air conditioner when you implement the measures. Accumulation of highly concentrated refrigerant may cause an oxygen deficiency accident.
- Do not install the air conditioner in a location that may be subject to a risk of exposure to a combustible gas. If a combustible gas leaks and becomes concentrated around the unit, a fire may occur.
- When transporting the air conditioner, wear shoes with additional protective toe caps.
- When transporting the air conditioner, do not take hold of the bands around the packing carton. You may injure yourself if the bands should break.
- Do not place any combustion appliance in a place where it is directly exposed to the wind of air conditioner, otherwise it may cause imperfect combustion.
- Do not install the air conditioner in a poorly ventilated space that is smaller than the minimum floor area ( $A_{\min}$ ).

This applies to:

- Indoor units
- Outdoor units installed  
(example: winter garden, garage, machinery room, etc)

Refer to “15 Appendix - [2] Minimum floor area:  $A_{\min}$  (m<sup>2</sup>)” to determine the minimum floor area.

## Installation

- Install the air conditioner at enough strong places to withstand the weight of the unit. If the strength is not enough, the unit may fall down resulting in injury.
- Follow the instructions in the Installation Manual to install the air conditioner. Failure to follow these instructions may cause the product to fall down or topple over or give rise to noise, vibration, water leakage, etc.
- The designated bolts (M10) and nuts (M10) for securing the outdoor unit must be used when installing the unit.
- Install the outdoor unit properly in a location that is durable enough to support the weight of the outdoor unit. Insufficient durability may cause the outdoor unit to fall, which may result in injury.
- If refrigerant gas has leaked during the installation work, ventilate the room immediately. If the leaked refrigerant gas comes in contact with fire, noxious gas may be generated.
- The installation of pipe work shall be kept to a minimum.

## Refrigerant piping

- Install the refrigerant pipe securely during the installation work before operating the air conditioner. If the compressor is operated with the valve open and without refrigerant pipe, the compressor sucks air and the refrigeration cycles is over pressurized, which may cause a injury.
- Tighten the flare nut with a torque wrench in the specified manner. Excessive tighten of the flare nut may cause a crack in the flare nut after a long period, which may result in refrigerant leakage.

- For installation and relocation work, follow the instructions in the Installation Manual and use tools and pipe components specifically made for use with R32 refrigerant. If pipe components not designed for R32 refrigerant are used and the unit is not installed correctly, the pipes may burst and cause damage or injuries. In addition, water leakage, electric shock, or fire may result.
- Nitrogen gas must be used for the airtight test.
- The charge hose must be connected in such a way that it is not slack.

## Electrical wiring

- Only a qualified installer(\*1) or qualified service person(\*1) is allowed to carry out the electrical work of the air conditioner. Under no circumstances must this work be done by an unqualified individual since failure to carry out the work properly may result in electric shocks and/or electrical leaks.
- The appliance shall be installed in accordance with national wiring regulations. Capacity shortages of the power circuit or an incomplete installation may cause an electric shock or fire.
- Use wiring that meets the specifications in the Installation Manual and the stipulations in the local regulations and laws. Use of wiring which does not meet the specifications may give rise to electric shocks, electrical leakage, smoking and/or a fire.
- Be sure to connect earth wire. (Earthing work) Incomplete earthing causes an electric shock.
- Do not connect earth wires to gas pipes, water pipes, and lightning rods or earth wires for telephone wires.
- After completing the repair or relocation work, check that the earth wires are connected properly.
- Install a circuit breaker that meets the specifications in the installation manual and the stipulations in the local regulations and laws.



- 
- Install the circuit breaker where it can be easily accessed by the agent.
  - When installing the circuit breaker outdoors, install one which is designed to be used outdoors.
  - Under no circumstances must the power cable be extended. Connection trouble in the places where the cable is extended may give rise to smoking and/or a fire.

### **Test run**

- Before operating the air conditioner after having completed the work, check that the electrical parts box cover of the indoor unit and service panel of the outdoor unit are closed, and set the circuit breaker to the ON position. You may receive an electric shock etc. if the power is turned on without first conducting these checks.
- When you have noticed that some kind of trouble (such as when a check display has appeared, there is a smell of burning, abnormal sounds are heard, the air conditioner fails to cool or heat or water is leaking) has occurred in the air conditioner, do not touch the air conditioner yourself but set the circuit breaker to the OFF position, and contact a qualified service person. Take steps to ensure that the power will not be turned on (by marking "out of service" near the circuit breaker, for instance) until qualified service person arrives. Continuing to use the air conditioner in the trouble status may cause mechanical problems to escalate or result in electric shocks, etc.
- After the work has finished, be sure to use an insulation tester set (500 V Megger) to check the resistance is 1 MΩ or more between the charge section and the non-charge metal section (Earth section). If the resistance value is low, a disaster such as a leak or electric shock is caused at user's side.

- Upon completion of the installation work, check for refrigerant leaks and check the insulation resistance and water drainage. Then conduct a test run to check that the air conditioner is operating properly.
- After the installation work, confirm that refrigerant gas does not leak. If refrigerant gas leaks into the room and flows near a fire source, such as a cooking range, noxious gas may be generated.

### **Explanations given to user**

- Upon completion of the installation work, tell the user where the circuit breaker is located. If the user does not know where the circuit breaker is, he or she will not be able to turn it off in the event that trouble has occurred in the air conditioner.
- If you have discovered that the fan guard is damaged, do not approach the outdoor unit but set the circuit breaker to the OFF position, and contact a qualified service person(\*1) to have the repairs done. Do not set the circuit breaker to the ON position until the repairs are completed.
- After the installation work, follow the Owner's Manual to explain to the customer how to use and maintain the unit.

### **Relocation**

- Only a qualified installer(\*1) or qualified service person(\*1) is allowed to relocate the air conditioner. It is dangerous for the air conditioner to be relocated by an unqualified individual since a fire, electric shocks, injury, water leakage, noise and/or vibration may result.
- When carrying out the pump-down work shut down the compressor before disconnecting the refrigerant pipe. Disconnecting the refrigerant pipe with the service valve left open and the compressor still operating will cause air, etc. to be sucked in, raising the pressure inside the refrigeration cycle to an abnormally high level, and possibly resulting in reputing, injury, etc.

## ⚠ CAUTION

This air conditioner adopts the HFC refrigerant (R32) which does not destroy the ozone layer.

- R32 refrigerant has a high working pressure and is apt to be affected by impurities such as water, oxidizing membrane, and oils. Therefore, during installation work, be careful that water, dust, previous refrigerant, refrigerating machine oil, or other substances do not enter the R32 refrigeration cycle.
- Special tools for R32 or R410A refrigerant are required for installation.
- For connecting pipes, use new and clean piping materials, and make sure that water and/or dust does not enter.

### Cautions for outdoor unit installation space

- In the event that the outdoor unit is installed in a small space and refrigerant leaks, accumulation of highly concentrated refrigerant may cause a fire hazard. Therefore, be sure to follow the installation space instructions in the Installation Manual, and provide open space on at least one of the four outdoor unit sides.
- In particular, when both the discharge and intake sides face walls and obstacles are also placed on both sides of the outdoor unit, take steps to provide space wide enough for a person to pass (600 mm or more) on one side to prevent leaked refrigerant from accumulating.

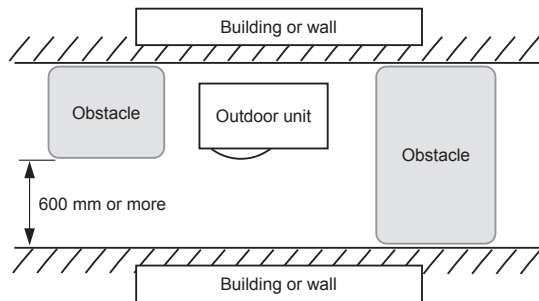

### To disconnect the appliance from main power supply



- This appliance must be connected to the main power supply by means of a switch with a contact separation of at least 3 mm.

### Do not wash air conditioners with pressure washers

- Electric leaks may cause electric shocks or fires.

(\*1) Refer to the “Definition of Qualified Installer or Qualified Service Person.”

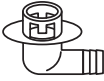
## 2 Accessory parts

Part name	Q'ty	Shape	Usage
Installation Manual	1		Hand this directly to the customer. (For other languages that do not appear in this Installation Manual, please refer to the enclosed CD-R.)
CD-ROM	1	—	Installation Manual
Drain nipple	1		
Waterproof rubber cap	2		

## 3 Installation of R32 refrigerant air conditioner

### CAUTION

#### R32 refrigerant air conditioner installation

- This air conditioner adopts the HFC refrigerant (R32) which does not destroy ozone layer.

Therefore, during installation work, make sure that water, dust, former refrigerant, or refrigerant oil does not enter the R32 refrigerant air conditioner cycle. To prevent mixing of refrigerant or refrigerant oil, the sizes of connecting sections of charge port on the main unit and installation tools are different from those of the conventional refrigerant units.

Accordingly, special tools are required for the R32 or R410A refrigerant units. For connecting pipes, use new and clean piping materials with high pressure fittings made for the R32 or R410A only, so that water and/or dust does not enter.

- When using existing piping, refer to “15 APPENDIX - [1] Existing piping”.

### ■ Required Tools/Equipment and Precautions for use

Prepare the tools and equipment listed in the following table before starting the installation work. Newly prepared tools and equipment must be used exclusively.

#### Legend

△ : Conventional tools (R32 or R410A)

◎ : Prepared newly (Use for R32 only)

Tools / equipment	Use	How to use tools / equipment
Gauge manifold	Vacuuming / charging refrigerant and operation check	△ Conventional tools (R410A)
Charging hose		△ Conventional tools (R410A)
Charging cylinder	Can not be used	Unusable (Use the electronic refrigerant charging scale)
Gas leak detector	Charging refrigerant	△ Conventional tools (R32 or R410A)
Vacuum pump	Vacuum drying	△ Conventional tools (R32 or R410A) Usable if the backflow prevention adapter is installed.
Vacuum pump with backflow prevention function	Vacuum drying	△ Conventional tools (R32 or R410A)
Flare tool	Flare machining of pipes	△ Conventional tools (R410A)

Bender	Bending pipes	△ Conventional tools (R410A)
Refrigerant recovery equipment	Refrigerant recovery	△ Conventional tools (R32 or R410A)
Torque wrench	Tightening flare nuts	△ Conventional tools (R410A)
Pipe cutter	Cutting pipes	△ Conventional tools (R410A)
Refrigerant cylinder	Charging refrigerant	◎ Prepared newly (Use for R32 only)
Welding machine and nitrogen cylinder	Welding pipes	△ Conventional tools (R410A)
Electronic refrigerant charging scale	Charging refrigerant	△ Conventional tools (R32 or R410A)

## ■ Refrigerant piping

### R32 refrigerant

#### CAUTION

- Incomplete flaring may cause refrigerant gas leakage.
- Do not re-use flares. Use new flares to prevent refrigerant gas leakage.
- Use flare nuts that are included with the unit. Using different flare nuts may cause refrigerant gas leakage.

**Use the following item for the refrigerant piping.**  
**Material : Seamless phosphorous deoxidized copper pipe.**  
**Ø6.35, Ø9.52, Ø12.7 Wall thickness 0.8 mm or more**  
**Ø15.88 Wall thickness 1.0 mm or more**

#### REQUIREMENT

When the refrigerant pipe is long, provide support brackets at intervals of 2.5 to 3 m to clamp the refrigerant pipe. Otherwise, abnormal sound may be generated.

# 4 Installation conditions

## ■ Before installation

Be sure to prepare to the following items before installation.

### Length of refrigerant pipe

Model	Length of refrigerant pipe connected to indoor / outdoor unit	Height difference (Indoor-outdoor)		Item
		Indoor unit: Upper	Outdoor unit: Lower	
GP56	3 to 50 m	30 m	30 m	Addition of refrigerant at the local site is unnecessary for refrigerant pipe length up to 30 m. If the refrigerant pipe length exceeds 30 m, add refrigerant in the amount given in "Charging additional refrigerant"

- \* Caution during addition of refrigerant.  
Charge the refrigerant accurately. Overcharging may cause serious trouble with the compressor.
- Do not connect a refrigerant pipe that is shorter than **3 m**.  
This may cause a malfunction of the compressor or other devices.

### Airtight test

1. Before starting an airtight test, further tighten the spindle valves on the gas and liquid sides.
2. Pressurize the pipe with nitrogen gas charged from the service port to the design pressure (4.15 Mpa) to conduct an airtight test.
3. After the airtight test is completed, evacuate the nitrogen gas.

### Air purge

- To purge air, use a vacuum pump.
- Do not use refrigerant charged in the outdoor unit to purge air. (The air purge refrigerant is not contained in the outdoor unit.)

### Electrical wiring

- Be sure to fix the power wires and indoor/outdoor connecting wires with clamps so that they do not come into contact with the cabinet, etc.

## Earthing

### WARNING

#### Make sure that proper earthing is provided.

Improper earthing may cause an electric shock. For details on how to check earthing, contact the dealer who installed the air conditioner or a professional installation company.

- Proper earthing can prevent charging of electricity on the outdoor unit surface due to the presence of a high frequency in the frequency converter (inverter) of the outdoor unit, as well as prevent electric shock. If the outdoor unit is not properly earthed, you may be exposed to an electric shock.
- **Be sure to connect the earth wire. (grounding work)**  
Incomplete grounding can cause an electric shock. Do not connect ground wires to gas pipes, water pipes, lightning rods or ground wires for telephone wires.

## Test run

Turn on the leakage breaker at least 12 hours before starting a test run to protect the compressor during startup.

### CAUTION

Incorrect installation work may result in a malfunction or complaints from customers.

## ■ Installation location

### WARNING

#### Install the outdoor unit properly in a location that is durable enough to support the weight of the outdoor unit.

Insufficient durability may cause the outdoor unit to fall, which may result in injury.

### CAUTION

#### Do not install the outdoor unit in a location that is subject to combustible gas leaks.

Accumulation of combustible gas around the outdoor unit may cause a fire.

#### Install the outdoor unit in a location that meets the following conditions after the customer's consent is obtained.

- A well-ventilated location free from obstacles near the air inlets and air outlet.
- A location that is not exposed to rain or direct sunlight.
- A location that does not increase the operating noise or vibration of the outdoor unit.
- A location that does not produce any drainage problems from discharged water.

#### Do not install the outdoor unit in the following locations.

- A location with a saline atmosphere (coastal area) or one that is full of sulfide gas (hot-spring area) (Special maintenance is required).
- A location subject to oil, vapor, oily smoke, or corrosive gases.
- A location in which organic solvent is used.
- Places where iron or other metal dust is present. If iron or other metal dust adheres to or collects on the interior of the air conditioner, it may spontaneously combust and start a fire.

- A location where high-frequency equipment (including inverter equipment, private power generator, medical equipment, and communication equipment) is used (Installation in such a location may cause malfunction of the air conditioner, abnormal control or problems due to noise from such equipment).
- A location in which the discharged air of the outdoor unit blows against the window of a neighboring house.
- A location where the operating noise of the outdoor unit is transmitted.
- When the outdoor unit is installed in an elevated position, be sure to secure its feet.
- A location in which drain water poses any problems.

### CAUTION

1. Install the outdoor unit in a location where the discharge air is not blocked.
2. When an outdoor unit is installed in a location that is always exposed to strong winds like a coast or on the high stories of a building, secure normal fan operation by using a duct or wind shield.
3. When installing the outdoor unit in a location that is constantly exposed to strong winds such as on the upper stairs or rooftop of a building, apply the windproofing measures referred to in the following examples.
  - 1) Install the unit so that its discharge port faces the wall of the building.  
Keep a distance 500 mm or more between the unit and wall surface.

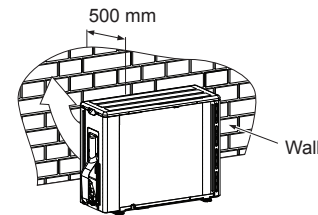

- 2) Consider the wind direction during the operational season of the air conditioner, and install the unit so that the discharge port is set at a right angle relative to the wind direction.



- When using an air conditioner under low outside temperature conditions (outside temp. -5 °C or lower) in COOL mode, prepare a duct or snow hood so that it is not affected by the snow.

### <Example>

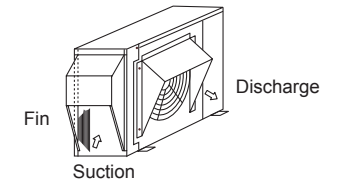

## Necessary Space for Installation (Unit: mm)

### Obstacle at rear side

#### Upper side is free

1. Single unit installation

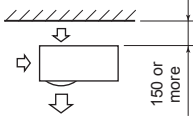

2. Obstacles on both right and left sides

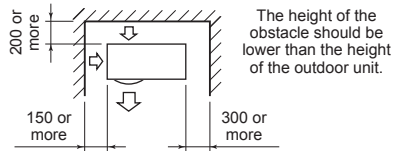

3. Serial installation of two or more units

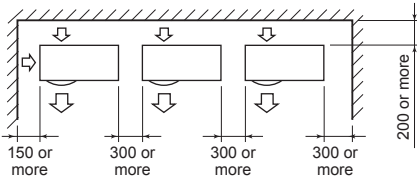

The height of the obstacle should be lower than the height of the outdoor unit.

### Obstacle also above unit

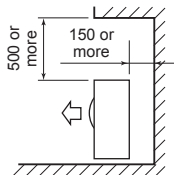

### Obstacle in front

#### Above unit is free

1. Single unit installation

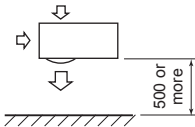

2. Serial installation of two or more units

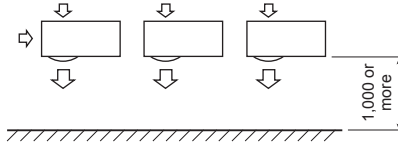

### Obstacle also at the above unit

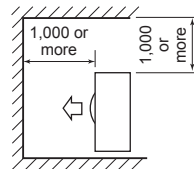

### Obstacles in both front and rear of unit

Open above and to the right and left of the unit.  
The height of an obstacle in both the front and rear of the unit, should be lower than the height of the outdoor unit.

#### Standard installation

1. Single unit installation

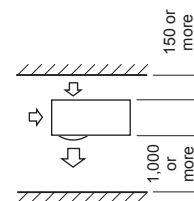

2. Serial installation of two or more units

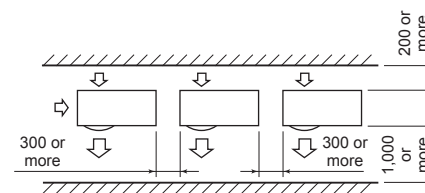

### Serial installation in front and rear

Open above and to the right and left of the unit.  
The height of an obstacle in both the front and rear of the unit, should be lower than the height of the outdoor unit.

#### Standard installation

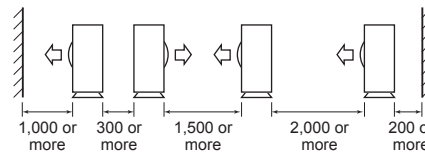

## Installation of Outdoor Unit

- Before installation, check the strength and horizontalness of the base so that abnormal sounds do not emanate.
- According to the following base diagram, fix the base firmly with the anchor bolts.  
(Anchor bolt, nut: M10 × 4 pairs)

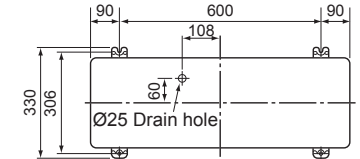

- As shown in the figure below, install the foundation and vibration-proof rubber pads to directly support the bottom surface of the fixing leg that is in contact with and underneath the bottom plate of the outdoor unit.
- \* When installing the foundation for an outdoor unit with downward piping, consider the piping work.

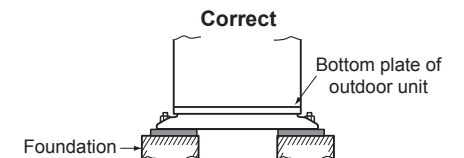
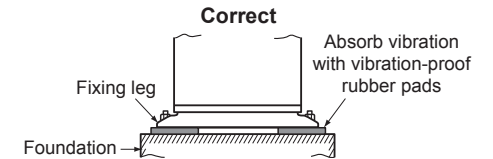

Support the bottom surface of the fixing leg that is in contact with and underneath the bottom plate of the outdoor unit.

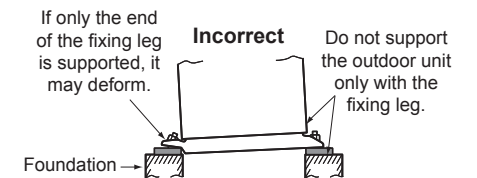

Set the out margin of the anchor bolt to 15 mm or less.

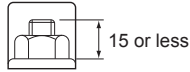

- When water is to be drained through the drain hose, attach the following drain nipple and waterproof rubber cap, and use the drain hose (Inner dia.: 16 mm) sold on the market. Also seal the screws securely with silicone material, etc., to prevent water from leaking. Some conditions may cause dewing or dripping of water.
- When collectively draining discharged water completely, use a drain pan.

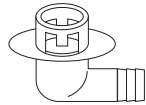

Drain nipple

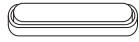

Waterproof rubber cap  
(2 pcs.)

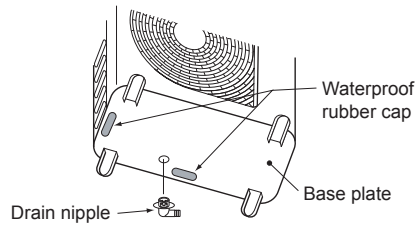

Drain nipple

Waterproof rubber cap

Base plate

## ■ For reference

If a heating operation is to be continuously performed for a long time under the condition that the outdoor temperature is 0 °C or lower, draining defrosted water may be difficult due to the bottom plate freezing, resulting in trouble with the cabinet or fan. It is recommended to procure an anti-freeze heater locally in order to safely install the air conditioner. For details, contact the dealer.

# 5 Refrigerant piping

## ■ Optional installation parts (Locally procured)

	Parts name	Q'ty
A	Refrigerant piping Liquid side: Ø6.4 mm Gas side: Ø12.7 mm	One each
B	Pipe insulating material (polyethylene foam, 6 mm thick)	1
C	Putty, PVC tape	One each

## ■ Refrigerant piping connection

### ⚠ CAUTION

#### TAKE NOTE OF THESE 4 IMPORTANT POINTS BELOW FOR PIPING WORK

1. Keep dust and moisture away from inside the connecting pipes.
2. Tightly connect the connection between pipes and the unit.
3. Evacuate the air in the connecting pipes using a VACUUM PUMP.
4. Check for gas leaks at connection points.

### Piping connection

Liquid side	
Outer diameter	Thickness
Ø6.4 mm	0.8 mm
Gas side	
Outer diameter	Thickness
Ø12.7 mm	0.8 mm

## Flaring

1. Cut the pipe with a pipe cutter.  
Be sure to remove burrs that may cause a gas leak.
2. Insert a flare nut into the pipe, and then flare the pipe.  
Use the flare nuts supplied with the air conditioner or those for R32.  
Insert a flare nut into the pipe, and flare the pipe.  
Use the flare nuts supplied with the air conditioner or flare nuts for R32 or R410A.  
However, the conventional tools can be used by adjusting the projection margin of the copper pipe.

### Projection margin in flaring : B (Unit : mm)

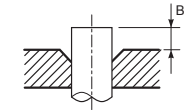

Rigid (Clutch type)

Outer dia. of copper pipe	R32 or R410A tool used	Conventional tool used
6.4	0 to 0.5	1.0 to 1.5
12.7		

### Flaring dia. size : A (Unit : mm)



Outer dia. of copper pipe	A $\begin{smallmatrix} +0 \\ -0.4 \end{smallmatrix}$
6.4	9.1
12.7	16.6

### ⚠ CAUTION

- Do not scratch the inner surface of the flared part when removing burrs.
- Flare processing under the condition of scratches on the inner surface of flare processing part will cause refrigerant gas leak.
- Check that the flared part is not scratched, deformed, stepped, or flattened, and that there are no chips adhered or other problems, after flare processing.
- Do not apply refrigerating machine oil to the flare surface.

## ■ Tightening of Connecting Part

- Align the centers of the connecting pipes and fully tighten the flare nut with your fingers. Then fix the nut with a wrench as shown in the figure and tighten it with a torque wrench.

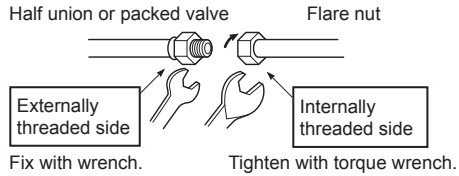

- As shown in the figure, be sure to use two wrenches to loosen or tighten the flare nut of the valve on the gas side. If you use a single crescent, the flare nut cannot be tightened to the required tightening torque. On the other hand, use a single crescent to loosen or tighten the flare nut of the valve on the liquid side.

(Unit: N•m)

Outer dia. of copper pipe	Tightening torque
6.4 mm (dia.)	14 to 18 (1.4 to 1.8 kgf•m)
12.7 mm (dia.)	49 to 61 (4.9 to 6.1 kgf•m)

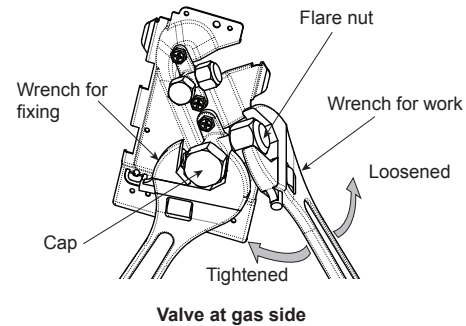

## ⚠ CAUTION

- Do not put the crescent wrench on the cap. The valve may break.
- If applying excessive torque, the nut may break according to some installation conditions.

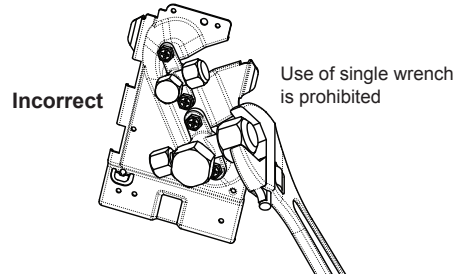

- After the installation work, be sure to check for gas leaks of the pipe connections with nitrogen. Therefore, using a torque wrench, tighten the flare pipe connecting sections that connect the indoor/outdoor units at the specified tightening torque. Incomplete connections may cause not only a gas leak, but also trouble with the refrigeration cycle.

**Do not apply refrigerant oil to the flared surface.**

## ■ Refrigerant pipe length

### Single

Model	Allowable pipe length (m)	Height difference (Indoor-outdoor H) (m)	
	Total length L	Indoor unit: Upper	Outdoor unit: Lower
GP56	50	30	30

Model	Pipe diameter (mm)		Number of bent portions
	Gas side	Liquid side	
GP56	Ø12.7	Ø6.4	10 or less

Figure of Single

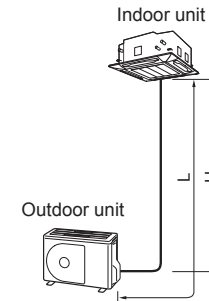



# 6 Air purging

## ■ Airtight test

After completing the refrigerant piping work, perform an airtight test. Connect a nitrogen gas cylinder and pressurize the pipes with nitrogen gas as follows to conduct the airtight test.

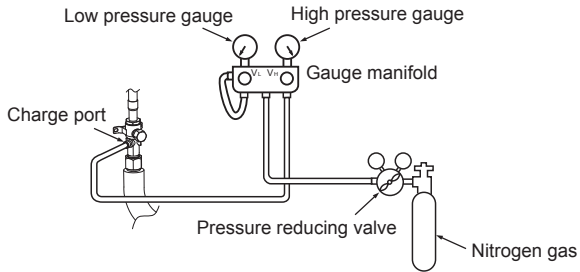

### ⚠ CAUTION

Never use oxygen, flammable gas, or noxious gas for the airtight test.

## Gas leak check

- Step 1....Pressurize to **0.5 MPa** (5 kg/cm<sup>2</sup>G) for 5 minutes or longer.
- Step 2....Pressurize to **1.5 MPa** (15 kg/cm<sup>2</sup>G) for 5 minutes or longer. > Major leaks can be discovered.
- Step 3....Pressurize to **4.15 MPa** (42 kg/cm<sup>2</sup>G) for 24 hours. .... Micro leaks can be discovered.

(However, note that when the ambient temperature differs during pressurization and after 24 hours, the pressure will change by approximately 0.01 MPa (0.1 kg/cm<sup>2</sup>G) per 1°C, so this should be compensated.)

If the pressure drops in steps 1 through 3, check the connections for leakage. Check for leaks with foaming liquid, etc., take steps to fix the leaks such as brazing the pipes again and tightening the flare nuts, and then perform the airtight test again.

\* After the airtight test is completed, evacuate the nitrogen gas.

## ■ Air purge

With respect to the preservation of the terrestrial environment, adopt "Vacuum pump" to purge air (Evacuate air in the connecting pipes) when installing the unit.

- Do not discharge the refrigerant gas to the atmosphere to preserve the terrestrial environment.
- Use a vacuum pump to discharge the air (nitrogen, etc.) that remains in the set. If air remains, the capacity may decrease.

For the vacuum pump, be sure to use one with a backflow preventer so that the oil in the pump does not backflow into the pipe of the air conditioner when the pump stops.  
(If oil in the vacuum pump is put in an air conditioner including R32, it may cause trouble with the refrigeration cycle.)

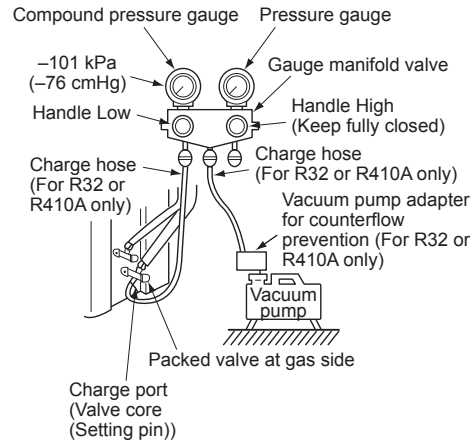

## Vacuum pump

- As shown in the figure, connect the charge hose after the manifold valve is closed completely.
- ↓
- Attach the connecting port of the charge hose with a projection to push the valve core (setting pin) to the charge port of the set.
- ↓
- Open Handle Low fully.
- ↓
- Turn ON the vacuum pump. (\*1)
- ↓
- Loosen the flare nut of the packed valve (Gas side) a little to check that the air passes through. (\*2)
- ↓
- Retighten the flare nut.
- ↓
- Execute vacuuming until the compound pressure gauge indicates -101 kPa (-76 cmHg). (\*1)
- ↓
- Close Handle Low completely.
- ↓
- Turn OFF the vacuum pump.
- ↓
- Leave the vacuum pump as it is for 1 or 2 minutes, and check that the indicator of the compound pressure gauge does not return.
- ↓
- Open the valve stem or valve handle fully. (First, at liquid side, then gas side)
- ↓
- Disconnect the charge hose from the charge port.
- ↓
- Tighten the valve and caps of the charge port securely.

\*1: Use the vacuum pump, vacuum pump adapter, and gauge manifold correctly referring to the manuals supplied with each tool before using them. Check that the vacuum pump oil is filled up to the specified line of the oil gauge.

\*2: When air is not charged, check again whether the connecting port of the discharge hose, which has a projection to push the valve core, is firmly connected to the charge port.

## ■ How to open the valve

Open or close the valve.

### Liquid side, gas side

Open the valve with a 4 mm hexagon wrench.  
[Hexagonal wrench is required.]

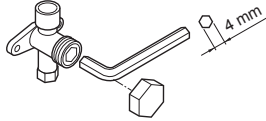

### Valve handling precautions

- Open the valve stem until it strikes the stopper. It is unnecessary to apply further force.
- Securely tighten the cap with a torque wrench.

### Cap tightening torque

Valve size	Ø6.4 mm	14 to 18 N•m (1.4 to 1.8 kgf•m)
	Ø12.7 mm	33 to 42 N•m (3.3 to 4.2 kgf•m)
Charge port		14 to 18 N•m (1.4 to 1.8 kgf•m)

## ■ Replenishing refrigerant

This model is a 20 m chargeless type that does not need to have its refrigerant replenished for refrigerant pipes up to 20 m. When a refrigerant pipe longer than 20 m is used, add the specified amount of refrigerant.

### Refrigerant replenishing procedure

1. After vacuuming the refrigerant pipe, close the valves and then charge the refrigerant while the air conditioner is not working.
2. When the refrigerant cannot be charged to the specified amount, charge the required amount of refrigerant from the charge port of the valve on the gas side during cooling.

### Requirement for replenishing refrigerant

Replenish liquid refrigerant.

When gaseous refrigerant is replenished, the refrigerant composition varies, which disables normal operation.

### Adding additional refrigerant

<b>GP56</b>
21~50 m: L
20 g × (L-20)

- L: Pipe length
- The refrigerant need not be reduced for a 20 meter (or less) refrigerant pipe.

## Gas leak inspection

**Use a leak detector manufactured specially for HFC refrigerant (R32, R410A, R134a, etc.) to perform the R32 gas leak inspection.**

- \* Leak detectors for conventional HCFC refrigerant (R22, etc.) cannot be used, as the sensitivity drops to approximately 1/40 when used for HFC refrigerant.
- R32 has a high working pressure, so failure to perform the installation work properly may result in gas leaks such as when the pressure rises during operation. Be sure to perform leak tests on the piping connections.

Indoor unit inspection locations  
(piping connections)

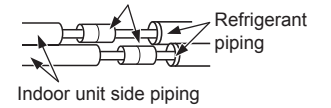

Indoor unit side piping

Outdoor unit inspection locations

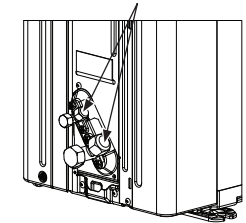

## ■ Insulating the Pipes

- The temperatures at both the liquid side and gas side will be low during cooling so in order to prevent condensation, be sure to insulate the pipes at both of these sides.
- Insulate the pipes separately for the liquid side and gas side.
- Insulate the branch pipes by following the instructions in the installation manual provided with the branch pipe kit.

### REQUIREMENT

Be sure to use an insulating material which can withstand temperatures above 120°C for the gas side pipe since this pipe will become very hot during heating operations.

## ■ To Fix the Fluorinated Greenhouse Gases Label

This product contains fluorinated greenhouse gases. Do not vent gases into the atmosphere.

Contains fluorinated greenhouse gases	
• Chemical Name of Gas	R32
• Global Warming Potential (GWP) of Gas	675

### ⚠ CAUTION

- Stick the enclosed refrigerant label adjacent to the service ports for charging or recovering location and where possible adjacent to existing nameplates or product information label.
- Clearly write the charged refrigerant quantity on the refrigerant label using indelible ink. Then, place the included transparent protective sheet over the label to prevent the writing from rubbing off.
- Prevent emission of the contained fluorinated greenhouse gas. Ensure that the fluorinated greenhouse gas is never vented to the atmosphere during installation, service or disposal. When any leakage of the contained fluorinated greenhouse gas is detected, the leak shall be stopped and repaired as soon as possible.
- Only qualified service personnel are allowed to access and service this product.
- Any handling of the fluorinated greenhouse gas in this product, such as when moving the product or recharging the gas, shall comply under (EU) Regulation No.517/2014 on certain fluorinated greenhouse gases and any relevant local legislation.
- Periodical inspections for refrigerant leaks may be required depending on European or local legislation.
- Contact dealers, installers, etc., for any questions.

Fill in the label as follows:

**Refrigerant Label**

Contains fluorinated greenhouse gases.

① Pre-charged refrigerant at factory [kg], specified in the nameplate.

② Additional charge on installation site [kg].

③ Total quantity of refrigerant in tonnes CO<sub>2</sub> equivalent.

Caution: Write out charge amount ①, ②, ①+② and ③ by indelible means on installation site.

<b>R32</b>	GWP:675		
① =	<input style="width: 40px;" type="text"/>	kg	Pre-charged refrigerant at factory [kg], specified in the nameplate
② =	<input style="width: 40px;" type="text"/>	kg	Additional charge on installation site [kg]
①+② =	<input style="width: 40px;" type="text"/>	kg	
③ =	<input style="width: 40px;" type="text"/>	t	$\frac{\text{GWP} \times \text{kg}}{1000}$

DG44206103

## 7 Electrical work

- Remove valve cover screw.
- Pull the valve cover downward to remove it.

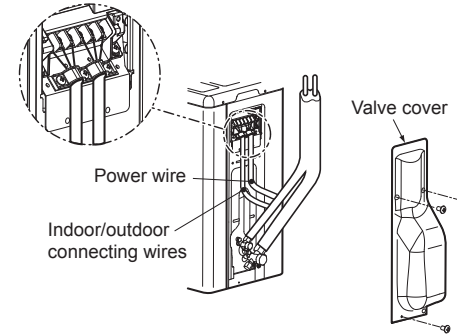

For the air conditioner, connect a power wire with the following specifications.

Model RAV-	GP56
<b>Power supply</b>	1 ~ 50 Hz 220 - 240 V
<b>Maximum running current</b>	13.1 A
<b>Installation fuse rating</b>	16 A (all types can be used)
<b>Power wire</b>	H07 RN-F or 60245 IEC 66 (2.5 mm <sup>2</sup> or more)
<b>Indoor/outdoor connecting wires</b>	H07 RN-F or 60245 IEC 66 (1.5 mm <sup>2</sup> or more)

### ⚠ CAUTION

- Wrong wiring may cause a burn-out of some electrical parts.
- Be sure to use the cord clamps attached to the product.
- Do not damage or scratch the conductive core or inner insulator of the power and inter-connecting wires when peeling them.
- Use the power and inter-connecting wires with specified thicknesses, specified types and protective devices required.

## ■ Wiring between indoor unit and outdoor unit

The dashed lines show on-site wiring.

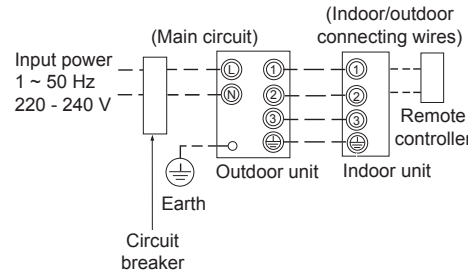

- Connect the indoor/outdoor connecting wires to the identical terminal numbers on the terminal block of each unit. Incorrect connection may cause a failure.

### How to wire

1. Connect the connecting wire to the terminal as identified with their respective numbers on the terminal block of the indoor and outdoor units. H07 RN-F or 60245 IEC 66 (1.5 mm<sup>2</sup> or more)
2. When connecting the connecting wire to the outdoor unit terminal, prevent water from coming into the outdoor unit.
3. Insulate the unsheathed cords (conductors) with electrical insulation tape. Process them so that they do not touch any electrical or metal parts.
4. For interconnecting wires, do not use a wire joined to another on the way.  
Use wires long enough to cover the entire length.

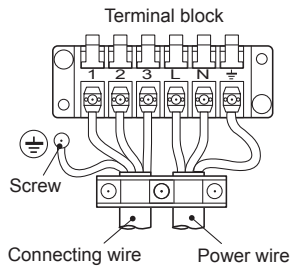

### Stripping length power cord and connecting wire

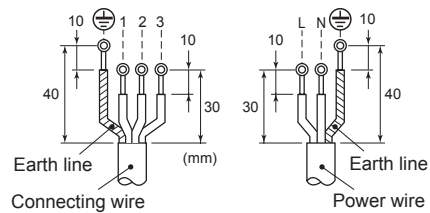

### CAUTION

- An installation fuse must be used for the power supply line of this air conditioner.
- Incorrect/incomplete wiring may lead to an electrical fire or smoke.
- Prepare an exclusive power supply for the air conditioner.
- This product can be connected to the mains power. Fixed wire connections: A switch that disconnects all poles and has a contact separation of at least 3 mm must be incorporated in the fixed wiring.

## 8 Earthing

### WARNING

**Be sure to connect the earth wire. (earthing work)**  
Incomplete earthing may cause an electric shock.

Connect the earth wire properly following applicable technical standards. Connecting the earth wire is essential to preventing electric shock and to reducing noise and electrical charges on the outdoor unit surface due to the high-frequency wave generated by the frequency converter (inverter) in the outdoor unit. If you touch the charged outdoor unit without an earth line, you may experience an electric shock.

## 9 Finishing

After the refrigerant pipe, inter-unit wires, and drain pipe have been connected, cover them with finishing tape and clamp them to the wall with off-the-shelf support brackets or their equivalent. Keep the power wires and indoor/outdoor connecting wires off the valve on the gas side or pipes that have no heat insulator.

## 10 Test run

- **Turn on the leakage breaker at least 12 hours before starting a test run to protect the compressor during startup.**  
To protect the compressor, power is supplied from the 220-240 VAC input to the unit to preheat the compressor.
  - **Check the following before starting a test run:**
    - That all pipes are connected securely without leaks.
    - That the valve is open.
- If the compressor is operated with the valve closed, the outdoor unit will become overpressurized, which may damage the compressor or other components. If there is a leak at a connection, air can be sucked in and the internal pressure further increases, which may cause a burst or injury.
- Operate the air conditioner in the correct procedure as specified in the Owner's Manual.

## 11 Annual maintenance

For an air conditioning system that is operated on a regular basis, cleaning and maintenance of the indoor/outdoor units are strongly recommended. As a general rule, if an indoor unit is operated for about 8 hours daily, the indoor/outdoor units will need to be cleaned at least once every 3 months. This cleaning and maintenance should be carried out by a qualified service person. Failure to clean the indoor/outdoor units regularly will result in poor performance, icing, water leaking and even compressor failure.

# 12 Air conditioner operating conditions

For proper performance, operate the air conditioner under the following temperature conditions:

Cooling operation	Dry bulb temp.	-15 °C to 52 °C
Heating operation	Wet bulb temp.	-27 °C to 15 °C

If air conditioner is used outside of the above conditions, safety protection may work.

# 13 Functions to be implemented locally

## ■ Handling Existing Pipe (Refer to 15 APPENDIX)

When using the existing pipe, carefully check for the following:

- Wall thickness (within the specified range)
- Scratches and dents
- Water, oil, dirt, or dust in the pipe
- Flare looseness and leakage from welds
- Deterioration of copper pipe and heat insulator

### Cautions for using existing pipe

- Do not reuse a flare nut to prevent gas leaks.  
Replace it with the supplied flare nut and then process it to a flare.
- Blow nitrogen gas or use an appropriate means to keep the inside of the pipe clean. If discolored oil or much residue is discharged, wash the pipe.
- Check welds, if any, on the pipe for gas leaks.

When the pipe corresponds to any of the following, do not use it. Install a new pipe instead.

- The pipe has been opened (disconnected from indoor unit or outdoor unit) for a long period.
- The pipe has been connected to an outdoor unit that does not use refrigerant R22, R410A or R407C.
- The existing pipe must have a wall thickness equal to or larger than the following thicknesses.

Reference outside diameter (mm)	Wall thickness (mm)	Material
6.4	0.8	-
9.5	0.8	-
12.7	0.8	-
15.9	1.0	-

- Do not use any pipe with a wall thickness less than these thicknesses due to insufficient pressure capacity.

## ■ Refrigerant recovery

When recovering the refrigerant in situations such as when relocating an indoor unit or outdoor unit, the recovery operation can be performed by operating the SW01 and SW02 switches on the P.C. board of the outdoor unit. A cover for the electric parts has been installed in order to provide protection from electric shocks while work is being performed. Operate the service switches and check the LED displays with this electric parts cover in place. Do not remove this cover while the power is still on.

### ⚠ DANGER

The entire P.C. board of this air conditioner system is a high-voltage area.  
When operating the service switches with the power of the system left on, wear electrically insulated gloves.

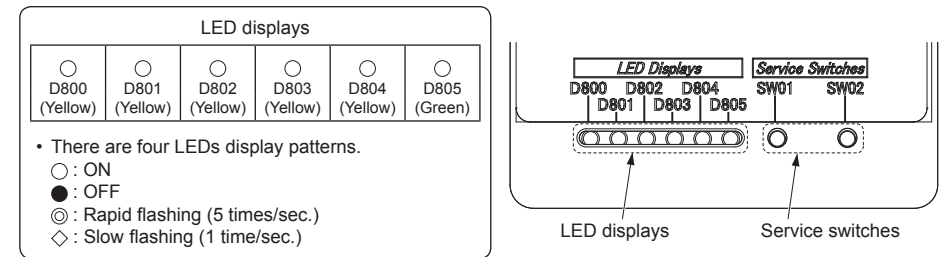

- In the initial LED display status, D805 is lighted as shown on the table below. If the initial status is not established (if D805 is flashing), hold down the SW01 and SW02 service switches simultaneously for at least 5 seconds to return the LED displays to the initial status.

LED display initial status

D800 (Yellow)	D801 (Yellow)	D802 (Yellow)	D803 (Yellow)	D804 (Yellow)	D805 (Green)
● or ◎	● or ◎	● or ◎	● or ◎	● or ◎	○
OFF or Rapid flashing	OFF or Rapid flashing	OFF or Rapid flashing	OFF or Rapid flashing	OFF or Rapid flashing	ON

- \* In order to reduce standby power, the LED indication may be turned off even when the power is on. When either SW01 or SW02 is pressed, the LED is displayed.

### Steps taken to recover the refrigerant

1. Operate the indoor unit in the fan mode.
2. Check that the LED displays are placed in their initial status. If not, place them in the initial status.
3. Hold down SW01 for at least 5 seconds, and check that D804 flashes slowly. (Fig. 1)
4. Press SW01 once to set the LED displays (D800 to D805) to the "refrigerant recovery LED display" shown below. (Fig. 2)

(Fig. 1)

LED displays indicated when step 3 is taken					
D800	D801	D802	D803	D804	D805
○	●	●	●	◇	●

○ : ON, ● : OFF, ◇ : Slow flashing

(Fig. 2)

Refrigerant recovery LED display					
D800	D801	D802	D803	D804	D805
○	●	●	●	⊙	●

○ : ON, ● : OFF, ⊙ : Rapid flashing

5. Press SW02 to set D805 to rapid flashing. (Each time SW02 is pressed, D805 is switched between rapid flashing and OFF.) (Fig. 3)
6. Hold down SW02 for at least 5 seconds, and when D804 flashes slowly and D805 lights, the forced cooling operation is started. (Max. 10 minutes) (Fig. 4)

(Fig. 3)

LED displays indicated when step 5 is taken					
D800	D801	D802	D803	D804	D805
○	●	●	●	⊙	⊙

○ : ON, ● : OFF, ⊙ : Rapid flashing

(Fig. 4)

LED displays indicated when step 6 is taken					
D800	D801	D802	D803	D804	D805
○	●	●	●	◇	●

○ : ON, ● : OFF, ◇ : Slow flashing

7. After operating the system for at least 3 minutes, close the valve on the liquid side.
  8. After the refrigerant has been recovered, close the valve on the gas side.
  9. Hold down SW01 and SW02 simultaneously for at least 5 seconds. The LED displays are returned to the initial status, and the cooling operation and indoor fan operation stop.
  10. Turn off the power.
- \* If there is any reason to doubt whether the recovery was successful in the course of this operation, hold down SW01 and SW02 simultaneously for at least 5 seconds to return to the initial status, and then repeat the steps for recovering the refrigerant.

### Existing piping

#### Steps taken to support existing piping

1. Set the circuit breaker to the ON position to turn on the power.
2. Check that the LED displays are placed in their initial status. If not, place them in the initial status.
3. Hold down SW01 for at least 5 seconds, and check that D804 flashes slowly. (Fig. 5)
4. Press SW01 four times to set the LED displays (D800 to D805) to the "LED displays for existing piping settings" shown below. (Fig. 6)

(Fig. 5)

LED displays indicated when step 3 is taken					
D800	D801	D802	D803	D804	D805
○	●	●	●	◇	●

○ : ON, ● : OFF, ◇ : Slow flashing

(Fig. 6)

LED displays for existing piping settings					
D800	D801	D802	D803	D804	D805
●	●	○	●	⊙	●

○ : ON, ● : OFF, ⊙ : Rapid flashing

5. Press SW02 to set D805 to rapid flashing. (Each time SW02 is pressed, D805 is switched between rapid flashing and OFF.) (Fig. 7)
6. Hold down SW02 for at least 5 seconds, and check that D804 flashes slowly and that D805 lights. (Fig. 8)

(Fig. 7)

LED displays indicated when step 5 is taken					
D800	D801	D802	D803	D804	D805
●	●	○	●	⊙	⊙

○ : ON, ● : OFF, ⊙ : Rapid flashing

(Fig. 8)

LED displays indicated when step 6 is taken					
D800	D801	D802	D803	D804	D805
●	●	○	●	◇	○

○ : ON, ● : OFF, ◇ : Slow flashing

7. Hold down SW01 and SW02 simultaneously for at least 5 seconds to return the LED displays to the initial status. The existing piping is now supported by taking the above steps. In this status, the heating capacity may decrease during heating depending on the outside air temperature and indoor temperature.
- \* If there is any reason to doubt whether establishing support was successful in the course of this operation, hold down SW01 and SW02 simultaneously for at least 5 seconds to return to the initial status, and then repeat the setting steps.

## How to check the existing piping settings

You can check whether the existing piping settings are enabled.

1. Check that the LED displays are placed in their initial status. If not, place them in the initial status.
2. Hold down SW01 for at least 5 seconds, and check that D804 flashes slowly. (Fig. 9)
3. Press SW01 four times to set the LED displays (D800 to D805) to the "LED displays for existing piping settings" shown below. If the setting is enabled, D802 lights and D804 and D805 flash rapidly. (Fig. 10)
4. Hold down SW01 and SW02 simultaneously for at least 5 seconds to return the LED displays to the initial status.

(Fig. 9)

LED displays indicated when step 3 is taken					
D800	D801	D802	D803	D804	D805
○	●	●	●	◇	●

○ : ON, ● : OFF, ◇ : Slow flashing

(Fig. 10)

LED displays for existing piping settings					
D800	D801	D802	D803	D804	D805
●	●	○	●	◎	◎

○ : ON, ● : OFF, ◎ : Rapid flashing

## When restoring the factory defaults

To restore the factory defaults in situations such as when relocating the units, follow the steps below.

1. Check that the LED displays are placed in their initial status. If not, place them in the initial status.
2. Hold down SW01 for at least 5 seconds, and check that D804 flashes slowly. (Fig. 11)
3. Press SW01 20 times to set the LED displays (D800 to D805) to the "LED displays restored to factory defaults" shown below. (Fig. 12)

(Fig. 11)

LED displays indicated when step 2 is taken					
D800	D801	D802	D803	D804	D805
○	●	●	●	◇	●

○ : ON, ● : OFF, ◇ : Slow flashing

(Fig. 12)

LED displays restored to factory defaults					
D800	D801	D802	D803	D804	D805
●	●	●	●	◎	●

○ : ON, ● : OFF, ◎ : Rapid flashing

4. Hold down SW02 for at least 5 seconds, and check that D804 flashes slowly. (Fig. 13)
5. Hold down SW01 and SW02 simultaneously for at least 5 seconds to return the LED displays to the initial status.

(Fig. 13)

LED displays indicated when step 4 is taken					
D800	D801	D802	D803	D804	D805
●	●	●	●	◇	●

○ : ON, ● : OFF, ◇ : Slow flashing

# 14 Troubleshooting

You can perform fault diagnosis of the outdoor unit with the LEDs on the P.C. board of the outdoor unit in addition to using the check codes displayed on the wired remote controller of the indoor unit. Use the LEDs and check codes for various checks. Details of the check codes displayed on the wired remote controller of the indoor unit are described in the Installation Manual of the indoor unit.

## LED displays and check codes

○ ...ON ● ...OFF ◎ ...Rapid flashing (5 times/sec.)

No.	Trouble description	LED display					
		D800	D801	D802	D803	D804	D805
1	Normal	●	●	●	●	●	○
2	Discharge temp. sensor (TD) trouble	◎	●	●	●	●	○
3	Heat exchanger temp. sensor (TE) trouble	●	◎	●	●	●	○
4	Heat exchanger temp. sensor (TL) trouble	◎	◎	◎	●	●	○
5	Outside air temp. sensor (TO) trouble	●	●	◎	●	●	○
6	Suction temp. sensor (TS) trouble	◎	●	◎	●	●	○
7	Heat sink temp. sensor (TH) trouble	●	◎	◎	●	●	○
8	Miss-mounting of sensor (TE, TS)	◎	◎	◎	●	●	○
9	EEPROM trouble	●	◎	●	◎	●	○
10	Compressor break down	◎	◎	●	◎	●	○
11	Compressor lock	●	●	◎	◎	●	○
12	Current detection circuit trouble	◎	●	◎	◎	●	○
13	Case thermostat operation	●	◎	◎	◎	●	○
14	Unset model type of P.C.board	●	●	●	●	◎	○
15	MCU communication trouble	◎	●	●	●	◎	○
16	Discharge temp. trouble	●	◎	●	●	◎	○
17	High pressure SW operation	◎	◎	●	●	◎	○
18	Power supply trouble	●	●	◎	●	◎	○
19	Heat sink overheat trouble	●	◎	◎	●	◎	○
20	Gas leak detection	◎	◎	◎	●	◎	○
21	4-way valve inverse trouble	●	●	●	◎	◎	○
22	High pressure protective operation	◎	●	●	◎	◎	○
23	Fan system trouble	●	◎	●	◎	◎	○
24	Short-circuit of compressor drive element	◎	◎	●	◎	◎	○
25	Position detection circuit trouble	●	●	◎	◎	◎	○

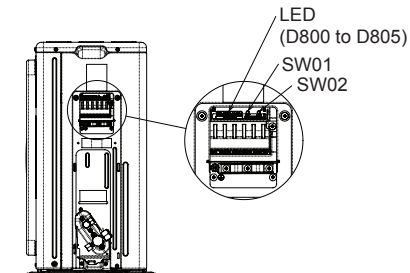

# 15 Appendix

## [1] Existing piping

### Work instructions

The existing R22 and R407C piping can be reused for our digital inverter R32 product installations.

### WARNING

Confirming the existence of scratches or dents on the existing pipes and confirming the reliability of the pipe strength are conventionally referred to the local site.

If the specified conditions can be cleared, it is possible to update existing R22 and R407C pipes to those for R32 models.

### Basic conditions needed to reuse existing pipes

Check and observe the presence of three conditions in the refrigerant piping works.

1. **Dry** (There is no moisture inside of the pipes.)
2. **Clean** (There is no dust inside of the pipes.)
3. **Tight** (There are no refrigerant leaks.)

### Restrictions for use of existing pipes

In the following cases, the existing pipes should not be reused as they are. Clean the existing pipes or exchange them with new pipes.

1. When a scratch or dent is heavy, be sure to use new pipes for the refrigerant piping works.
2. When the existing pipe thickness is thinner than the specified "Pipe diameter and thickness," be sure to use new pipes for the refrigerant piping works.
  - The operating pressure of R32 is high. If there is a scratch or dent on the pipe or a thinner pipe is used, the pressure strength may be inadequate, which may cause the pipe to break in the worst case.

### \* Pipe diameter and thickness (mm)

Reference outside diameter (mm)	Wall thickness (mm)	Material
6.4	0.8	—
9.5	0.8	—
12.7	0.8	—
15.9	1.0	—

- In case the pipe diameter is  $\varnothing$ 12.7 mm or less and the thickness is less than 0.7 mm, be sure to use new pipes for the refrigerant piping works.
3. When the outdoor unit was left with the pipes disconnected, or the gas leaked from the pipes and the pipes were not repaired and refilled.
    - There is the possibility of rain water or air, including moisture, entering the pipe.
  4. When refrigerant cannot be recovered using a refrigerant recovery unit.
    - There is the possibility that a large quantity of dirty oil or moisture remains inside the pipes.
  5. When a commercially available dryer is attached to the existing pipes.
    - There is the possibility that copper green rust has been generated.
  6. When the existing air conditioner is removed after refrigerant has been recovered.
 

Check if the oil is judged to be clearly different from normal oil.

    - The refrigerant oil is copper rust green in color: There is the possibility that moisture has mixed with the oil and rust has been generated inside the pipe.
    - There is discolored oil, a large quantity of residue, or a bad smell.
    - A large quantity of shiny metal dust or other wear residue can be seen in the refrigerant oil.
  7. When the air conditioner has a history of the compressor failing and being replaced.
    - When discolored oil, a large quantity of residue, shiny metal dust, or other wear residue or mixture of foreign matter is observed, trouble will occur.

8. When temporary installation and removal of the air conditioner are repeated such as when leased etc.
9. If the type of refrigerator oil of the existing air conditioner is other than the following oil (Mineral oil), Suniso, Freol-S, MS (Synthetic oil), alkyl benzene (HAB, Barrel-freeze), ester series, PVE only of ether series.
  - The winding-insulation of the compressor may deteriorate.

### NOTE

The above descriptions are results have been confirmed by our company and represent our views on our air conditioners, but do not guarantee the use of the existing pipes of air conditioners that have adopted R32 or R410A in other companies.

### Branching pipe for simultaneous operation system

In the concurrent twin system, when TOSHIBA has specified that branching pipe is to be used, it can be reused.

Branching pipe model name:  
RBC-TWP30E, RBC-TWP50E

On the existing air conditioner for simultaneous operation system (twin system), there are cases of branch pipes being used that have insufficient compressive strength.

In such case, please change the piping to a branch pipe for R32 or R410A.

### Curing of pipes

When removing and opening the indoor or outdoor unit for a long time, cure the pipes as follows:

- Otherwise rust may be generated when moisture or foreign matter due to condensation enters the pipes.
- The rust cannot be removed by cleaning, and new pipes are necessary.

Placement location	Term	Curing manner
Outdoors	1 month or more	Pinching
	Less than 1 month	Pinching or taping
Indoors	Every time	



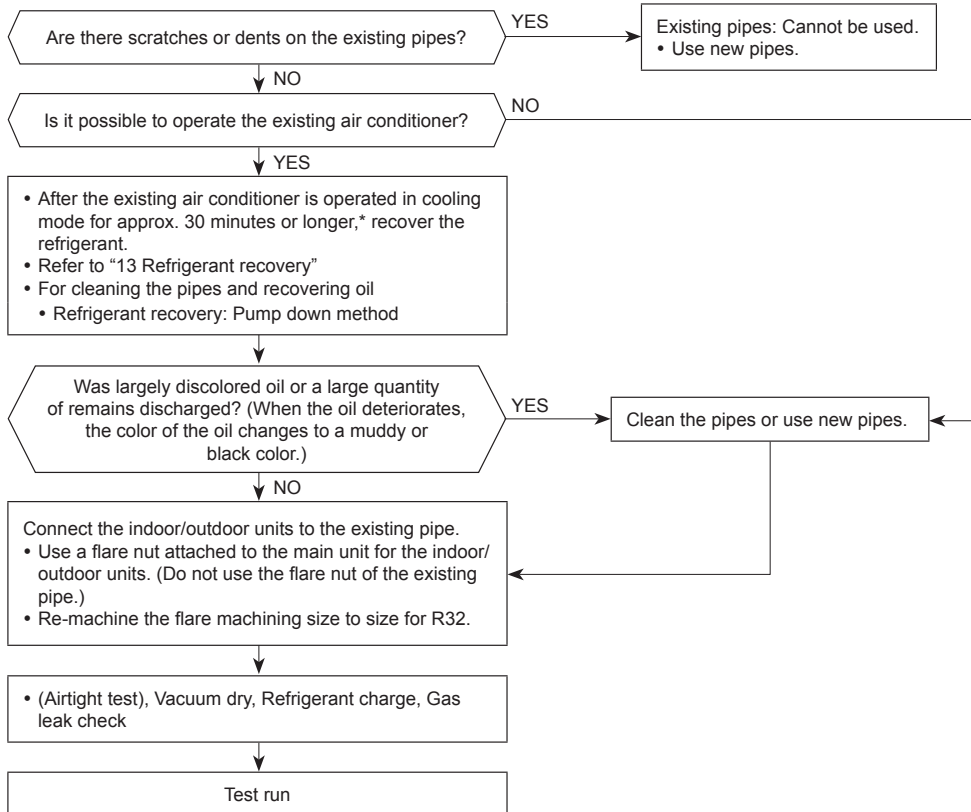

## [2] Minimum floor area : $A_{min}$ (m<sup>2</sup>)

	Total refrigerant quantity*	Floor standing unit	Wall mounted unit	Ceiling mounted unit
	$h_0$	0.6	1.8	2.2
	M (kg)	$A_{min}$ (m <sup>2</sup> )		
2HP	1.90	30.98	3.44	2.30
	1.92	31.63	3.51	2.35
	1.94	32.29	3.59	2.40
	1.96	32.96	3.66	2.45
	1.98	33.64	3.74	2.50
	2.00	34.32	3.81	2.55
	2.02	35.01	3.89	2.60
	2.04	35.71	3.97	2.66
	2.06	36.41	4.05	2.71
	2.08	37.12	4.12	2.76
	2.10	37.84	4.20	2.81
	2.12	38.56	4.28	2.87
	2.14	39.30	4.37	2.92
	2.16	40.03	4.45	2.98
	2.18	40.78	4.53	3.03
	2.20	41.53	4.61	3.09
	2.22	42.29	4.70	3.15
	2.24	43.05	4.78	3.20
	2.26	43.83	4.87	3.26
	2.28	44.61	4.96	3.32
	2.30	45.39	5.04	3.38
	2.32	46.18	5.13	3.44
	2.34	46.98	5.22	3.49
	2.36	47.79	5.31	3.55
	2.38	48.60	5.40	3.62
	2.40	49.42	5.49	3.68
	2.42	50.25	5.58	3.74
	2.44	51.09	5.68	3.80
	2.46	51.93	5.77	3.86
	2.48	52.77	5.86	3.93
2.50	53.63	5.96	3.99	
2.52	54.49	6.05	4.05	
2.54	55.36	6.15	4.12	
2.56	56.23	6.25	4.18	
2.58	57.12	6.35	4.25	
2.60	58.00	6.44	4.31	
2.62	58.90	6.54	4.38	
2.64	59.80	6.64	4.45	
2.66	60.71	6.75	4.52	
2.68	61.63	6.85	4.58	
Max.	2.70	62.55	6.95	4.65

\* Total refrigerant quantity: Refrigerant quantity pre-charged at factory + Additional refrigerant quantity charged during installation

# 16 Specifications

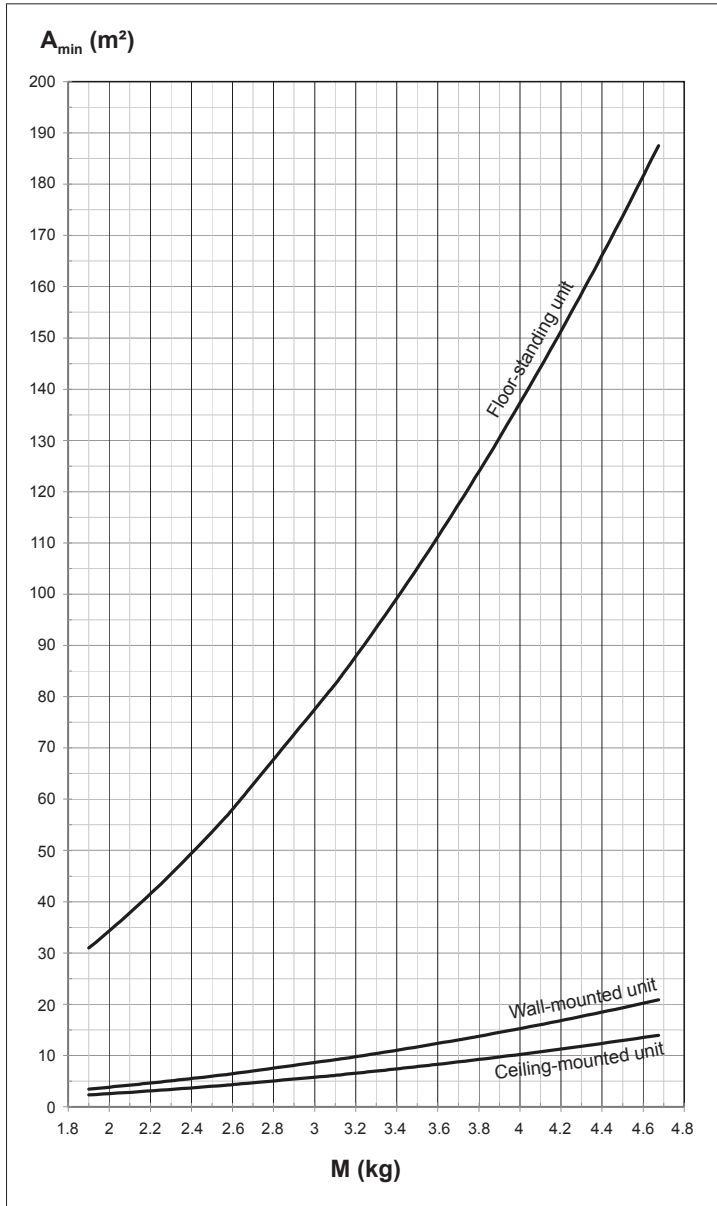

Model	Sound power level (dB(A))		Weight (kg)
	Cooling	Heating	
RAV-GP561ATP-E	*	*	45
RAV-GP561ATJP-E	*	*	45

\* Under 70 dB(A)

Product information of ecodesign requirements. (Regulation (EU) 2016/2281)  
<http://ecodesign.toshiba-airconditioning.eu/en>

## Declaration of conformity

Manufacturer: **TOSHIBA CARRIER (THAILAND) CO., LTD.**  
144 / 9 Moo 5, Bangkadi Industrial Park, Tivanon Road, Tambol Bangkadi,  
Amphur Muang, Pathumthani 12000, Thailand

TCF holder: **TOSHIBA CARRIER EUROPE S.A.S**  
Route de Thil 01120 Montluel FRANCE

Hereby declares that the machinery described below:

Generic Denomination: Air Conditioner

Model / type: RAV-GP561ATP-E  
RAV-GP561ATJP-E

Commercial name: Super Digital Inverter Series Air Conditioner

Complies with the provisions of the Machinery Directive (Directive 2006/42/EC) and the regulations transposing into national law

Note: This declaration becomes invalid if technical or operational modifications are introduced without the manufacturer's consent.

## Warnings on refrigerant leakage

### Check of concentration limit

**The room in which the air conditioner is to be installed requires a design that in the event of refrigerant gas leaking out, its concentration will not exceed a set limit.**

The refrigerant R32 which is used in the air conditioner is safe, without the toxicity or combustibility of ammonia, and is not restricted by laws to be imposed which protect the ozone layer. However, since it contains more than air, it poses the risk of suffocation if its concentration should rise excessively. Suffocation from leakage of R32 is almost non-existent.

If a conditioner system is to be installed in a small room, select a suitable model and installation procedure so that if the refrigerant accidentally leaks out, its concentration does not reach the limit (and in the event of an emergency, measures can be made before injury can occur).

In a room where the concentration may exceed the limit, create an opening with adjacent rooms, or install mechanical ventilation combined with a gas leak detection device.

The concentration is as given below.

$$\frac{\text{Total amount of refrigerant (kg)}}{\text{Min. volume of the indoor unit installed room (m}^3\text{)}} \leq \text{Concentration limit (kg/m}^3\text{)}$$

Refrigerant Concentration Limit shall be in accordance with local regulations.

**TOSHIBA CARRIER (THAILAND) CO.,LTD.**

144 / 9 Moo 5, Bangkadi Industrial Park, Tivanon Road, Tambol Bangkadi, Amphur Muang, Pathumthani 12000, Thailand

**1127050201**