

TOSHIBA
Leading Innovation >>>

AIR CONDITIONER (SPLIT TYPE)
Installation manual



Outdoor Unit

For commercial use

Model name:

RAV-SM1603AT-E1
RAV-SM1603ATJ-E1

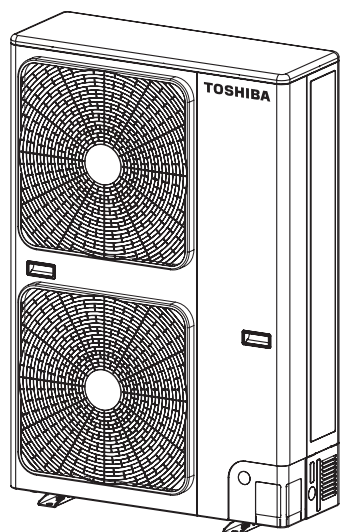

Original instruction

ADOPTION OF NEW REFRIGERANT
This Air Conditioner is a new type that has adopted a new refrigerant HFC (R410A) instead of the conventional refrigerant R22 in order to prevent destruction of the ozone layer.

This equipment complies with IEC 61000-3-12 provided that the short-circuit power Ssc is greater than or equal to Ssc (*1) at the interface point between the user's supply and the public system. It is the responsibility of the installer or user of the equipment to ensure, by consultation with the distribution network operator if necessary, that the equipment is connected only to a supply with a short-circuit power Ssc greater than or equal to Ssc (*1).

Ssc (*1)

Model	Ssc (KVA)		
	Single system	Twin system	Triple system
RAV-SM1603AT(J)-E1	890	1160	2160

Contents

1	PRECAUTIONS FOR SAFETY	3
2	ACCESSORY PARTS AND REFRIGERANT	7
3	INSTALLATION OF NEW REFRIGERANT AIR CONDITIONER	8
4	INSTALLATION CONDITIONS	9
5	REFRIGERANT PIPING	11
6	AIR PURGING	13
7	ELECTRICAL WORK	14
8	EARTHING	17
9	FINISHING	17
10	TEST RUN	17
11	ANNUAL MAINTENANCE	17
12	FUNCTIONS TO BE IMPLEMENTED LOCALLY	18
13	TROUBLESHOOTING	19
14	APPENDIX	19
15	SPECIFICATIONS	21

Thank you for purchasing this Toshiba air conditioner.

Please read carefully through these instructions that contain important information which complies with the "Machinery" Directive (Directive 2006/42/EC), and ensure that you understand them.

After reading these instructions, be sure to keep them in a safe place together with the Owner's Manual and Installation Manual supplied with your product.

Generic Denomination: Air Conditioner

Definition of Qualified Installer or Qualified Service Person

The air conditioner must be installed, maintained, repaired and removed by a qualified installer or qualified service person. When any of these jobs is to be done, ask a qualified installer or qualified service person to do them for you. A qualified installer or qualified service person is an agent who has the qualifications and knowledge described in the table below.

Agent	Qualifications and knowledge which the agent must have
Qualified installer	<ul style="list-style-type: none"> The qualified installer is a person who installs, maintains, relocates and removes the air conditioners made by Toshiba Carrier Corporation. He or she has been trained to install, maintain, relocate and remove the air conditioners made by Toshiba Carrier Corporation or, alternatively, he or she has been instructed in such operations by an individual or individuals who have been trained and is thus thoroughly acquainted with the knowledge related to these operations. The qualified installer who is allowed to do the electrical work involved in installation, relocation and removal has the qualifications pertaining to this electrical work as stipulated by the local laws and regulations, and he or she is a person who has been trained in matters relating to electrical work on the air conditioners made by Toshiba Carrier Corporation or, alternatively, he or she has been instructed in such matters by an individual or individuals who have been trained and is thus thoroughly acquainted with the knowledge related to this work. The qualified installer who is allowed to do the refrigerant handling and piping work involved in installation, relocation and removal has the qualifications pertaining to this refrigerant handling and piping work as stipulated by the local laws and regulations, and he or she is a person who has been trained in matters relating to refrigerant handling and piping work on the air conditioners made by Toshiba Carrier Corporation or, alternatively, he or she has been instructed in such matters by an individual or individuals who have been trained and is thus thoroughly acquainted with the knowledge related to this work. The qualified installer who is allowed to work at heights has been trained in matters relating to working at heights with the air conditioners made by Toshiba Carrier Corporation or, alternatively, he or she has been instructed in such matters by an individual or individuals who have been trained and is thus thoroughly acquainted with the knowledge related to this work.

Qualified service person	<ul style="list-style-type: none"> The qualified service person is a person who installs, repairs, maintains, relocates and removes the air conditioners made by Toshiba Carrier Corporation. He or she has been trained to install, repair, maintain, relocate and remove the air conditioners made by Toshiba Carrier Corporation or, alternatively, he or she has been instructed in such operations by an individual or individuals who have been trained and is thus thoroughly acquainted with the knowledge related to these operations. The qualified service person who is allowed to do the electrical work involved in installation, repair, relocation and removal has the qualifications pertaining to this electrical work as stipulated by the local laws and regulations, and he or she is a person who has been trained in matters relating to electrical work on the air conditioners made by Toshiba Carrier Corporation or, alternatively, he or she has been instructed in such matters by an individual or individuals who have been trained and is thus thoroughly acquainted with the knowledge related to this work. The qualified service person who is allowed to do the refrigerant handling and piping work involved in installation, repair, relocation and removal has the qualifications pertaining to this refrigerant handling and piping work as stipulated by the local laws and regulations, and he or she is a person who has been trained in matters relating to refrigerant handling and piping work on the air conditioners made by Toshiba Carrier Corporation or, alternatively, he or she has been instructed in such matters by an individual or individuals who have been trained and is thus thoroughly acquainted with the knowledge related to this work. The qualified service person who is allowed to work at heights has been trained in matters relating to working at heights with the air conditioners made by Toshiba Carrier Corporation or, alternatively, he or she has been instructed in such matters by an individual or individuals who have been trained and is thus thoroughly acquainted with the knowledge related to this work.
--------------------------	--

Definition of Protective Gear





When the air conditioner is to be transported, installed, maintained, repaired or removed, wear protective gloves and "safety" work clothing.

In addition to such normal protective gear, wear the protective gear described below when undertaking the special work detailed in the table below.

Failure to wear the proper protective gear is dangerous because you will be more susceptible to injury, burns, electric shocks and other injuries.

Work undertaken	Protective gear worn
All types of work	Protective gloves "Safety" working clothing
Electrical-related work	Gloves to provide protection for electricians and from heat Insulating shoes Clothing to provide protection from electric shock
Work done at heights (50 cm or more)	Helmets for use in industry
Transportation of heavy objects	Shoes with additional protective toe cap
Repair of outdoor unit	Gloves to provide protection for electricians and from heat

■ Warning Indications on the Air Conditioner Unit

Warning indication		Description
 <p>WARNING</p> <p>ELECTRICAL SHOCK HAZARD Disconnect all remote electric power supplies before servicing.</p>	<p>WARNING</p> <p>ELECTRICAL SHOCK HAZARD Disconnect all remote electric power supplies before servicing.</p>	
 <p>WARNING</p> <p>Moving parts. Do not operate unit with grille removed. Stop the unit before the servicing.</p>	<p>WARNING</p> <p>Moving parts. Do not operate unit with grille removed. Stop the unit before the servicing.</p>	
 <p>CAUTION</p> <p>High temperature parts. You might get burned when removing this panel.</p>	<p>CAUTION</p> <p>High temperature parts. You might get burned when removing this panel.</p>	
 <p>CAUTION</p> <p>Do not touch the aluminum fins of the unit. Doing so may result in injury.</p>	<p>CAUTION</p> <p>Do not touch the aluminum fins of the unit. Doing so may result in injury.</p>	
 <p>CAUTION</p> <p>BURST HAZARD Open the service valves before the operation, otherwise there might be the burst.</p>	<p>CAUTION</p> <p>BURST HAZARD Open the service valves before the operation, otherwise there might be the burst.</p>	

1 PRECAUTIONS FOR SAFETY

The manufacturer shall not assume any liability for the damage caused by not observing the description of this manual.

WARNING

General

- Before starting to install the air conditioner, read carefully through the Installation Manual, and follow its instructions to install the air conditioner.
- Only a qualified installer(*1) or qualified service person(*1) is allowed to install the air conditioner. If the air conditioner is installed by an unqualified individual, a fire, electric shocks, injury, water leakage, noise and/or vibration may result.
- Do not use any refrigerant different from the one specified for complement or replacement. Otherwise, abnormally high pressure may be generated in the refrigeration cycle, which may result in a failure or explosion of the product or an injury to your body.
- When transporting the air conditioner, use a forklift and when moving the air conditioner by hand, move the unit with 4 people.
- Before opening the intake grille of the indoor unit or service panel of the outdoor unit, set the circuit breaker to the OFF position. Failure to set the circuit breaker to the OFF position may result in electric shocks through contact with the interior parts. Only a qualified installer(*1) or qualified service person(*1) is allowed to remove the intake grille of the indoor unit or service panel of the outdoor unit and do the work required.

- Before carrying out the installation, maintenance, repair or removal work, be sure to set the circuit breaker to the OFF position. Otherwise, electric shocks may result.
- Place a “Work in progress” sign near the circuit breaker while the installation, maintenance, repair or removal work is being carried out. There is a danger of electric shocks if the circuit breaker is set to ON by mistake.
- Only a qualified installer(*1) or qualified service person(*1) is allowed to undertake work at heights using a stand of 50 cm or more.
- Wear protective gloves and safety work clothing during installation, servicing and removal.
- Do not touch the aluminum fin of the outdoor unit. You may injure yourself if you do so. If the fin must be touched for some reason, first put on protective gloves and safety work clothing, and then proceed.
- Do not climb onto or place objects on top of the outdoor unit. You may fall or the objects may fall off of the outdoor unit and result in injury.
- When working at heights, use a ladder which complies with the ISO 14122 standard, and follow the procedure in the ladder’s instructions. Also wear a helmet for use in industry as protective gear to undertake the work.
- When cleaning the filter or other parts of the outdoor unit, set the circuit breaker to OFF without fail, and place a “Work in progress” sign near the circuit breaker before proceeding with the work.
- When working at heights, put a sign in place so that no-one will approach the work location, before proceeding with the work. Parts and other objects may fall from above, possibly injuring a person below.
- The refrigerant used by this air conditioner is the R410A.
- You shall ensure that the air conditioner is transported in stable condition.

- Do not modify the products. Do not also disassemble or modify the parts. It may cause a fire, electric shock or injury.
- This appliance is intended to be used by expert or trained users in shops, in light industry, or for commercial use by lay persons.

Selection of installation location

- If you install the unit in a small room, take appropriate measures to prevent the refrigerant from exceeding the limit concentration even if it leaks. Consult the dealer from whom you purchased the air conditioner when you implement the measures. Accumulation of highly concentrated refrigerant may cause an oxygen deficiency accident.
- Do not install the air conditioner in a location that may be subject to a risk of exposure to a combustible gas. If a combustible gas leaks and becomes concentrated around the unit, a fire may occur.
- When transporting the air conditioner, wear shoes with additional protective toe caps.
- When transporting the air conditioner, do not take hold of the bands around the packing carton. You may injure yourself if the bands should break.
- Do not place any combustion appliance in a place where it is directly exposed to the wind of air conditioner, otherwise it may cause imperfect combustion.

Installation

- Install the air conditioner at enough strong places to withstand the weight of the unit. If the strength is not enough, the unit may fall down resulting in injury.
- Follow the instructions in the Installation Manual to install the air conditioner. Failure to follow these instructions may cause the product to fall down or topple over or give rise to noise, vibration, water leakage, etc.

- The designated bolts (M10) and nuts (M10) for securing the outdoor unit must be used when installing the unit.
- Install the outdoor unit properly in a location that is durable enough to support the weight of the outdoor unit. Insufficient durability may cause the outdoor unit to fall, which may result in injury.
- If refrigerant gas has leaked during the installation work, ventilate the room immediately. If the leaked refrigerant gas comes in contact with fire, noxious gas may be generated.

Refrigerant piping

- Install the refrigerant pipe securely during the installation work before operating the air conditioner. If the compressor is operated with the valve open and without refrigerant pipe, the compressor sucks air and the refrigeration cycles is over pressurized, which may cause a injury.
- Tighten the flare nut with a torque wrench in the specified manner. Excessive tighten of the flare nut may cause a crack in the flare nut after a long period, which may result in refrigerant leakage.
- When the air conditioner has been installed or relocated, follow the instructions in the Installation Manual and purge the air completely so that no gases other than the refrigerant will be mixed in the refrigerating cycle. Failure to purge the air completely may cause the air conditioner to malfunction.
- Nitrogen gas must be used for the airtight test.
- The charge hose must be connected in such a way that it is not slack.

Electrical wiring

- Only a qualified installer(*1) or qualified service person(*1) is allowed to carry out the electrical work of the air conditioner. Under no circumstances must this work be done by an unqualified individual since failure to carry out the work properly may result in electric shocks and/or electrical leaks.

- The appliance shall be installed in accordance with national wiring regulations. Capacity shortages of the power circuit or an incomplete installation may cause an electric shock or fire.
- Use wiring that meets the specifications in the Installation Manual and the stipulations in the local regulations and laws. Use of wiring which does not meet the specifications may give rise to electric shocks, electrical leakage, smoking and/or a fire.
- Be sure to connect earth wire. (Grounding work)
Incomplete grounding causes an electric shock.
- Do not connect ground wires to gas pipes, water pipes, and lightning rods or ground wires for telephone wires.
- After completing the repair or relocation work, check that the ground wires are connected properly.
- Install a circuit breaker that meets the specifications in the installation manual and the stipulations in the local regulations and laws.
- Install the circuit breaker where it can be easily accessed by the agent.
- When installing the circuit breaker outdoors, install one which is designed to be used outdoors.
- Under no circumstances must the power cable be extended.
Connection trouble in the places where the cable is extended may give rise to smoking and/or a fire.

Test run

- Before operating the air conditioner after having completed the work, check that the electrical parts box cover of the indoor unit and service panel of the outdoor unit are closed, and set the circuit breaker to the ON position. You may receive an electric shock etc. if the power is turned on without first conducting these checks.

-
- When you have noticed that some kind of trouble (such as when an error display has appeared, there is a smell of burning, abnormal sounds are heard, the air conditioner fails to cool or heat or water is leaking) has occurred in the air conditioner, do not touch the air conditioner yourself but set the circuit breaker to the OFF position, and contact a qualified service person. Take steps to ensure that the power will not be turned on (by marking “out of service” near the circuit breaker, for instance) until qualified service person arrives. Continuing to use the air conditioner in the trouble status may cause mechanical problems to escalate or result in electric shocks, etc.
 - After the work has finished, be sure to use an insulation tester set (500V Megger) to check the resistance is 1 MΩ or more between the charge section and the non-charge metal section (Earth section). If the resistance value is low, a disaster such as a leak or electric shock is caused at user’s side.
 - Upon completion of the installation work, check for refrigerant leaks and check the insulation resistance and water drainage. Then conduct a test run to check that the air conditioner is operating properly.
 - After the installation work, confirm that refrigerant gas does not leak. If refrigerant gas leaks into the room and flows near a fire source, such as a cooking range, noxious gas may be generated.

Explanations given to user

- Upon completion of the installation work, tell the user where the circuit breaker is located. If the user does not know where the circuit breaker is, he or she will not be able to turn it off in the event that trouble has occurred in the air conditioner.

- If you have discovered that the fan guard is damaged, do not approach the outdoor unit but set the circuit breaker to the OFF position, and contact a qualified service person(*1) to have the repairs done. Do not set the circuit breaker to the ON position until the repairs are completed.
- After the installation work, follow the Owner’s Manual to explain to the customer how to use and maintain the unit.

Relocation

- Only a qualified installer(*1) or qualified service person(*1) is allowed to relocate the air conditioner. It is dangerous for the air conditioner to be relocated by an unqualified individual since a fire, electric shocks, injury, water leakage, noise and/or vibration may result.
 - When carrying out the pump-down work shut down the compressor before disconnecting the refrigerant pipe. Disconnecting the refrigerant pipe with the service valve left open and the compressor still operating will cause air, etc. to be sucked in, raising the pressure inside the refrigeration cycle to an abnormally high level, and possibly resulting in reputing, injury, etc.
-

⚠ CAUTION

New Refrigerant Air Conditioner Installation

• THIS AIR CONDITIONER ADOPTS THE NEW HFC REFRIGERANT (R410A) WHICH DOES NOT DESTROY OZONE LAYER.

R410A refrigerant is apt to be affected by impurities such as water, oxidizing membrane, and oils because the working pressure of R410A refrigerant is approx. 1.6 times as that of refrigerant R22. Accompanied with the adoption of the new refrigerant, the refrigeration machine oil has also been changed. Therefore, during installation work, be sure that water, dust, former refrigerant, or refrigeration machine oil does not enter the new type refrigerant R410A air conditioner circuit.

To prevent mixing of refrigerant or refrigerating machine oil, the sizes of connecting sections of charging port on main unit and installation tools are different from those of the conventional refrigerant units.

Accordingly, special tools are required for the new refrigerant (R410A) units. For connecting pipes, use new and clean piping materials with high pressure fittings made for R410A only, so that water and/or dust does not enter.







Do not wash air conditioners with pressure washers.

- Electric leaks may cause electric shocks or fires.

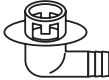
(*1) Refer to the "Definition of Qualified Installer or Qualified Service Person."

2 ACCESSORY PARTS AND REFRIGERANT

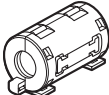
■ Accessory Parts

Part name	Q'ty	Shape	Usage
Outdoor unit installation manual	1		Hand this directly to the customer. (For other languages that do not appear in this Installation Manual, please refer to the enclosed CD-R.)
CD-ROM	1	—	Installation manual
Drain nipple	1		
Waterproof rubber cap	5		
Protective bush	1		For protecting wires (pipe cover)
Guard material for passage part	1		For protecting passage part (pipe cover)
Ferrite core	1		For conforming to EMC standards for twin/triple systems Color: White (Used for indoor/outdoor connecting wires)
Clamp filter	1		For conforming to EMC standards for twin/triple systems Color: Gray (Used for outdoor fan motor lead wire)
Banding band	2		For conforming to EMC standards for twin/triple systems (For clamping the clamp filter and ferrite core)

3 INSTALLATION OF NEW REFRIGERANT AIR CONDITIONER

- The R410A refrigerant is more susceptible to impurities such as water, oxide membranes, oils, and fats. With the adoption of the new refrigerant, the refrigerating oil has also been changed. Be careful not to let water, dust, conventional refrigerant, and/or conventional refrigerating oil enter the refrigerating cycle of the new refrigerant air conditioner.
- To prevent different refrigerant or refrigerating oil from becoming mixed, the sizes of the charging port of the unit and the installation tool connection sections are different from those of the conventional refrigerant. Accordingly, the following exclusive tools are required for the new refrigerant R410A.

Required Tools/Equipment and Precautions for Use

Prepare the tools and equipment listed in the following table before starting the installation work. Newly prepared tools and equipment must be used exclusively.

Legend

△ : Prepared newly (Use for R410A only. Do not use for refrigerant R22 or R407C etc.)

⊙ : Conventional tools/equipment are available

Tools/equipment	Use	How to use tools/equipment
Gauge manifold	Vacuuming/charging refrigerant and operation check	△ Prepared newly for R410A only
Charging hose		△ Prepared newly for R410A only
Charging cylinder	Can not be used	Unusable (Use the refrigerant charging measure instead.)
Gas leak detector	Gas leak check	△ Prepared newly
Vacuum pump	Vacuum drying	Unusable
Vacuum pump with backflow prevention function	Vacuum drying	⊙ R22 (Conventional tools)
Flare tool	Flare machining of pipes	⊙ Usable if dimensions are adjusted.
Bender	Bending pipes	⊙ R22 (Conventional tools)
Refrigerant recovery equipment	Refrigerant recovery	△ For R410A only
Torque wrench	Tightening flare nuts	△ Exclusive for Ø12.7 mm and Ø15.9 mm

Pipe cutter	Cutting pipes	⊙ R22 (Conventional tools)
Welding machine and nitrogen cylinder	Welding pipes	⊙ R22 (Conventional tools)
Refrigerant charging measure	Charging refrigerant	⊙ R22 (Conventional tools)

Refrigerant Piping

New refrigerant (R410A)

When using the conventional piping kit

- When using the conventional piping kit with no indication of applicable refrigerant types, be sure to use it with a wall thickness of 0.8 mm for Ø9.5 mm and with a wall thickness of 1.0 mm for Ø15.9 mm. Do not use the conventional piping kit with a wall thickness less than these thicknesses due to insufficient pressure capacity.

When using general copper pipes

- Use general copper pipes with a wall thickness of 0.8 mm for Ø9.5 mm and with a wall thickness of 1.0 mm for Ø15.9 mm. Do not use any copper pipes with a wall thickness less than these thicknesses.

Flare nuts and flare machining

- The flare nuts and flare machining are different from those for the conventional refrigerant. Use the flare nuts supplied with the air conditioner or those for R410A.
- Before performing flare machining, carefully read "REFRIGERANT PIPING".

4 INSTALLATION CONDITIONS

■ Before installation

Be sure to prepare to the following items before installation.

Length of refrigerant pipe

Length of refrigerant pipe connected to indoor/outdoor unit	Item
5 to 30 m	Addition of refrigerant is unnecessary at the local site.
*31 to 50 m	<Addition of refrigerant> Add 40 g of refrigerant for every 1 m of piping that exceeds 30 m.

- * Caution during addition of refrigerant
When the total length of refrigerant piping exceeds 30 m, add 40 g/m of refrigerant up to a maximum total length of piping at 50 m. (Max. amount of additional refrigerant is 800 g.)
Charge the refrigerant accurately. Overcharging may cause serious trouble with the compressor.
- Do not connect a refrigerant pipe that is shorter than **5 m**.
This may cause a malfunction of the compressor or other devices.

■ Airtight test

- Before starting an airtight test, further tighten the spindle valves on the gas and liquid sides.
- Pressurize the pipe with nitrogen gas charged from the service port to the design pressure (4.15 MPa) to conduct an airtight test.
- After the airtight test is completed, evacuate the nitrogen gas.

Air purge

- To purge air, use a vacuum pump.
- Do not use refrigerant charged in the outdoor unit to purge air. (The air purge refrigerant is not contained in the outdoor unit.)

Electrical wiring

- Be sure to fix the power wires and indoor/outdoor connecting wires with clamps so that they do not come into contact with the cabinet, etc.

Earthing

- Proper earthing can prevent charging of electricity on the outdoor unit surface due to the presence of a high frequency in the frequency converter (inverter) of the outdoor unit, as well as prevent electric shock. If the outdoor unit is not properly earthed, you may be exposed to an electric shock.

Test Run

Turn on the leakage breaker at least 12 hours before starting a test run to protect the compressor during startup.

■ Installation Location

⚠ CAUTION

Install the outdoor unit in a location that meets the following conditions after the customer's consent is obtained.

- A well-ventilated location free from obstacles near the air inlets and air outlet
- A location that is not exposed to rain or direct sunlight
- A location that does not increase the operating noise or vibration of the outdoor unit
- A location that does not produce any drainage problems from discharged water

Do not install the outdoor unit in the following locations.

- A location with a saline atmosphere (coastal area) or one that is full of sulfide gas (hot-spring area) (Special maintenance is required.)
- A location subject to oil, vapor, oily smoke, or corrosive gases
- A location in which organic solvent is used
- Places where iron or other metal dust is present. If iron or other metal dust adheres to or collects on the interior of the air conditioner, it may spontaneously combust and start a fire.
- A location where high-frequency equipment (including inverter equipment, private power generator, medical equipment, and communication equipment) is used (Installation in such a location may cause malfunction of the air conditioner, abnormal control or problems due to noise from such equipment.)
- A location in which the discharged air of the outdoor unit blows against the window of a neighboring house
- A location where the operating noise of the outdoor unit is transmitted
- When the outdoor unit is installed in an elevated position, be sure to secure its feet.
- A location in which drain water poses any problems.

- Install the outdoor unit in a location where the discharge air is not blocked.
- When an outdoor unit is installed in a location that is always exposed to strong winds like a coast or on the high stories of a building, secure normal fan operation by using a duct or wind shield.
- When installing the outdoor unit in a location that is constantly exposed to strong winds such as on the upper stairs or rooftop of a building, apply the windproofing measures referred to in the following examples.

- 1) Install the unit so that its discharge port faces the wall of the building.
Keep a distance 500 mm or more between the unit and wall surface.

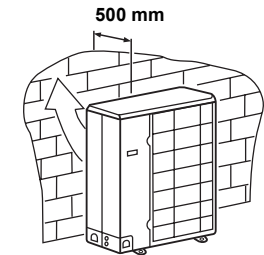

- 2) Consider the wind direction during the operational season of the air conditioner, and install the unit so that the discharge port is set at a right angle relative to the wind direction.

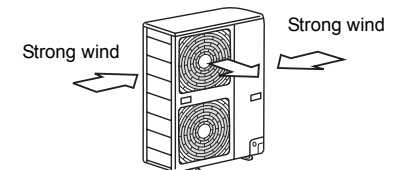

- When using an air conditioner under low outside temperature conditions (Outside temp: -5 °C or lower) in COOL mode, prepare a duct or wind shield so that it is not affected by the wind.
- When installing the unit in an area where snowfalls may be heavy, take steps to prevent the unit from being adversely affected by the fallen or accumulated snow.
 - Either make the foundation higher or install a stand (which is high enough to ensure that the unit will be above the fallen or accumulated snow) and place the unit on it.
 - Attach a snow shield (locally procured).

<Example>

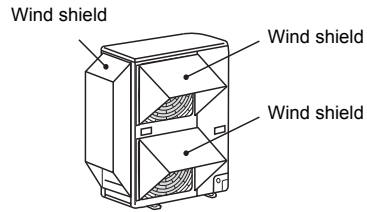

■ Necessary Space for Installation (Unit: mm)

Obstacle at rear side

Upper side is free

1. Single unit installation

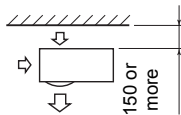

2. Obstacles on both right and left sides

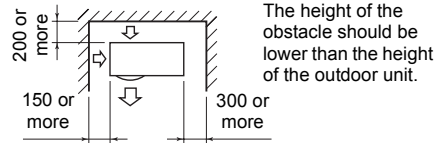

3. Serial installation of two or more units

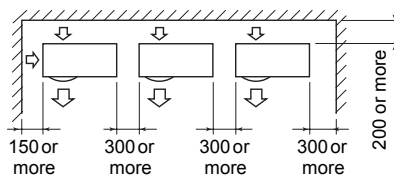

The height of the obstacle should be lower than the height of the outdoor unit.

Obstacle also above unit

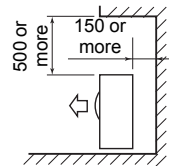

Obstacle in front

Above unit is free

1. Single unit installation

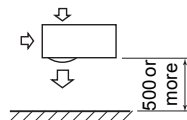

2. Serial installation of two or more units

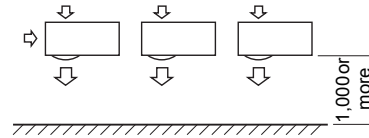

Obstacle also at the above unit

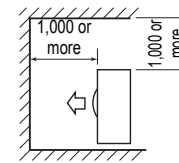

Obstacles in both front and rear of unit

Open above and to the right and left of the unit. The height of an obstacle in both the front and rear of the unit, should be lower than the height of the outdoor unit.

Standard installation

1. Single unit installation

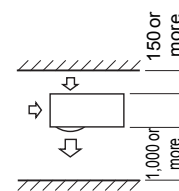

2. Serial installation of two or more units

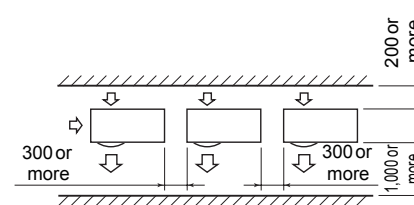

Serial installation in front and rear

Open above and to the right and left of the unit. The height of an obstacle in both the front and rear of the unit should be lower than the height of the outdoor unit.

Standard installation

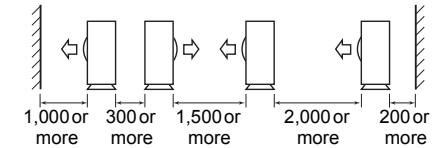

■ Installation of Outdoor Unit

- Before installation, check the strength and horizontalness of the base so that abnormal sounds do not emanate.
- According to the following base diagram, fix the base firmly with the anchor bolts. (Anchor bolt, nut: M10 x 4 pairs)

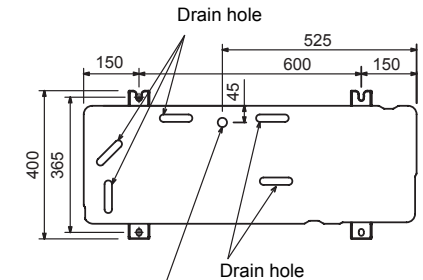

Drain nipple mounting hole

- As shown in the figure below, install the foundation and vibration-proof rubber pads to directly support the bottom surface of the fixing leg that is in contact with and underneath the bottom plate of the outdoor unit.
- * When installing the foundation for an outdoor unit with downward piping, consider the piping work.

5 REFRIGERANT PIPING

■ Knockout of Pipe Cover

Knockout procedure

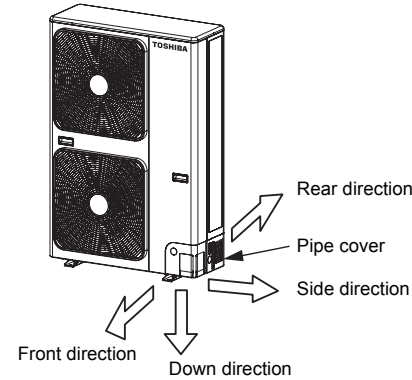

- After punching out the knockout hole, remove burrs from the hole and then install the supplied protective bush and guard material around the passage hole to protect wires and pipes. Be sure to attach the pipe covers after pipes have been connected. Cut the slits under the pipe covers to facilitate the installation. After connecting the pipes, be sure to mount the pipe cover. The pipe cover is easily mounted by cutting off the slit at the lower part of the pipe cover.

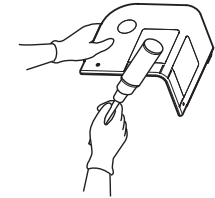

* Be sure to wear heavy work gloves while working.

- The indoor/outdoor connecting pipes can be connected in 4 directions. Take off the knockout part of the pipe cover through which pipes or wires will pass through the base plate.
- Detach the pipe cover and tap on the knockout section a few times with the shank of a screwdriver. A knockout hole can easily be punched.

- When collectively draining discharged water completely, use a drain pan.

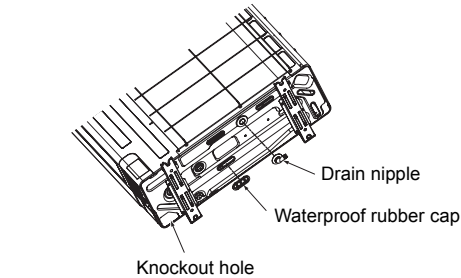
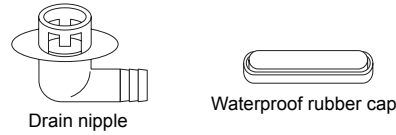

■ For Reference

If a heating operation is to be continuously performed for a long time under the condition that the outdoor temperature is 0 °C or lower, draining defrosted water may be difficult due to the bottom plate freezing, resulting in trouble with the cabinet or fan. It is recommended to procure an anti-freeze heater locally in order to safely install the air conditioner. For details, contact the dealer.

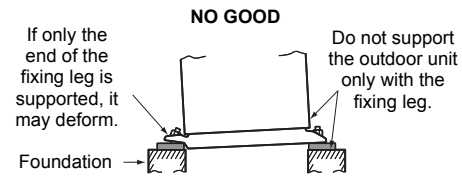
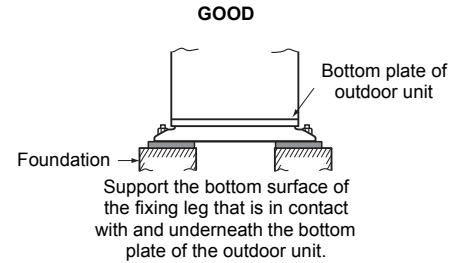
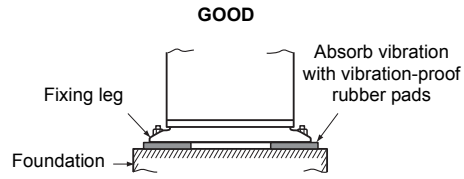

Set the out margin of the anchor bolt to 15 mm or less.

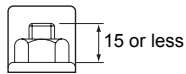

- When water is to be drained through the drain hose, attach the following drain nipple and waterproof rubber cap, and use the drain hose (Inner diam: 16 mm) sold on the market. Also seal knockout hole and the screws securely with silicone material, etc., to prevent water from leaking. Some conditions may cause dewing or dripping of water.

■ Optional Installation Parts (Locally procured)

	Parts name	Q'ty
A	Refrigerant piping Liquid side: Ø9.5 mm Gas side: Ø15.9 mm	One each
B	Pipe insulating material (polyethylene foam, 10 mm thick)	1
C	Putty, PVC tape	One each

■ Refrigerant Piping Connection

⚠ CAUTION

TAKE NOTE OF THESE 4 IMPORTANT POINTS BELOW FOR PIPING WORK

1. Keep dust and moisture away from inside the connecting pipes.
2. Tightly connect the connection between pipes and the unit.
3. Evacuate the air in the connecting pipes using a VACUUM PUMP.
4. Check for gas leaks at connection points.

Piping connection

Liquid side	
Outer diameter	Thickness
Ø9.5 mm	0.8 mm

Gas side	
Outer diameter	Thickness
Ø15.9 mm	1.0 mm

Flaring

1. Cut the pipe with a pipe cutter.
Be sure to remove burrs that may cause a gas leak.
2. Insert a flare nut into the pipe, and then flare the pipe.
Use the flare nuts supplied with the air conditioner or those for R410A.
Insert a flare nut into the pipe, and flare the pipe.
As the flaring sizes of R410A differ from those of refrigerant R22, the flare tools newly manufactured for R410A are recommended.
However, the conventional tools can be used by adjusting the projection margin of the copper pipe.

Projection margin in flaring: B (Unit: mm)

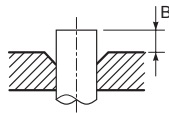

Rigid (Clutch type)

Outer diam. of copper pipe	R410A tool used	Conventional tool used
	R410A	
9.5	0 to 0.5	1.0 to 1.5
15.9		

Flaring diameter size: A (Unit: mm)



Outer dia. of copper pipe	A ⁺⁰ _{-0.4}
9.5	13.2
15.9	19.7

* In case of flaring for R410A with the conventional flare tool, pull the tool out approx. 0.5 mm more than that for R22 to adjust it to the specified flare size.
The copper pipe gauge is useful for adjusting the projection margin size.

■ Tightening of Connecting Part

1. Align the centers of the connecting pipes and fully tighten the flare nut with your fingers. Then fix the nut with a wrench as shown in the figure and tighten it with a torque wrench.

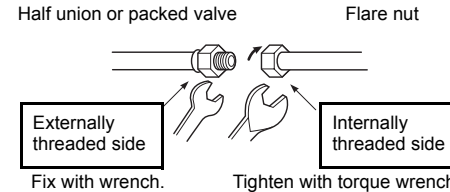

2. As shown in the figure, be sure to use two wrenches to loosen or tighten the flare nut of the valve on the gas side. If you use a single crescent, the flare nut cannot be tightened to the required tightening torque.
On the other hand, use a single crescent to loosen or tighten the flare nut of the valve on the liquid side.

(Unit: N•m)

Outer dia.	Tightening torque
Ø9.5	33 to 42
Ø15.9	33 to 42

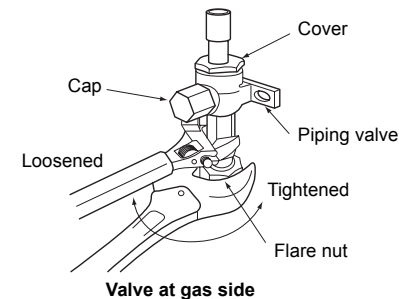

⚠ CAUTION

1. Do not put the crescent wrench on the cap or cover. The valve may break.
2. If applying excessive torque, the nut may break according to some installation conditions.

NO GOOD

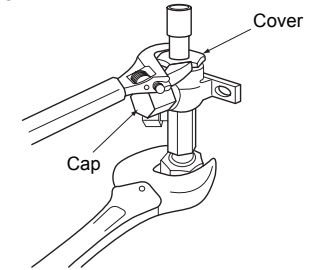

- After the installation work, be sure to check for gas leaks of the pipe connections with nitrogen.
- Pressure of R410A is higher than that of R22 (Approx. 1.6 times).
Therefore, using a torque wrench, tighten the flare pipe connecting sections that connect the indoor/outdoor units at the specified tightening torque.
Incomplete connections may cause not only a gas leak, but also trouble with the refrigeration cycle.

Do not apply refrigerating machine oil to the flared surface.

■ Refrigerant Pipe Length

Single

Allowable pipe length (m)	Height difference (Indoor-outdoor H) (m)	
	Indoor unit: Upper	Outdoor unit: Lower
Total length L	30	30
50		

Pipe diameter (mm)		Number of bent portions
Gas side	Liquid side	
Ø15.9	Ø9.5	10 or less

Simultaneous twin, triple

System	Allowable pipe length (m)			Height difference (m)		
	Total length • $l_1 + l_2$ • $l_1 + l_3$ • $l_1 + l_4$ Maximum	Distributed pipes • l_2 • l_3 • l_4 Maximum	Distributed pipes • $l_3 - l_2$ • $l_4 - l_2$ • $l_4 - l_3$ Maximum	Indoor-outdoor H		Indoor-indoor (Δh)
				Indoor unit: Upper	Outdoor unit: Upper	
TWIN	50	15	10	30	30	0.5
TRIPLE	50	15	10	30	30	0.5

System	Pipe diameter (mm)				Number of bent portions
	Main pipe		Branching pipe		
	Gas side	Liquid side	Gas side	Liquid side	
TWIN	Ø15.9	Ø9.5	Ø15.9	Ø9.5	10 or less
TRIPLE	Ø15.9	Ø9.5	Ø12.7	Ø6.4	10 or less

Figure of Single

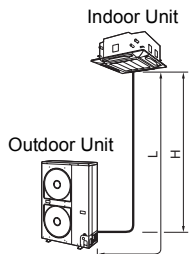

Figure of Simultaneous twin

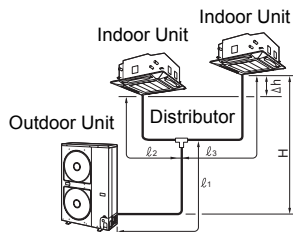
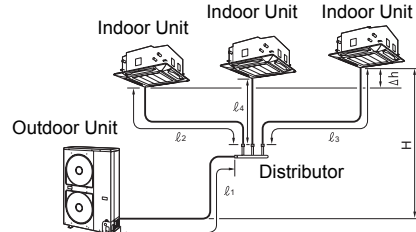

Figure of Simultaneous triple



6 AIR PURGING

■ Airtight test

Before starting an airtight test, further tighten the spindle valves on the gas side and liquid side.

Pressurize the pipe with nitrogen gas charged from the service port to the design pressure (4.15 MPa) to conduct the airtight test.

After the airtight test is completed, evacuate the nitrogen gas.

■ Air Purge

With respect to the preservation of the terrestrial environment, adopt "Vacuum pump" to purge air (Evacuate air in the connecting pipes) when installing the unit.

- Do not discharge the refrigerant gas to the atmosphere to preserve the terrestrial environment.
- Use a vacuum pump to discharge the air (nitrogen, etc.) that remains in the set. If air remains, the capacity may decrease.

For the vacuum pump, be sure to use one with a backflow preventer so that the oil in the pump does not backflow into the pipe of the air conditioner when the pump stops.

(If oil in the vacuum pump is put in an air conditioner including R410A, it may cause trouble with the refrigeration cycle.)

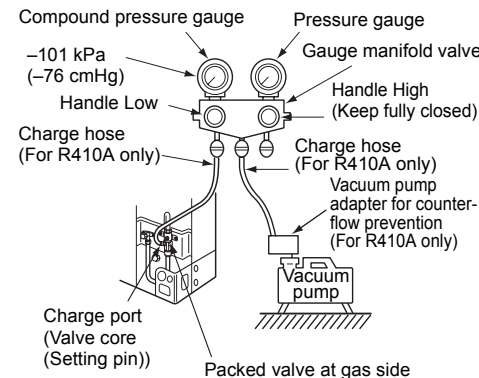

Vacuum pump

As shown in the figure, connect the charge hose after the manifold valve is closed completely.



Attach the connecting port of the charge hose with a projection to push the valve core (setting pin) to the charge port of the set.



Open Handle Low fully.



Turn ON the vacuum pump. (*1)



Loosen the flare nut of the packed valve (Gas side) a little to check that the air passes through. (*2)



Retighten the flare nut.



Execute vacuuming until the compound pressure gauge indicates -101 kPa (-76 cmHg). (*1)



Close Handle Low completely.



Turn OFF the vacuum pump.



Leave the vacuum pump as it is for 1 or 2 minutes, and check that the indicator of the compound pressure gauge does not return.



Open the valve stem or valve handle fully. (First, at liquid side, then gas side)



Disconnect the charge hose from the charge port.



Tighten the valve and caps of the charge port securely.

- *1 Use the vacuum pump, vacuum pump adapter, and gauge manifold correctly referring to the manuals supplied with each tool before using them.
Check that the vacuum pump oil is filled up to the specified line of the oil gauge.
- *2 When air is not charged, check again whether the connecting port of the discharge hose, which has a projection to push the valve core, is firmly connected to the charge port.

■ How to open the valve

Open or close the valve.

Liquid side

Open the valve with a 4 mm hexagon wrench.

Gas side

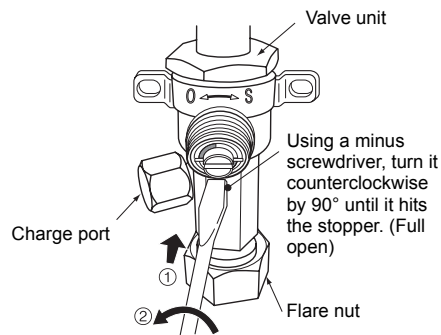

Handle position

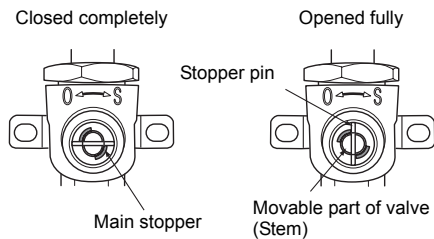

- While the valve is fully opened, after the screwdriver has reached the stopper, do not apply torque exceeding 5 N·m. Applying excessive torque may damage the valve.

Valve handling precautions

- Open the valve stem until it strikes the stopper. It is unnecessary to apply further force.
- Securely tighten the cap with a torque wrench.

Cap tightening torque

- The cap with the 9.5 mm outer diameter is available in two sizes in accordance with the type of packed valve for which the cap is used. The tightening torque depends on the width across flats of the cap so check it in the table below.

(Unit: N·m)

Valve size	Ø9.5 (H19 mm)	14 to 18
	Ø9.5 (H22 mm)	33 to 42
	Ø15.9	20 to 25
Charge port		14 to 18

■ Replenishing refrigerant

This model is a 30 m chargeless type that does not need to have its refrigerant replenished for refrigerant pipes up to 30 m. When a refrigerant pipe longer than 30 m is used, add the specified amount of refrigerant.

Refrigerant replenishing procedure

- After vacuuming the refrigerant pipe, close the valves and then charge the refrigerant while the air conditioner is not working.
- When the refrigerant cannot be charged to the specified amount, charge the required amount of refrigerant from the charge port of the valve on the gas side during cooling.

Requirement for replenishing refrigerant

Replenish liquid refrigerant.

When gaseous refrigerant is replenished, the refrigerant composition varies, which disables normal operation.

Adding additional refrigerant

31~50 m: L
40 g × (L-30)

- L: Pipe length
- To add additional refrigerant to twin system, refer to the installation manual supplied with the branching pipe (sold separately).
- The refrigerant need not be reduced for a 30 meter (or less) refrigerant pipe.

7 ELECTRICAL WORK

⚠ WARNING

- Using the specified wires, ensure that the wires are connected, and fix wires securely so that the external tension to the wires does not affect the connecting part of the terminals.**
Incomplete connection or fixation may cause a fire, etc.
- Be sure to connect the earth wire. (grounding work)**
Incomplete grounding may lead to electric shock.
Do not connect ground wires to gas pipes, water pipes, lightning rods or ground wires for telephone wires.
- The appliance shall be installed in accordance with national wiring regulations.**
Capacity shortages of the power circuit or an incomplete installation may cause an electric shock or fire.

NOTE

- Remove the panel, and you can see electric parts on the front side.
- A metal pipe can be installed through the hole for wiring. If the hole size does not fit the wiring pipe to be used, drill the hole again to an appropriate size.
- Be sure to clamp the power wires and indoor/outdoor connecting wires with a banding band along the connecting pipe so that the wires do not touch the compressor or discharge pipe.
(The compressor and the discharge pipe become hot.)
Furthermore, be sure to secure these wires with the cord clamps on the valve fixing plate.

⚠ CAUTION

- Wrong wiring may cause a burn-out of some electrical parts.
- Be sure to use the cord clamps attached to the product.
- Do not damage or scratch the conductive core or inner insulator of the power and inter-connecting wires when peeling them.
- Use the power and inter-connecting wires with specified thicknesses, specified types and protective devices required.

■ Wiring between Indoor Unit and Outdoor Unit

The dashed lines show on-site wiring.

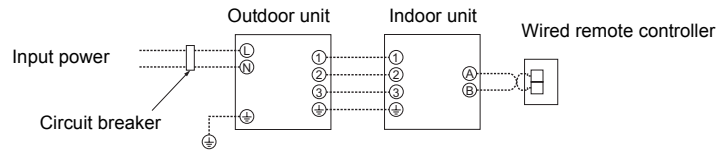

- Connect the indoor/outdoor connecting wires to the identical terminal numbers on the terminal block of each unit. Incorrect connection may cause a failure.

For the air conditioner, connect a power wire with the following specifications.

Model (RAV- Type)	SM160
Power supply	220-240 V~ 50 Hz
Maximum running current	32 A
Recommended field fuse	40 A
Power wire*	3 × 6 mm ² or more (H07 RN-F or 60245 IEC 66)
Indoor/outdoor connecting wires*	4 × 1.5 mm ² or more (H07 RN-F or 60245 IEC 66)

* Number of wire × wire size

How to wire

1. Remove the front panel (two screws).
2. Connect the connecting wire to the terminal as identified with their respective numbers on the terminal block of the indoor and outdoor units. H07 RN-F or 60245 IEC 66 (1.5 mm² or more)
 - When connecting the connecting wire to the outdoor unit terminal, prevent water from coming into the outdoor unit.
 - Insulate the unsheathed cords (conductors) with electrical insulation tape. Process them so that they do not touch any electrical or metal parts.
 - For interconnecting wires, do not use a wire joined to another on the way. Use wires long enough to cover the entire length.

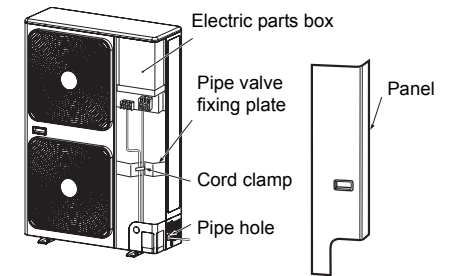

⚠ CAUTION

Wiring connections differ in conformance to EMC standards, depending whether the system is single, twin or triple. Connect wires according to respective instructions.

- An installation fuse must be used for the power supply line of this air conditioner.
- Incorrect/incomplete wiring may lead to an electrical fire or smoke.
- Prepare an exclusive power supply for the air conditioner.
- This product can be connected to the mains power. Fixed wire connections:
A switch that disconnects all poles and has a contact separation of at least 3 mm must be incorporated in the fixed wiring.

Wiring diagram

* For details on the remote controller wiring/installation, refer to the Installation Manual enclosed with the remote controller.

Single system

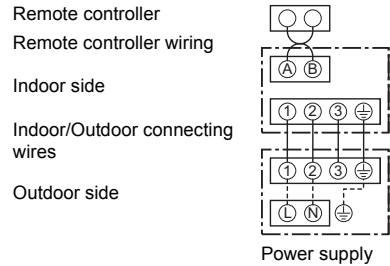

Simultaneous twin system

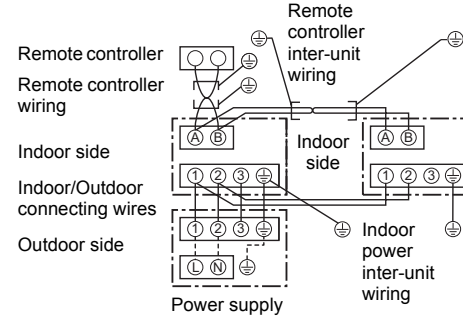

Simultaneous triple system

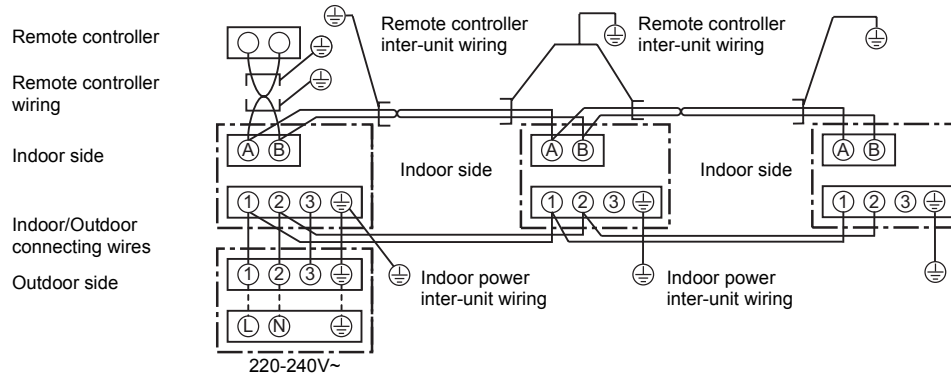

* Use 2-core shield wire (MVVS 0.5 to 2.0 mm² or more) for the remote controller wiring in the simultaneous twin system to prevent noise problems. Be sure to connect both ends of the shield wire to earth leads.

* Connect earth wires for each indoor unit in the simultaneous twin system.

Single system

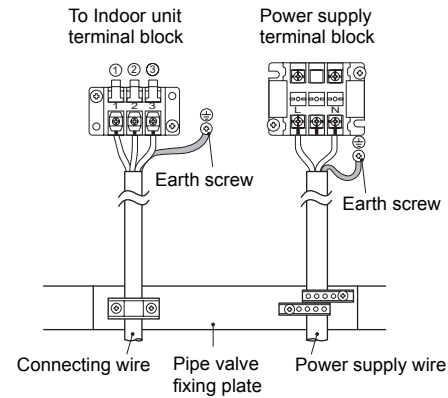

Stripping length power cord and connecting wire

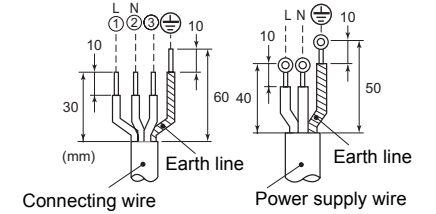

Twin system, Triple system

⚠ WARNING

For simultaneous twin and triple systems, perform the following to conform to EMC standards.

1. Attach the supplied ferrite core (white) to indoor/outdoor connecting wires.
 - Pass indoor/outdoor connecting wires ① and ② through the supplied ferrite core and wind them in a single turn, then connect them to the terminals of the outdoor unit. Connect the indoor/outdoor connecting wire ③ and earth wire directly to the outdoor unit terminals.
2. Attach the supplied clamp filter (gray) to the outdoor fan motor lead wire.
 - Attach the supplied clamp filter securely to the fan motor lead wire (lower) in the electric parts box of the outdoor unit.

• For details on how to install the indoor unit, refer to the Installation Manual supplied with the indoor unit.

<1. Attaching the ferrite core>

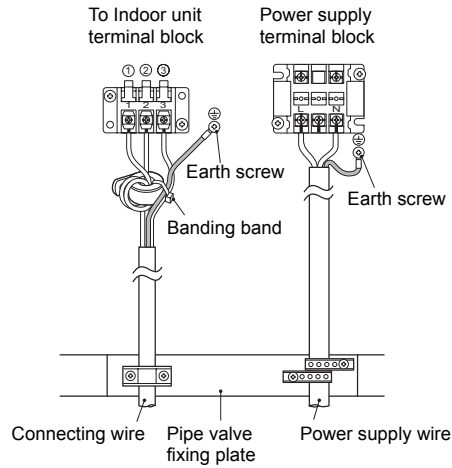

* Clamp the indoor/outdoor connecting wire ③, earth wire, and ferrite core with the supplied banding band.

Stripping length power cord and connecting wire

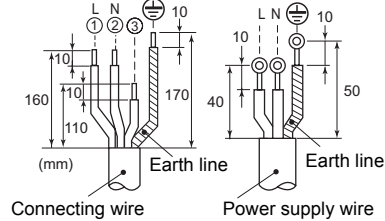

8 EARTHING

Connect the earth line properly following applicable technical standards. Connecting the earth line is essential to preventing electric shock and to reducing noise and electrical charges on the outdoor unit surface due to the high-frequency wave generated by the frequency converter (inverter) in the outdoor unit. If you touch the charged outdoor unit without an earth line, you may experience an electric shock.

9 FINISHING

After the refrigerant pipe, inter-unit wires, and drain pipe have been connected, cover them with finishing tape and clamp them to the wall with off-the-shelf support brackets or their equivalent. Keep the power wires and indoor/outdoor connecting wires off the valve on the gas side or pipes that have no heat insulator.

10 TEST RUN

- Turn on the leakage breaker at least 12 hours before starting a test run to protect the compressor during startup. To protect the compressor, power is supplied from the 220-240 VAC input to the unit to preheat the compressor.
- Check the following before starting a test run:
 - That all pipes are connected securely without leaks.
 - That the valve is open.
 If the compressor is operated with the valve closed, the outdoor unit will become overpressurized, which may damage the compressor or other components. If there is a leak at a connection, air can be sucked in and the internal pressure further increases, which may cause a burst or injury.
- Operate the air conditioner in the correct procedure as specified in the Owner's Manual.

11 ANNUAL MAINTENANCE

- For an air conditioning system that is operated on a regular basis, cleaning and maintenance of the indoor/outdoor units are strongly recommended. As a general rule, if an indoor unit is operated for about 8 hours daily, the indoor/outdoor units will need to be cleaned at least once every 3 months. This cleaning and maintenance should be carried out by a qualified service person. Failure to clean the indoor/outdoor units regularly will result in poor performance, icing, water leaking and even compressor failure.

<2. Attaching the clamp filter>

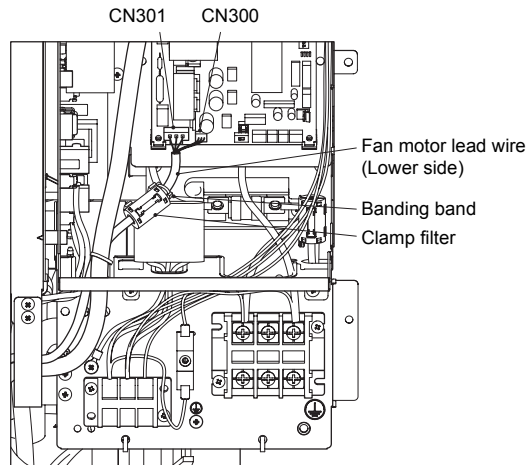

- Attach the supplied clamp filter to the lower outdoor fan motor lead wire.
- Make sure that the claw of the clamp filter is securely locked.
 - Pass the supplied banding band through the upper hole of the clamp filter to clamp it together with the fan motor lead wire.
 - The fan motor lead wires are connected to connectors CN301 and CN300 on the P.C. board of the outdoor unit.

12 FUNCTIONS TO BE IMPLEMENTED LOCALLY

■ Handling Existing Pipe

When using the existing pipe, carefully check for the following:

- Wall thickness (within the specified range)
- Scratches and dents
- Water, oil, dirt, or dust in the pipe
- Flare looseness and leakage from welds
- Deterioration of copper pipe and heat insulator

Cautions for using existing pipe

- Do not reuse a flare nut to prevent gas leaks.
Replace it with the supplied flare nut and then process it to a flare.
- Blow nitrogen gas or use an appropriate means to keep the inside of the pipe clean. If discolored oil or much residue is discharged, wash the pipe.
- Check welds, if any, on the pipe for gas leaks.

When the pipe corresponds to any of the following, do not use it. Install a new pipe instead.

- The pipe has been opened (disconnected from indoor unit or outdoor unit) for a long period.
- The pipe has been connected to an outdoor unit that does not use refrigerant R22, R410A or R407C.
- The existing pipe must have a wall thickness equal to or larger than the following thicknesses.

Reference outside diameter (mm)	Wall thickness (mm)
Ø9.5	0.8
Ø15.9	1.0
Ø19.0	1.0

- Do not use any pipe with a wall thickness less than these thicknesses due to insufficient pressure capacity.
- To use an existing Ø19.0 mm pipe, set bit 5 of SW801 (switch for existing pipe) on the P.C. board of the outdoor unit to ON. In this case, the heating performance may be reduced depending on the outside air temperature and room temperature.

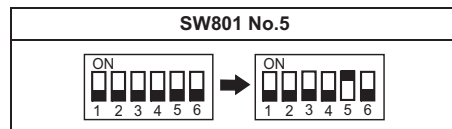

■ Recovering Refrigerant

- Use refrigerant recovery switch SW802 on the P.C. board of the outdoor unit to recover refrigerant when the indoor or outdoor unit is moved.

Procedure

1. Turn on the power of the air conditioner.
2. Select the FAN mode for indoor unit operation with the remote controller.
3. Press refrigerant recovery switch SW802 on the P.C. board of the outdoor unit to drive the air conditioner into the forced cooling mode for up to 10 minutes. Open the valve to start refrigerant recovery.
4. Upon completion of refrigerant recovery, close the valve and press SW802 for at least 1 second to stop operation.
5. Turn off the power.

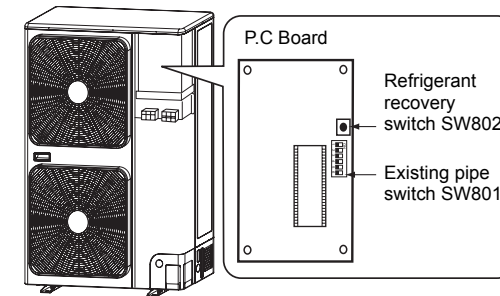

⚠ DANGER

Be careful of electric shock because the P.C. board has an electrical current running through it.

13 TROUBLESHOOTING

You can perform fault diagnosis of the outdoor unit with the LEDs on the P.C. board of the outdoor unit in addition to using the check codes displayed on the wired remote controller of the indoor unit. Use the LEDs and check codes for various checks. Details of the check codes displayed on the wired remote controller of the indoor unit are described in the Installation Manual of the indoor unit.

■ LED displays and check codes

LED indication	Cycle control P.C. board				Cause
	LED indication				
	D800	D801	D802	D803	
D800 ○: Red D801 ○: Yellow D802 ○: Yellow D803 ○: Yellow ◎: Rapid flashing ●: Off ○: On	○	●	●	●	Heat exchanger sensor (TE) error
	●	●	○	●	Suction sensor (TS) error
	○	○	●	●	Discharge sensor (TD) error
	●	○	●	○	Thermostat for compressor activated
	●	○	●	●	Outdoor temperature sensor (TO) error
	○	○	○	●	DC outdoor fan error (Upper side)
	○	○	○	○	DC outdoor fan error (Lower side)
	○	●	●	○	Communication error between IPDU (An abnormal stop is performed.)
	●	○	●	○	Comp. case thermo. operate – Serial signal error
	●	○	○	●	Discharge temp. error
	○	○	●	○	EEPROM error
	●	●	○	○	Communication error between IPDU (An abnormal stop is not performed.)
	◎	●	●	●	G-Tr short-circuit protection
	●	◎	●	●	Detect circuit error
	◎	◎	●	●	Current sensor error
●	●	◎	●	Comp. lock error	
◎	●	◎	●	Comp. break down	

14 APPENDIX

Work instructions

The existing R22 and R407C piping can be reused for our digital inverter R410A product installations.

⚠ WARNING

Confirming the existence of scratches or dents on the existing pipes and confirming the reliability of the pipe strength are conventionally referred to the local site. If the specified conditions can be cleared, it is possible to update existing R22 and R407C pipes to those for R410A models.

Basic conditions needed to reuse existing pipes

Check and observe the presence of three conditions in the refrigerant piping works.

1. **Dry** (There is no moisture inside of the pipes.)
2. **Clean** (There is no dust inside of the pipes.)
3. **Tight** (There are no refrigerant leaks.)

Restrictions for use of existing pipes

In the following cases, the existing pipes should not be reused as they are. Clean the existing pipes or exchange them with new pipes.

1. When a scratch or dent is heavy, be sure to use new pipes for the refrigerant piping works.
2. When the existing pipe thickness is thinner than the specified "Pipe diameter and thickness," be sure to use new pipes for the refrigerant piping works.
 - The operating pressure of R410A is high (1.6 times that of R22 and R407C). If there is a scratch or dent on the pipe or a thinner pipe is used, the pressure strength may be inadequate, which may cause the pipe to break in the worst case.

* Pipe diameter and thickness (mm)

Pipe outer diameter	Ø6.4	Ø9.5	Ø12.7	Ø15.9	Ø19.0
Thickness	R410A	0.8	0.8	0.8	1.0
	R22 (R407C)	0.8	0.8	0.8	1.0

- In case the pipe diameter is Ø12.7 mm or less and the thickness is less than 0.7 mm, be sure to use new pipes for the refrigerant piping works.
3. When the outdoor unit was left with the pipes disconnected, or the gas leaked from the pipes and the pipes were not repaired and refilled.
 - There is the possibility of rain water or air, including moisture, entering the pipe.
 4. When refrigerant cannot be recovered using a refrigerant recovery unit.
 - There is the possibility that a large quantity of dirty oil or moisture remains inside the pipes.
 5. When a commercially available dryer is attached to the existing pipes.
 - There is the possibility that copper green rust has been generated.
 6. When the existing air conditioner is removed after refrigerant has been recovered. Check if the oil is judged to be clearly different from normal oil.
 - The refrigerator oil is copper rust green in color: There is the possibility that moisture has mixed with the oil and rust has been generated inside the pipe.
 - There is discolored oil, a large quantity of residue, or a bad smell.
 - A large quantity of shiny metal dust or other wear residue can be seen in the refrigerant oil.
 7. When the air conditioner has a history of the compressor failing and being replaced.
 - When discolored oil, a large quantity of residue, shiny metal dust, or other wear residue or mixture of foreign matter is observed, trouble will occur.

8. When temporary installation and removal of the air conditioner are repeated such as when leased etc.
9. If the type of refrigerator oil of the existing air conditioner is other than the following oil (Mineral oil), Suniso, Freol-S, MS (Synthetic oil), alkyl benzene (HAB, Barrel-freeze), ester series, PVE only of ether series.
 - The winding-insulation of the compressor may deteriorate.

NOTE

The above descriptions are results have been confirmed by our company and represent our views on our air conditioners, but do not guarantee the use of the existing pipes of air conditioners that have adopted R410A in other companies.

Curing of pipes

When removing and opening the indoor or outdoor unit for a long time, cure the pipes as follows:

- Otherwise rust may be generated when moisture or foreign matter due to condensation enters the pipes.
- The rust cannot be removed by cleaning, and new pipes are necessary.

Placement location	Term	Curing manner
Outdoors	1 month or more	Pinching
	Less than 1 month	Pinching or taping
Indoors	Every time	

Branching pipe for simultaneous operation system

- In the concurrent twin system, when TOSHIBA has specified that branching pipe is to be used, it can be reused.
Branching pipe model name:
RBC-TWP30E2, RBC-TWP50E2, RBC-TRP100E
On the existing air conditioner for simultaneous operation system (twin, triple system), there are cases of branch pipes being used that have insufficient compressive strength.
In such case, please change the piping to a branch pipe for R410A.

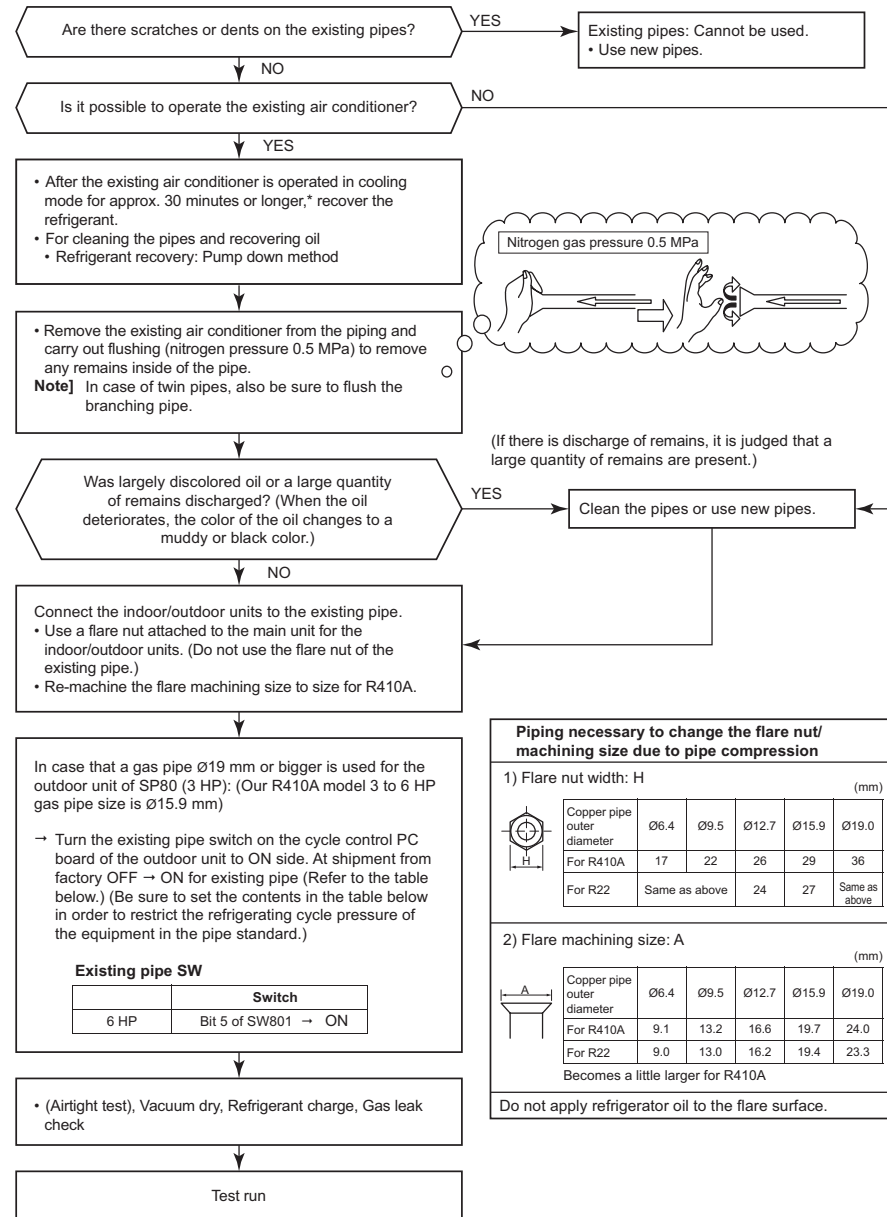

15 SPECIFICATIONS

Model	Sound power level (dB)		Weight (kg)
	Cooling	Heating	
RAV-SM1603AT(J)-E1	68	70	99

Declaration of Conformity

Manufacturer: TOSHIBA CARRIER CORPORATION
336 Tadehara, Fuji-shi, Shizuoka-ken 416-8521 JAPAN

TCF holder: TOSHIBA CARRIER EUROPE S.A.S
Route de Thil
01120 Montluel FRANCE

Hereby declares that the machinery described below:

Generic Denomination: Air Conditioner

Model/type: RAV-SM1603AT-E1,
RAV-SM1603ATJ-E1

Commercial name: Digital Inverter Series Air Conditioner

Complies with the provisions of the "Machinery" Directive (Directive 2006/42/EC) and the regulations transposing into national law

Note: This declaration becomes invalid if technical or operational modifications are introduced without the manufacturer's consent.

Contains fluorinated greenhouse gases	
Chemical Name of Gas	R410A
Global Warming Potential (GWP) of Gas	2088 (ex.R410A ref.AR4)

⚠ CAUTION

- (1) Stick the enclosed refrigerant label adjacent to the service ports for charging or recovering location and where possible adjacent to existing nameplates or product information label.
- (2) Clearly write the charged refrigerant quantity on the refrigerant label using indelible ink. Then, place the included transparent protective sheet over the label to prevent the writing from rubbing off.
- (3) Prevent emission of the contained fluorinated greenhouse gas. Ensure that the fluorinated greenhouse gas is never vented to the atmosphere during installation, service or disposal. When any leakage of the contained fluorinated greenhouse gas is detected, the leak shall be stopped and repaired as soon as possible.
- (4) Only qualified service personnel are allowed to access and service this product.
- (5) Any handling of the fluorinated greenhouse gas in this product, such as when moving the product or recharging the gas, shall comply under (EU) Regulation No.517/2014 on certain fluorinated greenhouse gases and any relevant local legislation.
- (6) Periodical inspections for refrigerant leaks may be required depending on European or local legislation.
- (7) Contact dealers, installers, etc., for any questions.

WARNINGS ON REFRIGERANT LEAKAGE

Check of Concentration Limit

The room in which the air conditioner is to be installed requires a design that in the event of refrigerant gas leaking out, its concentration will not exceed a set limit.

The refrigerant R410A which is used in the air conditioner is safe, without the toxicity or combustibility of ammonia, and is not restricted by laws to be imposed which protect the ozone layer. However, since it contains more than air, it poses the risk of suffocation if its concentration should rise excessively. Suffocation from leakage of R410A is almost non-existent.

If a conditioner system is to be installed in a small room, select a suitable model and installation procedure so that if the refrigerant accidentally leaks out, its concentration does not reach the limit (and in the event of an emergency, measures can be made before injury can occur).

In a room where the concentration may exceed the limit, create an opening with adjacent rooms, or install mechanical ventilation combined with a gas leak detection device.

The concentration is as given below.

$$\frac{\text{Total amount of refrigerant (kg)}}{\text{Min. volume of the indoor unit installed room (m}^3\text{)}} \leq \text{Concentration limit (kg/m}^3\text{)}$$

The concentration limit of R410A which is used in air conditioners is 0.3kg/m³.

▼ NOTE

The minimum indoor floor area compared with the amount of refrigerant is roughly as follows:
(When the ceiling is 2.7m high)

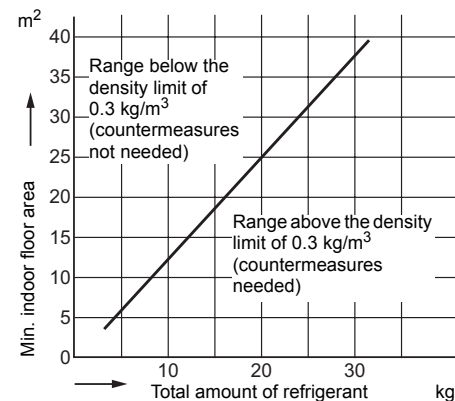

TOSHIBA CARRIER CORPORATION

336 Tadehara, Fuji-shi, Shizuoka-ken 416-8521 JAPAN

DH91304403