

# TOSHIBA

Leading Innovation >>>

## AIR CONDITIONER (SPLIT TYPE) Owner's Manual



1117880699

### Indoor Unit

Model name:

Concealed Duct High Static Pressure Type

**RAV-SM2244DTP-E**  
**RAV-SM2804DTP-E**

For commercial use

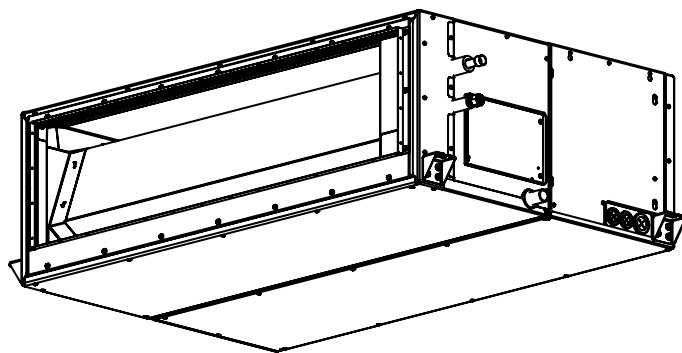

Original instruction

**ADOPTION OF NEW REFRIGERANT**

**This Air Conditioner uses R410A an environmentally friendly refrigerant.**

This appliance can be used by children aged from 8 years and above and persons with reduced physical, sensory or mental capabilities or lack of experience and knowledge if they have been given supervision or instruction concerning use of the appliance in a safe way and understand the hazards involved. Children shall not play with the appliance. Cleaning and user maintenance shall not be made by children without supervision.

## Contents

1	Precautions for safety .....	3
2	Part names .....	6
3	Wired remote controller .....	6
4	Correct usage.....	8
5	Timer operation.....	9
6	Power saving mode .....	9
7	Maintenance .....	10
8	Troubleshooting.....	11
9	Operations and performance.....	12
10	Installation .....	13
11	Specifications .....	13

Thank you for purchasing this Toshiba air conditioner.

Please read carefully through these instructions that contain important information which complies with the "Machinery" Directive (Directive 2006/42/EC), and ensure that you understand them.

After reading these instructions, be sure to keep them in a safe place together with the Installation Manual supplied with your product.





**Generic Denomination: Air Conditioner**

**Definition of Qualified Installer or Qualified Service Person**

The air conditioner must be installed, maintained, repaired and removed by a qualified installer or qualified service person. When any of these jobs is to be done, ask a qualified installer or qualified service person to do them for you. A qualified installer or qualified service person is an agent who has the qualifications and knowledge described in the table below.

Agent	Qualifications and knowledge which the agent must have
Qualified installer	<ul style="list-style-type: none"> <li>The qualified installer is a person who installs, maintains, relocates and removes the air conditioners made by Toshiba Carrier Corporation. He or she has been trained to install, maintain, relocate and remove the air conditioners made by Toshiba Carrier Corporation or, alternatively, he or she has been instructed in such operations by an individual or individuals who have been trained and is thus thoroughly acquainted with the knowledge related to these operations.</li> <li>The qualified installer who is allowed to do the electrical work involved in installation, relocation and removal has the qualifications pertaining to this electrical work as stipulated by the local laws and regulations, and he or she is a person who has been trained in matters relating to electrical work on the air conditioners made by Toshiba Carrier Corporation or, alternatively, he or she has been instructed in such matters by an individual or individuals who have been trained and is thus thoroughly acquainted with the knowledge related to this work.</li> <li>The qualified installer who is allowed to do the refrigerant handling and piping work involved in installation, relocation and removal has the qualifications pertaining to this refrigerant handling and piping work as stipulated by the local laws and regulations, and he or she is a person who has been trained in matters relating to refrigerant handling and piping work on the air conditioners made by Toshiba Carrier Corporation or, alternatively, he or she has been instructed in such matters by an individual or individuals who have been trained and is thus thoroughly acquainted with the knowledge related to this work.</li> <li>The qualified installer who is allowed to work at heights has been trained in matters relating to working at heights with the air conditioners made by Toshiba Carrier Corporation or, alternatively, he or she has been instructed in such matters by an individual or individuals who have been trained and is thus thoroughly acquainted with the knowledge related to this work.</li> </ul>
Qualified service person	<ul style="list-style-type: none"> <li>The qualified service person is a person who installs, repairs, maintains, relocates and removes the air conditioners made by Toshiba Carrier Corporation. He or she has been trained to install, repair, maintain, relocate and remove the air conditioners made by Toshiba Carrier Corporation or, alternatively, he or she has been instructed in such operations by an individual or individuals who have been trained and is thus thoroughly acquainted with the knowledge related to these operations.</li> <li>The qualified service person who is allowed to do the electrical work involved in installation, repair, relocation and removal has the qualifications pertaining to this electrical work as stipulated by the local laws and regulations, and he or she is a person who has been trained in matters relating to electrical work on the air conditioners made by Toshiba Carrier Corporation or, alternatively, he or she has been instructed in such matters by an individual or individuals who have been trained and is thus thoroughly acquainted with the knowledge related to this work.</li> <li>The qualified service person who is allowed to do the refrigerant handling and piping work involved in installation, repair, relocation and removal has the qualifications pertaining to this refrigerant handling and piping work as stipulated by the local laws and regulations, and he or she is a person who has been trained in matters relating to refrigerant handling and piping work on the air conditioners made by Toshiba Carrier Corporation or, alternatively, he or she has been instructed in such matters by an individual or individuals who have been trained and is thus thoroughly acquainted with the knowledge related to this work.</li> <li>The qualified service person who is allowed to work at heights has been trained in matters relating to working at heights with the air conditioners made by Toshiba Carrier Corporation or, alternatively, he or she has been instructed in such matters by an individual or individuals who have been trained and is thus thoroughly acquainted with the knowledge related to this work.</li> </ul>

**Warning indications on the air conditioner unit**

Warning indication	Description		
 <table border="1" data-bbox="1301 296 1559 456"> <tr> <td data-bbox="1375 304 1485 328"><b>WARNING</b></td> </tr> <tr> <td data-bbox="1301 344 1559 448"><b>ELECTRICAL SHOCK HAZARD</b> Disconnect all remote electric power supplies before servicing.</td> </tr> </table>	<b>WARNING</b>	<b>ELECTRICAL SHOCK HAZARD</b> Disconnect all remote electric power supplies before servicing.	<p><b>WARNING</b></p> <p><b>ELECTRICAL SHOCK HAZARD</b> Disconnect all remote electric power supplies before servicing.</p>
<b>WARNING</b>			
<b>ELECTRICAL SHOCK HAZARD</b> Disconnect all remote electric power supplies before servicing.			
 <table border="1" data-bbox="1301 521 1559 681"> <tr> <td data-bbox="1375 529 1485 553"><b>WARNING</b></td> </tr> <tr> <td data-bbox="1301 569 1559 673">Moving parts. Do not operate unit with grille removed. Stop the unit before the servicing.</td> </tr> </table>	<b>WARNING</b>	Moving parts. Do not operate unit with grille removed. Stop the unit before the servicing.	<p><b>WARNING</b></p> <p>Moving parts. Do not operate unit with grille removed. Stop the unit before the servicing.</p>
<b>WARNING</b>			
Moving parts. Do not operate unit with grille removed. Stop the unit before the servicing.			
 <table border="1" data-bbox="1301 746 1559 906"> <tr> <td data-bbox="1375 754 1485 778"><b>CAUTION</b></td> </tr> <tr> <td data-bbox="1301 794 1559 898">High temperature parts. You might get burned when removing this panel.</td> </tr> </table>	<b>CAUTION</b>	High temperature parts. You might get burned when removing this panel.	<p><b>CAUTION</b></p> <p>High temperature parts. You might get burned when removing this panel.</p>
<b>CAUTION</b>			
High temperature parts. You might get burned when removing this panel.			
 <table border="1" data-bbox="1301 971 1559 1131"> <tr> <td data-bbox="1375 979 1485 1003"><b>CAUTION</b></td> </tr> <tr> <td data-bbox="1301 1019 1559 1123">Do not touch the aluminum fins of the unit. Doing so may result in injury.</td> </tr> </table>	<b>CAUTION</b>	Do not touch the aluminum fins of the unit. Doing so may result in injury.	<p><b>CAUTION</b></p> <p>Do not touch the aluminium fins of the unit. Doing so may result in injury.</p>
<b>CAUTION</b>			
Do not touch the aluminum fins of the unit. Doing so may result in injury.			
 <table border="1" data-bbox="1301 1197 1559 1356"> <tr> <td data-bbox="1375 1204 1485 1228"><b>CAUTION</b></td> </tr> <tr> <td data-bbox="1301 1244 1559 1348"><b>BURST HAZARD</b> Open the service valves before the operation, otherwise there might be the burst.</td> </tr> </table>	<b>CAUTION</b>	<b>BURST HAZARD</b> Open the service valves before the operation, otherwise there might be the burst.	<p><b>CAUTION</b></p> <p><b>BURST HAZARD</b> Open the service valves before the operation, otherwise there might be the burst.</p>
<b>CAUTION</b>			
<b>BURST HAZARD</b> Open the service valves before the operation, otherwise there might be the burst.			

# 1 Precautions for safety

The manufacturer shall not assume any liability for the damage caused by not observing the description of this manual.

## WARNING

### General

- Carefully read Owner's Manual before starting the air conditioner. There are many important things to keep in mind for daily operation.
- Ask for installation to be performed by the dealer or a professional. Only a qualified installer(\*1) is able to install an air conditioner. If a non-qualified person installs an air conditioner, it may result in problems such as fire, electric shock, injury, water leakage, noise and vibration.
- Do not use any refrigerant different from the one specified for complement or replacement. Otherwise, abnormally high pressure may be generated in the refrigeration cycle, which may result in a failure or explosion of the product or an injury to your body.
- Places where the operation sound of the outdoor unit may cause a disturbance. (Especially at the boundary line with a neighbour, install the air conditioner while considering the noise.)
- This appliance is intended to be used by expert or trained users in shops, in light industry and on farms, or for commercial use by lay persons.

### Transportation and storage

- To transport the air conditioner, wear shoes with protective toe caps, protective gloves, and other protective clothing.
- To transport the air conditioner, do not take hold of the bands around the packing carton. You may injure yourself if the bands should break.
- Before stacking the packing cartons for storage or transportation, heed the precautions written on the packing cartons. Failure to heed the precautions may cause the stack to collapse.
- The air conditioner must be transported in stable condition. If any part of the product broken, contact your dealer.
- When carrying the Air Conditioner, be sure to use a forklift. If it is necessary to carry by hands, be sure to carry it with more than 4 people and only for a short time shall be allowed to do so.

### Installation

- Only a qualified installer(\*1) or qualified service person(\*1) is allowed to carry out the electrical work of the air conditioner. Under no circumstances must this work be done by an unqualified individual since failure to carry out the work properly may result in electric shocks and / or electrical leaks.

- After the installation work has been completed, have the installer explain about the circuit breaker positions. In the event that trouble has occurred in the air conditioner, set the circuit breaker to the OFF position, and contact a service person.
- If the unit is installed in a small room, take appropriate measures to prevent the refrigerant from exceeding the limit concentration even if it leaks. Consult the dealer from whom you purchased the air conditioner when you implement the measures. Accumulation of highly concentrated refrigerant may cause an oxygen deficiency accident.
- Do not install the air conditioner in a location that may be subject to a risk of exposure to a combustible gas. If a combustible gas leaks and becomes concentrated around the unit, a fire may occur.
- Use the company-specified products for the separately purchased parts. Use of non-specified products may result in fire, electric shock, water leakage or other trouble. Have the installation performed by a professional.
- Confirm that earthing is performed correctly.

### Operation

- Before opening the electrical control box cover of the indoor unit or service panel of the outdoor unit, set the circuit breaker to the OFF position. Failure to set the circuit breaker to the OFF position may result in electric shocks through contact with the interior parts. Only a qualified installer(\*1) or qualified service person(\*1) is allowed to remove the electrical control box cover of the indoor unit or service panel of the outdoor unit and do the work required.
- Inside the air conditioner are high-voltage areas and rotating parts. Due to the danger of electric shocks or of your fingers or physical objects becoming trapped in the rotating parts, do not remove service panel of the outdoor unit. When work involving the removal of these parts is required, contact a qualified installer(\*1) or a qualified service person(\*1).
- Do not move or repair any unit by yourself. Since there is high voltage inside the unit, you may get electric shock when removing the cover and main unit.
- Use of a stand more than 50 cm high to clean the filter of the indoor unit or to carry out other such jobs constitutes working at heights. Due to the danger of falling off the stand and injuring yourself while working at heights, this kind of work should not be done by unqualified individuals. When this kind of work must be carried out, do not do it yourself but ask a qualified installer(\*1) or a qualified service person(\*1) to do it for you.
- Do not touch the aluminum fin of the outdoor unit. You may injure

- 
- yourself if you do so. If the fin must be touched, do not touch it yourself but contact a qualified installer(\*1) or a qualified service person(\*1).
- Do not climb onto or place objects on top of the outdoor unit. You may fall or the objects may fall off of the outdoor unit and result in injury.
  - Do not place any combustion appliance in a place where it is directly exposed to the wind of air conditioner, otherwise it may cause imperfect combustion.
  - When the air conditioner is operated with a combustion appliance in the same place, ventilate the room sufficiently. Poor ventilation causes oxygen shortage.
  - When the air conditioner is used in a closed room, sufficiently ventilate the room. Poor ventilation causes oxygen shortage.
  - Do not expose your body to cool air directly for a long time and do not cool yourself excessively. Doing so may result in deteriorated physical condition and ill health.
  - Do not insert your finger or a stick into the air intake or discharge. Doing so may result injury as the fan is rotating at high speed inside the unit.
  - Consult the shop where you purchased the air conditioner if air conditioning (cooling and heating) is not performed properly as a refrigerant leakage may be the cause. Confirm the repair details with a qualified service person(\*1) when the repair includes additional charging of the refrigerant.
  - Stop running the air conditioner and turn off the breaker before cleaning. Otherwise, injury may result as the fan is rotating at high speed inside the unit.

### Repairs

- If there is any kind of trouble (such as when an error display has appeared, there is a smell of burning, abnormal sounds are heard, the air conditioner fails to cool or heat or water is leaking) has occurred in the air conditioner, do not touch the air conditioner yourself but set the circuit breaker to the OFF position, and contact a qualified service person(\*1). Take steps to ensure that the power will not be turned on (by marking "out of service" near the circuit breaker, for instance) until qualified service person(\*1) arrives. Continuing to use the air conditioner in the trouble status may cause mechanical problems to escalate or result in electric shocks or other trouble.
- If the fan guard is damaged, do not approach the outdoor unit but set the circuit breaker to the OFF position, and contact a qualified service person(\*1) to have the repairs done. Do not set the circuit breaker to the ON position until the repairs are completed.
- If there is a danger of the indoor unit's falling, do not approach the indoor unit but set the circuit breaker to the OFF position, and contact

- 
- a qualified installer(\*1) or a qualified service person(\*1) to refit the unit. Do not set the circuit breaker to the ON position until the unit has been refitted.
  - If there is a danger of the outdoor unit's toppling over, do not approach the outdoor unit but set the circuit breaker to the OFF position, and contact a qualified installer(\*1) or a qualified service person(\*1) to have the improvements or refitting done. Do not set the circuit breaker to the ON position until the improvements or refitting is completed.
  - Do not modify the products. Do not also disassemble or modify the parts. It may cause a fire, electric shock or injury.

### Relocation

- When the air conditioner is to be relocated, do not relocate it yourself but contact a qualified installer(\*1) or a qualified service person(\*1). Failure to relocate the air conditioner properly may result in electric shocks and / or a fire.

---

### CAUTION

#### **To disconnect the appliance from the mains supply.**

- This appliance must be connected to the mains by means of a switch with a contact separation of at least **3 mm**.

#### **The installation fuse (all types can be used) must be used for the power supply line of this air conditioner.**

### Installation

- Certainly lay the drain hose for perfect draining. Improper drainage may cause flooding in the house and getting furniture wet.
- Connect the air conditioner to an exclusive power supply of the rated voltage, otherwise the unit may break down or cause a fire.
- Confirm that the outdoor unit are fixed on the base. Otherwise, falling down of the units or other accidents may occur.

### Operation

- Do not use this air conditioner for special purpose such as preserving food, precision instruments, art objects, breeding animals, car, vessel.
- Do not touch any switches with wet finger, otherwise you may get an electric shock.
- If the air conditioner will not be used for a considerably long time, turn off the main switch or the circuit breaker, for safety.
- To make the air conditioner operate in its original performance, operate it within the range of the operating temperature specified









in the instructions. Otherwise it may cause a malfunction, or water leak from the unit.

- Prevent any liquid from falling into the remote controller. Do not spill juice, water or any kind of liquid.
- Do not wash the air conditioner. Doing so may result in electric shock.
- Check whether the installation base and other equipment have become deteriorated after being used for a long time. Leaving them such condition may result in the unit's falling down and causing injury.
- Do not leave flammable sprays or other flammable materials near the air conditioner, and do not spray flammable aerosol directly to the air conditioner. They may catch fire.
- Stop running the air conditioner and turn off the breaker before cleaning. Otherwise, injury may result as the fan is rotating at high speed inside the unit.
- Ask for cleaning of the air conditioner to be performed by the dealer. Cleaning the air conditioner in an improper manner may cause damage to plastic parts, insulation failure of electric parts or other parts, and result in a malfunction. In the worst case, it may result in water leakage, electric shock, smoke emission or fire.
- Do not put a water container such as a vase on the unit. Water intrusion into the unit may occur and it may cause deterioration of electric insulation and result in electric shock.

(\*1) Refer to the "Definition of Qualified Installer or Qualified Service Person."

## ■ Information on the transportation, handling and storage of the carton

### ◆ Examples of indication on the carton

Symbol	Description	Symbol	Description
	Keep dry		Do not drop
	Fragile		Do not lay down
 3 cartons	Stacking height (4 cartons can be stacked in this case)		Do not walk on this carton
	This side up		Do not step
	Handle with care		

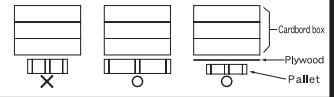
Other cautions	Description
 <p><b>Caution</b> Injury possibility. Don't handle with packing band, or may get injured in case of broken band.</p>	<p><b>CAUTION</b></p> <p>Injury possibility. Don't handle with packing band, or may get injured in case of broken band.</p>
<p><b>Stacking notice.</b></p> <p>In case that cardboard boxes protrude out of pallet when stacking, lay a 10mm thick plywood over the pallet.</p> 	<p><b>Stacking notice.</b></p> <p>In case that cardboard boxes protrude out of pallet when stacking. Lay a 10 mm thick plywood over the pallet.</p>

## 2 Part names

### ■ Indoor unit

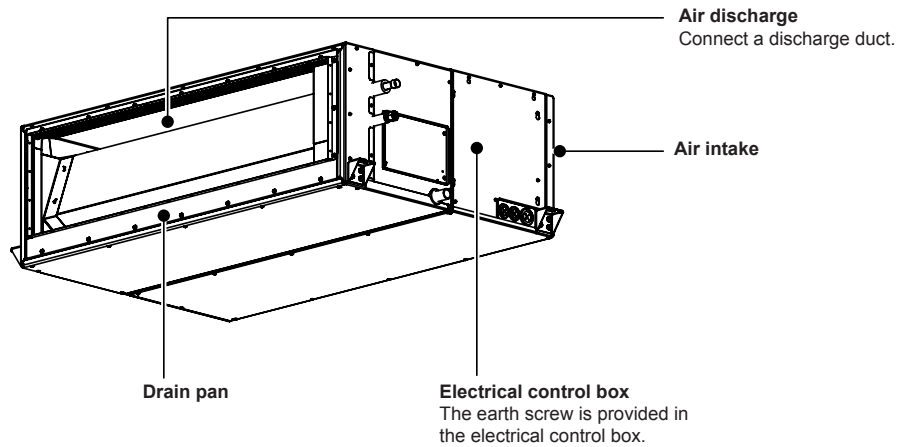

### ■ Outdoor unit (The design varies depending on the outdoor unit. The following illustration shows an example.)

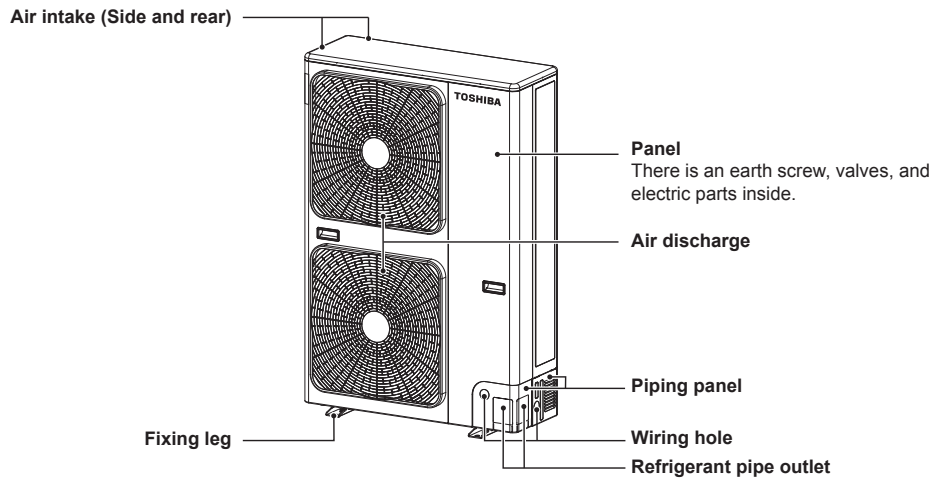

## 3 Wired remote controller





This remote controller can control the operation of up to 8 indoor units.

### ■ Display section

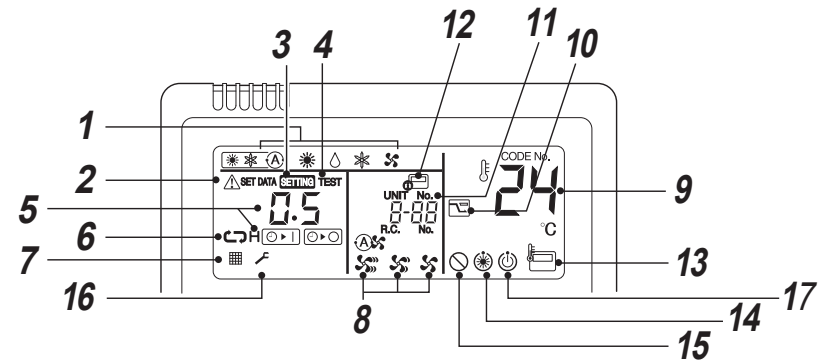
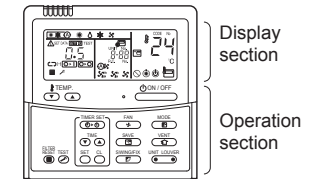
In the display illustration below all the icons are shown. When the unit is in operation, only relevant icons will be displayed.

- When the leak breaker is turned on at the first time, **SETTING** flashes on the display part of the remote controller.
- While this icon is flashing, the model is being automatically confirmed. Wait till **SETTING** icon has disappeared to use the remote controller.



- 1 Operation mode**  
The selected operation mode is displayed.
- 2 Check code display**  
Displayed while the protective device works or a problem occurs.
- 3 SETTING display**  
Displayed during setup of the timer or other settings.
- 4 TEST run display**  
Displayed during a test run.
- 5 Timer display**  
The selected timer time is displayed. When a problem occurs, check code is displayed.
- 6 Timer mode display**  
The selected timer mode is displayed.
- 7 Filter display**  
Reminder to clean the air filter.
- 8 Fan speed display**  
The selected fan speed mode is displayed.  
(Auto)   
(High)   
(Med.)   
(Low) 
- 9 Set temperature display**  
The selected set temperature is displayed.
- 10 Power saving mode display**  
Limits compressor speed (capacity) to save energy.

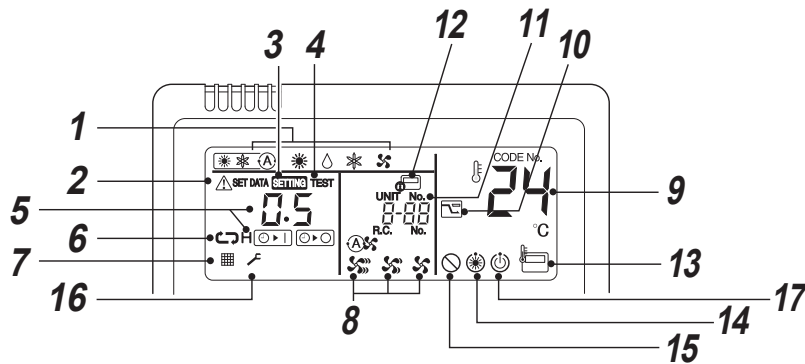

**11 UNIT No. display**

The selected indoor unit number is displayed. Also number of indoor or outdoor unit which a problem occurs is displayed.

**12 Central control display**

Displayed when the air conditioner is used under the central control in combination with a central control remote controller.

In case the remote controller is disabled by the central control system, the button flashes. The button operation is not accepted.

Even when ON / OFF, MODE, or TEMP. button is pushed, and the button operation is not accepted. (Settings made by the remote controller vary with the central control mode. For details, refer to the Owner's Manual of the central control remote controller.)

**13 Remote controller sensor display**

Displayed while the sensor of the remote controller is used.

**14 Pre-heat display**

Displayed when the heating mode is energized or defrost cycle is initiated. While this icon is displayed, the indoor fan stops.

**15 No function display**

Displayed when the function requested is not available on that model.

**16 Service display**

**17 Operation ready display**

This display appears on some models.

**■ Operation section**

Push each button to select a desired operation.

- The control saves commands in memory and after the initial setting, there is no need for any additional settings unless changes are desired. The air conditioner can be operated by pushing the ON / OFF button.

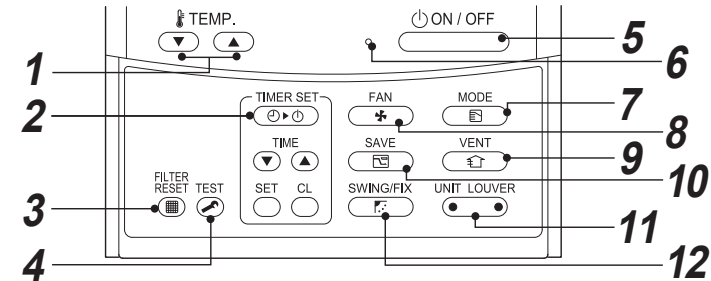

**1 TEMP. button (Temperature set button)**

Adjusts the set point. Select the desired set point by pushing TEMP. or TEMP.

**2 TIMER SET button (Timer set button)**

Use to setup the timer.

**3 FILTER RESET button (Filter reset button)**

Resets " " display after cleaning filter.

**4 TEST button (Test button)**

Use only for service. (During normal operation, do not use this button.)

**5 ON / OFF button**

When the button is pushed, the operation starts, and it stops by pushing the button again. When the operation has stopped, the operation lamp and all the displays disappear.

**6 Operation lamp**

Green light illuminates when unit is on. Although it flashes when operating the protection device or a problem occurs.

**7 MODE button (Operation mode button)**

Selects desired operation mode.

**8 FAN button (Fan speed button)**

Fan speed is not adjustable.

**9 VENT button (Ventilation button)**

Use when a power ventilation kit (locally procured) is connected.

- If " " is displayed on the remote controller when this button is pushed, no vent kit connected.

**10 SAVE button (Power save operation)**

Use to initiate power saving mode.

**11 UNIT LOUVER button (Unit / Louver select button)**

Selects a unit number (left) and louver number (right).

**UNIT:** Selects an indoor unit when multiple indoor units are controlled with one remote controller.

**LOUVER:** No Function.

**12 SWING/FIX button (Swing / Louver direction button)**

No Function.

**OPTION:**

**Remote controller sensor**

Usually the temperature sensor of the indoor unit senses the temperature. The temperature on the surrounding of the remote controller can also be sensed. For details, contact the dealer from which you have purchased the air conditioner.



# 4 Correct usage

When the air conditioner is used for the first time or when the setting is changed, follow the steps below. Settings are saved in memory and are displayed anytime the unit is turned on by pushing the  button.

## ■ Preparation



- When the circuit breaker is turned on, the partition lines are displayed on the remote controller.
- \* **After the circuit breaker is turned on, the remote controller does not accept any commands for approx. 1 minute, this is not a failure.**

### REQUIREMENT

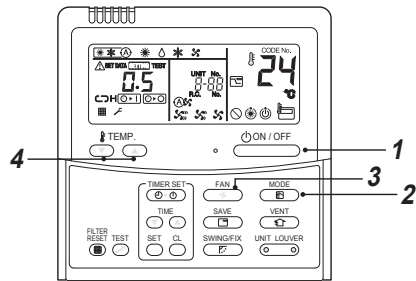
When the air conditioner is re-powered after it has not been used for a long period, turn on the circuit breaker at least 12 hours before starting the air conditioner.







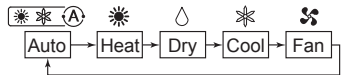

## Start

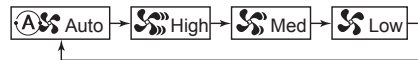
- 1 Push  button.**  
The operation lamp illuminates, and the operation starts.
- 2 Select an operation mode with the “” button.**  
One push of the button, and the display changes in the order shown below.



- 3 Select fan speed with “” button.**  
One push of the button, and the display changes in the order shown below.



- When fan is in “ Auto”, fan speed is adjusted based on difference between set point and room temperature.
- In heating operation, if the room temperature is not heated sufficiently with speed “ Low” operation, select “ Med.” or “ High” operation.
- The temperature sensor detects the return air temperature at the indoor unit, which differs from the room temperature depending on the installation condition.  
Set point is a target of room temperature.  
(“ Auto” is not selectable in the Fan mode.)

- 4 Select the set point temperature by pushing the “TEMP. ” or “TEMP. ” buttons.**

## Stop

Push  button.  
The operation lamp goes off, and the operation stops.

### NOTE

## Auto Changeover

- During Auto Mode, the unit selects the operating mode (cooling, heating or fan only) based on the user set point temperature.
- If the Auto mode is uncomfortable, you can select the desired conditions manually.

## Heating

- If there is a demand for heating, unit will start approximately 3 to 5 minutes after the mode is selected.
- After the heating operation has stopped, fan may continue to run for approx. 30 seconds.
- When the room temperature reaches the set temperature, the outdoor unit stops and the indoor unit fan runs at extremely low speed.
- During defrost operation, the fan stops so that cool air is not discharged. (“” Pre-heat is displayed.)



## When operation is restarted after stop

- When attempting to restart the unit immediately after it was stopped, the unit cannot start for approx. 3 minutes this is to protect the compressor.

## ■ 8°C operation (For object pre-heating)

The air conditioner can control the heating temperature to about 8°C in the heating mode.  
**The 8°C heating operation requires settings with the wired remote controller. Ask the installer or dealer for the settings according to the installation manual of the indoor unit.**



## Start

1. Set the displayed temperature to 18°C in the heating mode by pushing TEMP.  button.
2. Set the displayed temperature to 8°C by pushing TEMP.  button for at least 4 seconds

## Stop

1. Set the displayed temperature to 18°C by pushing TEMP.  button.
  - The air conditioner returns to the normal HEAT mode. Select a desired temperature and operation mode.

### NOTE

- The discharged air temperature is lower than that in the normal heating operation.
- The room temperature may not be heated evenly depending on the remote controller installation location.
- The room temperature may not reach 8°C depending on the room size or the installation conditions.
- Setting for fan speed is available during the 8°C heating operation.  
The 8°C heating operation is cancelled in the following cases.
  - When operation is stopped with  button
  - When another operation mode is selected with  button
  - When temperature setting or operation mode is changed or operation is started / stopped by the wireless remote controller or the central control remote controller.
- When this operation mode is used, observe proper operating hours and we recommend that you ask service staff for periodic maintenance of the air conditioner.

## 5 Timer operation

Three timer modes are available: (Setting of up to 168 hours is enabled.)

- Off timer : The unit stops when the set time is reached.
- Repeat Off timer : The unit stops daily when the set time is reached.
- On timer : The unit starts when the set time is reached.

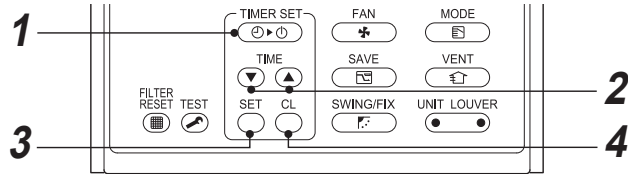

### Start

#### 1 Push **TIMER SET** button.

The timer mode changes with every push of the button.

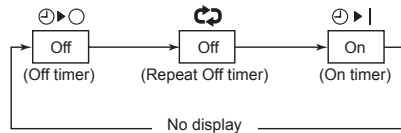

- **SETTING** and timer display flashes.

#### 2 Push **TIME** to select "set time".

- With every push of **TIME** button, the set time increases by 0.5 hr (30 minutes). When a time more than 24 hours is set for timer operation, timer can be set in increments of 1 hr. The maximum set time is 168hr (7 days). The remote control displays the set time with time (between 0.5 and 23.5 hours) (\*) or number of days and time (24 hours or more) (\*) as shown below.
- With every push of **TIME** button, the set time decreases by 0.5 hr (30 minutes) (0.5 - 23.5 hours) or 1 hr (24 - 168 hours).

### Example of remote control display

#### • 23.5 hours (\*)



#### • 34 hours (\*)



Number of days    Time

1d shows 1 day (24 hours).

10h shows 10 hours. (Total 34 hours)

#### 3 Push **SET** button.

**SETTING** display disappears and time display goes on, and **ON/OFF** or **ON/OFF** display flashes. (When On timer is activated, time and On timer **ON/OFF** are displays and other displays disappear.)

#### 4 Cancel timer operation.

Push **ON/OFF** button. Timer display disappears.

### NOTE

- When the operation stops after the timer reached the preset time, the Repeat Off timer resumes the operation by pushing **ON/OFF** button and stops the operation after the time of the timer has reached the set time.
- When **SWING/FIX** is pushed while the Off timer function of the air conditioner is active, the indication of the timer function disappears and then appears again after about 5 seconds. This is due to normal processing of the remote controller.

## 6 Power saving mode

The power saving mode saves energy by limiting the maximum current which will effect heating or cooling capacity that the unit can generate.

### Push **SAVE** button during operation.

- The air conditioner enters power saving mode.
- **SAVE** appears on the display.

Power saving mode will stay in effect until it is cancelled.

To cancel the power saving mode, push **SAVE** button again. **SAVE** disappears.

### ■ To configure the power saving settings

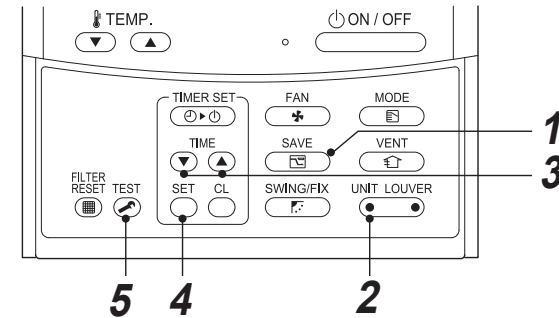

#### 1 Push **SAVE** button for at least 4 seconds when the air conditioner is not working. **SETTING** flashes.

#### 2 Push **UNIT LOUVER** (left side of the button) to select an indoor unit to be set.

- Each time the button is pushed, UNIT No. change as follows:

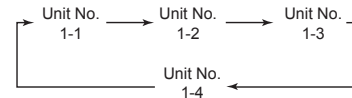

The fan of the selected unit runs.

#### 3 Push **TIME** buttons, to adjust the setting of power level.

- Each push of the button changes the power level by 1 % within the range from 100 % to 50 %.
- The factory default is 75 %.

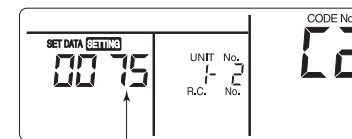

Setting of power level in power saving mode

4 Push  button.

5 Push  button to complete the setting.

#### NOTE

- When other electric appliances are used at the same time, to avoid triggering the circuit breaker, power saving mode is recommended. Of course you can use power saving mode to save energy as well.
- Power saving mode consumes less energy, but may not heat / cool the room as much as normal mode. (The maximum current is limited to approximately 75 % (factory default) of the normal mode.)
- To adjust the power-save settings, see "To configure the power saving settings" in Power saving mode.
- Even when operation start / stop, operation mode change, or power reset is performed during the power saving mode, the power saving mode is retained until the next operation.

## 7 Maintenance

### WARNING

**Cleaning the air filter and other parts of the air filter involves dangerous work in high places, so be sure to have a qualified installer or qualified service person to do it. Do not attempt it by yourself.**

#### ▼ Cleaning air filters (sold separately or locally procured)

Clogged air filters will reduce the cooling and heating performance.

- 1) If "■" is displayed on the remote controller, clean the air filters.
- 2) When the cleaning of air filters has been completed, push  button. "■" disappears.

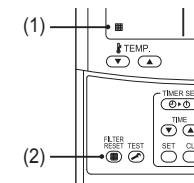

#### ◆ When not used for a long time

1. Perform the fan operation for a couple of hours to dry inside.
2. Push  button on the remote controller to stop running, and turn off the circuit breaker.
3. Clean the air filters and reinstall them.

#### ◆ Before the cooling season

##### Clean the drain pan

- Contact the dealer where you purchased the product. (Drain does not work if the drain pan or vent is clogged. In some cases the drain may overflow and wet the wall or floor. Clean the drain pan before the cooling season.)

#### ◆ Check periodically

- If the unit is used for a long time, parts may deteriorate and cause malfunction or bad drainage of dehumidified water depending on the heat, humidity, or dust.
- In addition to the usual maintenance, it is recommended that you have the unit checked and maintained by the dealer where you purchased it.

#### NOTE

For environmental conservation, it is strongly recommended that the indoor and outdoor units of the air conditioner in use be cleaned and maintained regularly to ensure efficient operation of the air conditioner. When the air conditioner is operated for a long time, periodic maintenance (once a year) is recommended. Furthermore, regularly check the outdoor unit for rust and scratches, and remove them or apply rustproof treatment, if necessary.

As a general rule, when an indoor unit is operated for 8 hours or more daily, clean the indoor unit and outdoor unit at least once every 3 months. Ask a professional for this cleaning / maintenance work. Such maintenance can extend the life of the product though it involves the owner's expense. Failure to clean the indoor and outdoor units regularly will result in poor performance, freezing, water leakage, and even compressor failure.

▼ Maintenance List

Part	Unit	Check (visual / auditory)	Maintenance
Heat exchanger	Indoor / outdoor	Dust / dirt clogging, scratches	Wash the heat exchanger when it is clogged.
Fan motor	Indoor / outdoor	Sound	Take appropriate measures when abnormal sound is generated.
Filter	Indoor	Dust / dirt, breakage	<ul style="list-style-type: none"> <li>Wash the filter with water when it is contaminated.</li> <li>Replace it when it is damaged.</li> </ul>
Fan	Indoor	<ul style="list-style-type: none"> <li>Vibration, balance</li> <li>Dust / dirt, appearance</li> </ul>	<ul style="list-style-type: none"> <li>Replace the fan when vibration or balance is terrible.</li> <li>Brush or wash the fan when it is contaminated.</li> </ul>
Air intake / discharge grilles	Indoor / outdoor	Dust / dirt, scratches	Fix or replace them when they are deformed or damaged.
Drain pan	Indoor	Dust / dirt clogging, drain contamination	Clean the drain pan and check the downward slope for smooth drainage.
Exterior	outdoor	<ul style="list-style-type: none"> <li>Rust, peeling of insulator</li> <li>Peeling / lift of coat</li> </ul>	Apply repair coating.

## 8 Troubleshooting

Check the points described below before requesting repair.

		Symptom	Cause
It is not a failure.	Outdoor unit	<ul style="list-style-type: none"> <li>White, misty, cold air or water comes out</li> <li>Sometimes the noise of air leaking is heard.</li> <li>A noise is heard when the power is turned on.</li> </ul>	<ul style="list-style-type: none"> <li>The fan of the outdoor unit is automatically stopped and defrosting is performed.</li> <li>The solenoid valve works when defrosting starts or stops.</li> <li>The outdoor unit is preparing for running.</li> </ul>
	Indoor unit	<ul style="list-style-type: none"> <li>Sometimes a swishing is heard.</li> <li>A clacking sound is heard.</li> <li>Discharged air smells unusual.</li> </ul>	<ul style="list-style-type: none"> <li>When the unit starts running, during operation, or immediately after the unit stops running, a sound such as water flowing may be heard, or the operation sound may become louder for a couple of minutes immediately after the unit starts running. This is the sound of the refrigerant flowing or the dehumidifier draining.</li> <li>This is a sound generated when the heat exchanger or other part expands and contracts slightly due to temperature change.</li> <li>Various smells from the walls, carpet, clothes, cigarette, cosmetics or other things adhere to the air conditioner.</li> </ul>
		<ul style="list-style-type: none"> <li>The unit does not run.</li> </ul>	<ul style="list-style-type: none"> <li>Has a blackout occurred?</li> <li>Has the circuit breaker blown?</li> <li>Has the protective device been activated? (The operation indicator and <math>\mathcal{L}</math> on the remote controller are blinking.)</li> </ul>
Check again.		The room does not cool down.	<ul style="list-style-type: none"> <li>Is the air intake or discharge of the outdoor unit clogged?</li> <li>Is a door or window open?</li> <li>Is the air filter clogged with dust?</li> <li>Is the setup temperature appropriate?</li> </ul>

If there is something unusual even after checking the above, stop running the unit, turn off the circuit breaker, and inform the dealer where you purchased the product of the product number and symptom. Do not attempt to repair the unit by yourself as doing so is dangerous. If the check indicator (e.g.  $EO$ ,  $FO$ ,  $HO$ ) is displayed on the remote controller LCD, inform the dealer of its content as well.

If any of the following occur, stop running the unit immediately, turn off the circuit breaker, and contact the dealer where you purchased the product.

- The switch does not work properly.
- The circuit breaker often blows out.
- You unintentionally put a foreign object or water inside.
- The unit cannot be run even after the cause of the protective device activation is removed.
- Other unusual conditions are found.

## Confirmation and check

When a problem occurred in the air conditioner, check code and indoor UNIT No. appear on the display part of the remote controller.

The check code is only displayed during the operation. If the display disappears, operate the air conditioner according to the following "Confirmation of check code log" for confirmation.

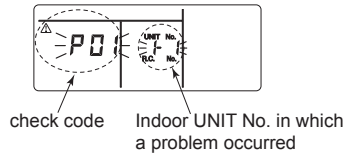

## Confirmation of check code log

When a problem occurred on the air conditioner, the check code log can be confirmed with the following procedure. (The check code log is stored in memory up to 4 check codes.) The log can be confirmed from both operating status and stop status.

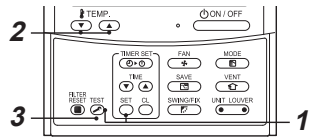

**1** Push **SET** and **TEST** buttons simultaneously for 4 seconds or more, the following display appears.

If **PO** is displayed, the mode enters in the check code log mode.

- [01: Order of check code log] is displayed in CODE No.
- [Check code] is displayed in CHECK.
- [Indoor unit address in which a problem occurred] is displayed in Unit No..

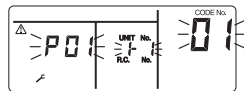

**2** Every pushing of **TEMP.** button used to set temperature, the check code log stored in memory is displayed in order.

The numbers in CODE No. indicate CODE No. [01] (latest) → [04] (oldest).

### REQUIREMENT

Do not push **ON/OFF** button because all the check code log of the indoor unit will be deleted.

**3** After confirmation, push **TEST** button to return to the usual display.

# 9 Operations and performance

### Check before running

- Check whether the earth wire is cut or disconnected.
- Check whether the air filter is installed.
- Turn on the circuit breaker 12 hours or more before starting operation.

### 3 minutes protection function

3-minutes protection function prevents the air conditioner from starting for initial 3 minutes after the main power switch / circuit breaker is turned on for restarting the air conditioner.

### Power failure

Power failure during operation will stop the unit completely.

- To restart the operation, push the ON / OFF button on the remote controller.
- Lightning or a wireless car telephone operating nearby may cause the unit to malfunction. Turn off the main power switch or circuit breaker and then turn them on again. Push the ON / OFF button on the remote controller to restart.

### Defrosting operation

If the outdoor unit is frosted during the heating operation, defrosting starts automatically (for approximately 2 to 10 minutes) to maintain the heating capacity.

- The fans in both indoor and outdoor units will stop during the defrosting operation.
- During the defrosting operation, the defrosted water will be drained from the bottom plate of the outdoor unit.

### Heating capacity

In the heating operation, the heat is absorbed from the outside and brought into the room. This way of heating is called heat pump system. When the outside temperature is too low, it is recommended to use another heating apparatus in combination with the air conditioner.

### Air conditioner operating conditions

For proper performance, operate the air conditioner under the following temperature conditions

Cooling operation	Outdoor temperature	: -15 °C to 46 °C (Dry bulb temp.)
	Room temperature	: 21 °C to 32 °C (Dry bulb temp.), 15 °C to 24 °C (Wet bulb temp.)
<b>[CAUTION]</b> Room relative humidity – less than 80 %. If the air conditioner operates in excess of this figure, the surface of the air conditioner may cause dewing.		
Heating operation	Outdoor temperature	: -20 °C to 15 °C (Wet bulb temp.)
	Room temperature	: 15 °C to 28 °C (Dry bulb temp.)

If air conditioner is used outside of the above conditions, safety protection may work.

### Protective device

- Stops operation when the air-conditioner is overloaded.
- If the protective device is activated, the unit stops running, and the operation indicator and check indicator on the remote controller blink.

### If the protective device is activated

- Turn off the circuit breaker and perform a checkup. Continued running may cause a malfunction.
- Check whether the air filter is installed. If not, the heat exchanger may be clogged with dust and water leakage may occur.

### During cooling

- The air intake or discharge of the outdoor unit is clogged.
- Strong wind continuously blows against the outlet of the outdoor unit.

### During heating

- The air filter is clogged with a large amount of dust.
- The air intake or discharge of the indoor unit is clogged.

### Do not turn off the circuit breaker

- During the air-conditioning season, leave the circuit breaker turned on, and use the ON / OFF key on the remote controller.

### Attention to snowfall and freeze on the outdoor unit

- In snowy areas, the air intake and air discharge of the outdoor unit are often covered with snow or frozen up. If snow or freeze on the outdoor unit is left as it is, it may cause machine failure or poor warming.
- In cold areas, pay attention to the drain hose so that it perfectly drains water without water remaining inside for freeze prevention. If water freezes in the drain hose or inside the outdoor unit, it may cause machine failure or poor warming.

# 10 Installation

**Do not install the air conditioner in the following places**

- Do not install the air conditioner in any place within 1 m from a TV, stereo, or radio set. If the unit is installed in such place, noise transmitted from the air conditioner affects the operation of these appliances.
- Do not install the air conditioner near a high frequency appliance (such as sewing machine or massager for business use), otherwise the air conditioner may malfunction.
- Places where iron or other metal dust is present. If iron or other metal dust adheres to or collects on the interior of the air conditioner, it may spontaneously combust and start a fire.
- Do not install the air conditioner in a humid or oily place, or in a place where steam, soot, or corrosive gas is generated.
- Do not install the air conditioner in a salty place such as seaside area.
- Do not install the air conditioner in a place where a great deal of machine oil is used.
- Do not install the air conditioner in a place where it is usually exposed to strong wind such as in seaside area.
- Do not install the air conditioner in a place where sulfurous gas generated such as in a spa.
- Do not install the air conditioner in a vessel or mobile crane.
- Do not install the air conditioner in an acidic or alkaline atmosphere (in a hot-spring area or near a chemicals factory, or in a place subject to combustion emissions). Corrosion may be generated on the aluminum fin and copper pipe of the heat exchanger.
- Do not install the air conditioner near an obstacle (such as air vent, lighting equipment) that disturbs discharge air. (Turbulent airflow may reduce the performance or disable devices.)
- Do not use the air conditioner for special purposes such as preserving food, precision instruments, or art objects, or where breeding animals or growing plants are kept. (This may degrade the quality of preserved materials.)
- Do not install the air conditioner over an object that must not get wet. (Condensation may drop from the indoor unit at a humidity of 80% or more or when the drain port is clogged.)
- Do not install the air conditioner in a place where an organic solvent is used.
- Do not install the air conditioner near a door or window subject to humid outside air. Condensation may form on the air conditioner.
- Do not install the air conditioner in a place where special spray is used frequently.

**Be careful with noise or vibrations**

- Do not install the air conditioner in a place where noise by outdoor unit or hot air from its air discharge annoys your neighbours.
- Install the air conditioner on a solid and stable foundation so that it prevents transmission of resonating, operation noise and vibration.
- If one indoor unit is operating, some sound may be audible from other indoor units that are not operating.

# 11 Specifications

Model	Sound pressure level (dBA)		Weight (kg)
	Cooling	Heating	
RAV-SM2244DTP-E	44	44	97
RAV-SM2804DTP-E	46	46	97

---

## Declaration of Conformity

Manufacturer: **TOSHIBA CARRIER (THAILAND) CO., LTD.**  
144 / 9 Moo 5, Bangkadi Industrial Park, Tivanon Road, Tambol Bangkadi,  
Amphur Muang, Pathumthani 12000, Thailand

Authorized Representative /  
TCF holder: Nick Ball  
Toshiba EMEA Engineering Director  
Toshiba Carrier UK Ltd.  
Porsham Close, Belliver Industrial Estate,  
PLYMOUTH, Devon, PL6 7DB.  
United Kingdom

Hereby declares that the machinery described below:

Generic Denomination: Air Conditioner

Model / type: RAV-SM2244DTP-E,  
RAV-SM2804DTP-E

Commercial name: Digital Inverter Series Air Conditioner

Complies with the provisions of the "Machinery" Directive (Directive 2006/42/EC) and the regulations transposing into national law

**"Declaration of incorporation of partly completed machinery"**

Must not be put into service until the final machinery into which it is to be incorporated has been declared in conformity with the provisions of this Directive, where appropriate.

**NOTE**

This declaration becomes invalid if technical or operational modifications are introduced without the manufacturer's consent.

---

Information according to EMC Directive 2004 / 108 / EC	
(Name of the manufacturer)	TOSHIBA CARRIER (THAILAND) CO., LTD.
(Address, city, country)	144 / 9 Moo 5, Bangkadi Industrial Park, Tivanon Road, Tambol Bangkadi, Amphur Muang, Pathumthani 12000, Thailand
(Name of the Importer/Distributor in EU)	Toshiba Carrier UK Ltd.
(Address, city, country)	Porsham Close, Belliver Industrial Estate, PLYMOUTH, Devon, PL6 7DB. United Kingdom

**TOSHIBA CARRIER (THAILAND) CO.,LTD.**  
**144/9 MOO 5, BANGKADI INDUSTRIAL PARK, TIVANON ROAD, TAMBOL BANGKADI,**  
**AMPHUR MUANG, PATHUMTHANI 12000, THAILAND.**

**1117880699**