

TOSHIBA

FILE NO. SVM-13072-2

SERVICE MANUAL

AIR-CONDITIONER

(SPLIT TYPE)

OUTDOOR UNIT
<DIGITAL INVERTER>

RAV-SM564ATP-E (TR)

RAV-SM804ATP-E (TR)

RAV-SM1104ATP-E (TR)

RAV-SM1404ATP-E (TR)

RAV-SM564ATJP-E

RAV-SM804ATJP-E

RAV-SM1104ATJP-E

RAV-SM1404ATJP-E



Revised on March, 2017

Original instruction**Adoption of Refrigerant**

To prevent the ozone layer destruction, this air conditioner adopted refrigerant HFC (R410A) instead the conventional refrigerant R22.

CONTENTS

SAFETY CAUTION	3
1. SPECIFICATIONS	14
1-1. Outdoor Unit.....	14
1-2. Operation Characteristic Curve.....	16
2. CONSTRUCTION VIEWS (EXTERNAL VIEWS)	18
2-1. RAV-SM564AT*P*, SM804AT*P*.....	18
2-2. RAV-SM1104AT*P*, SM1404AT*P*.....	19
3. SYSTEMATIC REFRIGERATING CYCLE DIAGRAM	21
3-1. Indoor Unit.....	21
3-2. Outdoor Unit.....	22
4. WIRING DIAGRAM	26
4-1. RAV-SM564AT*P*, SM804AT*P*.....	26
4-2. RAV-SM1104AT*P*, SM1404AT*P*.....	27
5. SPECIFICATIONS OF ELECTRICAL PARTS	28
6. REFRIGERANT R410A	29
6-1. Safety During Installation/Serviceing	29
6-2. Refrigerant Piping Installation	29
6-3. Tools	33
6-4. Recharging of Refrigerant.....	33
6-5. Brazing of Pipes	34
6-6. Instructions for Re-use Piping of R22 or R407C.....	36
6-7. Replenishing refrigerant.....	39
7. OUTDOOR CONTROL CIRCUIT	40
7-1. Outline of Main Controls.....	40
7-2. Outdoor Print Circuit Board.....	45
8. TROUBLESHOOTING	47
8-1. Summary of Troubleshooting.....	47
8-2. Troubleshooting	49
8-3. Table Inspection of outdoor unit main parts	72
9. SETUP AT LOCAL SITE AND OTHERS	73
9-1. Calling of Error History	73
9-2. Group Control Operation.....	73
9-3. Outdoor Unit.....	75
9-4. Applicable Control of Outdoor Unit.....	84
10. ADDRESS SETUP	85
10-1. Address Setup Procedure	85
10-2. Address Setup & Group Control.....	86
10-3. Remote Controller Wiring.....	89
10-4. Address Setup (Manual setting from remote controller).....	89
10-5. Confirmation of Indoor Unit No. Position.....	90
11. REPLACEMENT OF THE SERVICE P.C. BOARD	92
12. HOW TO EXCHANGE COMPRESSOR	95
12-1. Exchanging Procedure of Compressor (Outline)	95
12-2. Exchange of Compressor.....	95
13. DETACHMENTS	96
13-1. RAV-SM564AT*P*, SM804AT*P*.....	96
13-2. RAV-SM1104AT*P*, SM1404AT*P*.....	104
14. EXPLODED VIEWS AND PARTS LIST	114
14-1. RAV-SM564ATP-E, SM564ATJP-E, SM564ATP-TR	114
14-2. RAV-SM804ATP-E, SM804ATJP-E, SM804ATP-TR	118
14-3. RAV-SM1104ATP-E, SM1104ATJP-E, SM1104ATP-TR	
RAV-SM1404ATP-E, SM1404ATPJ-E, SM1404ATP-TR	122

SAFETY CAUTION

Please read carefully through these instructions that contain important information which complies with the "Machinery" Directive (Directive 2006/42/EC), and ensure that you understand them.

Generic Denomination: Air Conditioner

Definition of Qualified Installer or Qualified Service Person

The air conditioner must be installed, maintained, repaired and removed by a qualified installer or qualified service person.

When any of these jobs is to be done, ask a qualified installer or qualified service person to do them for you.

A qualified installer or qualified service person is an agent who has the qualifications and knowledge described in the table below.

Agent	Qualifications and knowledge which the agent must have
Qualified installer (*1)	<ul style="list-style-type: none"> • The qualified installer is a person who installs, maintains, relocates and removes the air conditioners made by Toshiba Carrier Corporation. He or she has been trained to install, maintain, relocate and remove the air conditioners made by Toshiba Carrier Corporation or, alternatively, he or she has been instructed in such operations by an individual or individuals who have been trained and is thus thoroughly acquainted with the knowledge related to these operations. • The qualified installer who is allowed to do the electrical work involved in installation, relocation and removal has the qualifications pertaining to this electrical work as stipulated by the local laws and regulations, and he or she is a person who has been trained in matters relating to electrical work on the air conditioners made by Toshiba Carrier Corporation or, alternatively, he or she has been instructed in such matters by an individual or individuals who have been trained and is thus thoroughly acquainted with the knowledge related to this work. • The qualified installer who is allowed to do the refrigerant handling and piping work involved in installation, relocation and removal has the qualifications pertaining to this refrigerant handling and piping work as stipulated by the local laws and regulations, and he or she is a person who has been trained in matters relating to refrigerant handling and piping work on the air conditioners made by Toshiba Carrier Corporation or, alternatively, he or she has been instructed in such matters by an individual or individuals who have been trained and is thus thoroughly acquainted with the knowledge related to this work. • The qualified installer who is allowed to work at heights has been trained in matters relating to working at heights with the air conditioners made by Toshiba Carrier Corporation or, alternatively, he or she has been instructed in such matters by an individual or individuals who have been trained and is thus thoroughly acquainted with the knowledge related to this work.
Qualified service person (*1)	<ul style="list-style-type: none"> • The qualified service person is a person who installs, repairs, maintains, relocates and removes the air conditioners made by Toshiba Carrier Corporation. He or she has been trained to install, repair, maintain, relocate and remove the air conditioners made by Toshiba Carrier Corporation or, alternatively, he or she has been instructed in such operations by an individual or individuals who have been trained and is thus thoroughly acquainted with the knowledge related to these operations. • The qualified service person who is allowed to do the electrical work involved in installation, repair, relocation and removal has the qualifications pertaining to this electrical work as stipulated by the local laws and regulations, and he or she is a person who has been trained in matters relating to electrical work on the air conditioners made by Toshiba Carrier Corporation or, alternatively, he or she has been instructed in such matters by an individual or individuals who have been trained and is thus thoroughly acquainted with the knowledge related to this work. • The qualified service person who is allowed to do the refrigerant handling and piping work involved in installation, repair, relocation and removal has the qualifications pertaining to this refrigerant handling and piping work as stipulated by the local laws and regulations, and he or she is a person who has been trained in matters relating to refrigerant handling and piping work on the air conditioners made by Toshiba Carrier Corporation or, alternatively, he or she has been instructed in such matters by an individual or individuals who have been trained and is thus thoroughly acquainted with the knowledge related to this work. • The qualified service person who is allowed to work at heights has been trained in matters relating to working at heights with the air conditioners made by Toshiba Carrier Corporation or, alternatively, he or she has been instructed in such matters by an individual or individuals who have been trained and is thus thoroughly acquainted with the knowledge related to this work.

Definition of Protective Gear

When the air conditioner is to be transported, installed, maintained, repaired or removed, wear protective gloves and “safety” work clothing.



In addition to such normal protective gear, wear the protective gear described below when undertaking the special work detailed in the table below.

Failure to wear the proper protective gear is dangerous because you will be more susceptible to injury, burns, electric shocks and other injuries.

Work undertaken	Protective gear worn
All types of work	Protective gloves “Safety” working clothing
Electrical-related work	Gloves to provide protection for electricians Insulating shoes Clothing to provide protection from electric shock
Work done at heights (50 cm or more)	Helmets for use in industry
Transportation of heavy objects	Shoes with additional protective toe cap
Repair of outdoor unit	Gloves to provide protection for electricians



The important contents concerned to the safety are described on the product itself and on this Service Manual. Please read this Service Manual after understanding the described items thoroughly in the following contents (Indications/Illustrated marks), and keep them.

[Explanation of indications]

Indication	Explanation
 DANGER	Indicates contents assumed that an imminent danger causing a death or serious injury of the repair engineers and the third parties when an incorrect work has been executed.
 WARNING	Indicates possibilities assumed that a danger causing a death or serious injury of the repair engineers, the third parties, and the users due to troubles of the product after work when an incorrect work has been executed.
 CAUTION	Indicates contents assumed that an injury or property damage (*) may be caused on the repair engineers, the third parties, and the users due to troubles of the product after work when an incorrect work has been executed.

* Property damage : Enlarged damage concerned to property, furniture, and domestic animal/pet

[Explanation of illustrated marks]





Mark	Explanation
	Indicates prohibited items (Forbidden items to do) The sentences near an illustrated mark describe the concrete prohibited contents.
	Indicates mandatory items (Compulsory items to do) The sentences near an illustrated mark describe the concrete mandatory contents.
	Indicates cautions (Including danger/warning) The sentences or illustration near or in an illustrated mark describe the concrete cautious contents.

Warning Indications on the Air Conditioner Unit

[Confirmation of warning label on the main unit]

Confirm that labels are indicated on the specified positions





If removing the label during parts replace, stick it as the original.

Warning indication		Description
 <p>WARNING</p> <p>ELECTRICAL SHOCK HAZARD Disconnect all remote electric power supplies before servicing.</p>	<p>WARNING</p> <p>ELECTRICAL SHOCK HAZARD Disconnect all remote electric power supplies before servicing.</p>	
 <p>WARNING</p> <p>Moving parts. Do not operate unit with grille removed. Stop the unit before the servicing.</p>	<p>WARNING</p> <p>Moving parts. Do not operate unit with grille removed. Stop the unit before the servicing.</p>	
 <p>CAUTION</p> <p>High temperature parts. You might get burned when removing this panel.</p>	<p>CAUTION</p> <p>High temperature parts. You might get burned when removing this panel.</p>	
 <p>CAUTION</p> <p>Do not touch the aluminum fins of the unit. Doing so may result in injury.</p>	<p>CAUTION</p> <p>Do not touch the aluminum fins of the unit. Doing so may result in injury.</p>	
 <p>CAUTION</p> <p>BURST HAZARD Open the service valves before the operation, otherwise there might be the burst.</p>	<p>CAUTION</p> <p>BURST HAZARD Open the service valves before the operation, otherwise there might be the burst.</p>	

Precaution for Safety

The manufacturer shall not assume any liability for the damage caused by not observing the description of this manual.







DANGER





 Turn off breaker.	Before carrying out the installation, maintenance, repair or removal work, be sure to set the circuit breaker to the OFF position. Otherwise, electric shocks may result.
	Before opening the intake grille of the indoor unit or service panel or valve cover of the outdoor unit, set the circuit breaker to the OFF position. Failure to set the circuit breaker to the OFF position may result in electric shocks through contact with the interior parts. Only a qualified installer (*1) or qualified service person (*1) is allowed to remove the intake grille of the indoor unit or service panel of the outdoor unit and do the work required.
	Before starting to repair the outdoor unit fan or fan guard, be absolutely sure to set the circuit breaker to the OFF position, and place a "Work in progress" sign on the circuit breaker before proceeding with the work.
	When cleaning the filter or other parts of the indoor unit, set the circuit breaker to OFF without fail, and place a "Work in progress" sign near the circuit breaker before proceeding with the work.
 Electric shock hazard	When you access inside of the service panel to repair electric parts, wait for about five minutes after turning off the breaker. Do not start repairing immediately. Otherwise you may get electric shock by touching terminals of high-voltage capacitors. Natural discharge of the capacitor takes about five minutes.
	Before operating the air conditioner after having completed the work, check that the electrical parts box cover of the indoor unit and service panel or valve cover of the outdoor unit are closed, and set the circuit breaker to the ON position. You may receive an electric shock etc. if the power is turned on without first conducting these checks.
 Execute discharge between terminals.	Even if the circuit breaker has been set to the OFF position before the service panel is removed and the electrical parts are repaired, you will still risk receiving an electric shock. For this reason, short-circuit the high-voltage capacitor terminals to discharge the voltage before proceeding with the repair work. For details on the short-circuiting procedure, refer to the Service Manual. You may receive an electric shock if the voltage stored in the capacitors has not been sufficiently discharged.
 Prohibition	Place a "Work in progress" sign near the circuit breaker while the installation, maintenance, repair or removal work is being carried out. There is a danger of electric shocks if the circuit breaker is set to ON by mistake.
	When checking the electric parts, removing the cover of the electric parts box of Indoor Unit and/or front panel of Outdoor Unit inevitably to determine the failure, put a sign "Do not enter" around the site before the work. Failure to do this may result in third person getting electric shock.
 Stay on protection	If, in the course of carrying out repairs, it becomes absolutely necessary to check out the electrical parts with the electrical parts box cover of one or more of the indoor units and the service panel of the outdoor unit removed in order to find out exactly where the trouble lies, wear insulated heat-resistant gloves, insulated boots and insulated work overalls, and take care to avoid touching any live parts. You may receive an electric shock if you fail to heed this warning. Only qualified service person (*1) is allowed to do this kind of work.





WARNING

 General	Before starting to repair the air conditioner, read carefully through the Service Manual, and repair the air conditioner by following its instructions.
	Only qualified service person (*1) is allowed to repair the air conditioner. Repair of the air conditioner by unqualified person may give rise to a fire, electric shocks, injury, water leaks and/or other problems.
	Only a qualified installer (*1) or qualified service person (*1) is allowed to carry out the electrical work of the air conditioner. Under no circumstances must this work be done by an unqualified individual since failure to carry out the work properly may result in electric shocks and/or electrical leaks.
	Wear protective gloves and safety work clothing during installation, servicing and removal.

WARNING

 General	<p>Use wiring that meets the specifications in the Installation Manual and the stipulations in the local regulations and laws. Use of wiring which does not meet the specifications may give rise to electric shocks, electrical leakage, smoking and/or a fire.</p>
	<p>The appliance shall be installed in accordance with national wiring regulations. Capacity shortages of the power circuit or an incomplete installation may cause an electric shock or fire.</p>
	<p>Only a qualified installer (*1) or qualified service person (*1) is allowed to undertake work at heights using a stand of 50 cm or more.</p>
	<p>When working at heights, use a ladder which complies with the ISO 14122 standard, and follow the procedure in the ladder's instructions. Also wear a helmet for use in industry as protective gear to undertake the work.</p>
	<p>When working at heights, put a sign in place so that no-one will approach the work location, before proceeding with the work. Parts and other objects may fall from above, possibly injuring a person below.</p>
	<p>Do not touch the aluminum fin of the outdoor unit. You may injure yourself if you do so. If the fin must be touched for some reason, first put on protective gloves and safety work clothing, and then proceed.</p>
	<p>Do not climb onto or place objects on top of the outdoor unit. You may fall or the objects may fall off of the outdoor unit and result in injury.</p>
	<p>When transporting the air conditioner, wear shoes with additional protective toe caps.</p>
	<p>When transporting the air conditioner, do not take hold of the bands around the packing carton. You may injure yourself if the bands should break.</p>
	<p>When transporting the air conditioner, use a forklift and when moving the air conditioner by hand, move the unit with 2 people. (SM56, 80), or move the unit with 4 people. (SM110, 140)</p>
	<p>Do not customize the product. Doing so may result in electric shock or other failure. This air conditioner has passed the pressure test as specified in IEC 60335-2-40 Annex EE.</p>
 Check earth wires.	<p>Before troubleshooting or repair work, check the earth wire is connected to the earth terminals of the main unit, otherwise an electric shock is caused when a leak occurs. If the earth wire is not correctly connected, contact an electric engineer for rework.</p>
	<p>After completing the repair or relocation work, check that the ground wires are connected properly.</p>
	<p>Be sure to connect earth wire. (Grounding work) Incomplete grounding causes an electric shock. Do not connect ground wires to gas pipes, water pipes, and lightning rods or ground wires for telephone wires.</p>
 Prohibition of modification.	<p>Do not modify the products. Do not also disassemble or modify the parts. It may cause a fire, electric shock or injury.</p>
 Use specified parts.	<p>When any of the electrical parts are to be replaced, ensure that the replacement parts satisfy the specifications given in the Service Manual (or use the parts contained on the parts list in the Service Manual). Use of any parts which do not satisfy the required specifications may give rise to electric shocks, smoking and/or a fire.</p>
 Do not bring a child close to the equipment.	<p>If, in the course of carrying out repairs, it becomes absolutely necessary to check out the electrical parts with the electrical parts box cover of one or more of the indoor units and the service panel of the outdoor unit removed in order to find out exactly where the trouble lies, place "Keep out" signs around the work site before proceeding. Third-party individuals may enter the work site and receive electric shocks if this warning is not heeded.</p>
 Insulating measures	<p>Connect the cut-off lead wires with crimp contact, etc, put the closed end side upward and then apply a water-cut method, otherwise a leak or production of fire is caused at the users' side.</p>
 No fire	<p>When performing repairs using a gas burner, replace the refrigerant with nitrogen gas because the oil that coats the pipes may otherwise burn.</p>
	<p>When repairing the refrigerating cycle, take the following measures. 1) Be attentive to fire around the cycle. When using a gas stove, etc, be sure to put out fire before work; otherwise the oil mixed with refrigerant gas may catch fire. 2) Do not use a welder in the closed room. When using it without ventilation, carbon monoxide poisoning may be caused. 3) Do not bring inflammables close to the refrigerant cycle, otherwise fire of the welder may catch the inflammables.</p>

 Refrigerant	<p>The refrigerant used by this air conditioner is the R410A.</p>
	<p>Check the used refrigerant name and use tools and materials of the parts which match with it. For the products which use R410A refrigerant, the refrigerant name is indicated at a position on the outdoor unit where is easy to see. To prevent miss-charging, the route of the service port is changed from one of the former R22.</p>
	<p>Do not use any refrigerant different from the one specified for complement or replacement. Otherwise, abnormally high pressure may be generated in the refrigeration cycle, which may result in a failure or explosion of the product or an injury to your body.</p>
	<p>For an air conditioner which uses R410A, never use other refrigerant than R410A. For an air conditioner which uses other refrigerant (R22, etc.), never use R410A. If different types of refrigerant are mixed, abnormal high pressure generates in the refrigerating cycle and an injury due to breakage may be caused.</p>
	<p>Do not charge refrigerant additionally. If charging refrigerant additionally when refrigerant gas leaks, the refrigerant composition in the refrigerating cycle changes resulted in change of air conditioner characteristics or refrigerant over the specified standard amount is charged and an abnormal high pressure is applied to the inside of the refrigerating cycle resulted in cause of breakage or injury. Therefore if the refrigerant gas leaks, recover the refrigerant in the air conditioner, execute vacuuming, and then newly recharge the specified amount of liquid refrigerant. In this time, never charge the refrigerant over the specified amount.</p>
	<p>When recharging the refrigerant in the refrigerating cycle, do not mix the refrigerant or air other than R410A into the specified refrigerant. If air or others is mixed with the refrigerant, abnormal high pressure generates in the refrigerating cycle resulted in cause of injury due to breakage.</p>
	<p>After the installation work, confirm that refrigerant gas does not leak. If refrigerant gas leaks into the room and flows near a fire source, such as a cooking range, noxious gas may be generated.</p>
 Assembly/ Cabling	<p>After repair work, surely assemble the disassembled parts, and connect and lead the removed wires as before. Perform the work so that the cabinet or panel does not catch the inner wires. If incorrect assembly or incorrect wire connection was done, a disaster such as a leak or fire is caused at user's side.</p>
 Insulator check	<p>After the work has finished, be sure to use an insulation tester set (500V Megger) to check the resistance is 1MΩ or more between the charge section and the non-charge metal section (Earth position). If the resistance value is low, a disaster such as a leak or electric shock is caused at user's side.</p>
 Ventilation	<p>When the refrigerant gas leaks during work, execute ventilation. If the refrigerant gas touches to a fire, poisonous gas generates. A case of leakage of the refrigerant and the closed room full with gas is dangerous because a shortage of oxygen occurs. Be sure to execute ventilation.</p>
	<p>If refrigerant gas has leaked during the installation work, ventilate the room immediately. If the leaked refrigerant gas comes in contact with fire, noxious gas may be generated.</p>
 Compulsion	<p>After the installation work, confirm that refrigerant gas does not leak. If refrigerant gas leaks into the room and flows near a fire source, such as a cooking range, noxious gas may be generated.</p>
	<p>When the refrigerant gas leaks, find up the leaked position and repair it surely. If the leaked position cannot be found up and the repair work is interrupted, pump-down and tighten the service valve, otherwise the refrigerant gas may leak into the room. The poisonous gas generates when gas touches to fire such as fan heater, stove or cooking stove though the refrigerant gas itself is innocuous. When installing equipment which includes a large amount of charged refrigerant such as a multi air conditioner in a sub-room, it is necessary that the density does not the limit even if the refrigerant leaks. If the refrigerant leaks and exceeds the limit density, an accident of shortage of oxygen is caused.</p>
	<p>Tighten the flare nut with a torque wrench in the specified manner. Excessive tighten of the flare nut may cause a crack in the flare nut after a long period, which may result in refrigerant leakage.</p>
	<p>Nitrogen gas must be used for the airtight test.</p>
	<p>The charge hose must be connected in such a way that it is not slack.</p>
	<p>For the installation/moving/reinstallation work, follow to the Installation Manual. If an incorrect installation is done, a trouble of the refrigerating cycle, water leak, electric shock or fire is caused.</p>

 Check after repair	Once the repair work has been completed, check for refrigerant leaks, and check the insulation resistance and water drainage. Then perform a trial run to check that the air conditioner is running properly.
	After repair work has finished, check there is no trouble. If check is not executed, a fire, electric shock or injury may be caused. For a check, turn off the power breaker.
	After repair work (installation of front panel and cabinet) has finished, execute a test run to check there is no generation of smoke or abnormal sound. If check is not executed, a fire or an electric shock is caused. Before test run, install the front panel and cabinet.
 Do not operate the unit with the valve closed.	Check the following matters before a test run after repairing piping. <ul style="list-style-type: none"> • Connect the pipes surely and there is no leak of refrigerant. • The valve is opened. Running the compressor under condition that the valve closes causes an abnormal high pressure resulted in damage of the parts of the compressor and etc. and moreover if there is leak of refrigerant at connecting section of pipes, the air is suctioned and causes further abnormal high pressure resulted in burst or injury.
 Check after reinstallation	Only a qualified installer (*1) or qualified service person (*1) is allowed to relocate the air conditioner. It is dangerous for the air conditioner to be relocated by an unqualified individual since a fire, electric shocks, injury, water leakage, noise and/or vibration may result.
	Check the following items after reinstallation. <ol style="list-style-type: none"> 1) The earth wire is correctly connected. 2) The power cord is not caught in the product. 3) There is no inclination or unsteadiness and the installation is stable. If check is not executed, a fire, an electric shock or an injury is caused.
	When carrying out the pump-down work shut down the compressor before disconnecting the refrigerant pipe. Disconnecting the refrigerant pipe with the service valve left open and the compressor still operating will cause air, etc. to be sucked in, raising the pressure inside the refrigeration cycle to an abnormally high level, and possibly resulting in reputing, injury, etc.
 Cooling check	When the service panel of the outdoor unit is to be opened in order for the compressor or the area around this part to be repaired immediately after the air conditioner has been shut down, set the circuit breaker to the OFF position, and then wait at least 10 minutes before opening the service panel. If you fail to heed this warning, you will run the risk of burning yourself because the compressor pipes and other parts will be very hot to the touch. In addition, before proceeding with the repair work, wear the heat-resistant gloves.
	When the service panel of the outdoor unit is to be opened in order for the fan motor, reactor, inverter or the areas around these parts to be repaired immediately after the air conditioner has been shut down, set the circuit breaker to the OFF position, and then wait at least 10 minutes before opening the service panel. If you fail to heed this warning, you will run the risk of burning yourself because the fan motor, reactor, inverter heat sink and other parts will be very hot to the touch. In addition, before proceeding with the repair work, wear the heat-resistant gloves.
 Installation	Only a qualified installer (*1) or qualified service person (*1) is allowed to install the air conditioner. If the air conditioner is installed by an unqualified individual, a fire, electric shocks, injury, water leakage, noise and/or vibration may result.
	Before starting to install the air conditioner, read carefully through the Installation Manual, and follow its instructions to install the air conditioner.
	Do not install the air conditioner in a location that may be subject to a risk of expire to a combustible gas. If a combustible gas leaks and becomes concentrated around the unit, a fire may occur.
	Install a circuit breaker that meets the specifications in the installation manual and the stipulations in the local regulations and laws.
	Install the circuit breaker where it can be easily accessed by the agent. Do not place any combustion appliance in a place where it is directly exposed to the wind of air conditioner, otherwise it may cause imperfect combustion.

Explanations given to user

- If you have discovered that the fan grille is damaged, do not approach the outdoor unit but set the circuit breaker to the OFF position, and contact a qualified service person to have the repairs done.
Do not set the circuit breaker to the ON position until the repairs are completed.

Relocation

- Only a qualified installer (*1) or qualified service person (*1) is allowed to relocate the air conditioner. It is dangerous for the air conditioner to be relocated by an unqualified individual since a fire, electric shocks, injury, water leakage, noise and/or vibration may result.
- When carrying out the pump-down work shut down the compressor before disconnecting the refrigerant pipe. Disconnecting the refrigerant pipe with the service valve left open and the compressor still operating will cause air, etc. to be sucked in, raising the pressure inside the refrigeration cycle to an abnormally high level, and possibly resulting in reputeing, injury, etc.

(*1) Refer to the "Definition of Qualified Installer or Qualified Service Person."

Declaration of Conformity

Manufacturer: TOSHIBA CARRIER (THAILAND) CO., LTD.
144 / 9 Moo 5, Bangkadi Industrial Park, Tivanon Road,
Amphur Muang, Pathumthani 12000, Thailand

Authorized Nick Ball

Representative/TCF holder: Toshiba EMEA Engineering Director
Toshiba Carrier UK Ltd.
Porsham Close, Belliver Industrial Estate,
PLYMOUTH, Devon, PL6 7DB.
United Kingdom

Hereby declares that the machinery described below:

Generic Denomination: Air Conditioner

Model/type: RAV-SM564ATP-E, RAV-SM804ATP-E, RAV-SM1104ATP-E,
RAV-SM1404ATP-E, RAV-SM564ATJP-E, RAV-SM804ATJP-E,
RAV-SM1104ATJP-E, RAV-SM1404ATJP-E, RAV-SM564ATP-TR,
RAV-SM804ATP-TR, RAV-SM1104ATP-TR, RAV-SM1404ATP-TR

Commercial name: Digital Inverter Series Air Conditioner

Complies with the provisions of the "Machinery" Directive (Directive 2006/42/EC) and the regulations transposing into national law.

Complies with the provisions of the following harmonized standard:

EN 378-2: 2008 + A2:2012

Note: This declaration becomes invalid if technical or operational modifications are introduced without the manufacturer's consent.

Disposal

How to dispose of air conditioners with a rating of 12 kW and below in accordance with the 2002/96/EC Directive WEEE (Waste Electrical and Electronic Equipment) is provided in the Installation Manual supplied with your product. For disposal of the product above 12 kW in rating you should use a registered company in accordance with any national or EU legislation.

<Model names with a rating of 12 kW and below (outdoor units)>

DI series

RAV-SM564ATP-E, RAV-SM804ATP-E, RAV-SM1104ATP-E,
RAV-SM564ATJP-E, RAV-SM804ATJP-E, RAV-SM1104ATJP-E,
RAV-SM564ATP-TR, RAV-SM804ATP-TR, RAV-SM1104ATP-TR

Specifications

Model	Sound power level (dBA)		Weight (kg)
	Cooling	Heating	
RAV-SM564ATP-E	*	*	40
RAV-SM564ATJP-E	*	*	40
RAV-SM804ATP-E	*	*	44
RAV-SM804ATJP-E	*	*	44
RAV-SM1104ATP-E	*	71	68
RAV-SM1104ATJP-E	*	71	68
RAV-SM1404ATP-E	*	71	68
RAV-SM1404ATJP-E	*	71	68
RAV-SM564ATP-TR	*	*	40
RAV-SM804ATP-TR	*	*	44
RAV-SM1104ATP-TR	*	71	68
RAV-SM1404ATP-TR	*	71	68

*: Under 70 dBA

• Refrigerant (R410A)

This air conditioner adopts HFC type refrigerant (R410A) which does not deplete the ozone layer.

1. Safety Caution Concerned to Refrigerant

The pressure of R410A is high 1.6 times of that of the former refrigerant (R22).

Accompanied with change of refrigerant, the refrigerating oil has been also changed.

Therefore, be sure that water, dust, the former refrigerant or the former refrigerating oil is not mixed into the refrigerating cycle of the air conditioner with refrigerant during installation work or service work.

If an incorrect work or incorrect service is performed, there is a possibility to cause a serious accident.

Use the tools and materials exclusive to R410A to purpose a safe work.

2. Cautions on Installation/Service

1) Do not mix the other refrigerant or refrigerating oil.

For the tools exclusive to R410A, shapes of all the joints including the service port differ from those of the former refrigerant in order to prevent mixture of them.

2) As the use pressure of the refrigerant is high, use material thickness of the pipe and tools which are specified for R410A.

3) In the installation time, use clean pipe materials and work with great attention so that water and others do not mix in because pipes are affected by impurities such as water, oxide scales, oil, etc.

Use the clean pipes.

Be sure to brazing with flowing nitrogen gas. (Never use gas other than nitrogen gas.)

4) For the earth protection, use a vacuum pump for air purge.

5) R410A refrigerant is azeotropic mixture type refrigerant.

Therefore use liquid type to charge the refrigerant. (If using gas for charging, composition of the refrigerant changes and then characteristics of the air conditioner change.)

3. Pipe Materials

For the refrigerant pipes, copper pipe and joints are mainly used.

It is necessary to select the most appropriate pipes to conform to the standard.

Use clean material in which impurities adhere inside of pipe or joint to a minimum.

1) Copper pipe

<Piping>

The pipe thickness, flare finishing size, flare nut and others differ according to a refrigerant type.

When using a long copper pipe for R410A, it is recommended to select "Copper or copper-base pipe without seam" and one with bonded oil amount 40mg/10m or less.

Also do not use crushed, deformed, discolored (especially inside) pipes.

(Impurities cause clogging of expansion valves and capillary tubes.)

<Flare nut>

Use the flare nuts which are attached to the air conditioner unit.

2) Joint

The flare joint and socket joint are used for joints of the copper pipe.

The joints are rarely used for installation of the air conditioner. However clear impurities when using them.

4. Tools

1. Required Tools for R410A

Mixing of different types of oil may cause a trouble such as generation of sludge, clogging of capillary, etc. Accordingly, the tools to be used are classified into the following three types.

- 1) Tools exclusive for R410A (Those which cannot be used for conventional refrigerant (R22))
- 2) Tools exclusive for R410A, but can be also used for conventional refrigerant (R22)
- 3) Tools commonly used for R410A and for conventional refrigerant (R22)

The table below shows the tools exclusive for R410A and their interchangeability.

Tools exclusive for R410A (The following tools for R410A are required.)

Tools whose specifications are changed for R410A and their interchangeability

No.	Used tool	Usage	R410A air conditioner installation		Conventional air conditioner installation
			Existence of new equipment for R410A	Whether conventional equipment can be used	Whether conventional equipment can be used
①	Flare tool	Pipe flaring	Yes	*(Note)	Yes
②	Copper pipe gauge for adjusting projection margin	Flaring by conventional flare tool	Yes	*(Note)	*(Note)
③	Torque wrench	Tightening of flare nut	Yes	No	No
④	Gauge manifold	Evacuating, refrigerant charge, run check, etc.	Yes	No	No
⑤	Charge hose				
⑥	Vacuum pump adapter	Vacuum evacuating	Yes	No	Yes
⑦	Electronic balance for refrigerant charging	Refrigerant charge	Yes	Yes	Yes
⑧	Leakage detector	Gas leakage check	Yes	No	Yes

(Note) When flaring is carried out for R410A using the conventional flare tools, adjustment of projection margin is necessary. For this adjustment, a copper pipe gauge, etc. are necessary.

General tools (Conventional tools can be used.)

In addition to the above exclusive tools, the following equipments which serve also for R22 are necessary as the general tools.

- | | |
|--|--|
| 1) Vacuum pump. Use vacuum pump by
attaching vacuum pump adapter. | 7) Screwdriver (+, -) |
| 2) Torque wrench | 8) Spanner or Monkey wrench |
| 3) Pipe cutter | 9) Hole core drill |
| 4) Reamer | 10) Hexagon wrench (Opposite side 4mm) |
| 5) Pipe bender | 11) Tape measure |
| 6) Level vial | 12) Metal saw |

Also prepare the following equipments for other installation method and run check.

- | | |
|----------------|--|
| 1) Clamp meter | 3) Insulation resistance tester (Megger) |
| 2) Thermometer | 4) Electroscope |

1. SPECIFICATIONS

1-1. Outdoor Unit

<Digital Inverter>

Model name	Outdoor unit	RAV-SM	564AT*P*	804AT*P*	
Power supply			1 phase 220-240V, 50Hz 1 phase 220V, 60Hz (Power exclusive to outdoor is required.)		
Compressor	Type		Hermetic compressor		
	Motor	(kW)	1.1	1.6	
	Pole		4	4	
Refrigerant charged		(kg)	1.1	1.7	
Refrigerant control			Pulse motor valve		
Inter connecting pipe	Standard length		(m)	7.5	7.5
	Min. length		(m)	5	5
	Max. total length		(m)	30	30
	Additional refrigerant charge under long piping connector			20g/m (21m to 30m)	40g/m (21m to 30m)
	Height difference	Outdoor lower	(m)	30	30
		Outdoor higher	(m)	30	30
Outer dimension	Height		(mm)	550	550
	Width		(mm)	780	780
	Depth		(mm)	290	290
Appearance			Silky shade (Muncel 1Y8.5/0.5)		
Total weight		(kg)	40	44	
Heat exchanger			Finned tube		
Fan unit	Fan		Propeller fan		
	Standard air flow high		(m ³ /min.)	40	45
	Motor		(W)	43	43
Connecting pipe	Gas side		(mm)	12.7	15.9
	Liquid side		(mm)	6.4	9.5
Sound pressure level		Cooling/Heating (dB·A)	46/48	48/52	
Sound power level		Cooling/Heating (dB·A)	63/65	65/69	
Outside air temperature, Cooling		°C (Dry bulb temp.)	46 to -15		
Outside air temperature, Heating		°C (Wet bulb temp.)	15 to -15		

<Digital Inverter>

Model name	Outdoor unit	RAV-SM	1104AT*P*	1404AT*P*	
Power supply			1 phase 220-240V, 50Hz 1 phase 220V, 60Hz (Power exclusive to outdoor is required.)		
Compressor	Type		Hermetic compressor		
	Motor	(kW)	2.5	3.0	
	Pole		4	4	
Refrigerant charged		(kg)	2.8	2.8	
Refrigerant control			Pulse motor valve		
Inter connecting pipe	Standard length		(m)	7.5	7.5
	Min. length		(m)	5	5
	Max. total length		(m)	50	50
	Additional refrigerant charge under long piping connector			40g/m (31m to 50m)	40g/m (31m to 50m)
	Height difference	Outdoor lower	(m)	30	30
Outdoor higher		(m)	30	30	
Outer dimension	Height		(mm)	890	890
	Width		(mm)	900	900
	Depth		(mm)	320	320
Appearance			Silky shade (Muncel 1Y8.5/0.5)		
Total weight		(kg)	68	68	
Heat exchanger			Finned tube		
Fan unit	Fan		Propeller fan		
	Standard air flow high		(m ³ /min.)	70	70
	Motor		(W)	100	100
Connecting pipe	Gas side		(mm)	15.9	15.9
	Liquid side		(mm)	9.5	9.5
Sound pressure level		Cooling/Heating (dB-A)	53/54	54/55	
Sound power level		Cooling/Heating (dB-A)	70/71	70/71	
Outside air temperature, Cooling		°C (Dry bulb temp.)	46 to -15		
Outside air temperature, Heating		°C (Wet bulb temp.)	15 to -15		

1-2. Operation Characteristic Curve

RAV-SM564AT*P*, SM804AT*P*

<Cooling>

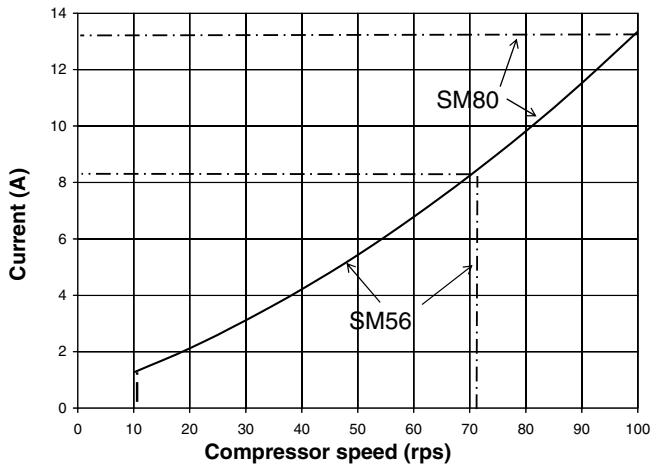

<Heating>

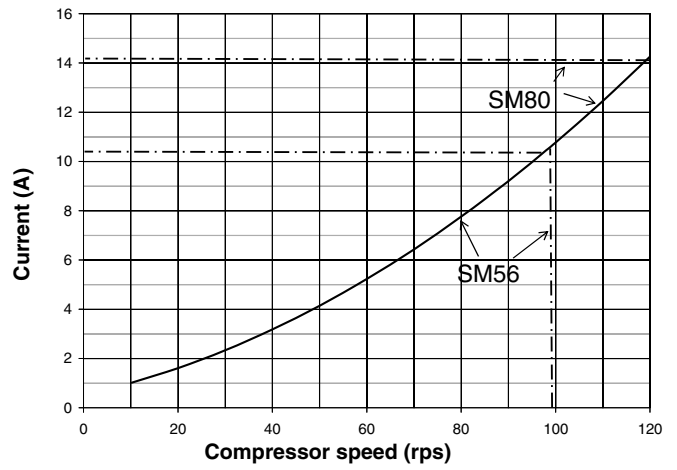

• Capacity variation ratio according to temperature

<Cooling>

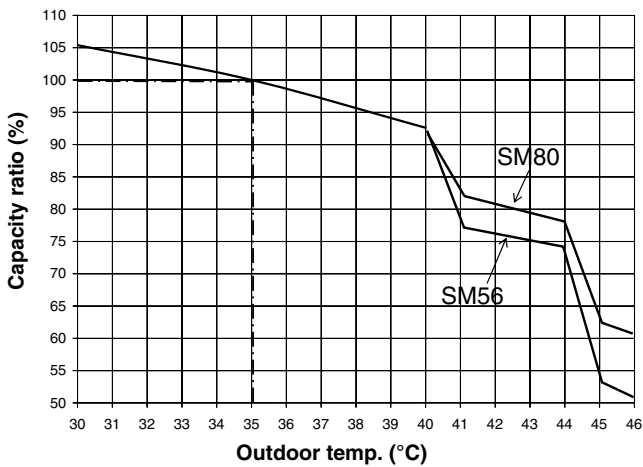

<Heating>

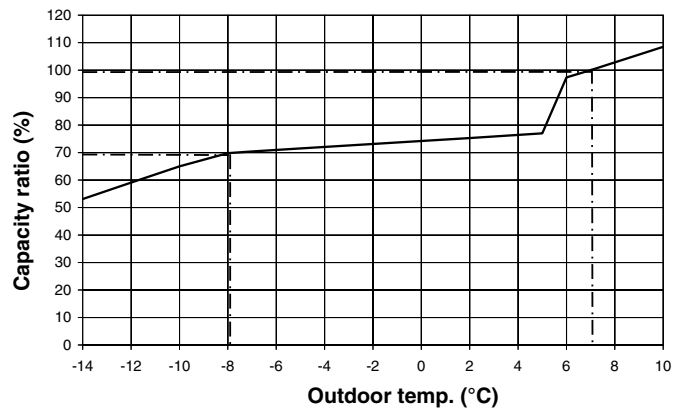

• Operation Characteristic Curve

RAV-SM1104AT*P*, SM1404AT*P*

<Cooling>

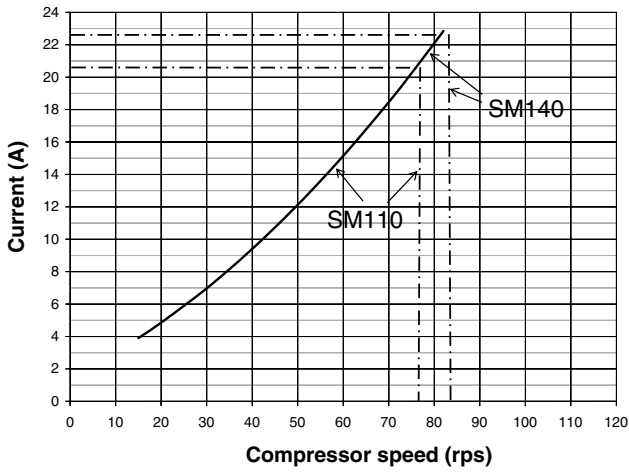

<Heating>

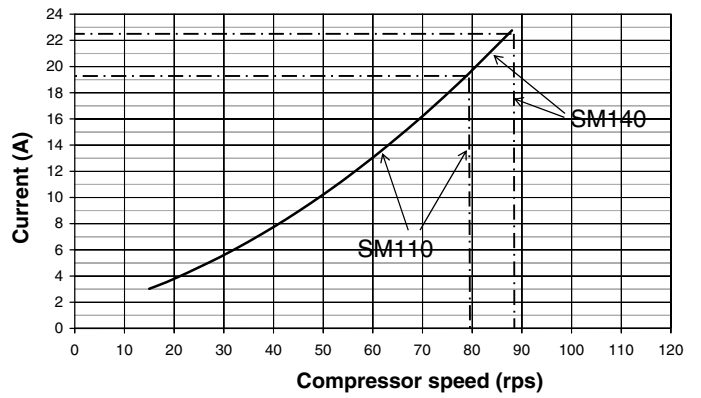

• Capacity variation ratio according to temperature

<Cooling>

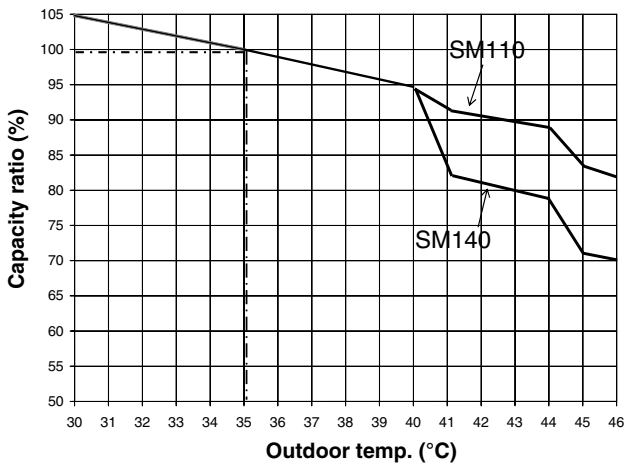

<Heating>

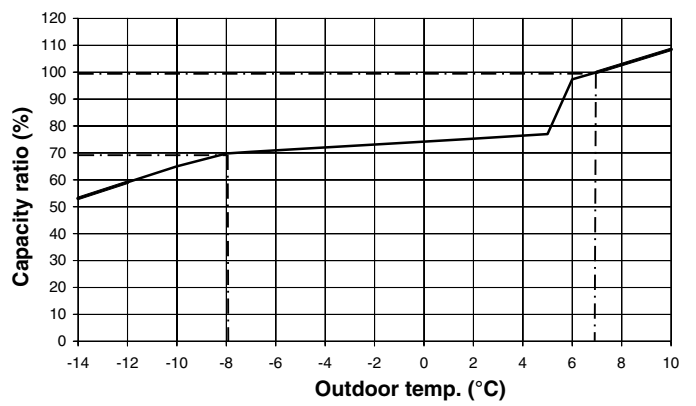

2. CONSTRUCTION VIEWS (EXTERNAL VIEWS)

2-1. RAV-SM564AT*P*, SM804AT*P*

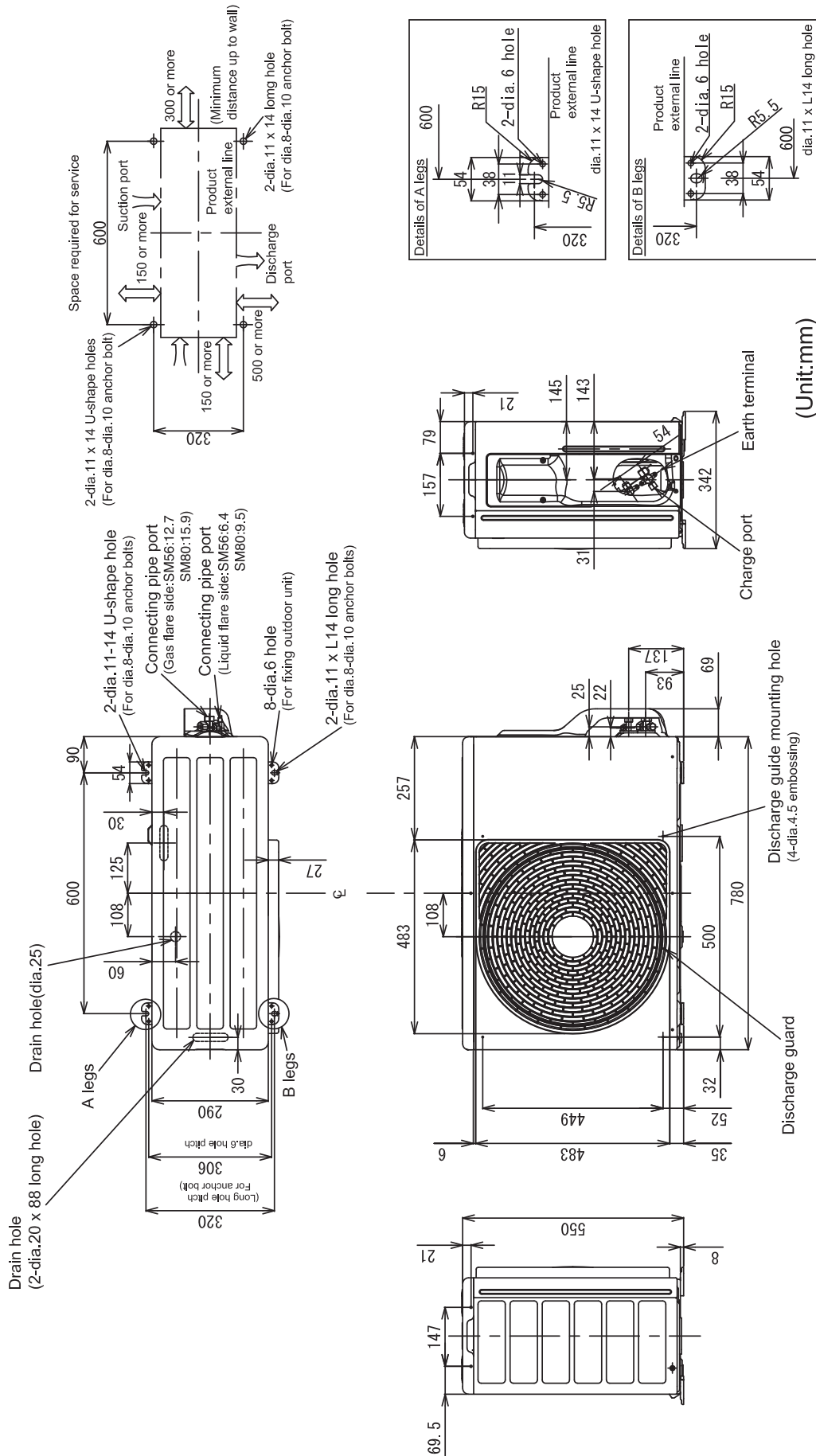

(Unit:mm)

2-2. RAV-SM1104AT*P*, SM1404AT*P*

	Name	Note
①	Refrigerant piping hole Indoor/Outdoor Unit connecting wire inlet hole	—
②	Power supply inlet hole	dia. 38 Knockout hole

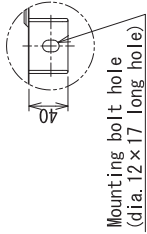
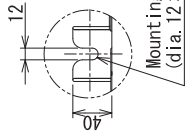

Details of B legs

Details of A legs

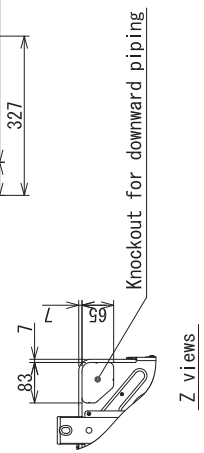
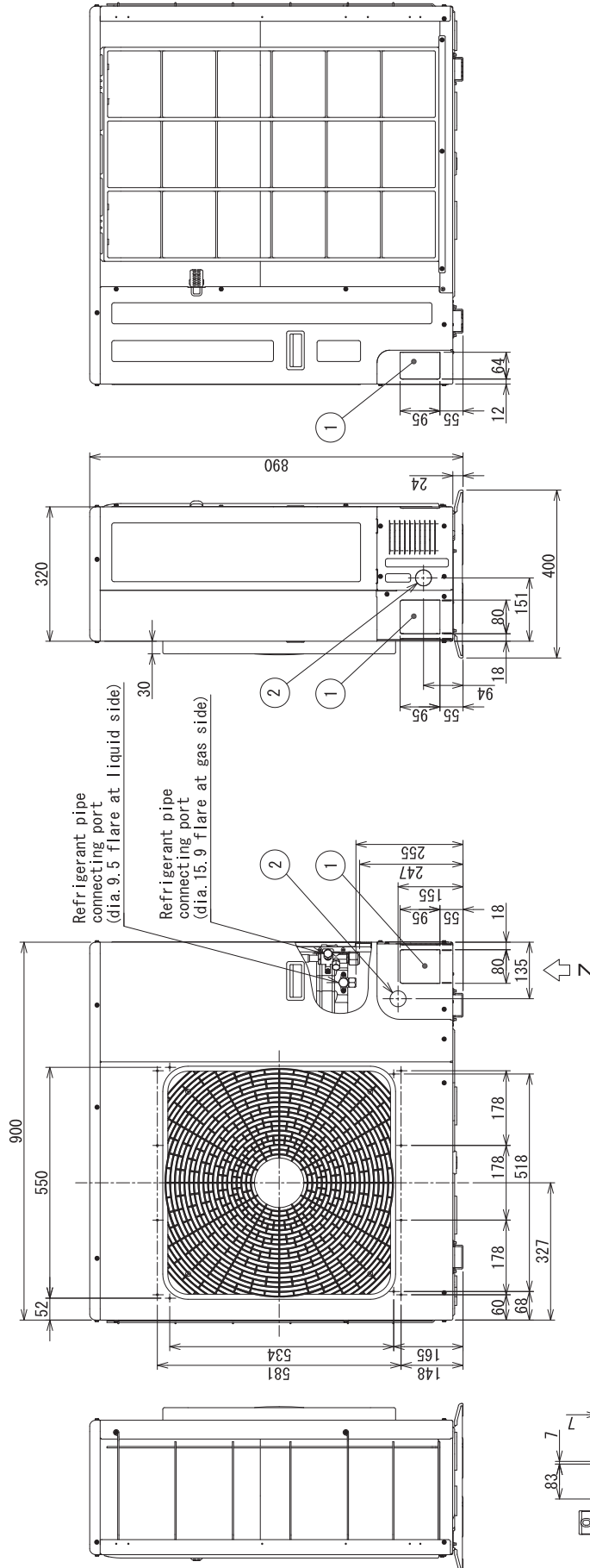
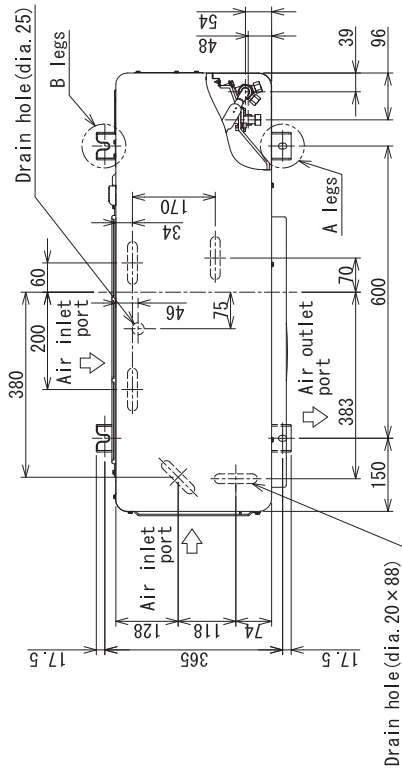

(Unit:mm)

RAV-TWP30E2, RAV-TWP50E2 (Simultaneous Twin)

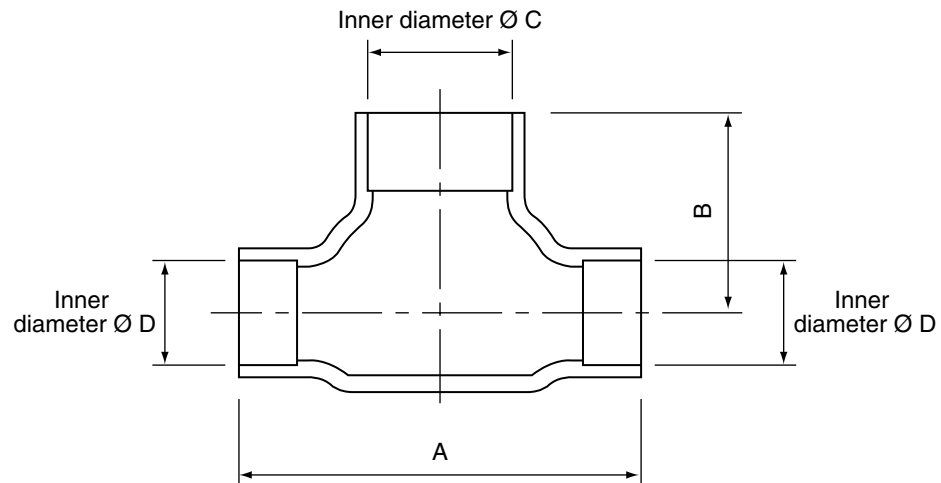

Model (RBC-)		A	B	C	D
TWP30E2	Liquid side	36	14	Ø9.5	Ø6.4
	Gas side	43	23	Ø15.9	Ø12.7
TWP50E2	Liquid side	34	14	Ø9.5	Ø9.5
	Gas side	44	21	Ø15.9	Ø15.9

3. SYSTEMATIC REFRIGERATING CYCLE DIAGRAM

3-1. Indoor Unit

- Single type (Combination of 1 indoor unit and 1 outdoor unit)

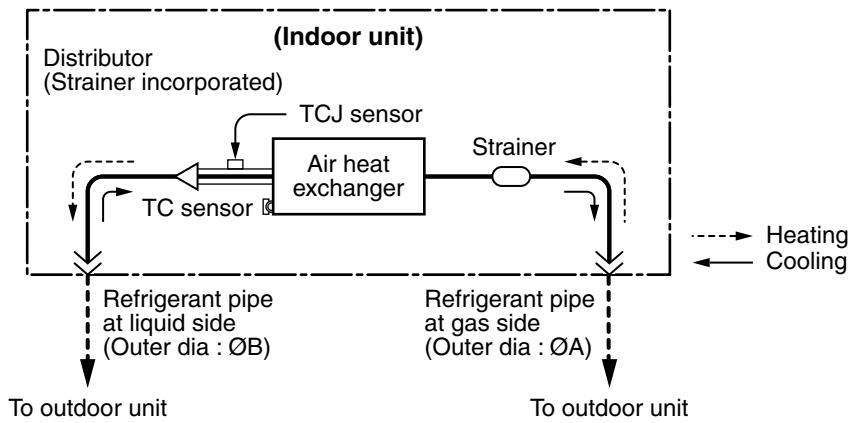

Dimension table

Indoor unit	Outer diameter of refrigerant pipe	
	Gas side ØA	Liquid side ØB
SM56 type	12.7	6.4
SM80, 110, 140 type	15.9	9.5

- Twin type (Combination of 2 indoor units and 1 outdoor unit)

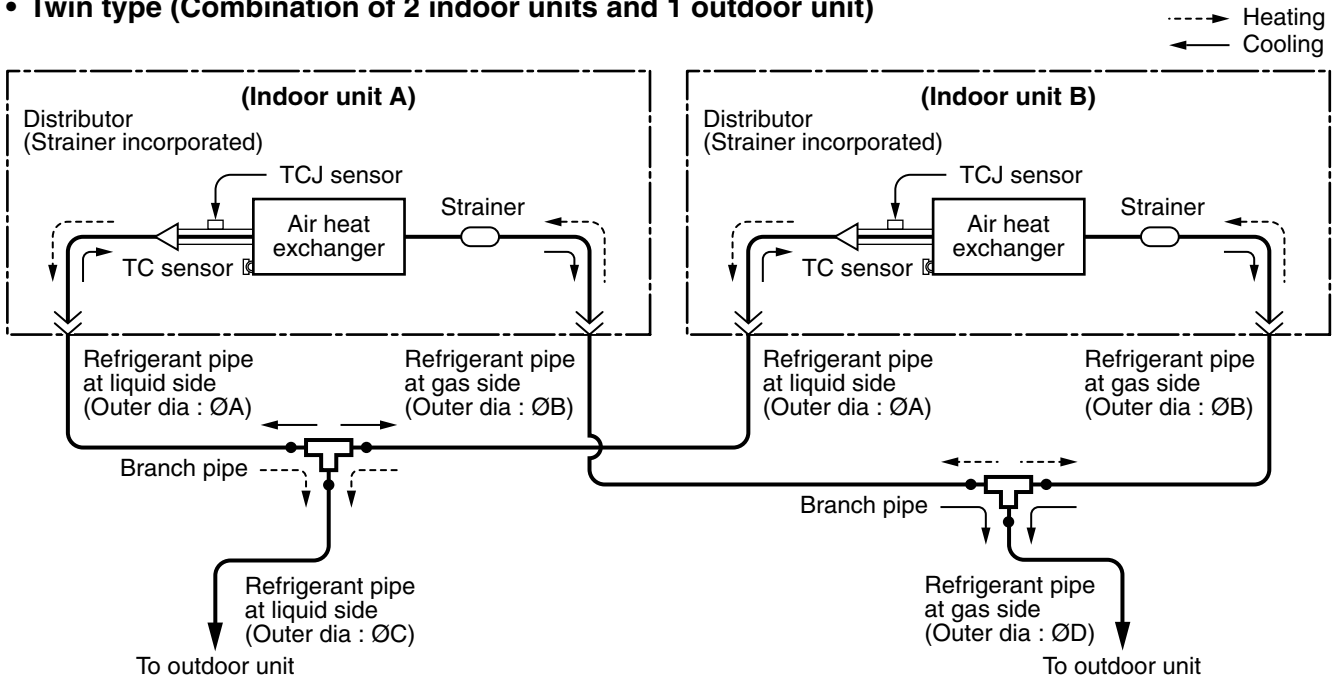

Indoor unit	Branch pipe RBC-	A	B	C	D
SM56 × 2	TWP30E2	6.4	12.7	9.5	15.9
SM80 × 2	TWP50E2	9.5	15.9	9.5	15.9

3-2. Outdoor Unit
RAV-SM564AT*P*

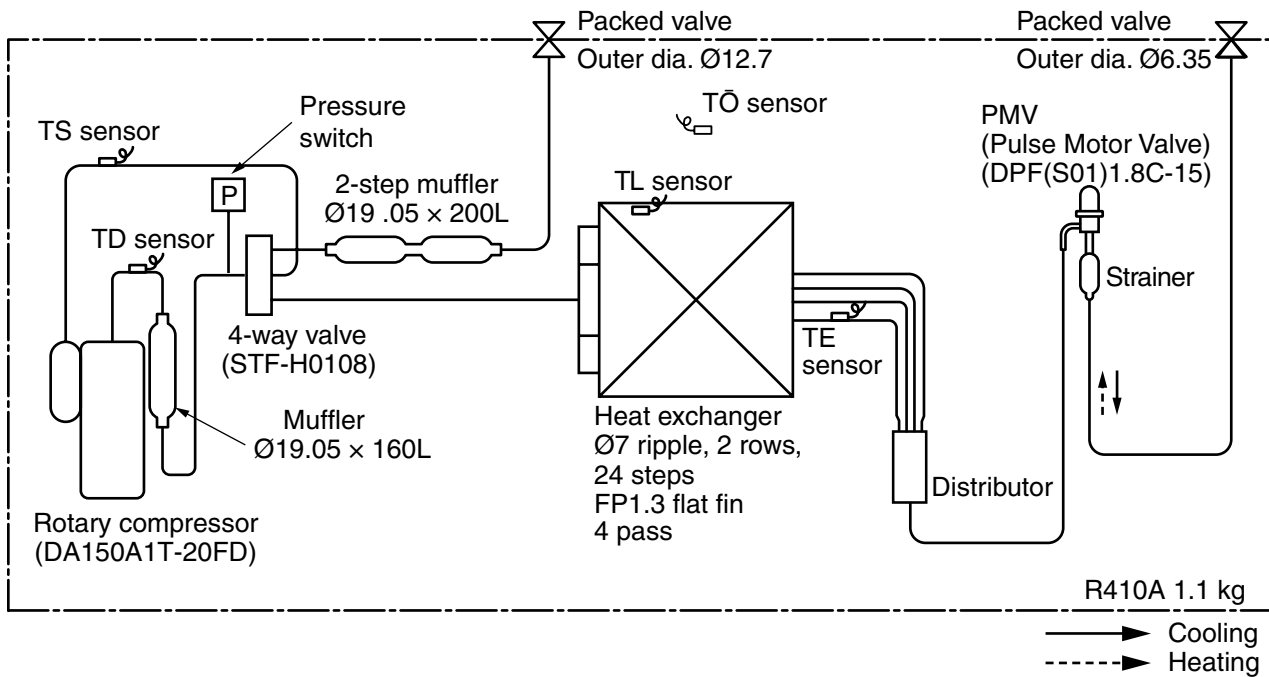

		Pressure				Pipe surface temperature (°C)				Compressor revolutions per second (rps) *	Indoor fan	Indoor/Outdoor temp. conditions (DB/WB) (°C)	
		(MPa)		(kg/cm ² G)		Discharge (TD)	Suction (TS)	Indoor heat exchanger (TC)	Outdoor heat exchanger (TE)			Indoor	Outdoor
		Pd	Ps	Pd	Ps								
Cooling	Standard	3.11	0.96	31.7	9.8	80	17	13	42	63	HIGH	27/19	35/-
	Overload	3.37	1.08	34.4	11.0	77	21	17	53	35	HIGH	32/24	46/-
	Low load	1.90	0.70	19.4	7.1	48	7	5	30	50	LOW	18/15.5	-5/-
Heating	Standard	2.27	0.63	23.1	6.4	68	5	37	1	66	HIGH	20/-	7/6
	Overload	2.86	0.89	29.2	9.1	86	17	47	11	95	LOW	28/-	24/18
	Low load	1.86	0.25	19.0	2.6	69	-14	31	-15	98	HIGH	15/-	-10/(70%)

* 4 poles are provided to this compressor.

The compressor frequency (Hz) measured with a clamp meter is 2 times of revolutions (rps) of the compressor.

RAV-SM804AT*P*

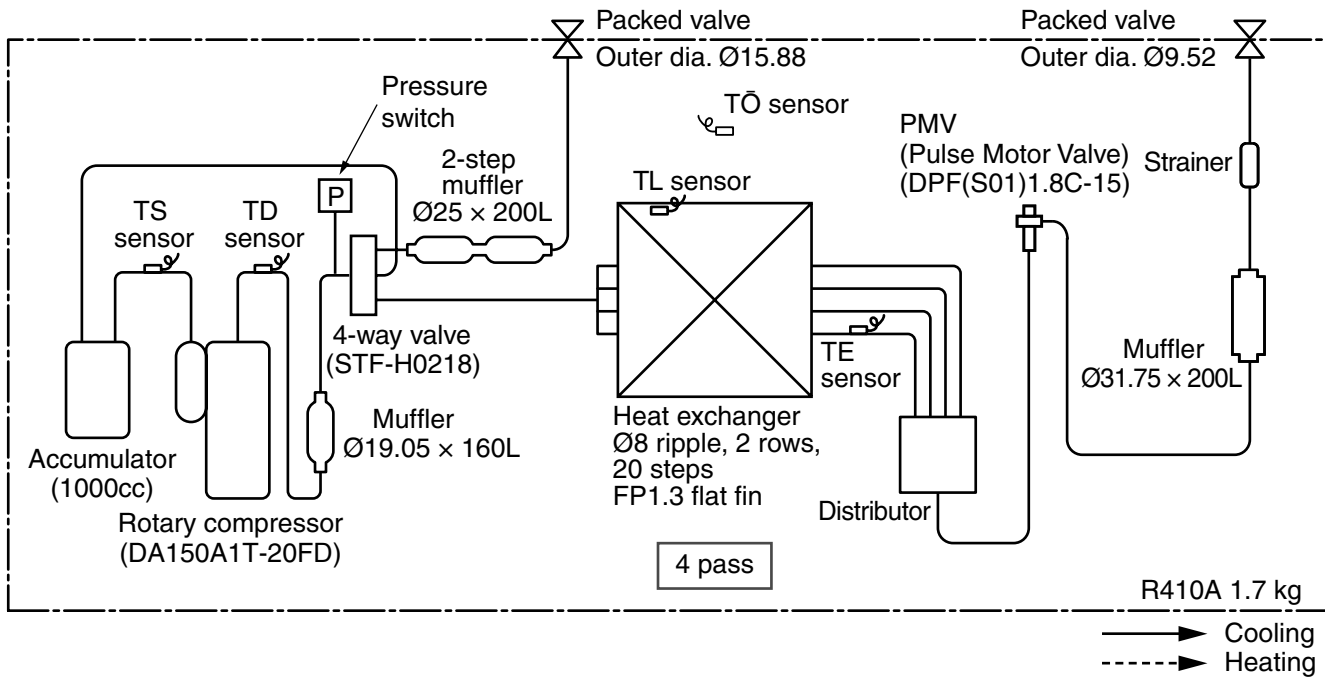

		Pressure				Pipe surface temperature (°C)				Compressor revolutions per second (rps) *	Indoor fan	Indoor/Outdoor temp. conditions (DB/WB) (°C)	
		(MPa)		(kg/cm ² G)		Discharge (TD)	Suction (TS)	Indoor heat exchanger (TC)	Outdoor heat exchanger (TE)			Indoor	Outdoor
		Pd	Ps	Pd	Ps								
Cooling	Standard	3.27	0.89	33.3	9.1	82	12	10	41	80	HIGH	27/19	35/-
	Overload	3.63	1.26	37.0	10.2	80	19	18	51	53	HIGH	32/24	46/-
	Low load	1.96	0.85	20.0	8.7	53	4	3	16	72	HIGH	18/15.5	-5/-
Heating	Standard	2.61	0.64	26.6	6.5	74	3	43	2	92	HIGH	20/-	7/6
	Overload	3.24	0.94	33.0	9.6	84	13	53	11	76	HIGH	30/-	24/18
	Low load	1.76	0.20	17.9	2.0	90	-21	31	-20	120	HIGH	15/-	-15/-

* 4 poles are provided to this compressor.

The compressor frequency (Hz) measured with a clamp meter is 2 times of revolutions (rps) of the compressor.

RAV-SM1104AT*P*, SM1404AT*P*

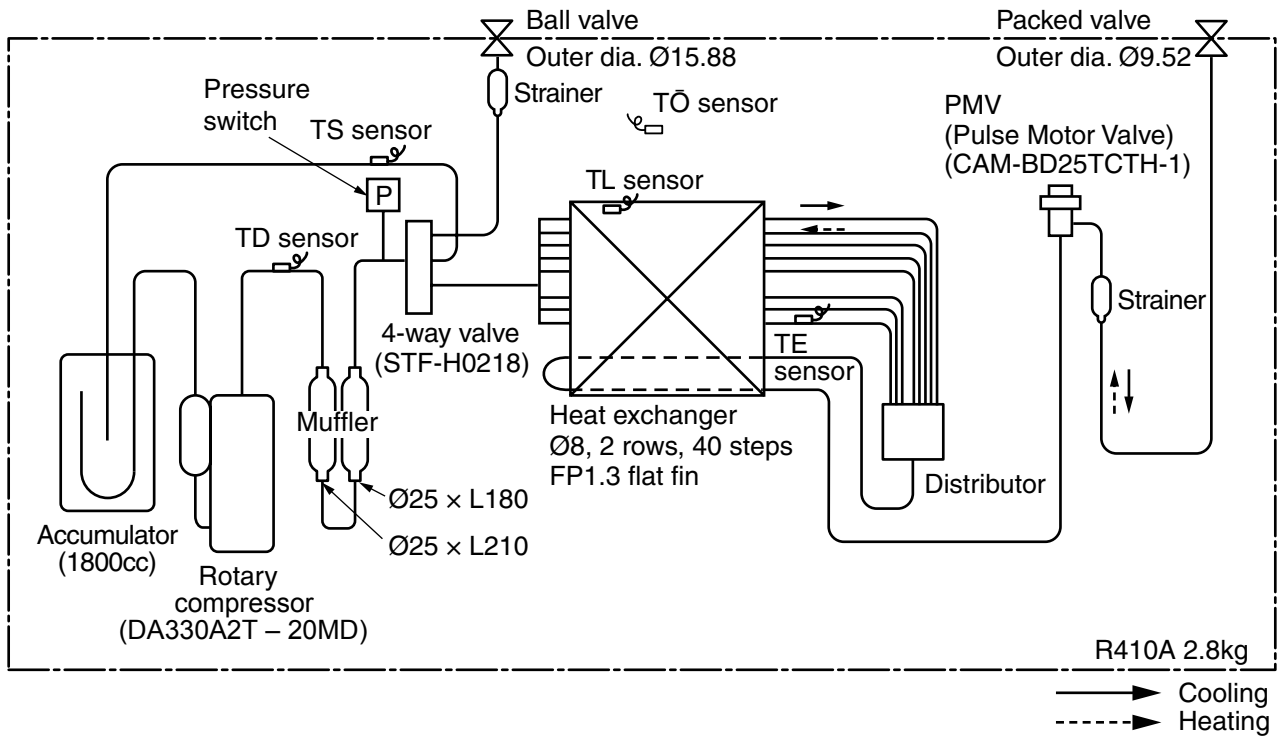

RAV-SM1104AT*P*

		Pressure				Pipe surface temperature (°C)				* Comp. Hz	Fan	Temp	
		(MPa)		(kg/cm ² G)		(TD)	(TS)	(TC)	(TE)			In	Out
		Pd	Ps	Pd	Ps								
Cooling	Standard	3.10	0.94	31.6	9.6	81	15	12	39	55	HIGH	27/19	35/-
	Overload	3.60	1.13	36.7	11.5	78	16	18	54	50	HIGH	32/24	46/-
	Low load	2.03	0.82	20.7	8.4	55	11	8	4	30	LOW	18/15.5	-15/-
Heating	Standard	2.57	0.65	26.2	6.6	75	3	41	2	58	HIGH	20/-	7/6
	Overload	3.13	1.12	31.9	11.4	76	19	52	16	30	LOW	30/-	24/18
	Low load	2.15	0.24	21.9	2.4	82	-19	34	-17	79	HIGH	15/-	-15/-

RAV-SM1404AT*P*

		Pressure				Pipe surface temperature (°C)				* Comp. Hz	Fan	Temp	
		(MPa)		(kg/cm ² G)		(TD)	(TS)	(TC)	(TE)			In	Out
		Pd	Ps	Pd	Ps								
Cooling	Standard	3.37	0.85	34.4	8.7	89	13	11	40	70	HIGH	27/19	35/-
	Overload	3.65	1.07	37.2	10.9	80	16	18	54	53	HIGH	32/24	46/-
	Low load	2.05	0.83	20.9	8.5	56	10	8	4	30	LOW	18/15.5	-15/-
Heating	Standard	2.79	0.63	28.4	6.4	79	3	45	2	67	HIGH	20/-	7/6
	Overload	3.10	1.12	30.6	11.4	75	19	51	16	30	LOW	30/-	24/18
	Low load	2.30	0.23	23.5	2.3	86	-19	38	-17	99	HIGH	15/-	-15/-

* 4 poles are provided to this compressor.
 The compressor frequency (Hz) measured with a clamp meter is 2 times of revolutions (rps) of the compressor.

4. WIRING DIAGRAM

4-1. RAV-SM564AT*P*, SM804AT*P*

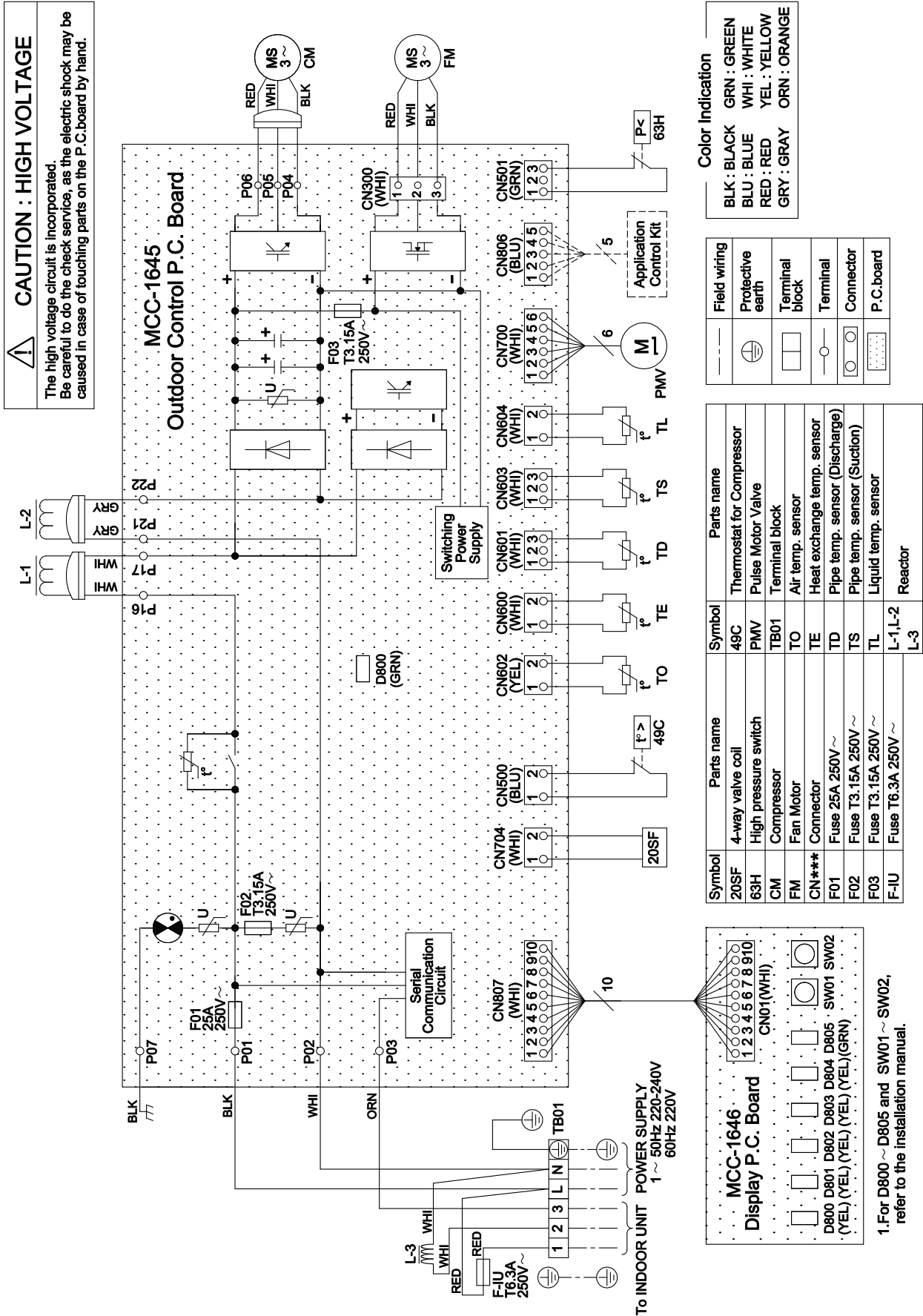

4-2. RAV-SM1104AT*P*, SM1404AT*P*

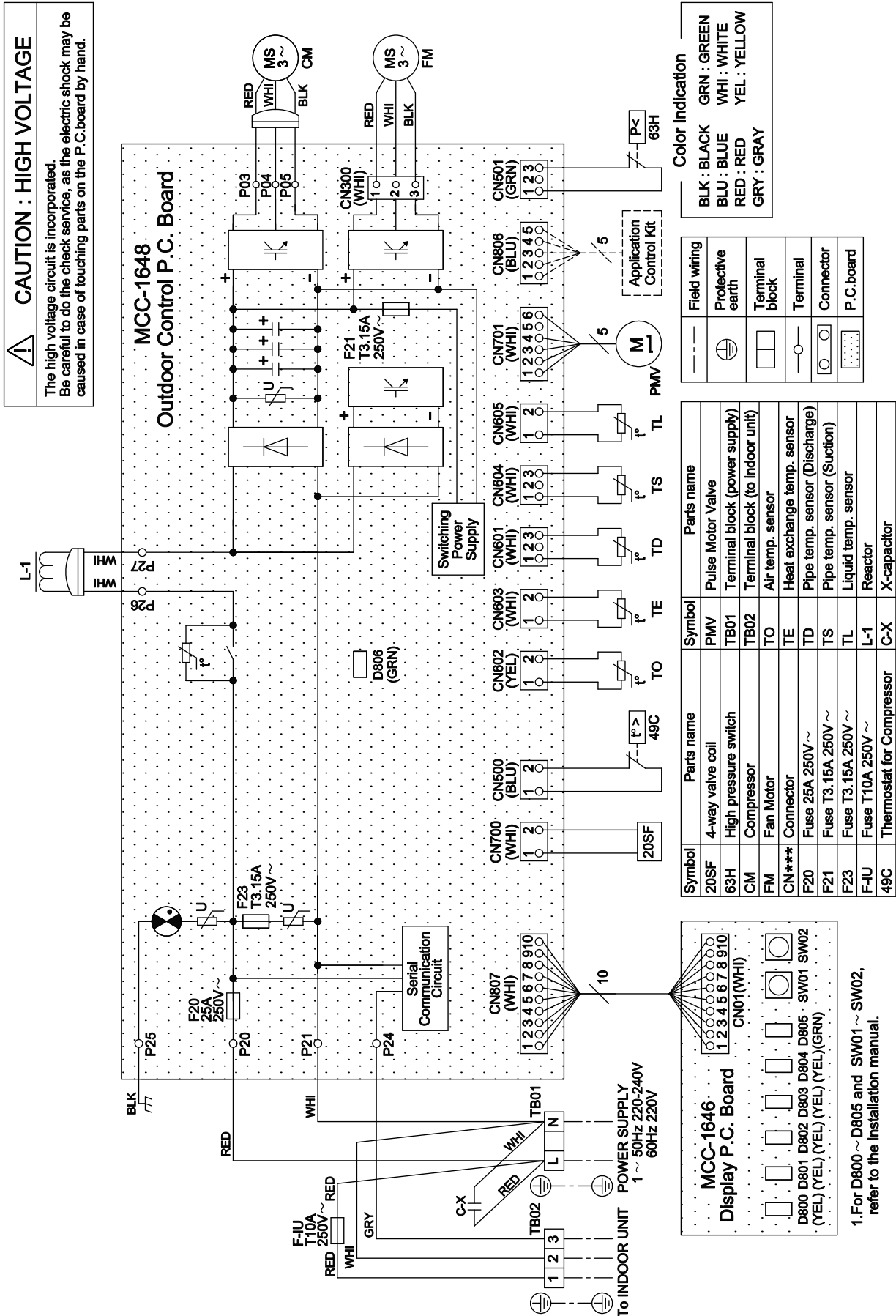

5. SPECIFICATIONS OF ELECTRICAL PARTS

RAV-SM564AT*P*, SM804AT*P*

No.	Parts name	Type	Specifications
1	Compressor	DA150A1T-20FD	3 phase, 4P, 1100 W
2	Fan motor	ICF-140-43-4R	Output 43 W
3	4-way valve coil	STF-H01AZ1724A1	-
4	PMV coil	PQ-M01012-000082	-
5	High-pressure SW	ACB-4UB83W	OFF:4.15MPa
6	Reactor	CH-57-Z-T	10mH, 16A
7	P.C. board	MCC-1645	-
8	Fuse (Mounted on P.C. board)	-	AC250 V, 25 A
9	Fuse	-	AC250 V, 6.3 A
10	Fuse (Mounted on P.C. board)	-	AC250 V, 3.15 A
11	Outdoor temp. sensor (TO sensor)	-	10 kΩ at 25°C
12	Heat exchanger temp. sensor (TE sensor)	-	10 kΩ at 25°C
13	Suction temp. sensor (TS sensor)	-	10 kΩ at 25°C
14	Discharge temp. sensor (TD sensor)	-	50 kΩ at 25°C
15	Heat exchanger temp. sensor (TL sensor)	-	50 kΩ at 25°C
16	Compressor thermo. (Protection)	CS-12AL	OFF: 125 ± 4°C, ON: 90 ± 5°C

RAV-SM1104AT*P*, SM1404AT*P*

No.	Parts name	Type	Specifications
1	Compressor	DA330A2T-20MD	3 phase, 4P, 3000W
2	Fan motor	WDF-340-A100-1	Output 100 W
3	4-way valve coil	STF-H01AZ1724A1	-
4	PMV coil	CAM-MD12TF-18	-
5	High-pressure SW	ACB-4UB83W	OFF:4.15MPa
6	Reactor	CH-62	6mH, 18.5A
7	P.C. board	MCC-1648	-
8	Fuse (Mounted on P.C. board)	-	AC250 V, 25 A
9	Fuse	-	AC250 V, 10 A
10	Fuse (Mounted on P.C. board)	-	AC250 V, 3.15 A
11	Outdoor temp. sensor (TO sensor)	-	10 kΩ at 25°C
12	Heat exchanger temp. sensor (TE sensor)	-	10 kΩ at 25°C
13	Suction temp. sensor (TS sensor)	-	10 kΩ at 25°C
14	Discharge temp. sensor (TD sensor)	-	50 kΩ at 25°C
15	Heat exchanger temp. sensor (TL sensor)	-	50 kΩ at 25°C
16	Compressor thermo. (Protection)	CS-12AL	OFF: 125 ± 4°C, ON: 90 ± 5°C

6. REFRIGERANT R410A

This air conditioner adopted the refrigerant HFC (R410A) which does not damage the ozone layer.

The working pressure of the refrigerant R410A is 1.6 times higher than conventional refrigerant (R22). The refrigerating oil is also changed in accordance with change of refrigerant, so be careful that water, dust, and existing refrigerant or refrigerating oil are not entered in the refrigerant cycle of the air conditioner using the refrigerant during installation work or servicing time.

The next section describes the precautions for air conditioner using the refrigerant.

Conforming to contents of the next section together with the general cautions included in this manual, perform the correct and safe work.

6-1. Safety During Installation/Serviceing

As R410A's pressure is about 1.6 times higher than that of R22, improper installation/servicing may cause a serious trouble. By using tools and materials exclusive for R410A, it is necessary to carry out installation/servicing safely while taking the following precautions into consideration.

1. Never use refrigerant other than R410A in an air conditioner which is designed to operate with R410A.

If other refrigerant than R410A is mixed, pressure in the refrigeration cycle becomes abnormally high, and it may cause personal injury, etc. by a rupture.

2. Confirm the used refrigerant name, and use tools and materials exclusive for the refrigerant R410A.

The refrigerant name R410A is indicated on the visible place of the outdoor unit of the air conditioner using R410A as refrigerant.

To prevent mischarging, the diameter of the service port differs from that of R22.

3. If a refrigeration gas leakage occurs during installation/servicing, be sure to ventilate fully. If the refrigerant gas comes into contact with fire, a poisonous gas may occur.
4. When installing or removing an air conditioner, do not allow air or moisture to remain in the refrigeration cycle. Otherwise, pressure in the refrigeration cycle may become abnormally high so that a rupture or personal injury may be caused.
5. After completion of installation work, check to make sure that there is no refrigeration gas leakage.

If the refrigerant gas leaks into the room, coming into contact with fire in the fan-driven heater, space heater, etc., a poisonous gas may occur.

6. When an air conditioning system charged with a large volume of refrigerant is installed in a small room, it is necessary to exercise care so that, even when refrigerant leaks, its concentration does not exceed the marginal level.

If the refrigerant gas leakage occurs and its concentration exceeds the marginal level, an oxygen starvation accident may result.

7. Be sure to carry out installation or removal according to the installation manual. Improper installation may cause refrigeration trouble, water leakage, electric shock, fire, etc.
8. Unauthorized modifications to the air conditioner may be dangerous. If a breakdown occurs please call a qualified air conditioner technician or electrician.

Improper repair may result in water leakage, electric shock and fire, etc.

6-2. Refrigerant Piping Installation

6-2-1. Piping Materials and Joints Used

For the refrigerant piping installation, copper pipes and joints are mainly used.

Copper pipes and joints suitable for the refrigerant must be chosen and installed.

Furthermore, it is necessary to use clean copper pipes and joints whose interior surfaces are less affected by contaminants.

1. Copper Pipes

It is necessary to use seamless copper pipes which are made of either copper or copper alloy and it is desirable that the amount of residual oil is less than 40 mg/10 m.

Do not use copper pipes having a collapsed, deformed or discolored portion (especially on the interior surface).

Otherwise, the expansion valve or capillary tube may become blocked with contaminants.

As an air conditioner using R410A incurs pressure higher than when using R22, it is necessary to choose adequate materials.

Thicknesses of copper pipes used with R410A are as shown in Table 6-2-1. Never use copper pipes thinner than 0.8mm even when it is available on the market.

NOTE:

Refer to the "6-6. Instructions for Re-use Piping of R22 or R407C".

Table 6-2-1 Thicknesses of annealed copper pipes

		Thickness (mm)	
Nominal diameter	Outer diameter (mm)	R410A	R22
1/4	6.4	0.80	0.80
3/8	9.5	0.80	0.80
1/2	12.7	0.80	0.80
5/8	15.9	1.00	1.00

1. Joints

For copper pipes, flare joints or socket joints are used. Prior to use, be sure to remove all contaminants.

a) Flare Joints

Flare joints used to connect the copper pipes cannot be used for pipings whose outer diameter exceeds 20 mm. In such a case, socket joints can be used.

Sizes of flare pipe ends, flare joint ends and flare nuts are as shown in Tables 6-2-3 to 6-2-5 below.

b) Socket Joints

Socket joints are such that they are brazed for connections, and used mainly for thick pipings whose diameter is larger than 20 mm. Thicknesses of socket joints are as shown in Table 6-2-2.

Table 6-2-2 Minimum thicknesses of socket joints

Nominal diameter	Reference outer diameter of copper pipe jointed (mm)	Minimum joint thickness (mm)
1/4	6.4	0.50
3/8	9.5	0.60
1/2	12.7	0.70
5/8	15.9	0.80

6-2-2. Processing of Piping Materials

When performing the refrigerant piping installation, care should be taken to ensure that water or dust does not enter the pipe interior, that no other oil other than lubricating oils used in the installed air conditioner is used, and that refrigerant does not leak.

When using lubricating oils in the piping processing, use such lubricating oils whose water content has been removed. When stored, be sure to seal the container with an airtight cap or any other cover.

1. Flare Processing Procedures and Precautions

a) Cutting the Pipe

By means of a pipe cutter, slowly cut the pipe so that it is not deformed.

b) Removing Burrs and Chips

If the flared section has chips or burrs, refrigerant leakage may occur.

Carefully remove all burrs and clean the cut surface before installation.

c) Insertion of Flare Nut

d) Flare Processing

Make certain that a clamp bar and copper pipe have been cleaned.

By means of the clamp bar, perform the flare processing correctly.

Use either a flare tool for R410A or conventional flare tool.

Flare processing dimensions differ according to the type of flare tool.

When using a conventional flare tool, be sure to secure "dimension A" by using a gauge for size adjustment.

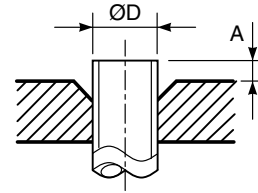

Fig. 6-2-1 Flare processing dimensions

Table 6-2-3 Dimensions related to flare processing for R410A / R22

Nominal diameter	Outer diameter (mm)	Thickness (mm)	A (mm)				
			Flare tool for R410A, R22 clutch type	Conventional flare tool (R410A)		Conventional flare tool (R22)	
				Clutch type	Wing nut type	Clutch type	Wing nut type
1/4	6.4	0.8	0 to 0.5	1.0 to 1.5	1.5 to 2.0	0.5 to 1.0	1.0 to 1.5
3/8	9.5	0.8	0 to 0.5	1.0 to 1.5	1.5 to 2.0	0.5 to 1.0	1.0 to 1.5
1/2	12.7	0.8	0 to 0.5	1.0 to 1.5	2.0 to 2.5	0.5 to 1.0	1.5 to 2.0
5/8	15.9	1.0	0 to 0.5	1.0 to 1.5	2.0 to 2.5	0.5 to 1.0	1.5 to 2.0

Table 6-2-4 Flare and flare nut dimensions for R410A

Nominal diameter	Outer diameter (mm)	Thickness (mm)	Dimension (mm)				Flare nut width (mm)
			A	B	C	D	
1/4	6.4	0.8	9.1	9.2	6.5	13	17
3/8	9.5	0.8	13.2	13.5	9.7	20	22
1/2	12.7	0.8	16.6	16.0	12.9	23	26
5/8	15.9	1.0	19.7	19.0	16.0	25	29

Table 6-2-5 Flare and flare nut dimensions for R22

Nominal diameter	Outer diameter (mm)	Thickness (mm)	Dimension (mm)				Flare nut width (mm)
			A	B	C	D	
1/4	6.4	0.8	9.1	9.2	6.5	13	17
3/8	9.5	0.8	13.0	13.5	9.7	20	22
1/2	12.7	0.8	16.2	16.0	12.9	20	24
5/8	15.9	1.0	19.4	19.0	16.0	23	27
3/4	19.0	1.0	23.3	24.0	19.2	34	36

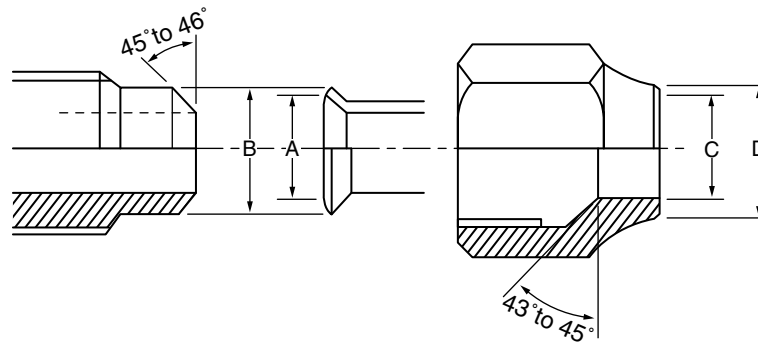

Fig. 6-2-2 Relations between flare nut and flare seal surface

2. Flare Connecting Procedures and Precautions

- Make sure that the flare and union portions do not have any scar or dust, etc.
- Correctly align the processed flare surface with the union axis.
- Tighten the flare with designated torque by means of a torque wrench.

The tightening torque for R410A is the same as that for conventional R22.

Incidentally, when the torque is weak, the gas leakage may occur.

When it is strong, the flare nut may crack and may be made non-removable.

When choosing the tightening torque, comply with values designated by manufacturers.

Table 6-2-6 shows reference values.

NOTE:

When applying oil to the flare surface, be sure to use oil designated by the manufacturer.

If any other oil is used, the lubricating oils may deteriorate and cause the compressor to burn out.

Table 6-2-6 Tightening torque of flare for R410A [Reference values]

Nominal diameter	Outer diameter (mm)	Tightening torque N•m (kgf•m)	Tightening torque of torque wrenches available on the market N•m (kgf•m)
1/4	6.4	14 to 18 (1.4 to 1.8)	16 (1.6), 18 (1.8)
3/8	9.5	33 to 42 (3.3 to 4.2)	42 (4.2)
1/2	12.7	50 to 62 (5.0 to 6.2)	55 (5.5)
5/8	15.9	63 to 77 (6.3 to 7.7)	65 (6.5)

6-3. Tools

6-3-1.Required Tools

Refer to the “4. Tools” (Page 13)

6-4. Recharging of Refrigerant

When it is necessary to recharge refrigerant, charge the specified amount of refrigerant according to the following steps.

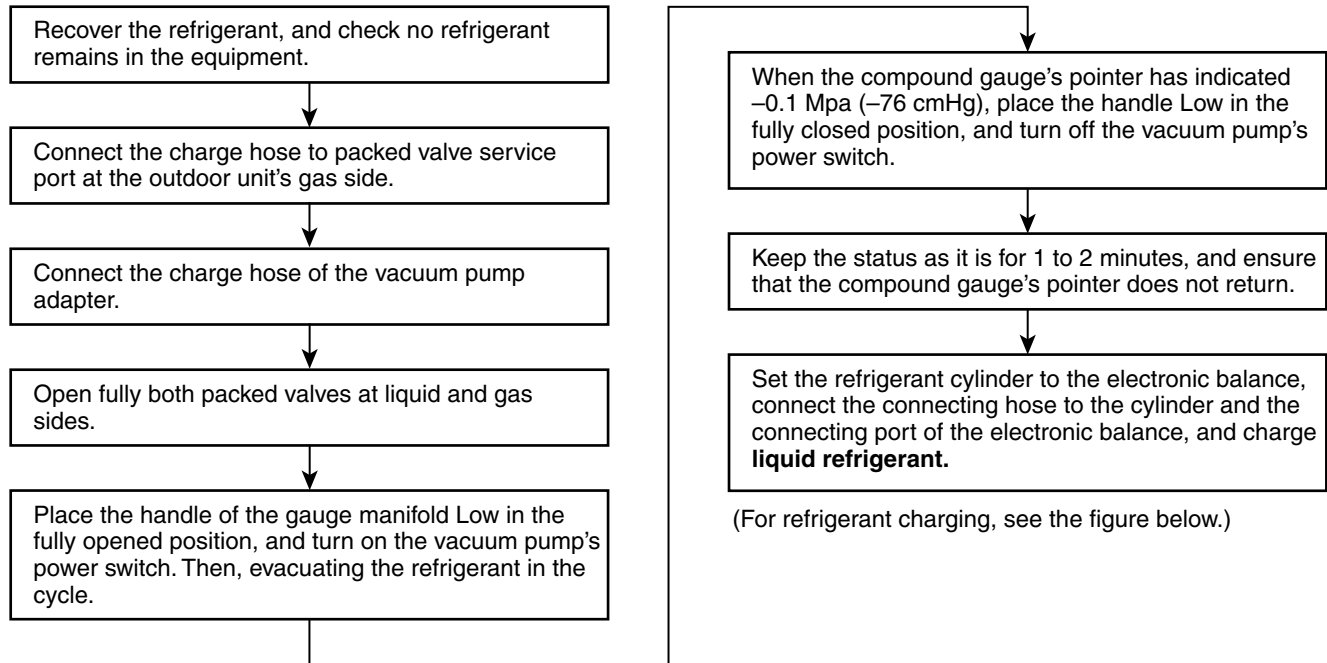

- 1) Never charge refrigerant exceeding the specified amount.
- 2) If the specified amount of refrigerant cannot be charged, charge refrigerant **bit by bit** in COOL mode.
- 3) Do not carry out additional charging.
When additional charging is carried out if refrigerant leaks, the refrigerant composition changes in the refrigeration cycle, that is characteristics of the air conditioner changes, refrigerant exceeding the specified amount is charged, and working pressure in the refrigeration cycle becomes abnormally high pressure, and may cause a rupture or personal injury.

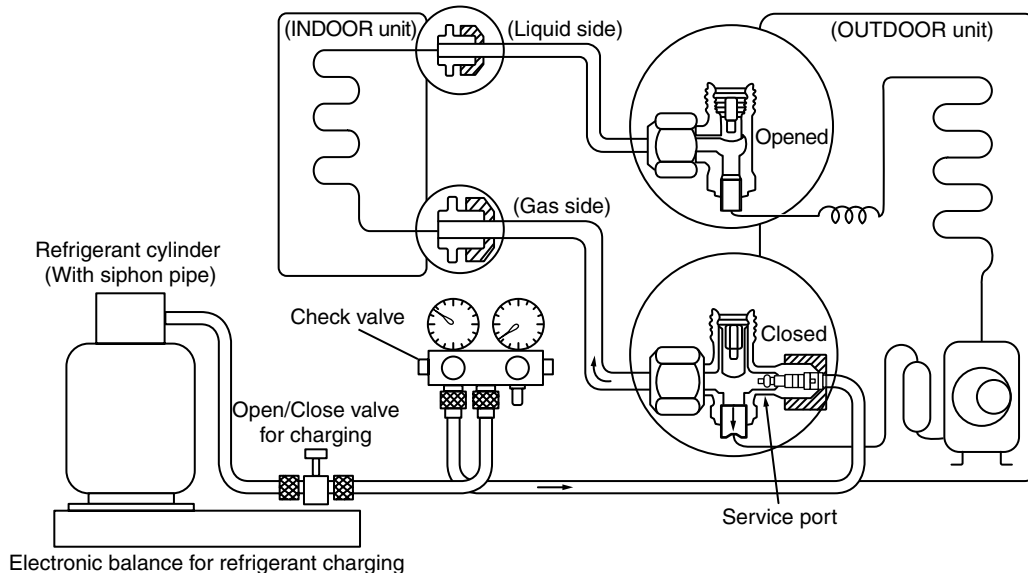
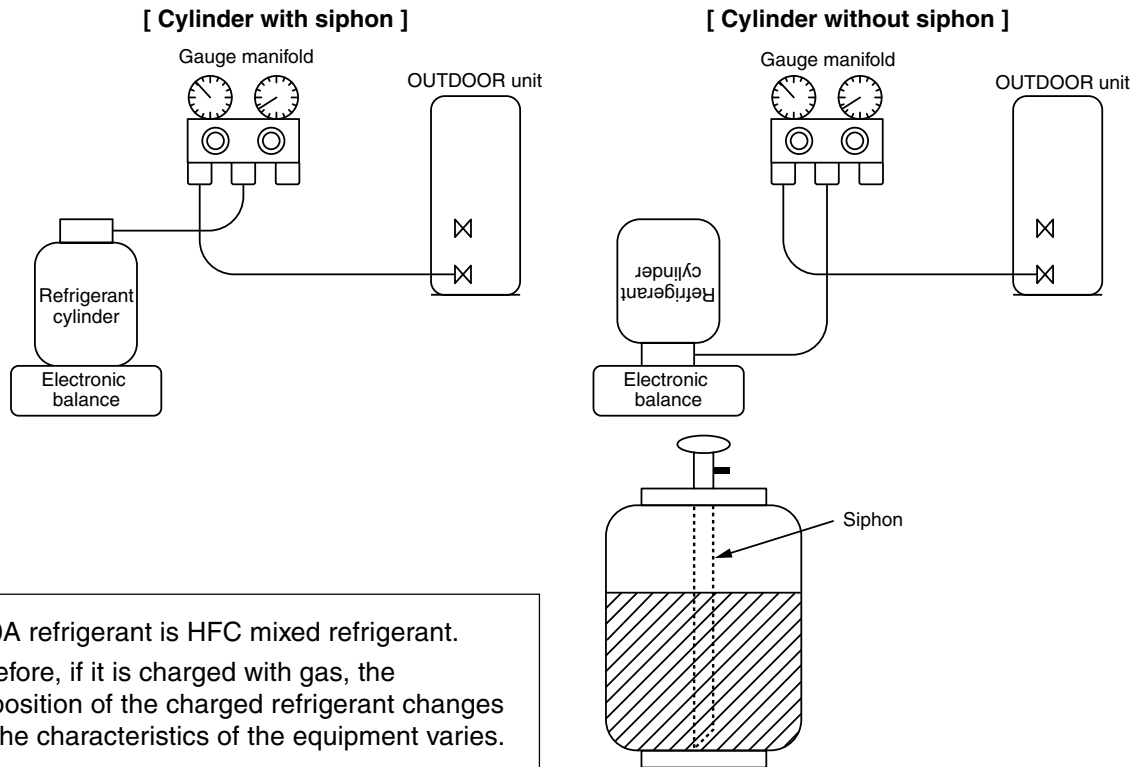

Fig. 6-4-1 Configuration of refrigerant charging

- 1) Be sure to make setting so that **liquid** can be charged.
- 2) When using a cylinder equipped with a siphon, liquid can be charged without turning it upside down.

It is necessary for charging refrigerant under condition of liquid because R410A is mixed type of refrigerant. Accordingly, when charging refrigerant from the refrigerant cylinder to the equipment, charge it turning the cylinder upside down if cylinder is not equipped with siphon.



R410A refrigerant is HFC mixed refrigerant. Therefore, if it is charged with gas, the composition of the charged refrigerant changes and the characteristics of the equipment varies.

Fig. 6-4-2

6-5. Brazing of Pipes

6-5-1. Materials for Brazing

1. Silver brazing filler

Silver brazing filler is an alloy mainly composed of silver and copper.

It is used to join iron, copper or copper alloy, and is relatively expensive though it excels in solderability.

2. Phosphor bronze brazing filler

Phosphor bronze brazing filler is generally used to join copper or copper alloy.

3. Low temperature brazing filler

Low temperature brazing filler is generally called solder, and is an alloy of tin and lead.

Since it is weak in adhesive strength, do not use it for refrigerant pipes.

- 1) Phosphor bronze brazing filler tends to react with sulfur and produce a fragile compound water solution, which may cause a gas leakage. Therefore, use any other type of brazing filler at a hot spring resort, etc., and coat the surface with a paint.
- 2) When performing brazing again at time of servicing, use the same type of brazing filler.

6-5-2. Flux

1. Reason why flux is necessary

- By removing the oxide film and any foreign matter on the metal surface, it assists the flow of brazing filler.
- In the brazing process, it prevents the metal surface from being oxidized.
- By reducing the brazing filler's surface tension, the brazing filler adheres better to the treated metal.

2. Characteristics required for flux

- Activated temperature of flux coincides with the brazing temperature.
- Due to a wide effective temperature range, flux is hard to carbonize.
- It is easy to remove slag after brazing.
- The corrosive action to the treated metal and brazing filler is minimum.
- It excels in coating performance and is harmless to the human body.

As the flux works in a complicated manner as described above, it is necessary to select an adequate type of flux according to the type and shape of treated metal, type of brazing filler and brazing method, etc.

3. Types of flux

• Noncorrosive flux

Generally, it is a compound of borax and boric acid.

It is effective in case where the brazing temperature is higher than 800°C.

• Activated flux

Most of fluxes generally used for silver brazing are this type.

It features an increased oxide film removing capability due to the addition of compounds such as potassium fluoride, potassium chloride and sodium fluoride to the borax-boric acid compound.

4. Piping materials for brazing and used brazing filler/flux

Piping material	Used brazing filler	Used flux
Copper - Copper	Phosphor copper	Do not use
Copper - Iron	Silver	Paste flux
Iron - Iron	Silver	Vapor flux

- 1) Do not enter flux into the refrigeration cycle.
- 2) When chlorine contained in the flux remains within the pipe, the lubricating oil deteriorates. Therefore, use a flux which does not contain chlorine.
- 3) When adding water to the flux, use water which does not contain chlorine (e.g. distilled water or ion-exchange water).
- 4) Remove the flux after brazing.

6-5-3. Brazing

As brazing work requires sophisticated techniques, experiences based upon a theoretical knowledge, it must be performed by a person qualified.

In order to prevent the oxide film from occurring in the pipe interior during brazing, it is effective to proceed with brazing while letting dry Nitrogen gas flow.

Never use gas other than Nitrogen gas.

1. Brazing method to prevent oxidation

- 1) Attach a reducing valve and a flow-meter to the Nitrogen gas cylinder.
- 2) Use a copper pipe to direct the piping material, and attach a flow-meter to the cylinder.
- 3) Apply a seal onto the clearance between the piping material and inserted copper pipe for Nitrogen in order to prevent backflow of the Nitrogen gas.
- 4) When the Nitrogen gas is flowing, be sure to keep the piping end open.
- 5) Adjust the flow rate of Nitrogen gas so that it is lower than 0.05 m³/Hr or 0.02 MPa (0.2kgf/cm²) by means of the reducing valve.
- 6) After performing the steps above, keep the Nitrogen gas flowing until the pipe cools down to a certain extent (temperature at which pipes are touchable with hands).
- 7) Remove the flux completely after brazing.

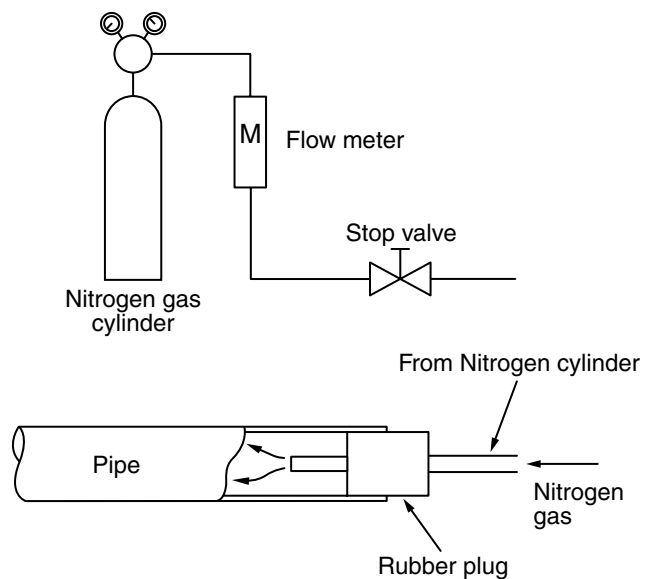

Fig. 6-5-1 Prevention of oxidation during brazing

6-6. Instructions for Re-use Piping of R22 or R407C

Instruction of Works:

The existing R22 and R407C piping can be reused for our digital inverter R410A products installations.

NOTE)

Confirmation of existence of scratch or dent of the former pipes to be applied and also confirmation of reliability of the pipe strength are conventionally referred to the local site.

If the definite conditions can be cleared, it is possible to update the existing R22 and R407C pipes to those for R410A models.

6-6-1. Basic Conditions Needed to Reuse the Existing Pipe

Check and observe three conditions of the refrigerant piping works.

1. Dry (There is no moisture inside of the pipes.)
2. Clean (There is no dust inside of the pipes.)
3. Tight (There is no refrigerant leak.)

6-6-2. Restricted Items to Use the Existing Pipes

In the following cases, the existing pipes cannot be reused as they are. Clean the existing pipes or exchange them with new pipes.

1. When a scratch or dent is heavy, be sure to use the new pipes for the works.
2. When the thickness of the existing pipe is thinner than the specified "Pipe diameter and thickness" be sure to use the new pipes for the works.
 - The operating pressure of R410A is high (1.6 times of R22 and R407C). If there is a scratch or dent on the pipe or thinner pipe is used, the pressure strength is poor and may cause break-age of the pipe at the worst.

* Pipe diameter and thickness (mm)

Pipe outer diameter		Ø6.4	Ø9.5	Ø12.7	Ø15.9	Ø19.0
Thickness	R410A	0.8	0.8	0.8	1.0	1.0
	R22 (R407C)					

- In case that the pipe diameter is Ø12.7 mm or less and the thickness is less than 0.7 mm, be sure to use the new pipes for works.
3. The pipes are left as coming out or gas leaks. (Poor refrigerant)
 - There is possibility that rain water or air including moisture enters in the pipe.
 4. Refrigerant recovery is impossible. (Refrigerant recovery by the pump-down operation on the existing air conditioner)
 - There is possibility that a large quantity of poor oil or moisture remains inside of the pipe.
 5. A dryer on the market is attached to the existing pipes.
 - There is possibility that copper green rust generated.

6. Check the oil when the existing air conditioner was removed after refrigerant had been recovered. In this case, if the oil is judged as clearly different compared with normal oil
 - The refrigerator oil is copper rust green : There is possibility that moisture is mixed with the oil and rust generates inside of the pipe.
 - There is discolored oil, a large quantity of the remains, or bad smell.
 - A large quantity of sparkle remained wear-out powder is observed in the refrigerator oil.
7. The air conditioner which compressor was exchanged due to a faulty compressor.

When the discolored oil, a large quantity of the remains, mixture of foreign matter, or a large quantity of sparkle remained wear-out powder is observed, the cause of trouble will occur.
8. Installation and removal of the air conditioner are repeated with temporary installation by lease and etc.
9. In case that type of the refrigerator oil of the existing air conditioner is other than the following oil (Mineral oil), Suniso, Freol-S, MS (Synthetic oil), alkyl benzene (HAB, Barrel-freeze), ester series, PVE only of ether series.
 - Winding-insulation of the compressor may become inferior.

NOTE)

The above descriptions are results of confirmation by our company and they are views on our air conditioners, but they do not guarantee the use of the existing pipes of the air conditioner that adopted R410A in other companies.

6-6-3. Branching Pipe for Simultaneous Operation System

- In the concurrent twin system, when TOSHIBA-specified branching pipe is used, it can be reused. Branching pipe model name: RBC-TWP30E2, RBC-TWP50E2. On the existing air conditioner for simultaneous operation system (twin system), there is a case of using branch pipe that has insufficient compressive strength. In this case please change it to the branch pipe for R410A.

6-6-4. Curing of Pipes

When removing and opening the indoor unit or outdoor unit for a long time, cure the pipes as follows:



- Otherwise rust may generate when moisture or foreign matter due to dewing enters in the pipes.
- The rust cannot be removed by cleaning, and a new piping work is necessary.

Place position	Term	Curing manner
Outdoors	1 month or more	Pinching or taping
	Less than 1 month	
Indoors	Every time	

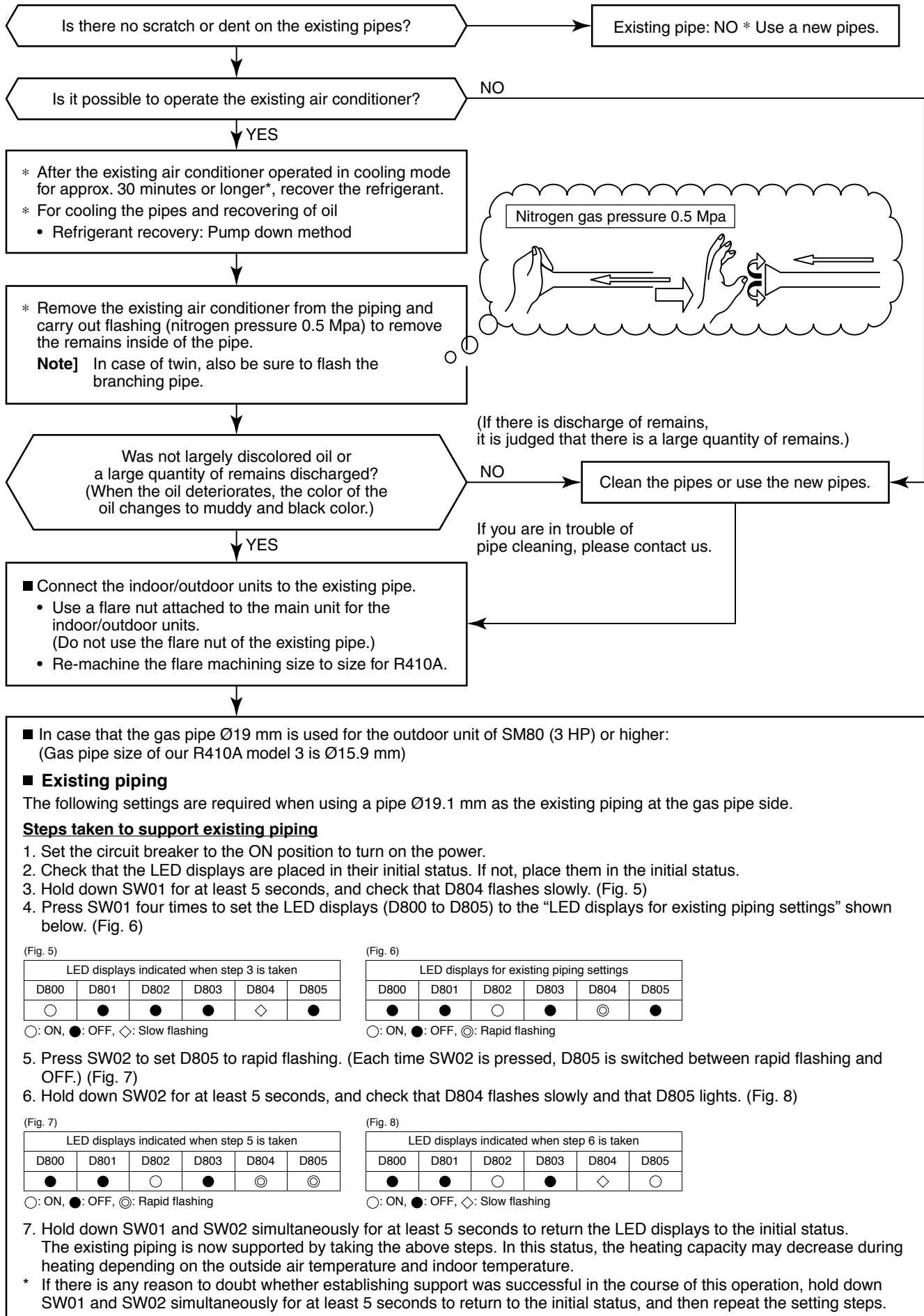
6-6-5. Final Installation Checks

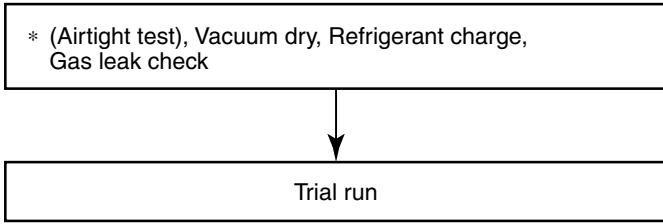

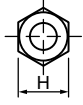

Piping necessary to change the flare nut/ machining size due to pipe compression.						
1) Flare nut width: H (mm)						
	Copper pipe outer dia.	Ø6.4	Ø9.5	Ø12.7	Ø15.9	Ø19.0
	For R410A	17	22	26	29	36
	For R22	Same as above		24	27	Same as above
2) Flare machining size: A (mm)						
	Copper pipe outer dia.	Ø6.4	Ø9.5	Ø12.7	Ø15.9	Ø19.0
	For R410A	9.1	13.2	16.6	19.7	24.0
	For R22	9.0	13.0	16.2	19.4	23.3
Becomes large a little for R410A						
Do not apply the refrigerator oil to the flare surface.						

6-6-6. Handling of Existing Pipe

When using the existing pipe, carefully check it for the following:

- Wall thickness (within the specified range)
- Scratches and dents
- Water, oil, dirt, or dust in the pipe
- Flare looseness and leakage from welds
- Deterioration of copper pipe and heat insulator

Cautions for using existing pipe

- Do not reuse the flare to prevent gas leak. Replace it with the supplied flare nut and then process it to a flare.
- Blow nitrogen gas or use an appropriate means to keep the inside of the pipe clean. If discolored oil or much residue is discharged, wash the pipe.
- Check welds, if any, on the pipe for gas leak. When the pipe corresponds to any of the following, do not use it. Install a new pipe instead.
 - The pipe has been open (disconnected from indoor unit or outdoor unit) for a long period.
 - The pipe has been connected to an outdoor unit that does not use refrigerant R22, R410A or R407C.
- The existing pipe must have a wall thickness equal to or larger than the following thickness.



Reference outside diameter (mm)	Wall thickness (mm)
Ø9.5	0.8
Ø15.9	1.0
Ø19.1	1.0

- Never use any pipe with a wall thickness less than these thicknesses due to insufficient pressure capacity.

RAV-SP804ATP*

- To use an existing Ø19.1 mm pipe, set bit 3 of SW802 (switch for existing pipe) on the P.C. board of the outdoor unit to ON.

In this case, the heating performance may be reduced depending on the outside air temperature and room temperature.

SW802	
When shipped from factory	When using existing pipe
	

6-7. Replenishing refrigerant

In order to assure the reliability of the appliance, the amount of refrigerant to be replenished shall be subject to the following restrictions. Follow the margin of excess replenished refrigerant, which is equivalent to the current R22. Otherwise, abnormally high pressure may be generated in the refrigeration cycle, which may result in failure, explosion of the product, or personal injury.

[Possible gas leakage]

Recharging refrigerant is allowed only if it is confirmed that the amount of leakage (e.g. slow leakage upon installation) is within the additional margin specified below.

The amount of leakage is not certain if the product does not function properly (e.g. insufficient cooling / heating performance). In such case, recover the refrigerant and replenish the refrigerant.

[Restrictions for the amount of additional charging]

- a. The amount of refrigerant additionally charged shall not exceed 10% of that specified. If the situation is not solved with such amount, recover the refrigerant completely and charge the specified amount.
- b. In case of slow leakage upon installation and the pipe connection length of not over 15m, further tighten the flare nut or take other effective measures. Do not recharge the refrigerant.

[Cautions for recharging with refrigerant]

- a. Use a scale with an accuracy of at least 10g to recharge the refrigerant. Do not use a bathroom scale.
- b. If the refrigerant leaks, identify the source and make sure to repair it. The refrigerant gas is not hazardous, but if it touches a heat source (e.g. fan heater, stove), a poisonous gas may be generated.
- c. Use liquid refrigerant for replenishment. Replenish the refrigerant carefully and slowly.

7. OUTDOOR CONTROL CIRCUIT

7-1. Outline of Main Controls

1. Pulse Modulating Valve (PMV) control

- 1) For PMV with SM56, 80 : 50 to 500, SM110, 140 : 30 to 500 pulses during operation, respectively.
- 2) In cooling operation, PMV is controlled with the temperature difference between TS sensor and TC sensor.
- 3) In heating operation, PMV is controlled with the temperature difference between TS sensor and TE sensor.
- 4) For the temperature difference in items 2) and 3), -1 to 5K is aimed as the target in both cooling and heating operations.
- 5) When the cycle excessively rose in both cooling and heating operations, PMV is controlled by TD sensor.
The aimed value is usually SM56, 80 : 100°C, SM110, 140 : 91°C in both cooling and heating operations.

REQUIREMENT

A sensor trouble may cause a liquid back-flow or abnormal overheat resulting in excessive shortening of the compressor life. In a case of trouble on the compressor, be sure to check there is no error in the resistance value an the refrigerating cycle of each sensor after repair and then start the operation.

2. Discharge temperature release control

- 1) When the discharge temperature did not fall or the discharge temperature rapidly went up by PMV control, this control lowers the compressor frequency. It subdivides the frequency control up to 0.6Hz to stabilize the cycle.
- 2) When the discharge temperature detected an abnormal stop zone, the compressor stops and then restarts after 2 minutes 30 seconds.
The error counting is cleared when the operation continued for 10 minutes. If the error is detected by 4 times without clearing, the error is determined and restarting is not performed.
* The cause is considered as excessively little amount of refrigerant, PMV error or clogging of the cycle.
- 3) For displayed contents of error, confirm on the check code list.

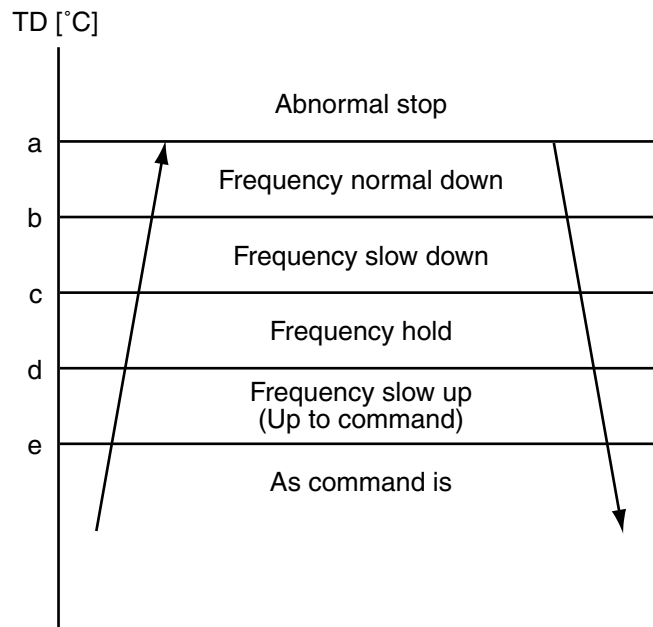

	a	b	c	d	e
SM56, 80	117	115	103	100	93
SM110, 140	111	109	106	103	96

3. Current release control

The output frequency and the output voltage are controlled by AC current value detected by current transformer on the outdoor P.C. board so that input current of the inverter does not exceed the specified value.

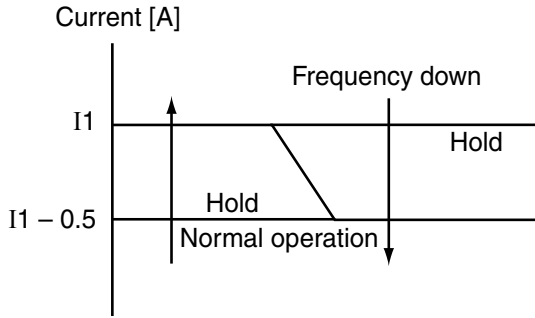

Model	SM56		SM80	
	COOL	HEAT	COOL	HEAT
I1 value [A]	10.1	12.0	14.5	14.0
Model	SM110		SM140	
	COOL	HEAT	COOL	HEAT
I1 value [A]	21.2	21.2	21.2	21.2

4. Outdoor fan control

Allocations of fan tap revolutions [rpm]

Model	W1	W2	W3	W4	W5	W6	W7	W8	W9	WA	WB	WC	WD	WE	WF
SM56	200	300	350	410	480	500	530	560	640	670	700	750	800	840	950
SM80	200	300	350	410	480	500	530	560	640	670	700	750	840	980	1050
SM110	200	210	250	320	390	460	530	600	660	730	770	850	870	900	900
SM140	200	210	250	320	390	460	530	600	660	730	770	850	870	900	900

4-1. Cooling fan control

- 1) An outdoor fan is controlled by TL sensor, TO sensor and compressor frequency. An outdoor fan is controlled at 1-tap interval of DC fan control.
- 2) At the start time, the fan is fixed for 60 seconds only with the maximum fan tap corresponded to the zone in the following table but it is controlled with TL sensor temperature after then.

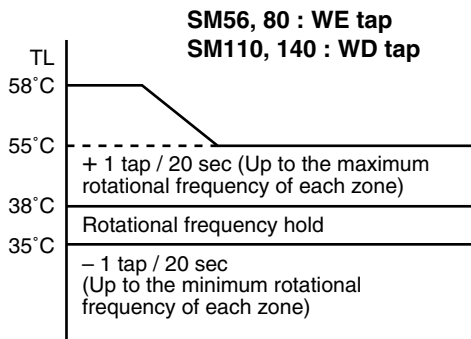

Temp. range	SM56	34.2 Hz or lower		34.2Hz to 58.8Hz		58.8Hz or higher	
	SM80	Min.	Max.	Min.	Max.	Min.	Max.
38°C ≤ TO		W6	WB	W8	WE	WA	WE
29°C ≤ TO < 38°C		W5	WA	W7	WE	W9	WE
15°C ≤ TO < 29°C		W3	W7	W5	W9	W7	WB
5°C ≤ TO < 15°C		W2	W5	W4	W7	W6	W9
0°C ≤ TO < 5°C		W1	W3	W3	W5	W4	W7
-4°C ≤ TO < 0°C		W1	W2	W2	W4	W3	W5
TO < -4°C		OFF	OFF	OFF	W3	W1	W4
TO error		OFF	WB	OFF	WE	W1	WE

Temp. range	SM110	34.2 Hz or lower		34.2Hz to 52.2Hz		52.2Hz or higher	
	SM140	Min.	Max.	Min.	Max.	Min.	Max.
38°C ≤ TO		W6	WD	W8	WD	WA	WD
29°C ≤ TO < 38°C		W5	WC	W7	WC	W9	WD
15°C ≤ TO < 29°C		W3	W7	W5	W9	W7	WB
5°C ≤ TO < 15°C		W2	W5	W4	W7	W6	W9
0°C ≤ TO < 5°C		W1	W3	W3	W5	W4	W7
-4°C ≤ TO < 0°C		W1	W2	W2	W4	W3	W5
TO < -4°C		OFF	W2	OFF	W4	OFF	W4
TO error		OFF	WD	OFF	WD	OFF	WD

4-2. Heating fan control

- 1) An outdoor fan is controlled by TE sensor, TO sensor and compressor frequency. (It is controlled with W1 for minimum and the maximum is controlled according to the following table.)
- 2) At the start time, the fan is fixed for 3 minutes only with the maximum fan tap corresponded to the zone in the following table but it is controlled with TE sensor temperature after then.
- 3) When a status $TE \geq 24^{\circ}\text{C}$ continues for 5 minutes, the operation stops. In this case, no error display appears and the status is same as the normal thermo-OFF. The can restarts after approx. 2 minutes 30 seconds and this continuous operation is not an error.
- 4) When the above status as 3) occurs frequently, it is considered that filter of the suction part of the indoor unit is dirty. Clean the filter and restart the operation.

TE	- 2 tap / 20 seconds (up to W1) Stop timer count
24°C	- 2 tap / 20 seconds (up to W1)
21°C	- 1 tap / 20 seconds (up to W1)
18°C	Rotational frequency hold
15°C	+ 1 tap / 20 seconds (up to Max. tap of each zone)

Temp. range	SM56	39.0 Hz or lower	39.0Hz to 67.8Hz	67.8Hz or higher
		Max.	Max.	Max.
$10^{\circ}\text{C} \leq \text{TO}$		W7	W8	W9
$5^{\circ}\text{C} \leq \text{TO} < 10^{\circ}\text{C}$		W9	WB	WE
$-3^{\circ}\text{C} \leq \text{TO} < 5^{\circ}\text{C}$		WE	WE	WF
$-10^{\circ}\text{C} \leq \text{TO} < -3^{\circ}\text{C}$		WF	WF	WF
$\text{TO} < -10^{\circ}\text{C}$		WF	WF	WF
TO error		WF	WF	WF

Temp. range	SM80	49.8 Hz or lower	49.8Hz to 88.8Hz	88.8Hz or higher
		Max.	Max.	Max.
$10^{\circ}\text{C} \leq \text{TO}$		W7	W8	W9
$5^{\circ}\text{C} \leq \text{TO} < 10^{\circ}\text{C}$		W9	WB	WF
$-3^{\circ}\text{C} \leq \text{TO} < 5^{\circ}\text{C}$		WF	WF	WF
$-10^{\circ}\text{C} \leq \text{TO} < -3^{\circ}\text{C}$		WF	WF	WF
$\text{TO} < -10^{\circ}\text{C}$		WF	WF	WF
TO error		WF	WF	WF

Temp. range	SM110 SM140	20.4 Hz or lower	20.4Hz to 45.0Hz	45.0Hz or higher
		Max.	Max.	Max.
$10^{\circ}\text{C} \leq \text{TO}$		W7	W8	W9
$5^{\circ}\text{C} \leq \text{TO} < 10^{\circ}\text{C}$		W9	WB	WE
$-3^{\circ}\text{C} \leq \text{TO} < 5^{\circ}\text{C}$		WE	WE	WE
$-10^{\circ}\text{C} \leq \text{TO} < -3^{\circ}\text{C}$		WE	WE	WE
$\text{TO} < -10^{\circ}\text{C}$		WE	WE	WE
TO error		WE	WE	WE

5. Coil heating control

- 1) This control function heats the compressor by turning on the stopped compressor instead of a case heater. It purposes to prevent stagnation of the refrigerant inside of the compressor.
- 2) As usual, turn on power of the compressor for the specified time before a test run after installation; otherwise a trouble of the compressor may be caused.
As same as a test run, it is recommended to turn on power of the compressor beforehand when starting operation after power of the compressor has been interrupted and left as it is for a long time.
- 3) A judgment for electricity is performed by TD and TO sensors.
If TO sensor is defective, a backup control is automatically performed by TE sensor.
For a case of defective TO sensor, judge it with outdoor LED display.
- 4) For every model, the power is turned off when TD is 30°C or more.

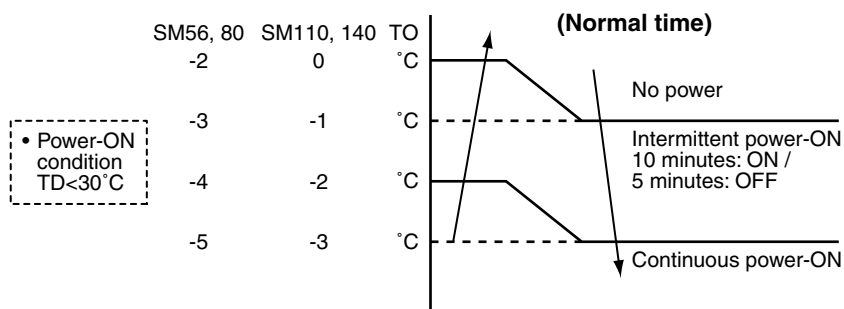

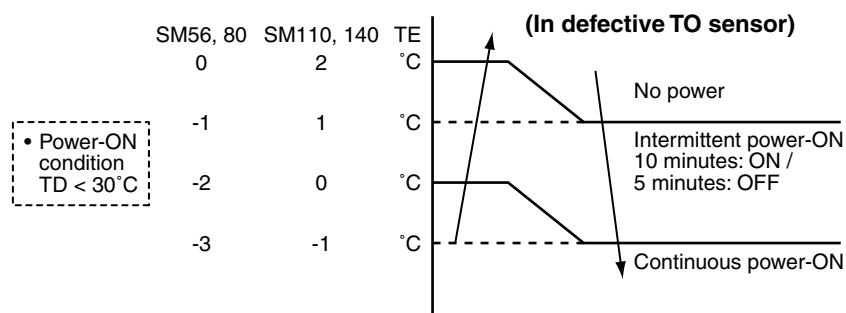

	SM56, 80	SM110, 140
Output power	20W	50W

REQUIREMENT

While heating the coil, the power sound may be heard. However it is not a trouble.

6. Short intermittent operation preventive control

- 1) For 3 to 10 minutes after operation start, in some cases, the compressor does not stop to protect the compressor even if receiving the thermostat-OFF signal from indoor. However it is not abnormal status. (The operation continuance differs according to the operation status.)
- 2) When the operation stops by the remote controller, the operation does not continue.

7. Current release value shift control

- 1) This control purposes to prevent troubles of the electronic parts such as the compressor driving elements and the compressor during cooling operation.
- 2) The current release control value (I1) is selected from the following table according to TO sensor value.

Current release control value (I1)

[A]

Temperature range	SM56	SM80	SM110	SM140
47°C ≤ TO	4.7	7.1	15.8	15.8
44°C ≤ TO < 47°C	4.7	9.9	17.4	17.4
39°C ≤ TO < 44°C	6.2	11.3	18.3	18.3
TO error	4.7	7.1	15.8	15.8

8. Over-current protective control

- 1) When the over-current protective circuit detected an abnormal current, stop the compressor.
- 2) The compressor restarts after 2 minutes 30 seconds setting [1] as an error count.
- 3) When the error count [8] was found, determine an error and restart operation is not performed.
- 4) For the error display contents, confirm on the check code list.

9. High-pressure release control

- 1) The operation frequency is controlled to restrain abnormal rising of high pressure by TL sensor in cooling operation and TC sensor in heating operation.
- 2) When TL sensor in cooling operation or TC sensor in heating operation detects abnormal temperature of the stop zone, stop the compressor and the error count becomes +1.
- 3) When the compressor stopped with 2), the operation restarts from the point of the normal operation zone (e point or lower) where it returned after 2 minutes 30 seconds.
- 4) The error count when the compressor stopped with 2) is cleared after the operation continued for 10 minutes.
If the error count becomes [10] without clearing, the error is determined and reactivation is not performed.
- 5) For the error display contents, confirm on the check code list.

HEAT TC / COOL TL
[°C]

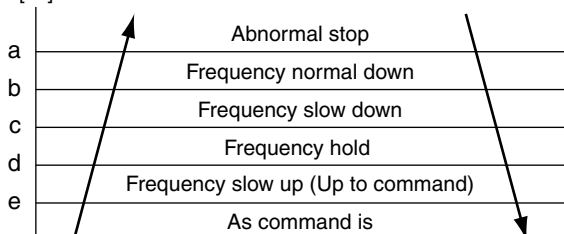

[°C]

	SM56, 80		SM110, 140	
	HEAT	COOL	HEAT	COOL
	TC	TL	TC	TL
a	62°C	63°C	62°C	63°C
b	57°C	63°C	57°C	62°C
c	55°C	61°C	55°C	60°C
d	53°C	59°C	53°C	58°C
e	49°C	55°C	49°C	54°C

10. Defrost control

- ① In heating operation, defrost operation is performed when TE sensor temperature satisfies any condition in A zone to D zone.
- ② The defrost operation is immediately finished if TE sensor temperature has become 12°C continuing for 3 seconds or more, or it also is finished when condition of 7°C < TE < 12°C has continued for 1 minute. The defrost operation is also finished when defrost operation has continued for 10 minutes even if TE sensor temperature has become 7°C or lower.
- ③ After defrost operation has finished, the compressor and the outdoor fan start heating operation after stopped for approx. 40 seconds.

Start of heating operation

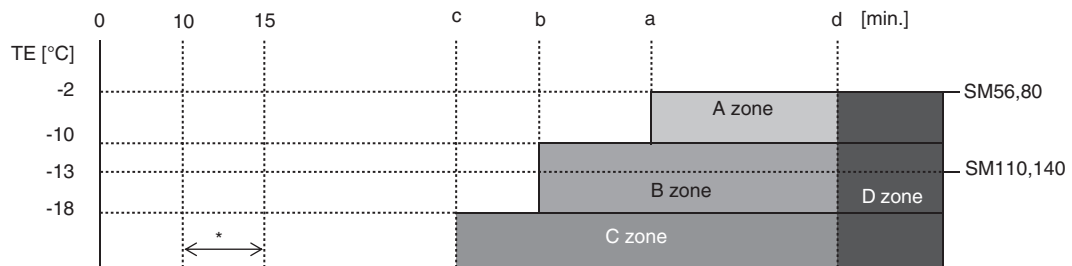

* From 10 minutes to 15 minutes after a heating operation started, the minimum value of TE is stored in memory as TEO and the minimum temperature of TO as ToO.

	At normal TO	At error TO
A zone	When status of $[(TEO - TE) - (ToO - TO) \geq 3^{\circ}C]$ continued for 20 seconds	When status of $[(TEO - TE) \geq 3^{\circ}C]$ continued for 20 seconds
B zone	When status of $[(TEO - TE) - (ToO - TO) \geq 2^{\circ}C]$ continued for 20 seconds	When status of $[(TEO - TE) \geq 2^{\circ}C]$ continued for 20 seconds
C zone	When status of [SM56, 80 : $TE \leq -25^{\circ}C$, SM110,140 : $TE \leq -18^{\circ}C$] continued for 20 seconds	
D zone	When compressor operation status with SM56, 80 : $TE < -13^{\circ}C$, SM110,140 : $TE < -2^{\circ}C$ are added by d times	

	SM56, 80	SM110, 140
a	41	55
b	29	45
c	29	39
d	90	150

11. High-pressure switch

- 1) When the high-pressure switch operates, the operation of the compressor is terminated.
- 2) The compressor restarts after 5 minutes using [1] as an error count. After restart, the error count is cleared when operation continues for 10 minutes or more.
- 3) An error is confirmed with the error count [10].
- 4) For the indicated contents of error, confirm using the check code table.

12. Control of compressor case thermo

- 1) The compressor stops when the case thermo of the compressor operated.
- 2) When the case thermo operated for approx. 80 seconds, H04 error code is displayed on the wired remote controller. → Refer to the Check Code.
- 3) When the case thermo is reset, the operation restarts.

7-2. Outdoor Print Circuit Board

RAV-SM564AT*P*, SM804AT*P*

<MCC-1645>

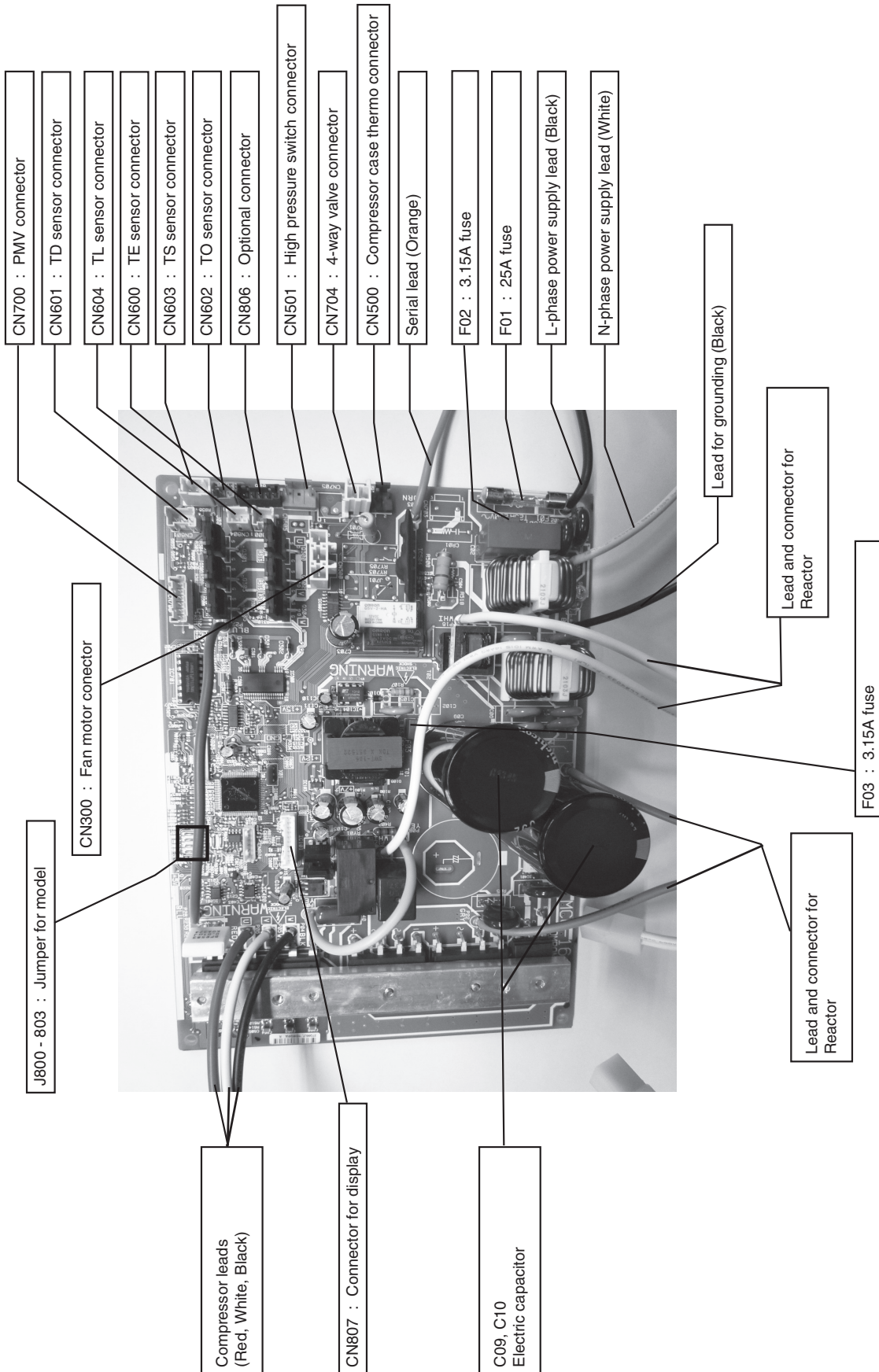

RAV-SM1104AT*P*, SM1404AT*P*
 <MCC-1648>

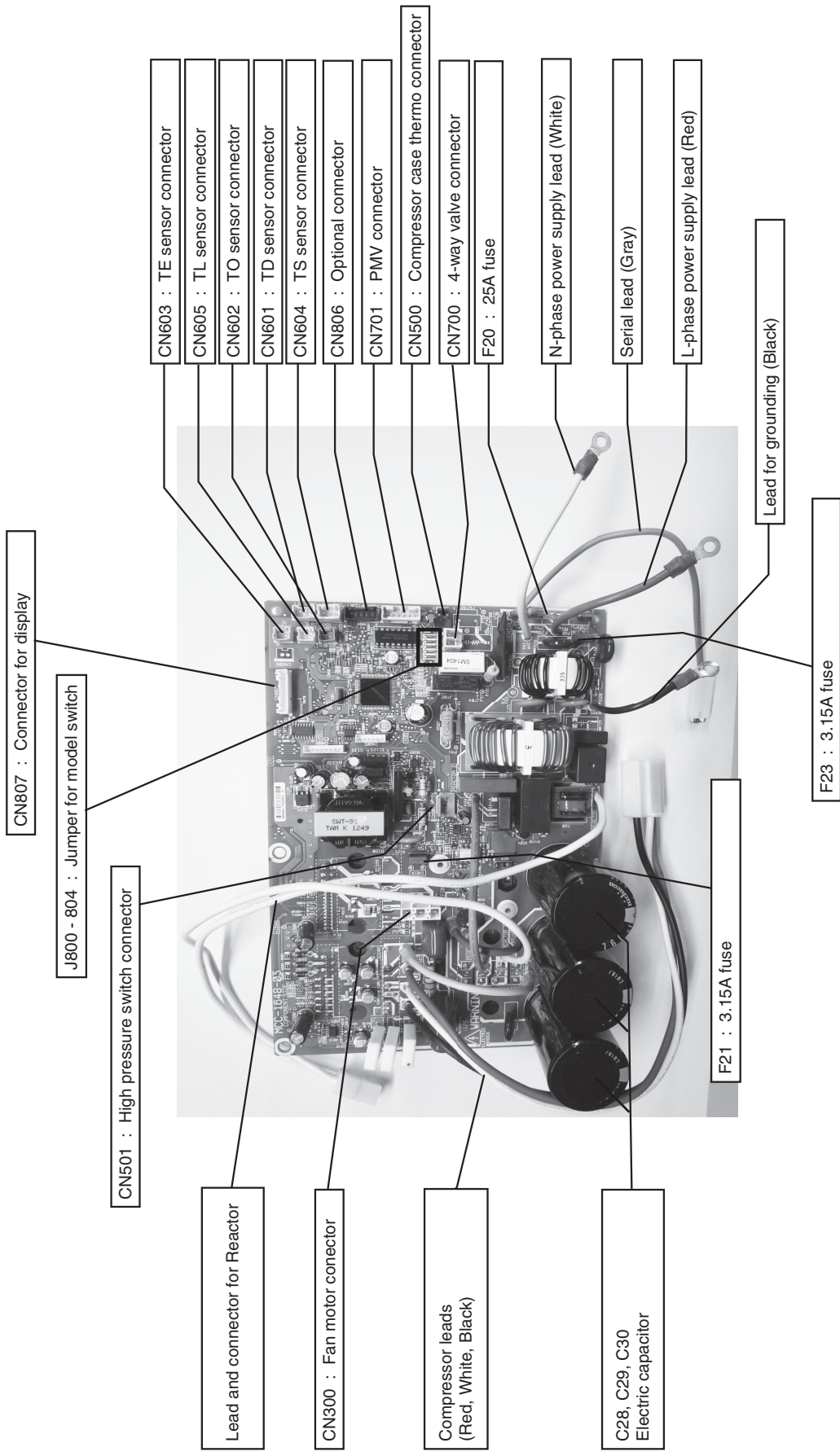

8. TROUBLESHOOTING

8-1. Summary of Troubleshooting

<Wired remote controller type>

1. Before troubleshooting

- 1) Required tools/instruments
 - ⊕ and ⊖ screwdrivers, spanners, radio cutting pliers, nippers, push pins for reset switch
 - Tester, thermometer, pressure gauge, etc.
- 2) Confirmation the following points before check
 - a) The following operations are normal.
 1. Compressor does not operate.
 - When 3-minutes delay (3 minutes after compressor OFF)
 - When the outdoor unit is in standby mode due to the room temperature reached the setup temperature
 - When the timer is operating
 - When indoor fan only operation mode
 - When an overflow error is detected in the indoor unit
 - When outside high-temperature operation controlled is in heating operation
 - When Thermo-OFF setting by Application Control Kit (TCB-PCOS1E2)
 2. Indoor fan does not rotate.
 - When cool air discharge prevention control is working in heating operation
 3. Outdoor fan does not rotate or air volume changes.
 - When high-temperature release operation control is working in heating operation
 - When outside low-temperature operation control is working in cooling operation
 - When defrost operation is being performed
 4. ON/OFF operation cannot be performed from remote controller.
 - When the control operation is being performed from outside/remote side
 - When automatic address is being set up
(When the power is turned on at the first time or when indoor unit address setting is changed, the operation will be performed after power-ON in 5 minutes or before.)
 - When the test run is being performed by operation of the outdoor controller
 - b) Did you return the cabling to the initial positions?
 - c) Are indoor unit and remote controller connected correctly?

2. Troubleshooting procedure

When a trouble occurred, check the parts along with the following procedure.



NOTE

Microcomputer misdiagnosis may also be caused by power condition problem and outer noise other than the checked items. If there is any noise source, change the cables of the remote controller to shield cables.

<Wireless remote controller type>**1. Before troubleshooting**

- 1) Required tools/instruments
 - ⊕ and ⊖ screwdrivers, spanners, radio cutting pliers, nippers, etc.
 - Tester, thermometer, pressure gauge, etc.
- 2) Confirmation the following points before check
 - a) The following operations are normal.
 1. Compressor does not operate.
 - When 3-minutes delay (3 minutes after compressor OFF)
 - When the outdoor unit in standby status due to the room temperature reached the setup temperature
 - When the timer is operating
 - When indoor fan only operation mode
 - When an overflow error is detected on the indoor unit
 - When outside high-temperature operation controlled is in heating operation
 - When Thermo-OFF setting by Application Control Kit (TCB-PCOS1E2)
 2. Indoor fan does not rotate.
 - Does not cool air discharge preventive control work in heating operation?
 3. Outdoor fan does not rotate or air volume changes.
 - When high-temperature release operation control is working in heating operation
 - When outside low-temperature operation control is working in cooling operation
 - When defrost operation is being performed
 4. ON/OFF operation cannot be performed from remote controller.
 - When forced operation is being performed
 - When the control operation is being performed from outside/remote side
 - When automatic address being set up
 - When the test run is being performed by operation of the outdoor controller
 - b) Did you return the cabling to the initial positions?
 - c) Are connecting cables between indoor unit and receiving unit correct?

2. Troubleshooting procedure

(When the power is turned on at the first time or when indoor unit address setting is changed, the operation will be performed after power-ON in 5 minutes or before.)

When a trouble occurred, check the parts along with the following procedure.



1) Outline of judgment

The primary judgment to check where a trouble occurred in indoor unit or outdoor unit is performed with the following method.

The errors can be identified by lamp indication of indoor unit (sensors of the receiving unit)

The indoor unit monitors operating status of the air conditioner, and the blocked contents of self-diagnosis are displayed restricted to the following cases if a protective circuit works.

8-2. Troubleshooting

8-2-1. Outline of judgment

The following method can be done to check whether the problem occurred in indoor or outdoor unit.

The error is indicated by indication lamp on the display of the indoor unit. (sensors of the receiving part)

The indoor unit monitors the operating status of the air conditioner, and the blocked contents of self-diagnosis are displayed restricted to the following cases if a protective circuit works.

● : OFF, ○ : ON, ◐ : Flash (0.5 sec.)

Lamp indication	Check code	Cause of trouble	
Operation Timer Ready ● ● ● No indication at all	—	Power supply OFF or miswiring between receiving unit and indoor unit	
Operation Timer Ready ◐ ● ● Flash	E01	Receiving error } Receiving unit } Sending error } Miswiring or wire connection error Communication stop } between receiving unit and indoor unit	
	E02		
	E03		
	Operation Timer Ready ◐ ● ● Flash	E08	Duplicated indoor unit No. Setup error
		E09	Duplicated header units of remote controller
		E10	Communication error between CPUs on indoor unit P.C. board
		E11	Communication error between Application control kit and indoor unit P.C. board
Operation Timer Ready ● ● ◐ Flash	E18	Wire connection error between indoor units, Indoor power OFF (Communication stop between indoor master and follower or between main and sub indoor twin)	
	E04	Miswiring between indoor unit and outdoor unit or connection error (Communication stop between indoor and outdoor units)	
Operation Timer Ready ● ◐ ◐ Alternate flash	P10	Overflow was detected. } Protective device of indoor unit worked. Indoor DC fan error }	
	P12		
Operation Timer Ready ◐ ● ◐ Alternate flash	P03	Outdoor unit discharge temp. sensor error } Case thermostat operation, High pressure protective operation, High pressure SW system error, Power supply error, } Protective device of Power supply error } outdoor unit Heat sink overheat error } worked. Gas leak detection }	
	P04		
	P05		
	P07		
	P15		
	P19	4-way valve inverse error (Indoor or outdoor unit detected)	
	Operation Timer Ready ◐ ● ◐ Alternate flash	P20	High pressure protective operation } Outdoor unit fan system error } Protective device of outdoor unit Short-circuit of compressor drive element } worked. Position detection circuit error }
		P22	
		P26	
P29			
Operation Timer Ready ◐ ● ◐ Alternate flash	P31	Stopped because of error of other indoor units in a group (Check codes of E03/L03/L07/L08)	

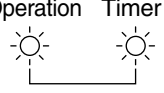
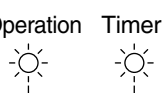
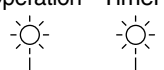
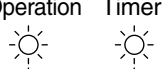
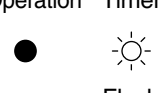
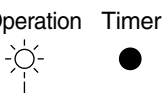
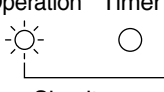
Lamp indication	Check code	Cause of trouble occurrence
Operation Timer Ready  Alternate flash	F01	Heat exchanger sensor (TCJ) error } Indoor unit sensor error Heat exchanger sensor (TC) error } Heat exchanger sensor (TA) error }
	F02	
	F10	
Operation Timer Ready  Alternate flash	F04	Discharge temp. sensor (TD) error } Sensor error of outdoor unit Temp. sensor (TE, TS, TL) error } Heat exchanger temp. sensor (TL) error } Outside air temp. sensor (TO) error } Suction temp. sensor (TS) error } Heat sink temp. sensor (TH) error } Miss-mounting of temp. sensor (TE, TS) }
	F06	
	F07	
	F08	
	F12	
	F13	
	F15	
Operation Timer Ready  Simultaneous flash	F29	Indoor EEPROM error
Operation Timer Ready  Simultaneous flash	F31	Outdoor EEPROM error
Operation Timer Ready  Flash	H01	Compressor break down } Outdoor compressor system error Compressor lock } Outdoor unit current detection circuit error }
	H02	
	H03	
	H04	Case thermostat operation
Operation Timer Ready  Simultaneous flash	L03	Duplicated header indoor units } → AUTO address There is indoor unit of group connection } in individual indoor unit. } * If group construction and address are not normal power supply turned on, automatically goes to address setup mode. Unsetting of group address } Missed setting } (Unset indoor capacity) }
	L07	
	L08	
	L09	
Operation Timer Ready  Simultaneous flash	L10	Outdoor unit unset model type of service P.C. board
	L20	Duplicated indoor central addresses
	L29	Outdoor P.C. board part error was detected (EEPROM error, Heat sink temp. sensor (TH) error) Outdoor unit unset model type of service P.C. board. Outdoor Heat sink overheat error, Gas leak detection, or 4-way valve system error.
	L30	Outside interlock error

8-2-2. Others (Other than Check Code)

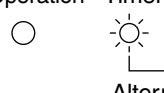
Lamp indication	Check code	Cause of trouble occurrence
Operation Timer Ready  Simultaneous flash	—	During test run
Operation Timer Ready  Alternate flash	—	Disagreement of cool/heat (Automatic cool/heat setting to automatic cool/heat prohibited model, or setting of heating to cooling-only model)

8-2-3. Monitor Function of Remote Controller Switch

■ Calling of sensor temperature display

<Contents>

Each data of the remote controller, indoor unit and outdoor unit can be shown by calling the service monitor mode from the remote controller.

<Procedure>

- 1 Push  +  buttons simultaneously for 4 seconds to call the service monitor mode.**

The service monitor shows up, the master indoor unit No. is displayed at first and then the temperature CODE No.  is displayed.



- 2 Push temperature set   buttons and then change the CODE No. of data to be monitored.**

The CODE No. list is shown below.

<RBC-AMT32E>

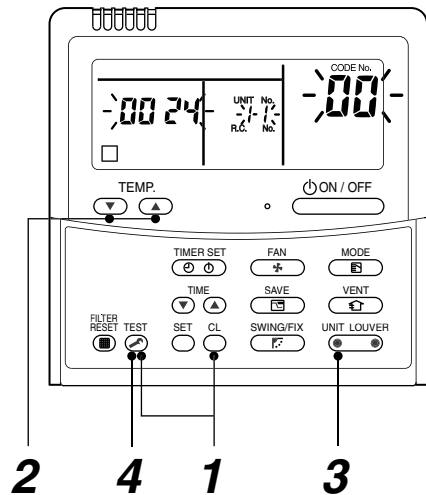

<Operation procedure>

1 → 2 → 3 → 4

↑
Returned to usual display

	CODE No.	Data name	Unit
Indoor unit data	01	Room temperature (Remote controller)	°C
	02	Indoor suction temperature (TA)	°C
	03	Indoor heat exchanger (Coil) temperature (TCJ)	°C
	04	Indoor heat exchanger (Coil) temperature (TC)	°C
	* 07	Indoor fan revolution frequency	rpm
	* F2	Indoor fan calculated operation time	×100h
	F3	Filter sign time	×1h
	* F8	Indoor discharge temperature*1 (4-way only)	°C

	CODE No.	Data name	Unit
Outdoor unit data	60	Outdoor heat exchanger (Coil) temperature (TE)	°C
	61	Outside temperature (TO)	°C
	62	Compressor discharge temperature (TD)	°C
	63	Compressor suction temperature (TS)	°C
	65	Heat sink temperature (TH)	°C
	6A	Operation current (× 1/10)	A
	* 6D	Outdoor heat exchanger (Coil) temperature (TL)	°C
	* 70	Compressor operation frequency	rps
	* 72	Outdoor fan revolution frequency (Lower)	rpm
	* 73	Outdoor fan revolution frequency (Upper)	rpm
	F1	Compressor calculated operation time	×100h

- The CODE No. with * marks in the above table are displayed only on the indoor units of 4 series models and later. (4 series indoor units mean RAV-SM1404UT-E for example.)
- The indoor discharge temperature of CODE No. [F8] is the estimated value from TC or TCJ sensor. Use this value to check discharge temperature at test run. (A discharge temperature sensor is not provided to this model.)
- The data value of each item is not the real time, but value delayed by a few seconds to ten-odd seconds.



- 3 Push  button to select the indoor unit to be monitored. Each data of the indoor unit and its outdoor units can be monitored.**



- 4 Pushing  button to returns to the usual display.**

8-2-4. Check Code List (Outdoor)

○ : ON, ⊙ : Flash, ● : OFF
 ALT (Alternate): Alternate flashing when there are two flashing LED/SIM (Simultaneous): Simultaneous flashing when there are two flashing LED

Central Control indication	Remote Controller indication	Sensor lamp part		Defected position	Detection	Explanation of error contents	Automatic Reset	Operation continuation
		Block indication	Flash					
19	F04	⊙	○	Outdoor unit Discharge temp. sensor (TD) error	Outdoor	Disconnection, short of discharge temp. sensor (TD) was detected	X	X
18	F06	⊙	○	Outdoor unit heat exchanger temp. sensor (TE) error	Outdoor	Disconnection, short of outdoor unit heat exchanger temp. sensor (TE) was detected.	X	X
18	F07	⊙	○	Outdoor unit Heat exchanger t temp. sensor (TL) error	Outdoor	Disconnection, short of outside heat exchanger temp. Sensor (TL) was detected.	X	X
1b	F08	⊙	○	Outdoor unit Outside air temp. sensor (TO) error	Outdoor	Disconnection, short of outside air temp. Sensor (TO) was detected.	○	○
A2	F12	⊙	○	Outdoor unit Suction temp. sensor (TS) error	Outdoor	Disconnection, short of suction temp. Sensor (TS) was detected.	X	X
43	F13	⊙	○	Outdoor unit Heat sink temp. sensor (TH) error	Outdoor	Disconnection, short of heat sink temp. Sensor (TH) (P.C. board installed) was detected.	X	X
18	F15	⊙	○	Outdoor unit Miss-mounting of temp. sensor (TE, TS)	Outdoor	Miss-mounting of outdoor heat exchanger temp. sensor (TE) and suction temp. sensor(TS) was detected.	X	X
1F	H01	●	●	Outdoor unit Compressor break down	Outdoor	Reached release point at min-Hz during compressor operating.	X	X
1d	H02	●	●	Outdoor unit Compressor lock	Outdoor	Compressor lock was detected.	X	X
17	H03	●	●	Outdoor unit Current detection circuit error	Outdoor	Current detection circuit error.	X	X
44	H04	●	●	Outdoor unit case thermostat operated	Outdoor	Case thermostat operated.	X	X
88	L10	⊙	○	Outdoor unit Unset model type of service P.C. board	Outdoor	When outdoor service P.C. board was used, model type select jumper setting was inappropriate.	X	X
1C	L29	⊙	○	Outdoor unit error	Outdoor	1) Outdoor P.C. board part error was detected (EEPROM error, Heat sink temp. sensor (TH) error) 2) Outdoor unit Unset model type of service P.C. board. 3) Outdoor Heat sink overheat error, Gas leak detection, or 4-way valve system error.	X	X
1E	P03	⊙	○	Outdoor unit Discharge temp. error	Outdoor	Error was detected by discharge temp. release control.	X	X
21	P04	⊙	○	Outdoor unit High pressure SW system error	Outdoor	High pressure protection switch operated.	X	X
AF	P05	⊙	○	Power supply error	Outdoor	Power supply voltage error.	X	X
1C	P07	⊙	○	Outdoor unit Heat sink overheat error	Outdoor	Abnormal overheat was detected by outdoor heat sink temp. sensor (TH).	X	X
AE	P15	⊙	○	Gas leak detection	Outdoor	Abnormal overheat of discharge temp. sensor (TD) or suction temp. sensor (TS) was detected.	X	X
22	P20	⊙	○	Outdoor High pressure protective operation	Outdoor	Error was detected by high pressure release control from indoor / outdoor heat exchanger temp. sensor.	X	X
1A	P22	⊙	○	Outdoor unit Outdoor fan system error	Outdoor	Error (Over-current, lock, etc.) was detected on outdoor fan drive circuit.	X	X
14	P26	⊙	○	Outdoor unit Short-circuit of compressor drive element	Outdoor	Short-circuited protective operation of compressor drive circuit element (G-Tr / IGBT) operated.	X	X
16	P29	⊙	○	Outdoor unit Position detection circuit error	Outdoor	Position detection error of compressor motor was detected.	X	X
97	E01	⊙	●	No remote controller master unit	Remote controller	Signal was not received from indoor unit.	-	-
-	E02	⊙	●	Remote controller communication error	Remote controller	Main remote controller was not set. (including 2 remote controllers)	-	-
97	E03	⊙	●	Regular communication error between indoor and remote controller	Indoor	Signal cannot be sent to indoor unit.	○	X
04	E04	●	○	Indoor/Outdoor serial error	Indoor	Serial communication error between indoor and outdoor	○	X
96	E08	⊙	●	Duplicated indoor addresses	Indoor	Same address as yours was detected.	○	X
99	E09	⊙	●	Duplicated main remote controllers	Remote controller	In 2-remote controller control, both were set as master.	X	X
CF	E10	⊙	●	Communication error between CPU	Indoor	MCU communication error between main motor and micro computer	○	△

Central Control indication	Remote Controller Indication	Sensor lamp part		Defected position	Detection	Explanation of error contents	Automatic Reset	Operation continuation
		Block indication	Flash					
4B	E11	○ ● ● ●	○	Communication error between Application control kit and indoor unit	Indoor	Communication error between Application control kit and indoor unit P.C. board	○	X
97,99	E18	○ ● ● ●	○	Regular communication error between master and follower indoor units	Indoor	Regular communication cannot be performed between master and follower indoor units. Communication between twin master (Main unit) and follower (sub unit) cannot be performed.	○	X
96	L03	○ ● ● ●	○	Duplicated indoor master units	Indoor	There are multiple master units in a group.	X	X
99	L07	○ ● ● ●	○	There is group cable in individual indoor unit.	Indoor	When even one group connection indoor unit exists in individual indoor unit	X	X
99	L08	○ ● ● ●	○	Unset indoor group address	Indoor	Indoor address group was unset.	X	X
46	L09	○ ● ● ●	○	Unset indoor capacity	Indoor	Capacity of indoor unit was unset.	X	X
66	L30	○ ○ ○ ○	○	Outside error input to indoor unit (Interlock)	Indoor	Abnormal stop by CN80 outside error input	X	X
08	P19	○ ● ● ●	○	4-way valve inverse error	Indoor Outdoor	In heating operation, error was detected by temp. down of indoor heat exchanger or temp. up of TE, TS.	○	X

◇ When this warning was detected before group construction/address check finish at power supply was turned on, the mode shifts automatically to AUTO address setup mode.

Error mode detected by indoor unit

Operation of diagnostic function				Judgment and measures
Check code	Cause of errors	Status of air conditioner	Condition	
E03	No communication from remote controller (including wireless) and communication adapter	Stop (Automatically reset)	Displayed when error is detected	1. Check cables of remote controller and communication adapters. • Remote controller LCD display OFF (Disconnection) • Central remote controller [97] check code
E04	The serial signal is not output from outdoor unit to indoor unit. • Miswiring of inter-unit wire • Defective serial sending circuit on outdoor P.C. board • Defective serial receiving circuit on indoor P.C. board	Stop (Automatically reset)	Displayed when error is detected	1. Outdoor unit does not completely operate. • Inter-unit wire check, correction of miswiring • Check outdoor P.C. board. Correct wiring of P.C. board. 2. When outdoor unit normally operates Check P.C. board (Indoor receiving / Outdoor sending).
E08	Duplicated indoor unit address	Stop	Displayed when error is detected	1. Check whether remote controller connection (Group/Individual) was changed or not after power supply turned on (Finish of group construction/Address check). * If group construction and address are not normal when the power has been turned on, the mode automatically shifts to address setup mode. (Resetting of address)
L03	Duplicated indoor master unit			
L07	There is group wire in individual indoor unit.			
L08	Unset indoor group address			
L09	Unset indoor capacity	Stop	Displayed when error is detected	1. Set indoor capacity (CODE No. (DN) = 11)
L30	Abnormal input of outside interlock	Stop	Displayed when error is detected	1. Check outside devices. 2. Check indoor P.C. board.
P10	Float switch operation • Float circuit, Disconnection, Coming-off, Float switch contact error	Stop	Displayed when error is detected	1. Trouble of drain pump 2. Clogging of drain pump 3. Check float switch. 4. Check indoor P.C. board. 5. Check Application control kit of indoor unit
P12	Indoor DC fan error	Stop	Displayed when error is detected	1. Position detection error 2. Over-current protective circuit of indoor fan driving unit operated. 3. Indoor fan locked. 4. Check indoor P.C. board.
P19	4-way valve system error • After heating operation has started, indoor heat exchangers temp. is down.	Stop (Automatically reset)	Displayed when error is detected	1. Check 4-way valve. 2. Check PMV 3. Check indoor heat exchanger (TC/TCJ). 4. Check indoor P.C. board.
P31	Own unit stops while warning is output to other indoor units.	Stop (Follower unit) (Automatically reset)	Displayed when error is detected	1. Judge follower unit while header unit is [E03], [L03], [L07] or [L08]. 2. Check indoor P.C. board.
F01	Coming-off, disconnection or short of indoor heat exchanger temp. sensor (TCJ)	Stop (Automatically reset)	Displayed when error is detected	1. Check indoor heat exchanger temp. sensor (TCJ). 2. Check indoor P.C. board.
F02	Coming-off, disconnection or short of indoor heat exchanger temp. sensor (TC)	Stop (Automatically reset)	Displayed when error is detected	1. Check indoor heat exchanger temp. sensor (TC). 2. Check indoor P.C. board.
F10	Coming-off, disconnection or short of indoor heat exchanger temp. sensor (TA)	Stop (Automatically reset)	Displayed when error is detected	1. Check indoor heat exchanger temp. sensor (TA). 2. Check indoor P.C. board.
F29	Indoor EEPROM error • EEPROM access error	Stop (Automatically reset)	Displayed when error is detected	1. Check indoor EEPROM. (including socket insertion) 2. Check indoor P.C. board.
E10	Communication error between indoor MCU • Communication error between fan driving MCU and main MCU	Stop (Automatically reset)	Displayed when error is detected	1. Check indoor P.C. board.
E11	Communication error between Application and indoor unit	Stop (Automatically reset)	Displayed when error is detected	1. Check power supply / communication harness 2. Check indoor P.C. board
E18	Regular communication error between indoor master and follower units and between main and sub units	Stop (Automatically reset)	Displayed when error is detected	1. Check remote controller wiring. 2. Check indoor power supply wiring. 3. Check indoor P.C. board.

Error mode detected by outdoor unit

Operation of diagnostic function				Judgment and measures
Check code	Cause of errors	Status of air conditioner	Condition	
Indoor unit				
F04	Disconnection, short of discharge temp. sensor (TD)	Stop	Displayed when error is detected	1. Check discharge temp. sensor (TD). 2. Check outdoor P.C. board
F06	Disconnection, short of heat exchanger temp. sensor (TE)	Stop	Displayed when error is detected	1. Check heat exchanger temp. sensor (TE). 2. Check outdoor P.C. board .
F07	Disconnection, short of heat exchanger temp. sensor (TL)	Stop	Displayed when error is detected	1. Check heat exchanger temp. sensor (TL). 2. Check outdoor P.C. board .
F12	Disconnection, short of suction temp. sensor (TS)	Stop	Displayed when error is detected	1. Check suction temp. sensor (TS). 2. Check outdoor P.C. board.
F15	Miss-mounting of outdoor temp. sensor (TE, TS)	Stop	Displayed when error is detected	1. Check temp. sensor (TE, TS). 2. Check outdoor P.C. board.
F08	Disconnection, short of outside air temp. sensor (TO)	Continue	Displayed when error is detected	1. Check outside air temp. sensor (TO). 2. Check outdoor P.C. board.
F13	Disconnection, short of heat sink temp. sensor (TH)	Stop	Displayed when error is detected	1. Check outdoor P.C. board
F31	Outdoor EEPROM error	Stop	Displayed when error is detected	1. Check outdoor P.C. board.
L10	Unset model type of service P.C. board	Stop	Displayed when error is detected	1. Outdoor service P.C. board. Check model type setting jumper wire.
P07	Heat sink overheat error * Heat sink temp. sensor detected over specified temperature.	Stop	Displayed when error is detected	1. Check screw tightening between P.C. board and heat sink and check radiator grease. 2. Check heat sink blast path.
P15	Detection of gas leak * Discharge temp. sensor (TD), Suction temp. sensor (TS) detected temperature over specified temp.	Stop	Displayed when error is detected	1. Check gas leak, recharge 2. Check full open of service valve. 3. Check PMV (Pulse Motor Valve). 4. Check broken pipe. 5. Check discharge temp. sensor (TD), suction temp. sensor (TS).
P19	4-way valve inverse error * After heating operation has started, indoor heat exchanger temp. drops under the specified temp. * After heating operation has started, outdoor heat exchanger / suction temp. rises over the specified temp.	Stop	Displayed when error is detected	1. Check operation of 4-way valve. 2. Check outdoor heat exchanger (TE), suction temp. sensor (TS). 3. Check indoor heat exchanger sensor (TC). 4. Check 4-way valve coil. 5. Check PMV (Pulse Motor Valve).
H01	Compressor break down * Although operation has started, operation frequency decreases and operation stops.	Stop	Displayed when error is detected	1. Check power supply voltage. (50 Hz : AC 198 to 264 V, 60 Hz : AC 198 to 242 V) 2. Overload operation of refrigerating cycle
H02	Compressor lock * Over-current detection after compressor start-up	Stop	Displayed when error is detected	1. Compressor problem (Lock, etc.): Replace compressor. 2. Compressor wiring error (Open phase)

Operation of diagnostic function				Judgment and measures
Check code	Cause of errors	Status of air conditioner	Condition	
Indoor unit				
H03	Current detection circuit error	Stop	Displayed when error is detected	1. Check outdoor P.C. board. (AC current detection circuit)
H04	Case thermostat operation *Abnormal overheat of compressor	Stop	Displayed when error is detected	1. Check case thermostat and its connector 2. Check gas leak, recharge 3. Check full open of service valve 4. Check PMV (Pulse Motor Valve) 5. Check broken pipe
P03	Discharge temp. error * Discharge temp. (TD) over specified value was detected.	Stop	Displayed when error is detected	1. Check refrigerating cycle (Gas leak) 2. Check PMV (Pulse Motor Valve) 3. Check discharge temp. sensor (TD).
P04	High pressure SW system error	Stop	Displayed when error is detected	1. Check service valves are fully opened. (Gas side, Liquid side) 2. Check outdoor fan operation. 3. Check motor error of outdoor fan. 4. Check clogging of outdoor PMV. 5. Check clogging of heat exchanger in indoor/outdoor units. 6. Short-circuit of suction/discharge air in outdoor unit. 7. Check outdoor P.C. board error. 8. Check fan system error (Cause of air volume drop) at indoor side. 9. Check PMV opening status in indoor unit.
P05	Power supply voltage error	Stop	Displayed when error is detected	1. Check power supply voltage. 50 Hz : AC 198 to 264 V, 60 Hz : AC 198 to 242 V
P20	High pressure protective operation • During cooling operation, outdoor temp. sensor (TL) detected temperature over specified temp. • During heating operation, indoor temp. sensor (TC, TCJ) detected temperature over specified temp.	Stop	Displayed when error is detected	1. Check outdoor heat exchanger sensor (TL). 2. Check indoor heat exchanger sensor (TC, TCJ). 3. Check full open of service valve. 4. Check indoor/outdoor fan. 5. Check PMV (Pulse Motor Valve). 6. Check clogging and short circuit of indoor/outdoor heat exchanger. 7. Overcharge of refrigerant. Recharge
P22	Outdoor fan system error	Stop	Displayed when error is detected	1. Check lock of fan motor. 2. Check power supply voltage. 50 Hz : AC 198 to 264 V, 60 Hz : AC 198 to 242 V 3. Check outdoor P.C. board.
P26	Short-circuit error of compressor driving element	Stop	Displayed when error is detected	1. When performing operation while taking-off compressor wire. If P26 error occurs, check control P.C. board. 2. When performing operation while taking-off compressor wire. If an error does not occurs, compressor is layer short.
P29	Position detection circuit error	Stop	Displayed when error is detected	1. Check control P.C. board.

Error mode detected by remote controller or central controller (TCC-LINK)

Operation of diagnostic function				Judgment and measures
Check code	Cause of errors	Status of air conditioner	Condition	
Not displayed at all (Operation on remote controller cannot be operated.)	No communication with master indoor unit <ul style="list-style-type: none"> Remote controller wiring is not correct. Power of indoor unit is not turned on. Automatic address cannot be completed. 	Stop	—	Power supply error of remote controller, Indoor EEPROM error <ol style="list-style-type: none"> 1. Check remote controller inter-unit wiring. 2. Check remote controller. 3. Check indoor power wiring. 4. Check indoor P.C. board. 5. Check indoor EEPROM. (including socket insertion) → Automatic address repeating phenomenon generates.
E01 *1	No communication with master indoor unit <ul style="list-style-type: none"> Disconnection of inter-unit wire between remote controller and master indoor unit (Detected by remote controller side) 	Stop (Automatically reset) * If center exists, operation continues.	Displayed when error is detected	Receiving error from remote controller <ol style="list-style-type: none"> 1. Check remote controller inter-unit wiring. 2. Check remote controller. 3. Check indoor power wiring. 4. Check indoor P.C. board.
E02	Signal send error to indoor unit (Detected by remote controller side)	Stop (Automatically reset) * If center exists, operation continues.	Displayed when error is detected	Error sending of remote controller <ol style="list-style-type: none"> 1. Check sending circuit inside the remote controller. → Replace remote controller.
E09	There are multiple main remote controllers. (Detected by remote controller side)	Stop (Sub unit continues operation.)	Displayed when error is detected	1. In 2-remote controllers (including wireless), there are multiple main units. Check that there are 1 main remote controller and other sub remote controllers.
L20 Central controller L20	Duplicated indoor central addresses on communication of central control system (Detected by indoor/central controller side)	Stop (Automatically reset)	Displayed when error is detected	1. Check setting of central control system network address. (Network adapter SW01) 2. Check network adapter P.C. board.
— *2 Central controller (Send) C05 (Receive) C06	Communication circuit error of central control system (Detected by central controller side)	Continues (By remote controller)	Displayed when error is detected	1. Check communication wire / miswiring 2. Check communication (U3, U4 terminals) 3. Check network adapter P.C. board. 4. Check central controller (such as central control remote controller, etc.) 5. Check terminal resistance. (TCC-LINK)
— Central controller P30	Indoor Gr sub unit error (Detected by central controller side)	Continuation/Stop (According to each case)	Displayed when error is detected	Check the check code of the corresponding unit from remote controller.

*1 The check code cannot be displayed by the wired remote controller.
(Usual operation of air conditioner becomes unavailable.)

For the wireless models, an error is notified by indication lamp.

*2 This trouble is related to communication of remote controller (A, B), central system (TCC-LINK U3, U4), and [E01], [E02], [E03], [E09] or [E18] is displayed or no check display on the remote controller according to the contents.

Contents Error Display

* When the errors were overlapped, the latest error is displayed.

* When D800 to D804 are slowly flashing or D805 is flashing, push and hold SW01 and SW02 simultaneously for 5 seconds or more. The error display changes to the error which is generated.

○ : ON, ● : OFF, ⊙ : Rapid flashing (5 times /second)

No.	Error	Check code [Wired remote controller]	LED display					
			D800 (Yellow)	D801 (Yellow)	D802 (Yellow)	D803 (Yellow)	D804 (Yellow)	D805 (Green)
1	Normal	—	●	●	●	●	●	○
2	Discharge temp. sensor (TD) error	F04	⊙	●	●	●	●	○
3	Heat exchanger temp. sensor (TE) error	F06	●	⊙	●	●	●	○
4	Heat exchanger temp. sensor (TL) error	F07	⊙	⊙	●	●	●	○
5	Outside air temp. sensor (TO) error	F08	●	●	⊙	●	●	○
6	Suction temp. sensor (TS) error	F12	⊙	●	⊙	●	●	○
7	Heat sink temp. sensor (TH) error	F13	●	⊙	⊙	●	●	○
8	Miss-mounting of outdoor temp. sensor (TE, TS)	F15	⊙	⊙	⊙	●	●	○
9	EEPROM error	F31	●	⊙	●	⊙	●	○
10	Compressor break down	H01	⊙	⊙	●	⊙	●	○
11	Compressor lock	H02	●	●	⊙	⊙	●	○
12	Current detection circuit error	H03	⊙	●	⊙	⊙	●	○
13	Case thermostat operation	H04	●	⊙	⊙	⊙	●	○
14	Unset model type of P.C.board	L10	●	●	●	●	⊙	○
15	Discharge temp. error	P03	●	⊙	●	●	⊙	○
16	High pressure SW system error	P04	⊙	⊙	●	●	⊙	○
17	Power supply error	P05	●	●	⊙	●	⊙	○
18	Heat sink overheat error	P07	●	⊙	⊙	●	⊙	○
19	Gas leak detection	P15	⊙	⊙	⊙	●	⊙	○
20	4-way valve inverse error	P19	●	●	●	⊙	⊙	○
21	High pressure protective operation	P20	⊙	●	●	⊙	⊙	○
22	Fan system error	P22	●	⊙	●	⊙	⊙	○
23	Short-circuit of compressor drive element	P26	⊙	⊙	●	⊙	⊙	○
24	Position detection circuit error	P29	●	●	⊙	⊙	⊙	○
25	Others (continuously operate)	-	⊙	●	⊙	⊙	⊙	○

<SM56, 80>

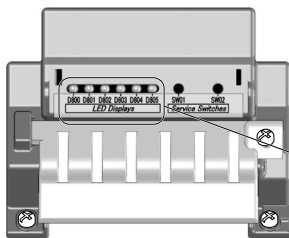

* The LEDs and switches are located at the outdoor unit as shown in the figure on the left.

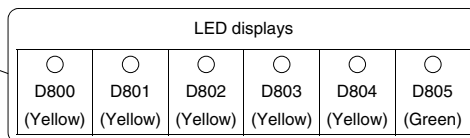

<SM110, 140>

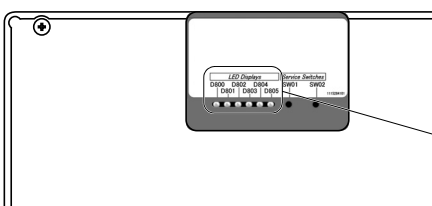

* The LEDs and switches are located at the outdoor unit as shown in the figure on the left.

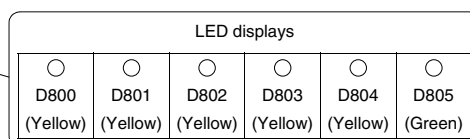

8-2-5. Diagnostic Procedure for Each Check Code (Outdoor Unit)

- 1) This section describes the diagnostic method for each check code displayed on the wired remote controller.
- 2) In some cases, a check code indicates multiple symptoms.
In this case, confirm LED display on the outdoor unit to narrow the contents to be confirmed.
- 3) The check code on the wired remote controller is displayed only when the same error occurred continuously by multiple times while LED of the outdoor unit displays even an error which occurred once.
Therefore the display on the wired remote controller may differ from that of LED.

LED display on outdoor unit

Operation method of the service SW

[Display of error which is generating]

- When even one of D800 to D804 rapid flashing, it indicates that an error occurred. When D800 to D801 indicate slow flashing or when D805 flashes, push and hold SW01 and SW02 for 5 seconds or more simultaneously. The error display exchanges to display of the error under occurrence at present.

[Example of discharge temp. sensor error]

(No error)

●	●	●	●	●	○
D800 (Yellow)	D801 (Yellow)	D802 (Yellow)	D803 (Yellow)	D804 (Yellow)	D805 (Green)

○ : ON, ● : OFF, ◎ : Rapid flashing (5 times /second)

(Error occurred)

◎	●	●	●	●	○
D800 (Yellow)	D801 (Yellow)	D802 (Yellow)	D803 (Yellow)	D804 (Yellow)	D805 (Green)

○ : ON, ● : OFF, ◎ : Rapid flashing (5 times /second)

Display of the latest error

- The latest error is displayed by the following action. As the memory is kept, it is confirmed even after the power supply was turned off once. (Except outside air temp. sensor (TO) error)



- 1) Check D800 to D804 are turned off (or rapid flashing) and D805 is turned on. When D800 to D804 are slowly flashing or D805 flashes, push and hold SW01 and SW02 for 5 seconds or more simultaneously. D800 to D804 will be turned off (or rapid flashing) and D805 flashes.
- 2) Push and hold SW01 for 5 seconds or more. D804 changes to slow flashing.
- 3) Push SW01 several times and change LED display (D800 to D804) to [Display of latest error (Including the present error)].
- 4) Push SW02. The latest error is displayed.
- 5) When finishing the work, be sure to execute item 1) to return LED to the initial status (Display of on occurring error).

Display of latest error
(Including the present error)

○	●	●	●	●	◎
D800 (Yellow)	D801 (Yellow)	D802 (Yellow)	D803 (Yellow)	D804 (Yellow)	D805 (Green)





○ : ON, ● : OFF, ◎ : Rapid flashing (5 times /second)

Check code	Outdoor LED display	Check and troubleshooting (Item without special mention indicates part of outdoor unit.)
[E04]	—	<p>[Indoor/Outdoor communication error]</p> <pre> graph TD Q1{{Is setting of group address of remote controller correct?}} -- NO --> A1[Check CODE No. [14]. Refer to "10 ADDRESS SETUP"] Q1 -- YES --> Q2{{Are inner wiring and indoor/outdoor control wires (1, 2, 3) correct?}} Q2 -- NO --> A2[Correct wiring indoor/outdoor control wires] Q2 -- YES --> Q3{{Are wiring of terminal blocks (1, 2, 3) correct?}} Q3 -- NO --> A3[Correct wiring of connectors and terminal blocks.] Q3 -- YES --> A4[Check outdoor P.C. board. Defect -> Replace] </pre>

Check code	Outdoor LED display	Check and troubleshooting (Item without special mention indicates part of outdoor unit.)
[F04]		<p>[Discharge temp. sensor (TD) error]</p> <pre> graph TD Q1{Is CN601 connection correct? Is resistance value of TD sensor correct?} Q1 -- NO --> A1[Correct connector. Sensor error → Replace] Q1 -- YES --> A2[Check outdoor P.C. board. Defect → Replace] </pre>
[F06]		<p>Heat exchanger temp. sensor (TE) error]</p> <pre> graph TD Q2{Is SM56, 80:CN600, SM110,140:CN603 connection correct? Is resistance value of TE sensor correct?} Q2 -- NO --> A3[Correct connector. Sensor error → Replace] Q2 -- YES --> A4[Check outdoor P.C. board. Defect → Replace] </pre>
[F07]		<p>[Heat exchanger temp. sensor (TL) error]</p> <pre> graph TD Q3{Is SM56, 80:CN604, SM110,140:CN605 connection correct? Is resistance value of TL sensor correct?} Q3 -- NO --> A5[Correct connector. Sensor error → Replace] Q3 -- YES --> A6[Check outdoor P.C. board. Defect → Replace] </pre>

Check code	Outdoor LED display	Check and troubleshooting (Item without special mention indicates part of outdoor unit.)
[F08]	● ● ◎ ● ● ○	<p>[Outside air temp. sensor (TO) error]</p> <pre> graph TD Q1{{Is CN602 connection correct? Is resistance value of TO sensor correct?}} A1[Correct connector. Sensor error → Replace] A2[Check outdoor P.C. board. Defect → Replace] Q1 -- NO --> A1 Q1 -- YES --> A2 </pre>
[F12]	◎ ● ◎ ● ● ○	<p>[Suction temp. sensor (TS) error]</p> <pre> graph TD Q2{{Is SM56, 80 : CN603, SM110, 140 : CN604 connection correct? Is resistance value of TS sensor correct?}} A3[Correct connector. Sensor error → Replace] A4[Check outdoor P.C. board. Defect → Replace] Q2 -- NO --> A3 Q2 -- YES --> A4 </pre>
[F13]	● ◎ ◎ ● ● ○	<p>[Heat sink temp. sensor (TH) error]</p> <pre> graph TD A5[Check outdoor P.C. board. Defect → Replace] </pre>
[F15]	◎ ◎ ◎ ● ● ○	<p>[Miss-mounting of outdoor temp. sensor (TE)]</p> <pre> graph TD Q3{{Is mounting status of TE and TS sensors correct?}} Q4{{Is SM56, 80 : CN603, SM110, 140 : CN604 connection correct? Is resistance value of TS sensor correct?}} Q5{{Is SM56, 80 : CN600, SM110, 140 : CN603 connection correct? Is resistance value of TE sensor correct?}} A6[Correct sensor mounting.] A7[Correct connector. Sensor error → Replace] A8[Correct connector. Sensor error → Replace] A9[Check outdoor P.C. board. Defect → Replace] Q3 -- NO --> A6 Q3 -- YES --> Q4 Q4 -- NO --> A7 Q4 -- YES --> Q5 Q5 -- NO --> A8 Q5 -- YES --> A9 </pre>

Check code	Outdoor LED display	Check and troubleshooting (Item without special mention indicates part of outdoor unit.)
[F31]	● ◎ ● ◎ ● ○	<p>[EEPROM error]</p> <div style="border: 1px solid black; padding: 5px; width: fit-content; margin: 10px auto;"> Check outdoor P.C. board. Defect → Replace </div>
[H01]	◎ ◎ ● ◎ ● ○	<p>[Compressor break down]</p> <pre> graph TD Q1{{Is power supply voltage correct? 50 Hz : AC 198 to 264 V 60 Hz : AC 198 to 242 V}} A1[Correct power supply line.] Q2{{Is wire connection correct? Compressor lead (P.C. board side, Compressor side), Reactor lead, Power supply lead}} A2[Check wire connection and correct it.] Q3{{Does an abnormal overload happen?}} A3[Remove and improve the cause of overload.] A4[Check outdoor P.C. board. Defect → Replace] Q1 -- NO --> A1 Q1 -- YES --> Q2 Q2 -- NO --> A2 Q2 -- YES --> Q3 Q3 -- YES --> A3 Q3 -- NO --> A4 </pre>
[H02]	● ● ◎ ◎ ● ○	<p>[Compressor lock]</p> <pre> graph TD Q1{{Is power supply voltage correct? 50 Hz : AC 198 to 264 V 60 Hz : AC 198 to 242 V}} A1[Correct power supply line.] Q2{{Is wire connection correct? Compressor lead (P.C. board side, Compressor side), Reactor lead, Power supply lead}} A2[Check wire connection and correct it.] Q3{{Is compressor under correct condition?}} A3[Check outdoor P.C. board. Defect → Replace] Q4{{Is there refrigerant stagnation?}} A4[Compressor lock → Replace] Q5{{Does PMV correctly operate?}} A5[Check TE, TS sensors and PMV. Defect → Replace] A6[Check outdoor P.C. board. Defect → Replace] Q1 -- NO --> A1 Q1 -- YES --> Q2 Q2 -- NO --> A2 Q2 -- YES --> Q3 Q3 -- YES --> A3 Q3 -- NO --> Q4 Q4 -- NO --> A4 Q4 -- YES --> Q5 Q5 -- NO --> A5 Q5 -- YES --> A6 </pre>

Check code	Outdoor LED display	Check and troubleshooting (Item without special mention indicates part of outdoor unit.)
[H03]		<p>[Current detection circuit error]</p> <div style="border: 1px solid black; padding: 5px; width: fit-content; margin: 10px auto;"> Check outdoor P.C. board. Defect → Replace </div>
[H04]		<p>[Case thermostat operation]</p> <pre> graph TD Q1{Are CN500 connection and case thermostat correct?} -- NO --> A1[Correct connector. Case thermostat error → Replace] Q1 -- YES --> Q2{Short each pins of CN500. Can compressor operate?} Q2 -- NO --> A2[Check outdoor P.C. board. Defect → Replace] Q2 -- YES --> Q3{Is there gas leak? Is there refrigerant shortage?} Q3 -- YES --> A3[Repair defectives position. Recharge refrigerant.] Q3 -- NO --> Q4{Is service valve fully opened?} Q4 -- NO --> A4[Open service valve fully.] Q4 -- YES --> Q5{Is PMV under correct conditions?} Q5 -- NO --> A5[Correct defective position. Replace defective part.] Q5 -- YES --> A6[Check crushed or broken pipe. Defect → Correct and Replace] </pre>
[L10]		<p>[Unset model type] : Only when service P.C. board is used</p> <div style="border: 1px solid black; padding: 5px; width: fit-content; margin: 10px auto;"> Cut jumper line according to the explanation sheet packaged with the service P.C. board. </div>
[P03]		<p>[Discharge temp. error]</p> <pre> graph TD Q1{Is there gas leak? Is there refrigerant shortage?} -- YES --> A1[Repair defective position. Recharge refrigerant.] Q1 -- NO --> Q2{Is PMV under correct condition} Q2 -- NO --> A2[Repair defective position. Replace defective part.] Q2 -- YES --> Q3{Does an abnormal overload happen} Q3 -- YES --> A3[Remove and improve the cause of overload.] Q3 -- NO --> Q4{Is CN601 connection correct? Is resistance value of TD sensor correct?} Q4 -- NO --> A4[Correct connector. Sensor error → Replace] Q4 -- YES --> A5[Check outdoor P.C. board. Defect → Replace] </pre>



Check code	Outdoor LED display	<DCheck and troubleshooting (Item without special mention indicates part of outdoor unit.)
[P04]		<p>[High pressure SW system error]</p> <pre> graph TD Q1{{Does high pressure switch operate?}} -- NO --> Q2{{Is circuit wiring correct?}} Q1 -- YES --> Q3{{Are parts of high pressure switch correct?}} Q2 -- NO --> A1[Wiring check, Correct.] Q2 -- YES --> A2[Check outdoor PC board Defective -> Replace] Q3 -- NO --> A3[Parts check Defective -> Replace] Q3 -- YES --> Q4{{Is service valve fully opened?}} Q4 -- NO --> A4[Open service valve fully.] Q4 -- YES --> A5[Reset the power supply and then do a test operation according to the season.] A5 --> B[Cooling operation.] A5 --> C[Heating operation.] B --> Q5{{Does cooling outdoor fan correctly operate?}} Q5 -- NO --> Q6{{Is there fan breakage or coming-off?}} Q5 -- YES --> Q7{{Is there any element which blocks heat exchanger of the outdoor unit?}} Q6 -- YES --> A6[Repair defective position. Connection of connectors, outdoor P.C. board, Fan motor, Wiring.] Q6 -- NO --> Q7 Q7 -- YES --> A7[Elimination of blocking element] Q7 -- NO --> A8[Overcharge of refrigerant/ Clogging/Pipe breakage/ Abnormal overload] C --> Q8{{Does the heating indoor fan correctly operate?}} Q8 -- NO --> Q9{{Are connections of connectors, capacitors and fan motor correct?}} Q8 -- YES --> Q10{{Is there any element which blocks indoor heat exchanger?}} Q9 -- YES --> Q11{{Are resistance value of TC and TCJ sensor correct?}} Q9 -- NO --> A9[Repair defective position.] Q10 -- YES --> A10[Elimination of blocking element] Q10 -- NO --> A11[Clogging by refrigerant overcharge/Pipe breakage/ Abnormal overload] Q11 -- YES --> A12[Check indoor P.C. board Defective -> Replace] Q11 -- NO --> A13[Replace TC or TCJ sensor.] </pre> <p> (B) ← Cooling operation (C) ← Heating operation </p>

Check code	Outdoor LED display	Check and troubleshooting (Item without special mention indicates part of outdoor unit.)
[P05]	● ● ◎ ● ◎ ○	<p>[Power supply error]</p> <pre> graph TD Q1{{Is the power supply voltage is lower than or over the range? 50 Hz : AC 198 to 264 V 60 Hz : AC 198 to 242 V}} A1[Confirm power supply, etc.] A2[Check outdoor P.C. board. Defect -> Replace] Q1 -- YES --> A1 Q1 -- NO --> A2 </pre>
[P07]	● ◎ ◎ ● ◎ ○	<p>[Heat sink overheat error]</p> <pre> graph TD Q1{{Is the power device on P.C. board tightly screwed? Are radiation grease properly applied?}} A1[Apply radiation grease to the power device. Retightening of screws.] Q2{{Does anything block the ventilation around the heat sink? Does anything block air flow from the fan?}} A2[Remove blocking matter. Correct short-circuit.] A3[Check outdoor P.C. board. Defect -> Replace] Q1 -- NO --> A1 Q1 -- YES --> Q2 Q2 -- YES --> A2 Q2 -- NO --> A3 </pre>
[P15]	◎ ◎ ◎ ● ◎ ○	<p>[Gas leak detection]</p> <pre> graph TD Q1{{Is there gas leak? Is there refrigerant shortage?}} A1[Repair defective position. Recharge refrigerant.] Q2{{Is PMV under correct condition?}} A2[Correct defective position. Replace defective part.] Q3{{Is service valve fully opened?}} A3[Open service valve fully.] Q4{{Is there crushed pipe?}} A4[Correct and replace piping.] Q5{{Check temp. sensor. TD sensor CN601, TS sensor SM56, 80:CN603, SM1110, 140:CN604}} A5[Correct connector. Sensor error -> Replace] A6[Check outdoor P.C. board. Defect -> Replace] Q1 -- YES --> A1 Q1 -- NO --> Q2 Q2 -- NO --> A2 Q2 -- YES --> Q3 Q3 -- NO --> A3 Q3 -- YES --> Q4 Q4 -- YES --> A4 Q4 -- NO --> Q5 Q5 -- Error --> A5 Q5 -- OK --> A6 </pre>

Check code	Outdoor LED display	Check and troubleshooting (Item without special mention indicates part of outdoor unit.)																										
[P19]	● ● ● ◎ ◎ ○	<p>[4-way valve inverse error]</p> <p>4-way valve maintenance check operation (SW01 and SW02 operations) You can confirm 4-way valve operation by handling service switches SW01 and SW02. Use this method to check whether there is trouble or not on the 4-way valve.</p> <p>[Method]</p> <ol style="list-style-type: none"> (1) Check D800 to D804 are turned off (or rapid flashing) and D805 is turned on. When D800 to D804 flash slowly or D805 flashes, push and hold SW01 and SW02 for 5 seconds or more simultaneously. In the result, D800 to D804 are turned off (or rapid flashing) and D805 changes from flashing to lighting. (2) Push and hold SW01 for 5 seconds or more. D804 changes to slow flashing. (3) Push SW01 several time and stop it at LED display of the following "Self-preservation valve operation" <table border="1" data-bbox="592 1515 1453 1825"> <tr> <td data-bbox="592 1515 812 1664">Self-preservation valve suck operation</td> <td data-bbox="812 1515 1112 1664"> <table border="1"> <tr> <td>D800</td> <td>D801</td> <td>D802</td> <td>D803</td> <td>D804</td> </tr> <tr> <td>○</td> <td>●</td> <td>○</td> <td>○</td> <td>◎</td> </tr> </table> </td> <td data-bbox="1112 1515 1453 1664"> SM56, 80: switch to cooling cycle This function is operated only by ten seconds, and turned off afterwards. SM110, 140: switch to heating cycle This function is operated only by ten seconds, and turned off afterwards. </td> </tr> <tr> <td data-bbox="592 1664 812 1825">Self-preservation valve secession operation</td> <td data-bbox="812 1664 1112 1825"> <table border="1"> <tr> <td>D800</td> <td>D801</td> <td>D802</td> <td>D803</td> <td>D804</td> </tr> <tr> <td>●</td> <td>○</td> <td>○</td> <td>○</td> <td>◎</td> </tr> </table> </td> <td data-bbox="1112 1664 1453 1825"> SM56, 80: switch to heating cycle This function is operated only by ten seconds, and turned off afterwards. SM110, 140: switch to cooling cycle This function is operated only by ten seconds, and turned off afterwards. </td> </tr> </table> <p>○ : ON, ● : OFF, ◎ : Rapid flashing (5 times/second)</p> <ol style="list-style-type: none"> (4) Push SW02 and then stop it at LED display of D805 flashes rapidly. (5) Push and hold SW02 for 5 seconds or more. In the result, D804 changes to slow flashing, D805 changes to lighting and the 4-way valve is operated. <p>* If an unknown point generated on the way of the operation, push and hold SW01 and SW02 for 5 seconds or more simultaneously. You can return to the item (1).</p>	Self-preservation valve suck operation	<table border="1"> <tr> <td>D800</td> <td>D801</td> <td>D802</td> <td>D803</td> <td>D804</td> </tr> <tr> <td>○</td> <td>●</td> <td>○</td> <td>○</td> <td>◎</td> </tr> </table>	D800	D801	D802	D803	D804	○	●	○	○	◎	SM56, 80: switch to cooling cycle This function is operated only by ten seconds, and turned off afterwards. SM110, 140: switch to heating cycle This function is operated only by ten seconds, and turned off afterwards.	Self-preservation valve secession operation	<table border="1"> <tr> <td>D800</td> <td>D801</td> <td>D802</td> <td>D803</td> <td>D804</td> </tr> <tr> <td>●</td> <td>○</td> <td>○</td> <td>○</td> <td>◎</td> </tr> </table>	D800	D801	D802	D803	D804	●	○	○	○	◎	SM56, 80: switch to heating cycle This function is operated only by ten seconds, and turned off afterwards. SM110, 140: switch to cooling cycle This function is operated only by ten seconds, and turned off afterwards.
Self-preservation valve suck operation	<table border="1"> <tr> <td>D800</td> <td>D801</td> <td>D802</td> <td>D803</td> <td>D804</td> </tr> <tr> <td>○</td> <td>●</td> <td>○</td> <td>○</td> <td>◎</td> </tr> </table>	D800	D801	D802	D803	D804	○	●	○	○	◎	SM56, 80: switch to cooling cycle This function is operated only by ten seconds, and turned off afterwards. SM110, 140: switch to heating cycle This function is operated only by ten seconds, and turned off afterwards.																
D800	D801	D802	D803	D804																								
○	●	○	○	◎																								
Self-preservation valve secession operation	<table border="1"> <tr> <td>D800</td> <td>D801</td> <td>D802</td> <td>D803</td> <td>D804</td> </tr> <tr> <td>●</td> <td>○</td> <td>○</td> <td>○</td> <td>◎</td> </tr> </table>	D800	D801	D802	D803	D804	●	○	○	○	◎	SM56, 80: switch to heating cycle This function is operated only by ten seconds, and turned off afterwards. SM110, 140: switch to cooling cycle This function is operated only by ten seconds, and turned off afterwards.																
D800	D801	D802	D803	D804																								
●	○	○	○	◎																								

Check code	Outdoor LED display	Check and troubleshooting (Item without special mention indicates part of outdoor unit.)
[P20]		<p>[High pressure protective operation]</p> <pre> graph TD Q1{{Is service valve fully opened?}} -- NO --> A1[Open service valve fully.] Q1 -- YES --> B1[Reset the power supply and then make a test run matching to the season.] B1 --> Q2{{Is resistance value of outdoor TL sensor correct?}} Q2 -- NO --> A2[Replace sensor.] Q2 -- YES --> Q3{{Is there any defect such as loosen nut in outdoor fan?}} Q3 -- YES --> A3[Check outdoor fan. Defect → Replace, retightening] Q3 -- NO --> Q4{{Does the outdoor fan perform abnormal operation?}} Q4 -- YES --> A4[Check the same items as [P22] error.] Q4 -- NO --> Q5{{Is there any element which blocks heat exchanger of outdoor unit? • Clogging of heat exchanger • Short circuit}} Q5 -- YES --> A5[Eliminate interfering element.] Q5 -- NO --> A6[Check overcharge of refrigerant, clogging of cycle, broken pipe, abnormal overload, etc. Defect → Correct defective position.] A6 --> Q6{{Does indoor fan correctly operate?}} Q6 -- YES --> Q7{{Are indoor fan motor and connector correct?}} Q7 -- NO --> A7[Correct the connection.] Q7 -- YES --> Q8{{Are resistance values of indoor TC and TCJ sensors correct?}} Q8 -- NO --> A8[Replace sensor.] Q8 -- YES --> A9[Check indoor P.C. board. Defect → Replace] Q6 -- NO --> Q9{{Is there any element blocks heat exchanger of indoor unit? • Clogging of filter • Clogging of heat exchanger • Short circuit}} Q9 -- YES --> A10[Eliminate interfering element.] Q9 -- NO --> A11[Check overcharge of refrigerant, clogging of cycle, broken pipe, abnormal overload, etc. Defect → Correct defective position.] </pre> <p>Heating season Heating operation</p> <p>Cooling season Cooling operation</p>

Check code	Outdoor LED display	Check and troubleshooting (Item without special mention indicates part of outdoor unit.)												
[P22]	● ◎ ● ◎ ◎ ○	<p>[Fan system error]</p> <pre> graph TD Q1{{Is the power supply voltage is lower than or over the range? 50 Hz : AC 198 to 264 V 60 Hz : AC 198 to 242 V}} A1[Check wiring construction. Ask to repair the power supply.] Q2{{Rotate shaft of the fan motor by hands during power-OFF. Can it be rotated smoothly? Is the resistance value of fan motor coil correct? Between red and white lead wire : 12 to 25Ω Between white and black lead wire : 12 to 25Ω Between black and red lead wire : 12 to 25Ω}} A2[Replace fan motor.] A3[Check outdoor PC board. Defect → Replace] Q1 -- NO --> A1 Q1 -- YES --> Q2 Q2 -- YES --> A3 Q2 -- NO --> A2 </pre> <p>Single operation check for outdoor fan</p> <p>A single operation of the outdoor fan can be confirmed by handling the service switches SW01 and SW02. Use this method to check whether there is trouble on the fan or not.</p> <p>[Method]</p> <ol style="list-style-type: none"> Check D800 to D804 are turned off (or rapid flashing) and D805 is turned on. When D800 to D804 flash slowly or D805 flashes, push and hold SW01 and SW02 for 5 seconds or more simultaneously. As a D800 to D804 are turned off (or rapid flashing) and D805 changes from flashing to lighting. Push and hold SW01 for 5 seconds or more. D804 changes to slow flashing. Push SW01 several times until the LED displays as the following "Outdoor fan single operation". <table border="1" data-bbox="776 1276 1243 1373"> <tr> <td></td> <td>D800</td> <td>D801</td> <td>D802</td> <td>D803</td> <td>D804</td> </tr> <tr> <td>Outdoor fan single operation</td> <td>○</td> <td>○</td> <td>●</td> <td>○</td> <td>◎</td> </tr> </table> <p>○ : ON, ● : OFF ◎ : Rapid flashing</p> <ol style="list-style-type: none"> Push SW02 several times until D805 rapidly flashes rapidly. Push and hold SW02 for 5 seconds or more. As a result, D804 changes to slow flashing, D805 changes to lighting and the fan rotates. The fan stops when pushing long SW01 and SW02 for 5 seconds or more simultaneously or when 2 minutes passed. <p>* If lost tracking on the operation, push and hold SW01 and SW02 for 5 seconds or more simultaneously to return to the item (1).</p>		D800	D801	D802	D803	D804	Outdoor fan single operation	○	○	●	○	◎
	D800	D801	D802	D803	D804									
Outdoor fan single operation	○	○	●	○	◎									

Check code	Outdoor LED display	Check and troubleshooting (Item without special mention indicates part of outdoor unit.)
[P26]		<p>[Short-circuit of compressor driving elements]</p> <pre> graph TD Q1{{Are connections of compressor lead and reactor lead correct? (Check referring to Wiring diagram.)}} Q2{{Does the same error occur in operation without compressor lead?}} A1[Correct wiring.] A2[Replace outdoor P.C. board.] A3[Check compressor. (Layer short, etc.) Defect → Replace] Q1 -- NO --> A1 Q1 -- YES --> Q2 Q2 -- YES --> A2 Q2 -- NO --> A3 </pre>
[P29]		<p>[Position detection circuit error]</p> <div style="border: 1px solid black; padding: 5px; width: fit-content; margin: 10px auto;"> <p>Check outdoor P.C. board. Defect → Replace</p> </div>
— No code		<p>[Other] Compressor disorder due to sudden change of load, etc.</p> <ul style="list-style-type: none"> * Although the display of outdoor LED outputs, the unit automatically restarts and error is not determined. * A code may appear when an open phase of compressor, coming-out of wires or power relay trouble occurred.

8-2-5. Diagnostic Procedure for Each Check Code (Outdoor Unit)

Temperature sensor Temperature – Resistance value characteristic table

TA, TC, TCJ, TE, TS, TO sensors

TD, TL sensors

Representative value

Representative value

Temperature (°C)	Resistance value (kΩ)		
	(Minimum value)	(Standard value)	(Maximum value)
0	32.33	33.80	35.30
10	19.63	20.35	21.09
20	12.23	12.59	12.95
25	9.75	10.00	10.25
30	7.764	7.990	8.218
40	5.013	5.192	5.375
50	3.312	3.451	3.594
60	2.236	2.343	2.454
70	1.540	1.623	1.709
80	1.082	1.146	1.213
90	0.7740	0.8237	0.8761
100	0.5634	0.6023	0.6434

Temperature (°C)	Resistance value (kΩ)		
	(Minimum value)	(Standard value)	(Maximum value)
0	150.5	161.3	172.7
10	92.76	99.05	105.6
20	58.61	62.36	66.26
25	47.01	49.93	52.97
30	37.93	40.22	42.59
40	25.12	26.55	28.03
50	17.00	17.92	18.86
60	11.74	12.34	12.95
70	8.269	8.668	9.074
80	5.925	6.195	6.470
90	4.321	4.507	4.696
100	3.205	3.336	3.468

TA, TC, TCJ, TE, TS, TO sensors

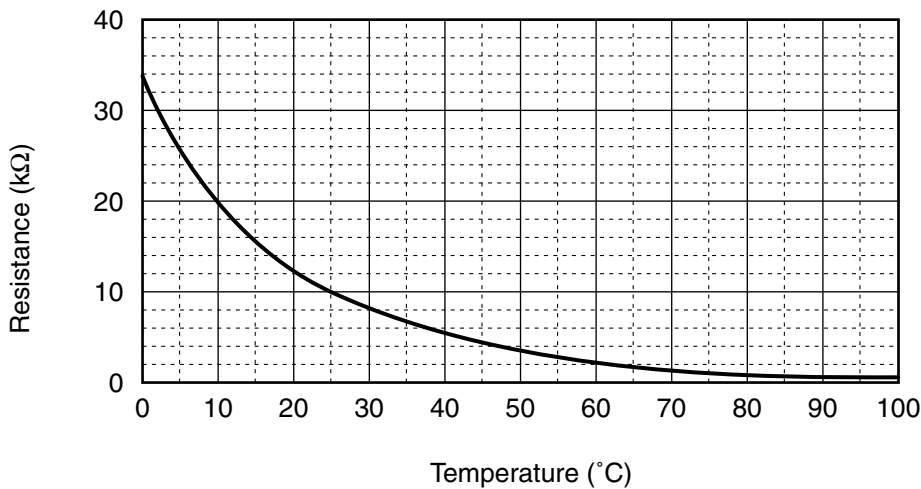

TD, TL sensors

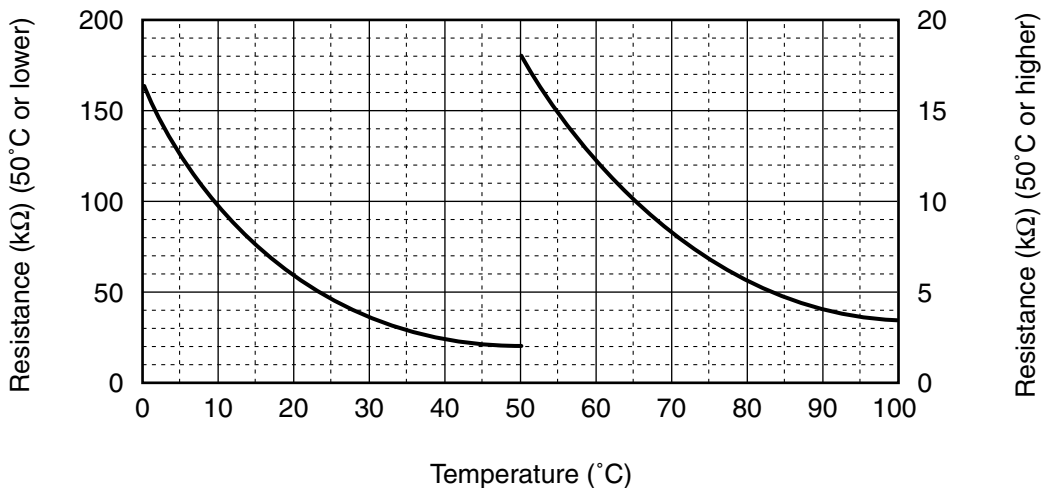

* As TH sensor (Outdoor unit heat sink temp. sensor) is incorporated in the outdoor control P.C. board, the resistance value cannot be measured.

8-3. Table Inspection of outdoor unit main parts

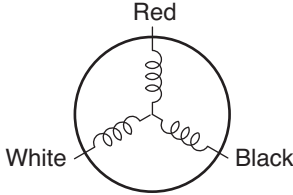
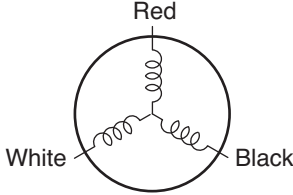
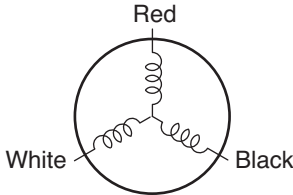
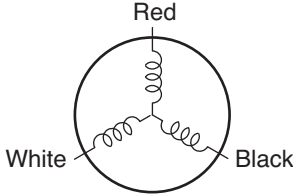
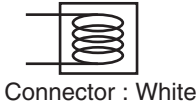
No.	Parts name	Checking procedure						
1	Compressor (Model : DA150A1T-20FD)	<p>Measure the resistance value of each winding by using the tester.</p>  <table border="1" data-bbox="966 335 1451 569"> <thead> <tr> <th>Position</th> <th>Resistance value</th> </tr> </thead> <tbody> <tr> <td>Red – White</td> <td rowspan="3">1.03 Ω</td> </tr> <tr> <td>White – Black</td> </tr> <tr> <td>Black – Red</td> </tr> </tbody> </table> <p style="text-align: right;">Under 20°C</p>	Position	Resistance value	Red – White	1.03 Ω	White – Black	Black – Red
Position	Resistance value							
Red – White	1.03 Ω							
White – Black								
Black – Red								
2	Fan motor (Model : ICF-140-43-4R)	<p>Measure the resistance value of each winding by using the tester.</p>  <table border="1" data-bbox="966 707 1451 941"> <thead> <tr> <th>Position</th> <th>Resistance value</th> </tr> </thead> <tbody> <tr> <td>Red – White</td> <td rowspan="3">21.00±1.05 Ω</td> </tr> <tr> <td>White – Black</td> </tr> <tr> <td>Black – Red</td> </tr> </tbody> </table> <p style="text-align: right;">Under 20°C</p>	Position	Resistance value	Red – White	21.00±1.05 Ω	White – Black	Black – Red
Position	Resistance value							
Red – White	21.00±1.05 Ω							
White – Black								
Black – Red								
3	Compressor (Model : DA330A2T-20MD)	<p>Measure the resistance value of each winding by using the tester.</p>  <table border="1" data-bbox="966 1076 1451 1311"> <thead> <tr> <th>Position</th> <th>Resistance value</th> </tr> </thead> <tbody> <tr> <td>Red – White</td> <td rowspan="3">0.37 Ω</td> </tr> <tr> <td>White – Black</td> </tr> <tr> <td>Black – Red</td> </tr> </tbody> </table> <p style="text-align: right;">Under 20°C</p>	Position	Resistance value	Red – White	0.37 Ω	White – Black	Black – Red
Position	Resistance value							
Red – White	0.37 Ω							
White – Black								
Black – Red								
4	Outdoor fan motor (Model : WDF-340-A100-1)	<p>Measure the resistance value of each winding by using the tester.</p>  <table border="1" data-bbox="966 1448 1451 1682"> <thead> <tr> <th>Position</th> <th>Resistance value</th> </tr> </thead> <tbody> <tr> <td>Red – White</td> <td rowspan="3">17.3±1.7 Ω</td> </tr> <tr> <td>White – Black</td> </tr> <tr> <td>Black – Red</td> </tr> </tbody> </table> <p style="text-align: right;">Under 20°C</p>	Position	Resistance value	Red – White	17.3±1.7 Ω	White – Black	Black – Red
Position	Resistance value							
Red – White	17.3±1.7 Ω							
White – Black								
Black – Red								
5	4-way valve coil (Cooling/heating switching) (Model : STF-H)	<p>Measure the resistance value of each winding by using the tester.</p>  <table border="1" data-bbox="966 1820 1451 1935"> <thead> <tr> <th>Resistance value</th> </tr> </thead> <tbody> <tr> <td>7.1±0.36 Ω</td> </tr> </tbody> </table> <p style="text-align: right;">Under 20°C</p>	Resistance value	7.1±0.36 Ω				
Resistance value								
7.1±0.36 Ω								

9. SETUP AT LOCAL SITE AND OTHERS

9-1. Calling of Error History

<Contents>

The error contents in the past can be called.

<Procedure>

- 1** Push **SET** + **TEST** buttons simultaneously for **4 seconds or more to call the service check mode.**
Service Check goes on, the **CODE No.** **01** is displayed, and then the content of the latest alarm is displayed. The number and error contents of the indoor unit in which an error occurred are displayed.
- 2** In order to monitor another error history, push the set temperature **TEMP.** buttons to change the error history No. (CODE No.).
CODE No. **01** (Latest) → **CODE No.** **04** (Old)
NOTE : 4 error histories are stored in memory.
- 3** Pushing **TEST** button returns the display to usual display.

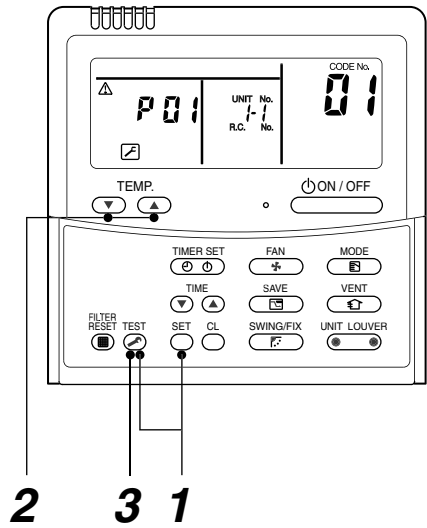

<Operation procedure>

1 → 2 → 3

Returned to usual display

REQUIREMENT

Do not push **CL** button, otherwise all the error histories of the indoor unit are deleted.

9-2. Group Control Operation

In a group control, operation of maximum 8 indoor units can be controlled by a remote controller. The indoor unit connected with outdoor unit (Individual/Master of twin) controls room temperature according to setting on the remote controller.

<System example>

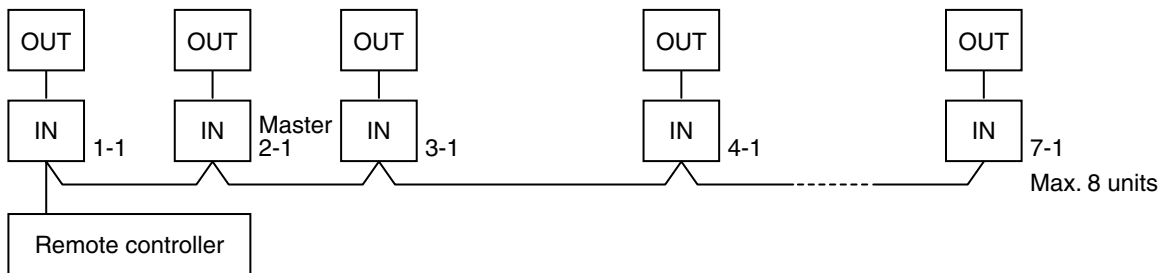

1. Display range on remote controller
The setup range (Operation mode/Air volume select/Setup temp) of the indoor unit which was set to the master unit is reflected on the remote controller.
2. Address setup
Turn on power of the indoor unit to be controlled in a group within 3 minutes after setting of automatic address. If power of the indoor unit is not turned on within 3 minutes (completion of automatic address setting), the system is rebooted and the automatic address setting will be judged again.
 - 1) Connect 3 In/Out cables surely.
 - 2) Check line address/indoor address/group address of the unit one by one.
 - 3) The unit No. (line/indoor gout address) which have been set once keep the present status as a rule if the unit No. is not duplicated with one of another unit.

■ Indoor unit power-ON sequence

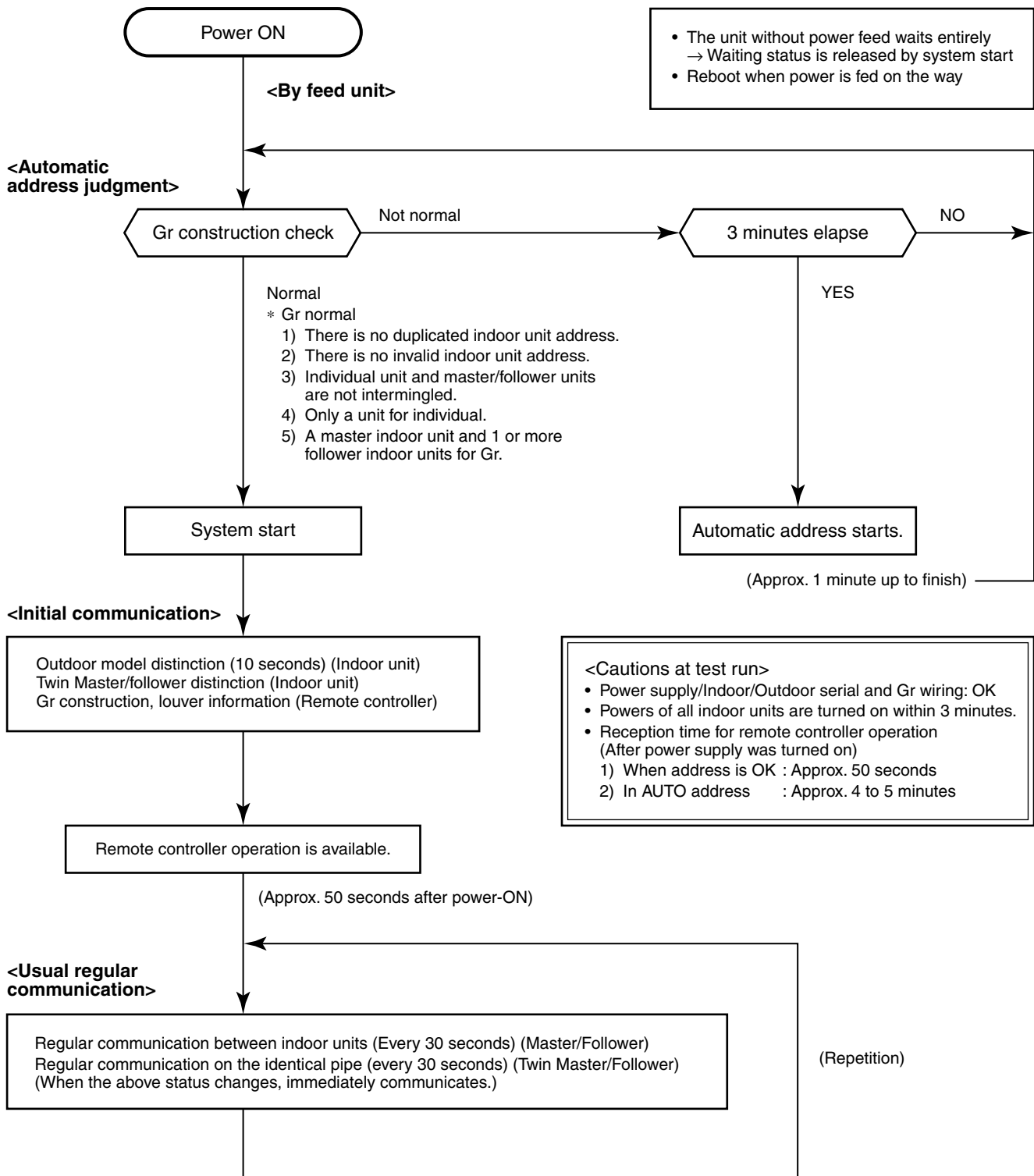

- In a group operation, if the indoor unit which was fed power after judgment of automatic address cannot receive regular communication from the master unit and regular communication on identical pipe within 120 seconds after power was turned on, it reboots (system reset).
→ The operation starts from judgment of automatic address (Gr construction check) again.
(If the address of the master unit was determined in the previous time, the power fed to the master unit and reboot works, the master unit may change though the indoor unit line address is not changed.)

9-3. Outdoor Unit

Various displays and various operations are enabled by push buttons (service) switches and LED on the outdoor control P.C. board.

Service switch (SW01, SW02) operations

LED display

- 4 patterns are provided for LED display.
○ : ON, ● : OFF, ◎ : Rapid flashing (5 times/second), ◇ : Slow flashing (Once/second)
- In the initial status of LED display, D805 is ON as the right figure.

When the initial status does not appear (in case of flashing of D805), LED display can be returned to the initial status by pushing and holding the service switches SW01 and SW02 for 5 seconds or more simultaneously.

LED display : initial status

● or ◎ D800 (Yellow)	● or ◎ D801 (Yellow)	● or ◎ D802 (Yellow)	● or ◎ D803 (Yellow)	● or ◎ D804 (Yellow)	○ D805 (Green)
----------------------------	----------------------------	----------------------------	----------------------------	----------------------------	----------------------

9-3-1. Refrigerant recovery control

HFC refrigerant is “Ozone layer destructive coefficient = 0”. However the discharge regulation is established for HFC refrigerant as it is greenhouse gas.

For this Model, a switch is mounted for refrigerant recovery operation (pump down) by the outdoor unit so that this Model can easily react to the environment when it will be reinstalled or scrapped.

[Operating method]

- 1) Set fan operation to the indoor unit.
- 2) Check LED display is the initial status. If it is not so, set the initial status.
- 3) Push and hold SW01 for 5 seconds or more and then check D804 flashes slowly.
- 4) Push SW01 several times and then stop it at the point where LED display (D800 to D804) is indicated as the following table.

D800	D801	D802	D803	D804
○	●	●	●	◎

- : ON, ● : OFF, ◎ : Rapid flashing (5 times/second)
- 5) Push SW02 so that D805 flashes rapidly.
 - 6) Push and hold SW02 for 5 seconds or more. The forced cooling operation starts if D804 flashes slowly and D805 is turned on. (Max. 10 minutes)
 - 7) After operation for 3 minutes or more, close the valve at liquid side.
 - 8) After recovery of refrigerant, close the valve at gas side.
 - 9) Push and hold SW01 and SW02 for 5 seconds or more simultaneously. The LED returns to the initial status, the cooling operation stops and the indoor fan operation stops.
 - 10) Turn off the power supply.
- * If an unknown point generated on the way of the operation, push and hold SW01 and SW02 for 5 seconds or more simultaneously. You can return to the item 2).

9-3-2. Various settings on outdoor unit (Existing piping etc.)

(1) Service switch setting

Various settings are available by setting service switches.

[Operating method]

- 1) Check LED display is the initial status. If it is not so, set the initial status.
- 2) Push and hold SW01 for 5 seconds or more and then check D804 flashes slowly.
- 3) Push SW01 several times and then stop it at the LED display of function item to be set up.

Function	LED display					Control contents																																				
Existing pipes setting	D800 ●	D801 ●	D802 ○	D803 ●	D804 ◎	When the existing piping uses Ø19.1 pipe, this function is validated. In this case, the heating capacity may drop due to outside temp. and indoor temp. in heating time.																																				
Snow-break fan control	D800 ●	D801 ○	D802 ●	D803 ●	D804 ◎	This function validates the control to prevent occurrence of motor lock by the accumulated snow entered from clearance of the fan guard or heat exchanger into blast route. Even when the compressor stops, the outdoor fan is operated with SM56, 80 : W3, SM110, 140 : W5 when the outside temperature is under 4°C.																																				
Max. frequency change	D800 ●	D801 ●	D802 ●	D803 ○	D804 ◎	This function is validated if the max. value of compressor frequency is required to lower. It lowers the max. frequency in cooling/heating time. In this case, the max. capacity lowers. Max. compressor frequency (rps) <table border="1" style="margin-top: 5px;"> <thead> <tr> <th rowspan="2">Model</th> <th colspan="2">SM56</th> <th colspan="2">SM80</th> <th colspan="2">SM110</th> <th colspan="2">SM140</th> </tr> <tr> <th>Cool</th> <th>Heat</th> <th>Cool</th> <th>Heat</th> <th>Cool</th> <th>Heat</th> <th>Cool</th> <th>Heat</th> </tr> </thead> <tbody> <tr> <td>Standard status</td> <td>70.8</td> <td>98.4</td> <td>100.2</td> <td>120.6</td> <td>78.6</td> <td>79.8</td> <td>92.4</td> <td>99.6</td> </tr> <tr> <td>When setting is valid</td> <td>70.8</td> <td>83.4</td> <td>100.2</td> <td>102.6</td> <td>63.6</td> <td>63.6</td> <td>79.8</td> <td>79.8</td> </tr> </tbody> </table>		Model	SM56		SM80		SM110		SM140		Cool	Heat	Cool	Heat	Cool	Heat	Cool	Heat	Standard status	70.8	98.4	100.2	120.6	78.6	79.8	92.4	99.6	When setting is valid	70.8	83.4	100.2	102.6	63.6	63.6	79.8	79.8
Model	SM56		SM80		SM110		SM140																																			
	Cool	Heat	Cool	Heat	Cool	Heat	Cool	Heat																																		
Standard status	70.8	98.4	100.2	120.6	78.6	79.8	92.4	99.6																																		
When setting is valid	70.8	83.4	100.2	102.6	63.6	63.6	79.8	79.8																																		

○ : ON, ● : OFF, ◎ : Rapid flashing (5 times/second)

- 4) Push SW02 so that D805 will flash rapidly.
 - 5) Push and hold SW02 for 5 seconds or more. D804 changes to slow flashing, D805 changes to lighting and then various settings are validated.
 - 6) When you want to continue the settings, moreover repeat items from 3) to 5).
 - 7) To invalidate various settings, execute items 1) to 3), push SW02 and then turn off D805.
 - 8) Push and hold SW02 for 5 seconds or more. D804 changes to slow flashing, D805 is turned off and then various settings are invalidated.
- * If an unknown point generated on the way of the operation, push and hold SW01 and SW02 for 5 seconds or more simultaneously. You can return to the item (1).

Confirmation method of various settings

You can confirm that various settings are validated.

- 1) Check LED displays are in the initial status. If it are not so, return them to the initial status.
- 2) Push and hold SW01 for 5 seconds or more. D804 changes to slow flashing.
- 3) Push SW01 several times and then stop it at the point where LED display (D800 to D804) to be checked. If the setting became valid, D804 and D805 flash rapidly. (When the setup was invalid, D804 flashes rapidly and D805 goes off.)
- 4) Push SW01 and SW02 for 5 seconds or more simultaneously to return LED display to the initial status.

In the case to return the setting to one at shipment from factory

When to return the setting to one at shipment from the factory due to reinstallation and so on, the setting can be returned in the following procedure.

- 1) Check LED display is the initial status. If it is not the initial status, return the setting to the initial status.
- 2) Push and hold SW01 for 5 seconds or more and then check D804 flashes slowly.
- 3) Push SW01 several times to make LED display status to "LED display to return the setting at shipment from the factory" in the right table.
- 4) Push and hold SW02 for 5 seconds or more and then check D804 flashes slowly.
- 5) Push and hold SW01 and SW02 simultaneously to return the LED display to the initial status.

LED display to return the setting at shipment from the factory					
D800	D801	D802	D803	D804	D805
●	●	●	●	○	●

○: ON, ●: OFF,
 ◎: Rapid flashing (5 times/second)

(2) Operation mode for cooling only/heating only

As for the indoor unit, the mode for cooling only/heating only is applied from the Ceiling 7 series.

When a group operates and twin operating, the indoor unit (master unit) connected with the outdoor unit is set to the header unit.

▼ Functions

The heating only (cooling only) mode can be selected by the sub P.C. board of outdoor unit.

State	Details of Processing		
(Factory default)	Operation mode	Operation State	Remote control
	Normal	AUTO, COOL, DRY, HEAT, FAN ONLY or can be selected	-
Sub P.C. board setting	The heating only (cooling only) mode can be selected by the sub P.C. board of outdoor unit.		
	P.C. board selection mode	Remote control operation/display	
	Normal	AUTO, COOL, DRY, HEAT, FAN ONLY or can be selected	-
	Cooling only	COOL, DRY, FAN ONLY or can be selected	When using the remote control,  (Operation mode controlled) indicator might be lit displayed.
Heating only	HEAT, FAN ONLY or can be selected		
	• The remote controller display becomes "AUTO", "COOL", "Dry", "HEAT", and "FAN ONLY" according to the connection and the indoor unit even if it sets for heating only. The compressor is a stop though the indoor fan works when "AUTO-cooling", "COOL", and "Dry" are selected.		

Setting/cancel method of operation mode for cooling only/heating only

The setting/cancel are done by operating the switch (SW01 and SW02) on the sub P.C. board of outdoor unit.

<SM56, 80 type>

LED displays					
D800	D801	D802	D803	D804	D805
○	○	○	○	○	○
(Yellow)	(Yellow)	(Yellow)	(Yellow)	(Yellow)	(Green)

- There are four LEDs display patterns.
- : ON
- : OFF
- ◎: Rapid flashing (5 times/sec.)
- ◇: Slow flashing (1 time/sec.)

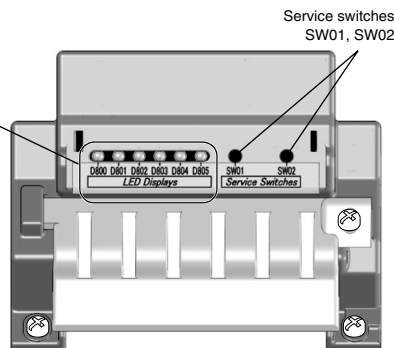

<SM110, 140 type>

LED displays					
D800	D801	D802	D803	D804	D805
○	○	○	○	○	○
(Yellow)	(Yellow)	(Yellow)	(Yellow)	(Yellow)	(Green)

- There are four LEDs display patterns.
- : ON
- : OFF
- ◎: Rapid flashing (5 times/sec.)
- ◇: Slow flashing (1 time/sec.)

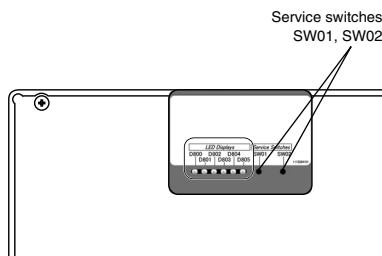

■ Setting method

1. Check the LED display is an initial state. (Fig. 1)
If the initial status is not established (if D805 is flashing), hold down the SW01 and SW02 service switches simultaneously for at least 5 seconds to return the LED displays to the initial status.
2. Hold down SW01 for at least 5 seconds, and check that D804 flashes slowly. (Fig. 2)
3. Several times press SW01 to set the LED displays of the selection mode shown below. (Fig. 3)
4. Press SW02, D805 is rapid flashing. (Fig. 4)
5. Hold down SW02 for at least 5 seconds, and when D804 flashes slowly and D805 lights, and the setting is completed. (Fig. 5)

※If there is any trouble, hold down SW01 and SW02 simultaneously for at least 5 seconds to return to the initial status, and then repeat the steps.

There are four LEDs display patterns. ○: ON, ●: OFF, ◎: Rapid flashing (5 times/sec.)

(Fig. 1)

◇: Slow flashing (1 time/sec.)

LED display initial status					
D800	D801	D802	D803	D804	D805
● or ◎	● or ◎	● or ◎	● or ◎	● or ◎	○
OFF or Rapid flashing	OFF or Rapid flashing	OFF or Rapid flashing	OFF or Rapid flashing	OFF or Rapid flashing	ON

(Fig. 2)

Procedure 2. LED display					
D800	D801	D802	D803	D804	D805
○	●	●	●	◇	●
ON	OFF	OFF	OFF	Slow flashing	OFF

(Fig. 3)

Selection mode	Procedure 3. LED display					
	D800	D801	D802	D803	D804	D805
Cooling only	○	○	●	●	◎	●
	ON	ON	OFF	OFF	Rapid flashing	OFF
Heating only	○	○	○	○	◎	●
	ON	ON	ON	ON	Rapid flashing	OFF

(Fig. 4)

Selection mode	Procedure 4. LED display					
	D800	D801	D802	D803	D804	D805
Cooling only	○	○	●	●	◎	◎
	ON	ON	OFF	OFF	Rapid flashing	Rapid flashing
Heating only	○	○	○	○	◎	◎
	ON	ON	ON	ON	Rapid flashing	Rapid flashing

(Fig. 5)

Selection mode	Procedure 5. LED display					
	D800	D801	D802	D803	D804	D805
Cooling only	○	○	●	●	◇	○
	ON	ON	OFF	OFF	Slow flashing	ON
Heating only	○	○	○	○	◇	○
	ON	ON	ON	ON	Slow flashing	ON

■ Cancel

1. 1. and 2. of the setting methods are executed.
2. Several times press SW01 to set the LED displays of the selection mode shown below. (Fig. 6)
3. Press SW02, D805 is turned off. (Fig. 7)
4. Hold down SW02 for at least 5 seconds, and when D804 flashes slowly and D805 lights, and the setting is completed. (Fig. 8)

(Fig. 6)

Selection mode	Procedure 2. LED display					
	D800	D801	D802	D803	D804	D805
Cooling only	○	○	●	●	⊙	⊙
	ON	ON	OFF	OFF	Rapid flashing	Rapid flashing
Heating only	○	○	○	○	⊙	⊙
	ON	ON	ON	ON	Rapid flashing	Rapid flashing

(Fig. 7)

Selection mode	Procedure 3. LED display					
	D800	D801	D802	D803	D804	D805
Cooling only	○	○	●	●	⊙	●
	ON	ON	OFF	OFF	Rapid flashing	OFF
Heating only	○	○	○	○	⊙	●
	ON	ON	ON	ON	Rapid flashing	OFF

(Fig. 8)

Selection mode	Procedure 4. LED display					
	D800	D801	D802	D803	D804	D805
Cooling only	○	○	●	●	◇	●
	ON	ON	OFF	OFF	Slow flashing	OFF
Heating only	○	○	○	○	◇	●
	ON	ON	ON	ON	Slow flashing	OFF

9-3-3. Service support function (LED display, service switch operating method)

1. LED display switching

1-1. Display switching list

The displayed contents of LED D800 to D805 on the outdoor P.C. board can be switched by handling the service switches SW01 and SW02.

[Operating method]

- 1) Check LED display is the initial status. If it is not so, set the initial status.
- 2) Push SW01 several times and then stop it at the point where LED display to be indicated.

LED display						Control contents
D800	D801	D802	D803	D804	D805	Error display (Error which is occurring at present) The error which is occurring at present is displayed. LED goes off while an error does not occur. (Refer to table A)
●	●	●	●	●	○	
D800	D801	D802	D803	D804	D805	Error display (The latest error: The latest error including this moment) After error status was eliminated, if you want to check the error which occurred before, call this setting and check it. (Even after turning off the power supply once, you can recheck it.) * In the case that an error occurred at present, the same contents as that at present is displayed. * TO sensor error only is not displayed in this setting. (Check setting which is occurring at present.) (Refer to table B)
○	●	●	●	●	○	
D800	D801	D802	D803	D804	D805	Discharge temperature sensor (TD) display Detected value of the discharge temperature (TD) is displayed. (Refer to table C)
●	○	●	●	●	○	
D800	D801	D802	D803	D804	D805	Outdoor heat exchanger temperature sensor (TE) display Detected value of the outdoor heat exchanger temperature sensor (TE) is displayed. (Refer to table C)
○	○	●	●	●	○	
D800	D801	D802	D803	D804	D805	Liquid temperature sensor (TL) display The detected value of the liquid temperature sensor (TL) is displayed. (Refer to table C)
●	○	○	●	●	○	
D800	D801	D802	D803	D804	D805	Suction temperature sensor (TS) display Detected value of the suction temperature sensor (TS) is displayed. (Refer to table C)
●	●	○	●	●	○	
D800	D801	D802	D803	D804	D805	Outside temperature sensor (TO) display Detected value of the outside temperature sensor (TO) is displayed. (Refer to table C)
○	●	○	●	●	○	
D800	D801	D802	D803	D804	D805	Heat sink temperature sensor (TH) display Detected value of the heat sink temperature sensor (TH) is displayed. (Refer to table C)
○	○	○	●	●	○	
D800	D801	D802	D803	D804	D805	Current display The current value which flows to the outdoor unit is displayed. (Refer to table C)
○	●	●	○	●	○	
D800	D801	D802	D803	D804	D805	Compressor operation frequency display The operation frequency of the compressor is displayed. (Refer to table C)
●	○	●	○	●	○	
D800	D801	D802	D803	D804	D805	PMV opening display The opening of PMV (Electronic expansion valve) is displayed. (Refer to table C)
○	○	●	○	●	○	
D800	D801	D802	D803	D804	D805	Indoor suction temperature sensor (TA) display The detected value of the indoor suction temperature sensor (TA) is displayed. (Refer to table C)
●	●	○	○	●	○	
D800	D801	D802	D803	D804	D805	Indoor heat exchanger temperature sensor (TC) display The detected value of the indoor heat exchanger temperature sensor (TC) is displayed. (Refer to table C)
○	●	○	○	●	○	
D800	D801	D802	D803	D804	D805	Indoor heat exchanger temperature (TCJ) display The detected value of the indoor heat exchanger temperature sensor (TCJ) is displayed. (Refer to table C)
○	●	○	○	●	○	

○ : ON, ● : OFF, ◎ : Rapid flashing (5 times/second)

- 3) Pushing SW02 changes item to one to be displayed.
- 4) To see other display contents, repeat items 1) to 3).
- 5) To finish LED display, be sure to execute item 1) to return LED to the initial status (error display of current occurrence) and then finish LED display.

1-2. Error display

The error which is occurring at present and the latest error (the latest error data including one which is occurring now) can be confirmed by lighting LED D800 to D805 on the outdoor control P.C. board.

A. Error display which occurs at present

LED display						Error name	Wired remote controller error code
D800	D801	D802	D803	D804	D805		
●	●	●	●	●	○	Normal	—
○	●	●	●	●	○	Discharge temp. sensor (TD) error	F04
●	○	●	●	●	○	Heat exchanger temp. sensor (TE) error	F06
○	○	●	●	●	○	Liquid temp. sensor (TL) error	F07
●	●	○	●	●	○	Outside temp. sensor (TO) error	F08
○	●	○	●	●	○	Suction temp. sensor (TS) error	F12
●	○	○	●	●	○	Heat sink temp. sensor (TH) error	F13
○	○	○	●	●	○	Heat exchanger sensor (TE, TS) misconnection	F15
●	○	●	○	●	○	EEPROM error	F31
○	○	●	○	●	○	Compressor breakdown	H01
●	●	○	○	●	○	Compressor lock	H02
●	○	○	○	●	○	Case thermostat operation	H04
●	●	●	●	○	○	Model unset	L10
●	○	●	●	○	○	Discharge temp. error	P03
○	○	●	○	○	○	High-pressure SW error	P04
○	●	○	○	●	○	Current detection circuit error	H03
○	●	○	●	○	○	Power supply error	P05
●	○	○	●	○	○	Heat sink overheat error	P07
○	○	○	●	○	○	Gas leak detection	P15
●	●	●	○	○	○	4-way valve reversal error	P19
○	●	●	○	○	○	High pressure protective operation	P20
●	○	●	○	○	○	Fan system error	P22
○	○	●	○	○	○	Driving element short circuit	P26
●	●	○	○	○	○	Position detection circuit error	P29
○	●	○	○	○	○	Others (No determination)	L31

○ : ON, ● : OFF, ◎ : Rapid flashing (5 times/second)

B. Error display of the latest (including error which occurs at present) error

LED display						Error name
D800	D801	D802	D803	D804	D805	
●	●	●	●	●	◇	Normal
○	●	●	●	●	◇	Discharge temp. sensor (TD) error
●	○	●	●	●	◇	Heat exchanger temp. sensor (TE) error
○	○	●	●	●	◇	Liquid temp. sensor (TL) error
○	●	○	●	●	◇	Suction temp. sensor (TS) error
●	○	○	●	●	◇	Heat sink temp. sensor (TH) error
○	○	○	●	●	◇	Heat exchanger sensor (TE, TS) misconnection
●	○	●	○	●	◇	EEPROM error
○	○	●	○	●	◇	Compressor breakdown
●	●	○	○	●	◇	Compressor lock
●	○	○	○	●	◇	Case thermostat operation
●	●	●	●	●	◇	Model unset
●	○	●	●	○	◇	Discharge temp. error
○	○	●	○	○	◇	High-pressure SW error
○	●	○	○	●	◇	Current detection circuit error
○	●	○	●	○	◇	Power supply error
●	○	○	●	○	◇	Heat sink overheat error
○	○	○	●	○	◇	Gas leak detection
●	●	●	○	○	◇	4-way valve reversal error
○	●	●	○	○	◇	High pressure protective operation
●	○	●	○	○	◇	Fan system error
○	○	●	○	○	◇	Driving element short circuit
●	●	○	○	○	◇	Position detection circuit error
○	●	○	○	○	◇	Others (No determination)

○ : ON, ● : OFF, ◎ : Rapid flashing (5 times/second), ◇ : Slow flashing (Once/second)

C. Sensor, current, compressor operation frequency, PMV opening display

The values, such as the temperature sensor or the current value, which the controller detects are easily confirmed.

* Temperature sensor: TD, TE, TL, TS, TO, TH, TA, TC, TCJ

LED display						Temp. sensor (°C)	Current (A)	Compressor frequency (rps)	PMV opening (pls)
D800	D801	D802	D803	D804	D805				
●	●	●	●	●	◇	- 25 or less	0 ~	0 ~	0 ~ 19
○	●	●	●	●	◇	- 25 ~	1 ~	5 ~	20 ~ 39
●	○	●	●	●	◇	- 20 ~	2 ~	10 ~	40 ~ 59
○	○	●	●	●	◇	- 15 ~	3 ~	15 ~	60 ~ 79
●	●	○	●	●	◇	- 10 ~	4 ~	20 ~	80 ~ 99
○	●	○	●	●	◇	- 5 ~	5 ~	25 ~	100 ~ 119
●	○	○	●	●	◇	0 ~	6 ~	30 ~	120 ~ 139
○	○	○	●	●	◇	5 ~	7 ~	35 ~	140 ~ 159
●	●	●	○	●	◇	10 ~	8 ~	40 ~	160 ~ 179
○	●	●	○	●	◇	15 ~	9 ~	45 ~	180 ~ 199
●	○	●	○	●	◇	20 ~	10 ~	50 ~	200 ~ 219
○	○	●	○	●	◇	25 ~	11 ~	55 ~	220 ~ 239
●	●	○	○	●	◇	30 ~	12 ~	60 ~	240 ~ 259
○	●	○	○	●	◇	35 ~	13 ~	65 ~	260 ~ 279
●	○	○	○	●	◇	40 ~	14 ~	70 ~	280 ~ 299
○	○	○	○	●	◇	45 ~	15 ~	75 ~	300 ~ 319
●	●	●	●	○	◇	50 ~	16 ~	80 ~	320 ~ 339
○	●	●	●	○	◇	55 ~	17 ~	85 ~	340 ~ 359
●	○	●	●	○	◇	60 ~	18 ~	90 ~	360 ~ 379
○	○	●	●	○	◇	65 ~	19 ~	95 ~	380 ~ 399
●	●	○	●	○	◇	70 ~	20 ~	100 ~	400 ~ 419
○	●	○	●	○	◇	75 ~	21 ~	105 ~	420 ~ 439
●	○	○	●	○	◇	80 ~	22 ~	110 ~	440 ~ 459
○	○	○	●	○	◇	85 ~	23 ~	115 ~	460 ~ 479
●	●	●	○	○	◇	90 ~	24 ~	120 ~	480 ~ 499
○	●	●	○	○	◇	95 ~	25 ~	125 ~	500
●	○	●	○	○	◇	100 ~	26 ~	130 ~	-
○	○	●	○	○	◇	105 ~	27 ~	135 ~	-
●	●	○	○	○	◇	110 ~	28 ~	140 ~	-
○	●	○	○	○	◇	115 ~	29 ~	145 ~	-
●	○	○	○	○	◇	120 or more	30 ~	150 ~	-
○	○	○	○	○	◇	Sensor error	31 or more	155 or more	-

○ : ON, ● : OFF, ◇ : Slow flashing (Once/second)

2. Special operation for maintenance check (SW01 and SW02 operations)

The following special operations for maintenance check can be performed by handling the service switches SW01 and SW02.

[Operating method]

- 1) Check LED display is the initial status. If it is not so, set the initial status.
- 2) Push and hold SW01 for 5 seconds or more and then check D804 flashes slowly.
- 3) Push SW01 and then stop it at the LED display of the function item to be set.

Special operation	LED display					Control contents
Refrigerant recovery operation	D800 ○	D801 ●	D802 ●	D803 ●	D804 ◎	The outdoor unit performs cooling operation. As the indoor unit does not operate by this operation only, carry out the fan operation beforehand. (Refer to 9-3-1.)
PMV full open operation	D800 ○	D801 ●	D802 ○	D803 ●	D804 ◎	Open PMV (Electronic expansion valve) fully. Execute the following item 6) or the control returns to normal operation after 2 minutes. (Refer Note 1)
PMV full close operation	D800 ●	D801 ○	D802 ○	D803 ●	D804 ◎	Close PMV (Electronic expansion valve) completely. Execute the following item 6) or the control returns to normal operation after 2 minutes. (Refer Note 1)
PMV middle opening operation	D800 ○	D801 ○	D802 ○	D803 ●	D804 ◎	Open PMV (Electronic expansion valve) to middle position (250 pulses). Execute the following item 6) or the control returns to normal operation after 2 minutes. (Refer Note 1)
Indoor heating trial operation command	D800 ○	D801 ●	D802 ●	D803 ○	D804 ◎	Carry out a trial heating operation. The operation returns to the normal control by executing the following item 6). (Refer Note 2)
Indoor cooling trial operation command	D800 ●	D801 ○	D802 ●	D803 ○	D804 ◎	Carry out a trial cooling operation. The operation returns to the normal control by executing the following item 6). (Refer Note 2)
Fan motor forced operation	D800 ○	D801 ○	D802 ●	D803 ○	D804 ◎	Operate the fan motor forcedly. Execute the following item 6) or the control returns to normal operation after 2 minutes. (Refer Note 1)
Self-preservation valve suck operation	D800 ○	D801 ●	D802 ○	D803 ○	D804 ◎	SM56, 80 : switch to cooling cycle This function is operated only by ten seconds, and turned off afterwards.
						SM110, 140 : switch to heating cycle This function is operated only by ten seconds, and turned off afterwards.
Self-preservation valve secession operation	D800 ●	D801 ○	D802 ○	D803 ○	D804 ◎	SM56, 80 : switch to heating cycle This function is operated only by ten seconds, and turned off afterwards.
						SM110, 140 : switch to cooling cycle This function is operated only by ten seconds, and turned off afterwards.

○ : ON, ● : OFF, ◎ : Rapid flashing (5 times/second)

(Note 1) Although these special operations are available even operating time, basically carry out these operations while the machine stops. If carrying out these operations, the pressure may change suddenly and a danger may grow.

(Note 2) Indoor trial cooling operation request / Indoor trial heating operation request

Cooling/heating trial operations are available from the outdoor unit only in combination with the following indoor units.

Trial operation is available: Indoor units after 4 series (RAV-SM****4*T*)

Trial operation is unavailable: Indoor units except the above units or in case that the indoor units except the above units are included at twin connection.

Note) The forced trial operation in this setting cannot be cleared by the indoor remote controller. Be sure to clear it by operation of the outdoor unit (6 below).

- 4) Push SW02 and then stop it at point where D805 becomes rapid flashing.
- 5) Push and hold SW02 for 5 seconds or more. D804 changes to slow flashing, D805 changes lighting and then the special operation becomes valid.
- 6) To invalidate various settings, push and hold SW01 and SW02 for 5 seconds or more simultaneously. D800 to D804 go off (or rapid flashing), D805 goes on (Initial status: Display of error which is occurring at present), and then the special operation becomes invalid (normal control).

* If an unknown point generated on the way of the operation, push and hold SW01 and SW02 for 5 seconds or more simultaneously. You can return to the item 1).

9-4. Applicable Control of Outdoor unit

The following controls are enabled by connecting the part "Application control kit" (TCB-PCOS1E2) sold separately.

(1) Power peak cut control

* The capacity of the outdoor unit is saved by the Demand signal from outside and corresponds to the temporary peak cut.

* The capacity save is switched to 3 stages, 75%, 50% and operation stop.

(2) Night operation (Sound reduction)

* Input a timer on the market (Arranged at site). The capacity is lowered regardless of load and the operation noise is reduced until 45dB. However the normal control is carried out if the outside temperature (TO sensor value) is 40°C or more.

(3) Compressor operation output

* When the compressor drives, turn on the contact output of no voltage.

10. ADDRESS SETUP

10-1. Address Setup Procedure

When an outdoor unit and an indoor unit are connected, or when an outdoor unit is connected to each indoor unit respectively in the group operation even if multiple refrigerant lines are provided, the automatic address setup completes with power-ON of the outdoor unit. The operation of the remote controller is not accepted while automatic address works. (Approx. 4 to 5 minutes)

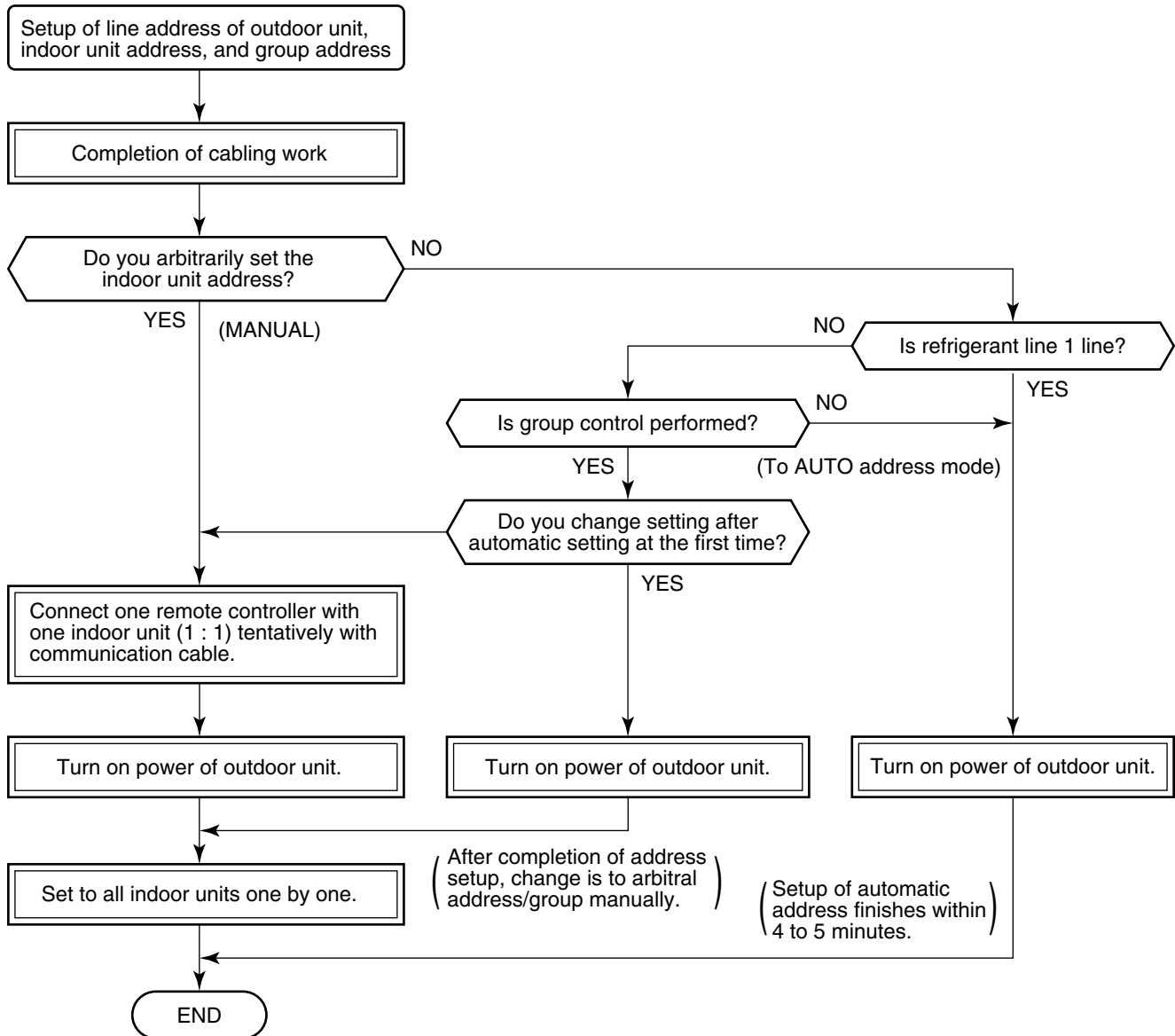

- When the following addresses are not stored in the neutral memory (IC503) on the indoor P.C. board, a test run operation cannot be performed. (Unfixed data at shipment from factory)

	Item code	Data at shipment	Setup data range
Line address	12	0099	0001 (No. 1 unit) to 0064 (No. 64 unit)
Indoor unit address	13	0099	0001 (No. 1 unit) to 0064 (No. 64 unit) Max. value of indoor units in the identical refrigerant line
Group address	14	0099	0000 : Individual (Indoor units which are not controlled in a group) 0001 : Master unit (1 indoor unit in group control) 0002 : Sub unit (Indoor units other than master unit in group control)

10-2. Address Setup & Group Control

<Terminology>

Indoor unit No. : N - n = Outdoor unit line address N (Max. 30) - Indoor unit address n (Max. 64)

Group address : 0 = Single (Not group control)
 1 = Master unit in group control
 2 = Sub unit in group control

Master unit (= 1) : The representative of multiple indoor units in group operation sends/receives signals to/from the remote controllers and sub indoor units.
 (* It has no relation with an indoor unit which communicates serially with the outdoor units.)
 The operation mode and setup temperature range are displayed on the remote controller LCD.
 (Except air direction adjustment of louver)

Sub unit (= 2) : Indoor units other than master unit in group operation
 Basically, sub units do not send/receive signals to/from the remote controllers.
 (Except errors and response to demand of service data)

Header unit (Representative unit) (Master Twin)

: This unit communicates with the indoor unit (follower) which serial-communicates with the outdoor units and sends/receives signal (Command from compressor) to/from the outdoor units as the representative of the cycle control in the indoor units of the identical line address within the minimum unit which configures one of the refrigerating cycles of Twin.

Follower unit (Subordinate unit) (Sub Twin)

: Indoor units excluding the header unit in Twin
 This unit communicates with (Header) indoor unit in the identical line address and performs control synchronized with (Header) indoor unit.
 This unit does not perform the signal send/receive operation with the outdoor units. :
 No judgment for serial signal error.

10-2-1. System Configuration

1. Single

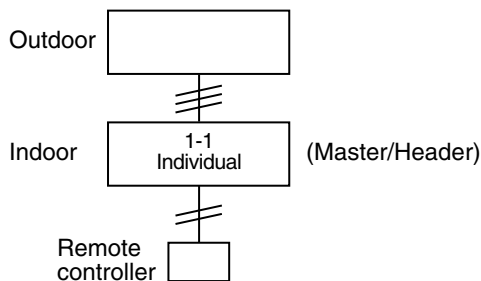

2. Twin

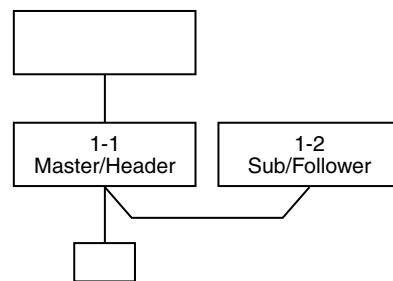

3. Single group operation

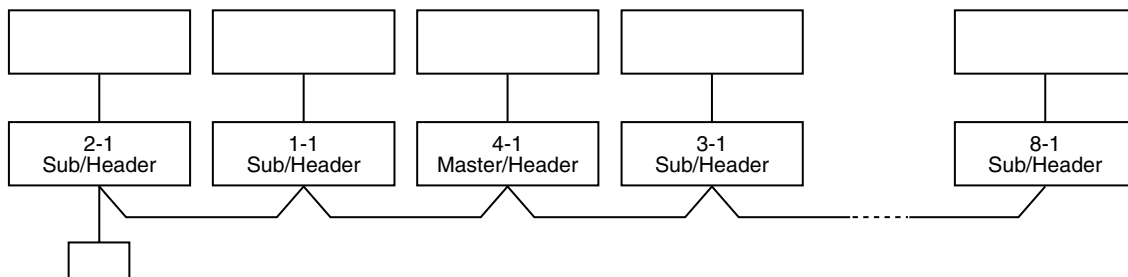

10-2-2. Automatic Address Example from Unset Address (No miswiring)

1. Standard (One outdoor unit)

1) Single

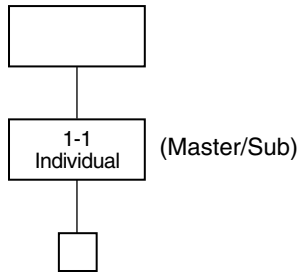

2) Group operation (Twin operation)

(Multiple outdoor units = Multiple indoor units only with serial communication)

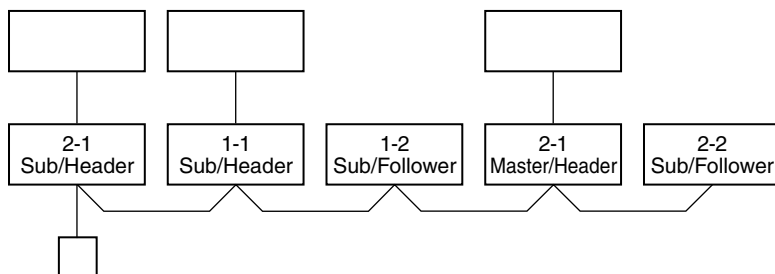

Only turning on source power supply (Automatic completion)

- Header unit: The header unit receives the indoor unit data (thermo status) of the follower (Without identical line address & indoor/outdoor serial) and then finally controls the outdoor compressor matching with its own thermo status.
The header unit sends this command information to the follower unit.
- Follower unit: The follower unit receives the indoor unit data from the header (With identical line address & indoor/outdoor serial) and then performs the thermo operation synchronized with the header unit.
The follower unit sends own thermo ON/OFF demand to the header unit.

(Example)

No. 1-1 header unit sends/receives signal to/from No. 1-2 and No. 1-3 follower units.
(It is not influenced by the line 2 or 3 address indoor unit.)

10-2-3. Automatic Address Example from Unset Address (No miswiring)

1. Standard (One outdoor unit)

- 1) Single
- 2) Twin

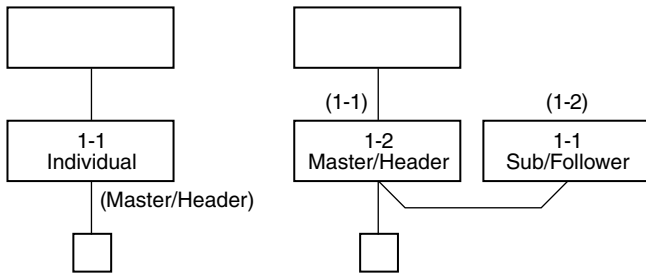

Only turning on source power supply (Automatic completion)

2. Group operation

(Multiple outdoor units = Multiple indoor units with serial communication only, without twin)

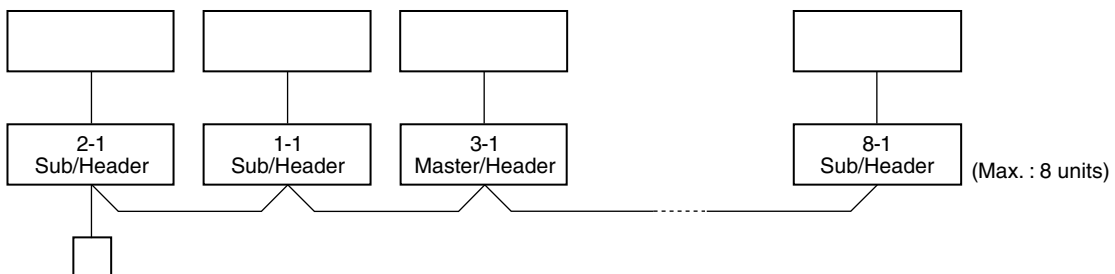

Only turning on source power supply (Automatic completion)

3. Multiple groups operation

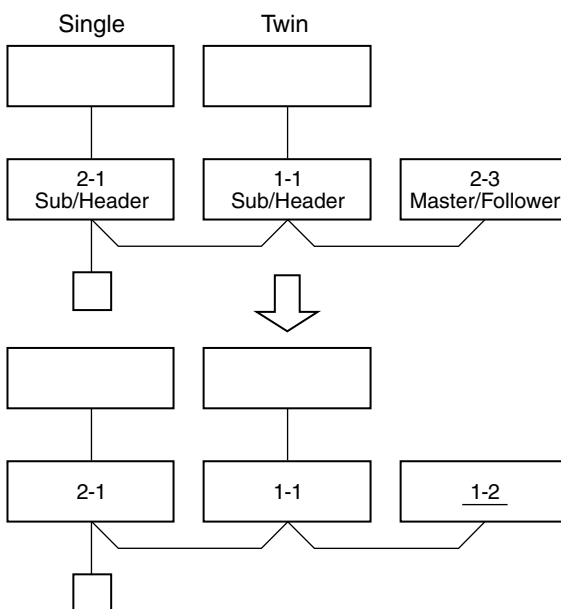

Change is necessary

Manually change addresses of the multiple follower units simultaneously from the remote controller.

10-3. Remote Controller Wiring

- Strip off approx. 9 mm the wire to be connected.
- For single system, use non polarity, 2 core wire is used for wiring of the remote controller. (0.5 mm² to 2.0 mm² wires)
- For the synchronous twin, triple system, use 2-core shield wire (Vinyl cord for microphone 0.5 to 2.0 mm²) to conform to the EMC standard.

Wiring diagram

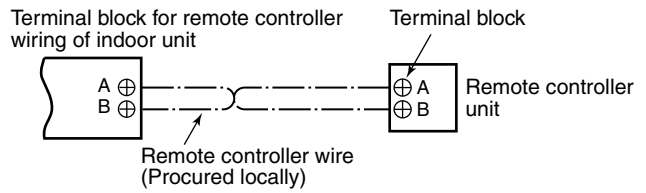

* For details of wiring/installation of the remote controller, refer to the Installation Manual enclosed with the remote controller.

Single system

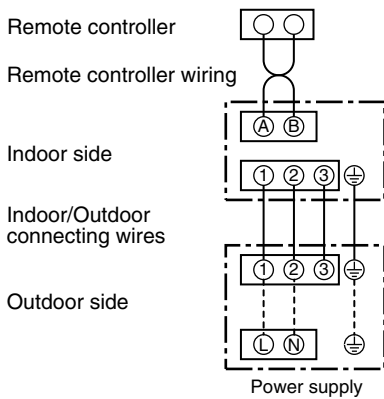

Simultaneous twin system

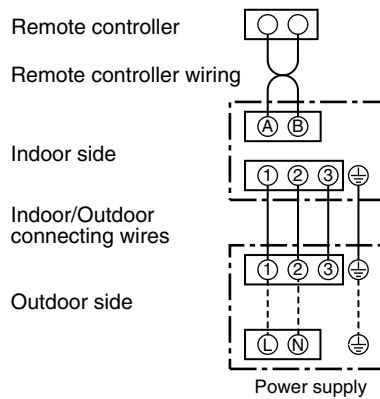

10-4. Address Setup (Manual setting from remote controller)

In case that addresses of the indoor units will be determined prior to piping work after cabling work

- Set an indoor unit per a remote controller.
- Turn on power supply.

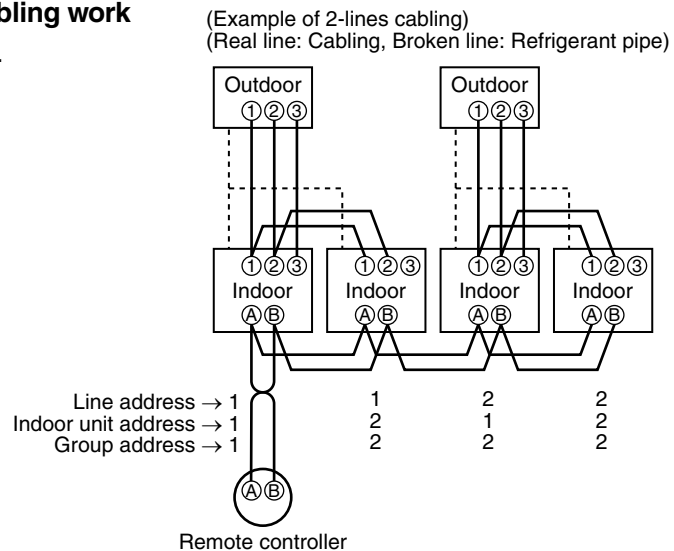

For the above example, perform setting by connecting singly the wired remote controller without remote controller inter-unit cable.

Group address
 Individual : 0000
 Master unit : 0001
 Sub unit : 0002 } In case of group control

- 1** Push **SET** + **CL** + **TEST** buttons simultaneously for 4 seconds or more.
- 2** (← Line address)
Using the temperature setup **▼** / **▲** buttons, set **12** to the CODE No.
- 3** Using timer time **▼** / **▲** buttons, set the line address.
- 4** Push **SET** button. (OK when display goes on.)
- 5** (← Indoor unit address)
Using the temperature setup **▼** / **▲** buttons, set **13** to the CODE No.
- 6** Using timer time **▼** / **▲** buttons, set 1 to the line address.
- 7** Push **SET** button. (OK when display goes on.)
- 8** (← Group address)
Using the temperature setup **▼** / **▲** buttons, set **14** to the CODE No.
- 9** Using timer time **▼** / **▲** buttons, set **0000** to Individual, **0001** to Master unit, and **0002** to sub unit.
- 10** Push **SET** button. (OK when display goes on.)
- 11** Push **TEST** button.
Setup completes. (The status returns to the usual stop status.)

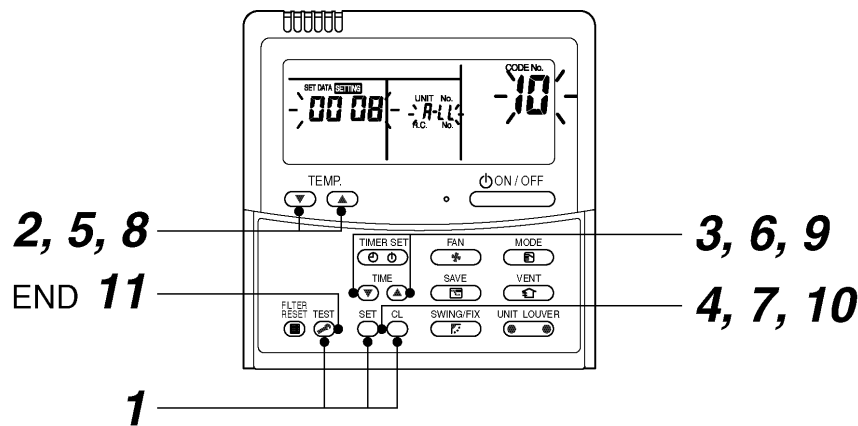

<Operation procedure>

1 → 2 → 3 → 4 → 5 → 6 → 7 → 8 → 9 → 10 → 11 END

10-5. Confirmation of Indoor Unit No. Position

1. To know the indoor unit addresses though position of the indoor unit body is recognized

- In case of individual operation (Wired remote controller : indoor unit = 1 : 1)
(Follow to the procedure during operation)

<Procedure>

- 1** Push **ON/OFF** button if the unit stops.
- 2** Push **UNIT LOUVER** button.

Unit No. **1-1** is displayed on LCD.

(It disappears after several seconds.)

The displayed unit No. indicate line address and indoor unit address.

(When other indoor units are connected to the identical remote controller (Group control unit), other unit numbers are also displayed every pushing **UNIT LOUVER** button.

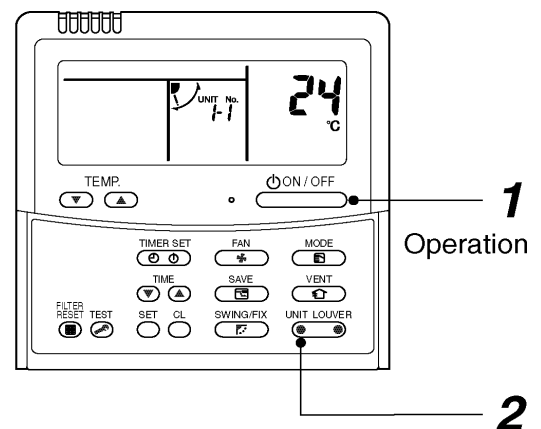

<Operation procedure>

1 → 2 END

2. To know the position of indoor unit body by address

- To confirm the unit No. in the group control
(Follow to the procedure during operation) (in this procedure, the indoor units in group control stop.)

<Procedure>

The indoor unit numbers in the group control are successively displayed, and fan, louver, and drain pump of the corresponding indoor unit are turned on.
(Follow to the procedure during operation)

- Push **VENT** and **TEST** buttons simultaneously for 4 seconds or more.
 - Unit No. **ALL** is displayed.
 - Fans and louvers of all the indoor units in the group control operate.
- Every pushing **UNIT LOUVER** button, the unit numbers in the group control are successively displayed.
 - The unit No. displayed at the first time indicates the master unit address.
 - Fan and louver of the selected indoor unit only operate.
- Push **TEST** button to finish the procedure.
All the indoor units in the group control stop.

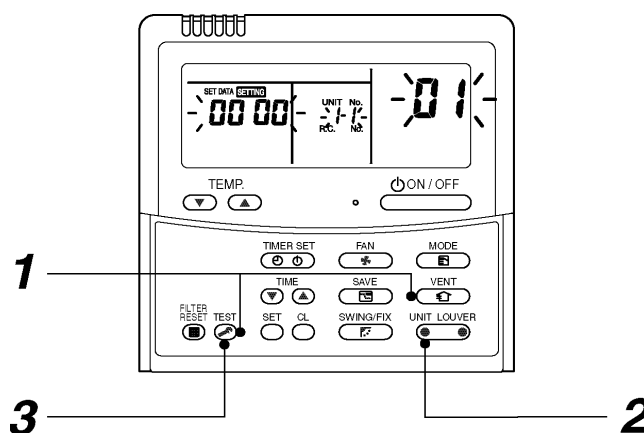

<Operation procedure>

1 → 2 → 3 END

<Maintenance/Check list>

Aiming in environmental preservation, it is strictly recommended to clean and maintain the indoor/outdoor units of the operating air conditioning system regularly to secure effective operation of the air conditioner.

It is also recommended to maintain the units once a year regularly when operating the air conditioner for a long time.

Check periodically signs of rust or scratches, etc. on coating of the outdoor units.

Repair the defective position or apply the rust resisting paint if necessary.

If an indoor unit operates for approx. 8 hours or more per day, usually it is necessary to clean the indoor/outdoor units once three months at least.

These cleaning and maintenance should be carried out by a qualified dealer.

Although the customer has to pay the charge for the maintenance, the life of the unit can be prolonged.

Failure to clean the indoor/outdoor units regularly will cause shortage of capacity, freezing, water leakage or trouble on the compressor.

Part name	Object		Contents of check	Contents of maintenance
	Indoor	Outdoor		
Heat exchanger	○	○	• Blocking with dust, damage check	• Clean it when blocking is found.
Fan motor	○	○	• Audibility for sound	• When abnormal sound is heard
Filter	○	—	• Visual check for dirt and breakage	• Clean with water if dirty • Replace if any breakage
Fan	○	○	• Visual check for swing and balance • Check adhesion of dust and external appearance.	• Replace fan when swinging or balance is remarkably poor. • If a large dust adheres, clean it with brush or water.
Suction/ Discharge grille	○	—	• Visual check for dirt and scratch	• Repair or replace it if deformation or damage is found.
Drain pan	○	—	• Check blocking by dust and dirt of drain water.	• Clean drain pan, Inclination check
Face panel, Louver	○	—	• Check dirt and scratch.	• Cleaning/Coating with repair painting
External appearance	—	○	• Check rust and peeling of insulator • Check peeling and floating of coating film	• Coating with repair painting

11. REPLACEMENT OF THE SERVICE P.C. BOARD

11-1-1. RAV-SM564AT*P*, SM804AT*P* (MCC-1645)

WARNING

Don't open the inverter cover before 1 minute after power has been turned off because an electric shock may be occurred.

Replacement steps:

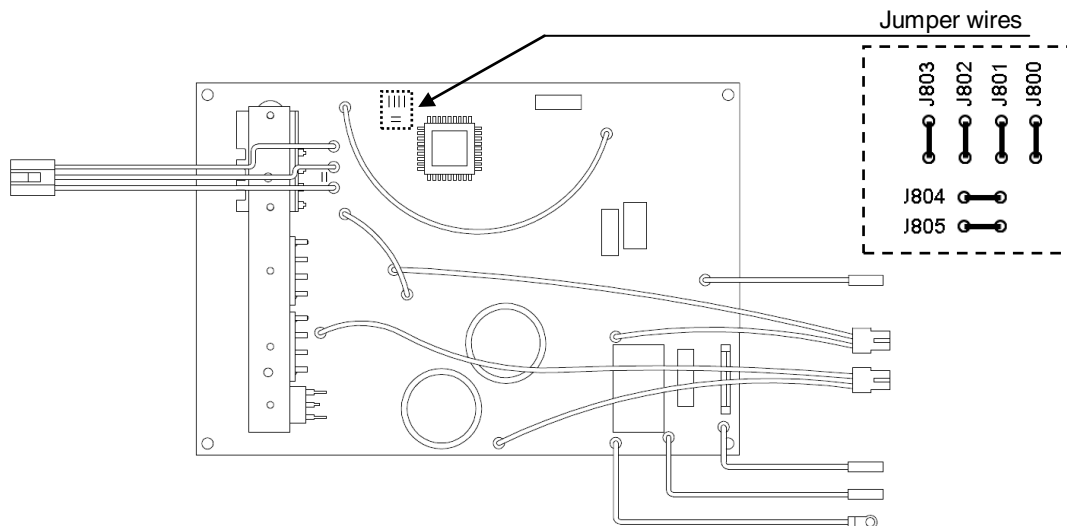

1 Jumper wires “J800~J803”

Cut the jumper wires of the service board, as instructed in the table below.

The jumper setting of J800~J803 differs from original supplied P.C.Board, therefore be sure to configure the jumpers as in the table below. If the model is not specified, the equipment will not operate.

Model name	J800	J801	J802	J803	
Service P.C. Board	○	○	○	○	○ : Connected
RAV-SM564AT*P*	×	○	○	○	×
RAV-SM804AT*P*	○	×	○	○	×

2 Jumper wires “J804~J805”

Set the jumper wires J804~J805 of the service board to the same as settings of the P.C.board before replacement.

11-1-2. RAV-SM564AT*P*, SM804AT*P* (MCC-1646)

⚠ WARNING

Don't open the inverter cover before 1 minute after power has been turned off because an electric shock may be occurred.

Assembly steps:

- 1** LED side of P.C.Board (MCC-1646) shall be inserted to hook① along the guide② of mold.
- 2** Switch side of P.C.Board (MCC-1646) shall be pressed to hook③ along guide④ of mold.
- 3** After assembly, push SW01 and SW02 to check that switches can be click (sound or feeling of click).

RAV-SM564AT*P*, RAV-SM804AT*P*

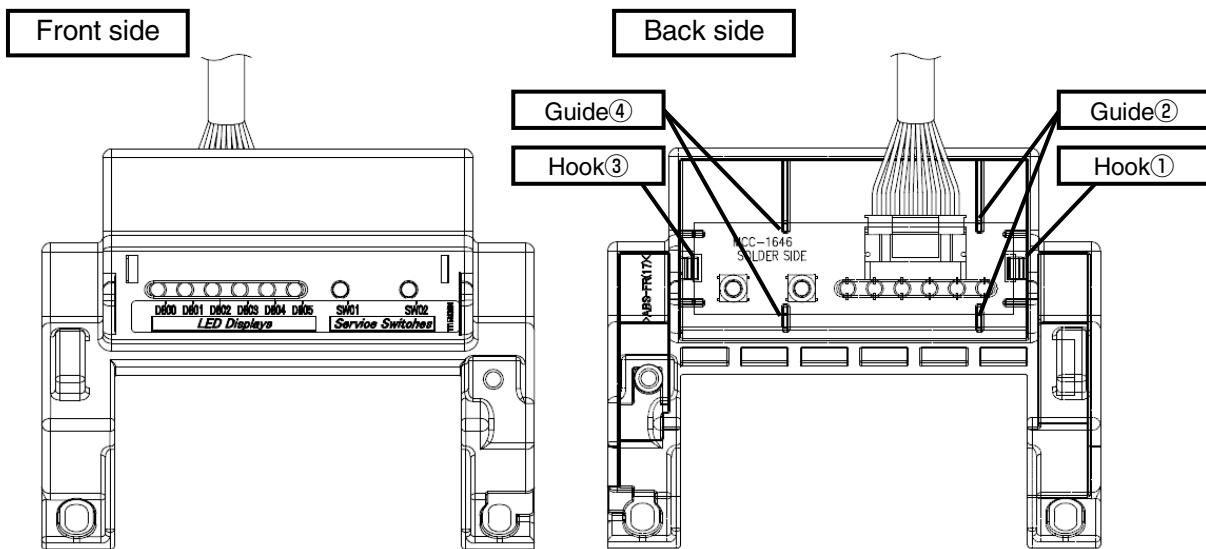

RAV-SM1104AT*P*, RAV-SM1404AT*P*

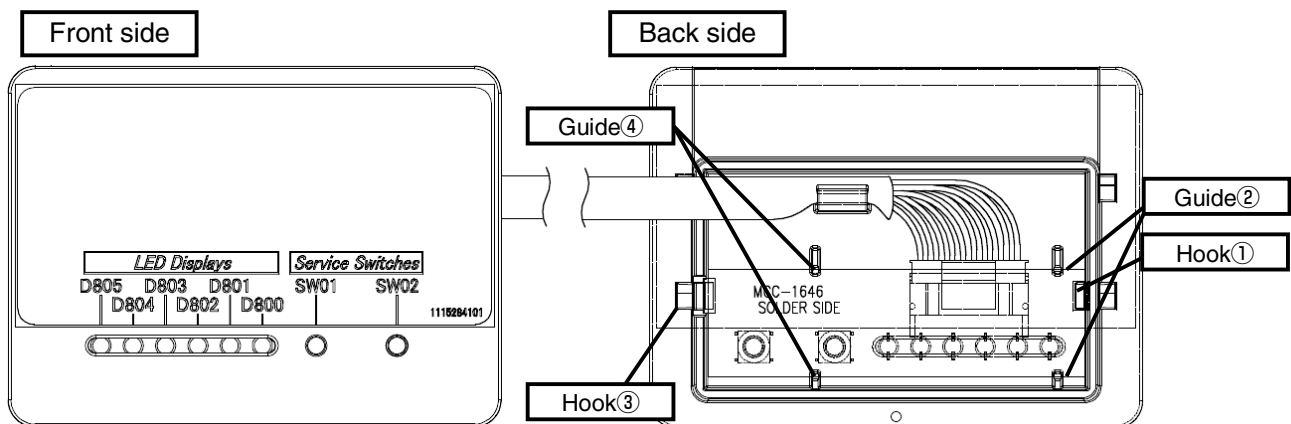

11-2. RAV-SM1104AT*P*, SM1404AT*P* (MCC-1648)

⚠ WARNING

Don't open the inverter cover before 1 minute after power has been turned off because an electric shock may be occurred.

Replacement steps:

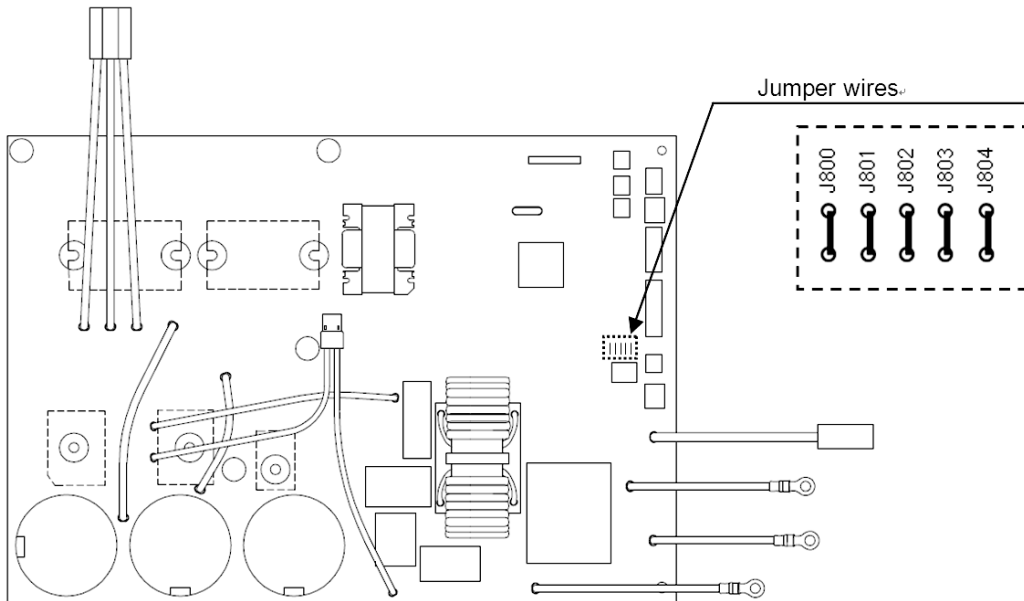

1 Jumper wires “J800~J803”

Cut the jumper wires of the service board, as instructed in the table below.

The jumper setting of J800~J803 differs from original supplied P.C.Board, therefore be sure to configure the jumpers as in the table below. If the model is not specified, the equipment will not operate.

Model name	J800	J801	J802	J803	
Service P.C. Board	○	○	○	○	○ : Connected
RAV-SM1104AT*P*	×	○	○	○	×
RAV-SM1404AT*P*	○	×	○	○	

2 Jumper wires “J804”

Set the jumper wire J804 of the service board to the same as settings of the P.C.board before replacement.

12. HOW TO EXCHANGE COMPRESSOR

12-1. Exchanging Procedure of Compressor (Outline)

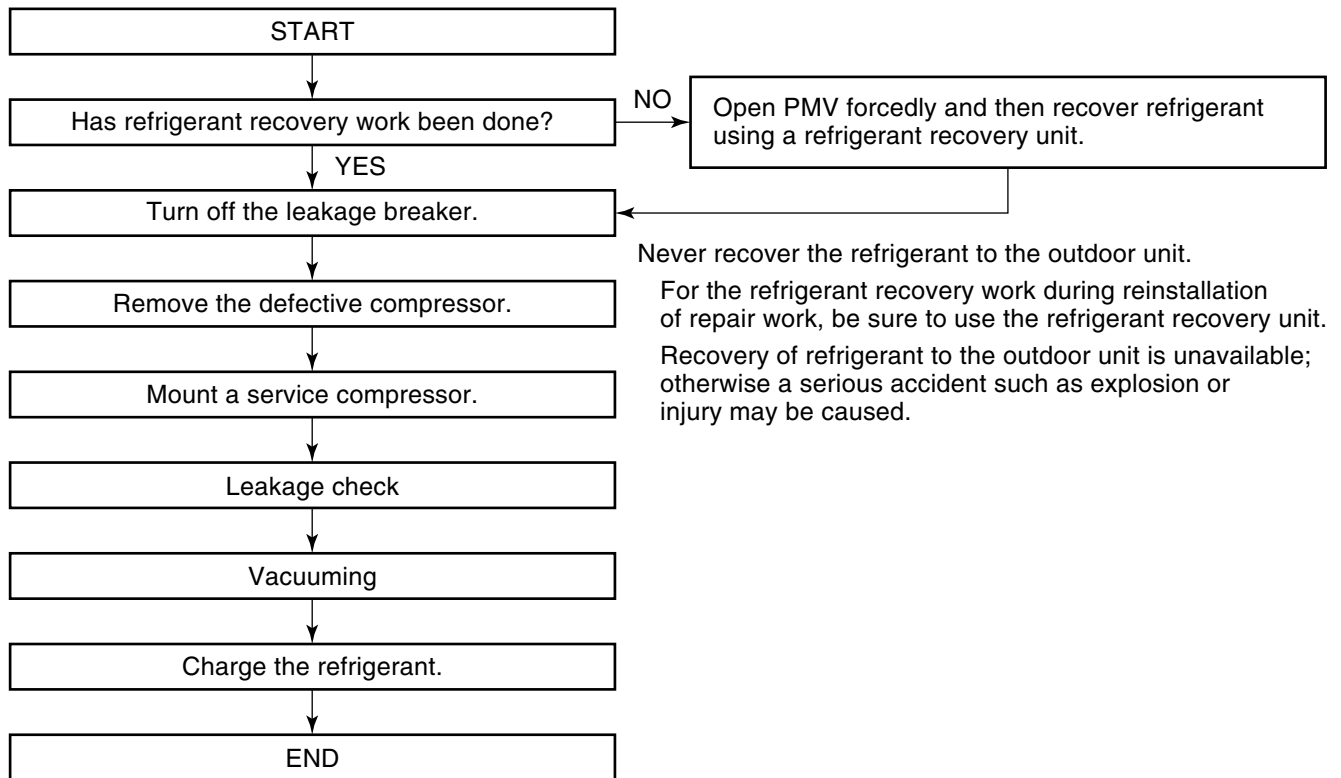



12-2. Exchange of Compressor



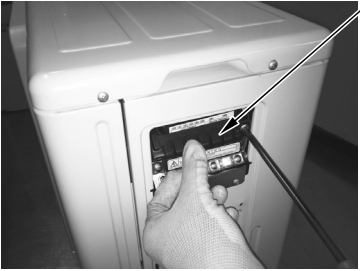
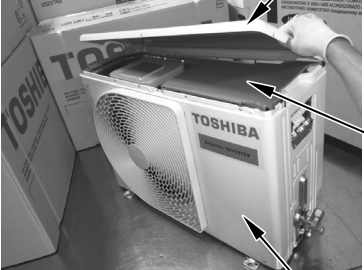

For exchange of compressors, refer to (11) Compressor in Section of 13. **Detachments.**

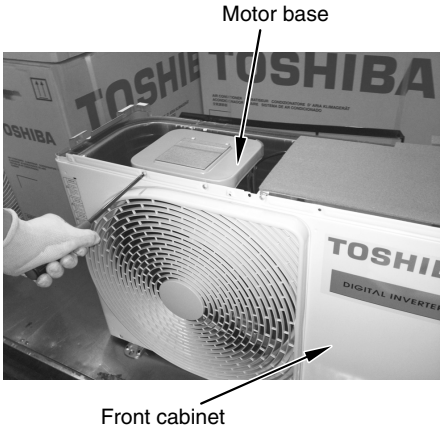
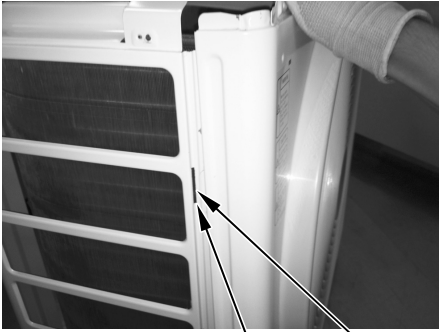
13. DETACHMENTS

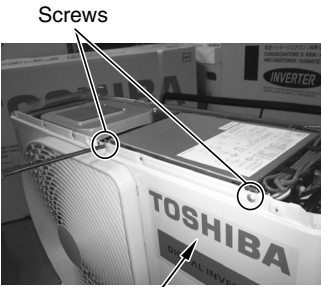

13-1. RAV-SM564AT*P*, SM804AT*P*

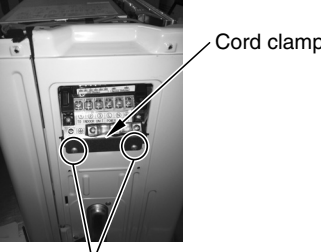

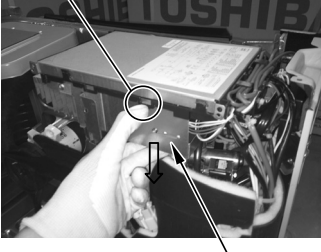
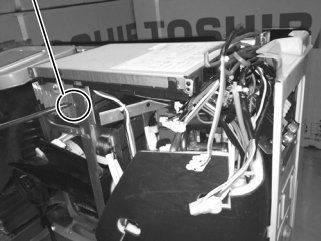
No.	Part name	Procedure	Remarks
①	Common procedure	<hr/> <p style="text-align: center;">CAUTION</p> <p>Never forget to put on the gloves at working time, otherwise an injury will be caused by the parts, etc.</p> <hr/> <p>1. Detachment</p> <ol style="list-style-type: none"> 1) Stop operation of the air conditioner, and turn off the main switch of the breaker for air conditioner. 2) Remove the valve cover. (ST1T Ø4 × 8L, 3 pcs.) <ul style="list-style-type: none"> • After removing screw, remove the valve cover pulling it downward. 3) Remove wiring cover (PT2T Ø4 × 10L, 1 pc.), and then remove connecting cable. 4) Remove the upper cabinet. (ST1T Ø4 × 8L, 5 pcs.) <ul style="list-style-type: none"> • After taking off screws, remove the upper cabinet pulling it upward. <p>2. Attachment</p> <ol style="list-style-type: none"> 1) Attach the waterproof cover. <hr/> <p style="text-align: center;">CAUTION</p> <p>Be sure to attach a waterproof cover. If it is not attached, there is a possibility that water enters inside of the outdoor unit.</p> <hr/> <ol style="list-style-type: none"> 2) Attach the upper cabinet. (ST1T Ø4 × 8L, 5 pcs.) <ul style="list-style-type: none"> • Hook the rear side of the upper cabinet to claw of the rear cabinet, and then put it on the front cabinet. 3) Perform cabling of connecting cables, and fix with cord clamp. (BT2T Ø4 × 12L, 3 pcs.) 4) Attach the wiring cover. (PT2T Ø4 × 10L, 1 pc.) 5) Attach the valve cover. (ST1T Ø4 × 8L, 3 pcs.) 	 <p>Valve cover</p>  <p>Wiring cover</p>  <p>Upper cabinet</p> <p>Water-proof cover</p> <p>Front cabinet</p>

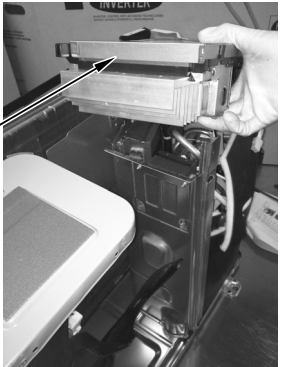
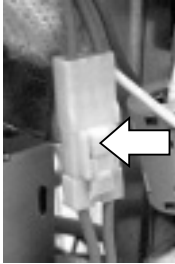

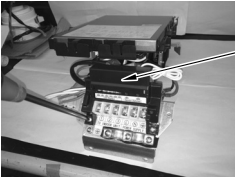
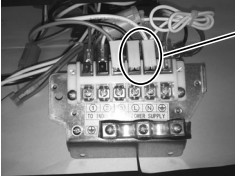
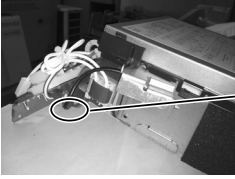
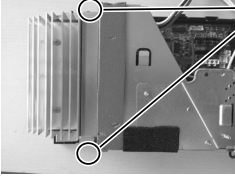
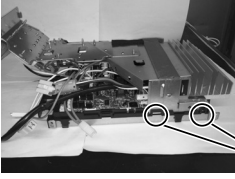
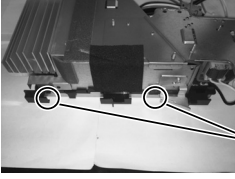
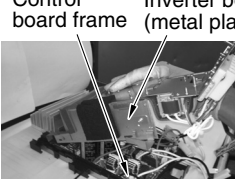
No.	Part name	Procedure	Remarks
②	Front cabinet	<p>1. How to remove</p> <ol style="list-style-type: none"> 1) Perform 1 of ①. 2) Remove the screw between front cabinet and side cabinet (right). (ST1T Ø4 × 8, 1 pc.) 3) Remove the screw between front cabinet and inverter. (ST1T Ø4 × 8, 2 pcs.) 4) Remove the screw between front cabinet and bottom slab. (ST1T Ø4 × 8, 3 pcs.) 5) Remove the screw between front cabinet and motor base. (ST1T Ø4 × 8, 2 pcs.) <ul style="list-style-type: none"> • Left side of front panel is inserted into side cabinet (left). Remove by pulling the upper part. <p>2. How to install</p> <ol style="list-style-type: none"> 1) Insert front panel's hook into side cabinet (left). 2) Insert side cabinet (left)'s hook into front cabinet's corner hole. 3) Insert the removed screws to their positions. 	 <p>Motor base</p> <p>Front cabinet</p>  <p>Corner hole Hook</p>  <p>Corner hole Hook</p>

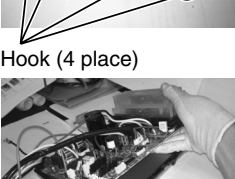
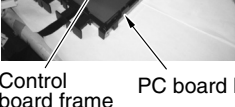
No.	Part name	Procedure	Remarks
③	Inverter assembly	<p>1. Detachment</p> <ol style="list-style-type: none"> 1) Perform work of item 1 of ① . 2) Take off screws of the upper part of the front cabinet. (ST1T Ø4 × 8L, 2 pcs.) <ul style="list-style-type: none"> • If removing the inverter cover under this condition, P.C. board can be checked. • If there is no space in the upper part of the upper cabinet, perform work of ②. <hr/> <p style="text-align: center;">CAUTION</p> <p>Be careful to check the inverter because high-voltage circuit is incorporated in it.</p> <hr/> <p style="text-align: center;">WARNING</p> <p>Never disassemble the inverter for 1minute after power has been turned off because an electric shock may be caused.</p> <hr/> <ol style="list-style-type: none"> 3) Perform 1 of ②. 4) Take off screw between side cabinet (right) and inverter box (wiring gate side) (ST1T Ø4 × 8, 2 pcs.) 5) Take off screw between partition plate and inverter box. (ST1T Ø4 × 8, 1 pc.) 6) Remove each lead wire type from holder of inverter upper part. 7) Pull upper part of inverter. Here, please cut bundling band that tie each lead wire type. 8) Remove the cover plate assembly. By hold cover plate assembly and pull down from PC board base's hook. 9) Remove connector of each lead wire type. 	 <p>Screws</p> <p>Front panel</p> <p>Inverter cover</p>   <p>Cord clamp</p> <p>Screws</p>  <p>Hook</p>  <p>Cover plate assembly</p>  <p>Screw</p>

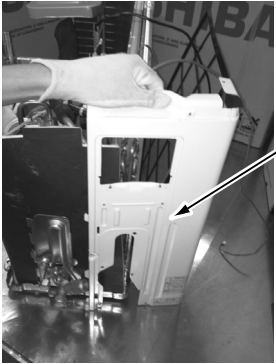
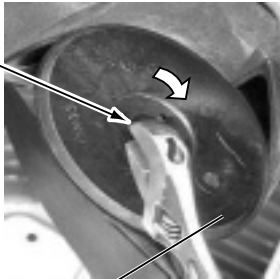
No.	Part name	Procedure	Remarks
③	Inverter assembly	<ul style="list-style-type: none"> • Connector Connection to compressor···(3P : Relay connector white) <li style="text-align: right;">※ (Warning 1) Reactor (2P : Relay connector white) CN300··· Outdoor fan (3P : white) <li style="text-align: right;">※ (Warning 1) CN701··· 4 directional valve (3P : yellow) <li style="text-align: right;">※ (Warning 1) CN700··· PMV coil (6P : white) <li style="text-align: right;">※ (Warning 1) CN601··· TD sensor (3P : white) CN603··· TS sensor (3P : white) <li style="text-align: right;">※ (Warning 1) CN600··· TE sensor (2P : white) <li style="text-align: right;">※ (Warning 1) CN604··· TL sensor (2P : white) <li style="text-align: right;">※ (Warning 1) CN602··· TO sensor (2P : white) CN500··· Case thermo (2P : blue) <li style="text-align: right;">※ (Warning 1) CN501··· High pressure switch (3P : green) <li style="text-align: right;">※ (Warning 1) <p style="margin-top: 20px;">※ Warning 1)</p> <p>Please remove housing part's lock before removing connectors.</p> <hr/> <p style="text-align: center;">REQUIREMENT</p> <p>As each connector has a lock mechanism, avoid to remove the connector by holding the lead wire, but by holding the connector.</p> <hr/>	 <p style="margin-top: 20px;">Remove the connectors with locking function by pushing the part indicated by the arrow mark.</p> 

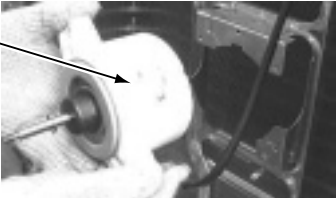

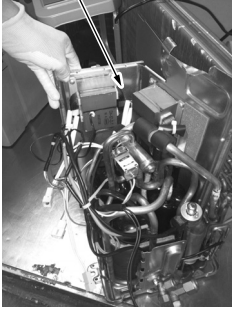
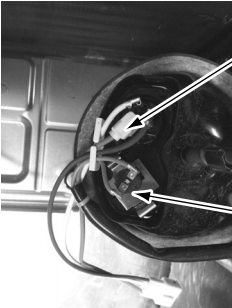
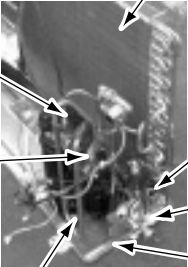
No.	Part name	Procedure	Remarks
④	Control P.C. board assembly	<p>1) Remove sub board base from inverter frame. (BT 2T Ø4 × 10, 2 pcs.) ※ Remove connector of control board frame side.</p> <p>2) Remove lead wire • connector that are connected from control board frame to other parts.</p> <p>1. Lead wire : Connect with terminal block Black, white, orange (single phase), red, white, black, orange (three phase) earthed lines (black)··· 1 pc.</p> <p>2. Connector CN807··· Display P.C.board (10P : white) ※ (Warning 1)</p> <p>Please cut the bundling band that tie lead wire of compressor, reactor and display P.C.board with inverter box(metal plate).</p> <p>※ Warning 1) Please remove housing part's lock before removing connectors.</p> <p>3) Take off 2 screws that connect inverter box and P.C.board base. And then remove inverter box from base.P.C.board base. Warning 2) Remove P.C.board base's hook (Hook 1, 2, 3, 4), hold P.C.board base, pull inverter box up.</p> <p>4) Remove control board frame from PC board base. (Remove while heat sink is still attached to control board frame)</p> <p>Warning 2) Remove PC board base's hook (4 places), hold heat sink, pull up.</p> <p>5) Take off 2 screws that connect heat sink and control board frame.</p> <p>6) Install new control board frame.</p> <p>Warning 3) When install new control board frame, please correctly insert the board. Make sure to install that heat sink touch metal plate.</p>	 Sub board base  Power line  Remove earth screw  Screws  Hook 1, 2  Hook 4, 3  Control board frame Inverter box (metal plate)  PC board base  Hook (4 place)  Control board frame PC board base

No.	Part name	Procedure	Remarks
⑤	Rear cabinet	1) Perform works of items 1 of ① and ②, ③. 2) Take off fixed screws for the bottom plate. (ST1T Ø4 × 8L, 2 pcs.) 3) Take off fixed screw for the valve mounting plate. (ST1T Ø4 × 8L, 3 pcs.)	
⑥	Fan motor	1) Perform works of items 1 of ① and ② . 2) Take off the flange nut fixing the fan motor and the propeller. • Turning it clockwise, the flange nut can be loosened. (To tighten the flange nut, turn counterclockwise.) 3) Remove the propeller fan. 4) Disconnect the connector for fan motor from the inverter. 5) Take off the fixing screws (3 pcs.) holding by hands so that the fan motor does not fall. NOTE: Tighten the flange nut with torque 4.9Nm (50kgf/cm).	 <p>Loosen the nut by turning clockwise</p>  <p>Propeller fan</p>  <p>Fan motor</p>

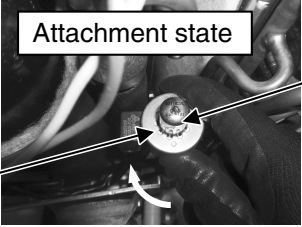
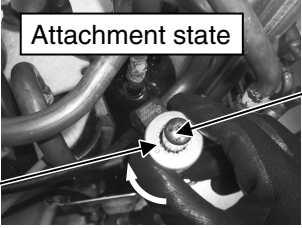
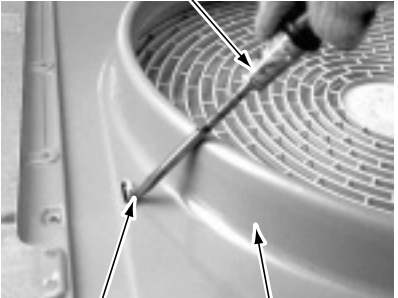
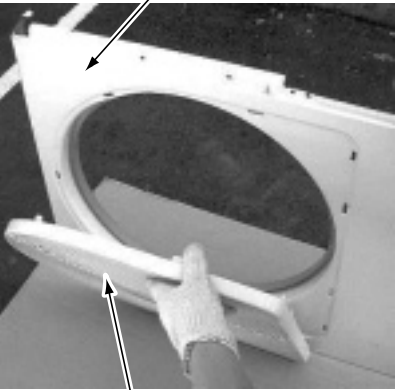
No.	Part name	Procedure	Remarks
⑦	Compressor	<p>1) Perform works of items 1 of ① and ②, ③, ⑤.</p> <p>2) Discharge refrigerant gas.</p> <p>3) Remove the partition plate. (ST1T Ø4 × 8L, 3 pcs.)</p> <p>4) Remove the terminal covers of the compressor, and disconnect lead wires of the compressor and the compressor thermo assembly from the terminal.</p> <p>5) Take off the soundproof plate.</p> <p>6) Remove pipes connected to the compressor with a burner.</p> <hr/> <p style="text-align: center;">CAUTION</p> <p>Pay attention to that flame does not involve 4-way valve or PMV. (If doing so, a malfunction may be caused.)</p> <hr/> <p>7) Take off the fixing screws of the bottom plate and heat exchanger. (ST1T Ø4 × 8L)</p> <p>8) Take off the fixing screws of the valve clamping plate to the bottom plate. (ST1T Ø4 × 8L, 2 pcs.)</p> <p>9) Pull upward the refrigerating cycle.</p> <p>10) Take off nut fixing the compressor to the bottom place.</p> <hr/> <p style="text-align: center;">CAUTION</p> <p>When reconnecting the lead wires to the compressor terminals after replacement of the compressor, be sure to caulk the Faston terminal without loosening.</p> <hr/>	<p>Partition plate</p>  <p>Compressor lead</p> <p>Case thermo</p>  <p>Heat exchanger</p> <p>Remove (Discharge pipe)</p> <p>Remove (Suction pipe)</p> <p>Screw</p> <p>Valve support board</p> <p>Screws (2 pcs.)</p> <p>Compressor bolt (3 pcs.)</p> 
⑧	Reactor	<p>1) Perform works of item 1 of ①, ② and ③.</p> <p>2) Remove partition plate (ST1T Ø4 × 8L, 3 pcs.)</p> <p>3) Take off screw attached to reactor (ST1T Ø4 × 8L, 5 pcs.)</p>	

No.	Part name	Procedure	Remarks
⑨	Pulse Motor Valve (PMV) coil	<p>1. Detachment</p> <ol style="list-style-type: none"> 1) Perform works of items ① and ②. 2) Release the coil from the concavity by turning it, and remove coil from the PMV. <p>2. Attachment</p> <ol style="list-style-type: none"> 1) Put the coil deep into the bottom position. 2) Fix the coil firmly by turning it to the concavity. 	<p>SM56* type</p>  <p>SM80* type</p> 
⑩	Fan guard	<p>1. Detachment</p> <ol style="list-style-type: none"> 1) Perform works of items 1 of ① and ②. 2) Remove the front cabinet, and put it down so that fan guard side directs downward. <hr/> <p style="text-align: center;">CAUTION</p> <p>Perform works on a corrugated cardboard, cloth, etc. to prevent flaw on the product.</p> <hr/> <ol style="list-style-type: none"> 3) Remove the hooking claws by pushing with minus screwdriver along with the arrow mark in the right figure, and remove the fan guard. <p>2. Attachment</p> <ol style="list-style-type: none"> 1) Insert claws of the fan guard in the hole of the front cabinet. Push the hooking claws (10 positions) with hands and then fix the claws. <hr/> <p style="text-align: center;">CAUTION</p> <p>All the attaching works have completed. Check that all the hooking claws are fixed to the specified positions.</p> <hr/>	 

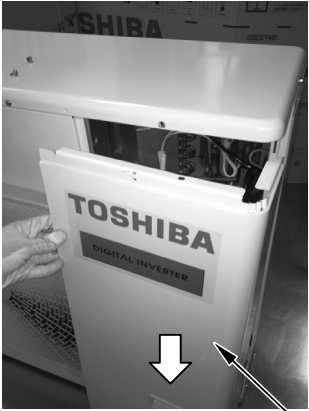
13-2. RAV-SM1104AT*P*, SM1404AT*P*

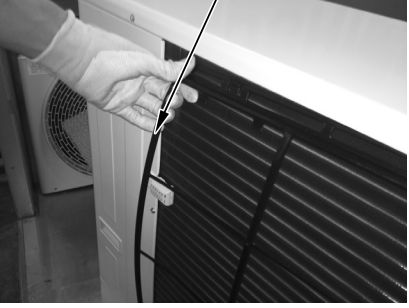
No.	Part name	Procedure	Remarks
①	Common procedure	<hr/> <p style="text-align: center;">CAUTION</p> <p>Be sure to put on the gloves at working time; otherwise an injury may be caused by a part, etc.</p> <hr/> <p>1. Detachment</p> <ol style="list-style-type: none"> 1) Stop operation of the air conditioner and then turn off switch of the breaker. 2) Remove the front panel. (Hexagonal screw Ø4 × 10, 2 pcs.) * After removing screws, remove the front panel while pulling it downward. 3) Remove the power wire and indoor/outdoor connecting wire from the cord clamp and the terminals. 4) Remove the top plate. (Hexagonal screw Ø4 × 10, 5 pcs.) <p>2. Attachment</p> <ol style="list-style-type: none"> 1) Attach the top plate. (Hexagonal screw Ø4 × 10, 5 pcs.) In this time, insert the fin guard of rear side between the top plate and the heat exchanger (Rear side). 2) Connect the power supply wire and the indoor/outdoor connecting wire to the terminal and fix it with cord clamp. <hr/> <p style="text-align: center;">CAUTION</p> <p>Using bundling band on the market, be sure to fix the power wire and indoor/outdoor connecting wire along the crossover pipe so that they do not come to contact with the compressor, valve at gas side, pipe at gas side and discharge pipe.</p> <hr/> <ol style="list-style-type: none"> 3) Attach the front panel. (Hexagonal screw Ø4 × 10, 2 pcs.) 	 <p style="text-align: right;">Front panel Top plate</p>  <p>Insert the fin guard of rear side between the top plate and the heat exchanger (at rear side).</p> 

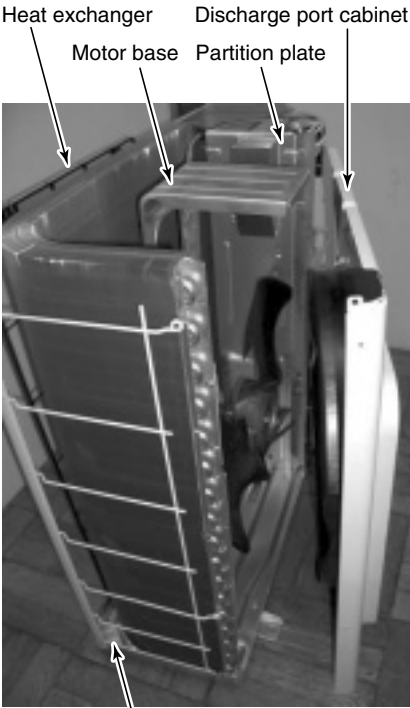
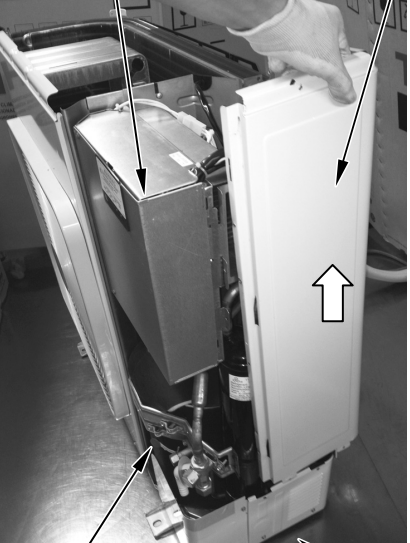
No.	Part name	Procedure	Remarks
②	Discharge port cabinet	<p>1. Detachment</p> <ol style="list-style-type: none"> 1) Carry out work of 1 of ①. 2) Remove screws for the discharge port cabinet and the partition plate. (ST1T Ø4 × 8, 3 pcs.) 3) Remove screws for the discharge port cabinet and the bottom plate. (Hexagonal screw Ø4 × 10, 2 pcs.) 4) Remove screws of the discharge port cabinet and the motor base. (ST1T Ø4 × 8, 2 pcs.) 5) Remove screws of the discharge port cabinet and the heat exchanger. (ST1T Ø4 × 8, 1 pc.) 6) Remove screws of the discharge port cabinet and the fin guard. (Hexagonal screw Ø4 × 10, 2 pcs.) 	 <p>Heat exchanger Discharge port cabinet Motor base Partition plate</p> <p>Fin guard</p>
③	Side cabinet	<p>1. Detachment</p> <ol style="list-style-type: none"> 1) Carry out work of 1 of ①. 2) Remove screws which fix the inverter assembly and the side cabinet. (ST1T Ø4 × 8, 2 pcs.) 3) Remove screws of the side cabinet and the valve fixing plate. (ST1T Ø4 × 8, 2 pcs.) 4) Remove screws of the side cabinet and the pipe panel (Rear). (Hexagonal screw Ø4 × 10, 2 pcs.) 5) Remove screws of the side cabinet and the bottom plate. (Hexagonal screw Ø4 × 10, 1 pc.) 6) Remove screws of the side cabinet and the heat exchanger. (Hexagonal screw Ø4 × 10, 3 pcs.) 7) Slide the side cabinet upward and then remove it. (Hook of inverter) 	 <p>Inverter assembly Side cabinet</p> <p>Valve fixing plate Panel piping (Rear)</p>

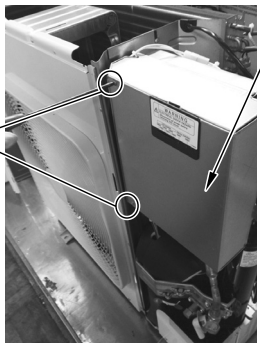
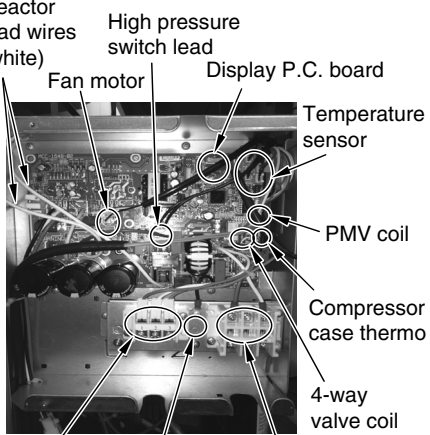
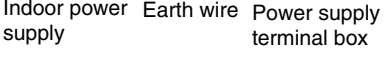
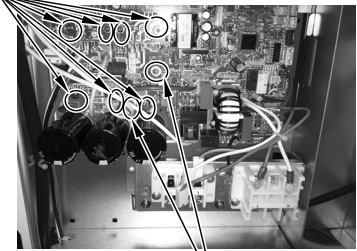
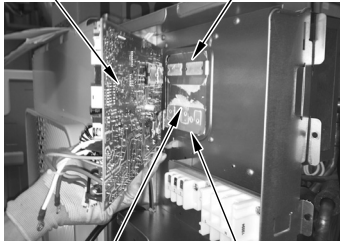
No.	Part name	Procedure	Remarks
④	Exchange of electric parts	<p>1. Control P.C. board</p> <p>1) Carry out work of 1 of ①.</p> <hr/> <p style="text-align: center;">⚠ WARNING</p> <p>Never disassemble the inverter for 1 minute after power has been turned off because an electric shock may be caused.</p> <hr/> <p>2) Take off screws of cover inverter. (ST1T Ø4 × 10L, 2 pcs.)</p> <p>3) Remove the connectors connected to the control P.C. board. (Indoor power supply, temperature sensors, PMV coil, 4-way valve coil, compressor case thermo, fan motor, high pressure switch, display P.C. board). * Unlock the lock of the housing part and then remove the connectors.</p> <p>4) Remove connectors connected to the compressor (3P: Relay connector white) and reactor (2P: Relay connector white) here, please cut the bundling band that tie lead wire compressor to the inverter box and lead wire reactor to the inverter box.</p> <p>Remove the power wire from the power supply terminal block. (Torque at tightening time: $2.5 \pm 0.1\text{N}\cdot\text{m}$)</p> <p>5) Remove the earth wire from the control P.C. board. (Truss B tight screw Ø4 × 6, 1 pc.)</p> <p>6) Remove the fixing screws of the control P.C. board. (Screw with collar for fixing element Ø3 × 20, 2 pcs. Screw with washer for fixing element Ø3 × 20, 7 pcs.)</p> <p>7) Remove the control P.C. board. (Supporter: 5 positions)</p> <p>NOTE: It is difficult to take out it because of radiator grease for heat sink.</p> <p>8) Mount a new control P.C. board.</p> <p>NOTE: Do not forget to attach the aluminum plate (Q201) and the insulating sheet (Q300). (Applying a little of radiator grease at the rear surface of the insulating sheet in advance to adhere to the heat sink makes easy the work.)</p>	 <p>Cover inverter Screws</p>  <p>Reactor lead wires (white) High pressure switch lead Fan motor Display P.C. board Temperature sensor PMV coil Compressor case thermo 4-way valve coil</p>  <p>Indoor power supply Earth wire Power supply terminal box</p> <p>Screw for fixing element (7 positions)</p>  <p>Screw with collar for fixing element (2 positions)</p>  <p>Control P.C. board Aluminium plate (Q201) Radiator grease Insulating sheet (Q300)</p>

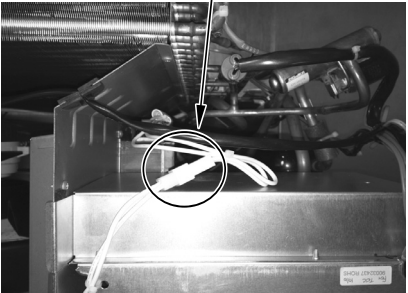
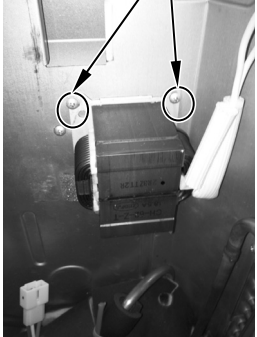
No.	Part name	Procedure	Remarks
④	Exchange of electric parts (Continued)	<p>2. Reactor</p> <ol style="list-style-type: none"> 1) Carry out works of 1 of ① and ③. 2) Remove the relay connector connected to the control P.C. board. 3) Remove each reactor. (Truss B tight screw Ø4 × 6, 2 pcs. each) 4) Attach a new reactor. 	<p>Reactor relay connector (Connected to lead wire (White) at P.C. board side)</p>  <p>Screws</p> 

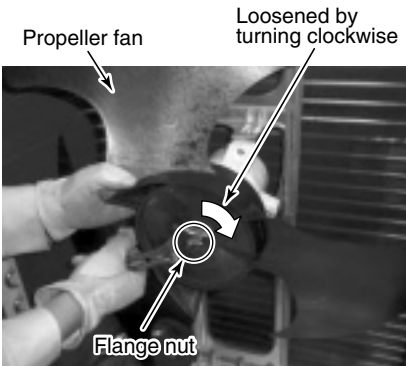
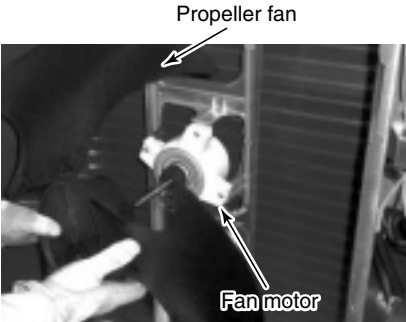
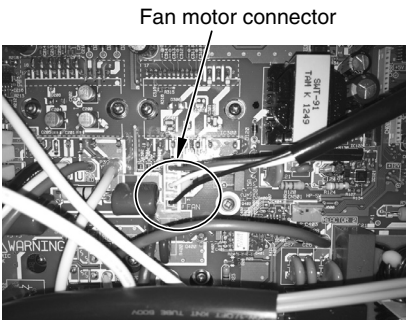
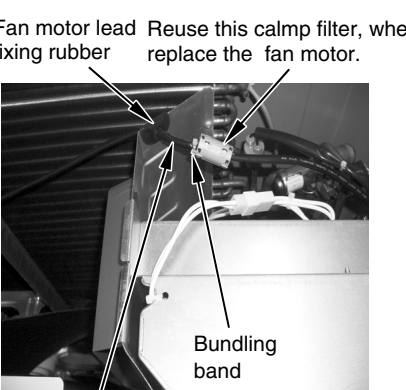
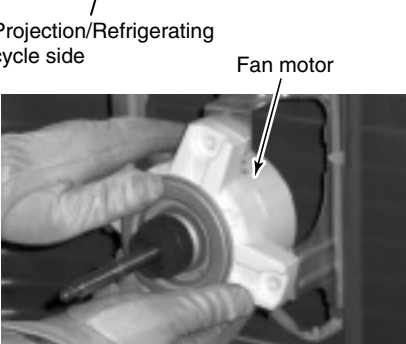
No.	Part name	Procedure	Remarks
⑤	Fan motor	<p>1) Carry out works of 1 of ① and ②.</p> <p>2) Remove the flange nut fixing the fan motor and the propeller fan. * The flange nut is loosened by turning clockwise. (To tighten it, turn it counterclockwise.)</p> <p>3) Remove the propeller fan.</p> <p>4) Remove the connector for fan motor from the inverter.</p> <p>5) Remove the fan motor lead from the fan motor lead fixing rubber of the penetrated part of the partition plate.</p> <p>6) Remove the fixing screws (4 pcs. each) while supporting the fan motor so that it does not fall.</p> <p>* Cautions when assembling the fan motor</p> <ul style="list-style-type: none"> * Tighten the flange nut with 4.95N•m (50kgf.cm). * Adjust length on the fan motor lead fixing rubber so that the fan motor lead does not slacken in order not to put the fan motor lead into contact with the propeller fan. <p>Attach the fan motor lead fixing rubber to the partition plate so that projection directs to the refrigerating cycle side.</p> <ul style="list-style-type: none"> * Be sure that the rector body does not come to contact with the fan motor lead. * Be sure to bind the removed bundling band with the bundling band on the market. <hr/> <p style="text-align: center;">⚠ CAUTION</p> <p>Use the metal band of the motor base to fix the fan motor lead on the motor base so that the fan motor lead does not come to contact with the propeller fan.</p> <hr/> <p>NOTE: Please reuse the clamp filter when replace the fun motor.</p>	 <p>Propeller fan</p> <p>Loosened by turning clockwise</p> <p>Flange nut</p>  <p>Propeller fan</p> <p>Fan motor</p>  <p>Fan motor connector</p> <p>Fan motor lead Reuse this clamp filter, when fixing rubber replace the fan motor.</p>  <p>Bundling band</p>  <p>Projection/Refrigerating cycle side</p> <p>Fan motor</p>

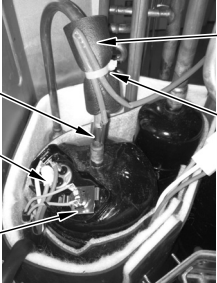
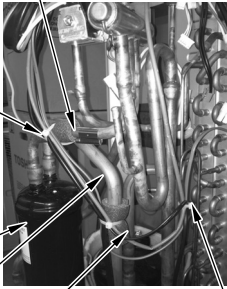
No.	Part name	Procedure	Remarks
⑥	Compressor Compressor lead	<p>1. Removal of broken compressor</p> <ol style="list-style-type: none"> 1) Recover the refrigerant gas. 2) Carry out works of 1 of ① and ②, ③. 3) Remove the piping panel (Front). Remove screws of the piping panel (Front) and the bottom plate. (Hexagonal screw Ø4 × 10, 2 pcs.) Remove screws of the piping panel (Front) and the piping panel (Rear). (Hexagonal screw Ø4 × 10, 1 pc.) 4) Remove the piping panel (Rear). Remove screws of the piping panel (Rear) and the bottom plate. (Hexagonal screw Ø4 × 10, 2 pcs.) 5) Remove the valve fixing plate. Remove bolts of the valve. (Hexagonal screw Ø6 × 16, 4 pcs.) Remove screws of the valve fixing plate and the partition plate. (ST1T Ø4 × 10, 1 pc.) Remove screws of the valve fixing plate and the accumulator. (Hexagonal screw Ø4 × 10, 1 pc.) Cut off the bundling band for the discharge pipe and the suction pipe and then remove each sensor and coil lead of PMV. 6) Remove the soundproof plate. (Upper side, outer winding, inner winding) 7) Remove terminal cover from the compressor and then remove the compressor lead and also the compressor case thermo. 8) Remove TD sensor fixed to the discharge pipe. 9) Remove the compressor lead. (Leave the ferrite core attached to the electric parts box as it is.) 	 <p>Piping panel (Front) Piping panel (Rear)</p>  <p>TD sensor Pipe cover Compressor lead Bundling band Compressor case thermo</p>  <p>TS sensor Pipe cover, bundling band, each sensor (TL, TO, TE, TD, TS sensors) PMV coil lead. Accumulator Suction pipe</p> <p>Pipe cover, bundling band, each sensor (TL, TO, TE, TD sensors) PMV coil lead. Bundling band, each sensor (TL, TO, TE sensors)</p>

No.	Part name	Procedure	Remarks
⑥	Compressor Compressor lead (Continued)	<p>10) Using a burner, remove the discharge pipe and the suction pipe connected to the compressor.</p> <hr/> <p style="text-align: center;">⚠ WARNING</p> <p>In case of removing the piping by broiling the welded part with a burner, if the piping includes oil, it may burst into flames at the moment when wax melted, so take sufficient care.</p> <hr/> <p style="text-align: center;">⚠ CAUTION</p> <p>Note so that the flame does not catch the 4-way valve and PMV. (An operation may become an error.)</p> <hr/> <p>11) Pull off the discharge pipe and the suction pipe of the refrigerating cycle upward.</p> <p>12) Remove the compressor bolts which fix the compressor to the bottom plate. (3 pcs.)</p> <p>13) Pull out the compressor toward you.</p> <hr/> <p style="text-align: center;">⚠ CAUTION</p> <p>The weight of the compressor is 15kg or more, so handle it by 2 workers.</p> <hr/>	<p>Remove (Discharge pipe) Remove (Suction pipe)</p>  <p>Compressor bolt (3 pcs.)</p>

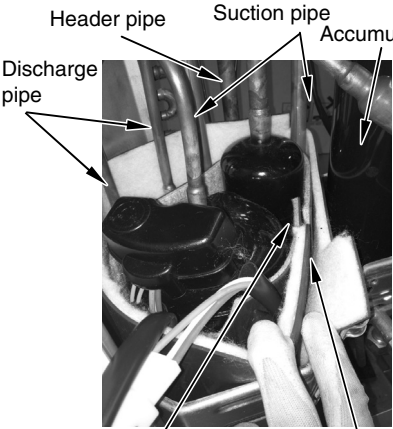
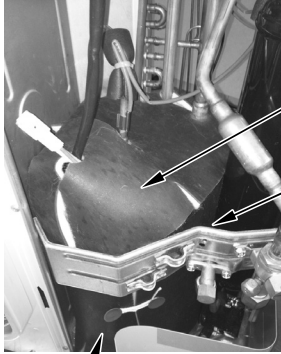
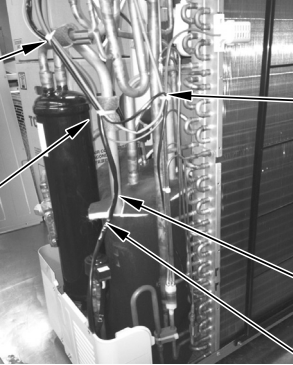
No.	Part name	Procedure	Remarks
⑥	Compressor Compressor lead (Continued)	<p>2. Mounting of compressor</p> <p>1) Mount the compressor in the reverse procedure of removal.</p> <p>NOTES:</p> <ul style="list-style-type: none"> * After exchange of the compressor, be sure to exchange the compressor lead. (Repair part code of compressor lead: 43T60443) * Fix the removed each sensor and PMV coil lead wire to the discharge pipe and the suction pipe with the bundling band via the pipe cover. <p>In this time, take note that each sensor and PMV coil lead wire do not come to contact with the discharge pipe and the reactor. (For fixing to the discharge pipe, use the black heat-proof pipe cover and the bundling band for heat-proof which is sold on the market.)</p> <ul style="list-style-type: none"> * As shown in the right figure, mount the soundproof plate (inner winding, outer winding) by inserting between the compressor and the piping, and between piping and the partition plate. * Put the compressor lead wire and the compressor case thermo between inner winding and outer winding of the soundproof as if dropping them in. 	 <p>Header pipe Suction pipe Accumulator Discharge pipe</p> <p>Pass the soundproof plate (inner winding) through between compressor and discharge pipe, suction pipe and then put it on the other side at this position.</p> <p>Pass the soundproof plate (outer winding) through between the suction pipe and accumulator and then put it on the other side at this position.</p>  <p>Soundproof plate (upper) Do not make clearance between the soundproof plate (upper) and the soundproof plate (outer winding). Soundproof plate (outer winding)</p>  <p>Pipe cover, bundling band, each sensor (TL, TO, TE, TD, TS sensors) PMV coil lead.</p> <p>Pipe cover, bundling band, each sensor (TL, TO, TE, TD sensors) PMV coil lead.</p> <p>Bundling band, each sensor (TL, TO, TE sensors)</p> <p>Suction pipe</p> <p>PMV coil lead</p>

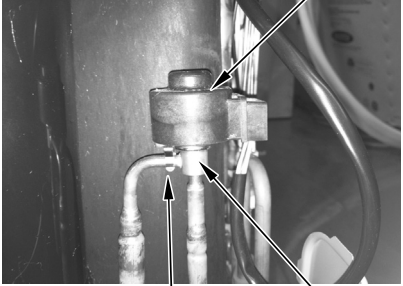
No.	Part name	Procedure	Remarks
⑥	Compressor Compressor lead (Continued)	<p>3. Vacuuming</p> <ol style="list-style-type: none"> 1) Connect the vacuum pump to the charge port of the gas pipe valve and then drive the vacuum pump. 2) Carry out vacuuming until the vacuum low pressure gauge indicates 1 (mmHg). <p>NOTE: Before vacuuming, open PMV fully. If PMV is closed, vacuuming may be impossible between the liquid pipe valve and PMV of the outdoor unit.</p> <p>Forced full-opening method of PMV Please refer to "9. SETUP AT LOCAL SITE AND OTHERS" (9-3-3.2)</p> <p>4. Refrigerant charging</p> <ol style="list-style-type: none"> 1) Add the quantity of refrigerant specified by the pipe length into the charge port of the valve. 	
⑦	PMV coil	<p>1. Detachment</p> <ol style="list-style-type: none"> 1) Carry out works of 1 of ① and ③. 2) While pulling the coil upward and removing the spring which pinches the copper pipe, remove the coil from PMV main body. <p>2. Attachment</p> <ol style="list-style-type: none"> 1) Match the spring to the copper pipe and fix it. 	 <p>PMV coil</p> <p>Spring</p> <p>PMV main body</p>

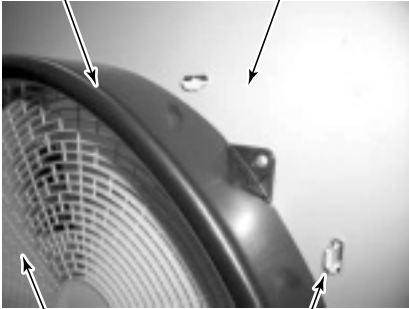
No.	Part name	Procedure	Remarks
⑧	Fan guard	<p>3. Detachment</p> <p>1) Carry out works of 1 of ① and ②.</p> <hr/> <p style="text-align: center;">CAUTION</p> <hr/> <p>To prevent scratching on the product, handle the product on a cardboard or cloth.</p> <hr/> <p>2) Remove the discharge port cabinet and then put on it so that the fan guard side directs downward.</p> <p>3) Remove the hooking claws (8 positions) of the fan guard.</p> <p>2. Attachment</p> <p>1) Push the hooking claws (8 positions) with hands from the front side to fix the claws.</p> <hr/> <p style="text-align: center;">CAUTION</p> <hr/> <p>Check that all the hooking claws are fixed at the specified positions.</p> <hr/>	<p>Bell mouth Discharge port cabinet</p>  <p>Fan guard Hooking claw</p>

14. EXPLODED VIEWS AND PARTS LIST

14-1. RAV-SM564ATP-E, SM564ATJP-E, SM564ATP-TR

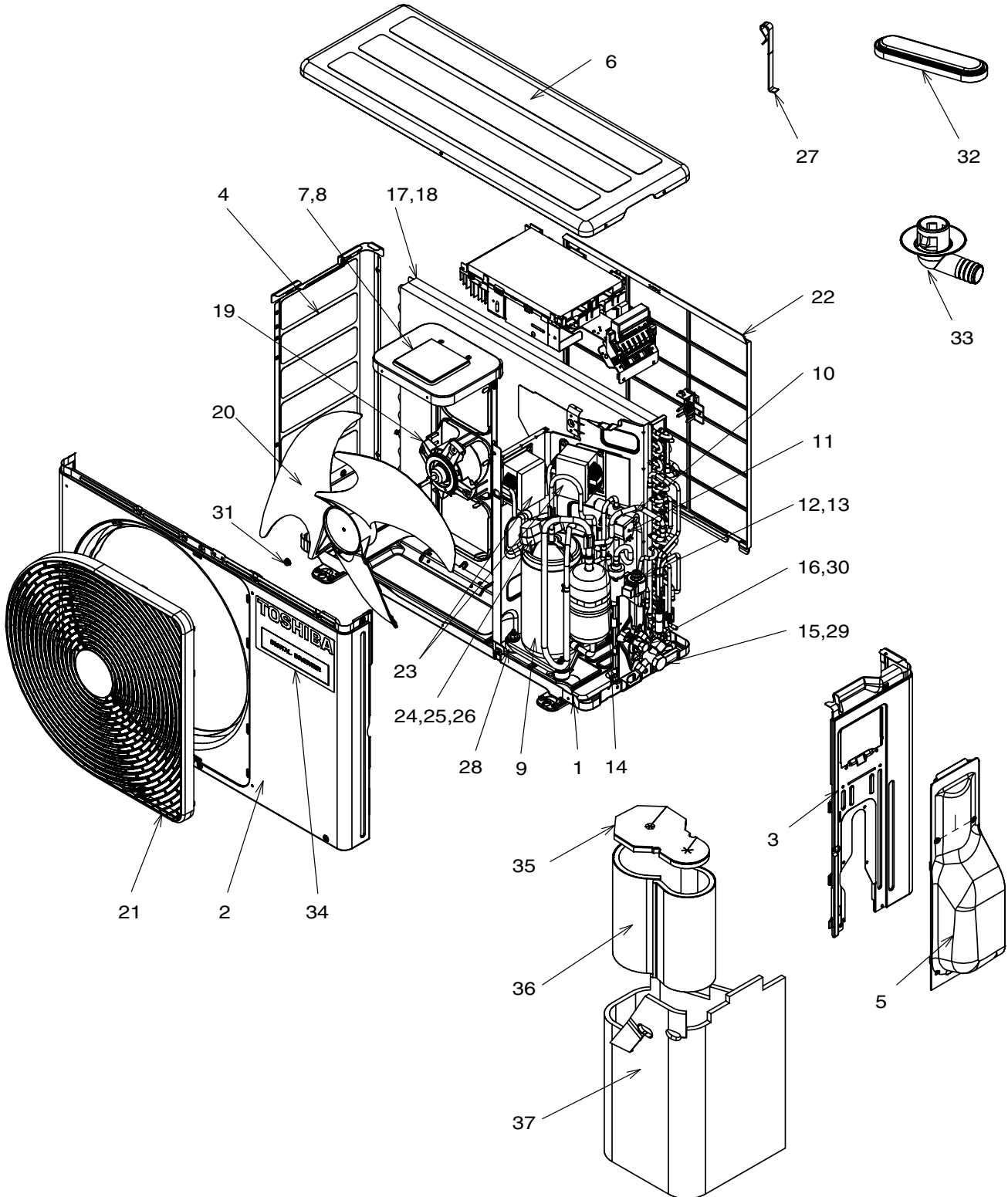

Location No.	Part No.	Description	RAV-		
			SM564ATP-E	SM564ATJP-E	SM564ATP-TR
1	43T42352	ASM-COAT-BASE	1	1	1
2	43T00605	ASM-CABI-F-S	1	1	1
3	43T00599	ASM-CABI-SIDE-R	1	1	1
4	43T00603	ASM-COAT-C-S-L	1	1	1
5	43T19352	ASM-COVER-PV	1	1	1
6	43T00604	ASM-COAT-CABI-U	1	1	1
7	43T39348	ASM-M-BASE	1		1
8	43T39347	ASM-M-BASE		1	
9	43T41493	COMP ASSY	1	1	1
10	43T46375	VALVE-4WAY	1	1	1
11	43T63352	COIL-V-4WAY	1	1	1
12	43T46425	BODY-PMV	1	1	1
13	43T63354	COIL-PMV	1	1	1
14	43T63353	SW-PRESS	1	1	1
15	43T46374	PACKEDVALVE	1	1	1
16	43T46358	PACKEDVALVE	1	1	1
17	43T43491	ASM-COND	1		1
18	43T43490	ASM-COAT-COND		1	
19	43T21375	MOTOR-FAN	1	1	1
20	43T20319	FAN-PR(PJ421)	1	1	1
21	43T19329	GUARD-FAN	1	1	1
22	43T19331	GUARD-FIN	1	1	1
23	43T58306	REACTOR	2	2	2
24	43T60439	ASM-COMP-LEAD	1	1	1
25	43T54319	BIMETAL-THERMO	1	1	1
26	43T50307	HOLDER-THERMO	1	1	1
27	43T19333	FIX-P-SENSOR	1	1	1
28	43T49335	RUBBER-CUSHION	3	3	3
29	43T47333	BONNET	1	1	1
30	43T47331	BONNET	1	1	1
31	43047669	NUT-FLANGE	1	1	1
32	43089160	CAP-WATERPROOF	2	2	2
33	43T79305	DRAIN-NIPPLE*	1	1	1
34	43T85553	MARK-T	1	1	1
35	43T04315	S-INSU(UP)	1	1	1
36	43T04316	SOUND-INSU(IS)	1	1	1
37	43T04317	SOUND-INSU(OS)	1	1	1

<Inverter assembly SM56>

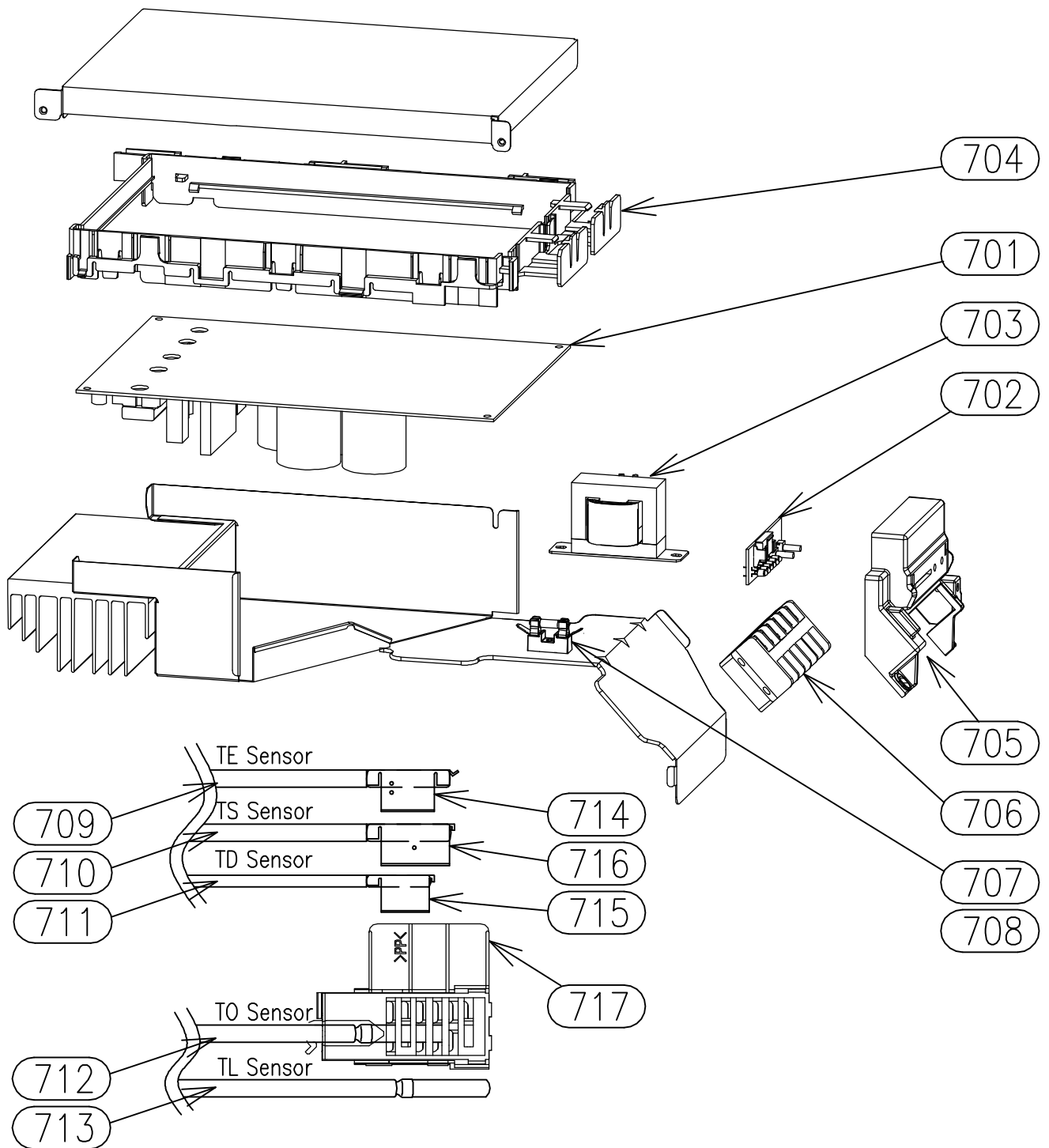

Location No.	Part No.	Description	RAV-		
			SM564ATP-E	SM564ATJP-E	SM564ATP-TR
701	43T6V413	ASM-L-PCB	1	1	1
702	43T6V418	ASM-PCB	1	1	1
703	43T60422	REACTOR(CH-76)	1	1	1
704	43T62313	BASE-PLATE-PC	1	1	1
705	43T61320	ASM-BASE-PL-SUB-PC	1	1	1
706	43T60423	TERMINAL	1	1	1
707	43T60426	FUSE	1	1	1
708	43T60425	FUSE-HOLDER	1	1	1
709	43T50352	TC-SENSOR(TE)	1	1	1
710	43T50353	TC-SENSOR(TS)	1	1	1
711	43T50334	SENSOR(TD)	1	1	1
712	43T50337	SENSOR(TO)	1	1	1
713	43T50335	SENSOR(TL)	1	1	1
714	43T63318	HOLDER-SENSOR(TE)	1	1	1
715	43T63317	HOLDER-SENSOR(TD)	1	1	1
716	43T63323	HOLDER-SENSOR(TS)	1	1	1
717	43T63319	SENSOR-HOLDER(TO)	1	1	1

14-2. RAV-SM804ATP-E, SM804ATJP-E, SM804ATP-TR

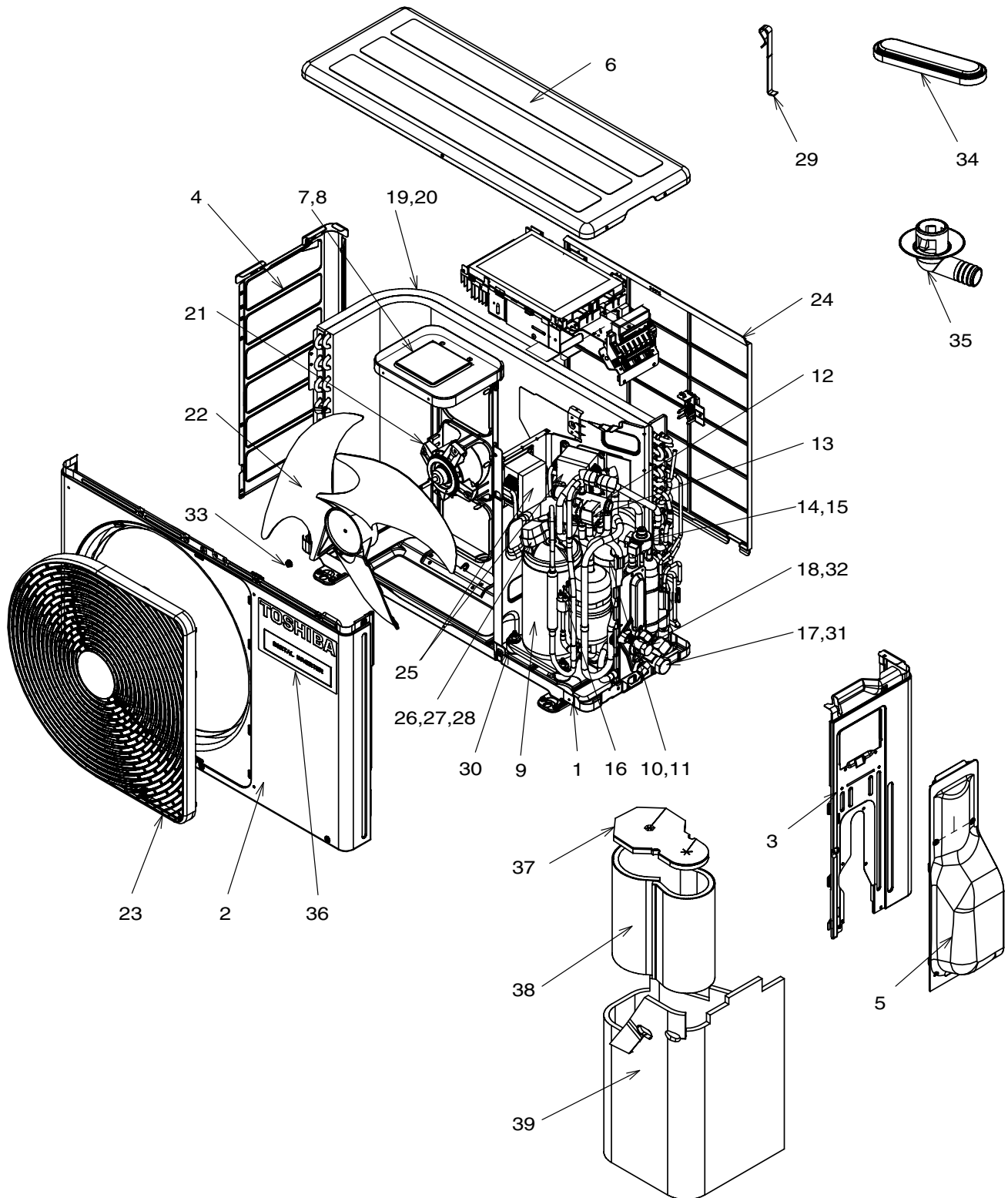

Location No.	Part No.	Description	RAV-		
			SM804ATP-E	SM804ATJP-E	SM804ATP-TR
1	43T42352	ASM-COAT-BASE	1	1	1
2	43T00605	ASM-CABI-F-S	1	1	1
3	43T00599	ASM-CABI-SIDE-R	1	1	1
4	43T00602	ASM-COAT-C-S-L	1	1	1
5	43T19352	ASM-COVER-PV	1	1	1
6	43T00604	ASM-COAT-CABI-U	1	1	1
7	43T39348	ASM-M-BASE	1		1
8	43T39347	ASM-M-BASE		1	
9	43T41493	COMP ASSY	1	1	1
10	43T48302	ASM-ACCUM	1		1
11	43T48303	ASM-ACCUM		1	
12	43T46383	VALVE-4WAY	1	1	1
13	43T63352	COIL-V-4WAY	1	1	1
14	43T46425	BODY-PMV	1	1	1
15	43T63354	COIL-PMV	1	1	1
16	43T63353	SW-PRESS	1	1	1
17	43T46386	PACKED-VALVE	1	1	1
18	43T46380	PACKED-VALVE	1	1	1
19	43T43471	ASM-COND	1		1
20	43T43487	WORK-COND		1	
21	43T21375	MOTOR-FAN	1	1	1
22	43T20319	FAN-PR(PJ421)	1	1	1
23	43T19329	GUARD-FAN	1	1	1
24	43T19331	GUARD-FIN	1	1	1
25	43T58306	REACTOR	2	2	2
26	43T60439	ASM-COMP-LEAD	1	1	1
27	43T54319	BIMETAL-THERMO	1	1	1
28	43T50307	HOLDER-THERMO	1	1	1
29	43T19333	FIX-P-SENSOR	1	1	1
30	43T49335	RUBBER-CUSHION	3	3	3
31	43T47334	BONNET	1	1	1
32	43T47332	BONNET	1	1	1
33	43047669	NUT-FLANGE	1	1	1
34	43089160	CAP-WATERPROOF	2	2	2
35	43T79305	DRAIN-NIPPLE*	1	1	1
36	43T85553	MARK-T	1	1	1
37	43T04315	S-INSU(UP)	1	1	1
38	43T04316	SOUND-INSU(IS)	1	1	1
39	43T04317	SOUND-INSU(OS)	1	1	1

<Inverter assembly SM80>

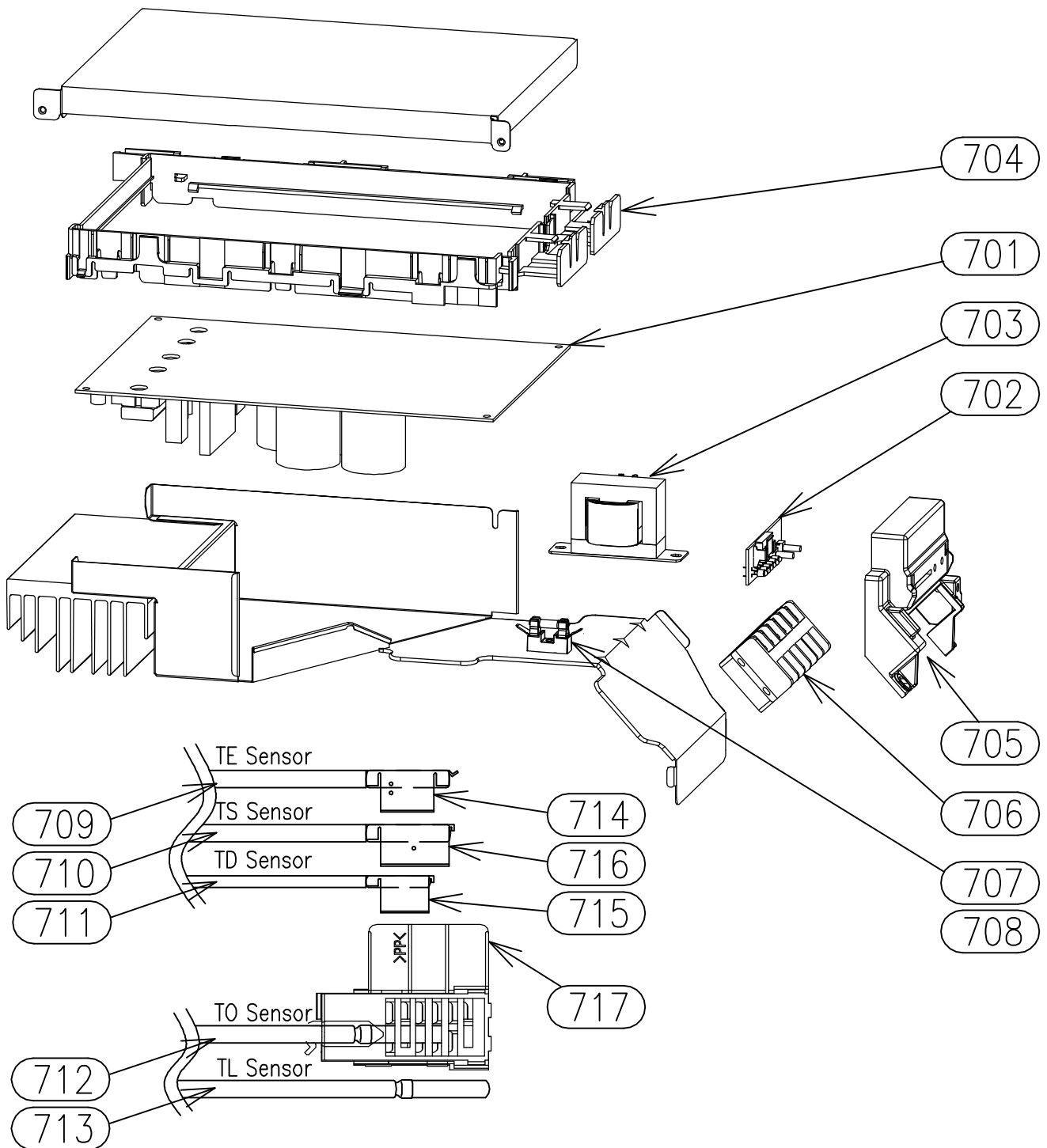

Location No.	Part No.	Description	RAV-		
			SM804ATP-E	SM804ATJP-E	SM804ATP-TR
701	43T6V413	ASM-L-PCB	1	1	1
702	43T6V418	ASM-PCB	1	1	1
703	43T60422	REACTOR(CH-76)	1	1	1
704	43T62313	BASE-PLATE-PC	1	1	1
705	43T61320	ASM-BASE-PL-SUB-PC	1	1	1
706	43T60423	TERMINAL	1	1	1
707	43T60426	FUSE	1	1	1
708	43T60425	FUSE-HOLDER	1	1	1
709	43T50352	TC-SENSOR(TE)	1	1	1
710	43T50353	TC-SENSOR(TS)	1	1	1
711	43T50334	SENSOR(TD)	1	1	1
712	43T50337	SENSOR(TO)	1	1	1
713	43T50335	SENSOR(TL)	1	1	1
714	43T63318	HOLDER-SENSOR(TE)	1	1	1
715	43T63317	HOLDER-SENSOR(TD)	1	1	1
716	43T63323	HOLDER-SENSOR(TS)	1	1	1
717	43T63319	SENSOR-HOLDER(TO)	1	1	1

**14-3. RAV-SM1104ATP-E, SM1104ATJP-E, SM1104ATP-TR
RAV-SM1404ATP-E, SM1404ATPJ-E, SM1404ATP-TR**

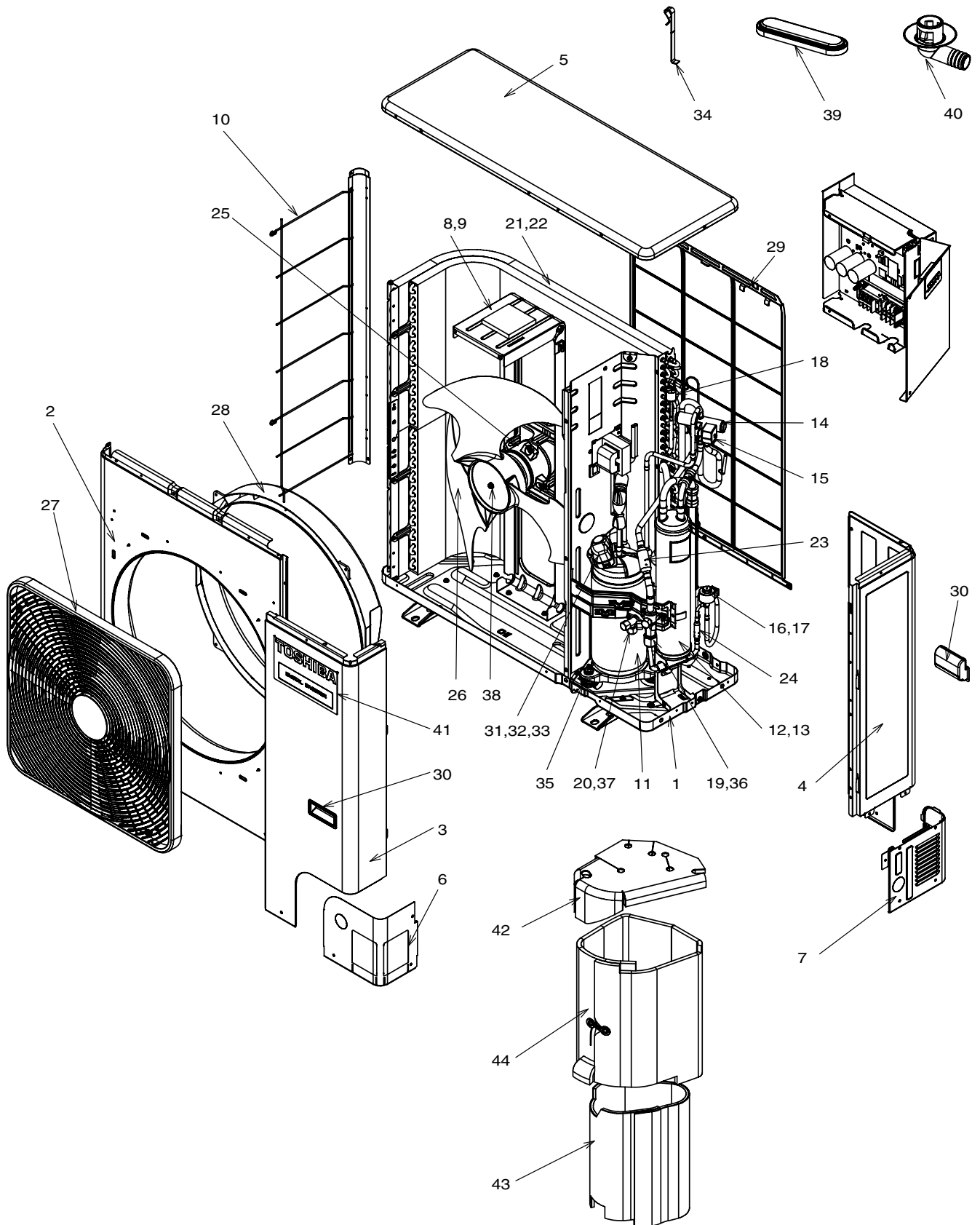

Location No.	Part No.	Description	RAV-SM					
			1104 ATP-E	1404 ATP-E	1104 ATJP-E	1404 ATJP-E	1104 ATP-TR	1404 ATP-TR
1	43T42351	ASM-BASE	1	1	1	1	1	1
2	43T00606	ASM-COAT-C-A-T	1	1	1	1	1	1
3	43T00601	ASM-PANEL-FRONT	1	1	1	1	1	1
4	43T00607	ASM-COAT-P-S-R	1	1	1	1	1	1
5	43T00600	ASM-CABI-UP	1	1	1	1	1	1
6	43T00608	ASM-COAT-P-P-FR	1	1	1	1	1	1
7	43T00609	ASM-COAT-P-P-BK	1	1	1	1	1	1
8	43T39342	BASE-MOTOR	1	1			1	1
9	43T39349	ASM-COAT-BASE-M			1	1		
10	43T19346	ASM-FIN-GUARD	1	1	1	1	1	1
11	43T41494	COMP ASSY	1	1	1	1	1	1
12	43T48301	ASM-ACCUM	1	1			1	1
13	43T48304	ASM-ACCUM			1	1		
14	43T46383	VALVE-4WAY	1	1	1	1	1	1
15	43T63352	COIL-V-4WAY	1	1	1	1	1	1
16	43T46387	BODY-PMV	1	1	1	1	1	1
17	43T63351	COIL-PMV	1	1	1	1	1	1
18	43T63353	SW-PRESS	1	1	1	1	1	1
19	43T46381	VALVE-BALL	1	1	1	1	1	1
20	43T46380	PACKED-VALVE	1	1	1	1	1	1
21	43T43492	ASM-COND	1	1			1	1
22	43T43493	WORK-COND			1	1		
23	43T47372	STRAINER	1	1	1	1	1	1
24	43T47396	STRAINER	1	1	1	1	1	1
25	43T60442	ASM-SERV-MOT	1	1	1	1	1	1
26	43T20337	FAN-PR(PG521)	1	1	1	1	1	1
27	43T19372	GUARD-FAN	1	1	1	1	1	1
28	43T22313	BELL-MOUTH	1	1	1	1	1	1
29	43T19345	GUARD-FIN	1	1	1	1	1	1
30	43T71302	HANDLE	2	2	2	2	2	2
31	43T60443	ASM-LEAD-COMP	1	1	1	1	1	1
32	43T54319	BIMETAL-THERMO	1	1	1	1	1	1
33	43T50307	HOLDER-THERMO	1	1	1	1	1	1
34	43T19333	FIX-P-SENSOR	1	1	1	1	1	1
35	43T49346	RUBBER CUSHION	3	3	3	3	3	3
36	43T47334	BONNET	1	1	1	1	1	1
37	43T47332	BONNET	1	1	1	1	1	1
38	43047669	NUT-FLANGE	1	1	1	1	1	1
39	43089160	CAP-WATERPROOF	5	5	5	5	5	5
40	43T79305	DRAIN-NIPPLE*	1	1	1	1	1	1
41	43T85553	MARK-T	1	1	1	1	1	1
42	43T04314	SOUND-INSU(UP)	1	1	1	1	1	1
43	43T04312	SOUND-INSU(IS)	1	1	1	1	1	1
44	43T04313	SOUND-INSU(OS)	1	1	1	1	1	1

Location No.	Part No.	Description	RAV-		
			SM1104ATP-E SM1404ATP-E	SM1104ATJP-E SM1404ATJP-E	SM1104ATP-TR SM1404ATP-TR
701	43T6V415	ASM-L-PCB	1	1	1
702	43T6V418	ASM-PCB	1	1	1
703	43T61318	CARD-EDGE (convex)	2	2	2
704	43T95302	CARD-EDGE (flat)	1	1	1
705	43T61319	SPACER(COLLAR)	2	2	2
706	43T61315	SPACER(BUSH)	2	2	2
707	43T61321	ASM-BASE-PL-SUB-PC	1	1	1
708	43T60405	TERMINAL (power supply)	1	1	1
709	43T60427	TERMINAL (to indoor unit)	1	1	1
710	43T60413	FUSE(10A/250V)	1	1	1
711	43T60425	FUSE-HOLDER	1	1	1
712	43T50336	SENSOR(TS)	1	1	1
713	43T50338	SENSOR(TE)	1	1	1
714	43T50337	SENSOR(TO)	1	1	1
715	43T50346	SENSOR(TD)	1	1	1
716	43T50335	SENSOR(TL)	1	1	1
717	43T63323	HOLDER-SENSOR(TS)	1	1	1
718	43T63318	HOLDER-SENSOR(TE)	1	1	1
719	43T63335	HOLDER-SENSOR(TO)	1	1	1
720	43T63317	HOLDER-SENSOR(TD)	1	1	1
721	43T60444	ASM-CAPA	1	1	1

WARNINGS ON REFRIGERANT LEAKAGE

Check of Concentration Limit

The room in which the air conditioner is to be installed requires a design that in the event of refrigerant gas leaking out, its concentration will not exceed a set limit.

The refrigerant R410A which is used in the air conditioner is safe, without the toxicity or combustibility of ammonia, and is not restricted by laws to be imposed which protect the ozone layer. However, since it contains more than air, it poses the risk of suffocation if its concentration should rise excessively. Suffocation from leakage of R410A is almost non-existent.

If a conditioner system is to be installed in a small room, select a suitable model and installation procedure so that if the refrigerant accidentally leaks out, its concentration does not reach the limit (and in the event of an emergency, measures can be made before injury can occur).

In a room where the concentration may exceed the limit, create an opening with adjacent rooms, or install mechanical ventilation combined with a gas leak detection device.

The concentration is as given below.

$$\frac{\text{Total amount of refrigerant (kg)}}{\text{Min. volume of the indoor unit installed room (m}^3\text{)}} \leq \text{Concentration limit (kg/m}^3\text{)}$$

The concentration limit of R410A which is used in air conditioners is 0.3kg/m³.

NOTE

The minimum indoor floor area compared with the amount of refrigerant is roughly as follows:
(When the ceiling is 2.7m high)

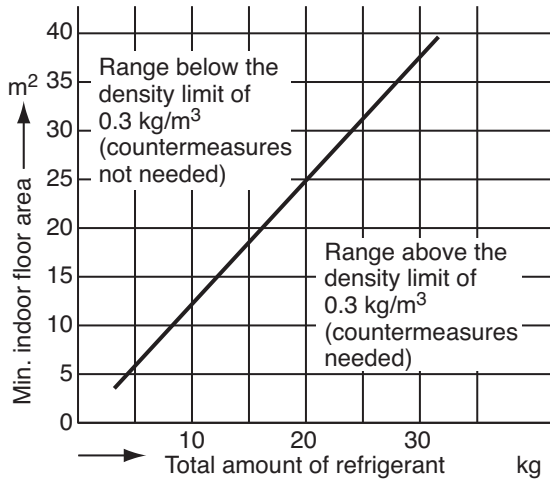

TOSHIBA CARRIER (THAILAND) CO.,LTD.

144/9 MOO 5, BANGKADI INDUSTRIAL PARK, TIVANON ROAD, TAMBOL BANGKADI,
AMPHUR MUANG, PATHUMTHANI 12000, THAILAND.