



Multi Tenant
Function controller
MCM-C210, MCM-C210N

Air Conditioner installation manual

imagine the possibilities

Thank you for purchasing this Samsung product.

SAMSUNG





Safety precautions

English

This installation manual explains how to install a Multi Tenant Function Controller that is connects to indoor unit of Samsung system air conditioner. Please read this manual thoroughly before installing the product. (Please refer to an appropriate installation manual for any optional product installation.)

	WARNING	Hazards or unsafe practices that may result in severe personal injury or death .	
	CAUTION	Hazards or unsafe practices that may result in minor personal injury or property damage .	
	Must follow directions.		Unplug the power plug from the wall socket.
	Do NOT attempt.		Do NOT disassemble.
	Make sure the machine is grounded to prevent electric shock.		

FOR INSTALLATION

WARNING

- Contact a service center for installation.**
 - ▶ Failure to do so may result in product malfunction, water leakage, electric shock and fire.
- You must use the supplied wire for installation.**
 - ▶ Failure to do so may result in fire or damage to a Multi Tenant Function Controller.
- All electric work should comply with local regulations and installation work carried out by a qualified technician.**
 - ▶ Installation by an unqualified technician may result in product malfunction, electric shock, and fire.
- Check whether the installation work is performed in accordance with the installation instructions.**
 - ▶ Incorrect installation of a Multi Tenant Function Controller may result in electric shock or fire.

FOR INSTALLATION

CAUTION

- When connecting a wire, do not tighten it too much.**
 - ▶ Failure to do so may result in breakage of the wire.
- Make sure the Multi Tenant Function Controller installation doesn't cause interference with other electrical appliances, particularly in a hospital etc.**
 - ▶ Failure to do so may result in abnormal operation.
- Do not install the product in an area where combustible gas leaks or possible gas leakage is expected.**
 - ▶ Failure to do so may result in fire or explosion.
- Do not install the product in conditions where it is exposed to oil, steam etc.**
 - ▶ Use of the product in an area exposed to oil, steam, sulfuric acid gas etc may result in component damage or product malfunction.
- Do not install the product in a place where acid or alkali liquid or special sprays are used.**
 - ▶ Failure to do so may result in electric shock or abnormal operation.

FOR OPERATION

WARNING

- Do not remodel or repair the Multi Tenant Function Controller yourself.**
 - ▶ Failure to do so may result in product malfunction, electric shock and fire, so contact a service center for repair.
- When disposing of a Multi Tenant Function Controller, contact a service center.**
- Do not move or reinstall an installed Multi Tenant Function Controller yourself.**
 - ▶ Failure to do so may result in electric shock or fire.

FOR OPERATION

CAUTION







- Make sure that water does not permeate inside the Multi Tenant Function Controller.**
 - ▶ Failure to do so may result in electric shock or fire.
- Do not connect power cable to the control cable terminal.**
 - ▶ Failure to do so may result in fire.



Consignes de sécurité

français





Ce manuel d'installation explique comment installer un contrôleur de fonctions multi-tenant connecté au module intérieur de votre climatiseur Samsung. Veuillez lire attentivement ce manuel préalablement à l'installation de l'appareil. (Concernant l'installation de tout appareil en option, veuillez vous reporter au manuel d'installation approprié.)

 AVERTISSEMENT	Dangers ou usages dangereux pouvant entraîner des blessures graves ou la mort.		
 ATTENTION	Dangers ou usages dangereux pouvant entraîner des blessures mineures ou des dégâts matériels.		
	Suivre impérativement les instructions.		Débrancher la fiche d'alimentation électrique de la prise murale.
	Ne PAS faire.		Ne PAS démonter.
	S'assurer que l'appareil est mis à la terre pour éviter tout choc électrique.		



POUR L'INSTALLATION **AVERTISSEMENT**

-  **Contactez un centre de services pour l'installation.**
 - ▶ Le non-respect de cette consigne risque d'endommager l'appareil et de provoquer fuite d'eau, choc électrique et incendie. **Vous devez utiliser le câble fourni pour l'installation.**
 - ▶ Le non-respect de cette consigne peut provoquer un incendie ou endommager le contrôleur de fonctions multi-tenant. **Tous les travaux électriques doivent être effectués en accord avec la réglementation locale et les travaux d'installation doivent être effectués par un électricien qualifié.**
 - ▶ L'installation par un technicien non qualifié risque d'endommager l'appareil et de provoquer un choc électrique et un incendie. **Vérifiez si les travaux d'installation sont effectués en accord avec les consignes d'installation.**
 - ▶ Une installation incorrecte du contrôleur de fonctions multi-tenant peut provoquer un choc électrique ou un incendie.



POUR L'INSTALLATION **ATTENTION**

-  **Lors du branchement d'un câble, ne le serrez pas trop fort.**
 - ▶ Cela risque d'endommager le câble.
-  **Assurez-vous que le contrôleur de fonctions multi-tenant ne provoque pas d'interférence avec d'autres appareils électriques, en particulier dans un hôpital, etc.**
 - ▶ Le non-respect de cette consigne risque de provoquer un dysfonctionnement.
-  **N'installez pas l'appareil dans un emplacement présentant des fuites de gaz combustible ou s'il existe un risque potentiel de fuite de gaz.**
 - ▶ Le non-respect de cette consigne risque de provoquer un incendie ou une explosion.
-  **N'installez pas l'appareil dans des conditions où il risque d'être exposé à l'huile, à la vapeur, etc.**
 - ▶ L'utilisation de l'appareil dans une zone exposée à l'huile, la vapeur, le gaz acide sulfureux, etc. risque d'endommager l'appareil ou le composant.
-  **N'installez pas l'appareil dans une zone en présence d'acide ou de liquide alcalin ou bien d'une pulvérisation particulière.**
 - ▶ Le non-respect de cette consigne risque de provoquer un choc électrique ou un dysfonctionnement.

POUR LE FONCTIONNEMENT **AVERTISSEMENT**

-  **Ne modifiez pas ni ne réparez pas vous-même le contrôleur de fonctions multi-tenant.**
 - ▶ Le non-respect de cette consigne risque de provoquer un dysfonctionnement de l'appareil, un choc électrique et un incendie. Par conséquent, contactez le service après-vente.
-  **Lors de la mise au rebut du contrôleur de fonctions multi-tenant, veuillez contacter le service après-vente. Ne déplacez pas ou ne réinstallez pas vous-même un contrôleur de fonctions multi-tenant.**
 - ▶ Le non-respect de cette consigne risque de provoquer un choc électrique ou un incendie.

POUR LE FONCTIONNEMENT **ATTENTION**

-  **Veillez à éviter tout contact du contrôleur de fonctions multi-tenant avec de l'eau.**
 - ▶ Le non-respect de cette consigne risque de provoquer un choc électrique ou un incendie.
-  **Ne branchez pas le câble d'alimentation à la borne de commande.**
 - ▶ Le non-respect de cette consigne risque de provoquer un incendie.



Preparing for installation

Checklist before installation

About power supply

Electric transformer and the power cables, for power supply, should be purchased separately and they are not provided by manufacturer.





About installation cables

Each power cables should be wired from the electrical transformer or indoor units to the installation location of the Multi Tenant Function Controller and wiring work must be done in advance so that they can be connected to each other.

About protection box

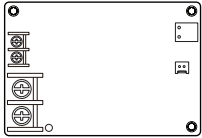
Protection box for the Multi Tenant Function Controller must be purchased separately. Installing the Multi Tenant Function Controller within an Ingress Protection (IP) box or a box made of metal material is recommended.

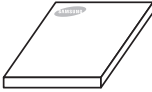
Accessories

Name	Multi Tenant Function Controller	DC power cable (5V)	Installation manual	Holder PBA
Quantity	1	1	1	4
Image				



Name of the parts and product dimension

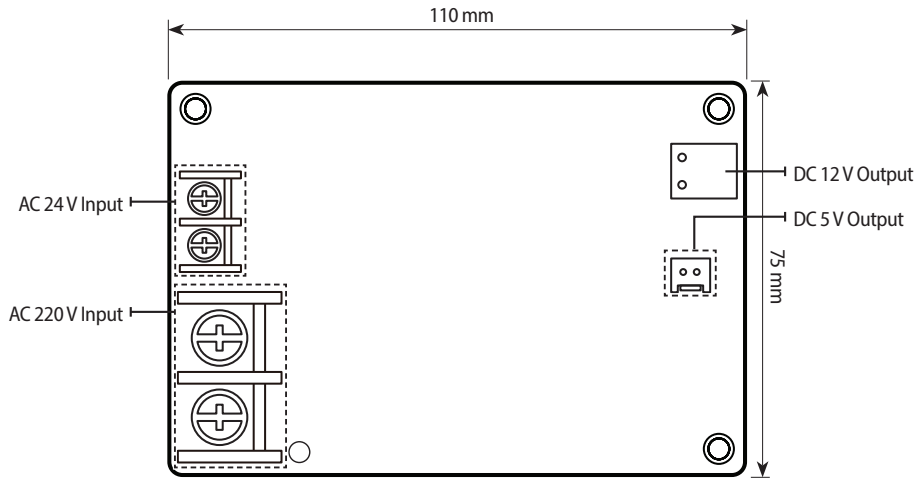

Installation diagram of Multi Tenant Function Controller

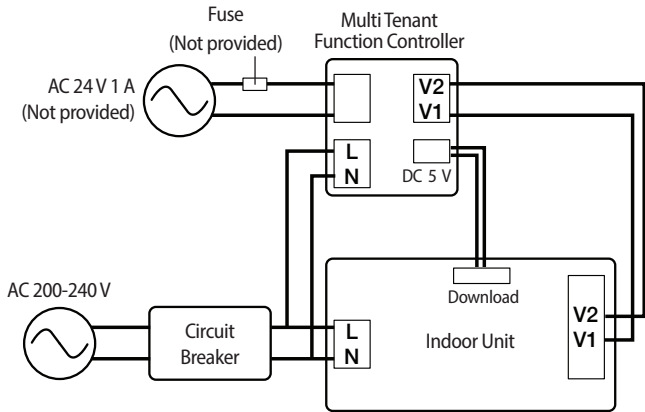

- * When installing a the AC 24 V transformer, use a box or metal material with the same or higher level of fire retardant as the IP box. You should close the gap around the place where wires are input so that any rodents or water cannot come into the box, and then remove all the sharp surfaces.
- AC 24 V needs to be purchased at a local shop. (You should purchase a rated part.)



Installing the product

Installing the Multi Tenant Function Controller box

- ▶ The size of the Multi Tenant Function Controller box should be more than 210 mm(W) x 130 mm(H) x 100 mm(D).
 - ▶ Fix the plate (PD, MD) to the Multi Tenant Function Controller box and assemble the holders (for fixing PBA) to install the Multi Tenant Function Controller.
 - Make 4 holes to fix PBA on the plate.
- * HOLE SIZE : 5 mm diameter

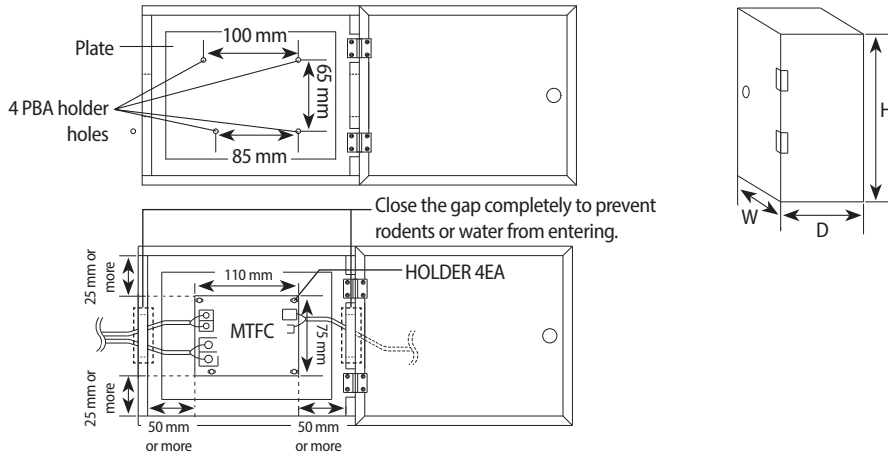

The installation location of Multi Tenant Function Controller box

- ▶ For ceiling type indoor unit, the distance between an indoor unit and the Multi Tenant Function Controller box should be within 3 m.
- * When the Multi Tenant Function Controller is installed, the Multi Tenant Function Controller box should be fixed.
- ▶ For wall-mounted indoor unit, the Multi Tenant Function Controller box should be concealed inside the wall and the distance between an indoor unit and Multi Tenant Function Controller box should be within 3 m.

For ceiling type: 1 WAY CASSETTE, 4 WAY CASSETTE and DUCT

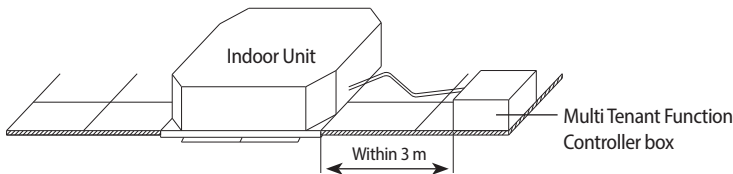

For wall-mounted type

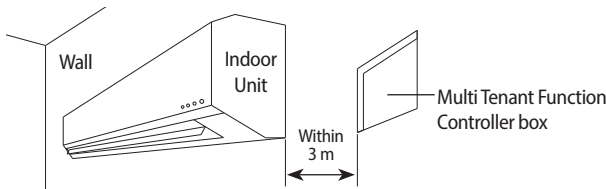



Indoor unit cable connection

- ▶ After cutting off the power of the indoor unit, connect the cable between the AC POWER terminal block of the indoor unit and the INDOOR POWER terminal block of the Multi Tenant Function Controller.
- ▶ Connect the cable between the Communication/Power terminal block V1/V2 of the indoor unit and the V1/V2 of the Multi Tenant Function Controller, complying the correct voltage polarity.
 - * If the cable is connected incorrectly, Multi Tenant Function Controller will not work properly. Furthermore, indoor unit communication error may occur and entire system may stop.
- ▶ Connect the DC power cable (5 V), which is included in the box, between the DOWNLOAD connector of the indoor unit and the DC 5 V connector of the Multi Tenant Function Controller.
 - * If you cut the DC power cable (5 V) and extend it on your own, it may cause problem on the product.
- ▶ To check the connection of the cable, disconnect the AC power cable of the indoor unit and supply the AC 24 V power. If the green LED of the Multi Tenant Function Controller turns on, cable is correctly connected.
 - * If the green LED of the Multi Tenant Function Controller does not turn on, check if the polarity of the V1 and V2 are correct.
- ▶ For the products with no V1 and V2 terminal block on the indoor units (such as RAC, 2WAY), connect the #1 wire (RED) of the 4P connector wire, connected to the communication SUB PCB, to the V1. (V2 connection is not required)

Use UL Standard, Class 2, AC 24 V
1 A electric transformer

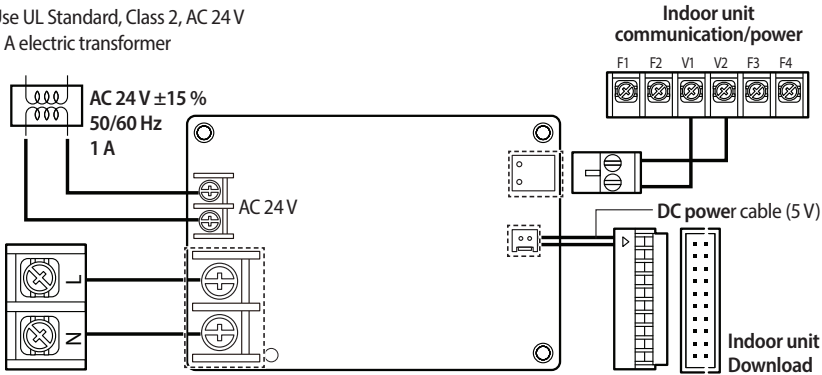

AC power for an indoor unit

INDOOR POWER

Connecting power cable

1. Make sure to cut-off the power before connecting the power cable.
2. Use appropriate tools to connect the cables firmly within rated torque range so that it can withstand external forces, and arrange the cables neatly so that cover or any other parts won't get loose. When the connection is loose, there is risk of overheat, electric shock or fire.
 - * Tightening torque: 6 N·cm



• Specification of the compatible compressed terminal

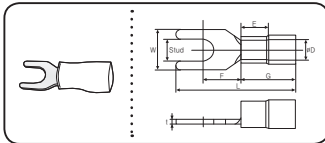

Range of permitted wires		Rated size	Stud size	Basic size (mm)						
AWG	mm ²	mm ²	mm	t	øD	G	E	F	W	L
22~16	0.25~1.65	1.5	3	0.7	3.8	10.0	4.5	6.5	6.0	21.2



Installing the product

Selecting a compressed terminal (Specification for connecting power supply of an indoor unit)

1. Select a solderless ring terminal for a power cable according to the nominal dimensions for cable.
2. Apply insulation coating to the connection part of the solderless ring terminal and the power cable.

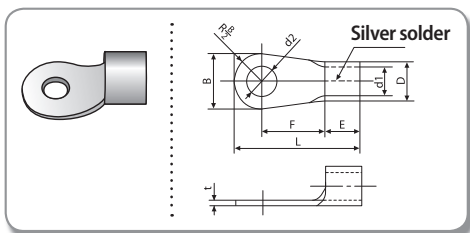

Nominal dimensions for cable		1.5		2.5		4
Nominal dimensions for screw		4	4	4	4	4
B	Standard dimension	6.6	8	6.6	8.5	9.5
	Allowance	±0.2		±0.2		±0.2
D	Standard dimension	3.4		4.2		5.6
	Allowance	+0.3 -0.2		+0.3 -0.2		+0.3 -0.2
d1	Standard dimension	1.7		2.3		3.4
	Allowance	±0.2		±0.2		±0.2
E	Minimum	4.1		6		6
F	Minimum	6		6		5
L	Maximum	16		17.5		20
d2	Standard dimension	4.3		4.3		4.3
	Allowance	+0.2 0		+0.2 0		+0.2 0
t	Minimum	0.7		0.8		0.9

Setting indoor unit installation option

- ▶ To use the Multi Tenant Function Controller, installation option must be changed.
- ▶ SEG2 of the installation option on installed indoor units must be set to '5' and SEG11 must be set to '2'.
 - * SEG11: 0 (Disable Multi Tenant Function Controller) / 2 (Enable Multi Tenant Function Controller)
 - * For detail information on the method of setting the installation option, please refer to the indoor unit installation manual.



- Wired remote controller for group control cannot be installed to an indoor unit which Multi Tenant Function controller was installed.
- EEV operation of the stopped Heat mode will be controlled in same condition as noise reduction control option (0/80 option) when Multi Tenant Function Controller operates.
- If the Multi Tenant Function Controller operates while multiple indoor units are working in mixed operation mode (cooling and heating at the same time), dew may form on the indoor unit fan.



Installation example of Multi Tenant Function Controller

When installing one transformer with one MTFC (Multi Tenant Function Controller)

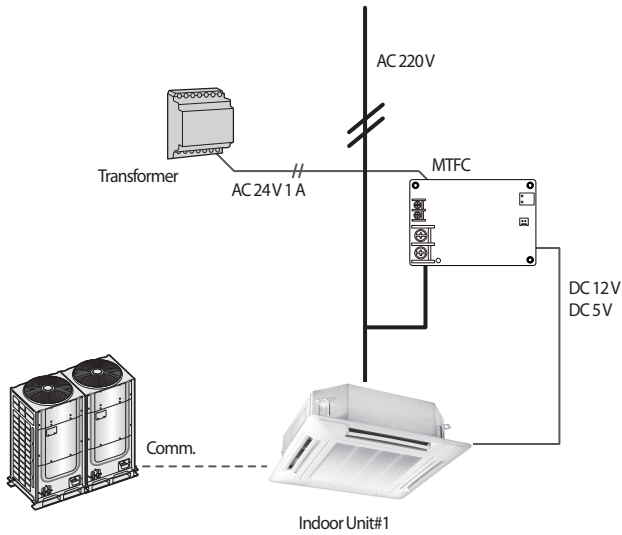

When installing one transformer with multiple MTFCs (Multi Tenant Function Controller)

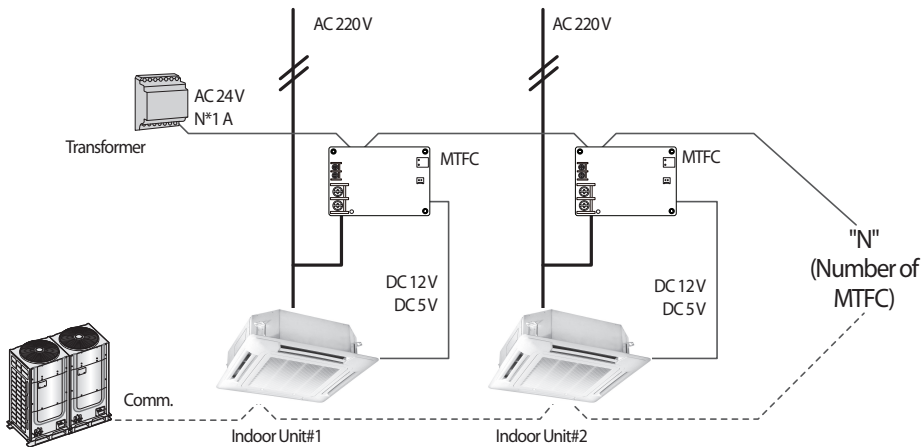

- ▶ When one transformer is installed with multiple MTFCs, current capacity setting should be 1 A x number of MTFC.





SAMSUNG

