



Air conditioner

Installation manual

AM093MNQDEH

- Thank you for purchasing this Samsung air conditioner.
- Before operating this unit, please read this manual carefully and retain it for future reference.



SAMSUNG

Contents

Safety Precautions

3

General information
Installing the unit
Power supply line, fuse or circuit breaker

Installation Procedure

5

Step 1 Checking and preparing accessories
Step 2 Selecting the installation location
Step 3 Installing the indoor unit
Step 4 Purging the unit
Step 5 Connecting the refrigerant pipe
Step 6 Cutting or flaring the pipes
Step 7 Performing leak test
Step 8 Wrapping the pipes with the insulation
Step 9 Installing the drain hose
Step 10 Optional: Changing direction of the drain hose
Step 11 Connecting the power and communication cables
Step 12 Optional: Extending the power cable
Step 13 Setting an indoor unit address and installation option
Step 14 Performing the final check
Step 15 Providing information for user

Appendix

31

Troubleshooting

Safety Precautions

Carefully follow the precautions listed below because they are essential to guarantee the safety of the equipment.

WARNING

- Always disconnect the air conditioner from the power supply before servicing it or accessing its internal components.
- Verify that installation and testing operations are performed by qualified personnel.
- Verify that the air conditioner is not installed in an easily accessible area.

General information

- Carefully read the content of this manual before installing the air conditioner and store the manual in a safe place in order to be able to use it as reference after installation.
- For maximum safety, installers should always carefully read the following warnings.
- Store the operation and installation manual in a safe location and remember to hand it over to the new owner if the air conditioner is sold or transferred.
- This manual explains how to install an indoor unit with a split system with two SAMSUNG units. The use of other types of units with different control systems may damage the units and invalidate the warranty. The manufacturer shall not be responsible for damages arising from the use of non compliant units.
- The manufacturer shall not be responsible for damage originating from unauthorized changes or the improper connection of electric and hydraulic lines. Failure to comply with these instructions or to comply with the requirements set forth in the "Operating limits" table, included in the manual, shall immediately invalidate the warranty.
- The air conditioner should be used only for the applications for which it has been designed: the indoor unit is not suitable to be installed in areas used for laundry.
- Do not use the units if damaged. If problems occur, switch the unit off and disconnect it from the power supply.
- In order to prevent electric shocks, fires or injuries, always stop the unit, disable the protection switch and contact SAMSUNG's technical support if the unit produces smoke, if the power cable is hot or damaged or if the unit is very noisy.

- Always remember to inspect the unit, electric connections, refrigerant tubes and protections regularly. These operations should be performed by qualified personnel only.
- The unit contains moving parts, which should always be kept out of the reach of children.
- Do not attempt to repair, move, alter or reinstall the unit. If performed by unauthorized personnel, these operations may cause electric shocks or fires.
- Do not place containers with liquids or other objects on the unit.
- All the materials used for the manufacture and packaging of the air conditioner are recyclable.
- The packing material and exhaust batteries of the remote control(optional) must be disposed of in accordance with current laws.
- The air conditioner contains a refrigerant that has to be disposed of as special waste. At the end of its life cycle, the air conditioner must be disposed of in authorized centers or returned to the retailer so that it can be disposed of correctly and safely.

Installing the unit

- **IMPORTANT:** When installing the unit, always remember to connect first the refrigerant tubes, then the electrical lines. Always disassemble the electric lines before the refrigerant tubes.
- Upon receipt, inspect the product to verify that it has not been damaged during transport. If the product appears damaged, DO NOT INSTALL it and immediately report the damage to the carrier or retailer (if the installer or the authorized technician has collected the material from the retailer.)
- After completing the installation, always carry out a functional test and provide the instructions on how to operate the air conditioner to the user.
- Do not use the air conditioner in environments with hazardous substances or close to equipment that release free flames to avoid the occurrence of fires, explosions or injuries.
- The air conditioner should be used only for the applications for which it has been designed: the indoor unit is not suitable to be installed in areas used for laundry.

Contents

- Our units must be installed in compliance with the spaces indicated in the installation manual to ensure either accessibility from both sides or ability to perform routine maintenance and repairs. The units' components must be accessible and that can be disassembled in conditions of complete safety either for people or things. For this reason, where it is not observed as indicated into the Installation Manual, the cost necessary to reach and repair the unit (in safety, as required by current regulations in force) with slings, trucks, scaffolding or any other means of elevation won't be considered in-warranty and charged to end user.

Power supply line, fuse or circuit breaker

- Always make sure that the power supply is compliant with current safety standards. Always install the air conditioner in compliance with current local safety standards.
- Always verify that a suitable grounding connection is available.
- Verify that the voltage and frequency of the power supply comply with the specifications and that the installed power is sufficient to ensure the operation of any other domestic appliance connected to the same electric lines.
- Always verify that the cut-off and protection switches are suitably dimensioned.
- Verify that the air conditioner is connected to the power supply in accordance with the instructions provided in the wiring diagram included in the manual.
- Always verify that electric connections (cable entry, section of leads, protections..) are compliant with the electric specifications and with the instructions provided in the wiring scheme. Always verify that all connections comply with the standards applicable to the installation of air conditioners.
- Be sure not to perform power cable modification, extension wiring, and multiple wire connection.
 - It may cause electric shock or fire due to poor connection, poor insulation, or current limit override.
 - When extension wiring is required due to power line damage, refer to "Step 12 Optional: Extending the power cable" in the installation manual.

CAUTION

- Make sure that you earth the cables.
 - Do not connect the earth wire to the gas pipe, water pipe, lighting rod or telephone wire. If earthing is not complete, electric shock or fire may occur.
- Install the circuit breaker.
 - If the circuit breaker is not installed, electric shock or fire may occur.
- Make sure that the condensed water dripping from the drain hose runs out properly and safely.
- Install the power cable and communication cable of the indoor and outdoor unit at least 1m away from the electric appliance.
- Install the indoor unit away from lighting apparatus using the ballast.
 - If you use the wireless remote control, reception error may occur due to the ballast of the lighting apparatus.
- Do not install the air conditioner in following places.
 - Place where there is mineral oil or arsenic acid. Resin parts flame and the accessories may drop or water may leak. The capacity of the heat exchanger may reduce or the air conditioner may be out of order.
 - The place where corrosive gas such as sulfurous acid gas generates from the vent pipe or air outlet. The copper pipe or connection pipe may corrode and refrigerant may leak.
 - The place where there is a machine that generates electromagnetic waves. The air conditioner may not operate normally due to control system.
 - The place where there is a danger of existing combustible gas, carbon fiber or flammable dust. The place where thinner or gasoline is handled. Gas may leak and it may cause fire.
- Please cover the air conditioner with PE BAG after installation, and remove it when you start to run air conditioner.

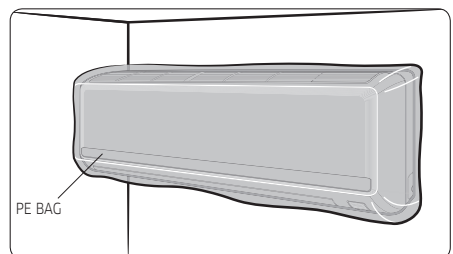





Installation Procedure

Step 1 Checking and preparing accessories

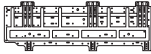
The following accessories are supplied with the indoor unit.

The type and quantity may differ depending on the specifications.

Installation plate	Installation manual
	
User manual	PE indoor unit cover
	

Step 2 Selecting the installation location

Indoor Unit

- Where airflow is not blocked.
- Where cool air can be distributed throughout the room.
- Install the refrigerant piping length and the height difference of both indoor and outdoor units as indicated in the installation diagram.
- Wall that prevents vibration and is strong enough to hold the product weight.
- Out of the direct sunlight .
- 1m or more away from the TV or radio (to prevent the screen from being distorted or noise from being generated).
- As far away as possible from fluorescent and incandescent lights (so that the remote control can be operated well).
- A place where the air filter can be replaced easily.

⚠ CAUTION

- Avoid the following places to prevent malfunction of the unit
 - Where there is machine oil
 - Salty environment such as the seaside areas
 - Where sulfide gas exists
 - Other special atmosphere areas

Space requirements for installation & service

Observe the clearances and maximum lengths as seen in the picture below when installing the air conditioner.

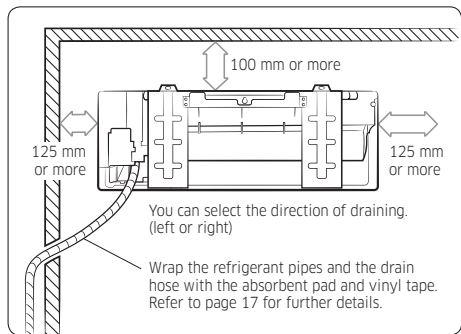

📄 NOTE

- The appearance of the unit may be different from the diagram depending on the model.

Installation Procedure

Step 3 Installing the indoor unit

Before fixing the installation plate to the wall or window frame, you must determine the position of the 65 mm hole through which the cable, pipe and hose pass to connect the indoor unit to the outdoor unit.

When facing the wall, the pipe and cable can be connected from the:

- Right
- Left
- Underside (right)
- Rear (right or left)

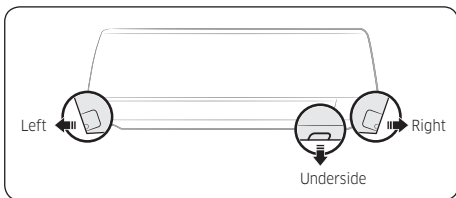

- 1 Determine the position of the pipe and drain hose hole as seen in the picture and drill the hole with an inner diameter of 65 mm so that it slants slightly downwards.

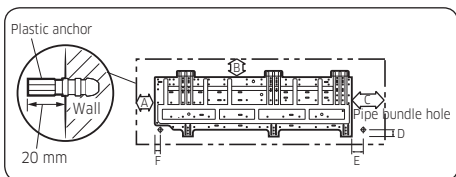

Pipe bundle hole: \varnothing 65 mm (Unit : mm)

Model	A	B	C	D	E	F
AM093MNQDEH	156	67	364	34.5	64.5	19.5

- 2 If you fix the indoor unit to a wall, fix the installation plate to the wall giving attention to the weight of the indoor unit.

NOTE

- If you mount the plate to a concrete wall by using plastic anchors, make sure that gaps between the wall and the plate, created by projected anchor, are less than 20 mm.

- 3 If you fix the indoor unit to a window frame, follow 4 to 6.
- 4 Determine the positions of the wooden uprights to be attached to the window frame.
- 5 Attach the wooden uprights to the window frame giving attention to the weight of the indoor unit.
- 6 Attach the installation plate to the wooden uprights using tapping screw.

Step 4 Purging the unit

Upon delivery, there may be inert gas inside the indoor unit. Purge the gas from the indoor unit before connecting the assembly pipe.

- Unscrew the caps at the end of each pipe. All inert gas exhausts from the indoor unit.

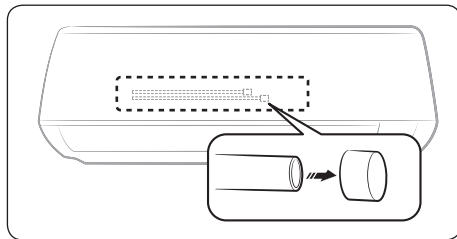

NOTE

- To prevent dirt or foreign substances from getting into the pipes during installation, do NOT remove the caps completely until you are ready to connect the pipes.

Step 5 Connecting the refrigerant pipe

Connect indoor and outdoor units with field-supplied copper pipes by means of flare connections. Use insulated seamless refrigeration grade pipe only, (Cu DHP type according to ISO1337), degreased and deoxidized, suitable for operating pressures of at least 4200 kPa and for burst pressure of at least 20700 kPa. Under no circumstances must sanitary type copper pipe be used.

There are 2 refrigerant pipes of different diameters:

- The smaller one is for the liquid refrigerant
- The larger one is for the gas refrigerant

A short pipe is already fitted to the air conditioner. You may need to extend the pipe using the assembly pipe. (optional)

The connection procedure for the refrigerant pipe varies according to the exit position of the pipe when facing the wall:

- Right (A)
- Left (B)
- Underside (C)
- Rear

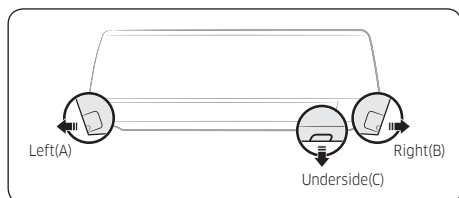

- 1 Cut out the appropriate knock-out piece on the rear of the indoor unit unless you connect the pipe directly from the rear.
- 2 Smooth the cut edges.
- 3 Remove the protection caps of the pipes and connect the assembly pipe to each pipe. Tighten the nuts first with your hands, and then with a torque wrench, applying the following torque:

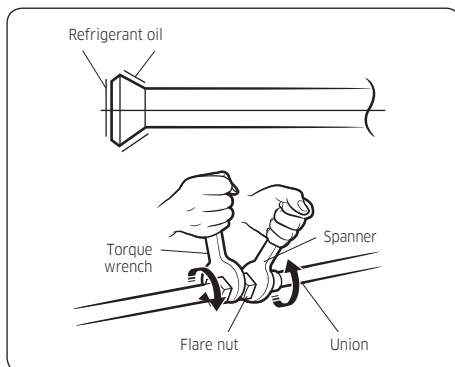

Outer diameter (mm)	Torque (N•m)	Torque (kgf•cm)
6.35	14~18	140~180
9.52	34~42	350~430
12.70	49~61	500~620
15.88	68~82	690~830

NOTE

- If you want to shorten or extend pipes, refer to Step 6 Cutting or flaring the pipes.
- 4 Cut off the remaining foam insulation.
 - 5 If necessary, bend the pipe to fit along the bottom of the indoor unit. Then pull it out through the appropriate hole.
 - The pipe should not project from the rear of the indoor unit.
 - The bending radius should be 100 mm or more.
 - 6 Pass the pipe through the hole in the wall.
 - 7 For further details on how to connect to the outdoor unit and purge the air, refer to Step 4 Purging the unit.

NOTE

- The pipe will be insulated and fixed permanently into position after finishing the installation and the gas leak test; refer to page 9 for further details.
- **DO NOT WALL UP THE PIPE CONNECTION!**
All refrigerant pipe connection must be easy accessible and serviceable.

Installation Procedure

Step 6 Cutting or flaring the pipes

(Unit: mm)

- 1 Make sure that you prepared the required tools. (pipe cutter, reamer, flaring tool and pipe holder)
- 2 If you want to shorten the pipe, cut it using a pipe cutter ensuring that the cut edge remains at 90° with the side of the pipe. There are some examples of correctly and incorrectly cut edges below.

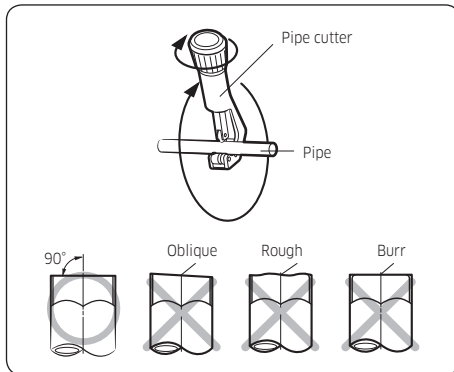

- 3 To prevent a gas leak, remove all burrs at the cut edge of the pipe using a reamer.
- 4 Carry out flaring work using flaring tool as shown below.

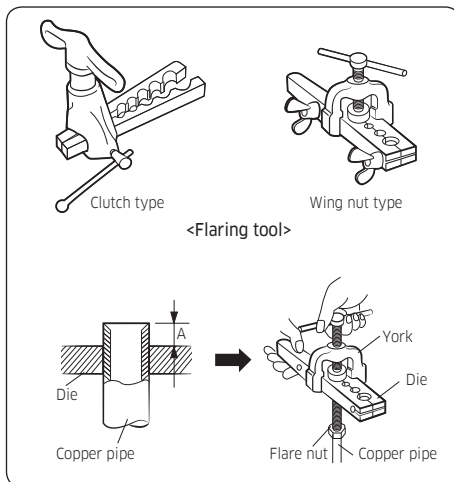

Outer diameter	A		
	Flare tool for R410A clutch type	Conventional flare tool	
		Clutch type	Wing nut type
6.35	0°~0.5	1.0°~1.5	1.5°~2.0
9.52	0°~0.5	1.0°~1.5	1.5°~2.0
12.70	0°~0.5	1.0°~1.5	1.5°~2.0
15.88	0°~0.5	1.0°~1.5	1.5°~2.0

- 5 Check if you flared the pipe correctly. There are some examples of incorrectly flared pipes below.

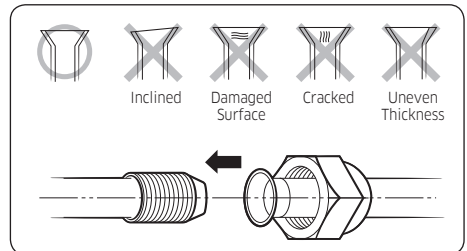

- 6 Align the pipes and tighten the flare nuts first manually and then with a torque wrench, applying the following torque.

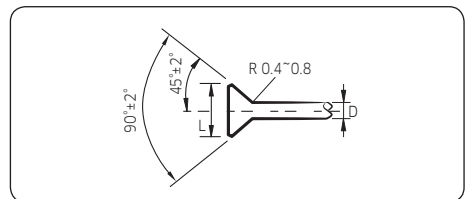

Outer diameter (D, mm)	Connection Torque		Flare dimension (L, mm)
	kgf·cm	N·m	
6.35	140~180	14~18	8.70~9.10
9.52	350~430	34~42	12.80~13.20
2.70	500~620	49~61	16.20~16.60
15.88	690~830	68~82	19.30~19.70

⚠ CAUTION

- In case of needing brazing, you must work with nitrogen gas blowing.

Step 7 Performing leak test

Leak test

LEAK TEST WITH NITROGEN (before opening valves)
In order to detect basic refrigerant leaks, before recreating the vacuum and recirculating the R410A, it's responsible of installer to pressurize the whole system with nitrogen (using a pressure regulator) at a pressure above 4.1MPa (gauge).

LEAK TEST WITH R410A (after opening valves)
Before opening valves, discharge all the nitrogen into the system and create vacuum. After opening valves check leaks using a leak detector for refrigerant R410A.

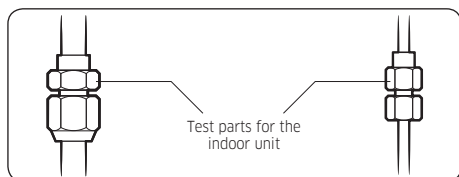

⚠ CAUTION

- Discharge all the nitrogen to create a vacuum and charge the system.

Step 8 Wrapping the pipes with the insulation

After checking for gas leaks in the system, insulate the pipe, hose and cables. Then place the indoor unit on the installation plate.

- To avoid condensation problems, place heat-resistant poly-ethylene foam separately around each refrigerant pipe in the lower part of the indoor unit.

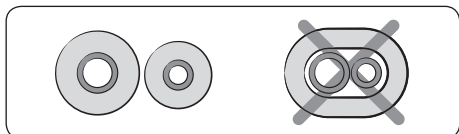

- Wrap the refrigerant pipe and the drain hose in the rear of the indoor unit with the absorbent pad.

📖 NOTE

- Wind the pipe and hose three times to the end of the indoor unit with the absorbent pad. (20mm interval)
- Wind the pipe, assembly cable and drain hose with insulation tape.
 - Place the bundle (the pipe, assembly cable and drain hose) in the lower part of the indoor unit carefully so it doesn't project from the rear of the indoor unit.

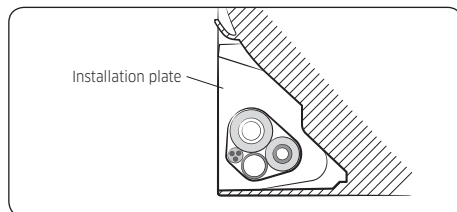

- Hook the indoor unit to the installation plate and move the unit to the right and left until it is securely in place.
- Wrap the rest of the pipe with vinyl tape.
- Attach the pipe to the wall using clamps (optional).

Installation Procedure

Step 9 Installing the drain hose

When installing the drain hose for the indoor unit, check if condensation draining is adequate. When passing the drain hose through the 65-mm hole drilled in the wall, check the following:

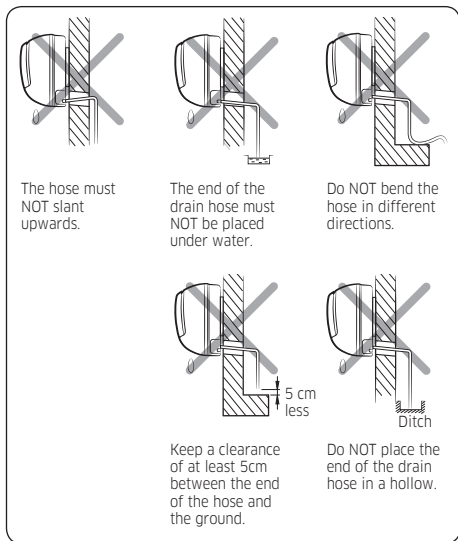

- 1 If necessary, connect the 2-meter extension drain hose to the drain hose.
- 2 If you use the extension drain hose, insulate the inside of the extension drain hose with a shield.
- 3 Fit the drain hose into 1 of 2 drain hose holes, then fix the end of the drain hose tightly with a clamp.

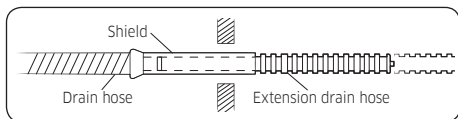

NOTE

- If you don't use the other drain hose hole, block it with a rubber stopper.

- 4 Pass the drain hose under the refrigerant pipe, keeping the drain hose tight.
- 5 Pass the drain hose through the hole in the wall. Check if it slants downwards as seen in the picture.

NOTE

- The hose will be fixed permanently into position after finishing the installation and the gas leak test; refer to page 12 for further details.
- DO NOT WALL UP THE DRAIN HOSE CONNECTION! Drain hose connection must be easy accessible and serviceable.

Step 10 Optional: Changing direction of the drain hose

You can select the direction of the drain hose, depending on where you want to install the indoor unit.

- 1 Detach the rubber cap with the flyer.

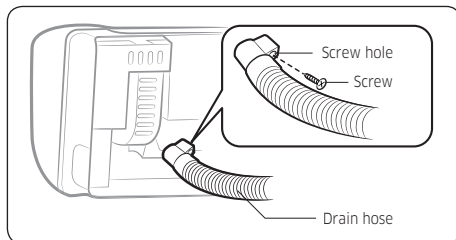

- 2 Detach the drain hose by pulling it and turning to the left.
- 3 Insert the drain hose by fixing it into the groove of the drain hose and the outlet of the drain pan.

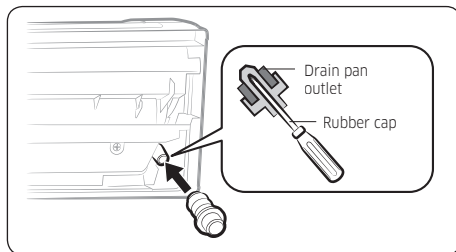

- 4 Attach the rubber cap with a screwdriver by turning it to the right until it fixes to the end of the groove.

Step 11 Connecting the power and communication cables

- 1 Before wiring work, you must turn off all power source.
- 2 Indoor unit power should be supplied through the breaker(ELCB or MCCB+ELB) separated by the outdoor power.
 - ELCB:Earth Leakage Circuit Breaker
 - MCCB:Molded Case Circuit Breaker
 - ELB:Earth Leakage Breaker
- 3 The power cable should be used only copper wires.
- 4 Connect the power cable{1(L), 2(N)} among the units within maximum length and communication cable(F1, F2) each.

- 5 Cut the cable as like the following picture. The earth cable need to be longer than the power cable (1(L), 2(N)) by 100 mm.

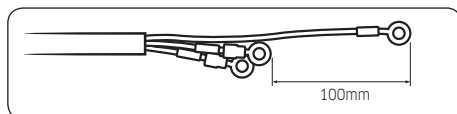

- 6 Connect the earth cable to the plate on the evaporator as like the following picture.

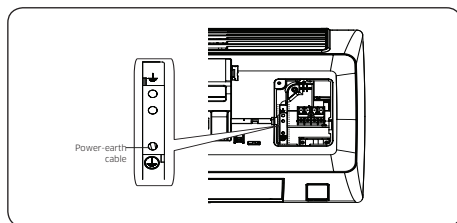

- 7 Connect F3, F4(for communication) wires at the back side of the indoor unit when installing the wired remote control.

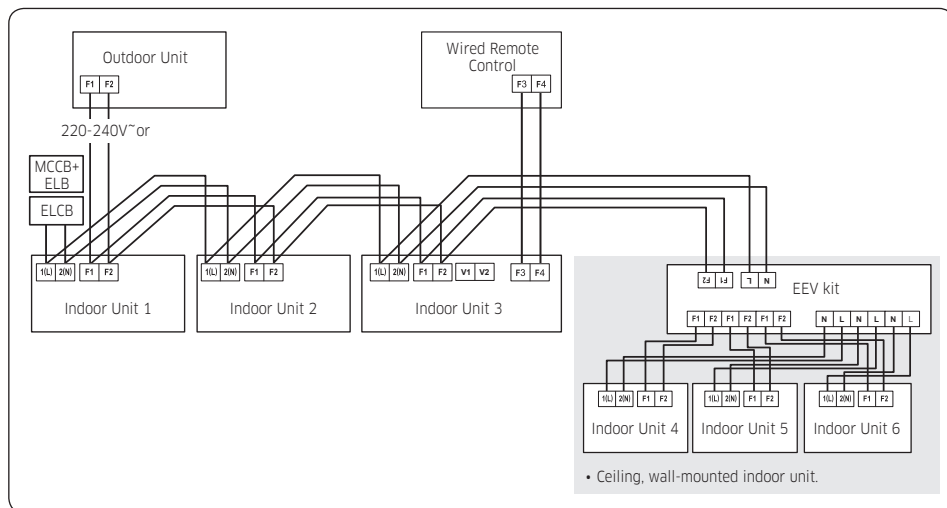

- ELCB : Essential Installation
- The EEV Kit is optional component.

WARNING

- Power off before connecting any wires;Indoor PBA will be damaged while V1,V2,F3,F4 short each other.
- You must connect the earth cable. If earthing is not complete, electric shock or fire may occur.

Installation Procedure

Ring terminal selection

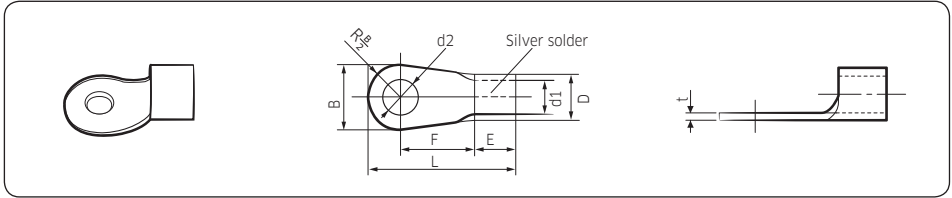

Normal dimensions for cable (mm ²)	Normal dimensions for screw (mm)	B		C		d1		E	F	L	d2		t
		Standard dimension (mm)	Allowance (mm)	Standard dimension (mm)	Allowance (mm)	Standard dimension (mm)	Allowance (mm)				Standard dimension (mm)	Allowance (mm)	
1.5	4	6.6	±0.2	3.4	+0.3 -0.2	1.7	±0.2	4.1	6	16	4.3	+0.2 0	0.7
	4	8											
2.5	4	6.6	±0.2	4.2	+0.3 -0.2	2.3	±0.2	6	6	17.5	4.3	+0.2 0	0.8
	4	8.5											
4	4	9.5	±0.2	5.6	+0.3 -0.2	3.4	±0.2	6	5	20	4.3	+0.2 0	0.9

Specification of electronic wire

Power supply	MCCB	ELB or ELCB	Power cable	Earth cable	Communication cable
Max : 242V / Min : 198V	XA	XA, 30 mmA, 0.1 s	2.5 mm ²	2.5 mm ²	0.75~1.5 mm ²

- Refer to the unit nameplate for rating current.
- Decide the capacity of ELCB(or MCCB+ELB) by below formula.
- Power supply cords of parts of appliances for outdoor use shall not be lighter than polychloroprene sheathed flexible cord. (Code designation IEC:60245 IEC 57 / CENELEC: H05RN-F or IEC:60245 IEC 66 / CENELEC: H07RN-F)

The capacity of ELCB(or MCCB+ELB) $X[A] = 1.25 \times 1.1 \times \sum A_i$

- X : The capacity of ELCB(or MCCB+ELB).
- $\sum A_i$: Sum of Rating currents of each indoor unit.
- Refer to each installation manual about the rating current of indoor unit.

- Decide the power cable specification and maximum length within 10% power drop among indoor units.

$$\sum_{k=1}^n \left(\frac{\text{Coef} \times 35.6 \times L_k \times i_k}{1000 \times A_k} \right) < 10\% \text{ of input voltage[V]}$$

- coef: 1.55
- Lk: Distance among each indoor unit[m],
- Ak: Power cable specification[mm²]
- ik: Running current of each unit[A]

Example of Installation

- Total power cable length L = 100(m), Running current of each units 1[A]
- Total 10 indoor units were installed

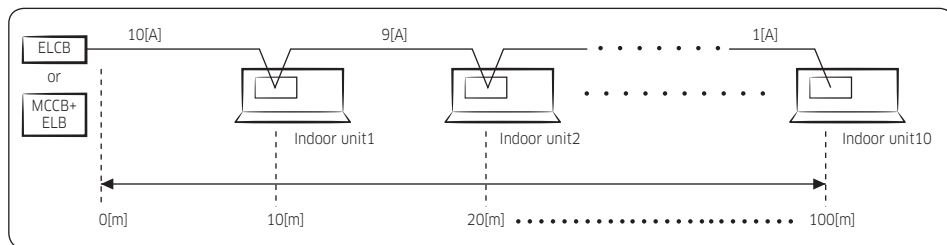

- Apply following equation.

$$\sum_{k=1}^n \left(\frac{\text{Coef} \times 35.6 \times L_k \times I_k}{1000 \times A_k} \right) < 10\% \text{ of input voltage[V]}$$

- Calculation

- Installing with 1 sort wire

$$\frac{2.5 \text{ [mm}^2\text{]}}{-2.2 \text{ [V]}} + \frac{2.5 \text{ [mm}^2\text{]}}{-2.0 \text{ [V]}} + \dots + \frac{2.5 \text{ [mm}^2\text{]}}{\dots} \rightarrow \text{Within } 198\text{V to } 242\text{V}$$

220 [V] 208.8 [V] : it's okay

$$-(2.2+2.0+1.8+1.5+1.3+1.1+0.9+0.7+0.4+0.2)=-11.2 \text{ [V]}$$

- Installing with 2 different sort wire.

$$\frac{4.0 \text{ [mm}^2\text{]}}{-1.4 \text{ [V]}} + \frac{4.0 \text{ [mm}^2\text{]}}{-1.2 \text{ [V]}} + \dots + \frac{2.5 \text{ [mm}^2\text{]}}{\dots} \rightarrow \text{Within } 198\text{V to } 242\text{V}$$

220 [V] 209.5 [V] : it's okay

$$-(1.4+1.2+1.8+1.5+1.3+1.1+0.9+0.7+0.4+0.2)=-10.5 \text{ [V]}$$

CAUTION

- Select the power cable in accordance with relevant local and national regulations.
- Wire size must comply with local and national code.
- For the power cable, use the grade of H07RN-F or H05RN-F materials.
- You should connect the power cable into the power cable terminal and fasten it with a clamp.
- The unbalanced power must be maintained within 10% of supply rating among whole indoor units.
- If the power is unbalanced greatly, it may shorten the life of the condenser. If the unbalanced power is exceeded over 10% of supply rating, the indoor unit is protected, stopped and the error mode indicates.
- To protect the product from water and possible shock, you should keep the power cable and the connection cord of the indoor and outdoor units in the iron pipe.
- Connect the power cable to the auxiliary circuit breaker. An all pole disconnection from the power supply must be incorporated in the fixed wiring(≥3mm).





Installation Procedure

- You must keep the cable in a protection tube.
- Keep distances of 50mm or more between power cable and communication cable.
- Maximum length of power cables are decided within 10% of power drop. If it exceeds, you must consider another power supplying method.
- The circuit breaker(ELCB or MCCB+ELB) should be considered more capacity if many indoor units are connected from one breaker.
- Use round pressure terminal for connections to the power terminal block.
- For wiring, use the designated power cable and connect it firmly, then secure to prevent out-side pressure being exerted on the terminal board.
- Use an appropriate screwdriver for tightening the terminal screws. A screwdriver with a small head will strip the head and make proper tightening impossible.
- Over-tightening the terminal screws may break them.
- See the table below for tightening torque for the terminal screws.

Tightening torque		
	N•m	kgf•cm
M3.5	0.8~1.2	8.0~12.0
M4	1.2~1.8	12.0~18.0

Step 12 Optional: Extending the power cable

- 1 Prepare the following tools.

Tools	Spec	Shape
Crimping pliers	MH-14	
Connection sleeve (mm)	20xØ6.5 (HxOD)	
Insulation tape	Width 19 mm	
Contraction tube (mm)	70xØ8.0 (LxOD)	

- 2 As shown in the figure, peel off the shields from the rubber and wire of the power cable.
 - Peel off 20 mm of cable shields from the pre-installed tube.

CAUTION

- For information about the power cable specifications for indoor and outdoor units, refer to the installation manual.
- After peeling off cable wires from the pre-installed tube, insert a contraction tube.

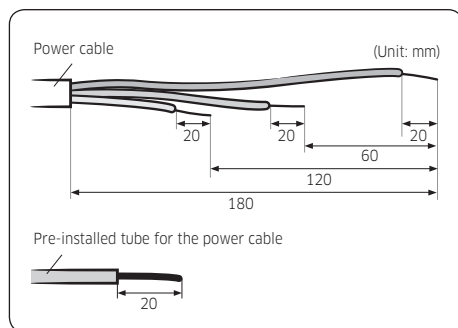

- 3 Insert both sides of core wire of the power cable into the connection sleeve.
- **Method 1:** Push the core wire into the sleeve from both sides.
 - **Method 2:** Twist the wire cores together and push it into the sleeve.

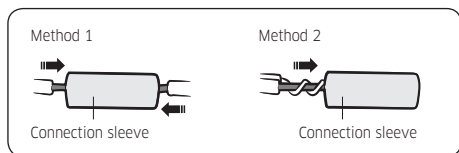

- 4 Using a crimping tool, compress the two points and flip it over and compress another two points in the same location.
- The compression dimension should be 8.0.

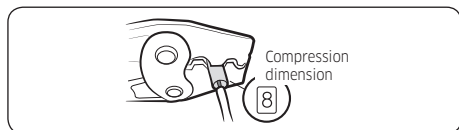

- After compressing it, pull both sides of the wire to make sure it is firmly pressed.

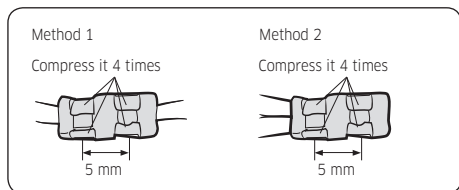

- 5 Wrap it with the insulation tape twice or more and position your contraction tube in the middle of the insulation tape.

Three or more layers of insulation are required.

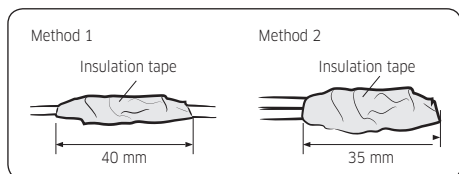

- 6 Apply heat to the contraction tube to contract it.

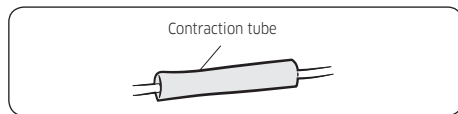

- 7 After tube contraction work is completed, wrap it with the insulation tape to finish.

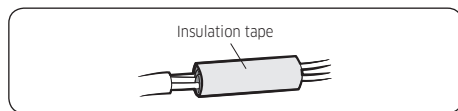

⚠ CAUTION

- Make sure that the connection parts are not exposed to outside.
- Be sure to use insulation tape and a contraction tube made of approved reinforced insulating materials that have the same level of withstand voltage with the power cable. (Comply with the local regulations on extensions.)

⚠ WARNING

- In case of extending the electric wire, please DO NOT use a round-shaped pressing socket.
 - Incomplete wire connections can cause electric shock or a fire.

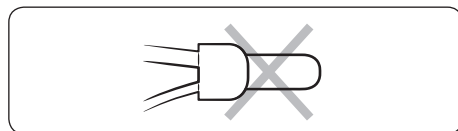

Installation Procedure

Step 13 Setting an indoor unit address and installation option

Set the indoor unit address and installation option with remote control option. Set the each option separately since you cannot set the ADDRESS setting and indoor unit installation setting option at the same time. You need to set twice when setting indoor unit address and installation option.

Option setting procedure

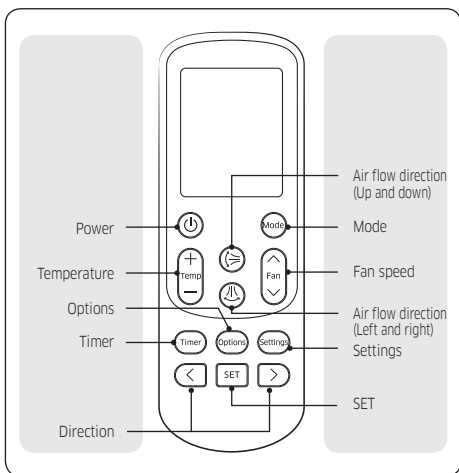

- 1 Remove batteries from the remote control.
- 2 Insert batteries and enter the option setting mode while pressing (High Temp button) and (Low Temp button).
- 3 Check if you have entered the option setting status.

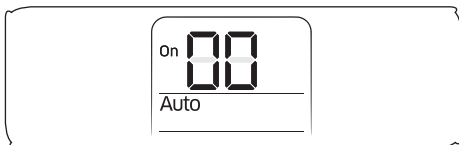







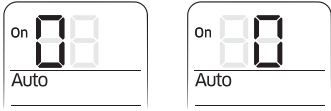

- 4 After entering the option setting status, select the option.

⚠ CAUTION

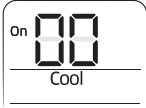
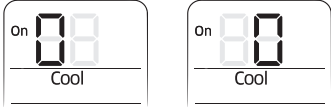

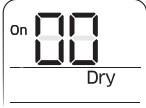
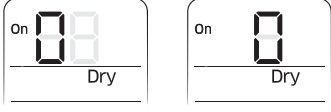

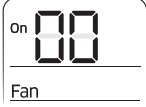

- Option setting is available from SEG1 to SEG 24
- SEG1, SEG7, SEG13, SEG19 are not set as page option.
- Set the SEG2~SEG6, SEG8~SEG12 as ON status and SEG14~18, SEG20~24 as OFF status.



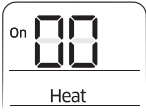
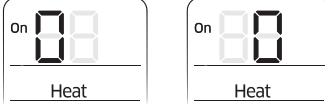

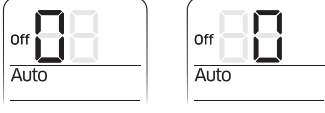
SEG1	SEG2	SEG3	SEG4	SEG5	SEG6
0	X	X	X	X	X
SEG7	SEG8	SEG9	SEG10	SEG11	SEG12
1	X	X	X	X	X
SEG13	SEG14	SEG15	SEG16	SEG17	SEG18
2	X	X	X	X	X
SEG19	SEG20	SEG21	SEG22	SEG23	SEG24
3	X	X	X	X	X

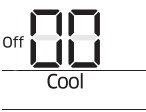
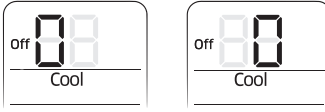
On (SEG1~12)	Off (SEG13~24)

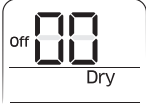
Option setting	Status
<p>1 Setting SEG2, SEG3 option</p> <p>a Press Low Fan button(V) to enter SEG2 value.</p> <p>b Press High Fan button(^) to enter SEG3 value.</p> <p>Each time you press the button, 0 → 1 → ... E → F will be selected in rotation.</p>	 <p>SEG2 SEG3</p>
<p>2 Setting Cool mode</p> <p> Press Mode button to be changed to Cool mode in the ON status.</p>	
<p>3 Setting SEG4, SEG5 option</p> <p>a Press Low Fan button(V) to enter SEG4 value.</p> <p>b Press High Fan button(^) to enter SEG5 value.</p> <p>Each time you press the button, 0 → 1 → ... E → F will be selected in rotation.</p>	 <p>SEG4 SEG5</p>
<p>4 Setting Dry mode</p> <p> Press Mode button to be changed to Dry mode in the ON status.</p>	
<p>5 Setting SEG6, SEG8 option</p> <p>a Press Low Fan button(V) to enter SEG6 value.</p> <p>b Press High Fan button(^) to enter SEG8 value.</p> <p>Each time you press the button, 0 → 1 → ... E → F will be selected in rotation.</p>	 <p>SEG6 SEG8</p>
<p>6 Setting Fan mode</p> <p> Press Mode button to be changed to Fan mode in the ON status.</p>	
<p>7 Setting SEG9, SEG10 option</p> <p>a Press Low Fan button(V) to enter SEG9 value.</p> <p>b Press High Fan button(^) to enter SEG10 value.</p> <p>Each time you press the button, 0 → 1 → ... E → F will be selected in rotation.</p>	 <p>SEG9 SEG10</p>

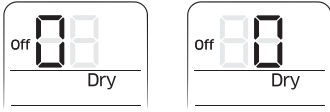
Installation Procedure

Option setting	Status
<p>8 Setting Heat mode</p> <p> Press Mode button to be changed to Heat mode in the ON status.</p>	
<p>9 Setting SEG11, SEG12 option</p> <p>a Press Low Fan button(∨) to enter SEG11 value.</p> <p>b Press High Fan button(∧) to enter SEG12 value.</p> <p>Each time you press the button, 0 → 1 → ... E → F will be selected in rotation.</p>	 <p style="text-align: center;">SEG11 SEG12</p>
<p>10 Setting Auto mode</p> <p> Press Mode button to be changed to Auto mode in the OFF status.</p>	
<p>11 Setting SEG14, SEG15 option</p> <p>a Press Low Fan button(∨) to enter SEG14 value.</p> <p>b Press High Fan button(∧) to enter SEG15 value.</p> <p>Each time you press the button, 0 → 1 → ... E → F will be selected in rotation.</p>	 <p style="text-align: center;">SEG14 SEG15</p>
<p>12 Setting Cool mode</p> <p> Press Mode button to be change to Cool mode in the OFF status.</p>	
<p>13 Setting SEG16, SEG17 option</p> <p>a Press Low Fan button(∨) to enter SEG16 value.</p> <p>b Press High Fan button(∧) to enter SEG17 value.</p> <p>Each time you press the button, 0 → 1 → ... E → F will be selected in rotation.</p>	 <p style="text-align: center;">SEG16 SEG17</p>
<p>14 Setting Dry mode</p> <p> Press Mode button to be change to Dry mode in the OFF status.</p>	

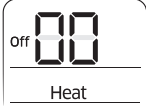
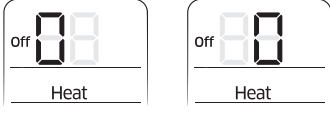
Option setting	Status
<p>15 Setting SEG18, SEG20 option</p> <p>a Press Low Fan button(V) to enter SEG18 value.</p> <p>b Press High Fan button(^) to enter SEG20 value.</p> <p>Each time you press the button, 0 → 1 → ... E → F will be selected in rotation.</p>	 <p>SEG18 SEG20</p>
<p>16 Setting Fan mode</p> <p> Press Mode button to be change to Fan mode in the OFF status.</p>	
<p>17 Setting SEG21, SEG22 option</p> <p>a Press Low Fan button(V) to enter SEG21 value.</p> <p>b Press High Fan button(^) to enter SEG22 value.</p> <p>Each time you press the button, 0 → 1 → ... E → F will be selected in rotation.</p>	 <p>SEG21 SEG22</p>
<p>18 Setting Heat mode</p> <p> Press Mode button to be change to Heat mode in the OFF status.</p>	
<p>19 Setting SEG23, SEG24 mode</p> <p>a Press Low Fan button(V) to enter SEG23 value.</p> <p>b Press High Fan button(^) to enter SEG24 value.</p> <p>Each time you press the button, 0 → 1 → ... E → F will be selected in rotation.</p>	 <p>SEG23 SEG24</p>

5 After setting option, press  button to check whether the option code you input is correct or not.

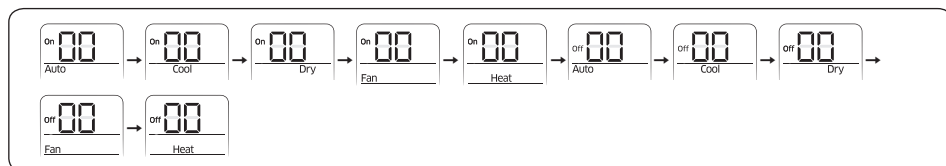

6 Press operation button  with the direction of remote control for set. For the correct option setting, you must input the option twice.

7 Check operation.

- Reset the indoor unit by pressing the **RESET** button of indoor unit or outdoor unit.
- Take the batteries out of the remote control and insert them again and then press the operation button.

Installation Procedure

Setting an indoor unit address (MAIN/RMC/MCU port)

- 1 Check whether power is supplied or not.
 - When the indoor unit is not plugged in, there should be additional power supply in the indoor unit.
- 2 Before installing the indoor unit, assign an address to the indoor unit according to the air conditioning system plan.
- 3 Assign an indoor unit address by wireless remote controller.

The initial setting status of indoor unit ADDRESS(MAIN/RMC/MCU port) is "0A0000-100000-200000-300000".

NOTE

Also set the MCU and Indoor units address by using Add-on > Change address on S-NET Pro 2.
(For more information, see the S-NET Pro 2 Help.)

Option No. : 0AXXXX-1XXXXX-2XXXXX-3XXXXX

Option	SEG1		SEG2		SEG3		SEG4		SEG5		SEG6	
Explanation	PAGE		MODE		Setting Main address		100-digit of indoor unit address		10-digit of indoor unit		The unit digit of an indoor unit	
Indication and Details	Indication	Details	Indication	Details	Indication	Details	Indication	Details	Indication	Details	Indication	Details
	0		A		0	No Main address	0~9	100-digit	0~9	10-digit	0~9	A unit digit
					1	Main address setting mode						
Option	SEG7		SEG8		SEG9		SEG10		SEG11		SEG12	
Explanation	PAGE				Setting RMC address				Group channel(*16)		Group address	
Indication and Details	Indication	Details	-		Indication	Details	-				Indication	Details
	1				0	No RMC address						
									1	RMC address setting mode	RMC1	0~F
Option	SEG13		SEG14		SEG15		SEG16		SEG17		SEG18	
Explanation	PAGE		-		Setting MCU PORT address		10-digit of MCU address		1-digit of MCU		MCU PORT address	
Indication and Details	Indication	Details	-		Indication	Details	Indication	Details	Indication	Details	Indication	Details
	2				0	No MCU PORT	0~1	10-digit	0~9	1-digit	A~F	PORT Location

CAUTION

- When A~F is entered to SEG5~6, the indoor unit MAIN ADDRESS is not changed.
- If you set the SEG 3 as 0, the indoor unit will maintain the previous MAIN ADDRESS even if you input the option value of SEG5~6.
- If you set the SEG 9 as 0, the indoor unit will maintain previous RMC ADDRESS even if you input the option value of SEG11~12.
- You cannot set SEG11 and SEG12 as F value at the same time.
- If the indoor unit is connected to the MCU, you can set the SEG 15~18.
Ex.) If you want to set the indoor unit to 'A' port of MCU #1. (0A0000 - 100000 - 20101A - 30000)

Setting an indoor unit installation option (suitable for the condition of each installation location)

- 1 Check whether power is supplied or not.
 - When the indoor unit is not plugged in, there should be additional power supply in the indoor unit.
- 2 Set the installation option according to the installation condition of an air conditioner.
 - The default setting of an indoor unit installation option is 020010-100000- 200000-300000.
 - Individual control of a remote control(SEG20) is the function that controls an indoor unit individually when there is more than one indoor unit.
- 3 Set the indoor unit option by wireless remote control.

O2 series installation option

SEG1	SEG2	SEG3	SEG4	SEG5	SEG6
0	2	Evaporator Drying	Use of external room temperature sensor / Minimizing fan operation when thermostat is off	Use of central control	FAN RPM compensation
SEG7	SEG8	SEG9	SEG10	SEG11	SEG12
1	-	Use of hot water heater	-	EEV Step when heating stops	-
SEG13	SEG14	SEG15	SEG16	SEG17	SEG18
2	Use of external control	Setting the output of external control / External heater signal / Cooling operation signal / Free Cooling control signal	S-Plasma ion	Buzzer control	Hours of filter usage
SEG19	SEG20	SEG21	SEG22	SEG23	SEG24
3	Individual control of a remote controller	Heating setting compensation	Adjusted EEV step of stopped unit during oil return /defrost mode.	-	-

- When setting the option other than above SEG values, the option will be set as "0".
- SEG5 central control option is basically set as 1 (Use), so you don't need to set the central control option additionally.
However, if the central control is not connected but it doesn't indicate an error message, you need to set the central control option as 0 (Disuse) to exclude the indoor unit from the central control.
- The external output of SEG15 is generated by MIM-B14 connection. (Refer to the manual of MIM-B14.)

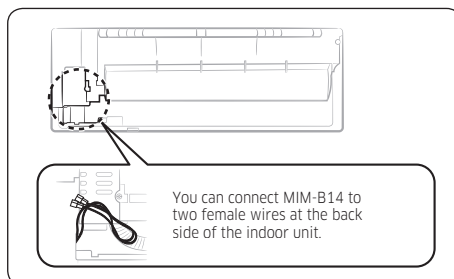

Installation Procedure

O2 series installation option(Detailed)

Option No. : 02XXXX-1XXXXX-2XXXXX-3XXXXX

Installation Procedure

Option	SEG1		SEG2		SEG3		SEG4			SEG5		SEG6	
Explanation	PAGE		MODE		Evaporator Drying		Use of external room temperature sensor / Minimizing fan operation when thermostat is off			Use of central control		FAN RPM compensation	
Indication and Details	Indication	Details	Indication	Details	Indication	Details	Indication	Details		Indication	Details	Indication	Details
								Use of External room temperature sensor	Minimizing fan operation when thermostat is off				
	0			2	0	Disuse	0	Default	Default	0	Disuse	0	Disuse
							1	Use	Disuse				
							2	Disuse	Use (Heating) (*2)				
							3	Use	Use (Heating) (*2)				
							4	Disuse	Use (Cooling) (*2)				
							5	Use	Use (Cooling) (*2)				
					4	Use (10min) (*1)	6	Disuse	Use (Heating / Cooling) (*2)	1	Use	1	RPM compensation
							7	Use	Use (Heating / Cooling) (*2)				
							8	Disuse	Use (Cooling Ultra Low Fan) (*2)				
							9	Use	Use (Cooling Ultra Low Fan) (*2)				
							A	Disuse	Use (Heating / Cooling Ultra Low Fan) (*2)				
							B	Use	Use (Heating / Cooling Ultra Low Fan) (*2)				
Option	SEG7		SEG8		SEG9		SEG10			SEG11		SEG12	
Explanation	PAGE		-		Use of hot water heater		-			EEV Step when heating stops		-	
Indication and Details	Indication	Details			Indication	Details				Indication	Details		
	1	Use (*3)			1	Adjusted EEV Step setting							
	3	Use (*3)			2*B	Opening EEV Step setting (*4)							
Option	SEG13		SEG14		SEG15		SEG16			SEG17		SEG18	

Explanation	PAGE		Use of external control		Setting the output of external control / External heater signal / Cooling operation signal / Free Cooling control signal		S-Plasma ion		Buzzer control		Hours of filter usage	
	Indication	Details	Indication	Details	Indication	Details	Indication	Details	Indication	Details	Indication	Details
Indication and Details	2		0	Disuse	0	External control (Thermo On)	0	Disuse	0	Use buzzer	2	1000 Hour
			1	ON/OFF control	1	External control (Operation On)						
					2	External heater signal (*5)						
			2	OFF control	3	External heater signal (*5)						
					4	Cooling operation signal (*6)						
			3	Window ON/OFF control	5	Free Cooling control (Cooling Thermo On) (*7)	1	Use	1	Disuse buzzer	6	2000 Hour
6	Free Cooling control (Cooling/Dry Thermo On) (*7)											
Option	SEG19	SEG20	SEG21		SEG22		SEG23	SEG24				
Explanation	PAGE	Individual control of a remote controller		Heating setting compensation		Adjusted EEV step of stopped unit during oil return / defrost mode.						
Indication and Details	3		0 or 1	channel 1	0	Default	0	Default				
			2	channel 2								
			3	channel 3	1	2°C						
			4	channel 4	2	5°C	1	Adjusted EEV position				

(*1) When Cooling or dry mode is off. The indoor fan operate in setting minutes.

(*2) Minimizing fan operation when thermostat is off

- Fan operates for 20 seconds at an interval of 5 minutes in heat mode.
- Fan stops or operates Ultra low in Coolong when thermostat is off.

(*3) 1: Fan is turned on continually when the hot water heater is turned on,

3: Fan is turned off when the hot water heater is turned on with cooling only indoor unit

Cooling only indoor unit: To use this option,install the Mode Select switch(MCM-C200) on the outdoor unit and fix it as cool mode.

(*4) It is only for wall-mounted indoor unit with EEV Integrated. If any design condition meets either of the following below, please set SEG11 to "7".

- a The total number of wall-mounted indoor units with EEV Integrated in one (modular) system is more than 20.

Installation Procedure

- b The total number of wall-mounted indoor units with EEV Integrated in one (modular) system is more than "the total of one(modular) system's capacity(kW) / 2" ("the total of one(modular) system's capacity(BTU/h) / 6800").
 ex) Outdoor capacity 28kW → 28 / 2 = 14. The total number of wall-mounted indoor units with EEV Integrated in one (modular) system is more than 14. Please refer to the EEV step table below for the system (for heating) at stop.

Indication	0	2	3	4	5	6	7	8	9	A	B
Stopped Unit's EEV step	Default	90↔160	100↔160	110↔160	120↔160	130↔160	160	200	250	300	400

(*5) When the following 2 or 3 is used as external heater On/Off signal, the signal for monitoring external contact control will not be output.

2: Fan is turned on continually when the external heater is turned on,

3: Fan is turned off when the external heater is turned on with cooling only indoor unit

Cooling only indoor unit: To use this option, install the Mode Select switch(MCM-C200) on the outdoor unit and fix it as cool mod.:

- If Fan is set to off for cooling only indoor unit by setting the SEG9=3 or SEG15=3, you need to use an external sensor or wired remote controller sensor to detect indoor temperature exactly.

(*6) When indoor unit is in cooling or Dry mode, The output signal is "ON".

(*7) For free cooling control, Economizer controller is required.



CAUTION

Do not install the electronic heater in the flow channel of the indoor unit fan.

Electronic heater should not be installed.

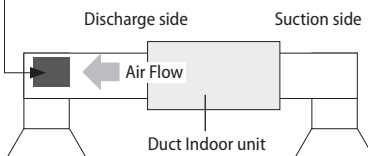

O5 series installation option

SEG1	SEG2	SEG3	SEG4	SEG5	SEG6
0	5	Use of Auto Change Over or cooling only for HR only	(When setting SEG3) Standard heating temp. Offset	(When setting SEG3) Standard cooling temp. Offset	(When setting SEG3) Standard for mode change Heating → Cooling
SEG7	SEG8	SEG9	SEG10	SEG11	SEG12
1	(When setting SEG3) Standard for mode change Cooling → Heating	(When setting SEG3) Time required for mode change	Compensation option for Long pipe or height difference between indoor units	MTFC (*3)	-
SEG13	SEG14	SEG15	SEG16	SEG17	SEG18
2	-	-	-	-	Control variables when using hot water / external heater (*4)
SEG19	SEG20	SEG21	SEG22	SEG23	SEG24
3	-	-	-	Forced FAN Operation for Heating and Cooling	-

Installation Procedure

05 series installation option(Detailed)

Option No. : 0XXXX-1XXXXX-2XXXXX-3XXXXX

Option	SEG1		SEG2		SEG3		SEG4		SEG5		SEG6	
Explanation	PAGE		MODE		Use of Auto Change Over or Cooling only for HR only		(When setting SEG3) Standard heating temp. Offset		(When setting SEG3) Standard cooling temp. Offset		(When setting SEG3) Standard for mode change Heating → Cooling	
Indication and Details	Indication	Details	Indication	Details	Indication	Details	Indication	Details	Indication	Details	Indication	Details
	1	0.5°C	1	0.5°C	1	1.5°C						
	1	Use Auto Change Over for HR only	2	1°C	2	1°C	2	2°C				
			3	1.5°C	3	1.5°C	3	2.5°C				
			4	2°C	4	2°C	4	3°C				
	2	Use Cooling only indoor unit for HR	5	2.5°C	5	2.5°C	5	3.5°C				
			6	3°C	6	3°C	6	4°C				
7			3.5°C	7	3.5°C	7	4.5°C					
Option	SEG7		SEG8		SEG9		SEG10		SEG11		SEG12	
Explanation	PAGE		(When setting SEG3) Standard for mode changing Cooling → Heating mode		(When setting SEG3) Time required for mode change		Compensation option for Long pipe or height difference between indoor units		MTFC (*3)		-	
Indication and Details	Indication	Details	Indication	Details	Indication	Details	Indication	Details	Indication	Details	Indication	Details
	1	1.5°C	1	7min	1	(*1) Height difference is more than 30m or (*2) Distance is longer than 110m						
	2	2°C	2	9min								
	3	2.5°C	3	11min								
	4	3°C	4	13min	2	(*1) Height difference is 15~30m or (*2) Distance is 50~110m						
	5	3.5°C	5	15min								
	6	4°C	6	20min								
7	4.5°C	7	30min									
2	Use											
Option	SEG13		SEG14		SEG15		SEG16		SEG17		SEG18	
Explanation	-	-	-	-	-	-	-	-	-	-	Control variables when using hot water / external heater (*4)	

Installation Procedure

Indication and Details	Indication	Details					Indication	Details		
								Set temp. for heater On/Off	Delay time for heater On	
Indication and Details	2						0	At the same time as thermo on	No delay	
							1	At the same time as thermo on	10 minutes	
							2	At the same time as thermo on	20 minutes	
							3	1.5 °C	No delay	
							4	1.5 °C	10 minutes	
							5	1.5 °C	20 minutes	
							6	3.0 °C	No delay	
							7	3.0 °C	10 minutes	
							8	3.0 °C	20 minutes	
							9	4.5 °C	No delay	
							A	4.5 °C	10 minutes	
							B	4.5 °C	20 minutes	
							C	6.0 °C	No delay	
							D	6.0 °C	10 minutes	
E	6.0 °C	20 minutes								
Option	SEG19	SEG20	SEG21	SEG22	SEG23		SEG24			
Explanation	PAGE	-	-	-	Forcing FAN Operation for Heating and Cooling			-		
Indication and Details	3						Indication	Details		
								Cooling Fan Setting	Heating Fan Setting	
								0	Disuse	Disuse
								1	Disuse	Use (Fan: User setting)
								2	Disuse	Use (Fan: High)
								3	Disuse	Use (Fan: Low)
								4	Use (Fan: User setting)	Disuse
								5	Use (Fan: User setting)	Use (Fan: User setting)
								6	Use (Fan: User setting)	Use (Fan: High)
								7	Use (Fan: User setting)	Use (Fan: Low)
								8	Use (Fan: High)	Disuse
								9	Use (Fan: High)	Use (Fan: User setting)
								A	Use (Fan: High)	Use (Fan: High)
								B	Use (Fan: High)	Use (Fan: Low)
								C	Use (Fan: Low)	Disuse
								D	Use (Fan: Low)	Use (Fan: User setting)
								E	Use (Fan: Low)	Use (Fan: High)
F	Use (Fan: Low)	Use (Fan: Low)								

Installation Procedure

- (*1) Height difference : The difference of the height between the corresponding indoor unit and the indoor unit installed at the lowest place. For example, When the indoor unit is installed 40m higher than the indoor unit installed at the lowest place, select the option "1".
- (*2) Distance : The difference between the pipe length of the indoor unit installed at farthest place from an outdoor unit and the pipe length of the corresponding indoor unit from an outdoor unit. For example, when the farthest pipe length is 100 m(328 ft) and the corresponding indoor unit is 40 m away from an outdoor unit, select the option "2". (100 - 40 = 60m)
- (*3) For MTFC option, MTFC(Multi Tenant Function Controller) kit is required.
- (*4) Heater operation when the SEG9 of O2 series installation option is set to using hot water heater or when SEG15 is set to using external heater
 - e.g. 1) Setting O2 series SEG9 = "1" / Setting O5 series SEG18 = "0": Hot water heater is turned on at the same time as the heating thermostat is on, and turned off when the heating thermostat is off.
 - e.g. 2) Setting O2 series SEG15 = "2" / Setting O5 series SEG18 = "A": Room temp. \leq set temp. + f(heating compensation temp.)
 - External heater is turned on when the temperature is maintained as 4.5 °C for 10 minutes. Room temp. $>$ set temp. + f(heating compensation temp.)
 - External heater is turned off when the temperature is maintained as 4.5 °C + 1 °C (1 °C is the Hysteresis for On/Off selection.)

SEG 3, 4, 5, 6, 8, 9 additional information

When the SEG 3 is set as "1" and follow Auto Change Over for HR only operation, it will operate as follows.

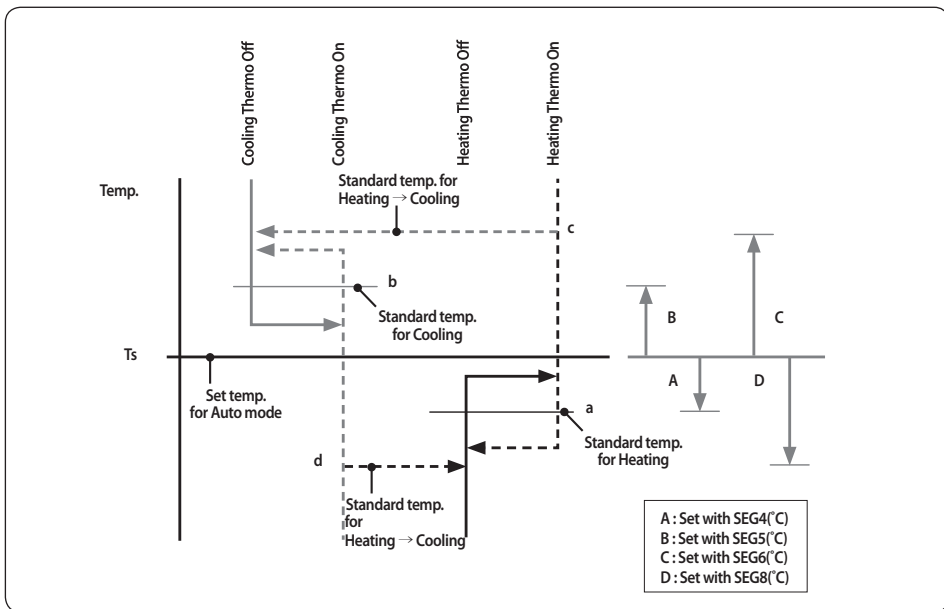

Cooling/Heating mode can be changed when Thermo Off status is maintained during the time with SEG9.

Changing a particular option

You can change each digit of set option.

Option	SEG1		SEG2		SEG3		SEG4		SEG5		SEG6	
Explanation	PAGE		MODE		The option mode you want to change		The tens' digit of an option SEG you will change		The unit digit of an option SEG you will change		Changed value	
Indication and Details	Indication	Details	Indication	Details	Indication	Details	Indication	Details	Indication	Details	Indication	Details
		0		D		Option mode	1~6	Tens' digit of SEG	0~9	Unit digit of SEG	0~9	The changed value

NOTE

- When changing a digit of an indoor unit address setting option, set the SEG3 as 'A'.
- When changing a digit of indoor unit installation option, set the SEG3 as '2'.

Ex) When setting the 'buzzer control' into disuse status.

Option	SEG1		SEG2		SEG3		SEG4		SEG5		SEG6	
Explanation	PAGE		MODE		The option mode you want to change		The tens' digit of an option SEG you will change		The unit digit of an option SEG you will change		Changed value	
Indication	0		D		2		1		7		1	



CAUTION

- If you are using heat pump model, mixed operation mode (two or more indoor units operating in different operation mode simultaneously) is not available when the indoor units are connected to same outdoor unit. If you set the master indoor unit with a remote control, outdoor unit will operate in the mode which was set in the master indoor unit.

Installation Procedure

Step 14 Performing the final check

To complete the installation, perform the following checks and tests to ensure that the air conditioner operates correctly.

- 1 Check the following:
 - Strength of the installation site
 - Tightness of pipe connection to detect gas leak
 - Electric wiring connection
 - Heat-resistant insulation of the pipe
 - Drainage
 - Grounding conductor connection
 - Correct operation (follow the steps below)
- 2 Press the  button and check the following:
 - The indicator on the indoor unit lights up.
 - The airflow blade opens and the fan gears up for operation.
- 3 Press any button and check the following:
 - The appropriate indicator lights up and the air conditioner operates according to the selected mode or function.
- 4 Press the  button and check the following:
 - The airflow blades work properly.

Step 15 Providing information for user

After finishing the installation of the air conditioner, you should explain the following to the user. Refer to appropriate pages in the user & installation manual.

- 1 How to start and stop the air conditioner
- 2 How to select the modes and functions
- 3 How to adjust the temperature and fan speed
- 4 How to adjust the airflow direction
- 5 How to set the timers
- 6 How to clean and replace the filters

NOTE

- When you complete the installation successfully, hand over the user & installation manual to the user for storage in a handy and safe place.











Troubleshooting

Detection of errors

- If an error occurs during the operation, an LED flickers and the operation is stopped except the LED.
- If you re-operate the air conditioner, it operates normally at first, then detect an error again.

LED Display

- If you turn off the air conditioner when the LED is flickering, the LED is also turned off.
- If you re-operate the air conditioner, it operates normally at first, then detect an error again.
- When E108 error occurs, change the address and reset the system.Ex.) When address of the indoor unit #1 and #2 are set as 5, address of the indoor unit #1 will become 5 and indoor unit #2 will display E108, A002.

Abnormal condition	Error code	LED Display		
				
<ul style="list-style-type: none"> • Error on indoor temperature sensor (Short or Open) 	E121	X		X
<ul style="list-style-type: none"> • Error on Eva-in sensor (Short or Open) • Error on Eva-out sensor (Short or Open) • Discharge sensor error (Short or Open) 	E122 E123 E126			X
<ul style="list-style-type: none"> • Indoor fan error 	E154	X	X	
<ul style="list-style-type: none"> • Error on outdoor temperature sensor (Short or Open) • Error on cond sensor • Error on discharge sensor Other outdoor unit sensor error that is not on the above list	E221 E237 E251		X	
<ul style="list-style-type: none"> • When there is no communication between the indoor•outdoor units for 2 minutes • Communication error received from the outdoor unit • 3 minute tracking error on outdoor unit • Communication error after tracking due to unmatching number of installed units • Error due to repeated communication address • Communication address not confirmed Other outdoor unit communication error that is not on the above list	E101 E102 E202 E201 E108 E109	X		
Self diagnosis error display <ul style="list-style-type: none"> • Error due to opened EEV (2nd detection) • Error due to closed EEV (2nd detection) • Eva in sensor is detached • Eva out sensor is detached • Thermal fuse error (Open) 	E151 E152 E128 E129 E198	