



DMS2.5(Data Management Server2.5)

MIM-D01AN

MIM-D01AUN

**BACnet Gateway**

MIM-B17BN

MIM-B17BUN

**LonWorks Gateway**

MIM-B18BN

MIM-B18BUN

# Air Conditioner user & installation manual

For more information on using the product, download the user manual from the product and refer to it.

imagine the possibilities

Thank you for purchasing this Samsung product.

**SAMSUNG**





# Safety Precautions **English**

## Caution for operation

- Before using the DMS2.5, BACnet Gateway, LonWorks Gateway, read carefully these instructions.
- After reading the instructions, keep this user's manual in a handy and safe place.  
If a user is changed, you must hand over the manuals.
- Never attempt to install the air conditioning system or to move the product by yourself.

### **WARNING**

- ◆ Do not attempt to install or repair the product by yourself.
- ◆ The product contains no user-serviceable parts. Always consult authorized service personnel for repairs.
- ◆ When moving, consult authorized service personnel for disconnection and installation of the product.
- ◆ Ensure that the wall is strong enough to support the weight of the product.
- ◆ Must install the product with rated power supply.
- ◆ In the event of a malfunction (burning smell, etc.), immediately stop operation, turn off the electrical breaker, and consult authorized service personnel.

### **CAUTION**

- ◆ Do not use inflammable gases near the product.
- ◆ Do not spill water into the product.
- ◆ Do not operate the product with wet hands.
- ◆ Do not install the product in a location where it will come into contact with the combustible gases, machine oil, sulphide gas, etc.
- ◆ Do not press buttons with a pointed thing.
- ◆ Do not pull or bend the product cable excessively.
- ◆ Do not use the product for other purpose.
- ◆ Do not spray an insecticide or other combustible things on the product.
- ◆ Do not clean the product with benzene, solvents or other chemicals.
- ◆ Do not give a shock to the product or disassemble it by yourself.

## Caution for installation

- This user & installation manual describes how to install the DMS2.5, BACnet Gateway, LonWorks Gateway. For installation of other optional accessories, refer to the appropriate installation manual.

### **WARNING**

- ◆ Read carefully this user & installation manual before installation and check if the product is installed correctly after installation.
- ◆ Do not attempt to install or repair this product by yourself.
- ◆ This product contains no user-serviceable parts. Always consult authorized service personnel for repairs.
- ◆ When moving, consult authorized service personnel for disconnection and installation of the product.
- ◆ Ensure that the wall is strong enough to support the weight of the product.
- ◆ Must install the product with rated power supply.
- ◆ The product must be installed according to the national electrical rules by an installation specialist.
- ◆ If you wish to uninstall the product, consult an authorized installation center.

### **CAUTION**

- ◆ Do not use inflammable gases near the product.
- ◆ Do not install the product in a location where it will come into contact with combustible gases, machine oil, sulphide gas, etc.
- ◆ Avoid locations where acid/alkali solution or special spray is used.
- ◆ Choose a location that is dry and sunny, but not exposed to direct sunlight. Suitable temperature is between 0°C(32 °F) and 39°C(102.2°F).
- ◆ Do not spill water into the product.
- ◆ Do not apply tensile strength to the cable to avoid cable damage.
- ◆ Do not press buttons with a sharp object.
- ◆ Do not connect the power cable to the control terminal.
- ◆ If the product is installed in a hospital or other special places, it should not affect other electronic devices.





# Consignes de sécurité **Français**

## Précautions pour le fonctionnement

- **Avant d'utiliser le DMS2.5, BACnet Gateway, LonWorks Gateway, lisez attentivement ces consignes.**
- **Après en avoir pris connaissance, conservez ce manuel d'utilisation dans un lieu sûr et à portée de main. En cas de changement d'utilisateur, vous devez remettre les manuels.**
- **Ne tentez jamais d'installer le climatiseur ou de déplacer le produit par vous-même.**

### **AVERTISSEMENT**

- ◆ Ne tentez pas d'installer ou de réparer vous-même le produit.
- ◆ Le produit ne contient aucun composant interne susceptible d'être réparé par l'utilisateur. Consultez toujours le personnel d'entretien agréé pour toute réparation.
- ◆ En cas de déplacement, consultez le personnel d'entretien agréé pour tout débranchement et toute installation du produit.
- ◆ Assurez-vous que le mur est suffisamment résistant pour supporter le poids du produit.
- ◆ Vous devez raccorder le produit à une installation supportant sa puissance nominale.
- ◆ En cas de dysfonctionnement (odeur de brûlé, etc.), arrêtez immédiatement le fonctionnement, coupez le disjoncteur électrique et consultez le personnel d'entretien qualifié.

### **ATTENTION**

- ◆ N'utilisez pas de gaz inflammable à proximité du produit.
- ◆ Ne renversez pas d'eau dans le produit.
- ◆ Ne manipulez pas le produit si vous avez les mains mouillées.
- ◆ N'installez pas le produit dans un lieu où il sera en contact avec des gaz combustibles, de l'huile de machine, de l'hydrogène sulfuré, etc.
- ◆ N'appuyez pas sur les boutons avec un objet pointu.
- ◆ Ne tirez pas sur le cordon d'alimentation du produit et ne le pliez pas excessivement.
- ◆ N'utilisez pas le produit dans un autre but que celui auquel il est destiné.
- ◆ Ne vaporisez pas d'insecticide ou autre produit combustible sur le produit.
- ◆ Ne nettoyez pas le produit en utilisant du benzène, des solvants ou autres produits chimiques.
- ◆ N'appliquez pas de choc sur le produit et ne le désassemblez pas non plus vous-même.

## Précautions pour l'installation

- **Ce manuel d'utilisation et d'installation décrit comment installer le DMS2.5, BACnet Gateway, LonWorks Gateway. Pour obtenir des informations sur l'installation d'autres accessoires optionnels, reportez-vous au manuel d'installation correspondant.**

### **AVERTISSEMENT**

- ◆ Veuillez lire attentivement ce manuel d'utilisation et d'installation avant l'installation, puis vérifiez si le produit est correctement installé.
- ◆ Ne tentez pas d'installer ou de réparer vous-même ce produit.
- ◆ Ce produit ne contient aucun composant interne susceptible d'être réparé par l'utilisateur. Consultez toujours le personnel d'entretien agréé pour toute réparation.
- ◆ En cas de déplacement, consultez le personnel d'entretien agréé pour tout débranchement et toute installation du produit.
- ◆ Assurez-vous que le mur est suffisamment résistant pour supporter le poids du produit.
- ◆ Connectez impérativement le produit à une installation supportant sa puissance nominale.
- ◆ Conformément aux règles électriques nationales, le produit doit être installé par un technicien d'installation.
- ◆ Si vous voulez désinstaller le produit, consultez un centre d'installation agréé.

### **ATTENTION**

- ◆ N'utilisez pas de gaz inflammable à proximité de l'appareil.
- ◆ N'installez pas le produit dans un lieu où il sera en contact avec des gaz combustibles, de l'huile de machine, de l'hydrogène sulfuré, etc.
- ◆ Évitez les emplacements où des solutions acides/alcalines ou des pulvérisateurs spéciaux sont utilisés.
- ◆ Choisissez un emplacement sec et lumineux, mais non exposé à la lumière directe du soleil. La température adaptée se situe entre 0 °C (32 °F) et 39 °C (102,2 °F).
- ◆ Ne renversez pas d'eau dans le produit.
- ◆ Ne soumettez pas le câble à un effort de tension qui pourrait l'endommager.
- ◆ N'appuyez pas sur les boutons à l'aide d'un objet pointu.
- ◆ Ne branchez pas le câble d'alimentation à la borne de commande.
- ◆ Si le produit est installé dans un hôpital ou dans d'autres endroits spéciaux, il ne doit pas affecter les autres appareils électroniques.



# Contents

◆ <b>SAFETY PRECAUTIONS</b> .....	2	◆ <b>TRACKING</b> .....	34
◆ <b>BEFORE INSTALLING THE DMS2.5</b> .....	5	◆ <b>SETTING THE POWER DISTRIBUTION</b> .....	42
◆ <b>ACCESSORIES</b> .....	6	◆ <b>APPENDIX</b> .....	44
◆ <b>VIEWING THE PARTS</b> .....	7	◆ <b>BACNET GATEWAY SETTING</b> .....	47
◆ <b>PRODUCT DIMENSIONS</b> .....	9	◆ <b>VIEWING LONWORKS GATEWAY'S PARTS</b> .....	69
◆ <b>SYSTEM ARCHITECTURE</b> .....	10	◆ <b>PRODUCT DIMENSIONS</b> .....	71
◆ <b>COMPATIBLE DEVICES</b> .....	11	◆ <b>LONWORKS GATEWAY SETTING</b> .....	72
◆ <b>INSTALLING THE DMS2.5</b> .....	13	◆ <b>SPECIFICATIONS</b> .....	96
◆ <b>SETTING THE COMPUTER ENVIRONMENT</b> .....	19	◆ <b>LICENSE</b> .....	97
◆ <b>SETTING THE DMS2.5</b> .....	21		

- Note*
- ◆ The contents and pictures used in this user & installation manual may be changed without advance notice for the functional reinforcement and improvement of a product.
  - ◆ This user & installation manual is for DMS2.5, BACnet Gateway, LonWorks Gateway installation.
  - ◆ Refer to page 47~68 to check BACnet Gateway installation.
  - ◆ Refer to page 69~95 to check LonWorks Gateway installation.

## Federal Communication Commission Interference Statement

This equipment has been tested and found to comply with the limits for a Class B digital device, pursuant to Part 15 of the FCC Rules. These limits are designed to provide reasonable protection against harmful interference in a residential installation. This equipment generates, uses and can radiate radio frequency energy and, if not installed and used in accordance with the instructions, may cause harmful interference to radio communications. However, there is no guarantee that interference will not occur in a particular installation. If this equipment does cause harmful interference to radio or television reception, which can be determined by turning the equipment off and on, the user is encouraged to try to correct the interference by one of the following measures:

- Reorient or relocate the receiving antenna.
- Increase the separation between the equipment and receiver.
- Connect the equipment into an outlet on a circuit different from that to which the receiver is connected.
- Consult the dealer or an experienced radio/TV technician for help.

## FCC Caution:

Any changes or modifications not expressly approved by the party responsible for compliance could void the user's authority to operate this equipment.

# Before Installing the DMS2.5

## Checks before installation

### 1 DMS2.5 IP

- ◆ Basically, only Private IP can be set to IP address. To use Public IP, you must set Enable public IP as 'Enable' from the menu [System Settings] → [System environment setting].

- Private IP range : 10.0.0.0 ~ 10.255.255.255, 172.16.0.0 ~ 172.31.255.255, 192.168.0.0 ~ 192.168.255.255

- Public IP range: IP except for Private IP range and 127.0.0.1(localhost)

- ◆ DMS2.5 supports DHCP. If Public IP must be assigned from DHCP, you must set Enable public IP as 'Enable' from the menu [System Settings] → [System environment setting].

- ※ DHCP(Dynamic Host Configuration Protocol)

- An Internet protocol for automating the configuration of computers that use TCP/IP.

- DHCP is used to automatically assign IP addresses.

- In other words, the IP address of the host is supported only when the PC is on.

### 2 Network related equipments

- ※ DHCP(Dynamic Host Configuration Protocol)

- An Internet protocol for automating the configuration of computers that use TCP/IP.

- DHCP is used to automatically assign IP addresses.

- In other words, the IP address of the host is supported only when the PC is on.

### 3 Installation connection wire

- ◆ The LAN cable and the communication cables from OnOff controller/interface modules must be installed in such a way that the wires can be connected to the DMS2.5 with ease.

#### Note

- ◆ *DMS2.5 supports Static IP or Dynamic IP. Web browser or S-NET series accesses DMS2.5 using its IP address. If the web browser or S-NET series which accesses to DMS2.5 are installed in a PC and the PC's IP is set to Public IP, you must register the Public IP to DMS2.5 to access.*

- ◆ *A static IP from an internet service provider must be used if xDSL (ADSL, VDSL) is supported.*







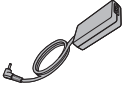

CAUTION

- ◆ **Use this product only in a separate dedicated network. Samsung electronics is not liable for any problems caused by connecting it to the Internet or an intranet.**

## Accessories

Make sure you have each item. Supplied items may vary depending on your country or service provider.

Item	DMS2.5	Adapter	Power cable		M4x16 Screw
Quantity	1	1	1		6
Shape			MIM-D01AN 	MIM-D01AUN 	

User & Installation manual	Cable tie
1	1
	



CAUTION

- ◆ ***The DMS2.5 must be installed by a trained installer.***
- ◆ ***Ensure the main power is turned off before installing the DMS2.5.***
- ◆ ***Be sure to use adapter and power cable we provide.***
- ◆ ***The power cable and the communication cable must be installed according to the national electrical wiring regulations.***
- ◆ ***LonWorks communication cable should use the cable which fits to the specification provided by Echelon.***

## Viewing the Parts

### Main Parts

#### DMS2.5 Exterior

##### LCD Display

Shows current time and IP address. Various messages will be displayed depending on button input.

##### LCD operation button

There are 4 buttons(Menu, ▼(Down), ▲(Up), Set) and you can access menu and move, check the menu.

##### LED Indicator

Check 15 LED status such as Power, CPU-Alive, Ethernet-Linked/Active, COM1~5-TX/RX and Check

##### DMS2.5 Bottom cover

Unfasten 2 screws on the bottom and separate the bottom cover from DMS2.5. Then check cable connection part.

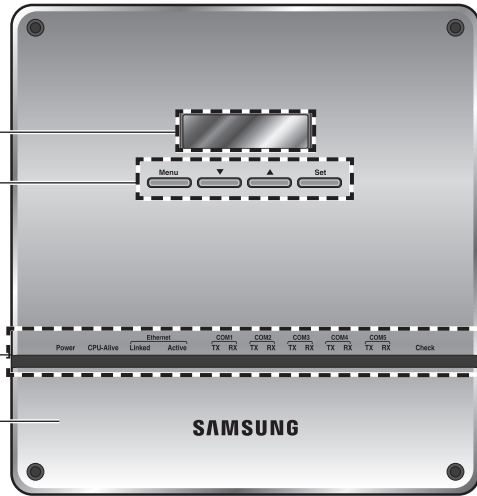

#### LED Indicator

Item	Name	Status
Power	Power indicator	Turns blue when the power is supplied.
CPU Alive	CPU operation indicator	Blinks in orange with 1 second intervals during normal operation.
Ethernet-Linked	Internet connection indicator	Turns green during normal connection.
Ethernet-Active	Internet data transmission/reception indicator	Blinks in orange during normal transmission/reception.
COM1~5 - TX	Channel 1~5 OnOff controller/Outdoor unit Data transmission Indicator	Blinks in green during normal transmission.
COM1~5 - RX	Channel 1~5 OnOff controller/Outdoor unit Data reception Indicator	Blinks in green during normal reception,
Check	Indoor/Outdoor unit/Communication check Indicator	Turns green when notice occurs.

## Viewing the Parts (Continued)

### DMS2.5 Cable Connection Part

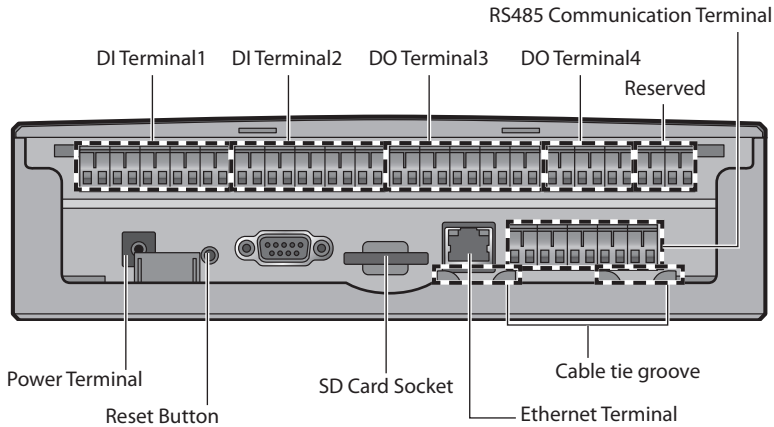

Name	Description
DI Terminal1	Digital Input connection terminal, Channel1~Channel5
DI Terminal2	Digital Input connection terminal, Channel6~Channel10
DO Terminal3	Digital Output connection terminal, Channel1~Channel5
DO Terminal4	Digital Output connection terminal, Channel6~Channel8
Reset Button	Reset DMS2.5
Power Terminal	Connect DMS2.5 adapter
SD card socket	Sub memory (for program update and set information saving) socket
RS485 Communication Terminal	Connect for RS485 communication with devices such as OnOff controller/Outdoor unit - COM1 ~ COM5
Ethernet Terminal	Connect LAN cable
Cable tie groove	Groove for arranging cables





## Main Parts

### DMS2.5 Interior

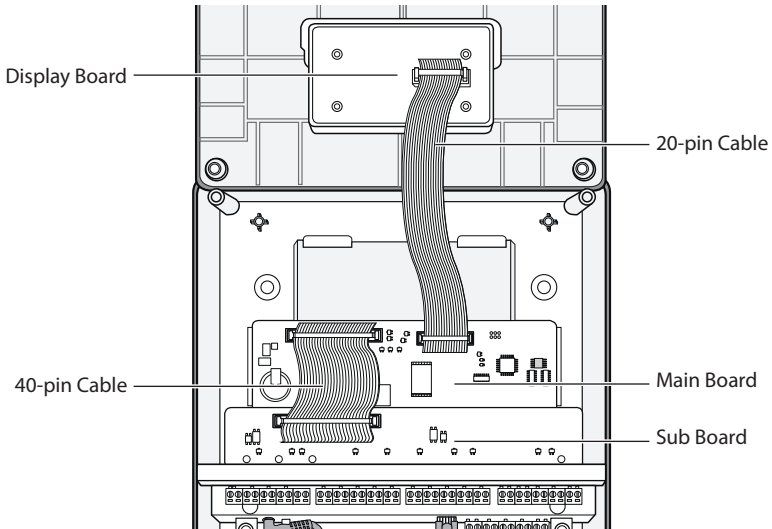

- Note**
- ◆ If you need external circuit configuration, consult with the manufacturer.
  - ◆ Refer to page 18 for DI contact input operation.

## Product Dimensions

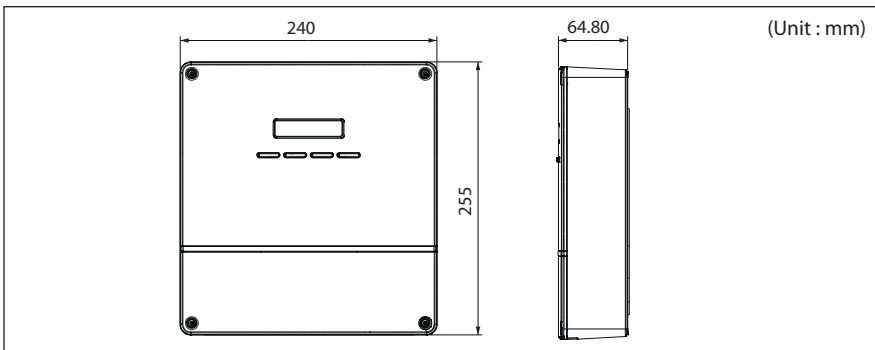

## System Architecture

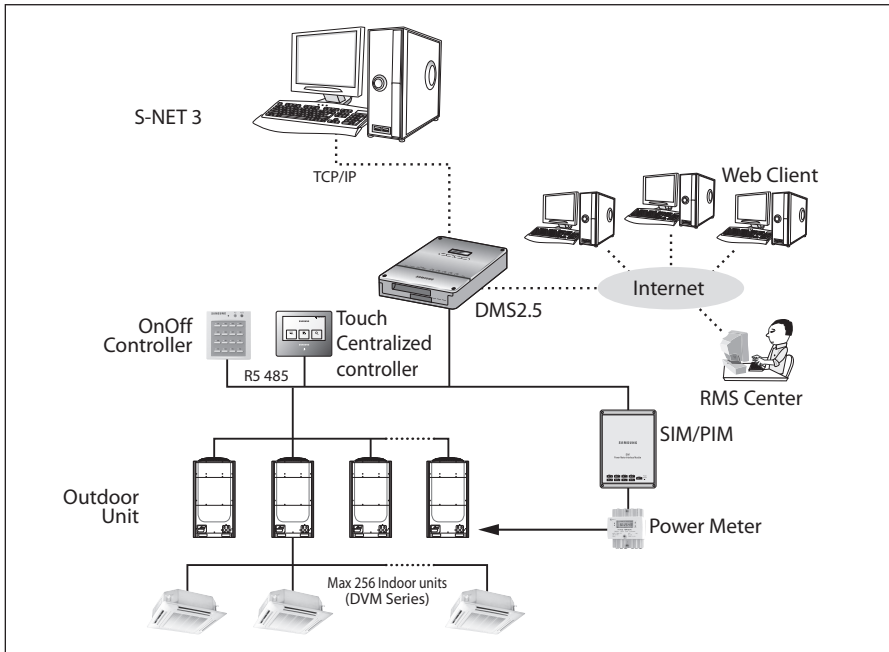

- Connecting outdoor unit and DMS2.5.
  - You can control up to 80 outdoor units and 256 indoor units by using DMS2.5.
  - ※ You can connect up to 16 (outdoor) units per each communication channel of the DMS2.5.
  - ※ The maximum number of indoor units (including ERV and MCU) that can be connected to each communication channel of DMS2.5 RS485 is 128.
  - If the number of connected outdoor unit increases, it may take long time for tracking. (Max. 30 minutes)



- ◆ **For devices that support new communication, you must set the communication mode of the channel to 'NEW' from 'System settings → Tracking' menu.**  
**Set of Indoor/outdoor units, with conventional communication type, cannot be connected to DMS2.5 with new communication.**
- ◆ **When 'NEW' is set as communication mode of the channel, virtual OnOff controller address will be assigned.**  
**(Channel 0: Virtual OnOff controller 11, Channel 1: Virtual OnOff controller 12, Channel 2: Virtual OnOff controller 13, Channel 3: Virtual OnOff controller 14, Channel 4: Virtual OnOff controller 15)**

## Compatible Devices

No	Devices	Model	Note
1	Indoor Unit Outdoor Unit	DVM S HR, DVM S HP, DVM ECO, DVM S WATER GEO, DVM S cooling only outdoor units and indoor units that can be connected to these outdoor units	DVM, CAC indoor/outdoor units and ERV product groups that support NASA communication
2	OnOff controller/ Touch Centralized controller	MCM-A202DN, MCM-A300N	OnOff controller: Centralized controller
3	SIM	MIM-B12N	Needed for EHP power distribution
4	PIM	MIM-B16N	Needed for EHP power distribution
5*	Watt-hour Meter	RS485 comm. type	Connected with SIM Needed for power distribution ( Please consult Samsung for compatible power meters)
		Pulse type	Connected with PIM Pulse Width: 20~400(ms) Pulse: 1~10000(Wh/Pulse)

\* Products with '\*' are not Samsung products and must be purchased separately.  
(Only selected power meters may be used for protocol compatibility issues.)



## Compatible Devices (Continued)

### Maximum Devices Attachable

Devices	Max.	Note
Indoor Unit	256	Tracking error occurs if exceeded The maximum number of indoor units (including ERV and MCU) that can be connected to each DMS communication channel is 128.
OnOff controller/ Touch Centralized controller	75	Must not exceed 15 units per each RS485 communication terminal
Outdoor unit	80	Must not exceed 16 units per each RS485 communication terminal
SIM/PIM	8	
Watt-hour Meter	64	Maximum 8 units can be connected to 1 SIM/PIM.



CAUTION

***The sum of OnOff controller, touch centralized controller, and SIM/PIM interface module that can be connected to each DMS2.5 communication channel should be 15 or less.***





## Installing the DMS2.5

1 Separate the installation plate on the rear side of DMS2.5.

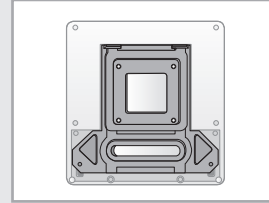

2 Fix the installation plate on the wall using 4 screws.

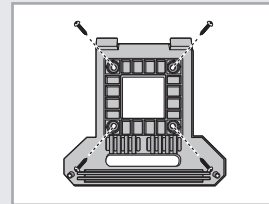

3 Hang the DMS2.5 on the groove which is on the top of the installation plate.

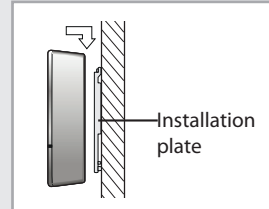

4 Fix the installation plate and DMS2.5 using 2 screws.  
◆ Depending on the installation environment, fix DMS2.5 using assistant holes.  
(Screws for assistant hole are not provided by our company.)

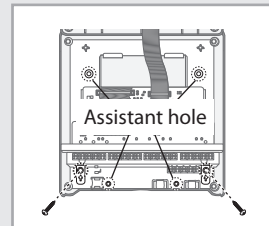

5 If you install DMS2.5 inside of the wall or wiring from the rear side is needed, use wiring groove on the bottom of DMS2.5.

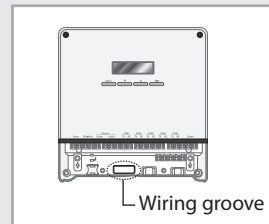

**To prevent breakdown and damage of DMS2.5, and for safe usage, it is recommended to install DMS2.5 on the wall.**



## Installing the DMS2.5 (Continued)

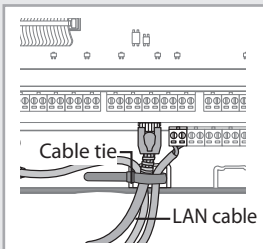
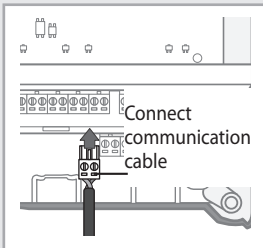
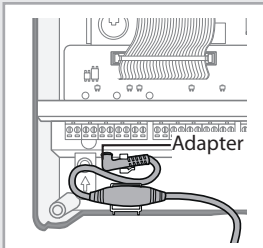
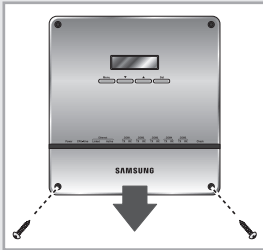

### Connecting Outdoor Unit

1 Unfasten the 2 screws on the bottom of the DMS2.5 front cover. Hold the bottom 2 sides of the DMS2.5 and push downwards to slide open the cover.

2 Connect the adapter to the power terminal.  
◆ Arrange the adapter as the right figure.

3 Separate 1 terminal block from 5 terminal blocks that are attached to RS485 communication terminal of the DMS2.5. Then, connect outdoor unit communication cable (R1, R2) to the terminal block.(R1↔A, R2↔B)

4 Connect LAN cable to the Ethernet terminal of DMS2.5. Then arrange it using cable tie.

5 Fasten the bottom cover of DMS2.5 and fix it using 2 screws.



**Maximum 80 Outdoor units can be connected to one DMS2.5.**



## Connecting SIM

- 1 Unfasten the 2 screws on the bottom of the DMS2.5 front cover. Hold the bottom 2 sides of the DMS2.5 and push downwards to slide open the cover.
- 2 Connect the adapter to the power terminal.
  - ◆ Arrange the adapter as the right figure.
- 3 Separate 1 terminal block from 5 terminal blocks which are attached to RS485 communication terminal. Then, connect SIM/PIM communication cable to the terminal block.
- 4 Connect LAN cable to the Ethernet terminal of DMS2.5. Then arrange it using cable tie.
- 5 Fasten the bottom cover of DMS2.5 and fix it using 2 screws.

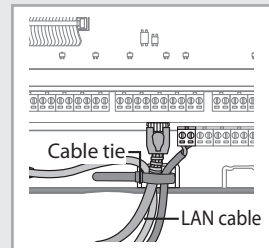
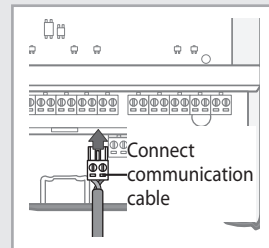
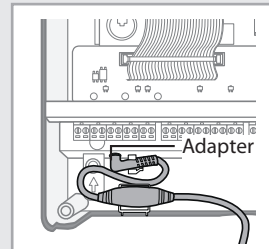
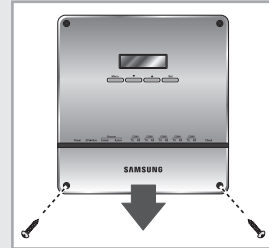

**CAUTION**  
**Maximum 8 SIM/PIM units can be connected to one DMS2.5.**





## Installing the DMS2.5 (Continued)

### Using the DI External Contact Control (Optional)

#### Setting the External Contact Control Pattern

- You can set the system settings through contact control pattern.

- 1 Select [System Settings] menu and click [System environment setting].
- 2 Click [Edit] from 'Select the contact control pattern'.
- 3 Select the pattern you want to check.
  - ◆ Pattern 1[No external input]: No operation will be made when inputting contact point control signal.
  - ◆ Pattern 2[Level(Emergency stop)]: Commands that stop all indoor unit operation and disable remote control when inputting contact point control signal. In level emergency stop status, it will not be controlled even if the command is set from upper controller.
  - ◆ Pattern 3[Level(Operation/Stop)]: Level signal input timing. It changes operation/stop status of all indoor units.
  - ◆ Pattern 4[pulse (Operation/Stop,Disable/Enable)]: Pulse signal. It changes operation/stop status of all indoor units.
- 4 Click [Save] after setting is completed.
- 5 Click [OK] when "This information will be modified. Do you want to proceed?" message window appears.
- 6 "Reading data from DMS2.5. Please wait." message appears and saving is completed. Then, system environment setting screen appears again with all items are disabled.

**Note** Pattern 1 is set as factory setting.



- ◆ **DMS2.5 has total 10 DI ports. However, actually used DI ports are Ch1 and Ch2, and the rest of the ports (Ch3~Ch10) are for additional functions. Therefore, make sure to connect Ch1 or Ch2 when using it.**
- ◆ **For DO, Ch1 and Ch2 are currently used inside of DMS2.5. Ch9 and Ch10 are reserved in case of need. Therefore you can only use Ch3~Ch8.**







## Contact control Pattern

Pattern	Control
Pattern1	<ul style="list-style-type: none"> <li>▶ No external input (Factory default setting) When you input contact control signal in port 1, there will be no response.</li> </ul>
Pattern2	<ul style="list-style-type: none"> <li>▶ Level input (Emergency stop)               <ol style="list-style-type: none"> <li>1. If the contact control signal is changed to ON, emergency stop status and all the indoor units are given 'Stop' command, and controlling using remote controller is impossible.</li> <li>2. During the emergency stop, the DMS2.5 will ignore any request from the upper controllers.</li> <li>3. During the emergency stop, the DMS2.5 will ignore previously set schedules.</li> <li>4. When the contact control signal changes from ON to OFF, DVM goes into normal operation status and returns to the remote control status before emergency stop.</li> <li>5. Even if the contact control signal of port 1 changes from ON to OFF, there will be no change to the indoor unit.</li> <li>6. When you input contact control signal in port 2, there will be no response.</li> </ol> </li> </ul>
Pattern3	<ul style="list-style-type: none"> <li>▶ Level input (Operation/Stop, Remote control Enable/Disable)               <ol style="list-style-type: none"> <li>1. If the contact signal of port 1 changes from OFF to ON, all indoor units will be given 'Operation' command.</li> <li>2. If the contact signal of port 1 changes from ON to OFF, all indoor units will be given 'Stop' command.</li> <li>3. If the contact signal of port 2 is OFF, you cannot control all indoor units using remote controller.</li> <li>4. If the contact signal of port 2 changes from OFF to ON, you can control all indoor units using remote controller.</li> <li>5. If the contact signal of port 2 changes from ON to OFF, you cannot control all indoor units using remote controller.</li> <li>6. Control command from the upper controller will be operated regardless of the contact point status.</li> <li>7. DVM system control using Schedule control will be operated regardless of the contact point status.</li> </ol> </li> </ul>
Pattern4	<ul style="list-style-type: none"> <li>▶ Pulse input (Operation/Stop)               <ol style="list-style-type: none"> <li>1. Valid pulse duration for input signal is 0.5~1.0 second. DMS2.5 ignores the signal which has shorter than 0.5 second duration, longer than 1.0 second Pulse width.</li> <li>2. When Pulse input signal is ON in Port 1. all indoor units will be given 'Operation' command.</li> <li>3. When Pulse input signal is ON in Port 2. all indoor units will be given 'Stop' command.</li> <li>4. DVM control command from the upper controller will be operated regardless of Pulse input signal.</li> <li>5. DVM system control using Schedule control will be operated regardless of Pulse input signal.</li> </ol> </li> </ul>





# Installing the DMS2.5 (Continued)

## DI(Digital Input) Circuitry according to Contact control Pattern

- Pattern 2 (May be used for connection with a fire sensor)

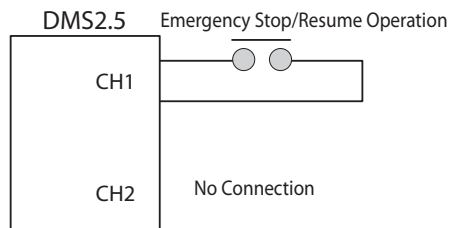

- Pattern 3 (External contact signal control)

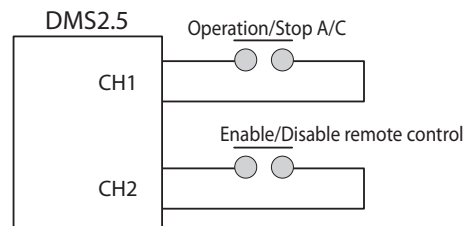

- Pattern 4 (Pulse signal control)

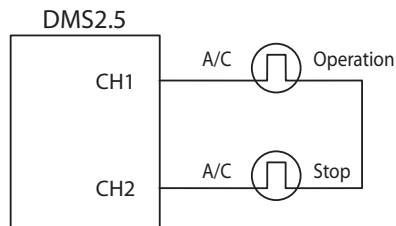



## Setting the Computer Environment

### 1 Device related to network (Purchase separately)

- ◆ Computer with a LAN Card
- ◆ HUB or network cable(Cross-Direct cable)

### 2 Computer web browser specification

- ◆ Internet Explorer 11 or later version
- ◆ Silverlight 2.0 or later version

- Note*
- ◆ A cross cable is used when connecting to PC directly. It is produced as transmission and reception cables are crossed. Cable 1, 2, 3, and 6 are crossed each other.
  - ◆ Visit internet homepage (<http://www.microsoft.com/silverlight/>) to download Silverlight. Or you can download it through the download link which is noticed automatically when you access to DMS2.5 for the first time.

## Connect DMS2.5 and Computer

### Connect DMS2.5 and Computer directly

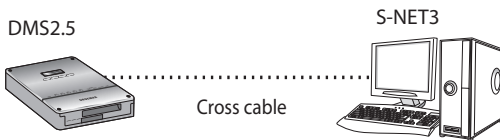

### Connect DMS2.5 and Computer using HUB

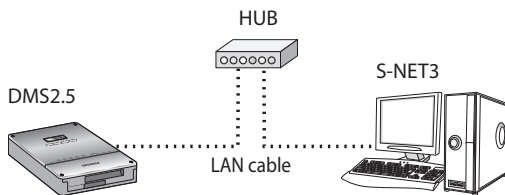



## Setting the Computer Environment (Continued)

### Computer Settings for DMS2.5 Connection

- All settings of DMS2.5 will be arranged in web page which built in DMS2.5. You should access to DMS2.5 IP to use DMS2.5 web page.  
Set your computer settings as follows.
- DMS2.5 Factory default setting  
DMS2.5 IP : 192.168.0.100

### IP Setting (Recommended)

- To access to DMS2.5 IP, set the network information of DMS2.5 connected computer as follows.

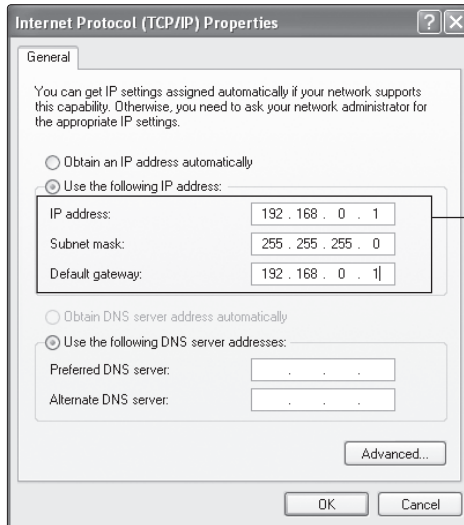

- IP address : 192.168.0.1(~253)  
Except 100
- Subnet mask : 255.255.255.0
- Default gateway : 192.168.0.1

- 1 Select [My network Settings] icon and click [Properties] using right button.
- 2 Select [Local area connection] icon and click [Properties] using right button from the network connection folder.
- 3 [Internet protocol(TCP/IP)] and click [Properties] using right button from the local area connection property window.
- 4 Enter "192,168,0,1" in IP address field, "255,255,255,0" for subnet mask address, and "192,168,0,1" for default gateway.
- 5 Click [OK] after setting.



## Setting the DMS2.5

### DMS2.5 Connection and Login

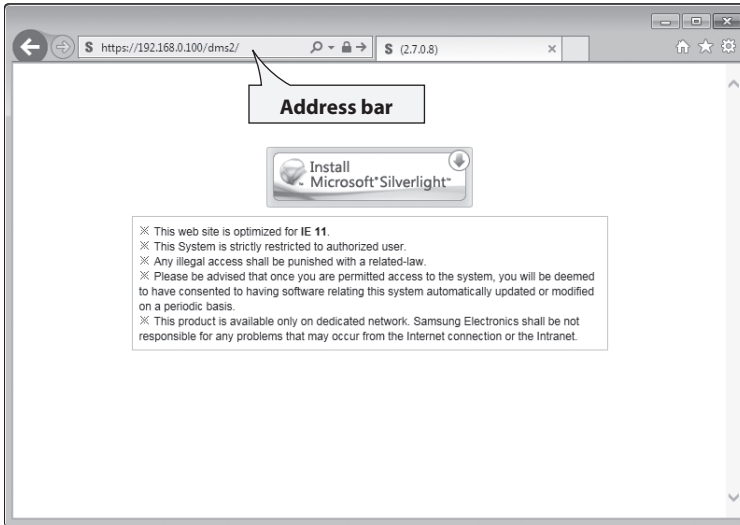

- 1 Click internet explorer icon(  ) twice on your computer.
- 2 When internet explorer window appears, enter IP address (**https://192.168.0.100**) on the address field then press [ENTER].
  - 1) At initial access, security certificate warning popup message will appear as shown. This message appears since DMS2.5 used the certificate of its own, so it will not appear if DMS2.5 certificate is registered on web browser. DMS2.5 certificate must be registered because the message will appear every time and it is not safe for security if it is not registered. Also, it should be registered to all PCs that are connecting to DMS2.5.

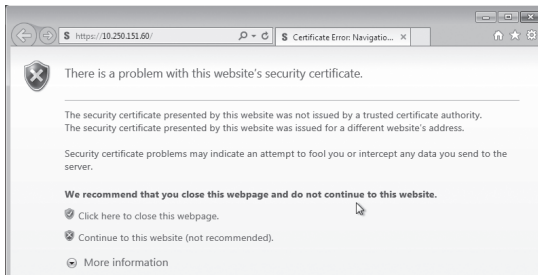

**You must stop connecting due to security problem if the message appears even if you registered DMS2.5 certificate.**

## Setting the DMS2.5 (Continued)

### 2) Registering DMS2.5 certificate on web browser

A. Select 'Content' tap in 'Tools' → 'Internet options', and click 'Certificates'.

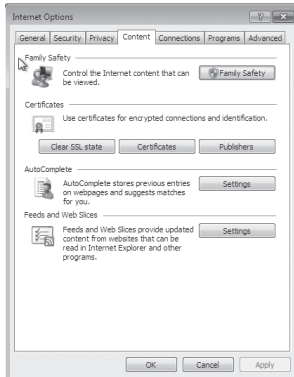

B. Select 'Trusted Root Certification Authorities' and click 'Import'.

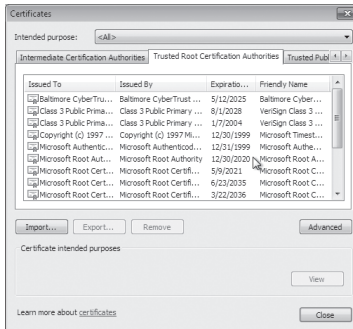

C. Click 'Next'.





D. Select 'Browse' and find DMS2.5 certificate, and click 'Next'. DMS2.5 certificate can be downloaded from [System environment setting].

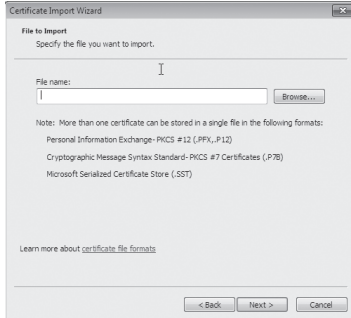

E. Select 'Place all certificates in following drive' and click 'Next'.

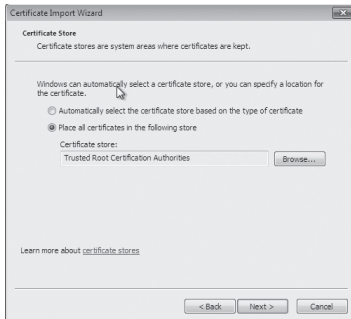

F. Click 'Finish', and click 'Yes' when security warning appears.

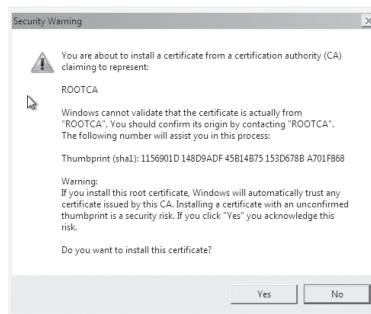
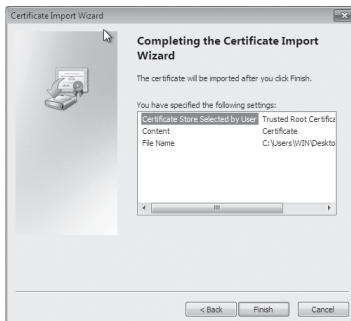

## Setting the DMS2.5 (Continued)

- 3 If it is the first time to access DMS2.5, "Install Microsoft Silverlight" message will appear.
  - ◆ If Microsoft Silverlight has already been installed, the screen will not appear.

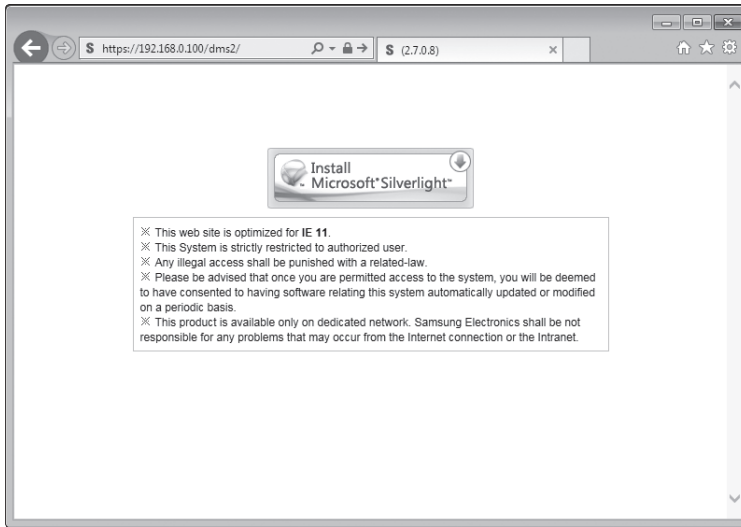

- 4 Click [Run] button and continue installation.  
After installation, access DMS2.5 again.



***Silverlight operates normally with Windows 7 or later version. It may not operate normally with former version of Windows.***



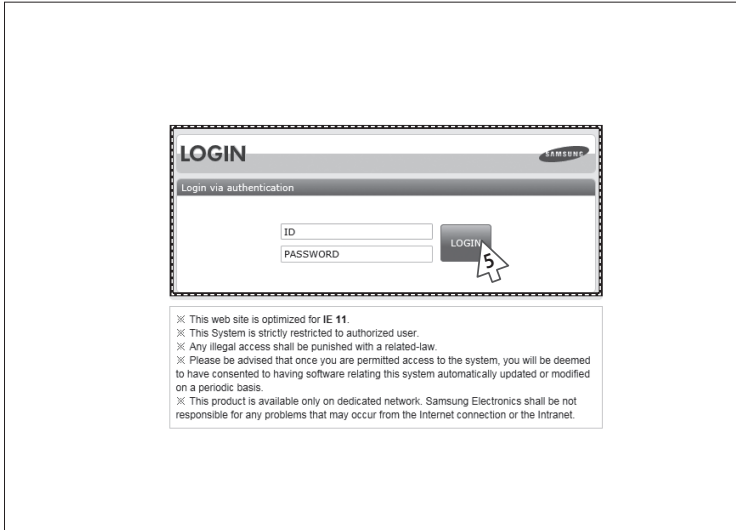

**5** Enter ID and password when DMS2.5 main web page appears. Then click [LOGIN].

- ◆ Depending on authorization settings set by the administrator, access to some functions may be restricted.
- ◆ For user authorization setting, refer to System settings → User authorization management.  
The default DMS2.5 user ID is 'admin' and password is 'ac0530'.

**Note**

- ◆ *Only authorized users can access to web page.*
- ◆ *Connection speed may slow down.  
Fewer than 5 concurrent users are recommended.*
- ◆ *DMS2.5 manager should change ID and password for security and management.*
- ◆ *LOGOUT : If you want to log out, click [LOGOUT] on the top of the menu. DMS2.5 will be ended.*





## Setting the DMS2.5 (Continued)

### DMS2.5 System Environment Setting (Network settings)

- You can set and check information about DMS2.5 installation operation.

### DMS2.5 Network Information Setting

- 1 Select [System Settings] menu and click [System environment setting].
- 2 Click [Edit] from DMS2.5 network information window.
- 3 When text boxes of IP address, subnet mask address, default gateway and DNS server are enabled, enter values for each item.
  - ◆ 15 letters can be entered for each item.
  - ◆ Each item should match with the network address form.

#### When checking DHCP

- ◆ If you check the 'DHCP', the text boxes of IP address, subnet mask address, default gateway and DNS server will be disabled.
  - ◆ If you want manual setting, uncheck 'DHCP' and then enter network information manually.
- 4 After clicking [Save], click [OK] when the message window appears.
    - ◆ If you click [OK] after setting network information as 'Edit', current internet explorer will be closed. And when you access DMS2.5 again, you can access DMS2.5 using manually setting IP.
    - ◆ If you click [OK] after setting network information as 'DHCP', current internet explorer will be closed. And when you access DMS2.5 again, you can access DMS2.5 using the IP displayed in LCD Display.





**Note**

- ◆ **Factory setting is as follows.**
  - IP address: 192.168.0.100    - Subnet mask address: 255.255.255.0
  - Default gateway: 192.168.0.1 - DNS server: 0.0.0.0
- ◆ **If you enabled the function by checking 'DHCP', you can check changed network information on the external LCD display.**
- ◆ **If 'DHCP' is set, IP address from DHCP server will be displayed.**
- ◆ **DMS2.5 gets automatically set IP address when you activate DHCP function. When connecting DMS2.5 to S-NET series, you can connect them using the IP. However the auto setting IP address can be changed by events such as network environment of restart. In this case, it may cause communication failure between S-NET series and DMS2.5. Therefore it is not recommended to connect DMS2.5 using DHCP address and S-NET series.**
- ◆ **Refer to the user manual if you want to check other items of the system environment setting, tracking which collects information about indoor and outdoor units connected to DMS2.5, and setting for power distribution. To download the user manual, select [User manual] after selecting [System settings] menu.**



CAUTION

- ◆ **This product must be used in a dedicated network because it cannot respond to network attacks such as hacking and viruses. When it is connected to the Internet or an intranet (ex: an office LAN), it could be a risk of illegal approach. Also, this may change it to a harmful connection for other network devices. This is not the responsibility of Samsung Electronics and not included in compensation for the damage.**





## Setting the DMS2.5 (Continued)

### System Time Setting

- 1 Select [System Settings] menu and click [System environment setting].
- 2 Click [Edit] from system time setting.
- 3 Enter system time(year/month/day/hour/minute/second).
  - ◆ You can enter only numbers.
  - ◆ Year: You can enter from 1980 to 2035.
  - ◆ Month: You can enter from 1 to 12.
  - ◆ Day: You can enter from 1 to 31.
  - ◆ Hour: You can enter from 0 to 23.
  - ◆ Minute: You can enter from 0 to 59.
  - ◆ Second: You can enter from 0 to 59.
- 4 Click [Save] and message window appears. Then click [OK].
  - ◆ "Reading data from DMS2.5. Please wait." message appears and saving is completed. Then, system environment setting screen appears again as all items are disabled.

*Note* System time reflects set current time.





## Setting the Language

- 1 Select [System Settings] menu and click [System environment setting].
- 2 Click [Edit] from language selection.
- 3 Select a language you want then click [Save].
- 4 Click [OK] when “This operation needs DMS2.5 to be restarted. Do you want to apply the setting?” message appears.
  - ◆ Click [OK] and current web browser will be closed. DMS2.5 will restart and it may take approximately 1 minute.





## Setting the DMS2.5 (Continued)

### DMS2.5 Name Setting

- 1 Select [System Settings] menu and click [System environment setting].
- 2 Click [Edit] from DMS2.5 name setting window.
- 3 Enter name of DMS2.5 when DMS2.5 name field enabled.
  - ◆ You can use maximum 30 letters including English alphabets and special symbols.
  - ◆ When DMS2.5 name is set, the name will be displayed on the top title bar of web browser.
- 4 Click [Save] after setting is completed.
- 5 Click [OK] when “This information will be modified. Do you want to proceed?” message window appears.
- 6 “Reading data from DMS2.5. Please wait.” message appears and saving is completed. Afterwards, system environment setting screen appears again as all items are disabled.
  - ◆ You can check new DMS2.5 name on the title bar of web browser.

**Note** Name of DMS2.5 is set to blank as factory default.





## Error Mail Forwarding Setting

- 1 Select [System Settings] menu and click [System environment setting].
- 2 Click [Edit] from error mail forwarding setting.
- 3 Set all the items as the value you want when all items fields are enabled.
  - ◆ If you select 'Apply', you should enter e-mail address, SMTP server ID, password, and SMTP server address.
  - ◆ If you select 'Not apply', E-mail, ID, PW and SMTP server items will not affect.
- 4 Click [Save] after setting is completed.
- 5 Click [OK] when "This information will be modified. Do you want to proceed?" message window appears.
- 6 "Reading data from DMS2.5. Please wait." message appears and saving is completed. Afterwards, system environment setting screen appears again with all items are disabled.

- Note**
- ◆ *In factory setting, 'Not apply' is checked and item fields (E-mail, ID, PW, SMTP server) are blank.*
  - ◆ *E-mail forwarding function deals with the server supporting SSL.*





## Setting the DMS2.5 (Continued)

### Setting Enable public IP

- 1 Select [System Settings] menu and click [System environment setting].
- 2 Click [Edit] on Enable public IP section.
- 3 Select whether to use Public IP or not.
  - ◆ When you select 'Enable', you must register the Public IP of PCs or network devices to access DMS2.5 from the PCs or network devices.
- 4 Click [Save].

### Setting Public IP of upper controller

- 1 Select [System Settings] menu and click [System environment setting].
- 2 Click [Edit] on Public IP of upper controller section.
- 3 Register the Public IP of PCs or network devices to access DMS2.5 from the PCs or network devices.
  - ◆ Select 'Apply' after entering the Public IP to access DMS2.5.
- 4 Click [Save].







## System setting initialization

192.168.0.100  
06:12:13(AM)

- 1 Press [Menu], [▲], [▼] or [Set] on LCD if IP and current time are displayed on LCD screen.
  - ◆ Main menu screen appears.
  - ◆ Initialization is not possible in the screen which time information is displayed.

MAIN MENU  
1.IP Config

- 2 Press [Menu] → [▼] → [▲] → [▼] → [Menu] buttons in order in main menu screen.
  - ◆ Caution will be displayed on LCD Display.

Are you sure?  
YES:Set, NO:Menu

- 3 Initialize DMS2.5 by clicking [Set] when caution phrase appears.
  - ◆ If you press [Menu] button, turns back to main menu without initialization.



CAUTION

***When initializing system setting, all saved data in DMS2.5 will be deleted.  
After initialization, saved data and IP address will be same as factory setting.***





## Tracking

### ◆ What is tracking?

Tracking is an operation that finds devices which are connected to DMS2.5.

Through tracking operation, devices which are connected to DMS2.5 can recognize if they are connecting to DMS2.5.

To supervise and control system air conditioner using DMS2.5, tracking should be done first.

### ◆ Things you can do through tracking

Checking the number of devices installed, setting communication mode for each channel, DVM tracking, Renaming is possible through tracking.

### ◆ Execute tracking

- (1) Connect DVM device
  - Connect the device to COM1~COM5.
- (2) Set communication mode for each channel.
  - Set proper communication mode which fits to the devices connected in step (1).
  - Be careful that if communication mode is not properly set, the device will not be found through tracking.
- (3) Execute tracking - Execute DVM tracking.
  - DVM tracking is an operation that finds system air conditioner devices such as indoor/outdoor unit and watt-hour meter.
- (4) Name setting for each device.
  - Name setting for each device is a function that sets the name of connected devices.
  - Set the name which shows installation location of the device.

### ◆ Communication mode setting for each channel

Roles

- It records what devices are connected to COM1~ COM5 of DMS2.5.
- Through tracking, DMS2.5 searches proper devices which fits to user's setting.
- Select proper communication mode which fits to connected device.

What is communication mode?

- Outdoor unit, OnOff controller, SIM, PIM can be connected to DMS2.5.

- Following is the list of devices that can be communicated through each communication mode.

- ▶ NEW mode: OnOff controller, outdoor units, and SIM/PIM which support new communication mode.
- ▶ IM mode: IM mode cannot be set, but it can be used for function change or new function with an updated version.





## Setting Communication Mode for Each Channel

- 1 Select [System Settings] menu and click [Tracking].
- 2 Click [Edit] from communication mode for each channel setting.
  - ◆ [Edit] will change to [Cancel].
  - ◆ Selection buttons are enabled. However, the channels which have searched device maintains its selection button disabled.
- 3 When each channel is enabled, check the communication mode you want to set for each channel.
  - ◆ You cannot change the communication mode of channel which has currently connected device.
  - ◆ When 'NEW' is set as communication mode, setting will allow tracking, monitoring and controlling devices that support NEW communication mode.
  - ◆ IM mode cannot be set, but it can be used for function change or new function with an updated version.
- 4 Click [Save] after setting is completed.
  - ◆ "Reading data from DMS2.5. Please wait." message appears and saving is completed. After that, tracking page with disabled items will be displayed again.
  - ◆ If you click [Cancel], check boxes will be disabled and [Cancel] will change to [Edit].





## Tracking (Continued)

### DVM Tracking

- 1 Select [System Settings] menu and click [Tracking].
- 2 Click [DVM Tracking].
- 3 Enter administrator's password and then click [OK].
- 4 Tracking information window pops up. Check it and click [OK] to continue.
  - ◆ Execute tracking depending on the communication mode set by communication mode setting for each channel.
- 5 "Tracking is in progress. Please wait." message appears.
  - ◆ Tracking takes from few seconds to several ten minutes. However, it may vary depending on the number of installed controllers. (Max. 30 minutes)





- 6 Tracking completed message will appear.  
Select Zone initialization mode you want.
  - ◆ No initialization: No zone information initialization will be made.
  - ◆ Individual initialization: Initialize zone information as individual mode.
    - Individual mode: Arrange by indoor unit main address on monitoring page.
  - ◆ Group initialization: Initialize zone information as group mode.
    - Group mode: Create group by indoor unit group address (RMC) on monitoring page.

※ Individual mode and group mode can be changed in [Zone Setting & Edit].
- 7 Page will be refreshed by clicking [OK]. Then you can check tracking result.

- Note**
- ◆ *If tracking is executed successfully while 'NEW' is set as communication mode for each channel, virtual OnOff controller will be assigned to each channel.*
  - ◆ *If there is no searched outdoor unit, OnOff controller, SIM/ PIM, it is regarded as DVM tracking failure.*
  - ◆ *If there are devices which have same address, first searched device will be registered only.*
    - ※ *Searching order is not fixed.*
  - ◆ *The number of OnOff controller does not contain the number of virtual OnOff controller.*
  - ◆ *Total number of indoor units includes general indoor units, ERV, AHU, Fresh ducts, ERV PLUS, Hydro Unit, Hydro Unit HT, DVM CHILLER and FCU Kit.*



CAUTION

- ◆ ***If you execute tracking, system setting will be initialized.***
- ◆ ***If tracking result does not match with actual installation information, there can be critical error in additional functions such as power distribution.***
- ◆ ***Make sure that tracking information matches to actual installation information after tracking.***
- ◆ ***If there are errors on indoor and outdoor units while tracking, the units may not be matched.***





## Tracking (Continued)

### Disconnect All Devices

#### Function

Initialize searched device status in DMS2.5.  
Monitoring and controlling of all the connected devices to DMS2.5 will be stopped when you use this function.

- ◆ Connect searched device to the other channel and execute tracking.  
If the other device is searched in the channel you want to use, use 'Disconnect all devices' function.
- ◆ If you use this function, DMS2.5 device connection status will be initialized.

#### Disconnect All Devices

- 1 Select [System Settings] menu and click [Tracking].
- 2 Click [Disconnect all devices].
- 3 Enter administrator's password and then click [OK].
- 4 Disconnect all devices information window pops up. Check it and click [OK] to continue.
- 5 "Reading data from DMS2.5. Please wait." message appears.  
After completing disconnect all devices operation, page will be refreshed.

*Note*

- ◆ After executing disconnect all devices function, device search status of DMS2.5 will be initialized.
- ◆ You should execute tracking again after using disconnect all devices function.





## Renaming the Device

- 1 Select [System Settings] menu and click [Tracking].
- 2 Click [Edit] on the bottom of tracking device list.
  - ◆ [Edit] will change to [Cancel].
  - ◆ When the type of the device is displayed, NEW communication address will be shown with it.

*Note* If you press [Cancel] button, [Cancel] will change to [Edit], and the changed name of device will be restored to original name.

- 3 Enter the device name, which is saved in the PBA of indoor unit and outdoor unit, in the Device name field or enter the name, which is saved in the DMS2.5, in the Name field.
  - ◆ You cannot use special symbols as Device name and Name.
  - ◆ The Name should be within 16 letters.
  - ◆ The Device name should be within 10 letters.
  - ◆ Select the check box beside 'Device name' if you want to use the name of the device (that supports NEW communication) which is saved in the PBA
- 4 Click [Save] after setting is completed.
  - ◆ "Reading data from DMS2.5. Please wait." message appears and saving is completed. After that, tracking page with disabled items will be displayed again.
  - ◆ If you click [Cancel], input fields are disabled and [Cancel] will change to [Edit].





## Tracking (Continued)

### DMS DI•DO Port Setting

- 1 Select [System Settings] and then click [Tracking].
- 2 Click [Setting] which is next to DMS DI•DO of device list.
- 3 Click [Edit] which is on the bottom of DMS DI•DO setting page.
  - ◆ [Edit] will change to [Cancel].
- 4 Edit each item when DMS DI•DO selection and input fields are activated.
  - ◆ Device type : DI or DO
  - ◆ Short name – Input short name of the device.
  - ◆ Full name – Input full name of the device.
  - ◆ Minimum value / Maximum value – MIN value is fixed as OFF and MAX value is fixed as ON.
- 5 Click [Save].
  - ◆ After the saving is complete, DMS DI•DO setting page with all inactivated items will appear.
  - ◆ If you press [Cancel], webpage will refresh and it goes back to the state before the modification.







## PIM Setting

- 1 Click [System Settings] → [Tracking] when DMS2.5 web page menu screen appears.
- 2 Click [Setting] which is next to PIM of device list.
  - ◆ Enter administrator's password and then click [OK].
- 3 Click [Edit] which is on the bottom of PIM setting page.
  - ◆ [Edit] will change to [Cancel].
- 4 Select a field you want to change.
  - ◆ Meter Value ( 0~99999.9, to one decimal place)
  - ◆ Meter Type / Pulse rate
    - Electricity (1~10000)
    - Water (1~10000)
    - Gas (0.001~10, to three decimal places)
  - ◆ Channel Status
  - ◆ Time Setting
  - ◆ PIM Password (Number)



CAUTION

◆ **You should tick the check box of the channel you want to change.**

- 5 Click the check boxes to select the channel applying for the setting.
- 6 Click [Save].
  - ◆ If you press [Cancel], webpage will refresh and it goes back to the state before the modification.





## Setting the Power Distribution

- ◆ When doing power distribution, set SIM/PIM channel for each indoor unit.

### Channel Setting by Indoor Unit

- 1 Click [EHP Power Consumption Inspection] → [Channel setting by indoor unit] when DMS2.5 web page menu screen appears.
- 2 Click [Edit] when the setting channel by indoor unit screen appears.
- 3 Check the address and channel information of SIM/PIM which is connected to watt-hour meter.
  - ◆ If 0~7 SIM/PIM units execute tracking, it will be displayed as 16~23 in DMS2.5.
- 4 Check the information of indoor/outdoor unit which is connected to watt-hour meter.
- 5 Check the SIM/PIM channel(watt-hour meter) information of indoor/outdoor unit.
  - ◆ You can set the channel when SIM/PIM is installed in DMS2.5.
  - ◆ When bringing indoor unit's power from outdoor unit, set the 'Outdoor unit SIM channel' information only. ('Outdoor unit SIM channel' is referring to watt-hour meter which is connected to outdoor unit.)
  - ◆ When bringing indoor unit's power from the other device, not from outdoor unit, set the 'Outdoor unit SIM channel' and 'Indoor unit SIM channel' information. ('Indoor unit SIM channel' is referring to watt-hour meter which is connected to indoor unit.)
  - ◆ Power distribution will be executed automatically. The user does not need to check the value of watt-hour meter.
  - ◆ The maximum number of SIM channels for an outdoor unit is 4.





- 
- 6 Check the virtual channel information of indoor/outdoor unit.
    - ◆ To execute power distribution without SIM/PIM, you should set virtual channel.
    - ◆ When bringing indoor unit's power from outdoor unit, set the 'Outdoor unit virtual channel' information only.  
(‘Outdoor unit virtual channel’ is referring to watt-hour meter which is connected to outdoor unit.)
    - ◆ When bringing indoor unit's power from the other device, not from outdoor unit, set the 'Outdoor unit virtual channel' and 'Indoor unit virtual channel' information.  
(‘Indoor unit virtual channel’ is referring to watt-hour meter which is connected to indoor unit.)
    - ◆ The number of virtual channel varies depending on the number of outdoor unit.
    - ◆ To execute power distribution, you need to check watt-hour meter value manually.
    - ◆ Power distribution using SIM/PIM is more accurate than using indoor/outdoor unit virtual channel. Therefore, it is recommended to execute power distribution using SIM/PIM.

---

  - 7 Set indoor unit to execute power distribution.
    - ◆ If you do not set the watt-hour meter information, the power distribution result of the indoor unit will be displayed as '0'.

---

  - 8 Click [Save].
    - ◆ Set channel information will be saved in DMS2.5.
    - ◆ If you do not click [Save], changed setting will not be saved.
- 



CAUTION

- ◆ **Information of watt-hour meter connected to indoor/outdoor unit should be accurate. If the watt-hour meter information is not accurate when you set channel information of indoor unit, error may occur in the power distribution result.**
- ◆ **You should set SIM/PIM channel information in the indoor unit if you want to execute power distribution using SIM/PIM. If not, it means that you do not execute power distribution. In this case, the power distribution result of the indoor unit will be '0'.**
- ◆ **If the information of watt-hour meter connected to indoor/outdoor unit is changed, consult with installation engineer.**
- ◆ **DMS2.5 executes power distribution based on set information.**





# Appendix

## IP Terminology

- DMS2.5 needs IP address to contact other computers.

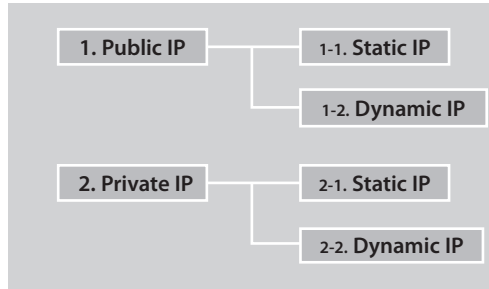

1. Public IP : Ordinary IP used to connect internet is called public IP.

1-1. Static IP : Static IP is a number that is assigned to a computer by an Internet service provider (ISP) to be its permanent address on the Internet.

1-2. Dynamic IP : Dynamic IP is a number, which changes every time when computer or model has restarted.

2. Private IP : This is a local IP which can not be used for internet connection. If you share internet connection through router, internet sharing software or, through OS, you may check the Client IP and they will be similar to below number system.

**10.0.0.0 ~ 10.255.255.255,**  
**172.16.0.0 ~ 172.31.255.255,**  
**192.168.0.0 ~ 192.168.255.255**

2-1. Static IP : Designated IP assigned by user.

2-2. Dynamic IP : User sets up to obtain their IP automatically.





## Examples of DMS2.5 Installation with DSL

### Local Management without External Control : Use Private IP

- ◆ Direct connection between DMS2.5 and computer or controller

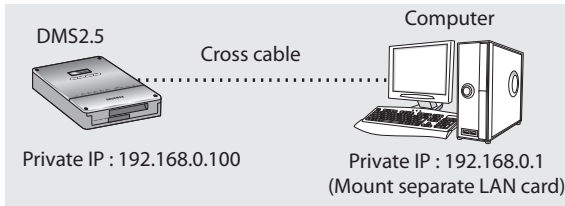

- ◆ Direct connection between DMS2.5 and computer or controller through HUB

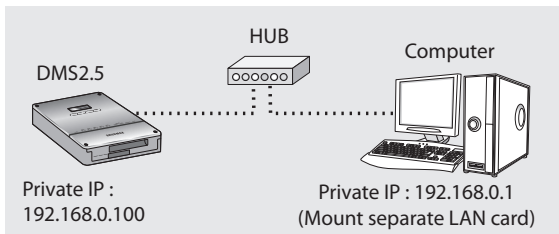



## Appendix (Continued)

### Initial Connection Error (for Private IP)

#### Several DMS2.5s are Connected to the Same Network

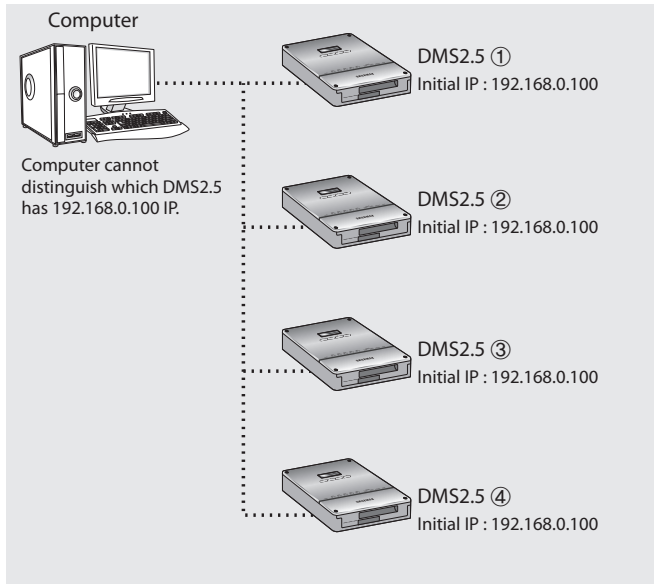

◆ In factory setting, all IP of DMS2.5 is same. Therefore, if you connect several DMS2.5 to the same network, the computer cannot distinguish which DMS2.5 has 192.168.0.100 IP address.

◆ Solution

- Connect only 1 DMS2.5 to the same network.
- Connect the power to only one DMS2.5 you want to use and cut the power for the rest of DMS2.5.
- Disconnect from the network and set the IP again per each DMS2.5. Then connect to the network again.



## BACnet Gateway setting

### System Architecture

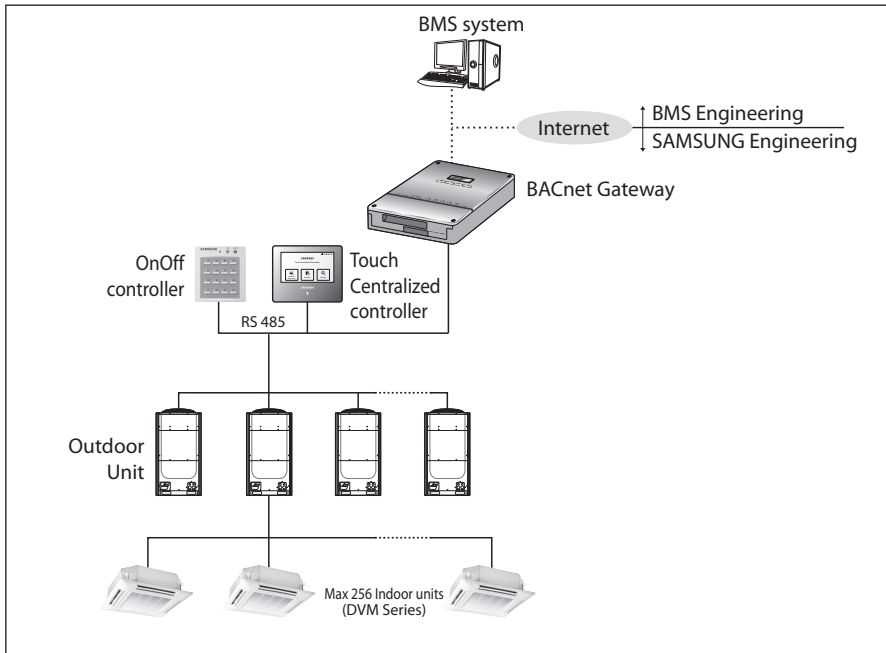

- Connecting outdoor units and BACnet Gateway
  - You can control up to 80 outdoor units and 256 indoor units using BACnet Gateway.
    - \* Each communication channel of BACnet Gateway can be connected with 16 outdoor units.
    - \* The maximum number of indoor units (including ERV and MCU) that can be connected to each communication channel of BACnet Gateway RS485 is 128.
  - The more outdoor units are connected, the longer time takes for tracking. (Max. 30 minutes)



◆ **For devices that support new communication, you must set the communication mode of the channel to 'NEW' from 'System settings → Tracking' menu. Set of Indoor/outdoor units, with conventional communication type, cannot be connected to BACnet Gateway with new communication.**

◆ **When setting communication channel mode as 'NEW', the address of virtual centralized control will be assigned.**

**Channel 0: Virtual OnOff controller 11, Channel 1: Virtual OnOff controller 12,  
Channel 2: Virtual OnOff controller 13, Channel 3: Virtual OnOff controller 14,  
Channel 4: Virtual OnOff controller 15**

## BACnet Gateway setting (Continued)

### Compatible Devices

No	Devices	Model	Note
1	Indoor Unit Outdoor Unit	Outdoor unit: DVM S HR, DVM S HP, DVM ECO, DVM S WATER, DVM S Cooling Only Indoor unit: Models that can be connected with above outdoor units	You should check that your indoor unit supports BACnet Gateway. (Refer to BACnet point list.)
2	OnOff controller/ Touch Centralized controller	MCM-A202DN, MCM-A300N	OnOff controller: Centralized controller
3	SIM	MIM-B12N	Needed for EHP power distribution
4	PIM	MIM-B16N	Needed for EHP power distribution
5*	Watt-hour Meter	RS485 comm. type	Connected with SIM Needed for power distribution ( Please consult Samsung for compatible power meters)
		Pulse type	Connected with PIM Pulse Width: 20~400(ms) Pulse: 1~10000(Wh/Pulse)

※ Products with '\*' are not Samsung products and must be purchased separately.  
(Only selected power meters may be used for protocol compatibility issues.)

※ Samsung is not responsible for BMS engineering which creates each device and objects.  
For further directions regarding on BMS engineering, consult with specialized BMS related vendor.





## Maximum Devices Attachable

Devices	Max.	Note
Indoor Unit	256	Tracking error occurs if exceeded The maximum number of indoor units (including ERV and MCU) that can be connected to each communication channel is 128.
OnOff controller/ Touch Centralized controller	75	Must not exceed 15 units per each RS485 communication terminal
Outdoor unit	80	Must not exceed 16 units per each RS485 communication terminal
SIM/PIM	8	
Watt-hour Meter	64	Maximum 8 units can be connected to 1 SIM/PIM.



CAUTION

- ◆ ***The sum of OnOff controller, touch centralized controller, and SIM/PIM interface module that can be connected to each communication channel should be 15 or less.***



## BACnet Gateway setting (Continued)

### Setting the BACnet Gateway

#### BACnet Gateway Connection and Login

- 1 Click internet explorer icon(  ) twice on your computer.
- 2 When internet explorer window appears, enter IP address (**https://192.168.0.100**) on the address bar then press [ENTER].
- 3 If it is the first time to access BACnet Gateway, "Install Microsoft Silverlight" message will appear.
  - ◆ If the Microsoft Silverlight has already been installed, the above message will not appear.
- 4 Click [Run] button and continue installation. After installation, access BACnet Gateway again.



CAUTION

**Silverlight operates normally with Windows 7 or later version. It may not operate normally with previous version of Windows.**

- 5 Enter ID and password when BACnet Gateway main web page appears, Then click [LOGIN].
  - ◆ If you use accounts with general authorization level to login, you cannot use the BACnet Gateway settings.
  - ◆ Depending on authorization level set by the administrator, access to some functions may be restricted.
  - ◆ You can change authorization level settings from **System settings → User authorization management**.
  - ◆ To use the BACnet Gateway functions, you must login with the ID that is included in administration group. Factory default BACnet Gateway ID is 'admin' and password is 'ac0530'.

#### Note

- ◆ Only authorized users can access web page.
- ◆ Connection speed may slow down. Fewer than 5 concurrent users are recommended.
- ◆ BACnet Gateway manager should change ID and password for security and management.
- ◆ Logout: If you want to logout, click [LOGOUT] on the top of the menu. BACnet Gateway will be ended.





CAUTION

- ◆ ***If you use accounts with authorization level lower than management group or accounts with general authorization level, you cannot access BACnet Gateway settings.***
- ◆ ***If you cannot access BACnet Gateway, consult the manager.***

- 6 If you login successfully, 'Control and Monitoring' screen will appear.  
Click [System Setting]→[BACnet configuration] menu to switch to BACnet Gateway.



CAUTION

- ◆ ***If you use accounts with authorization level lower than management group or accounts with general authorization level, BACnet configuration will not be displayed on the menu.***
- ◆ ***If the BACnet configuration menu does not appear, consult the manager.***

- 7 If you access BACnet Gateway, 'Device Configuration' screen will appear initially.
  - ◆ If you click [DMS2.5 Connect] button, screen will be switched to initial screen.





## BACnet Gateway setting (Continued)

### Reading EHP Watt-hour Meter

#### Setting and checking watt-hour meter

- 1 Click [System and Checking Watt-hour meter].
  - ◆ You can change settings on watt-hour meter only when SIM/PIM interface module is connected.
- 2 Click [Edit] from the 'Setting and checking Watt-hour meter' screen.
  - ◆ CT proportion is set to '1' as factory default value.
- 3 Set the [Name] and [CT proportion] for the watt-hour meter.
  - ◆ You can use maximum 16 letters for name and only available special characters are ".", ",", "\_", "-", and "space".
  - ◆ Value for CT proportion should be integer between range of 1 ~ 5000.
- 4 Click [Save].
  - ◆ CT proportion value will be saved to the BACnet Gateway.
  - ◆ If you do not click [Save] changed setting will not be saved.
- 5 Watt-hour meter value will display the actual value of electricity on the corresponding watt-hour meter. Value will be updated automatically.



CAUTION

***When using CT watt-hour meter, be careful that there can be difference with actual power consumption as much as CT ratio error.***





## Monthly baseline setting

- 1 Click [System and Checking Watt-hour meter].
- 2 Click [Edit] from the 'Monthly baseline setting' screen.
  - ◆ You can make changes when list box enables.
- 3 Set the Monthly baseline setting.
  - ◆ You can select from 1 ~ 31.
  - ◆ If you select the last day of the month, it will automatically set the last day of corresponding month as baseline.  
Ex) Last day of February: 28<sup>th</sup> or 29<sup>th</sup>
  - ◆ Power consumption is calculated for a month before monthly baseline.  
Ex) Monthly baseline: 28<sup>th</sup>  
Today: 19<sup>th</sup> Nov.  
Time period for power consumption and operation: 29<sup>th</sup> Sep. ~ 28<sup>th</sup> Oct.
- 4 Click [Save].
  - ◆ Changed settings will be saved to the BACnet Gateway.
  - ◆ If you do not click [Save] changed setting will not be saved.

## Period setting

- 1 Click [System and Checking Watt-hour meter].
- 2 Click [Edit] from the 'Period setting' screen.
  - ◆ You can select checkbox to set period in daily or monthly unit.
  - ◆ If you select daily period setting, text box will be enabled and you can enter the period in daily unit.
  - ◆ If you select monthly period setting, you can select the period in monthly unit.
- 3 Set the period
  - ◆ If you set period in daily unit, you can set up to maximum 90 days.
  - ◆ If you set period in monthly unit, you can set up to maximum 1 months.
- 4 Click [Save].
  - ◆ Changed setting will be saved to BACnet Gateway.
  - ◆ If you do not click [Save], changed setting will not be saved.





## BACnet Gateway setting (Continued)

### System Settings

- ◆ You can set and check information about BACnet Gateway installation and operation.

#### BACnet Gateway network information

- 1 Click [System Settings].
- 2 Click [Edit] from the 'BACnet network information' section.
- 3 When text boxes of IP, Subnet mask, Default gateway, DNS server, BBMD IP, BBMD PORT, Network No., and BACnet PORT are enabled, enter the address values for each item.
  - ◆ 15 letters can be entered for each item.
  - ◆ Each item should match with the network address form.
  - ◆ You can enter from 1 to 40 for Network No.
  - ◆ If you want to use multiple BACnet Gateway in the same network, you should set up "Network No." differently.
  - ◆ You can edit BBMD PORT. You can enter from 0 to 65535.
  - ◆ You can edit BACnet PORT. You can enter from 0 to 65535.
- 4 Click [Save] button on the 'BACnet network information' section.
- 5 When the pop-up window appears, click [OK].
- 6 If you click [OK], current internet explorer will be closed. Then you may run the web browser again and access BACnet Gateway by entering the IP set and saved manually.



CAUTION

- ◆ **Default value of BACnet PORT is 47808.**
- ◆ **Check the communication with external BACnet device when changing BACnet PORT.**
- ◆ **Set default value of BBMD PORT when not using BBMD function.**
- ◆ **Default value of BBMD PORT is 0 (Not used).**
- ◆ **Check the communication with external BACnet device when using BBMD function.**
- ◆ **Local network does not work when changing BBMD PORT.**
- ◆ **Default value of network number is 9.**
- ◆ **Set the network number that is not repeated when communicating externally.**





## **BACnet gateway information and initialization**

- 1** Click [System Settings].
- 2** You can check the basic BACnet gateway information from 'BACnet gateway information' section.
- 3** Click [Edit] from the 'BACnet gateway information' section.
- 4** If you want to initialize 'Recipient\_list', Check and click [Save].
- 5** When the pop-up window appears, click [OK]. BACnet Gateway will restart and the system will initialize 'Recipient\_list'.





## BACnet Gateway setting (Continued)

### Device Configuration

#### Checking device information

- 1 Click one of the Object ID from 'Object ID' column.  
Detail information of the selected device will be displayed in device information.

---

- 2 Analog data of the selected device will be displayed in Analog data.
  - ◆ Object ID: Displays ID of the corresponding object.
  - ◆ Type: Displays type of the corresponding object.
    - AI: Input (Read Only)
    - AO: Output (Read/Write)
    - AV: Value (Read/Write)
  - ◆ Object Name: Displays the name of the corresponding object.
  - ◆ Value: Displays the current value of the corresponding object.
    - Unit will be displayed between [ ].

---

- 3 Binary data of the selected device will be displayed in Binary data.
  - ◆ Object ID: Displays ID of the corresponding object.
  - ◆ Type: Displays type of the corresponding object.
    - BI: Input (Read Only)
    - BO: Output (Read/Write)
    - BV: Value (Read/Write)
  - ◆ Object Name: Displays the name of the corresponding object.
  - ◆ Value: Displays the current value of the corresponding object.
    - It will be displayed either On or Off

---

- 4 Multi-state Data of the selected device will be displayed in Multi-state data.
  - ◆ Object ID: Displays ID of the corresponding object.
  - ◆ Type: Displays type of the corresponding object.
    - MI: Input (Read Only)
    - MO: Output (Read/Write)
    - MV: Value (Read/Write)
  - ◆ Object Name: Displays the name of the corresponding object.
  - ◆ Value: Displays the current value of the corresponding object.

**Note** Please refer to BACnet Point List to check the device configuration data for each device (Refer to page 62~67).







## BACnet Protocol Implementation Conformance Statement

Date: 2016.01.11

Vendor Name: SAMSUNG Electronics CO., Ltd.

Product Name: DMS BACnet Gateway

Product Model Number: MIM-B17BN, MIM-B17BUN

Application Software Version: 1.20 Firmware Revision: 1.20

BACnet Protocol Revision: 2.0

### Product Description:

This product supports BACnet/IP and provide functions to monitor and control status of air conditioner.

### BACnet Standardized Device Profile (Annex L):

- BACnet Operator Workstation (B-OWS)
- BACnet Advanced Operator Workstation (B-AWS)
- BACnet Operator Display (B-OD)
- BACnet Building Controller (B-BC)
- BACnet Advanced Application Controller (B-AAC)
- BACnet Application Specific Controller (B-ASC)
- BACnet Smart Sensor (B-SS)
- BACnet Smart Actuator (B-SA)

List all BACnet Interoperability Building Blocks Supported (Annex K): \_\_\_\_\_

	SUPPORTED BIBBS	BIBB NAME	SUPPORTED	REMARKS
Data Sharing	DS-RP-A	Data Sharing-ReadProperty-A	<input type="checkbox"/>	
	DS-RP-B	Data Sharing-ReadProperty-B	<input checked="" type="checkbox"/>	
	DS-RPM-A	Data Sharing-ReadPropertyMultiple-A	<input type="checkbox"/>	
	DS-RPM-B	Data Sharing-ReadPropertyMultiple-B	<input checked="" type="checkbox"/>	
	DS-RPC-A	Data Sharing-ReadPropertyConditional-A	<input type="checkbox"/>	
	DS-RPC-B	Data Sharing-ReadPropertyConditional-B	<input type="checkbox"/>	
	DS-WP-A	Data Sharing-WriteProperty-A	<input type="checkbox"/>	
	DS-WP-B	Data Sharing-WriteProperty-B	<input checked="" type="checkbox"/>	
	DS-WPM-A	Data Sharing-WritePropertyMultiple-A	<input type="checkbox"/>	
	DS-WPM-B	Data Sharing-WritePropertyMultiple-B	<input checked="" type="checkbox"/>	
	DS-COV-A	DataSharing-COV-A	<input type="checkbox"/>	
	DS-COV-B	DataSharing-COV-B	<input checked="" type="checkbox"/>	
	DS-COVP-A	DataSharing-COVP-A	<input type="checkbox"/>	
	DS-COVP-B	DataSharing-COVP-B	<input type="checkbox"/>	
	DS-COVU-A	DataSharing-COV-Unsolicited-A	<input type="checkbox"/>	
DS-COVU-B	DataSharing-COV-Unsolicited-B	<input type="checkbox"/>		



## BACnet Gateway setting (Continued)

	SUPPORTED BIBBS	BIBB NAME	SUPPORTED	REMARKS
Alarm and Event Management	AE-N-A	Alarm&Event-Notification-A	<input type="checkbox"/>	
	AE-N-I-B	Alarm&Event-Notification Internal-B	<input checked="" type="checkbox"/>	Optional Support
	AE-N-E-B	Alarm&Event-Notification External-B	<input type="checkbox"/>	
	AE-ACK-A	Alarm&Event-ACK-A	<input type="checkbox"/>	
	AE-ACK-B	Alarm&Event-ACK-B	<input type="checkbox"/>	
	AE-ASUM-A	Alarm&Event-Summary-A	<input type="checkbox"/>	
	AE-ASUM-B	Alarm&Event-Summary-B	<input type="checkbox"/>	
	AE-ESUM-A	Alarm&Event-Enrollment Summary-A	<input type="checkbox"/>	
	AE-ESUM-B	Alarm&Event-Enrollment Summary-B	<input type="checkbox"/>	
	AE-INFO-A	Alarm&Event-Information-A	<input type="checkbox"/>	
	AE-INFO-B	Alarm&Event-Information-B	<input type="checkbox"/>	
	AE-LS-A	Alarm&Event-LifeSafety-A	<input type="checkbox"/>	
AE-LS-B	Alarm&Event-LifeSafety-B	<input type="checkbox"/>		
Scheduling	SCHED-A	Scheduling-A	<input type="checkbox"/>	
	SCHED-I-B	Scheduling-Internal-B	<input type="checkbox"/>	
	SCHED-E-B	Scheduling-External-B	<input type="checkbox"/>	
Trending	T-VMT-A	Viewing and Modifying Trends-A	<input type="checkbox"/>	
	T-VMT-I-B	Viewing and Modifying Trends Internal-B	<input type="checkbox"/>	
	T-VMT-E-B	Viewing and Modifying Trends External-B	<input type="checkbox"/>	
	T-ATR-A	Automated Trend Retrieval-A	<input type="checkbox"/>	
	T-ATR-B	Automated Trend Retrieval-B	<input type="checkbox"/>	
	T-VMMV-A	Viewing and Modifying Multiple Values-A	<input type="checkbox"/>	
	T-VMMV-I-B	View and Modifying Multiple Values Internal-B	<input type="checkbox"/>	
	T-VMMV-E-B	View and Modifying Multiple Values External-B	<input type="checkbox"/>	
Device and Network Management	T-AMVR-A	Automated Multiple Value Retrieval-A	<input type="checkbox"/>	
	T-AMVR-B	Automated Multiple Value Retrieval-B	<input type="checkbox"/>	
	DM-DDB-A	Dynamic Device Binding-A	<input type="checkbox"/>	
	DM-DDB-B	Dynamic Device Binding-B	<input checked="" type="checkbox"/>	
	DM-DOB-A	Dynamic Object Binding-A	<input type="checkbox"/>	
	DM-DOB-B	Dynamic Object Binding-B	<input checked="" type="checkbox"/>	
	DM-DCC-A	DeviceCommunicationControl-A	<input type="checkbox"/>	
	DM-DCC-B	DeviceCommunicationControl-B	<input type="checkbox"/>	
	DM-TM-A	Text Message-A	<input type="checkbox"/>	
	DM-TM-B	Text Message-B	<input type="checkbox"/>	
	DM-TS-A	Time Synchronization-A	<input type="checkbox"/>	
	DM-TS-B	Time Synchronization-B	<input checked="" type="checkbox"/>	
	DM-UTC-A	UTCTime Synchronization-A	<input type="checkbox"/>	
	DM-UTC-B	UTCTime Synchronization-B	<input type="checkbox"/>	
DM-RD-A	ReinitializeDevice-A	<input type="checkbox"/>		
DM-RD-B	ReinitializeDevice-B	<input type="checkbox"/>		
DM-BR-A	Backup&Restore-A	<input type="checkbox"/>		
DM-BR-B	Backup&Restore-B	<input type="checkbox"/>		



	SUPPORTED BIBBS	BIBB NAME	SUPPORTED	REMARKS
Device and Network Management	DM-R-A	Restart-A	<input type="checkbox"/>	
	DM-R-B	Restart-B	<input type="checkbox"/>	
	DM-LM-A	List Manipulation-A	<input type="checkbox"/>	
	DM-LM-B	List Manipulation-B	<input type="checkbox"/>	
	DM-OCD-A	Object Creation & Deletion-A	<input type="checkbox"/>	
	DM-OCD-B	Object Creation & Deletion-B	<input type="checkbox"/>	
	DM-VT-A	Virtual Terminal-A	<input type="checkbox"/>	
	DM-VT-B	Virtual Terminal-B	<input type="checkbox"/>	
	NM-CE-A	Connection Establishment-A	<input type="checkbox"/>	
	NM-CE-B	Connection Establishment-B	<input type="checkbox"/>	
	NM-RC-A	Router Configuration-A	<input type="checkbox"/>	
NM-RC-B	Router Configuration-B	<input type="checkbox"/>		

#### Segmentation Capability:

- Segmented requests supported Window Size \_\_\_\_\_
- Segmented responses supported Window Size \_\_\_\_\_

#### Standard Object Types Supported:

Object-Type	Supported	Dynamically Creatable	Dynamically Deletable	Writeable Properties
Analog Input	<input checked="" type="checkbox"/>	<input type="checkbox"/>	<input type="checkbox"/>	
Analog Output	<input type="checkbox"/>	<input type="checkbox"/>	<input type="checkbox"/>	
Analog Value	<input checked="" type="checkbox"/>	<input type="checkbox"/>	<input type="checkbox"/>	Present value
Binary Input	<input checked="" type="checkbox"/>	<input type="checkbox"/>	<input type="checkbox"/>	
Binary Output	<input checked="" type="checkbox"/>	<input type="checkbox"/>	<input type="checkbox"/>	Present value
Binary Value	<input checked="" type="checkbox"/>	<input type="checkbox"/>	<input type="checkbox"/>	Present value
Calendar	<input type="checkbox"/>	<input type="checkbox"/>	<input type="checkbox"/>	
Command	<input type="checkbox"/>	<input type="checkbox"/>	<input type="checkbox"/>	
Device	Yes	n/a	n/a	n/a
Event Enrollment	<input type="checkbox"/>	<input type="checkbox"/>	<input type="checkbox"/>	
File	<input type="checkbox"/>	<input type="checkbox"/>	<input type="checkbox"/>	
Group	<input type="checkbox"/>	<input type="checkbox"/>	<input type="checkbox"/>	
Loop	<input type="checkbox"/>	<input type="checkbox"/>	<input type="checkbox"/>	
Multi-state Input	<input checked="" type="checkbox"/>	<input type="checkbox"/>	<input type="checkbox"/>	Present value
Multi-state Output	<input type="checkbox"/>	<input type="checkbox"/>	<input type="checkbox"/>	
Multi-state Value	<input checked="" type="checkbox"/>	<input type="checkbox"/>	<input type="checkbox"/>	Present value
Notification Class	<input checked="" type="checkbox"/>	<input type="checkbox"/>	<input type="checkbox"/>	Recipient_List
Program	<input type="checkbox"/>	<input type="checkbox"/>	<input type="checkbox"/>	
Schedule	<input type="checkbox"/>	<input type="checkbox"/>	<input type="checkbox"/>	





## BACnet Gateway setting (Continued)

### Data Link Layer Options:

- BACnet IP, (Annex J)
- BACnet IP, (Annex J), Foreign Device
- ISO 8802-3, Ethernet (Clause 7)
- ANSI/ATA 878.1, 2.5 Mb. ARCNET (Clause 8)
- ANSI/ATA 878.1, RS-485 ARCNET (Clause 8), baud rate(s) \_\_\_\_\_
- MS/TP master (Clause 9), baud rate(s): \_\_\_\_\_
- MS/TP slave (Clause 9), baud rate(s): \_\_\_\_\_
- Point-To-Point, EIA 232 (Clause 10), baud rate(s): \_\_\_\_\_
- Point-To-Point, modem, (Clause 10), baud rate(s): \_\_\_\_\_
- LonTalk, (Clause 11), medium: \_\_\_\_\_
- BACnet/ZigBee (ANNEX O)
- Other: \_\_\_\_\_

### Device Address Binding:

Is static device binding supported? (This is currently necessary for two-way communication with MS/TP slaves and certain other devices.)  Yes  No

### Networking Options:

- Router, Clause 6 - List all routing configurations, e.g., ARCNET-Ethernet, Ethernet-MS/TP, etc.
- Annex H, BACnet Tunneling Router over IP
- BACnet/IP Broadcast Management Device (BBMD)
  - Does the BBMD support registrations by Foreign Devices?  Yes  No
  - Does the BBMD support network address translation?  Yes  No

### Character Sets Supported:

Indicating support for multiple character sets does not imply that they can all be supported simultaneously.

- ANSI X3.4  IBM™/Microsoft™ DBCS  ISO 8859-1
- ISO 10646 (UCS-2)  ISO 10646 (UCS-4)  JIS 0208

If this product is a communication gateway, describe the types of non-BACnet equipment/networks(s) that the gateway supports:

This gateway switches SAMSUNG air conditioner protocol to BACnet protocol to make RS-485 communication possible with the air conditioners connected to gateway.





## Detail Description of Object

### Device

Following table shows regulation of device ID and they are created automatically.

Item	DNET – Range [Digit 2]	CPP – Range [Digit 3]	INDOOR – Range [Digit 2]
Centralized Controller (OnOff Controller)	1~40	000~015	64
SIM/PIM	1~40	100~115	64
DMS DI/DO	1~40	300~315	64
Interface Module (Outdoor Unit)	1~40	400~655 (16 x 16)	64
Indoor Unit, ERV, ERV Plus, AHU kit, EHS, Fresh duct	1~40	400~655	0~63
Gateway	1~40	900	64

#### Ex) Indoor Unit

**DNET (Gateway number): 9**

**Indoor Unit Address: 01.01.32**

**Device ID: 941732**

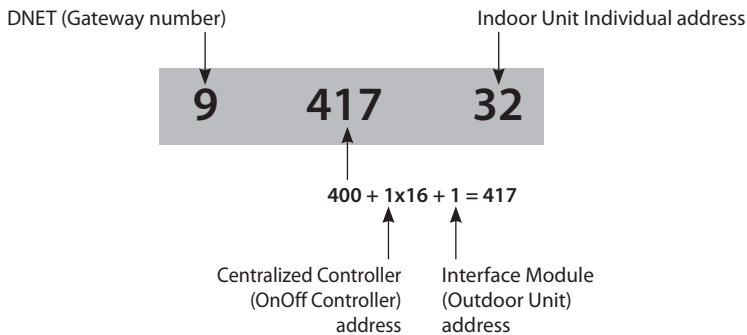

#### ◆ Object of device

Refer to BACnet point List

#### ◆ Command Priorities

- Supports 1 ~ 16 Priority Level
- Recommends 8 Priority Level



## BACnet Gateway setting (Continued)

### BACnet Point List

#### Indoor Unit

Single indoor unit has following point list.

Instance Number	Object	Object Type	Object Name	Unit		Status value				
				Inactive	Active					
				Text-1	Text-2	Text-3	Text-4	Text-5		
1	Indoor Temperature	AI	AC_RoomTemp_xx_xxxxxx	°C						
2	Set temperature	AV	AC_Temp_Set_xx_xxxxxx	°C						
3	Setting lower temperature limit	AV	AC_Cool_LimitTemp_xx_xxxxxx	°C						
4	Setting upper temperature limit	AV	AC_Heat_LimitTemp_xx_xxxxxx	°C						
5	The power value of an indoor unit after the basic date	AI	AC_Baseline_kWh_xx_xxxxxx	kWh						
6	The number of hours usage of an indoor unit after the basic date	AI	AC_Baseline_Minute_xx_xxxxxx	Minute						
7	Power value within period	AI	AC_Period_kWh_xx_xxxxxx	kWh						
8	The number of hours usage of an indoor unit within period	AI	AC_Period_Minute_xx_xxxxxx	Minute						
** 9	Power On/Off	BV	AC_Power_xx_xxxxxx	Off	On					
10	Applying lower temperature limit setting	BV	AC_Cool_Limit_set_xx_xxxxxx	False	True					
11	Applying upper temperature limit setting	BV	AC_Heat_Limit_set_xx_xxxxxx	False	True					
** 12	Filter sign status	BI	AC_FilterSign_xx_xxxxxx	False	True					
** 13	Filter sign reset	BO	AC_FilterSign_Reset_xx_xxxxxx	False	True					
** 14	Operation mode status	MV	AC_Operation_Mode_xx_xxxxxx	Auto	Cool	Heat	Fan	Dry		
* 15	Fan speed status	MV	AC_FanSpeed_xx_xxxxxx	Auto	Low	Mid	High	Turbo		
16	Air flow direction status	MV	AC_FanFlow_xx_xxxxxx	None	Vertical	Horizon	All			
** 17	Operation mode limit status	MV	AC_Mode_Limit_xx_xxxxxx	No Limit	Cool Only	Heat Only				
** 18	Remote controller limit status	MV	AC_Remocon_Limit_xx_xxxxxx	Enable RC	Disable RC	Conditional RC				
** 19	Integrated error code of both indoor unit and outdoor unit	AI	AC_Error_Code_xx_xxxxxx	Refer to list of error code						
* 20	SPI setting	BV	AC_SPI_xx_xxxxxx	False	True					
* 21	HumanSensor setting	BV	AC_MDS_xx_xxxxxx	False	True					
** 22	AC Indoor Notify	NC	AC_Notify_xx_xxxxxx	When the error occurred, send event to list of destination in the recipient_list. (Max : 8)						
* 23	Discharge cooling set temperature	AV	AC_DisCoolTemp_Set_xx_xxxxxx	°C/F						
* 24	Discharge heating set temperature	AV	AC_DisHeatTemp_Set_xx_xxxxxx	°C/F						
* 25	Discharge current temperature	AI	AC_DisCurrentTemp_xx_xxxxxx	°C/F						

\* Temperature setting range can be different depending on the model and the common range is as follows:

Auto: 18 °C~30 °C

Cool: 18 °C~30 °C

Heat: 16 °C~30 °C

Fan: Temperature cannot be adjusted

Dry: 18 °C~30 °C

(\*) Mark is optionally supported. For a fresh duct, (\*\*) mark is supported.



## AHU Kit

Single AHU unit has following point list.

Instance Number	Object	Object Type	Object Name	Unit		Status value				
				Inactive	Active					
				Text-1	Text-2	Text-3	Text-4	Text-5		
1	Indoor Temperature	AI	AHU_RoomTemp_xx_xxxxxx	°C						
2	Set temperature	AV	AHU_Temp_Set_xx_xxxxxx	°C						
3	Setting lower temperature limit	AV	AHU_Cool_LimitTemp_xx_xxxxxx	°C						
4	Setting upper temperature limit	AV	AHU_Heat_LimitTemp_xx_xxxxxx	°C						
5	The power value of an indoor unit after the basic date	AI	AHU_Baseline_kWh_xx_xxxxxx	kWh						
6	The number of hours usage of an indoor unit after the basic date	AI	AHU_Baseline_Minute_xx_xxxxxx	Minute						
7	Power value within period	AI	AHU_Period_kWh_xx_xxxxxx	kWh						
8	The number of hours usage of an indoor unit within period	AI	AHU_Period_Minute_xx_xxxxxx	Minute						
9	Power On/Off	BV	AHU_Power_xx_xxxxxx	Off	On					
10	Applying lower temperature limit setting	BV	AHU_Cool_Limit_set_xx_xxxxxx	False	True					
11	Applying upper temperature limit setting	BV	AHU_Heat_Limit_set_xx_xxxxxx	False	True					
12	Filter sign status	BI	AHU_FilterSign_xx_xxxxxx	False	True					
13	Filter sign reset	BO	AHU_FilterSign_Reset_xx_xxxxxx	False	True					
14	Operation mode status	MV	AHU_Operation_Mode_xx_xxxxxx	Auto	Cool	Heat	Fan	Dry		
15	Operation mode limit status	MV	AHU_Mode_Limit_xx_xxxxxx	No Limit	Cool Only	Heat Only				
16	Remote controller limit status	MV	AHU_Remocon_Limit_xx_xxxxxx	Enable RC	Disable RC	Conditional RC				
17	Integrated error code of both indoor unit and outdoor unit	AI	AHU_Error_Code_xx_xxxxxx	Refer to list of error code						
* 18	Discharge cooling set temperature	AV	AHU_DisCoolSetTemp_xx_xxxxxx	°C						
* 19	Discharge heating set temperature	AV	AHU_DisHeatSetTemp_xx_xxxxxx	°C						
* 20	Discharge current temperature	AI	AHU_Dis_CurrentTemp_xx_xxxxxx	°C						
* 21	Humidification setting	BV	AHU_Humidification_xx_xxxxxx	Off	On					
* 22	Outdoor air intake setting	BV	AHU_OAIntake_xx_xxxxxx	Off	On					
* 23	Outdoor cooling setting	BV	AHU_OutdoorCool_xx_xxxxxx	Off	On					
* 24	Fan speed status	MV	AHU_FanSpeed_xx_xxxxxx	Low	Mid	High				
* 25	Set humidity status	MV	AHU_SetHumidity_xx_xxxxxx	Low	Mid	High				
* 26	Current humidity status	MI	AHU_CurrentHumidity_xx_xxxxxx	Low	Mid	High				
27	AHU Notify	NC	AHU_Notify_xx_xxxxxx	When the error occurred, send event to list of destination in the recipient_list. (Max : 8)						

(\* ) Mark is optionally supported.



## BACnet Gateway setting (Continued)

### EHS

Single EHS Unit has following point list.

Instance Number	Object	Object Type	Object Name	Unit		Status value			
				Inactive	Active	Text-1	Text-2	Text-3	Text-4
1	Room temperature	AI	EHS_RoomTemp_xx_xxxxxx	°C					
2	Set temperature	AV	EHS_Temp_Set_xx_xxxxxx	°C	Use when displayed temperature type is set to 'Room'.				
3	Set temperature of water out	AV	EHS_WaterOutTemp_Set_xx_xxxxxx	°C	Use when displayed temperature type is set to 'WaterOut'.				
4	Set temperature of hot water	AV	EHS_HotWaterTemp_Set_xx_xxxxxx	°C					
5	Setting lower temperature limit	AV	EHS_Cool_LimitTemp_xx_xxxxxx	°C	Use when displayed temperature type is set to 'Room'.				
6	Setting upper temperature limit	AV	EHS_Heat_LimitTemp_xx_xxxxxx	°C	Use when displayed temperature type is set to 'Room'.				
7	Lower temperature limit for water out	AV	EHS_WOCoolLimitTemp_xx_xxxxxx	°C					
8	Upper temperature limit for water out	AV	EHS_WOHeatLimitTemp_xx_xxxxxx	°C					
9	Upper temperature limit for hot water	AV	EHS_WTHeatLimitTemp_xx_xxxxxx	°C					
10	The power value after the basic date	AI	EHS_Baseline_kWh_xx_xxxxxx	kWh					
11	The number of hours usage of an indoor unit after the basic date	AI	EHS_Baseline_Minute_xx_xxxxxx	Minute					
12	Power value within period	AI	EHS_Period_kWh_xx_xxxxxx	kWh					
13	The number of hours usage of an indoor unit within period	AI	EHS_Period_Minute_xx_xxxxxx	Minute					
14	Current temperature of water out	AI	EHS_WOCurrentTemp_xx_xxxxxx	°C					
15	Current temperature of hot water	AI	EHS_HotWaterTemp_xx_xxxxxx	°C					
16	Displayed temperature type	BI	EHS_ControlTempType_xx_xxxxxx	Room	WaterOut				
17	Thermostat usage	BI	EHS_Thermostat_xx_xxxxxx	False	True				
18	Outing	BI	EHS_GoOut_xx_xxxxxx	Off	On				
19	Power On/Off	BV	EHS_Power_xx_xxxxxx	Off	On				
20	Setting lower temperature limit	BV	EHS_Cool_LimitTemp_Set_xx_xxxxxx	False	True	Use when displayed temperature type is set to 'Room'.			
21	Setting upper temperature limit	BV	EHS_Heat_LimitTemp_Set_xx_xxxxxx	False	True	Use when displayed temperature type is set to 'Room'.			
22	Apply lower temperature limit for water out	BV	EHS_WOCoolLimitFlag_xx_xxxxxx	False	True	Use when displayed temperature type is set to 'WaterOut'.			
23	Apply upper temperature limit for water out	BV	EHS_WOHeatLimitFlag_xx_xxxxxx	False	True	Use when displayed temperature type is set to 'WaterOut'.			
24	Apply upper temperature limit for hot water	BV	EHS_WTHeatLimitFlag_xx_xxxxxx	False	True				
25	On/Off status of hot water mode	BV	EHS_HotWater_Power_xx_xxxxxx	Off	On				
26	Status of quiet operation	BV	EHS_Sleep_xx_xxxxxx	Off	On				
27	Operation mode status	MV	EHS_Operation_Mode_xx_xxxxxx	Auto	Cool	Heat			
28	Operation mode limit status	MV	EHS_Mode_Limit_xx_xxxxxx	No Limit	Cool Only	Heat Only			
29	Remote controller limit status	MV	EHS_Remocon_Limit_xx_xxxxxx	Enable RC	Disable RC	Conditional RC			
30	Status of hot water operation mode	MV	EHS_HotWater_Mode_xx_xxxxxx	*Force	Eco	Standard	Power		
31	Integrated error code of both indoor unit and outdoor unit	AI	EHS_Error_Code_xx_xxxxxx						
32	EHS notify	NC	EHS_Notify_xx_xxxxxx	When the error occurred, send event to list of destination in the recipient_list. (Max : 8)					

Force hot water mode (\* marked) will be supported later.  
It is the point list of Hydro Unit and Hydro Unit HT.



## ERV, ERV Plus

Single ERV or ERV Plus unit has following point list.

Instance Number	Object	Object Type	Object Name	Unit		Status value				
				Inactive	Active					
				Text-1	Text-2	Text-3	Text-4	Text-5		
1	Power On/Off operation	BV	ERV_Power_xx_xxxxxx	Off	On					
2	Filter sign status	BI	ERV_FilterSign_xx_xxxxxx	False	True					
3	Filter sign reset	BO	ERV_FilterSign_Reset_xx_xxxxxx	False	True					
4	Operation mode status	MV	ERV_Operation_Mode_xx_xxxxxx	Auto	HeatEx	Bypass	Sleep			
5	Fan speed status	MV	ERV_FanSpeed_xx_xxxxxx	Low	High	Turbo				
6	Remote controller limit status	MV	ERV_Remocon_Limit_xx_xxxxxx	Enable RC	Disable RC	Conditional RC				
7	Integrated error code of ERV unit	AI	ERV_Error_Code_xx_xxxxxx							
*8	The power value of an ERV Plus unit after the basic date	AI	ERV_Plus_Baseline_kWh_xx_xxxxxx	kWh						
*9	The number of hours usage of an ERV Plus unit after the basic date	AI	ERV_Plus_Baseline_Minute_xx_xxxxxx	Minute						
*10	Power value within period	AI	ERV_Plus_Period_kWh_xx_xxxxxx	kWh						
*11	The number of hours usage of an ERV Plus unit within period	AI	ERV_Plus_Period_Minute_xx_xxxxxx	Minute						
*12	ERV Plus operation mode status	MV	ERV_Plus_Operation_Mode_xx_xxxxxx	Auto	Cool	Heat	Off			
*13	ERV Plus operation mode limit status	MV	ERV_Plus_Mode_Limit_xx_xxxxxx	No Limit	Cool Only	Heat Only				
14	ERV Notify	NC	ERV_Notify_xx_xxxxxx	When the error occurred, send event to list of destination in the recipient_list. (Max:8)						

(\*) Mark is optionally supported.

## DVM CHILLER

Single DVM CHILLER Unit has following point list.

Instance Number	Object	Object Type	Object Name	Unit		Status value				
				Inactive	Active					
				Text-1	Text-2	Text-3	Text-4	Text-5		
1	Chilled Water Temperature	AI	MC_WaterTemp_xx_xxxxxx	°C/F						
2	Set temperature	AV	MC_WaterTemp_Set_xx_xxxxxx	°C/F						
3	Demand limit setting	AV	MC_Demand_Set_xx_xxxxxx	%						
4	The number of hours usage of an indoor unit after the basic date	AI	MC_Baseline_Minute_xx_xxxxxx	Minute						
5	The number of hours usage of an indoor unit within period	AI	MC_Period_Minute_xx_xxxxxx	Minute						
6	Power On/Off operation	BV	MC_Power_xx_xxxxxx	Off	On					
7	Water Law	BO	MC_Water_Law_xx_xxxxxx	False	True					
8	Quiet	BV	MC_Quiet_xx_xxxxxx	Off	On					
9	Forced Fan	BV	MC_Forced_Fan_xx_xxxxxx	Off	On					
10	Operation mode status	MV	MC_Operation_Mode_xx_xxxxxx	Cool	Heat	Cool Storage	Hot Water			
11	Remote controller limit status	MV	MC_Remocon_Limit_xx_xxxxxx	Enable RC	Disable RC	Conditional RC				
12	Integrated error code	AI	MC_Error_Code_xx_xxxxxx							
13	DVM CHILLER Notify	NC	MC_Notify_xx_xxxxxx	When the error occurred, send event to list of destination in the recipient_list. (Max:8)						

BACnet Device Object does not support master function of DVM CHILLER.

**Demand control setting range is as follows:**

50,55,60,65,70,75,80,85,90,95,100(%)

## BACnet Gateway setting (Continued)

### SIM/PIM

Single SIM/PIM has following point list.

Instance Number	Object	Object Type	Object Name	Status value
1	SIM/PIM error code	AI	SIM_Error_Code_xx_xx	Refer to list of error code
2	SIM/PIM Notify	NC	SIM_Notify_xx_xx	When the error occurred, send event to list of destination in the recipient_list. (Max: 8)

### Centralized Controller (OnOff Controller)

Single Centralized Controller (OnOff Controller) has following point list.

Instance Number	Object	Object Type	Object Name	Status value
1	Centralized Controller (OnOff Controller) error code	AI	Central_Error_Code_xx_xx	Refer to the list of the integrated error code
2	Centralized Controller (OnOff Controller) notify	NC	Central_Notify_xx_xx	When the error occurred, send event to list of destination in the recipient_list. (Max: 8)

### Interface Module (Outdoor Unit)

Single Interface Module (Outdoor Unit) has following point list.

Instance Number	Object	Object Type	Object Name	Unit					Status value				
				Inactive		Active							
				Text-1	Text-2	Text-3	Text-4	Text-5	Text-6	Text-7	Text-8	Text-9	Text-10
1	Outside temperature	AI	ODU_Outside_Temp_xx_xxxx	°C									
*2	Cool capacity compensation	AV	ODU_Cool_Compensation_xx_xxxx	0: 5~7°C / 1: 7~9°C / 2: 9~11°C / 3: 10~12°C / 4: 11~13°C / 5: 12~14°C / 6: 13~15°C / 14: Auto control (from ODU)									
*3	Heat capacity compensation	AV	ODU_Heat_Compensation_xx_xxxx	0: 25 kg/cm <sup>2</sup> / 1: 26 kg/cm <sup>2</sup> / 2: 27 kg/cm <sup>2</sup> / 3: 28 kg/cm <sup>2</sup> / 4: 29 kg/cm <sup>2</sup> / 5: 30 kg/cm <sup>2</sup> / 6: 31 kg/cm <sup>2</sup> / 7: 32 kg/cm <sup>2</sup> / 8: 33 kg/cm <sup>2</sup> / 14: Auto control (from ODU)									
4	Compressor status	BI	ODU_Comp_Status_xx_xxxx	False	True								
5	Interface Module (Outdoor Unit) error code	AI	Repeater_Error_Code_xx_xxxx	Refer to the list of the integrated error code									
6	Interface Module (Outdoor Unit) notify	NC	IM_Notify_xx_xxxx	When the error occurred, send event to list of destination in the recipient_list. (Max: 8)									

(\*) Mark is optionally supported.

## BACnet Gateway

BACnet Gateway has following point list.

Instance Number	Control and Monitoring	Object Type	Object Name	Status Value
1	All device OFF	BO	ALL_OFF_xx	Inactive : All devices Off
2	DMS2.5 Status	AI	DMS2.5_Status_xx	0: Normal, 8: Emergency stop, 105 : Tracking in progress, 108 : Tracking failed 109 : DMS2.5 ↔ BACnet Communication failed
3	BACnet error code	AI	BACnetApp_Error_Code_xx	BACnet error code
4	Gateway Notify	NC	GW_Notify_xx	When the error occurred, send event to list of destination in the recipient_list. (Max : 8)

## DDC

DDC has following point list.

Instance Number	Object	Object Type	Object Name	Unit		Status value				
				Inactive	Active					
				Text-1	Text-2	Text-3	Text-4	Text-5		
1	Digital Input 1	BI	DI_01_xx_xx (BACnet Gateway Reserved)	Off	On					
2	Digital Input 2	BI	DI_02_xx_xx (BACnet Gateway Reserved)	Off	On					
3	Digital Input 3	BI	DI_03_xx_xx	Off	On					
4	Digital Input 4	BI	DI_04_xx_xx	Off	On					
5	Digital Input 5	BI	DI_05_xx_xx	Off	On					
6	Digital Input 6	BI	DI_06_xx_xx	Off	On					
7	Digital Input 7	BI	DI_07_xx_xx	Off	On					
8	Digital Input 8	BI	DI_08_xx_xx	Off	On					
9	Digital Input 9	BI	DI_09_xx_xx	Off	On					
10	Digital Input 10	BI	DI_10_xx_xx	Off	On					
11	Digital Output 1	BO	DO_01_xx_xx (BACnet Gateway Reserved)	Off	On					
12	Digital Output 2	BO	DO_02_xx_xx (BACnet Gateway Reserved)	Off	On					
13	Digital Output 3	BO	DO_03_xx_xx	Off	On					
14	Digital Output 4	BO	DO_04_xx_xx	Off	On					
15	Digital Output 5	BO	DO_05_xx_xx	Off	On					
16	Digital Output 6	BO	DO_06_xx_xx	Off	On					
17	Digital Output 7	BO	DO_07_xx_xx	Off	On					
18	Digital Output 8	BO	DO_08_xx_xx	Off	On					



CAUTION

- ◆ **If communication error occurs on devices such as SIM/PIM/Centralized Controller (OnOff Controller)/Interface Module (Outdoor Unit) etc, other functions such as power distribution may also create a problem. You must have BMS system to check the errors and you must take action immediately.**



## BACnet Gateway setting (Continued)

### Other Information

#### Object setting when there is communication error

If any communication error occurs between the air conditioner devices, the property will be set as below.

1. Reliability property will be set as COMMUNICATION\_FAILURE.
2. Fault / Alarm flag of Status\_Flags property will be set as TRUE.
3. Present\_Value property is readable but the value is not guaranteed.

#### Object setting when there is general error

If any air conditioner related error occurs, the property will be set as below.

1. The Reliability property value of each object will be set as UNRELIABLE\_OTHER.
2. FAULT / Alarm flag of Status Flags property will be set as TRUE.

### Main service

#### Time setting

Time synchronization Service is a service that allows the time of BACnet Gateway to be synchronized with the time of PC.

#### COV (Change Of Value)

COV service is supported and you can set confirmed or unconfirmed COV. You can set lifetime value.



CAUTION

- ◆ **COV registration information will disappear when a BACnet gateway is switched off. The reserved value caused by the power supply problem is not guaranteed according to the BACnet regulation.**
- ◆ **When BMS system is sending control command, don't send it repeatedly in a very short time.**
- ◆ **If BMS system is sending control command repeatedly in a very short time, DMS may be stopped due to overload.**



# Viewing LonWorks Gateway's Parts

## Main Parts

### LonWorks Gateway Exterior

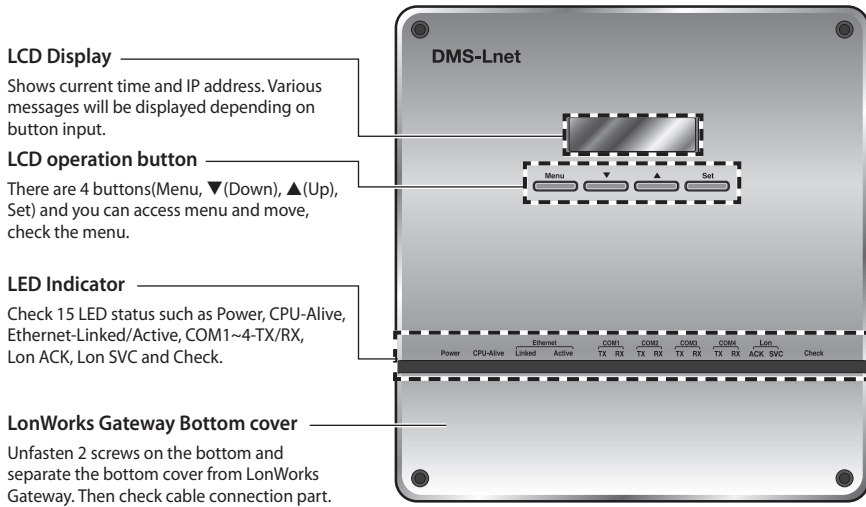

### LED Indicator

Item	Name	Status
Power	Power indicator	Turns blue when the power is supplied.
CPU Alive	CPU operation indicator	Blinks in orange with 1 second intervals during normal operation.
Ethernet-Linked	Internet connection indicator	Turns green during normal connection.
Ethernet-Active	Internet data transmission/reception indicator	Blinks in orange during normal transmission/reception.
COM1~4 - TX	Channel 1~4 OnOff controller/Outdoor unit Data transmission Indicator	Blinks in green during normal transmission.
COM1~4 - RX	Channel 1~4 OnOff controller/Outdoor unit Data reception Indicator	Blinks in green during normal reception.
Lon ACK	LonWorks data reception indicator	Blinks in green during normal reception.
Lon SVC	LonWorks device status indicator	Blinks in green during un-configured. - Needs commission by integration tool (Ex. LonMaker)
Check	Indoor/Outdoor unit/Communication check Indicator	Turns green when notice occurs.

## Viewing LonWorks Gateway's Parts (Continued)

### LonWorks Gateway Cable Connection Part

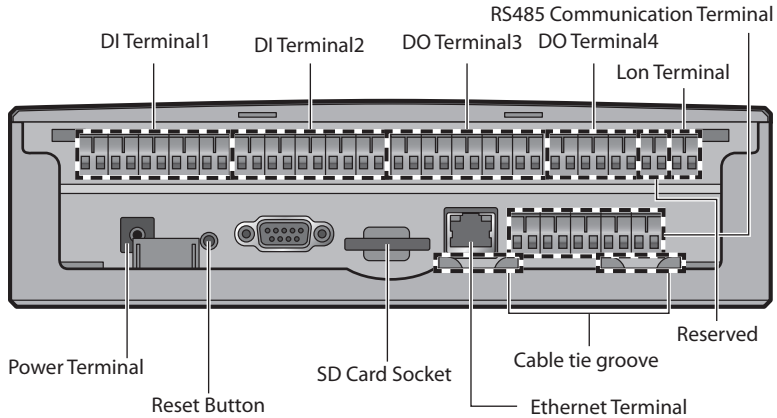

Name	Description
DI Terminal1	Digital Input connection terminal, Channel1~Channel5
DI Terminal2	Digital Input connection terminal, Channel6~Channel10
DO Terminal3	Digital Output connection terminal, Channel1~Channel5
DO Terminal4	Digital Output connection terminal, Channel6~Channel8
Lon Terminal	Terminal Block for LonWorks communication (TP/FT-10)
Reset Button	Reset LonWorks Gateway
Power Terminal	Connect LonWorks Gateway adapter
SD card socket	Sub memory (for program update and set information saving) socket
RS485 Communication Terminal	Connect for RS485 communication with devices such as OnOff controller/Interface module -COM1 ~ COM5
Ethernet Terminal	Connect LAN cable
Cable tie groove	Groove for arranging cables



## LonWorks Gateway Interior

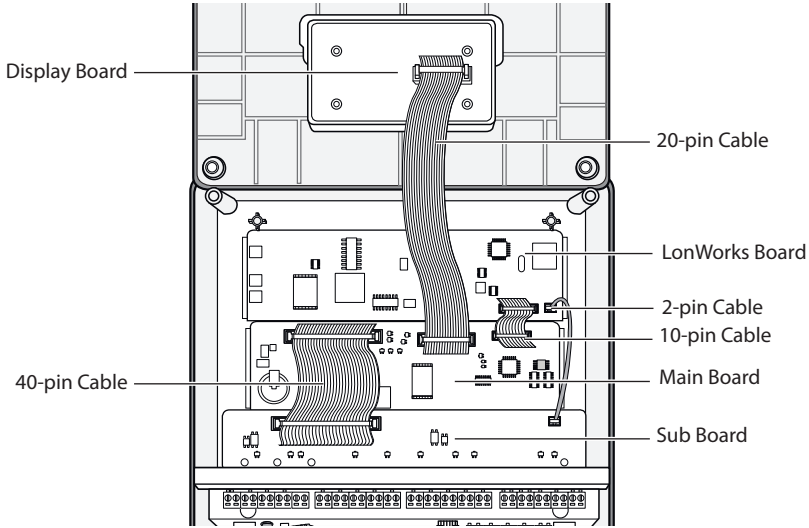

*Note* If you need external circuit configuration, consult with the manufacturer.

## Product Dimensions

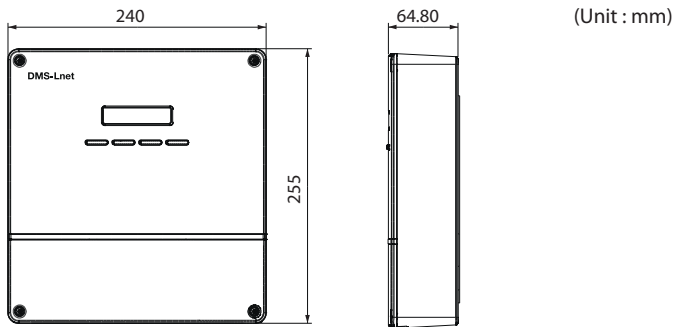

# LonWorks Gateway setting

## System Architecture

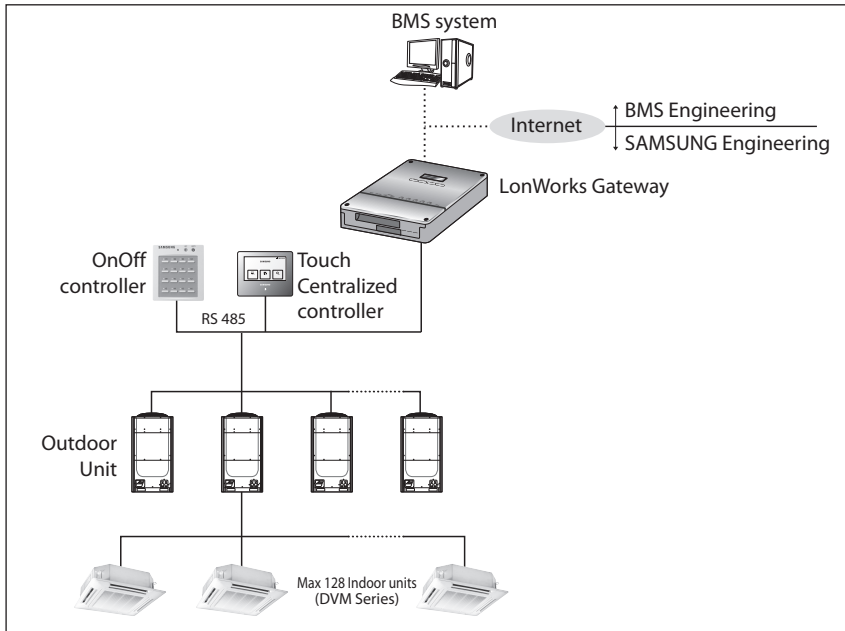

- Connecting outdoor units and LonWorks Gateway
  - You can control up to 80 outdoor units and 128 indoor units using LonWorks Gateway.
    - \* Each communication channel of LonWorks Gateway can be connected with 16 outdoor units.
    - \* The maximum number of indoor units (including ERV and MCU) that can be connected to each RS485 communication channel of LonWorks Gateway is 128.
  - The more outdoor units are connected, the longer time takes for tracking.



- ◆ **For devices that support new communication, you must set the communication mode of the channel to 'NEW' from 'System settings → Tracking' menu. Set of Indoor/outdoor units, with conventional communication type, cannot be connected to LonWorks Gateway with new communication.**
- ◆ **When setting communication channel mode as 'NEW', the address of virtual OnOff control will be assigned.**  
**Channel 0: Virtual OnOff controller 11, Channel 1: Virtual OnOff controller 12, Channel 2: Virtual OnOff controller 13, Channel 3: Virtual OnOff controller 14, Channel 4: Virtual OnOff controller 15**





## Compatible Devices

No	Devices	Model	Note
1	Indoor Unit Outdoor Unit	DVM S HR, DVM S HP, DVM ECO, DVM S WATER, DVM S cooling only outdoor units and indoor units that can be connected to these outdoor units	Check if the LonWorks Gateway supports each type of indoor units. (Check the LonWorks NV list)
2	OnOff controller/ Touch Centralized controller	MCM-A202DN, MCM-A300N	OnOff controller : Centralized controller
3	SIM	MIM-B12N	Needed for EHP power distribution
4	PIM	MIM-B16N	Needed for EHP power distribution
5*	Watt-hour Meter	RS485 comm. type	Connected with SIM Needed for power distribution ( Please consult Samsung for compatible power meters)
		Pulse type	Connected with PIM Pulse Width: 20~400(ms) Pulse: 1~10000(Wh/Pulse)

※ Products with '\*' are not Samsung products and must be purchased separately.  
(Only selected power meters may be used for protocol compatibility issues.)

※ Samsung is not responsible for BMS engineering which creates each device and objects.  
For further directions regarding on BMS engineering, consult with specialized BMS related vendor.



## LonWorks Gateway setting (Continued)

### Maximum Devices Attachable

Devices	Max.	Note
Indoor Unit	128	Tracking error occurs if exceeded The maximum number of indoor units (including ERV and MCU) that can be connected to each communication channel is 128.
OnOff controller / Touch Centralized controller	75	Must not exceed 15 units per each RS485 communication terminal
Outdoor unit	80	Must not exceed 16 units per each RS485 communication terminal
SIM/PIM	8	-
Watt-hour Meter	64	Maximum 8 units can be connected to 1 SIM/PIM.



CAUTION

- ◆ ***The sum of OnOff controller, touch centralized controller, and SIM/PIM interface module that can be connected to each communication channel should be 15 or less.***



## Installing the LonWorks Gateway

### Commission

#### ● Commission using Service Pin

To activate the Service Pin, press and hold [SET] button for more than three seconds while time is displayed in the LCD Display window of the front side of LonWorks Gateway.



Press and hold the [SET] button for more than 3 seconds.

When you press Service Pin, Neuron ID will be sent and [SVC] LED of the front panel will be lit up for a second.

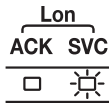

**You should correctly set up a network according to the installation and communication environment and set the data processing system in advance.**  
**This Gateway provides data for 128 indoor units. However, the connectable number of indoor units can be different according to the number of items, communication cycle or operating environment.**  
**Do not connect a device requiring urgent control in the same network.**



## LonWorks Gateway setting (Continued)

### Control and Monitoring Item

#### ● Functional classification by a device.

The functions provided can be different according to the type of the connected device.

No	NV Name	Remarks	Indoor	ERV	AHU Kit	Fresh Duct	DVM CHILLER	FCU Kit
1	nviOnOff	ON/OFF command	○	○	○	○	○	○
2	nviApplicMode	Setting operating mode	○	×	○	○	○	○
3	nviSetpoint	Setting desirable temperature	○	×	○	×	○	○
4	nviFanStatus	Setting wind speed and direction	○	○	×	×	×	○
5	nviERVMode	Setting ERV operation mode	×	○	×	×	×	×
6	nviFilterReset	Filter reset command	○	○	○	○	×	×
7	nviUserLockout	Setting the restriction of remote control use	○	○	○	○	○	○
8	nviOccOpMode	Setting cooling only mode / Setting heating only mode	○	×	○	○	×	○
9	nviCoolTempLock	Setting the low temperature limit	○	×	○	×	×	○
10	nviHeatTempLock	Setting the high temperature limit	○	×	○	×	×	○
11	nvoSpaceTemp	Display indoor temperature	○	×	○	×	○	○
12	nvoApplicMode	Display operating mode	○	×	○	○	○	○
13	nvoSetpoint	Display desire temperature	○	×	○	×	○	○
14	nvoOnOff	Display ON/OFF status	○	○	○	○	○	○
15	nvoFanStatus	Display wind speed and direction	○	○	×	×	×	○
16	nvoERVMode	Display ERV operating mode	×	○	×	×	×	×
17	nvoErrorCode	Display Error code	○	○	○	○	○	○
18	nvoDeviceAlarm	Remote control Lock, Filter Sign, Thermo ON/OFF, Error occurrence status display	○	○	○	○	○	○
19	nvoOccOpMode	Cooling only/Heating only setup status display	○	×	○	○	×	○
20	nvoCoolTempLock	Low temperature limit setting status display	○	×	○	×	×	○
21	nvoHeatTempLock	High temperature limit setting status display	○	×	○	×	×	○
22	nvoUserLockout	Display the restriction of remote control use	○	○	○	○	○	○
23	nvoEnergyComp	Display electricity usage (Time Period)	○	×	×	×	×	×
24	nvoEnergyCon	Display electricity usage (Basic date)	○	×	×	×	×	×
25	nvoRuntimep	Display used hours (Period)	○	×	○	×	○	○
26	nvoRuntime	Display used hours (Basic date)	○	×	○	×	○	○
27	nvoDevListDesc	The summary of device information (Model, Address, Operation Status)	○	○	○	○	○	○

\* With DVM CHILLER, be cautious in setting a master device.



- Although the LonWorks Gateway can connect 128 units, the actual number of available items can differ according to the number of indoor units connected. When the number of indoor units is increased, the number of controllable items will be decreased; on the other hand, as the number of indoor units decreases, the controllable items increase.

The functions provided can be different according to the type of the connected device.

Control and Monitoring Item	The maximum number of connectable indoor units.	Remarks
27 items (All)	22	In the case that 20 items can be processed per a second and data inquiry interval is 30 seconds.
20 items	30	
15 items	40	
12 items	50	
9 items	64	
6 items	100	
4 items	128	

- You can freely choose the items.
- The number of items that can be processed will be different according to the time interval that inquires about data at Human Machine Interface. LonWorks Gateway can process 20 items of Acknowledged Service Type per a second. Therefore, the amount of data that can be processed is decided according to how frequently HMI inquires about the data and the number of indoor units that can be connected is decided by this amount of data.

\* For example : In the case that HMI inquires about the 27 items of Acknowledged Service Type by an indoor unit.  
When HMI inquires for data at 30 seconds interval, 22 indoor units can be connected, at 60 seconds interval 44 indoor units can be connected, at 120 seconds interval 88 indoor units can be connected.

- The renewal cycle can be different according to the provided NV.



CAUTION

- ◆ **When BMS system is sending control command, don't send it repeatedly in a very short time.**
- ◆ **If BMS system is sending control command repeatedly in a very short time, DMS may be stopped due to overload.**



## LonWorks Gateway setting (Continued)

### Setting the LonWorks Gateway

#### LonWorks Gateway Connection and Login

- 1 Click internet explorer icon(  ) twice on your computer.
- 2 When internet explorer window appears, enter IP address (**http://192.168.0.100**) on the address bar then press [ENTER].
- 3 If it is the first time to access LonWorks Gateway, "Install Microsoft Silverlight" message will appear.
  - ◆ If the Microsoft Silverlight has already been installed, the above message will not appear.
- 4 Click [Run] button and continue installation.  
After installation, access LonWorks Gateway again.



**Silverlight operates normally with Windows 7 or later version. It may not operate normally with previous version of Windows.**

- 5 Enter ID and password when LonWorks Gateway main web page appears, Then click [LOGIN].
  - ◆ If you use accounts with general authorization level to login, you cannot use the LonWorks Gateway settings.
  - ◆ Depending on authorization level set by the administrator, access to some functions may be restricted.
  - ◆ You can change authorization level settings from **System settings** → **User authorization management**.
  - ◆ To use the LonWorks Gateway functions, you must login with the ID that is included in administration group. Factory default LonWorks Gateway ID is 'admin' and password is 'ac0530'.

#### Note

- ◆ **Only authorized users can access web page.**
- ◆ **Connection speed may slow down. Fewer than 5 concurrent users are recommended.**
- ◆ **LonWorks Gateway manager should change ID and password for security and management.**
- ◆ **Logout: If you want to logout, click [LOGOUT] on the top of the menu. LonWorks Gateway will be ended.**



- ◆ **If you use accounts with authorization level lower than management group or accounts with general authorization level, you cannot access LonWorks Gateway settings.**
- ◆ **If you cannot access LonWorks Gateway, consult the manager.**



- 6 If you login successfully, 'Control and Monitoring' screen of DMS2.5 will appear. Click [System Setting]→[LonWorks configuration] menu to switch to LonWorks Gateway.



- ◆ ***If you use accounts with authorization level lower than management group or accounts with general authorization level, LonWorks configuration will not be displayed on the menu.***
- ◆ ***If the LonWorks configuration menu does not appear, consult the manager.***

- 7 If you access LonWorks Gateway, 'Device Configuration' screen will appear initially.
  - ◆ If you click [DMS2.5 Connect] button, screen will be switched to initial screen of the DMS2.5.

## Reading EHP Watt-hour Meter

### Setting and checking watt-hour meter

- 1 Click [Setting and Checking Watt-hour meter].
  - ◆ You can change settings on watt-hour meter only when SIM/PIM interface module is connected.
- 2 Click [Edit] from the 'Setting and checking Watt-hour meter' screen.
  - ◆ CT proportion is set to '1' as factory default value.
- 3 Set the [Name] and [CT proportion] for the watt-hour meter.
  - ◆ You can use maximum 16 letters for name and only available special characters are ".", ",", "\_", "-", and "space".
  - ◆ Value for CT proportion should be integer between range of 1 ~ 5000.
- 4 Click [Save].
  - ◆ Changed settings will be saved to the LonWorks Gateway.
  - ◆ If you do not click [Save] changed setting will not be saved.
- 5 Watt-hour meter value will display the actual value of electricity on the corresponding watt-hour meter. Value will be updated automatically.



***When using CT watt-hour meter, be careful that there can be difference with actual power consumption as much as CT ratio error.***





## LonWorks Gateway setting (Continued)

### Monthly baseline setting

- 1 Click [Setting and Checking Watt-hour meter].
- 2 Click [Edit] from the 'Monthly baseline setting' screen.
  - ◆ You can make changes when list box enables.
- 3 Set the Monthly baseline setting.
  - ◆ You can select from 1~31.
  - ◆ If you select the last day of the month, it will automatically set the last day of corresponding month as baseline.  
Ex) Last day of February: 28<sup>th</sup> or 29<sup>th</sup>
  - ◆ Power consumption is calculated for a month before monthly baseline.  
Ex) Monthly baseline: 28<sup>th</sup>  
Today: 19<sup>th</sup> Nov.  
Time period for power consumption and operation: 29<sup>th</sup> Sep. ~ 28<sup>th</sup> Oct.
- 4 Click [Save].
  - ◆ Changed settings will be saved to the LonWorks Gateway.
  - ◆ If you do not click [Save] changed setting will not be saved.

### Period setting

- 1 Click [Setting and Checking Watt-hour meter].
- 2 Click [Edit] from the 'Period setting' screen.
  - ◆ You can select checkbox to set period in daily or monthly unit.
  - ◆ If you select daily period setting, text box will be enabled and you can enter the period in daily unit.
  - ◆ If you select monthly period setting, you can select the period in monthly unit.
- 3 Set the period
  - ◆ If you set period in daily unit, you can set up to maximum 90 days.
  - ◆ If you set period in monthly unit, you can set up to maximum 1 month.
- 4 Click [Save].
  - ◆ Changed setting will be saved to LonWorks Gateway.
  - ◆ If you do not click [Save], changed setting will not be saved.







## Device Configuration

### Checking and changing the Object ID

**List of equipment connected to LonWorks can be checked when the tracking is completed.**

- 1 Device Type, Address, Name and Object ID will appear.
- 2 Object IDs are assigned in order from 1 to 128 when initial tracking is executed.
- 3 If you want to change the Object ID, click [Edit] and change the Object ID of the applicable device.
  - ◆ The Object ID can not be used for more than one piece of device.
  - ◆ Object ID can be entered between 1 ~ 128.
  - ◆ Device without an Object ID can not transfer its information to LonWorks.
  - ◆ Object ID does not appear if there are more than 128 indoor units.

### Checking device information

- 1 Click one of the Addresses from 'Address' colum.
  - ◆ Detail information of the selected device will be displayed in device information.
- 2 You can check the value of each Input item.

**Note** ◆ *The value of the Input item represents the current status of the device. Therefore, value may be different from the final status controlled by LonWorks MMI.*

◆ *Some values cannot be altered depending on their connection to a type of device (Indoor unit, ERV, AHU kit, Fresh ducts).*

- 3 Check the current value of the Output.

The current value indicates the current status of indoor unit(ERV) and the value can be different due to synchronization delay with LonWorks MMI and data conversion.

▶ Refer to LonWorks Message Definition for device information display for each device.



## LonWorks Gateway setting (Continued)

### Overview for Function

◆ Followings are the NV lists of indoor unit(ERV/AHU kit/Fresh ducts) supported by LonWorks Gateway.

- 1) nvi type - Data setting is allowed
  - 2) nvo type - Data setting is not allowed
- Please refer to Message Definition for Setting value.

### 1. Indoor Unit(ERV/AHU Kit/Fresh ducts/DVM Chiller/FCU Kit) Objects

No.	NV Name	NV Type	Remarks
1	nviOnOff	SNVT_switch	ON/OFF command
2	nviApplicMode	SNVT_hvac_mode	Setting operating mode
3	nviSetpoint	SNVT_temp_p	Setting desirable temperature
4	nviFanStatus	SNVT_switch	Setting wind speed and direction
5	nviERVMode	SNVT_count	Setting ERV operation mode
6	nviFilterReset	SNVT_switch	Filter reset command
7	nviUserLockout	SNVT_switch	Setting the restriction of remote control use
8	nviOccOpMode	SNVT_switch	Setting cooling only mode / Setting heating only mode
9	nviCoolTempLock	SNVT_switch	Setting the low temperature limit
10	nviHeatTempLock	SNVT_switch	Setting the high temperature limit
11	nvoSpaceTemp	SNVT_temp_p	Display indoor temperature
12	nvoApplicMode	SNVT_hvac_mode	Display operating mode
13	nvoSetpoint	SNVT_temp_p	Display desire temperature
14	nvoOnOff	SNVT_switch	Display ON/OFF status
15	nvoFanStatus	SNVT_switch	Display wind speed and direction
16	nvoERVMode	SNVT_count	Display ERV operating mode
17	nvoErrorCode	SNVT_count	Display Error code
18	nvoDeviceAlarm	SNVT_state	Remote control Lock, Filter Sign, Thermo ON/OFF, Error occurrence status display
19	nvoOccOpMode	SNVT_switch	Cooling only/Heating only setup status display
20	nvoCoolTempLock	SNVT_switch	Low temperature limit setting status display
21	nvoHeatTempLock	SNVT_switch	High temperature limit setting status display
22	nvoUserLockout	SNVT_switch	Display the restriction of remote control use
23	nvoEnergyComp	SNVT_elec_kwh_l	Display electricity usage (Time Period)
24	nvoEnergyCon	SNVT_elec_kwh_l	Display electricity usage (Basic date)
25	nvoRuntimep	SNVT_time_hour	Display used hours (Period)
26	nvoRuntime	SNVT_time_hour	Display used hours (Basic date)
27	nvoDevListDesc	SNVT_str_asc	The summary of device information (Model, Address, Operation Status)



## 2. DMS system Objects

No.	NV Name	NV Type	Remarks
1	nviDigitalOut[6]	SNVT_switch	Control Digital output of DMS
2	nviAllOff	SNVT_hvac_emerg	Control all indoor unit / ERV OFF
3	nvoDigitalOut[6]	SNVT_switch	Display Digital output status of DMS
4	nvoDigitalIn[8]	SNVT_switch	Display Digital input status of DMS
5	nvoSystemLock	SNVT_switch	Display System Lock status of DMS
6	nvoDMSAlarm	SNVT_count	Display communication error of the sub device connected to DMS
7	nvoSystemAlarm	SNVT_count	

## 3. Configuration Properties

No.	NV Name	NV Type	Remarks
1	nciSndHrtBt	SNVT_time_sec SCPTmaxSendTime	Send Heartbeat
2	nciMinOutTm	SNVT_time_sec SCPTminSendTime	Minimum Send Time
3	nciMinDeltaTemp	SNVT_temp_p SCPTminDeltaTemp	Min. difference before update
4	nciDelayStatrup	SNVT_time_sec SCPTpwrupDelay	Delay time after a power-up



### <Unused Network Variables>

**The network variable listed below do exist within our XIF file. However, they are not explained in this document. They are exclusively intended for internal testing purpose and should not be used by a user.**

- ◆ nvIVolt
- ◆ nvoVoltFb



# LonWorks Gateway setting (Continued)

## Network Parameter Chart

### Indoor/ERV/AHU kit/Fresh ducts/DVM Chiller/FCU Kit objects

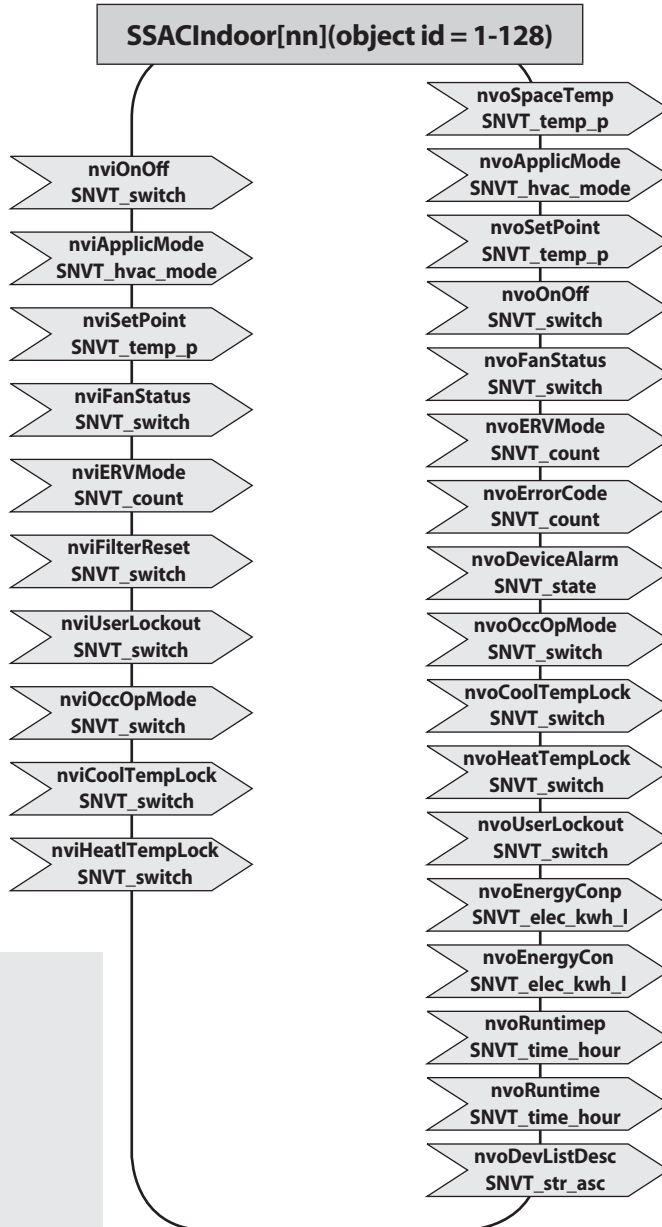



## DMS system objects

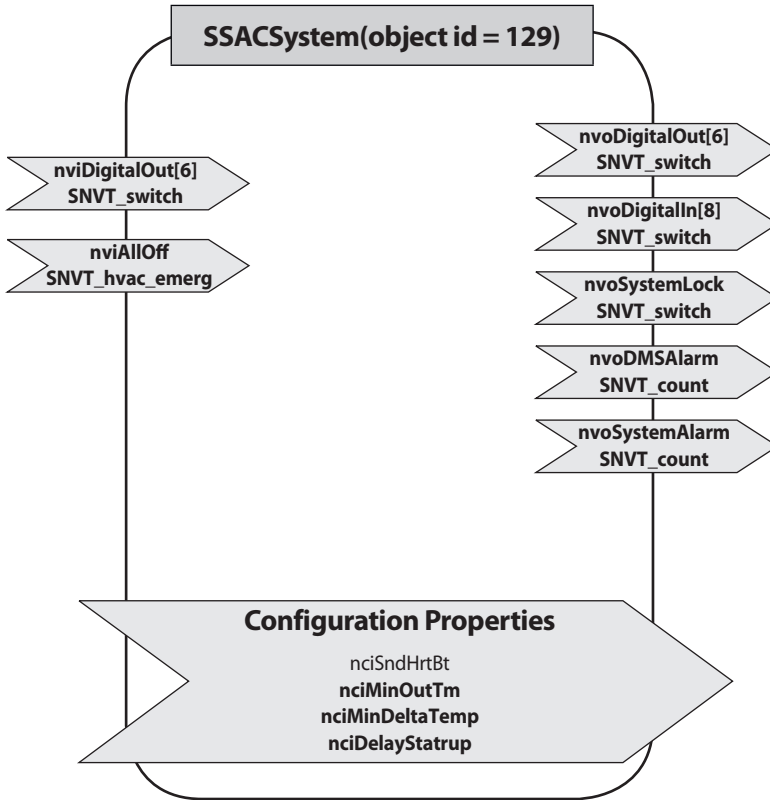

## LonWorks Gateway setting (Continued)

### Message Definition

#### Data for Indoor Device

##### ● nvoSpaceTemp(11)

Description	Indoor temperature
SNVT Type	SNVT_temp_p: Signed Long, 2 bytes
Value and operation	Range: -10.00 °C ~ 50.00 °C

##### ● nvoApplicMode(12), nviApplicMode(2)

Description	Operation Mode status
SNVT Type	SNVT_hvac_mode: Enumeration(hvac_t)
Value and operation	0: HVAC_AUTO 1: HVAC_HEAT 3: HVAC_COOL 6: HVAC_OFF 9: HVAC_FAN_ONLY 11: HVAC_ICE(Cool Storage) 13: HVAC_ECONOMY(Hot Water) 14: HVAC_DEHUMID

\* Invalid Value: Automatically set as HVAC\_AUTO

##### ● nvoSetpoint(13), nviSetpoint(3)

Description	Set Temperature
SNVT Type	SNVT_temp_p: Signed Long, 2 bytes
Value and operation	Cool: 18.0 °C ~ 30.0 °C, Heat: 16.0 °C ~ 30.0 °C

\* Invalid Value: Automatically set up as minimum or maximum value.

\* When setting temperature, only an integer value is applied. A decimal point is ignored.

\* DVM CHILLER: -10 °C ~ 55 °C

##### ● nvoOnOff(14), nviOnOff(1)

Description	Power ON/OFF status									
SNVT Type	SNVT_switch: Unsigned/signed Short									
Value and operation	<table border="1"> <thead> <tr> <th></th> <th>Value</th> <th>State</th> </tr> </thead> <tbody> <tr> <td>OFF</td> <td>0.0</td> <td>0</td> </tr> <tr> <td>ON</td> <td>100.0</td> <td>1</td> </tr> </tbody> </table>		Value	State	OFF	0.0	0	ON	100.0	1
	Value	State								
OFF	0.0	0								
ON	100.0	1								



### ● nvoFanStatus(15), nviFanStatus(4)

Description	Fan Speed and direction		
SNVT Type	SNVT_switch: Unsigned/signed Short		
Value and operation		Value	State
	Auto	0.0	-
	Low	1.0	-
	Mid	2.0	-
	High	3.0	-
	Eco	4.0	-
	Turbo	5.0	-
	Auto	Any>5.0	
	Stop	-	0
	Up-Down	-	1

- \* Supporting modes are different according to indoor units.
- Indoor unit/FCU Kit: Auto, Low, Mid, High (Turbo : Optional)
  - ERV : Mid, High, Turbo
  - AHU Kit: High
- \* When an indoor unit operation mode is Auto or Dehumid, Fan speed is controlled as 'Auto'.
- \* When an indoor unit operation mode is FAN ONLY, 'Auto' cannot be controlled by Fan speed.

### ● nvoERVMode(16), nviERVMode(5)

Description	ERV Operation Mode
SNVT Type	SNVT_count: Unsigned Long, 2 bytes
Value and operation	( 0: Auto ) 1: H/R ( 2: Air purification ) 3: Sleep 4: Normal

\* ( ) : Function that is not supported now.

### ● nvoErrorCode(17)

Description	Error Code
SNVT Type	SNVT_count: Unsigned Long, 2 bytes
Value and operation	Valid Range: 0 ~ 999 00 00 → No Error Refer to list of Error code



## LonWorks Gateway setting (Continued)

### ● nvoDeviceAlarm(18)

Description	1. Remote control restriction status 2. Filter alert status 3. Thermo On/Off status 4. Error alert Status				
SNVT Type	SNVT_state: 16 Unsigned Bitfields				
Value and operation	Byte	Bit9	Bit8	Operation	Remark
	Flags_1	0	0	Unlock	nvoUserLockout
		0	1	Level1	
		1	0	Lock	
	Byte	Bit	value	Operation	Remark
	Flags_2	2	0	No alarm	nvoFilterAlarm
			1	Alarm	
		1	0	Thermo Off	Thermo On/Off
			1	Thermo On	
		0	0	No Error	nvoErrorCode
1			Error		

### ● nvoOccOpMode(19), nviOccOpModeCmd(8)

Description	Operation Mode restriction		
SNVT Type	SNVT_switch: Unsigned/singed Short		
Value and operation		Value	State
	Unlock	0.0	0
	Cool only	1.0	1
	Heat only	2.0	1

### ● nvoCoolTempLock(20), nviCoolTempLock(9)

Description	Setting/monitoring Lower limit temperature and function toggle		
SNVT Type	SNVT_switch: Unsigned/singed Short		
Value and operation	Operation	Value	State
	Unlock	18.0 ~ 30.0	0
	Lock	18.0 ~ 30.0	1
Cool: 18.0 °C ~ 30.0 °C			





● **nvoHeatTempLock(21), nviHeatTempLock(10)**

Description	Setting/monitoring upper limit temperature and function toggle		
SNVT Type	SNVT_switch: Unsigned/signed Short		
Value and operation	Operation	Value	State
	Unlock	16.0 ~ 30.0	0
	Lock	16.0 ~ 30.0	1
Heat: 16.0 °C ~ 30.0 °C			

● **nvoEnergyComp(23)**

Description	Electric consumption value within the period
SNVT Type	SNVT_elec_kwh_l: Signed Quad, 4bytes
Value and operation	Raw range: 0 ~ 999999 Resolution: 0.1

● **nvoEnergyCon(24)**

Description	Electric consumption value after baselin
SNVT Type	SNVT_elec_kwh_l: Signed Quad, 4bytes
Value and operation	Raw range: 0 ~ 999999 Resolution: 0.1

● **nvoRunTimep(25)**

Description	Indoor unit usage within the period
SNVT Type	SNVT_time_hour: Signed Long, 2bytes
Value and operation	Raw range: 0 ~ 65535

● **nvoRunTime(26)**

Description	Indoor unit usage after baseline
SNVT Type	SNVT_time_hour: Signed Long, 2bytes
Value and operation	Raw range: 0 ~ 65535

※ Energy consumption and Runtime are the accumulated value during the user setting period.

※ The data above is for reference so you can not use them for official billing.



## LonWorks Gateway setting (Continued)

### ● nviFilterReset(6)

Description	Filter alert reset			
SNVT Type	SNVT_switch: Unsigned/singed Short			
Value and operation	Value	State	Operation	remark
	0.0	0	No Action	
	100.0	1	Filter Reset	

### ● nviUserLockout(7), nvoUserLockout(22)

Description	Remote control restriction			
SNVT Type	SNVT_switch: Unsigned/singed Short			
Value and operation	Value	State	Operation	remark
	0.0	0	Unlock	
	100.0	1	Level 1	
	100.0	2	Lock	

### ● nvoDevListDesc(27)

Description	Device Information
SNVT Type	SNVT_str_asc: Unsigned Character Array, 31bytes
Value and operation	Refer to Expansion of nvoDevListDesc



## ● Expansion of nvoDevListDesc

	description	character	value	
ascii.	[0]	Alphabet or digit		
	[1]	Alphabet or digit		
	[2]	Alphabet or digit		
	[3]	Model information	Alphabet or digit	
	[4]	Alphabet or digit		
	[5]	Alphabet or digit		
	[6]	Separator	Underbar(_)	095
	[7]	OnOff controller address	Alphabet or digit	
	[8]		Alphabet or digit	
	[9]	Separator	Period(.)	046
	[10]	Interface Module address	Alphabet or digit	
	[11]		Alphabet or digit	
	[12]	Separator	Period(.)	046
	[13]	Indoor Unit Address	Alphabet or digit	
	[14]		Alphabet or digit	
	[15]	Separator	Underbar(_)	095
	[16]	Unit type	0: indoor unit, 1: AHU, 2: ERV	
	[17]	Separator	Underbar(_)	095
	[18]	Operation mode	DMS Format 0: Auto, 1: Cool, 2: Dehumid, 3: Fan, 4: Heat, 5: Cool Storage, 6: Hot Water	
	[19]	ON/OFF	0, 1	
	[20]	Fan speed	0, 1, 2, 3, 4, 5	
	[21]	Fan Swing	0, 1	
	[22]	Error	0, 1	
	[23]	Separator	Underbar(_)	095
	[24]	setPoint temperate	Second significant digit	
	[25]		First significant digit	
	[26]		First decimal place	
	[27]	Space temperate(*)	Second significant digit	
	[28]		First significant digit	
	[29]		First decimal place	
[30]	Null padding	0	048	

(\*) If the value is a negative number, it is displayed as sign, 10-digit, single-digit.



## LonWorks Gateway setting (Continued)

### Data for DMS System

#### ● nvoDigitalOut(3), nviDigitalOut(1)

Description	Digital output status on DMS		
SNVT Type	SNVT_switch: Unsigned/singed Short		
Value and operation		Value	State
	OFF	0.0	0
	ON	100.0	1

#### ● nvoDigitalIn(4)

Description	Digital Input status on DMS		
SNVT Type	SNVT_switch: Unsigned/singed Short		
Value and operation		Value	State
	OFF	0.0	0
	ON	100.0	1

#### ● nvoSystemLock(5)

Description	System lock status of DMS(only monitoring available)		
SNVT Type	SNVT_switch: Unsigned/singed Short		
Value and operation		Value	State
	Unlock	0.0	0
	Lock	100.0	1

#### ● nvoDMSAlarm(6)

Description	DMS Alarm
SNVT Type	SNVT_count : Unsigned Long, 2 bytes
Value and operation	0 : Normal
	8 : Emergency stop
	105 : Tracing in progress
	108 : Tracking failed
	109 : Lon Module ↔ DMS2.5 communication Error
	110 : Object ID Update



### ● nvoSystemAlarm(7)

Description	SIM/PIM Communication Error Code
SNVT Type	SNVT_count: Unsigned Long, 2 bytes
Value and operation	SIM/PIM Communication Error Refer to list of Error code

### ● nviAllOff(2)

Description	All indoor units turn off
SNVT Type	Enumeration, emerg_t
Value and operation	0 : EMERG_NORMAL 4 : EMERG_SHUTDOWN

## LonWorks Gateway setting (Continued)

### Configuration Properties

#### ● Overview

This document provides information on all configuration properties defined for LonWorks Gateway device. For the sake of simplicity, although the configuration properties are defined to UFPTSSACSystem functional block, they are shared among the members of UFPTSSACIndoor functional blocks.

#### ● Configuration Properties Table

No	CPNV Name	SCPT Reference	SNVT Type	Resolution
1	nciSndHrtBt	SCPTmaxSendTime	SNVT_time_sec	0.1
2	nciMinOutTm	SCPTminSendTime	SNVT_time_sec	0.1
3	nciMinDeltaTemp	SCPTminDeltaTemp	SNVT_temp_p	0.01
4	nciDelayStartup	SCPTpwrUpDelay	SNVT_time_sec	0.1

### Details of Configuration Properties

#### ● Send Heartbeat

This configuration property defines the maximum period of time that expires before the specified network variable outputs will automatically be updated. The associated network variable will also be transmitted as a heartbeat output on a regular basis as dictated by the Maximum Send Time (nciSndHrtBt) configuration value.

##### Valid Range

The valid range is any value between 0.0 sec and 6,553.4 sec. Setting nciSndHrtBt = 0.0 (default value) disables the Send Heartbeat mechanism.

##### Recommendations

If required, especially in an event-driven update for monitoring, set a value greater than the default update rate (currently, 10s).

##### Associate Values

nvoDMSAlarm, nvoSystemAlarm.

#### ● Minimum Send Time

This configuration property defines the minimum period of time between automatic network variable output transmissions. The associated network variable will be updated no faster than the Minimum Send Time (nciMinOutTm) configuration value.

##### Valid Range

The valid range is any value between 0.0 sec and 6,553.4 sec. Setting nciMinOutTm = 0.0 (default value) disables the Minimum Send Time mechanism.



#### Recommendations

If required, set a value greater than the default update rate (currently, 10s). Any smaller value does not yield a change in the update pattern.

#### Associate Values

nvoSpaceTemp, nvoSetPoint

### ● Minimum Temperature Change

This configuration property sets the minimum temperature change required before the associated output network variable is updated. The associate network variable will not be updated unless the change is greater than or equal to the Minimum Temperature Change (nciMinDeltaTemp) configuration value.

#### Valid Range

The valid range is any value between -273.17°C and 327.66°C. Setting nciMinDeltaTemp = 0.0 (default value) disables the Minimum Temperature Change mechanism.

#### Recommendations

If required, set a value greater than 0.1 degree in Celsius. Also, consider the maximum of the typical operating range which is 50 degree in Celsius.

#### Associate Values

nvoSpaceTemp, nvoSetPoint

### ● Start-Up Delay

This configuration property controls the minimum period of time that expires before outputs are retransmitted. It also is the minimum amount of elapsed time after a power-up or re-establishment of communications before a control action takes place. This can be used to account for the settle-down time of a network.

All of the output network variable will be updated no faster than the Start-Up Delay (nciDelayStartup) configuration value. Also, the heartbeat mechanism will not be enabled unless the elapsed time passes the Start-Up Delay, if used.

#### Valid Range

The valid range is any value between 0.0 sec and 6,553.4 sec. Setting nciDelayStartup = 0.0 disables the Start-Up Delay mechanism.

#### Associate Values

All output network variables

#### Recommendations

If required, set a value greater than 1 minute which is a settle-down time of the installed device.



## Specifications

Items		Description
Exterior		
Size		240 X 255 X 64.8 mm (Width X Length X Height )
Weight		1.48 Kg
Power	Source	DC ADAPTOR
	INPUT Voltage	100-240V 50/60Hz 1.0A
	OUTPUT Voltage	12V 3A
Inter- face	RS-485	5 Channels
	Ethernet	10/100Mbps 1 Port
	SD CARD	Option (Purchase SD card separately)
	DI	12V Digital Input 10 Channels
	DO	12V Digital Output 8 Channels
	Etc.	Serial Port, Reset Button
Display		16-Character X 2-Line Character LCD
Input method		Menu/Up/Down/Set 4-Tact Button





## License

### Open Source Announcement

The software included in this product contains open source software. You may obtain the complete corresponding source code for a period of three years after the last shipment of this product by sending an email to <mailto:oss.request@samsung.com>.

It is also possible to obtain the complete corresponding source code in a physical medium such as a CD-ROM; a minimal charge will be required.

The following URL [http://opensource.samsung.com/opensource/DMS2\\_5/seq/1](http://opensource.samsung.com/opensource/DMS2_5/seq/1) leads to the download page of the source code made available and open source license information as related to this product. This offer is valid to anyone in receipt of this information.





**Memo**



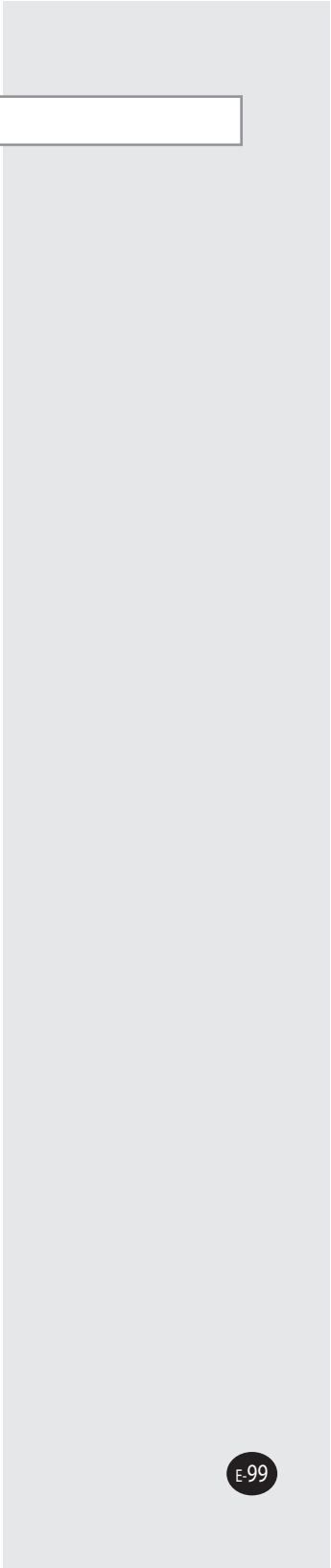

E-99





**SAMSUNG**



DB68-06095A-02

