

Air conditioner

User manual

AR**NSPX** / AR**NSWX**

- Thank you for purchasing this Samsung air conditioner.
- Before operating this unit, please read this user manual carefully and retain it for future reference.



SAMSUNG

Contents

| | |
|--|-----------|
| Safety Information | 3 |
| Safety Information | 3 |
| At a Glance | 11 |
| Remote Control Operation | 11 |
| Inserting batteries • Operation modes • Controlling temperature • Controlling fan speed • Controlling air flow direction | |
| Power Smart Features | 13 |
| Cooling Operation | 13 |
| Cool mode • 2-Step cooling function • Wind-Free Cooling function | |
| Dehumidifying Operation | 15 |
| Dry mode | |
| Air Purifying Operation | 15 |
| Ionizer function | |
| Heating Operation | 16 |
| Heat mode | |
| Quick Smart Features | 17 |
| Auto mode • Fan mode • Fast function • Comfort function • Beep sound function • Quiet function • Display lighting function • Wi-Fi function (SmartThings app) | |
| Energy-Saving Features | 19 |
| Energy-Saving Operation | 19 |
| Electricity consumption check • Usage time check • Single user function • Timed on/Timed off function • good'sleep function | |
| Cleaning and Maintenance | 22 |
| Cleaning at a Glance | 22 |
| Troubleshooting | 25 |
| Information about refrigerant | 27 |
| SmartThings app | 28 |

Safety Information





Before using your new air conditioner, please read this manual thoroughly to ensure that you know how to safely and efficiently operate the extensive features and functions of your new appliance. Because the following operating instructions cover various models, the characteristics of your air conditioner may differ slightly from those described in this manual. If you have any questions, call your nearest contact centre or find help and information online at www.samsung.com.

WARNING

Hazards or unsafe practices that may result in severe personal injury or death.

CAUTION

Hazards or unsafe practices that may result in minor personal injury or property damage.

-  Follow directions.
-  Do NOT attempt.
-  Make sure the machine is grounded to prevent electric shock.
-  Cut off the power supply.
-  Do NOT disassemble.

FOR INSTALLATION

WARNING

-  **Use a power cord with this product's power specifications or higher and use the power cord for this appliance only. In addition, do not use an extension cord.**
 - Extending the power cord may result in electric shock or fire.
 - Do not use an electric transformer. This may result in electric shock or fire.
 - If the voltage/frequency/rated current condition is different, it may cause fire.

The installation of this appliance must be performed by a qualified technician or service company.

- Failing to do so may result in electric shock, fire, explosion, problems with the product, or injury and may also void warranty on the installed product.

Install an Isolation Switch next to the Air Conditioner (but not on the panels of the Air Conditioner) and circuit breaker dedicated to the air conditioner.

- Failing to do so may result in electric shock or fire.

Fix the outdoor unit firmly so that the electric part of the outdoor unit is not exposed.

- Failing to do so may result in electric shock, fire, explosion, or problems with the product.

 **Do not install this appliance near a heater, or inflammable material. Do not install this appliance in a humid, oily or dusty location, in a location exposed to direct sunlight and water (or rain). Do not install this appliance in a location where gas may leak.**

- This may result in electric shock or fire.

Never install the outdoor unit in a location such as on a high external wall where it could fall.

- If the outdoor unit falls, it may result in injury, death or property damage.

 **This appliance must be properly grounded. Do not ground the appliance to a gas pipe, plastic water pipe, or telephone line.**

- Failing to do so may result in electric shock, fire, and explosion.
- Make sure to use a socket-outlet with ground.

CAUTION

-  Please cover the air conditioner with PE BAG after installation, and remove it when you start to run air conditioner.

Install your appliance on a level and hard floor that can support its weight.

- Failing to do so may result in abnormal vibrations, noise, or problems with the product.

Install the drain hose properly so that water drains correctly.



- Failing to do so may result in water overflowing and property damage. Avoid adding drain to waste pipes as odours may arise in the future.

When installing the outdoor unit, make sure to connect the drain hose so that draining is performed correctly.

- The water generated during heating by the outdoor unit may overflow and result in property damage.
In particular, in winter, if a block of ice falls, it may result in injury, death or property damage.

FOR POWER SUPPLY

WARNING

-  When the circuit breaker is damaged, contact your nearest service centre.
-  Do not pull or excessively bend the power line. Do not twist or tie the power line. Do not hook the power line over a metal object, place a heavy object on the power line, insert the power line between objects, or push the power line into the space behind the appliance.
 - This may result in electric shock or fire.

 **CAUTION**

 When not using the air conditioner for a long period of time or during a thunder/lightning storm, cut the power at the circuit breaker.

- Failing to do so may result in electric shock or fire.

FOR USING

 **WARNING**

 If the appliance is flooded, please contact your nearest service centre.

- Failing to do so may result in electric shock or fire.

If the appliance generates a strange noise, a burning smell or smoke, cut off the power supply immediately and contact the nearest service centre.

- Failing to do so may result in electric shock or fire.

In the event of a gas leak (such as propane gas, LP gas, etc.), ventilate immediately without touching the power line. Do not touch the appliance or power line.

- Do not use a ventilating fan.
- A spark may result in an explosion or fire.

To reinstall the air conditioner, please contact your nearest service centre.

- Failing to do so may result in problems with the product, water leakage, electric shock, or fire.
- Delivery service for the product is not provided. If you reinstall the product in another location, additional construction expenses and an installation fee will be charged.

-
- Especially, when you wish to install the product in an unusual location such as in an industrial area or near the seaside where it is exposed to salt in the air, please contact your nearest service centre.



Do not touch the circuit breaker with wet hands.

- This may result in electric shock.

Do not turn the air conditioner off with the circuit breaker while it is operating.

- Turning the air conditioner off and then on again with the circuit breaker may cause a spark and result in electric shock or fire.

After unpacking the air conditioner, keep all packaging materials well out of the reach of children, as packaging materials can be dangerous to children.

- If a child places a bag over its head, it may result in suffocation.

Do not touch the air flow blade with your hands or fingers during heating.

- This may result in electric shock or burns.

Do not insert your fingers or foreign substances into the air inlet/outlet of the air conditioner.

- Take special care that children do not injure themselves by inserting their fingers into the product.

Do not strike or pull the air conditioner with excessive force.

- This may result in fire, injury, or problems with the product.

Do not place an object near the outdoor unit that allows children to climb onto the machine.

- This may result in children seriously injuring themselves.

Do not use this air conditioner for long periods of time in badly ventilated locations or near infirm people.

- Since this may be dangerous due to a lack of oxygen, open a window at least once an hour.

-
-  **If any foreign substance such as water has entered the appliance, cut off the power supply and contact the nearest service centre.**
 - Failing to do so may result in electric shock or fire.

-  **Do not attempt to repair, disassemble, or modify the appliance yourself.**
 - Do not use any fuse (such as copper, steel wire, etc.) other than the standard fuse.
 - Failing to do so may result in electric shock, fire, problems with the product, or injury.

 **CAUTION**

-  **Do not place objects or devices under the indoor unit.**
 - Water dripping from the indoor unit may result in fire or property damage.

Check that the installation frame of the outdoor unit is not broken at least once a year.

- Failing to do so may result in injury, death or property damage.

Max current is measured according to IEC standard for safety and current is measured according to ISO standard for energy efficiency.

-  **Do not stand on top of the appliance or place objects (such as laundry, lighted candles, lighted cigarettes, dishes, chemicals, metal objects, etc.) on the appliance.**
 - This may result in electric shock, fire, problems with the product, or injury.

Do not operate the appliance with wet hands.

- This may result in electric shock.

Do not spray volatile material such as insecticide onto the surface of the appliance.

- As well as being harmful to humans, it may also result in electric shock, fire or problems with the product.

Do not drink the water from the air conditioner.

- The water may be harmful to humans.

Do not apply a strong impact to the remote control and do not disassemble the remote control.

Do not touch the pipes connected with the product.

- This may result in burns or injury.

Do not use this air conditioner to preserve precision equipment, food, animals, plants or cosmetics, or for any other unusual purposes.

- This may result in property damage.

Avoid directly exposing humans, animals or plants to the air flow from the air conditioner for long periods of time.

- This may result in harm to humans, animals or plants.

This appliance is not intended for use by persons (including children) with reduced physical, sensory or mental capabilities, or lack of experience and knowledge, without supervision or instruction concerning use of the appliance by a person responsible for their safety. Children should be supervised to ensure that they do not play with the appliance.

For use in Europe : This appliance can be used by children aged from 8 years and above and persons with reduced physical, sensory or mental capabilities or lack of experience and knowledge if they have been given supervision or instruction concerning use of the appliance in a safe way and understand the hazards involved. Children shall not play with the appliance. Cleaning and user maintenance shall not be made by children without supervision.

FOR CLEANING

WARNING

 **Do not clean the appliance by spraying water directly onto it. Do not use benzene, thinner or alcohol to clean the appliance.**

- This may result in discolouration, deformation, damage, electric shock or fire.

Before cleaning or performing maintenance, cut off the power supply and wait until the fan stops.

- Failing to do so may result in electric shock or fire.

CAUTION

 **Take care when cleaning the surface of the heat exchanger of the outdoor unit since it has sharp edges.**

- This should be done by a qualified technician. Please contact your installer or service centre.

 **Do not clean the inside of the air conditioner by yourself.**

- For cleaning inside the appliance, contact your nearest service centre.
- When cleaning the filter, refer to the descriptions in the 'Cleaning at a Glance' section.
- Failing to do so may result in damage, electric shock or fire.
- Make sure to prevent any injury from sharp edges of the surface when handling the heat exchanger.

Remote Control Operation

You can use the air conditioner easily by selecting a mode and then by controlling the temperature, fan speed, and air direction. For remote control buttons related to each operation, see the pages at the front of this manual.

Inserting batteries

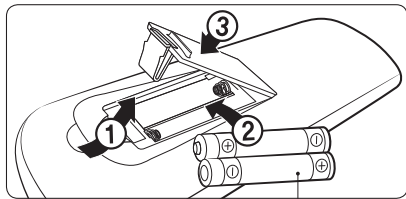

two 1.5V AAA type batteries

NOTE

- The descriptions in this manual are primarily made based on the remote control buttons.
- Although Ionizer (AR**NSWX***) and d'light Cool is displayed on the remote control display, it is not available on this model.
- For the multi system Ionizer (AR**NSWX***) , d'light Cool and Single user are displayed on the remote control display, but these functions are not available.

1 Operation modes

You can change the current mode between Auto, Cool, Dry, Fan, and Heat by pressing the **Mode** button.

1 Controlling temperature

You can control the temperature in each mode as follows:

| Mode | Temperature control |
|------------------------|---|
| Auto/ Cool/ Heat | Adjust by 1 °C between 16 °C and 30 °C. |
| Dry | Adjust by 1 °C between 18 °C and 30 °C. |
| Fan | You cannot control the temperature. |

You can switch between Celsius and Fahrenheit indications on the remote control.



▶ Press and hold for 3 or more seconds

NOTE

- The temperature indications on the indoor unit are not switched.
- This function is canceled when the remote control batteries are replaced. In this case, run this function again.











You can use the Cool, Dry, and Heat modes in the following conditions:

| Mode | Cool | Dry | Heat |
|---------------------|-------------------------------|-----------------|-----------------|
| Indoor temperature | 16 °C to 32 °C | 18 °C to 32 °C | 27 °C or less |
| Outdoor temperature | -10 °C to 46 °C | -10 °C to 46 °C | -15 °C to 24 °C |
| Indoor humidity | 80% or less relative humidity | - | - |

- If the air conditioner operates in a high humidity environment in the Cool mode for an extended period of time, condensation may occur.
- If the outdoor temperature drops to -15°C, the heating capacity may decrease to as much as 60% to 70% of the specified capacity.
- For more information about outdoor temperature in the multi system, refer to the manual for the multi system.

1 Controlling fan speed

You can select the following fan speeds in each mode:

| Mode | Available fan speeds |
|---------------|--|
| Auto/ Dry |  (Auto) |
| Cool/ Heat |  (Auto),  (Low),  (Med),  (High),  (Turbo) |
| Fan |  (Low),  (Med),  (High),  (Turbo) |

1 Controlling air flow direction

Keep the air flow in a constant direction by stopping the movements of the vertical and horizontal air flow blades.

In operation ►  or 

NOTE

- If you adjust the vertical air flow blade manually, it may not close completely when you turn off the air conditioner.
- If you adjust the horizontal air flow blade manually, it may not operate normally.
- You can control the air flow direction when the good'sleep function is running while in the Heat mode, but not while in the Cool mode.

Cooling Operation

You can use the air conditioner easily by selecting a mode and then by controlling the temperature, fan speed, and air direction.

2 Cool mode

Use the Cool mode to stay cool in hot weather.



NOTE

- For comfort, keep the temperature difference between the indoor and outdoor air within 5 °C in the Cool mode.
- After selecting the Cool mode, select a function, temperature, and fan speed that you want to apply.
 - To cool your room quickly, select a low temperature and a strong fan speed.
 - To save energy, select a high temperature and a weak fan speed.
 - As the indoor temperature approaches the set temperature, the compressor will operate at a low speed to save energy.

3 2-Step cooling function

Strong cooling operation starts to reach the desired temperature in the first step. When the room temperature nearly reaches the desired temperature, the fan speed and the air flow direction are controlled properly. When it reaches the desired temperature, the Wind-Free Cooling operation starts to provide mild breeze.

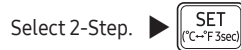

NOTE

- When the indoor temperature rises by some elements such as solar radiation, door opening and closing, or ventilation, the Wind-Free Cooling operation is cancelled and then changed to a strong cooling operation automatically.
- The air flow blade is automatically adjusted to control air flow according to the indoor temperature.

| Change of the air flow blade by temperature | |
|---|---|
| ○ | ● |

- : Open (Breeze comes out from the air flow blade)
- : Close (Breeze comes out from the Wind-Free panel)

- If you select the 2-Step cooling function while such functions as Wind-Free Cooling, Fast, Comfort, Quiet, Single user, good'sleep function are running, these functions are cancelled.



4 Wind-Free Cooling function

Use the Wind-Free Cooling function to enjoy mild cool breeze exuding from fine holes on the Wind-Free panel with the air flow blade closed, instead of getting cool wind directly. The automated control of the temperature and fan speed according to the indoor temperatures keeps your room cool and pleasant.



In the Cool/Dry/Fan mode 

NOTE

- To cancel this function, press the  button again.
- If the Wind-Free Cooling function is cancelled, the air conditioner returns to the original fan speed.
- You can adjust the set temperature during the Wind-Free Cooling function, and recommended set temperatures are 24 to 26 °C. However, you cannot change the set temperature in the Fan mode.
- You can use the Wind-Free Cooling function when the Cool, Dry, or Fan mode is running.
- If the room temperature goes high because of rise of external temperature, heat from cooking, or other reason, operate the Wind-Free Cooling function after operating in the Cool mode.
- If you select the Wind-Free Cooling function in the Fan mode, the compressor stops working so that cool air does not come out. However, mild breeze comes out and starts to clean the air in the room.
- When indoor humidity becomes higher relatively while the Wind-Free Cooling function is running, the air flow blade is open to control the air flow smoothly in the room. When the indoor temperature and humidity are changed, the air flow blade is closed and the Wind-Free Cooling function starts to operate.

| Change of the air flow blade by temperature and humidity | |
|---|---|
|  |  |

- : Open (Breeze comes out from the air flow blade)
- : Close (Breeze comes out from the Wind-Free panel)

- If the air conditioner is installed over the bed, adjust the set temperature from 25 to 27 °C to use the Wind-Free Cooling function while sleeping or using the good'sleep function.
- If you select the Wind-Free Cooling function while such functions as 2-step cooling, Fast, Comfort, Single user, Quiet or air flow direction   function are running, these functions are cancelled.

Dehumidifying Operation

The dehumidifying function of the Samsung air conditioner keeps an enclosed space dry and comfortable.

5 Dry mode

Use the Dry mode in rainy or humid weather.



NOTE

- The lower the set temperature is, the greater the dehumidifying capacity is. When the current humidity seems to be high, adjust the set temperature to a low temperature.
- You cannot use the Dry mode for heating. The Dry mode is designed to produce a cooling side-effect.

Air Purifying Operation

The air purification function of the Samsung air conditioner keeps the air in an enclosed space purified.

6 Ionizer function

Only for AR**NSPX*** model

Use the Ionizer function to purify your room with negative ions produced by the air conditioner. This function is available in the Auto, Cool, Dry, Fan, and Heat modes.

In the Auto, Cool, Dry, Fan, or Heat mode 

NOTE

- You can adjust the set temperature, except for in the Fan mode.
- When the Ionizer function is additionally selected while a specific mode is running, there is little difference in electricity consumption and operating noise.

Heating Operation

The heating functions of the Samsung air conditioner keep an enclosed space warm and comfortable.

7 Heat mode

Use the Heat mode to stay warm.



NOTE

- While the air conditioner warms up, the fan may not operate for about 3 to 5 minutes at the beginning to prevent cold blasts.
- If the air conditioner heats insufficiently, use an additional heating appliance in combination with the air conditioner.
- When the outdoor temperature is low and the humidity is high in Heat mode, frost may develop on the outdoor heat exchanger. This may also decrease the heating efficiency. If this occurs, the air conditioner runs the defrost function for 5 to 12 minutes to remove frost from the outdoor heat exchanger.

- When the defrost function is running, steam is produced on the outdoor unit. The air conditioner moves the vertical air flow blade to the lowest position, as shown in the below figure, to prevent cold air from coming out from the indoor unit.

- A. The position of the vertical air flow blade when the defrost function is running (The blade looks almost closed.)
- B. The position range of the vertical air flow blade when the Heat mode is running.

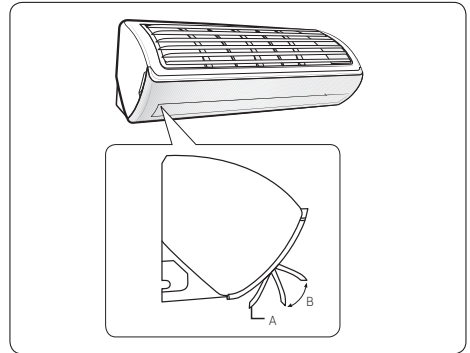

- When the defrost function is running, no air comes out from the indoor unit in order to prevent cold air from coming out. When the defrost function is finished, warm air comes out after a while.
- The cycle of the defrost function may be shortened depending on the amount of frost on the outdoor unit.
- The cycle of the defrost function may be shortened depending on the humidity from rain and snow, too.
- When the defrost function is running, you cannot select other functions with the remote control. Select them after the defrost function is finished.

Quick Smart Features

There is a variety of extra functionality provided by the Samsung air conditioner.

8 Auto mode

Use the Auto mode when you want the air conditioner to automatically control the operation. The air conditioner will provide the most comfortable atmosphere that it can.



NOTE

- When the indoor temperature seems to be higher or lower than the set point, the air conditioner automatically produces either cool air to cool down the indoor temperature or warm air to warm up the indoor temperature.

9 Fan mode

Use the Fan mode to run the air conditioner like a common fan. The air conditioner provides a natural breeze.



NOTE

- If the air conditioner will not be used for an extended period of time, dry the air conditioner by running it in the Fan mode for 3 or 4 hours.
- The outdoor unit is designed not to operate in the Fan mode to prevent cold air from entering through the unit. This is a normal operation and not a fault with the air conditioner.

10 Fast function

Use the Fast function to quickly cool or heat your room. This function is the most powerful cooling and heating function provided by the air conditioner. You can select this function both in the Cool and Heat modes.

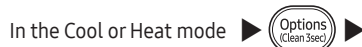

NOTE

- You can change the air flow direction.
- You cannot change the set temperature and the fan speed.
- When you select the Fast function in the Heat mode, you may not be able to increase the fan speed in order to prevent cool air from blowing.
- If you select the Fast function while such functions as 2-Step cooling, Wind-Free Cooling, Comfort, Single user, Quiet, or good'sleep are running, these functions are cancelled.

11 Comfort function

Use the Comfort function when you feel the current cooling or heating effect is too strong. The air conditioner provides a mild cooling or heating. You can select this function both in the Cool and Heat modes.

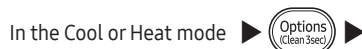

NOTE

- You can change the set temperature and the air flow direction.
- You cannot change the fan speed.
- If you feel cooling or heating effect in the Comfort function is weak, cancel the Comfort function.
- If you select the Comfort function while such functions as 2-Step cooling, Wind-Free Cooling, Fast, Single user, Quiet, or good'sleep are running, these functions are cancelled.

12 Beep sound function

Use the Beep sound function to turn on or off the beep sound that plays when you press a button on the remote control.

**13 Quiet function**

Use the Quiet function to reduce operating noise. You can select this function both in the Cool and Heat modes.

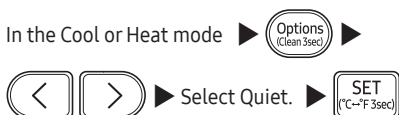
**NOTE**

- You can change the set temperature and the air flow direction.
- You cannot change the fan speed.
- If you select the Quiet function while such functions as 2-Step cooling, Wind-Free Cooling, Fast, Comfort, Single user, or good'sleep are running, these functions are cancelled.

14 Display lighting function

Use the Display lighting function to turn on or off the lighting of the indoor unit display.

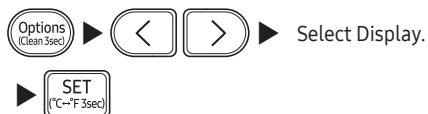
**NOTE**

- The Display lighting function does not operate when the indoor unit is turned off.
- The Timer (⌚) indicator does not disappear, even if you turn off the Display lighting function.
- If you change the current mode or function when the Display lighting function is on, the Display lighting function turns off.

15 Wi-Fi function (SmartThings app)

When you turn on the Wi-Fi function, the Transmit (📶) indicator blinks and **RF** appears on the remote control display for a few seconds. Then both of them disappear.

In operation ▶ Timer (⌚) ▶ Hold down 4 seconds.

NOTE

- For further information, refer to SmartThings app chapter in this manual.
- SmartThings app may not be available on some models.

Energy-Saving Operation

The smart energy-saving functions of the Samsung air conditioner reduce electricity consumption.

16 Electricity consumption check

For the multi system, this function is not supported.

Use the Usage function to check the amount of electricity consumed by using the air conditioner. The amount consumed is displayed on the indoor unit display for a few seconds, and the set indoor temperature appears.

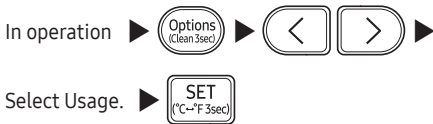

The value range displayed is between 0.1 kWh and 99 kWh. Electricity consumption is calculated from the moment the air conditioner turns on. The value is reset when the air conditioner turns off.

NOTE

- The usage shown on the indoor unit display may slightly differ from the amount of electricity actually consumed.
- You can view electricity consumption only when the air conditioner is operating.

17 Usage time check

For the single system, this function is not supported.

Use the Usage time function to check the operation duration from the moment when the air conditioner is turned on to the moment when the Usage time function is selected. The usage time is displayed on the indoor unit display for a few seconds, and the set indoor temperature appears.

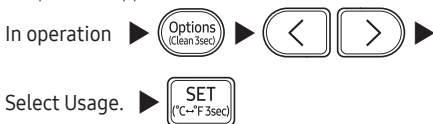

The usage time is displayed in units of hour. For example, 0.1 is equivalent to 6 minutes; 2.5, 2 hours and 30 minutes; 3.7, 3 hours and 42 minutes. The value range displayed is between 0.0 and 99. The value is reset when the air conditioner turns off.



AR**NSPX***



AR**NSWX***

NOTE

- The usage time shown on the indoor unit display may a little differ from the actual operation time of the air conditioner.
- You can view the usage time only when the air conditioner is operating.

18 Single user function

For the multi system, this function is not supported.

Use the Single user function to reduce electricity consumption while staying cool or warm. You can select this function in the Cool and Heat modes.

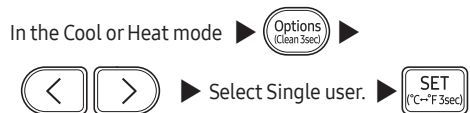

For AR**NSWX*** model

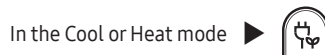

NOTE

- When the Single user function starts, the pattern appears on the remote control for a few seconds, and vertical air swing begins automatically.
- After selecting the Single user function, you can change the set temperature (24 °C to 30 °C in the Cool mode, 16 °C to 30 °C in the Heat mode), fan speed, and air flow direction.
- When the Single user function is turned on in the Cool mode while the set temperature is set to lower than 24 °C, the set temperature is automatically raised to 24 °C. But if the set temperature is set to between 25 °C and 30 °C, it remains the same.
- Even after you turn off the Single user function, air swing continues until you turn it off with the air swing button.
- If you select the Single user while such function as 2-Step cooling, Wind-Free Cooling, Fast, Comfort, Quiet, or good'sleep are running, these modes are cancelled.

- After starting the Timed on function, you can change the mode and the set temperature. You cannot change the set temperature while the Fan mode is running.
- You cannot set the same time for both of the Timed on and Timed off functions.

| Combining Timed on and Timed off | |
|----------------------------------|---|
| When the air conditioner is off | Example) Timed on: 3 hours, Timed off: 5 hours The air conditioner turns on after 3 hours from the moment you start Timed on/off, remains on for 2 hours, then turns off automatically. |
| When the air conditioner is on | Example) Timed on: 3 hours, Timed off: 1 hour The air conditioner turns off after 1 hour from the moment you start Timed on/off, then turns on after 2 hours from the moment it is turned off. |

19 Timed on/Timed off function

Use the Timed on/Timed off to turn on or off the air conditioner after the time that you set.

(Select On or Off among On, Off, and) ▶

(Set the on/off time.) ▶

- Press the (Timer) button to change the current function between **On**, **Off**, and (good'sleep). (good'sleep) is displayed in the Cool and Heat mode only.

NOTE

- Once you start the Timed on/off function, the Timer () indicator is displayed on the indoor unit display.
- You can set a time between 0.5 and 24 hours. Set the time interval to 0.0 to cancel the Timed on/off function.

20 good'sleep function

Use the good'sleep function to get a good sleep at night and to save energy. You can select this function both in the Cool and Heat modes.

In the Cool or Heat mode ▶ (Select among On, Off, and) ▶

(Set the operation time.) ▶

Press the (Timer) button to change the current function between **On**, **Off**, and (good'sleep).

NOTE

- Once you start the good'sleep function, the Timer () indicator appears on the indoor unit display.
- You can adjust the set temperature by 1 °C between 16 °C and 30 °C.

- The recommended and optimal set temperatures in the good'sleep function are as follows:

| Mode | Recommended set temperature | Optimal set temperature |
|------|-----------------------------|-------------------------|
| Cool | 25 °C to 27 °C | 26 °C |
| Heat | 21 °C to 23 °C | 22 °C |

- The good'sleep function can be operated with the Wind-Free Cooling function. Select the Wind-Free Cooling function to get mild breeze. To select or cancel the Wind-Free Cooling function, press the  button.
- You can set the operation time to between 0.5 and 12 hours. Set the operation time to 0.0 to cancel the good'sleep function.
- The default operation time for the good'sleep function in the Cool mode is 8 hours. If the operation time is set to over 5 hours, the Wake up function begins 1 hour before the set time. The air conditioner stops automatically when the operation time expires.
- When the Timed on, Timed off, and good'sleep functions are overlapped, the air conditioner operates its timer with only the function that you have started most recently.
- If you select the good'sleep function while such functions as 2-step cooling, Fast, Comfort, Quiet, Single user function are running, these functions are cancelled.

Cleaning at a Glance

Running Auto clean

1. Method 1 : Press  button for 3 seconds or more.

Method 2:  →  →  → Select [Clean] → 

- The indoor unit display shows



AR**NSPX***



AR**NSWX***

2. The Auto clean function is activated.

3. When operation is off, auto clean starts for 10 min.

- The indoor unit display shows cleaning progress (from 1 to 99%).

4. The air conditioner is automatically turned off.

To deactivate the Auto clean function

Method 1: Press the  button for 3 seconds or more.

Method 2:  →  →  → Select [Clean] → 

To cancel the Auto clean operation

Press the  button twice within 20 seconds.



NOTE

- When the air conditioner is off, the Auto clean function starts immediately; when the air conditioner is in operation, the Auto clean function starts as soon as the air conditioner stops running.
- If you starts a function while in the Auto clean operation, the Auto clean function is reset, and then is restarted when that function is stopped or completed.

Cleaning the indoor unit exterior and outdoor unit heat exchanger

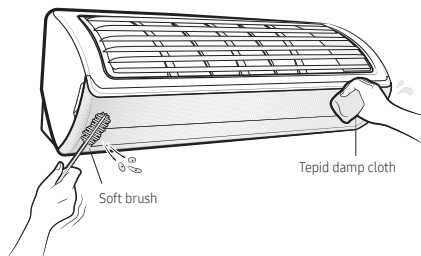

Before cleaning, be sure to turn off the equipment and disconnect the power plug.

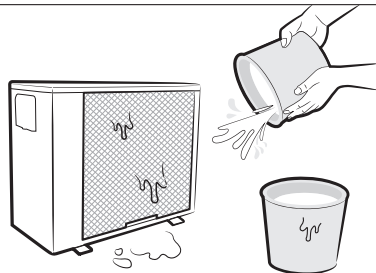

Spray water to clean the dust.

⚠ CAUTION

- Do not clean the display by using alkaline detergent.
- Do not use sulphuric acid, hydrochloric acid, or organic solvents (such as thinner, kerosene, and acetone) to clean the surfaces. Do not put any stickers on it as this can damage the surface of the air conditioner.
- When you clean and inspect the heat exchanger on the outdoor unit, contact the local service centre for help.

Cleaning the filter

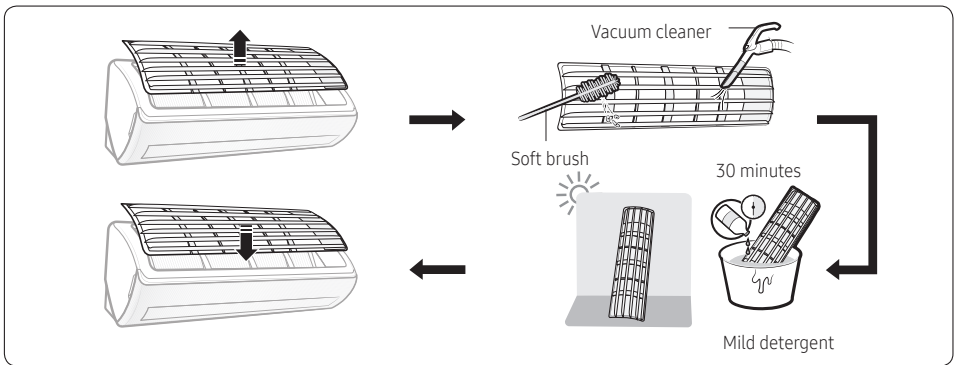

⚠ CAUTION

- Do not scrub the air filter with a brush or other cleaning utensil. This may damage the filter.
- Do not expose the air filter to direct sunlight when drying it.

📖 NOTE

- Clean the air filter every 2 weeks. Cleaning term may vary depending on the usage and environmental conditions.
- If the air filter dries in a humid area, it may produce offensive odours. Clean it again and dry it in a well-ventilated area.

Resetting the filter-cleaning reminder

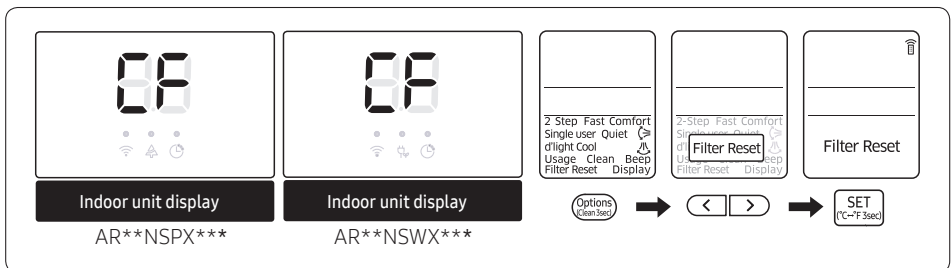

Tip on cleaning the Wind-Free panel



Gently push the air flow blade with your finger until it is open.

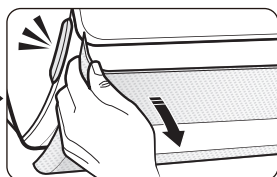

Hold and pull both sides of the Wind-Free panel until it is detached from the air conditioner.

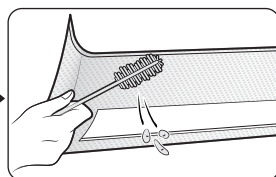

Remove the dust with a soft brush or vacuum cleaner.

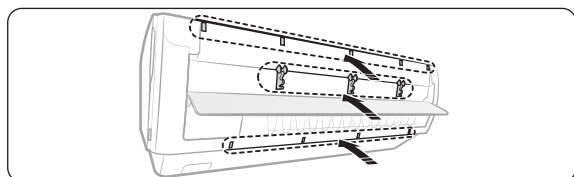

Push the 5 latches on top, 3 on center, and 4 on bottom with your hand.

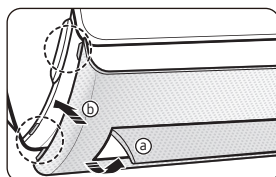

Gently push the air flow blade with your finger to open (a), then align and engage the protrusions (top left, top right, bottom left, bottom right) on the Wind-Free panel into the groves on the front panel (b).

CAUTION

- If you assemble the air flow blade without pushing it by hand, it may be obstructed by the Wind-Free panel and may not open when the air conditioner operates.

Troubleshooting

If the air conditioner operates abnormally, refer to the following chart to save time and unnecessary expenses.

| Problem | Solution |
|--|--|
| The air conditioner does not work at all. | <ul style="list-style-type: none"> • Check the power status, then operate the air conditioner again. • Switch on the circuit breaker, plug in the power cord, then operate the air conditioner again. • Make sure that the isolator is turned on. • Check whether the Timed off function is running. Operate the air conditioner again by pressing the Power button. |
| I cannot change the temperature. | <ul style="list-style-type: none"> • Check whether the Fan or Fast mode is running. In these modes, the air conditioner controls the set temperature automatically, and you cannot change the set temperature. |
| Cool or warm air does not come out of the air conditioner. | <ul style="list-style-type: none"> • Check whether the set temperature is higher in the Cool mode or lower in the Heat mode than the current temperature. Press the Temperature button on the remote control to change the set temperature. • Check whether the air filter is blocked with dirt. If the air filter is blocked, the cooling and heating performance may decrease. Remove dirt regularly. • Check whether the outdoor unit is covered or installed near obstacles. Remove the coverings and obstacles. • Check whether the air conditioner is running the defrost function. When ice forms in winter or the outdoor temperature is too low, the air conditioner runs the defrost function automatically. While this function is running, the indoor fan stops and warm air does not come out. • Check whether doors or windows are open. This may cause poor cooling or heating performance. Close the doors and windows. • Check whether the air conditioner is turned on immediately after the cooling or heating operation stops. In this case, only the fan runs to protect the outdoor unit compressor. • Check whether the pipe length is too long. When the pipe length exceeds the maximum pipe length, the cooling and heating performance may decrease. |
| I cannot change the air flow direction. | <ul style="list-style-type: none"> • Check whether the good'sleep function is running. While this function is running, you cannot control the air flow direction. (But you can control the air flow direction if this function is running in the Heat mode.) |
| I cannot change the fan speed. | <ul style="list-style-type: none"> • When the Auto, Dry, or Fast mode is running or the good'sleep function is running in the Cool mode, the air conditioner controls the fan speed automatically and you cannot change the fan speed. |

| Problem | Solution |
|--|--|
| The remote control does not work. | <ul style="list-style-type: none"> • Replace the batteries in the remote control with new ones. • Make sure that nothing is blocking the remote control sensor. • Check whether there are strong lighting apparatus near the air conditioner. Strong light which comes from fluorescent bulbs or neon signs may interrupt the electric waves. |
| The Timed on/off function does not work. | <ul style="list-style-type: none"> • Check whether you pressed the SET button on the remote control after setting the time. |
| The indicator blinks continuously. | <ul style="list-style-type: none"> • Press the Power button to turn off the air conditioner or disconnect the power plug. If the indicator is still blinking, contact the service centre. |
| Odours permeate in the room during operation. | <ul style="list-style-type: none"> • Check whether the air conditioner is running in a smoky area. Ventilate the room or operate the air conditioner in the Fan mode for 3 to 4 hours. (There are no components used in the air conditioner that emit a strong odour.) • Check whether the drains are clean. Clean them regularly. |
| An error is indicated. | <ul style="list-style-type: none"> • If the indoor unit indicator blinks, contact the nearest service centre. Be sure to pass the error code to the service centre. |
| Noise is generated. | <ul style="list-style-type: none"> • When refrigerant flow changes, noise may be generated, depending on the status of the air conditioner. This is a normal operation. |
| Smoke is generated from the outdoor unit. | <ul style="list-style-type: none"> • It may not be a fire but it can be a steam generated from the outdoor heat exchanger while the defrost function is running in the Heat mode in winter. |
| Water drops from the pipe connections of the outdoor unit. | <ul style="list-style-type: none"> • Condensation may develop when the ambient temperature changes excessively. This is a normal operation. |

To perform its antimicrobial function this product has been treated with the biocide substance Silver zinc zeolite.

Information about refrigerant

Important information: regulation regarding the refrigerant used.

This product contains fluorinated greenhouse gases. Do not vent gases into the atmosphere.

CAUTION

If the system contains 5 tCO₂e or more of fluorinated greenhouse gases, it must be checked for leakage at least once every 12 months, according to regulation No. 517/2014. This activity must be covered by qualified personnel only. In the case of the situation above, the installer (or authorized person with responsibility for final check) must provide a maintenance book, with all the information recorded, according to REGULATION (EU) No. 517/2014 OF THE EUROPEAN PARLIAMENT AND OF THE COUNCIL of 16 April 2014 on fluorinated greenhouse gases.

| Refrigerant type | GWP value |
|------------------|-----------|
| R-410A | 2088 |

- GWP: Global Warming Potential
- Calculating tCO₂e: kg x GWP/1000

SmartThings app

To use the SmartThings app, connect the product to the network in the sequence described below. The images shown may differ depending on your smartphone model, OS version and manufacturer. You need to set up the Wi-Fi access point only when connecting the product to a Wi-Fi network. Once the product is connected, you can use the SmartThings app via Wi-Fi, 3G, LTE or more wireless networks.

1 Checking the power connections

Check if the power is connected to the product and the access point.

2 Setting up and connecting to a Wi-Fi access point using your smartphone

1 To connect the product to a Wi-Fi network, turn on Wi-Fi at "Settings > Wi-Fi", and then select the access point to connect to

- Only alphanumeric characters are supported for wireless access point names (SSIDs). If an SSID has a special character, rename it before connecting to it.
- This product supports only Wi-Fi 2.4 GHz.

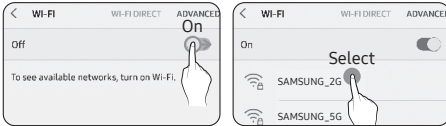

2 Turning off "SMART NETWORK SWITCH" at "Settings > Wi-Fi" on your Smartphone

- If "SMART NETWORK SWITCH" or "Adaptive Wi-Fi" is turned on, you cannot connect to the network. Be sure to turn off these functions before connecting to the network.

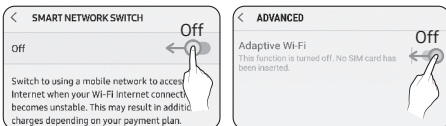

NOTE

- The setup may differ depending on your smartphone model, OS version and manufacturer.

3 Checking the Internet connectivity

- After connecting to Wi-Fi, check that your smartphone is connected to the Internet.

NOTE

- A firewall may prevent your smartphone from connecting to the Internet. In this case, contact your Internet service provider for troubleshooting.

3 Downloading the SmartThings app and registering your Samsung account

1 Downloading the SmartThings app

- Search for "SmartThings" on Play Store or App Store, and download the SmartThings app to your smartphone.
- If the SmartThings app is already installed on your smartphone, update it to the latest version.

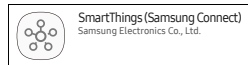

NOTE

- For the tablets that are not supported by the SmartThings app and the smart phones that has an OS version earlier than the recommended versions, the SmartThings app may not be found.
 - Android OS 6.0 or later (with at least 2 GB RAM) is recommended.
 - Supported screen resolutions: 1280 x 720 (HD), 1920 x 1080 (FHD), 2560 x 1440 (WQHD)

- The SmartThings app is not compatible with some Apple devices including iPad and some smartphones.
 - iPhone 6 or later with iOS 10.0 or later is supported.
 - Supported screen resolutions: 1334x750, 1920x1080
- The SmartThings app may change without prior notice to improve product usability and performance.

2 Registering your Samsung account

- A Samsung account is required to use the SmartThings app. To create your Samsung account and log in to your account, follow the instructions displayed on the SmartThings app. You do not need to install an additional app.

NOTE

- If you already have a Samsung account, log in to the account. When your smartphone is a Samsung device and you have a Samsung account, your smartphone is automatically logged in to your account.

4 Connecting the SmartThings app to your product

1 Selecting the product to connect to

- 1) Start the SmartThings app about one minute after turning on the product to connect to.
- 2) After the SmartThings app is started, select "ADD NOW" when a pop-up window saying that a product to connect to is found appears.



- 3) If the pop-up window does not appear, select "ADD DEVICE", and then select the product you want to connect to from the list of available devices.

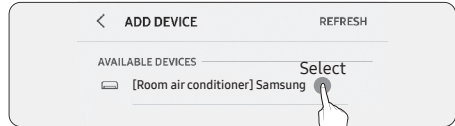

- 4) If the product you want to connect to is not listed in the list of available devices, select "Air conditioner > Room air conditioner" at "ADD DEVICE MANUALLY".

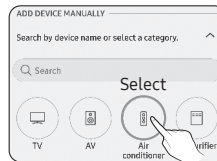

2 Connecting the SmartThings app to your product

- Follow the instructions displayed on the SmartThings app to connect to your product.
- For information on how to use the SmartThings app, select the How To menu on the app.

NOTE

- If a pop-up window saying that the Internet connection is unsure appears during connecting to your product, do not select it and continue to proceed with the connection.
- If a pop-up window saying that the device is already registered appears during connecting to your product, get permission using "REQUEST PERMISSION" from a user already connected to the product, or create a new account using "REGISTER MY ACCOUNT" to independently connect to the product.

- If a Samsung account-related country error occurs during connecting to your product, log out of your current Samsung account, log in to your previous Samsung account, and then delete all devices that have been connected previously. Then, log in to your current Samsung account again, and then configure the settings.
- If a failure message appears while adding a device, see "Setting up and connecting to a Wi-Fi access point using your smartphone" on page 28. The connection may fail temporarily due to an installation location problem of the access point or other problems.
- If a message appears on the SmartThings app, follow its instructions.



NOTE

- For the authentication/encryption protocols for wireless/wired access points, WPA/TKIP and WPA2/AES are recommended. New Wi-Fi authentication specifications and non-standard Wi-Fi authentication protocols are not supported.
- The product supports the IEEE802.11 b/g/n (2.4 GHz), Soft-AP communication protocol. (Samsung recommends IEEE802.11n.)
- If your Internet service provider permanently have registered the MAC address (a unique identification number) of your PC or modem, you may not be able to connect your product to the Internet. Contact your Internet service provider and ask how to connect devices other than your PC (such as an air conditioner and an air purifier) to the Internet.



WARNING

- RF exposure warning statement – for keeping 20cm distance when installing this module.
- Warning that this module should not be installed and operating simultaneously with other radio without additional evaluation or FCC filing.
- Instruction for host system labeling, the host system should have proper label showing that it "Contains FCC ID : A3LSWL-B70F"

- Your device uses non-harmonised frequency and is intended for use in all European countries. The WLAN can be operated in the EU without restriction indoors, but cannot be operated outdoors in France.

Specifications

| Wi-Fi | |
|-----------------|------------------------|
| Frequency Range | Transmitter Power(Max) |
| 2412 - 2472 MHz | 20 dBm |

Open Source Announcement

The software included in this product contains open source software. You may obtain the complete corresponding source code for a period of three years after the last shipment of this product by sending an email to mailto:oss.request@samsung.com.

It is also possible to obtain the complete corresponding source code in a physical medium such as a CD-ROM; a minimal charge will be required.

The following URL http://opensource.samsung.com/opensource/SMART_AT_051/seq/0 leads to the download page of the source code made available and open source license information as related to this product. This offer is valid to anyone in receipt of this information.



Controlling the air conditioner with SmartThings app

You can skillfully control the air conditioner.

| Category | Function | Description |
|--------------|--|---|
| Monitoring | Set temperature | Displays the set temperature. |
| | Current temperature | Displays the current temperature. |
| Control | Power | Turns on or off the air conditioner. |
| | Mode | Selects the desired operation. |
| | Temperature | Adjusts the indoor set temperature. |
| | Fan Speed | Sets the fan speed of operation mode. |
| | Wind direction | Sets the fan directions of operation mode. |
| | Wind Free | Turns on or off the Wind Free function. |
| | Purity | Turns on or off the Purity function. |
| | Schedule | Sets On or Off timer for each function. <ul style="list-style-type: none"> • The maximum number of schedule for On/Off timer function is 10. • Set time for On timer and Off timer should be different. • Once the On/Off timer is set, the setting remains even if you unplug the air conditioner and plug in it again. |
| | Options | Selects an option function of operation mode. <ul style="list-style-type: none"> • The available options might be different depending on the air conditioner model. • The fan speed and fan direction are set automatically according to the selected options. • For detailed information on the options of the product, refer to the user manual. |
| | Settings | Sets additional functions. <ul style="list-style-type: none"> • Press the Settings button on the control screen to check or set detailed information of air conditioner. • The functions of Clean, Filter, Beep, My Wind, and Energy Monitor can be set. <ul style="list-style-type: none"> - When the Beep function is off, the beep sound from the device will be mute. |
| About Device | Selects a service function. <ul style="list-style-type: none"> • On About Device screen, you can use Version Info, Help Desk, Tutorial, and Self Check menus. | |

Reference

| | |
|----------|---|
| English | Hereby, Samsung Electronics, declares that the radio equipment type appliance is in compliance with Directive 2014/53/EU. The full text of the EU declaration of conformity is available at the following internet address: The official Declaration of conformity may be found at http://www.samsung.com , go to Support > Search Product Support and enter the model name. |
| Czech | Společnost Samsung Electronics tímto prohlašuje, že uvedené rádiové zařízení vyhovuje požadavkům směrnice 2014/53/EU. Úplné znění EU Prohlášení o shodě je k dispozici na následující internetové adrese: Oficiální prohlášení o shodě naleznete na webu http://www.samsung.com , kde klepnete na odkaz Podpora a do pole Hledat Podporu zadejte název modelu. |
| Danish | Samsung Electronics erklærer hermed, at denne type radioudstørsapparat opfylder kravene og bestemmelserne i direktiv 2014/53/EU. Hele teksten i EU-overensstemmelseserklæringen findes på denne webadresse: Den officielle overensstemmelseserklæring kan findes på http://www.samsung.com . Gå til support > Søg efter produktsupport, og angiv modelnavnet. |
| German | Samsung Electronics erklärt hiermit, dass diese Vorrichtung vom Gerätetyp Funkgerät der Richtlinie 2014/53/EU entspricht. Der gesamte Text der EU-Konformitätserklärung ist unter der folgenden Internetadresse verfügbar: Die offizielle Konformitätserklärung ist unter http://www.samsung.com zu finden. Gehen Sie zu Support > Produktsupport durchsuchen und geben Sie den Modellnamen ein. |
| Estonian | Käesolevaga kinnitab Samsung Electronics, et raadioseadme tüüpi seade vastab direktiivile 2014/53/EL. EL-i vastavusdeklaratsiooni terve tekst on saadaval internetis järgmisel aadressil. Ametliku vastavusdeklaratsiooni leiute aadressilt http://www.samsung.com , avage menüü Tugi > Otsi toote tuge ja sisestage seejärel mudeli nimi. |
| Spanish | Por la presente, Samsung Electronics declara que este aparato de equipamiento de radio cumple con la Directiva 2014/53/UE. El texto completo de la declaración de conformidad con la UE está disponible en la siguiente dirección de Internet: La Declaración de conformidad oficial se puede encontrar en http://www.samsung.com , vaya a soporte > Búsqueda de soporte de productos e introduzca el nombre del modelo. |
| Greek | Με την παρούσα, η Samsung Electronics, δηλώνει ότι η συσκευή ραδιοεξοπλισμού συμμορφώνεται με την Οδηγία 2014/53/ΕΕ. Το πλήρες κείμενο της δήλωσης συμμόρφωσης με την ευρωπαϊκή οδηγία είναι διαθέσιμο στη διεύθυνση: Μπορείτε να βρείτε την επίσημη δήλωση συμμόρφωσης στην τοποθεσία http://www.samsung.com . Επιλέξτε Υποστήριξη > Αναζήτηση υποστήριξης προϊόντος και εισαγάγετε το όνομα μοντέλου. |
| French | Par la présente, Samsung Electronics déclare que cet appareil de type équipement radio est en conformité avec la Directive 2014/53/UE. Le texte intégral de la déclaration de conformité de l'UE est disponible à l'adresse Internet suivante : La Déclaration officielle de conformité se trouve sur http://www.samsung.com , rendez-vous sur la page d'assistance > Rechercher dans l'Assistance et saisissez un nom de modèle. |
| Italian | Samsung Electronics dichiara che l'apparecchiatura radio aderisce alla direttiva 2014/53/EU. Il testo integrale della dichiarazione di conformità EU è disponibile al seguente indirizzo: La dichiarazione ufficiale di conformità è disponibile su http://www.samsung.com , selezionare supporto > Cerca Supporto Prodotto e inserire il nome del modello. |

| | |
|------------|--|
| Latvian | Samsung Electronics ar šo paziņo, ka šī radioiekārtas tipa ierīce atbilst Direktīvas 2014/53/ES prasībām. Pilns ES atbilstības deklarācijas teksts ir pieejams šajā interneta adresē: Oficiālo atbilstības deklarāciju var atrast vietnē http://www.samsung.com , atverot Atbalsts > Meklēt produkta atbalstu un ievadot modeļa nosaukumu. |
| Lithuanian | Šiuo dokumentu Samsung Electronics patvirtina, kad radijo įrangos tipo prietaisais atitinka direktyvos 2014/53/ES reikalavimus. Visą ES atitikties deklaracijos tekstą rasite apsilankę internetinėje svetainėje adresu: Oficiali atitikties deklaracija pateikiama svetainėje http://www.samsung.com , eikite į skirtuką Palaikymas > Ieškoti gaminio palaikymo ir įveskite modelio numerį. |
| Dutch | Samsung Electronics verklaart hierbij dat het type radiotoestel voldoet aan Richtlijn 2014/53/EU. De volledige tekst van de EG-Conformiteitsverklaring vindt u op deze website: De officiële Conformiteitsverklaring vindt u op http://www.samsung.com , ga naar Ondersteuning > Productondersteuning zoeken en voer de modelnaam in. |
| Hungarian | A Samsung Electronics ezennel kijelenti, hogy a rádiós berendezés típusú készülék megfelel a 2014/53/EK irányelv előírásainak. Az EU megfeleléségi nyilatkozat teljes szövege az alábbi weboldalon olvasható: A hivatalos Megfeleléségi nyilatkozat a http://www.samsung.com honlapon olvasható, lépjen a Támogatás > Terméktámogatás keresése menüpontra, és adja meg a modell nevét. |
| Polish | Firma Samsung Electronics niniejszym oświadcza, że sprzęt radiowy jest zgodny z wymogami Dyrektywy 2014/53/UE. Pełny tekst europejskiej deklaracji zgodności jest dostępny na stronie internetowej: Treść oficjalnej deklaracji zgodności jest dostępna pod adresem http://www.samsung.com w menu Wsparcie > Szukaj, gdzie należy podać nazwę modelu. |
| Portuguese | Pelo presente, a Samsung Electronics declara que o aparelho tipo equipamento de rádio está em conformidade com a Diretiva 2014/53/UE. O texto integral da declaração de conformidade europeia está disponível no seguinte endereço da internet: A Declaração de conformidade oficial pode ser encontrada em http://www.samsung.com , vá a Suporte > Pesquisar Suporte do produto e insira o nome do modelo. |
| Slovenian | S tem družba Samsung Electronics izjavlja, da je radijska oprema skladna z Direktivo 2014/53/EU. Celotno besedilo izjave ES o skladnosti je na voljo na spodnjem internetnem naslovu: Uradno izjavo o skladnosti lahko najdete na naslovu http://www.samsung.com . Pojdite na podpora > Iskanje podpore za izdelek, nato vnesite ime izdelka. |
| Slovak | Spoločnosť Samsung Electronics týmto vyhlasuje, že zariadenie rádiového typu je v súlade so smernicou 2014/53/EÚ. Celé znenie Vyhlásenia o zhode EÚ je k dispozícii na nasledujúcej internetovej adrese: Oficiálne Vyhlásenie o zhode sa nachádza na lokalite http://www.samsung.com , prejdite na položky Podpora > Vyhľadávanie podpory produktov a zadajte názov modelu. |
| Finnish | Samsung Electronics vakuuttaa, että radiolaitte on direktiivin 2014/53/EU vaatimusten mukainen. EU-vaatimusten mukaisuusvakuutuksen täydellinen teksti on saatavilla seuraavassa Internet-osoitteessa: Virallinen vaatimusten mukaisuusvakuutus on osoitteessa http://www.samsung.com . Valitse Tuki > Etsi tuotetukea ja kirjoita mallinimi. |

| | |
|-----------|--|
| Swedish | Härmed deklarerar Samsung Electronics att denna anordning av radioutrustningstyp uppfyller direktivet 2014/53/EU. Den fullständiga texten i EU-deklarationen om överensstämmelse finns tillgänglig på följande internetadress: Den officiella deklarationen om överensstämmelse finns på http://www.samsung.com . Gå till stöd > Sök produktsupport och ange modellnamnet. |
| Bulgarian | С настоящия документ Samsung Electronics декларира, че уредът от тип радиоборудване е в съответствие с Директива 2014/53/ЕС. Целият текст на ЕС Декларацията за съответствие е наличен на следния интернет адрес: Официалната Декларация за съответствие можете да намерите на http://www.samsung.com , отидете на отидете на поддръжка > Търсене на поддръжка за продукт и въведете името на модела. |
| Romanian | Prin prezenta, Samsung Electronics declară faptul că aparatul de tip echipament radio respectă Directiva 2014/53/UE. Textul complet al declarației de conformitate UE este disponibil la una dintre următoarele adrese de internet: Declarația de conformitate oficială poate fi găsită la http://www.samsung.com , accesați asistența > Căutați asistența produsului și introduceți numele modelului. |
| Norwegian | Samsung Electronics erklærer herved at dette radioutstyret er i samsvar med direktiv 2014/53/EU. Den fullstendige teksten til EU-samsvarserklæringen er tilgjengelig på følgende nettadresse: Den offisielle samsvarserklæringen finnes på http://www.samsung.com . Gå til Support > Søk gjennom produktsupport og angi modellnavn. |
| Turkish | İşbu belge ile, Samsung Electronics bu radyo ekipmanı türü cihazın 2014/53/EU Direktifine uygun olduğunu beyan etmektedir. AB uygunluk beyanının tam metnine aşağıdaki internet adresinden ulaşabilirsiniz: Resmî Uygunluk beyanını http://www.samsung.com adresinde bulabilirsiniz. Destek > Ürün Desteği Ara'ya gidin ve model adını girin. |
| Russian | Настоящим компания Samsung Electronics заявляет, что устройство типа радиоборудование соответствует Директиве 2014/53/ЕС. Полный текст декларации о соответствии ЕС доступен по следующему веб-адресу: Официальная Декларация о соответствии доступна по адресу http://www.samsung.com , перейдите в раздел Поддержка > Поиск продукта и введите имя модели. |
| Ukrainian | Ця компанія Samsung Electronics заявляє, що прилад, який належить до радіобладнання, відповідає вимогам Директиви 2014/53/EU. Повний текст декларації про відповідність нормам країн ЄС доступний за такою адресою в інтернеті: Офіційний текст Декларації про відповідність можна знайти на сайті http://www.samsung.com ; перейдіть до розділу підтримки, потім — до поля пошуку підтримки для певного виробу та введіть назву моделі. |
| Serbian | Ovim putem kompanija Samsung Electronics izjavljuje da je ovaj uređaj u tipu radio opreme u skladu sa direktivom 2014/53/EU. Kompletan sadržaj EU deklaracije o usaglašenosti dostupan je na sledećoj internet adresi: Zvaničnu deklaraciju o usaglašenosti možete naći na adresi http://www.samsung.com , idite na Podrška > Pretraga podrške za proizvode i unesite naziv modela. |
| Croatian | Tvrtka Samsung Electronics ovim izjavljuje da je uređaj tipa radijske opreme usklađen s Direktivom 2014/53/EU. Potpuni tekst EU deklaracije o sukladnosti dostupan je na sljedećim web-adresama: Službenu izjavu o sukladnosti možete pronaći na adresi http://www.samsung.com , ako odaberete Podrška > Traži podršku za proizvod i unesete naziv modela. |

Memo



***Correct Disposal of This Product
(Waste Electrical & Electronic Equipment)***

(Applicable in countries with separate collection systems)

This marking on the product, accessories or literature indicates that the product and its electronic accessories (e.g. charger, headset, USB cable) should not be disposed of with other household waste at the end of their working life. To prevent possible harm to the environment or human health from uncontrolled waste disposal, please separate these items from other types of waste and recycle them responsibly to promote the sustainable reuse of material resources.

Household users should contact either the retailer where they purchased this product, or their local government office, for details of where and how they can take these items for environmentally safe recycling.

Business users should contact their supplier and check the terms and conditions of the purchase contract. This product and its electronic accessories should not be mixed with other commercial wastes for disposal.



Correct disposal of batteries in this product

This marking on the battery, manual or packaging indicates that the batteries in this product should not be disposed of with other household waste at the end of their working life. Where marked, the chemical symbols Hg, Cd or Pb indicate that the battery contains mercury, cadmium or lead above the reference levels in EC Directive 2006/66.

For information on Samsung's environmental commitments and product-specific regulatory obligations, e.g. REACH, WEEE, Batteries, visit : samsung.com/uk/aboutsamsung/samsungelectronics/corporatecitizenship/data_corner.html

