

TOSHIBA

INSTALLATION MANUAL AIR CONDITIONER (SPLIT TYPE)

R32

INVERTER

ENGLISH

Indoor unit

RAS-10PKVPG-E

RAS-13PKVPG-E

RAS-16PKVPG-E

Outdoor unit

RAS-10PAVPG-E

RAS-13PAVPG-E

RAS-16PAVPG-E



1121451198

- PRECAUTIONS FOR SAFETY**..... 1
- ACCESSORY PARTS** 5
- INSTALLATION DIAGRAM OF INDOOR AND OUTDOOR UNITS** 6
 - **Optional Installation Parts** 6
- INDOOR UNIT**..... 7
 - **Installation Place**..... 7
 - **Cutting a Hole and Mounting Installation Plate** 7
 - **Piping and Drain Hose Installation** 8
 - **Indoor Unit Fixing**..... 9
 - **In case of Indoor unit is fixed to Installation plate with screws**..... 9
 - **Drainage** 9
- OUTDOOR UNIT**..... 10
 - **Installation Place**..... 10
 - **Precautions about Installation in Regions with Showfall and Cold Temperatures** 10
 - **Refrigerant Piping Connection** 10
 - **Evacuating** 11
- ELECTRICAL WORKS** 12
 - **Wiring Connection**..... 12
 - **Power Supply and Connecting Cable Connection** 13
 - **Power supply input Wiring Diagram**..... 14
- OTHERS**..... 15
 - **Gas Leak Test**..... 15
 - **Remote Control A-B Selection** 15
 - **Test Operation**..... 15
 - **Auto Restart Setting**..... 15

PRECAUTIONS FOR SAFETY



Read the precautions in this manual carefully before operating the unit.



This appliance is filled with R32.

EN

- Before installation, please read these precautions for safety carefully.
- Be sure to follow the precautions provided here to avoid safety risks. The symbols and their meanings are shown below.

WARNING : It indicates that incorrect use of this unit may cause severe injury or death.

CAUTION : It indicates that incorrect use of this unit may cause personal injury (*1), or property damage (*2).

*1 : Personal injury means a slight accident, burn, or electrical shock which does not require admission or repeated hospital treatment.

*2 : Property damage means greater damage which affects assets or resources.

For general public use

Power supply cord and connecting cable of appliance use shall be at least polychloroprene sheathed flexible cord (design H07RN-F) or cord designation 60245 IEC66. (Shall be installed in accordance with national wiring regulations.)

CAUTION

To disconnect the appliance from the main power supply

This appliance must be connected to the main power supply by means of a circuit breaker or a switch with a contact separation of at least 3 mm in all poles.

DANGER

- FOR USE BY QUALIFIED PERSONS ONLY.
- TURN OFF MAIN POWER SUPPLY BEFORE ATTEMPTING ANY ELECTRICAL WORK. MAKE SURE ALL POWER SWITCHES ARE OFF. FAILURE TO DO SO MAY CAUSE ELECTRIC SHOCK.
- CONNECT THE CONNECTING CABLE CORRECTLY. IF THE CONNECTING CABLE IS CONNECTED WRONGLY, ELECTRIC PARTS MAY BE DAMAGED.
- CHECK THE EARTH WIRE THAT IT IS NOT BROKEN OR DISCONNECTED BEFORE INSTALLATION.
- DO NOT INSTALL NEAR CONCENTRATIONS OF COMBUSTIBLE GAS OR GAS VAPORS. FAILURE TO FOLLOW THIS INSTRUCTION CAN RESULT IN FIRE OR EXPLOSION.
- TO PREVENT OVERHEATING THE INDOOR UNIT AND CAUSING A FIRE HAZARD, PLACE THE UNIT WELL AWAY (MORE THAN 2 M) FROM HEAT SOURCES SUCH AS RADIATORS, HEATERS, FURNACE, STOVES, ETC.
- WHEN MOVING THE AIR CONDITIONER FOR INSTALLING IT IN ANOTHER PLACE AGAIN, BE VERY CAREFUL NOT TO GET THE SPECIFIED REFRIGERANT (R32) WITH ANY OTHER GASEOUS BODY INTO THE REFRIGERATION CYCLE. IF AIR OR ANY OTHER GAS IS MIXED IN THE REFRIGERANT, THE GAS PRESSURE IN THE REFRIGERATION CYCLE BECOMES ABNORMALLY HIGH AND IT RESULTINGLY CAUSES BURST OF THE PIPE AND INJURIES ON PERSONS.
- IN THE EVENT THAT THE REFRIGERANT GAS LEAKS OUT OF THE PIPE DURING THE INSTALLATION WORK, IMMEDIATELY LET FRESH AIR INTO THE ROOM. IF THE REFRIGERANT GAS IS HEATED BY FIRE OR SOMETHING ELSE, IT CAUSES GENERATION OF POISONOUS GAS.

WARNING

- Never modify this unit by removing any of the safety guards or bypassing any of the safety interlock switches.
- Do not install in a place which cannot bear the weight of the unit. Personal injury and property damage can result if the unit falls.
- Before doing the electrical work, attach an approved plug to the power supply cord.
Also, make sure the equipment is properly earthed.
- Appliance shall be installed in accordance with national wiring regulations. If you detect any damage, do not install the unit. Contact your dealer immediately.

- Do not use any refrigerant different from the one specified for complement or replacement.
Otherwise, abnormally high pressure may be generated in the refrigeration cycle, which may result in a failure or explosion of the product or an injury to your body.
- Do not use means to accelerate the defrosting process or to clean, other than those recommended by the manufacturer.
- The appliance shall be stored in a room without continuously operating ignition sources (for example: open flames, an operating gas appliance or an operating electric heater).
- Be aware that refrigerants may not contain an odour.
- Do not pierce or burn as the appliance is pressurized. Do not expose the appliance to heat, flame, sparks, or other sources or ignition. Else, it may explode and cause injury or death.
- For R32 model, use pipes, flare nut and tools which is specified for R32 refrigerant. Using of existing (R22) piping, flare nut and tools may cause abnormally high pressure in the refrigerant cycle (piping), and possibly result in explosion and injury.
- Thickness of copper pipes used R32 must be more than 0.8mm. Never use copper pipes thinner than 0.8mm.
- Do not perform flare connection inside a building or dwelling or room, when joining the heat exchanger of indoor unit with interconnection piping. Refrigerant connection inside a building or dwelling or room must be made by brazing or welding. Joint connection of indoor unit by flaring method can only be made at outdoor or at outside of building or dwelling or room. Flare connection may cause gas leak and flammable atmosphere.
- After completion of installation or service, confirm there is no leakage of refrigerant gas. It may generate toxic gas when the refrigerant contacts with fire.
- Appliance and pipe-work shall be installed, operated and stored in a room with a floor area larger than A_{\min} m².
How to get A_{\min} m² : $A_{\min} = (M / (2.5 \times 0.22759 \times h_0))^2$
M is the refrigerant charge amount in appliance in kg. h_0 is the installation height of the appliance in m: 0.6 m for floor standing/1.8 m for wall mounted/1.0 m for window mounted/2.2 m for ceiling mounted (For these units recommend installation height 2.5 m.).
- Comply with national gas regulations.

CAUTION

- Exposure of unit to water or other moisture before installation could result in electric shock.
Do not store it in a wet basement or expose to rain or water.
- After unpacking the unit, examine it carefully for possible damage.
- Do not install the unit at place where leakage of flammable gas may occur. In case gas leaks and accumulates at surrounding of the unit, it may cause of fire.
- Do not install in a place that can increase the vibration of the unit. Do not install in a place that can amplify the noise level of the unit or where noise and discharged air might disturb neighbors.
- To avoid personal injury, be careful when handling parts with sharp edges.
- Please read this installation manual carefully before installing the unit. It contains further important instructions for proper installation.
- The manufacturer shall not assume any liability for the damage caused by not observing the description of this manual.

REQUIREMENT OF REPORT TO THE LOCAL POWER SUPPLIER

Please make absolutely sure that the installation of this appliance is reported to the local power supplier before installation. If you experience any problems or if the installation is not accepted by the supplier, the service agency will take adequate countermeasures.

■ Important information regarding the refrigerant used

This product contains fluorinated greenhouse gases.

Do not vent gases into the atmosphere.

Refrigerant type: **R32**











GWP⁽¹⁾ value: **675** * (ex. R32 ref. AR4)

⁽¹⁾GWP = global warming potential

The refrigerant quantity is indicated on the unit name plate.

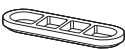
* This value is based on F gas regulation 517/2014

ACCESSORY PARTS

ACCESSORY AND INSTALLATION PARTS			
No.	Parts name	No.	Parts name
①	 Installation plate* x 1	②	 Wireless remote control* x 1
③	 Battery x 2	④	 Remote control holder* x 1
⑤	 Mounting screw** $\varnothing 4 \times 25 / \times 6$	⑥	 Flat head wood screw $\varnothing 3.1 \times 16 / \times 2$
⑦	 Drain nipple*** x 1 (for heating model only)	⑧	 Cap water proof*** x 2 (for some models only)
⑨	 Owner's Manual	⑩	 Installation Manual
⑪	 B Label x 2 (for Multi model)		

* The part may differ from that shown.

** The number of parts may differ by model.

*** The part is packed with the outdoor unit.

Filter Clean / Replacement

Air filters

Clean every 2 weeks.

1. Open the air inlet grille.
2. Remove the air filters.
3. Vacuum or wash and then dry them.
4. Reinstall the air filters and close the air inlet grille.

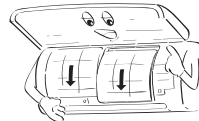
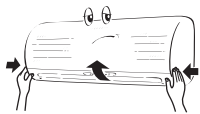

INSTALLATION DIAGRAM OF INDOOR AND OUTDOOR UNITS

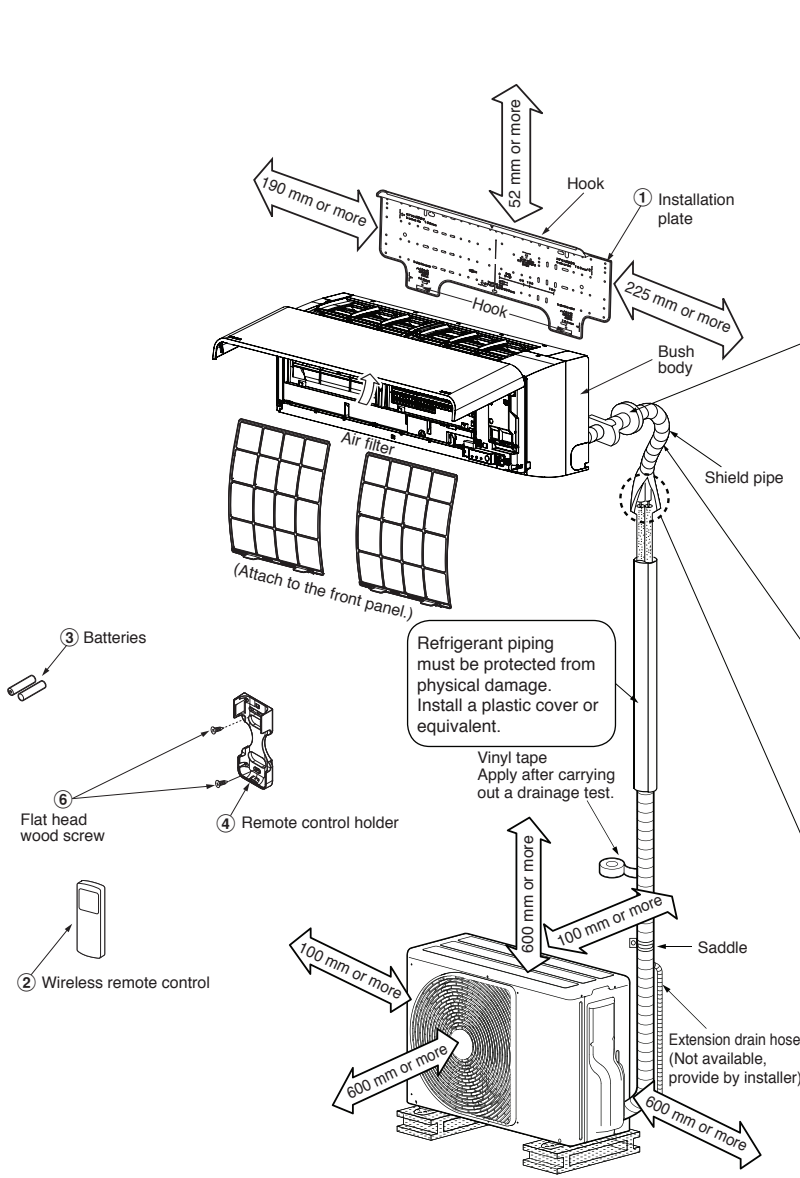

For the rear left and left piping

Wall

Insert the cushion between the indoor unit and wall, and tilt the indoor unit for better operation.

The auxiliary piping can be connected to the left, rear left, rear right, right, bottom right or bottom left.

Right

Rear right

Bottom right

Rear left

Bottom left

Left

Do not allow the drain hose to get slack.

Cut the piping hole sloped slightly.

Make sure to run the drain hose sloped downward.

The flare connection should be installed outdoors.

Insulate the refrigerant pipes separately with insulation, not together.

6 mm thick heat resisting polyethylene foam

Optional Installation Parts

Part code	Parts name	Q'ty
A	Refrigerant piping Liquid side : Ø6.35 mm Gas side : Ø9.52 mm (RAS-10, 13PKVPG-E) : Ø12.7 mm (RAS-16PKVPG-E)	One each
B	Pipe insulating material (polyethylene foam, 6 mm thick)	1
C	Putty, PVC tapes	One each

Fixing bolt arrangement of outdoor unit

- Secure the outdoor unit with fixing bolts and nuts if the unit is likely to be exposed to a strong wind.
- Use Ø8 mm or Ø10 mm anchor bolts and nuts.
- If it is necessary to drain the defrost water, attach drain nipple ⑦ and cap water proof ⑧ to the bottom plate of the outdoor unit before installing it.

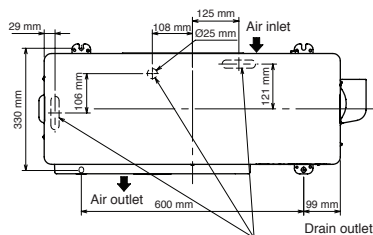

* Drain nipple and cap water proof are packed in outdoor unit.

Piping and Drain Hose Installation

Piping and drain hose forming

* Since dewing results in a machine trouble, make sure to insulate both connecting pipes. (Use polyethylene foam as insulating material.)

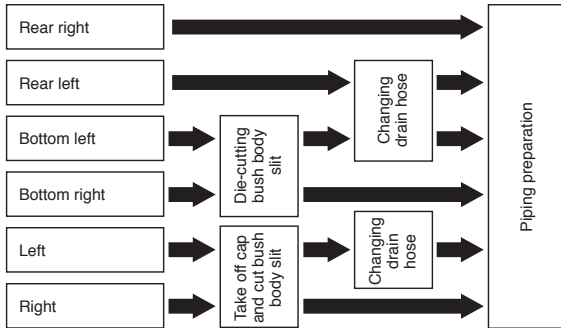

1. Die-cutting bush body slit

• For Bottom left or Bottom right

Cut out the slit on bottom left or right side of bush body for the bottom left or right connection with a pair of nippers.

• For Left or Right

Take off Cap and cut out the slit on left or right side of bush body for the left or right connection with a pair of nippers.

2. Changing drain hose

For leftward connection, bottom-leftward connection and rearleftward connection's piping, it is necessary to change the drain hose and drain cap.

How to remove the drain hose

- The drain hose can be removed by removing the screw securing the drain hose and then pulling out the drain hose.
- When removing the drain hose, be careful of any sharp edges of steel plate. The edges can injure.
- To install the drain hose, insert the drain hose firmly until the connection part contacts with heat insulator, and then secure it with original screw.

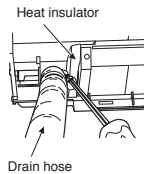

How to remove the drain cap

Clip the drain cap by needle-nose pliers and pull out.

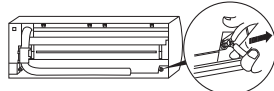

How to fix the drain cap

- 1) Insert hexagon wrench (4 mm) in a center head.
- 2) Firmly insert the drain cap.

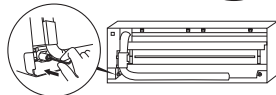

Do not apply lubricating oil (refrigerant machine oil) when inserting the drain cap. Application causes deterioration and drain leakage of the plug.

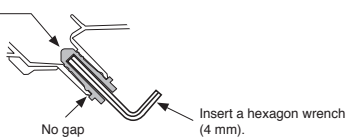

CAUTION

Firmly insert the drain hose and drain cap; otherwise, water may leak.

In case of right or left piping

- Take off the cap by hand and cut of the slit.
- After scribing slits of the bush body with a knife or a making-off pin, cut them with a pair of nippers or an equivalent tool.

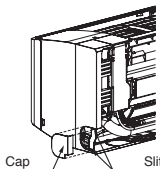

In case of bottom right or bottom left piping

- After scribing slits of the bush body with a knife or a making-off pin, cut them with a pair of nippers or an equivalent tool.

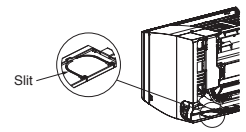

Left-hand connection with piping

- Bend the connecting pipe so that it is laid within 43 mm above the wall surface. If the connecting pipe is laid exceeding 43 mm above the wall surface, the indoor unit may unstably be set on the wall. When bending the connecting pipe, make sure to use a spring bender so as not to crush the pipe.

Bend the connecting pipe within a radius of 30 mm.

To connect the pipe after installation of the unit (figure)

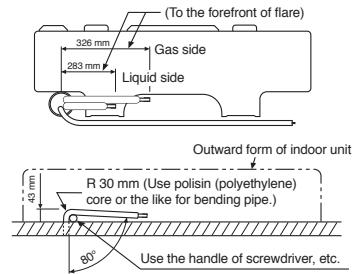

WARNING

- Do not perform flare connection inside a building or dwelling or room, when joining the heat exchanger of indoor unit with interconnection piping. Refrigerant connection inside a building or dwelling or room must be made by brazing or welding. Joint connection of indoor unit by flaring method can only be made at outdoor or at outside of building or dwelling or room. Flare connection may cause gas leak and flammable atmosphere.

NOTE

If the pipe is bent incorrectly, the indoor unit may unstably be set on the wall. After passing the connecting pipe through the pipe hole, connect the connecting pipes to the auxiliary pipes and wrap the facing tape around them.

CAUTION

- Bind the auxiliary pipes (two) and connecting cable with facing tape tightly. In case of leftward piping and rear-leftward piping, bind the auxiliary pipes (two) only with facing tape.

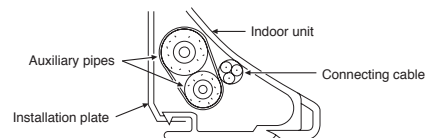

- Carefully arrange pipes so that any pipe does not stick out of the rear plate of the indoor unit.
- Carefully connect the auxiliary pipes and connecting pipes to one another and cut off the insulating tape wound on the connecting pipe to avoid double-taping at the joint; moreover, seal the joint with the vinyl tape, etc.
- Since dewing results in a machine trouble, make sure to insulate both connecting pipes. (Use polyethylene foam as insulating material.)
- When bending a pipe, carefully do it, not to crush it.

Indoor Unit Fixing

1. Pass the pipe through the hole in the wall and hook the indoor unit on the installation plate at the upper hook.
2. Swing the indoor unit to right and left to confirm that it is firmly hooked up on the installation plate.
3. While pressing the indoor unit onto the wall, hook it at the lower part on the installation plate. Pull the indoor unit toward you to confirm that it is firmly hooked up on the installation plate.

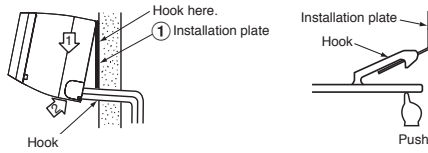

- For detaching the indoor unit from the installation plate, pull the indoor unit toward you while pushing its bottom up at the specified parts.

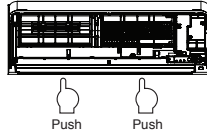

In case of Indoor unit is fixed to Installation plate with screws

1. Remove 2 screw caps with flat screwdriver.
2. Fix them with $\text{O}4 \times 10 \sim 14\text{L}$, 2 screws which are prepared at the site.
3. Cover screw caps as previous process.

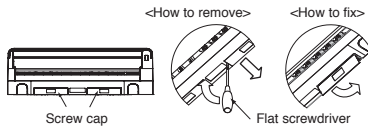

Drainage

1. Run the drain hose sloped downwards.

NOTE

- The hole should be made at a slight downward slant on the outdoor side.

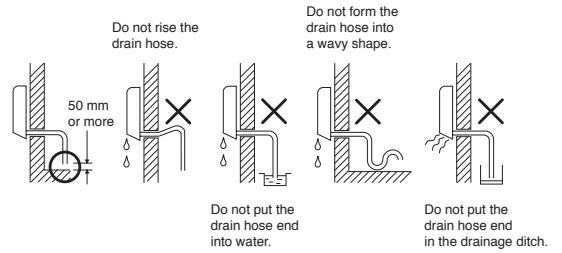

2. Put water in the drain pan and make sure that the water is drained out of doors.
3. When connecting extension drain hose, insulate the connecting part of extension drain hose with shield pipe.

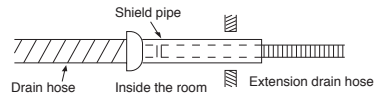

CAUTION

Arrange the drain pipe for proper drainage from the unit. Improper drainage can result in dew-dropping.

This air conditioner has the structure designed to drain water collected from dew, which forms on the back of the indoor unit, to the drain pan. Therefore, do not store the power cord and other parts at a height above the drain guide.

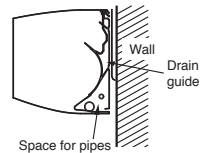

OUTDOOR UNIT

Installation Place

- A place which provides the spaces around the outdoor unit as shown in the diagram
- A place which can bear the weight of the outdoor unit and does not allow an increase in noise level and vibration
- A place where the operation noise and discharged air do not disturb your neighbors
- A place which is not exposed to a strong wind
- A place free of a leakage of combustible gases
- A place which does not block a passage
- When the outdoor unit is to be installed in an elevated position, be sure to secure its feet.
- The allowable length of the connecting pipe.

Models	RAS-10PAVPG-E	RAS-13PAVPG-E	RAS-16PAVPG-E
Chargeless	up to 15 m	up to 15 m	up to 15 m
Maximum length	20 m	20 m	20 m
Additional refrigerant charging	16 - 25 m (20g / 1m)	16 - 25 m (20g / 1m)	16 - 25 m (20g / 1m)

- The allowable height of outdoor unit installation site.

Models	RAS-10PAVPG-E	RAS-13PAVPG-E	RAS-16PAVPG-E
Maximum height	10 m	10 m	10 m

- A place where the drain water does not raise any problems

CAUTION

When the outdoor unit is installed in a place where the drain water might cause any problems, Seal the water leakage point tightly using a silicone adhesive or caulking compound.

Precautions about Installation in Regions with Snowfall and Cold Temperatures

- Do not use the supplied drain nipple for draining water. Drain the water from all the drain holes directly.
- To protect the outdoor unit from snow accumulation, install a holding frame, and attach a snow protection hood and plate.
- Do not use a double-stacked design.

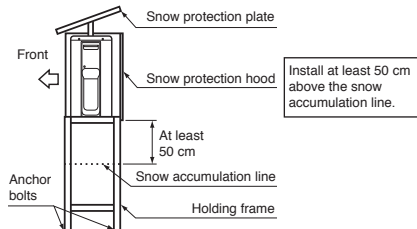

CAUTION

1. Install the outdoor unit without anything blocking the air discharging.
2. When the outdoor unit is installed in a place always exposed to strong wind like a coast or on a high storey of a building, secure the normal fan operation using a duct or a windshield.
3. In particularly windy areas, install the unit such as to avoid admission of wind.
4. Installation in the following places may result in trouble. Do not install the unit in such places.
 - A place full of machine oil
 - A saline-place such as the coast
 - A place full of sulfide gas
 - A place where high-frequency waves are likely to be generated as from audio equipment, welders, and medical equipment

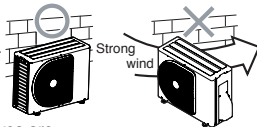

Refrigerant Piping Connection

Flaring

1. Cut the pipe with a pipe cutter.



2. Insert a flare nut into the pipe and flare the pipe.

- Projection margin in flaring : A (Unit : mm)

RIDGID (clutch type)

Outer dia. of copper pipe	R32 tool used	Conventional tool used
Ø6.35	0 to 0.5	1.0 to 1.5
Ø9.52	0 to 0.5	1.0 to 1.5
Ø12.70	0 to 0.5	1.0 to 1.5

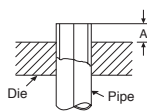

IMPERIAL (wing nut type)

Outer dia. of copper pipe	R32
Ø6.35	1.5 to 2.0
Ø9.52	1.5 to 2.0
Ø12.70	2.0 to 2.5

CAUTION

- Do not scratch the inner surface of the flared part when removing burrs.
- Flare processing under the condition of scratches on the inner surface of flare processing part will cause refrigerant gas leak.

Tightening connection

Align the centers of the connecting pipes and tighten the flare nut as far as possible with your fingers. Then tighten the nut with a spanner and torque wrench as shown in the figure.

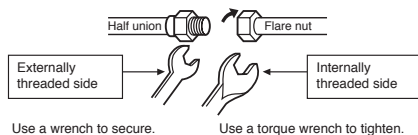

CAUTION

Do not apply excess torque. Otherwise, the nut may crack depending on the conditions.

(Unit : N·m)

Outer dia. of copper pipe	Tightening torque
Ø6.35 mm	14 to 18 (1.4 to 1.8 kgf·m)
Ø9.52 mm	33 to 42 (3.3 to 4.2 kgf·m)
Ø12.70 mm	50 to 62 (5.0 to 6.2 kgf·m)

Tightening torque of flare pipe connections

The operating pressure of R32 is higher than that of R22 (approx. 1.6 times). It is therefore necessary to firmly tighten the flare pipe connecting sections (which connect the indoor and outdoor units) up to the specified tightening torque. Incorrect connections may cause not only a gas leakage, but also damage to the refrigeration cycle.

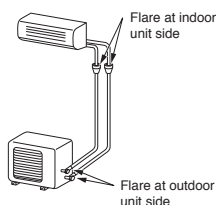

Evacuating

After the piping has been connected to the indoor unit, you can perform the air purge together at once.

AIR PURGE

Evacuate the air in the connecting pipes and in the indoor unit using a vacuum pump. Do not use the refrigerant in the outdoor unit. For details, see the manual of the vacuum pump.

Using a vacuum pump

Be sure to use a vacuum pump with counter-flow prevention function so that inside oil of the pump does not flow backward into pipes of the air conditioner when the pump stops. (If oil inside of the vacuum pump enters the air conditioner, which use R32, refrigeration cycle trouble may result.)

1. Connect the charge hose from the manifold valve to the service port of the packed valve at gas side.
2. Connect the charge hose to the port of the vacuum pump.
3. Open fully the low pressure side handle of the gauge manifold valve.
4. Operate the vacuum pump to start evacuating. Perform evacuating for about 15 minutes if the piping length is 25 meters. (15 minutes for 25 meters) (assuming a pump capacity of 27 liters per minute) Then confirm that the compound pressure gauge reading is -101 kPa (-76 cmHg).
5. Close the low pressure side valve handle of the gauge manifold valve.
6. Open fully the valve stem of the packed valves (both gas and liquid sides).
7. Remove the charging hose from the service port.
8. Securely tighten the caps on the packed valves.

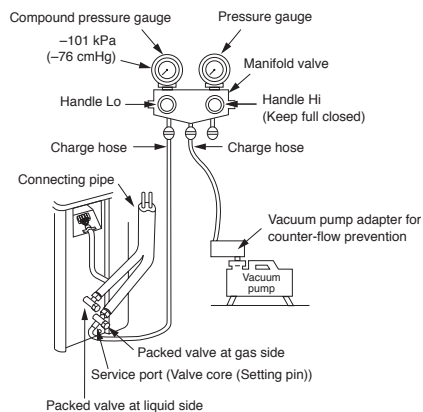

CAUTION

KEEP IMPORTANT 6 POINTS FOR PIPING WORK.

- (1) Take away dust and moisture (inside of the connecting pipes).
- (2) Tighten the connections (between pipes and unit).
- (3) Evacuate the air in the connecting pipes using a VACUUM PUMP.
- (4) Check gas leak (connected points).
- (5) Be sure to fully open the packed valves before operation.
- (6) Reusable mechanical connectors and flared joints are not allowed indoors. When mechanical connectors are reused indoors, sealing parts shall be renewed. When flared joints are reused indoors, the flare part shall be refabricated.

Packed valve handling precautions

- Open the valve stem all the way out, but do not try to open it beyond the stopper.

Pipe size of Packed Valve	Size of Hexagon wrench
12.70 mm and smaller	A = 4 mm
15.88 mm	A = 5 mm

- Securely tighten the valve cap with torque in the following table.

Cap	Cap Size (H)	Torque
Valve Rod Cap	H17 - H19	14~18 N·m (1.4 to 1.8 kgf·m)
	H22 - H30	33~42 N·m (3.3 to 4.2 kgf·m)
Service Port Cap	H14	8~12 N·m (0.8 to 1.2 kgf·m)
	H17	14~18 N·m (1.4 to 1.8 kgf·m)

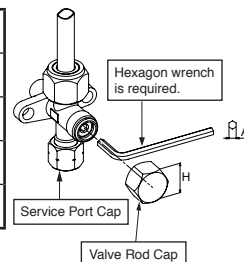

ELECTRICAL WORKS

The power supply can be selected to connect to indoor unit or outdoor unit. Choose proper way and connect the power supply and connecting cable by follow the instruction as following.

Model	RAS-10PKVPG-E	RAS-13PKVPG-E	RAS-16PKVPG-E
Power source	50Hz, 220-240 V Single phase		
Maximum running current	8.50A	10.00A	10.50A
Circuit breaker rating	10.50A	12.50A	13.50A
Power supply cable	H07RN-F or 60245 IEC66 (1.5 mm ² or more)		
Connecting cable			

Wiring Connection

Indoor unit

Wiring of the cable can be carried out without removing the main panel.

1. Remove the front panel.
Pull and lift up front panel until it stops, move arms on left and right side to outward direction then pull toward you to remove front panel.
* Beware front panel fall down that may cause of injure or part damage.

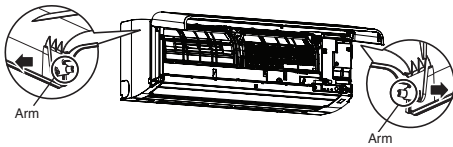

2. Remove the terminal cover and cord clamp.
3. Insert the cable (according to the local cords) into the pipe hole on the wall.
4. Take out the cable protrudes about 20 cm from the front.
5. Insert the cable fully into the terminal block and secure it tightly with screws.
6. Tightening torque : 1.2 N·m (0.12 kgf·m)
7. Secure the cable with the cord clamp.
8. Fix the terminal cover and attach front panel to the indoor unit.

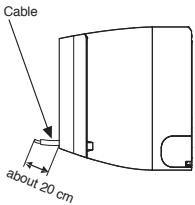
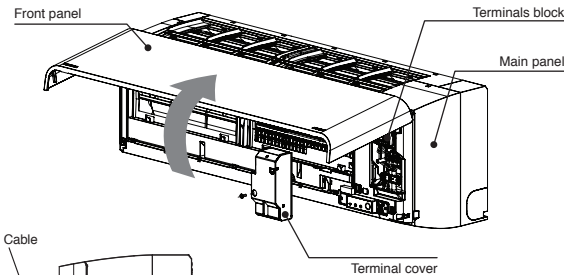

How to attach the front panel

Carry out attaching in the reverse order to removal.

Keep front panel horizontally and put both arms into guides.
Make sure both arms are inserted completely.
If the gap between main panel and front panel isn't even, remove and attach again.

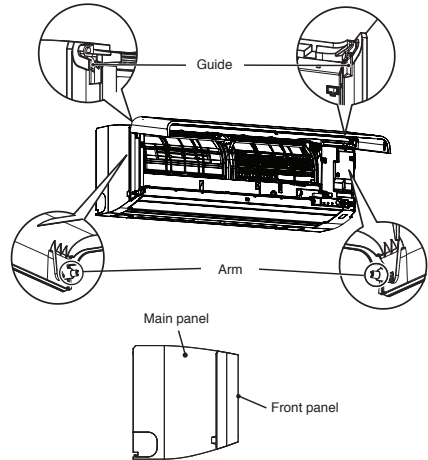

CAUTION

- Be sure to refer to the wiring system diagram labeled inside the main panel.
- Check local electrical cords and also any specific wiring instructions or limitations.

Outdoor unit

1. Remove the valve cover from the outdoor unit.
2. Connect the cable to the terminals as identified with their respective matched numbers on the terminal block of indoor and outdoor unit.
3. When connecting the cable to the outdoor unit terminals, make a loop as shown in the installation diagram of indoor and outdoor unit to prevent water coming in the outdoor unit.
4. Insulate the unused cords (conductors) from any water coming in the outdoor unit. Proceed them so that they do not touch any electrical or metal parts.

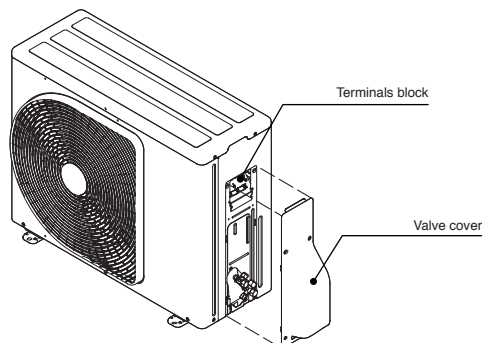

Power Supply and Connecting Cable Connection

EN

Power Supply Input at Indoor Unit Terminal Block (Recommend)

Power supply cable

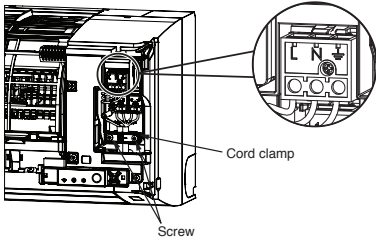

Indoor Unit

Stripping length of the power supply cable

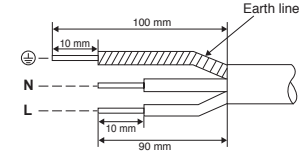

Connecting cable

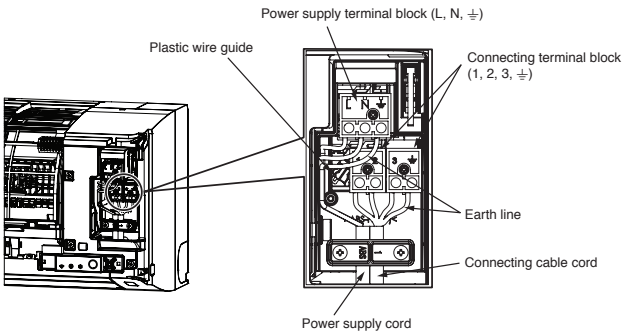

Stripping length of the connecting cable

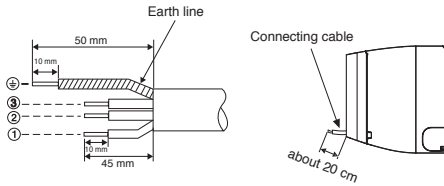

Outdoor Unit

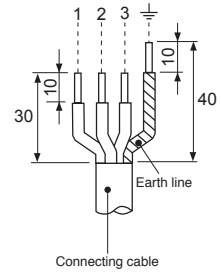
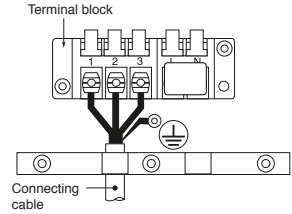

Power Supply Input at Outdoor Unit Terminal Block (Optional)

Connecting cable

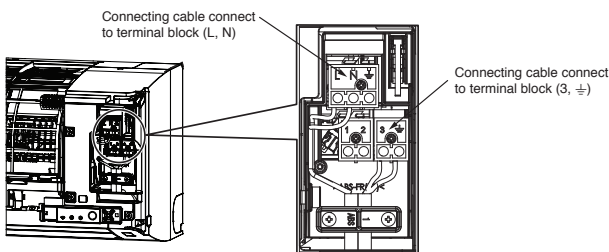

Indoor Unit

Outdoor Unit

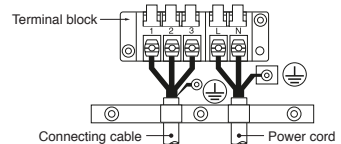

Stripping length of the connecting cable

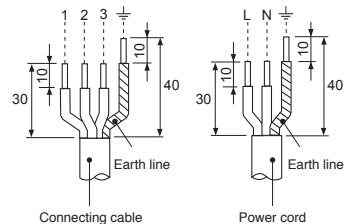
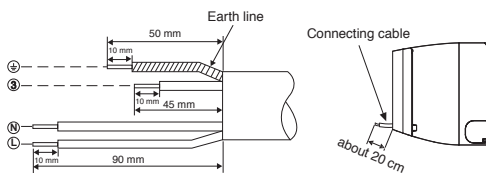

Power supply input Wiring Diagram

Power supply input at Indoor unit Terminal Block (Recommend)

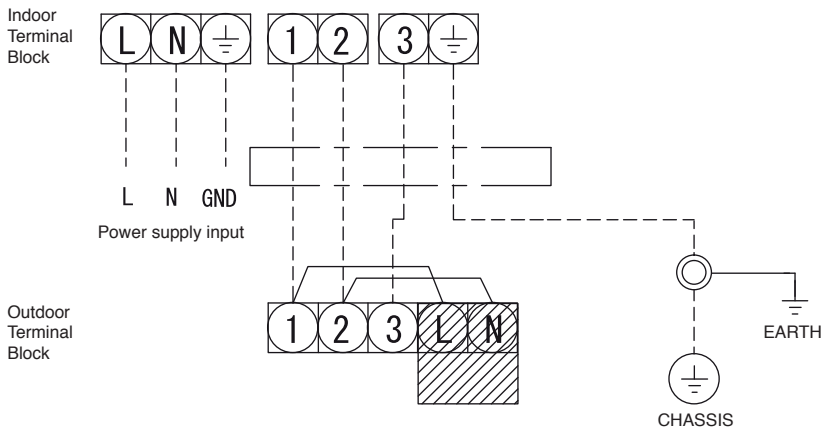

Power supply input at Outdoor unit Terminal Block (Optional)

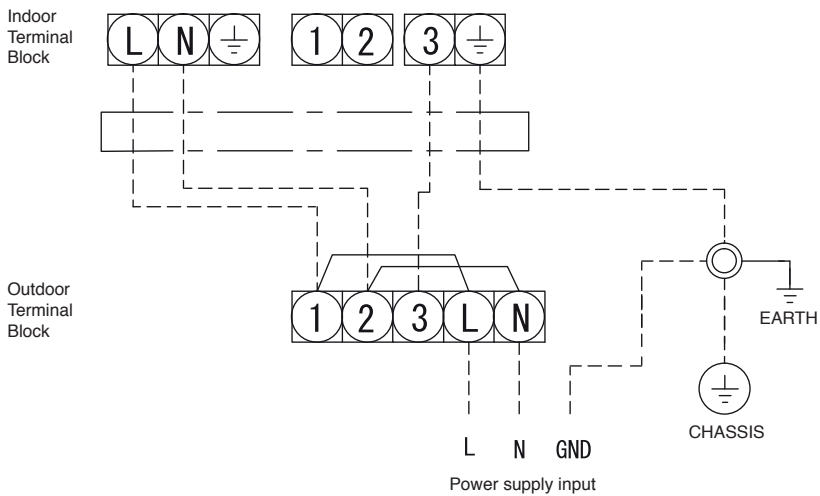

CAUTION

1. The power supply must be same as the rated of air conditioner.
 2. Prepare the power source for exclusive use with air conditioner.
 3. Circuit breaker must be used for the power supply line of this air conditioner.
 4. Be sure to comply power supply and connecting cable for size and wiring method.
 5. Every wire must be connected firmly.
 6. Perform wiring works so as to allow a general wiring capacity.
 7. Wrong wiring connection may cause some electrical part burn out.
 8. Incorrect or incomplete wiring is carried out, it will cause an ignition or smoke.
 9. This product can be connected to main power supply.
- Connection to fixed wiring : A switch which disconnects all poles and has a contact separation at least 3mm must be incorporated in the fixed wiring.

OTHERS

Gas Leak Test

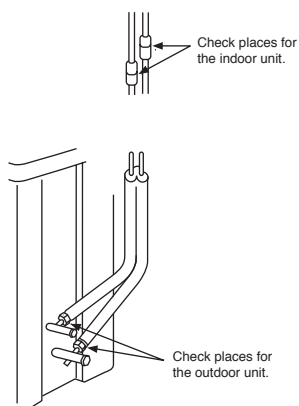

- Check the flare nut connections for the gas leak with a gas leak detector or soap water.

Remote Control A-B Selection

- When two indoor units are installed in the same room or adjacent two rooms, if operating a unit, two units may receive the remote control signal simultaneously and operate. In this case, the operation can be preserved by setting either one remote control to B setting. (Both are set to A setting in factory shipment.)
- The remote control signal is not received when the settings of indoor unit and remote control are different.
- There is no relation between A setting/B setting and A room/B room when connecting the piping and cables.

To separate using of remote control for each indoor unit in case of 2 air conditioner are installed near.

Remote Control B Setup.

1. Press RESET button on the indoor unit to turn the air conditioner ON.
2. Point the remote control at the indoor unit.
3. Push and hold **CHECK** button on the Remote Control by the tip of the pencil. "00" will be shown on the display (Picture ①).
4. Press **MODE** during pushing **CHECK**. "B" will show on the display and "00" will disappear and the air conditioner will turn OFF. The Remote Control B is memorized (Picture ②).

- Note :
1. Repeat above step to reset Remote Control to be A.
 2. Remote Control A has not "A" display.
 3. Default setting of Remote Control from factory is A.

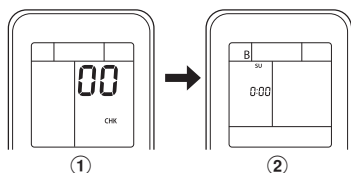

Test Operation

To switch to the TEST RUN (COOL) mode, press Temporary switch for 10 seconds. (The unit will make a short Pi sound.)

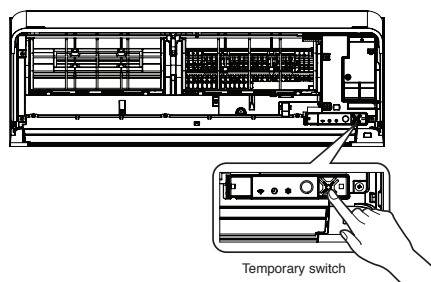

Auto Restart Setting

This product is designed so that, after a power failure, it can restart automatically in the same operating mode as before the power failure.

Information

The product was shipped with Auto Restart function in the off position. Turn it on as required.

How to set the Auto Restart

1. Press and hold the Temporary switch on the indoor unit for 3 seconds to set the operation (3 Pi sound and OPERATION lamp blink 5 time/sec for 5 seconds).
2. Press and hold the Temporary switch on the indoor unit for 3 seconds to cancel the operation (3 Pi sound but OPERATION lamp does not blink).
 - In case of ON timer or OFF timer are set, AUTO RESTART OPERATION does not activate.