

# Air conditioner

---

## User manual

AC\*\*\*MN\*DKH / AC\*\*\*MNMSEH

---

- Thank you for purchasing this Samsung air conditioner.
- Before operating this unit, please read this user manual carefully and retain it for future reference.



**SAMSUNG**

# Contents

---

<b>Safety Information</b>	<b>3</b>
Safety Information	3
<b>At a Glance</b>	<b>10</b>
Indoor Unit Overview	10
<b>Cleaning and Maintenance</b>	<b>11</b>
Cleaning the Air Conditioner	11
Cleaning the air filter	
Maintaining the Air Conditioner	15
Periodical checks	
<b>Appendix</b>	<b>17</b>
Troubleshooting	17
Operation Features	21
Technical specifications	22



**Correct Disposal of This Product  
(Waste Electrical & Electronic Equipment)**

***(Applicable in countries with separate collection systems)***

This marking on the product, accessories or literature indicates that the product and its electronic accessories (e.g. charger, headset, USB cable) should not be disposed of with other household waste at the end of their working life. To prevent possible harm to the environment or human health from uncontrolled waste disposal, please separate these items from other types of waste and recycle them responsibly to promote the sustainable reuse of material resources.

Household users should contact either the retailer where they purchased this product, or their local government office, for details of where and how they can take these items for environmentally safe recycling.

Business users should contact their supplier and check the terms and conditions of the purchase contract. This product and its electronic accessories should not be mixed with other commercial wastes for disposal.

For information on Samsung's environmental commitments and product specific regulatory obligations e.g. REACH visit:  
[samsung.com/uk/aboutsamsung/samsungelectronics/corporatecitizenship/data\\_corner.html](https://samsung.com/uk/aboutsamsung/samsungelectronics/corporatecitizenship/data_corner.html)

# Safety Information

---

Before using your new air conditioner, please read this manual thoroughly to ensure that you know how to safely and efficiently operate the extensive features and functions of your new appliance.





Because the following operating instructions cover various models, the characteristics of your air conditioner may differ slightly from those described in this manual. If you have any questions, call your nearest contact centre or find help and information online at [www.samsung.com](http://www.samsung.com).

## **WARNING**

Hazards or unsafe practices that may result in severe personal injury or death.

## **CAUTION**

Hazards or unsafe practices that may result in minor personal injury or property damage.

-  Follow directions.
-  Do NOT attempt.
-  Make sure the machine is grounded to prevent electric shock.
-  Cut-off the power supply.
-  Do NOT disassemble.

## **FOR INSTALLATION**

---

## **WARNING**

 **Use the power line with the power specifications of the product or higher and use the power line for this appliance only. In addition, do not use an extension line.**

- Extending the power line may result in electric shock or fire.
- Do not use an electric transformer. It may result in electric shock or fire.
- If the voltage/frequency/rated current condition is different, it may cause fire.

# Safety Information

---

**The installation of this appliance must be performed by a qualified technician or service company.**

- Failing to do so may result in electric shock, fire, explosion, problems with the product, or injury.

**Install a switch and circuit breaker dedicated to the air conditioner.**

- Failing to do so may result in electric shock or fire.

**Fix the outdoor unit firmly so that the electric part of the outdoor unit is not exposed.**

- Failing to do so may result in electric shock or fire.

**⊘ Do not install this appliance near a heater, inflammable material. Do not install this appliance in a humid, oily or dusty location, in a location exposed to direct sunlight and water (rain drops). Do not install this appliance in a location where gas may leak.**

- This may result in electric shock or fire.

**Never install the outdoor unit in a location such as on a high external wall where it could fall.**

- If the outdoor unit falls, it may result in injury, death or property damage.

**⚡ This appliance must be properly grounded. Do not ground the appliance to a gas pipe, plastic water pipe, or telephone line.**

- Failure to do so may result in electric shock, fire, an explosion, or other problems with the product.
- Never plug the power cord into a socket that is not grounded correctly and make sure that it is in accordance with local and national codes.

---

**⚠ CAUTION****❗ Install your appliance on a level and hard floor that can support its weight.**

- Failing to do so may result in abnormal vibrations, noise, or problems with the product.

**Install the draining hose properly so that water is drained correctly.**

- Failing to do so may result in water overflowing and property damage. Avoid adding drain to waste pipes as odours may arise in the future.

**When installing the outdoor unit, make sure to connect the draining hose so that draining is performed correctly.**

- The water generated during the heating operation by the outdoor unit may overflow and result in property damage. In particular, in winter, if a block of ice falls, it may result in injury, death or property damage.

---

**FOR POWER SUPPLY**

---

**⚠ WARNING****❗ When the circuit breaker is damaged, contact your nearest service centre.**

- ⊘ **Do not pull or excessively bend the power line. Do not twist or tie the power line. Do not hook the power line over a metal object, place a heavy object on the power line, insert the power line between objects, or push the power line into the space behind the appliance.**

- This may result in electric shock or fire.

**⚠ CAUTION****⚡ When not using the air conditioner for a long period of time or during a thunder/lightning storm, cut the power at the circuit breaker.**

- Failing to do so may result in electric shock or fire.

# Safety Information

---

## FOR USING

---

### **WARNING**

#### **If the appliance is flooded, please contact your nearest service centre.**

- Failing to do so may result in electric shock or fire.

**If the appliance generates a strange noise, a burning smell or smoke, unplug the power plug immediately and contact your nearest service centre.**

- Failing to do so may result in electric shock or fire.

**In the event of a gas leak (such as propane gas, LP gas, etc.), ventilate immediately without touching the power line. Do not touch the appliance or power line.**

- Do not use a ventilating fan.
- A spark may result in an explosion or fire.

**To reinstall the air conditioner, please contact your nearest service centre.**

- Failing to do so may result in problems with the product, water leakage, electric shock, or fire.
- A delivery service for the product is not provided. If you reinstall the product in another location, additional construction expenses and an installation fee will be charged.
- Especially, when you wish to install the product in an unusual location such as in an industrial area or near the seaside where it is exposed to the salt in the air, please contact your nearest service centre.

#### **Do not touch the circuit breaker with wet hands.**

- This may result in electric shock.

**Do not turn the air conditioner off with the circuit breaker while it is operating.**

- Turning the air conditioner off and then on again with the circuit breaker may cause a spark and result in electric shock or fire.

---

**After unpacking the air conditioner, keep all packaging materials well out of the reach of children, as packaging materials can be dangerous to children.**

- If a child places a bag over its head, it may result in suffocation.

**Do not touch the front panel with your hands or fingers during the heating operation.**

- This may result in electric shock or burns.

**Do not insert your fingers or foreign substances into the outlet when the air conditioner is operating or the front panel is closing.**

- Take special care that children do not injure themselves by inserting their fingers into the product.

**Do not insert your fingers or foreign substances into the air inlet/outlet of the air conditioner.**

- Take special care that children do not injure themselves by inserting their fingers into the product.

**Do not strike or pull the air conditioner with excessive force.**

- This may result in fire, injury, or problems with the product.

**Do not place an object near the outdoor unit that allows children to climb onto the machine.**

- This may result in children seriously injuring themselves.

**Do not use this air conditioner for long periods of time in badly ventilated locations or near infirm people.**

- Since this may be dangerous due to a lack of oxygen, open a window at least once an hour.

 **If any foreign substance such as water has entered the appliance, cut the power by unplugging the power plug and turning the circuit breaker off and then contact your nearest service centre.**

- Failing to do so may result in electric shock or fire.

 **Do not attempt to repair, disassemble, or modify the appliance yourself.**

- Do not use any fuse (such as copper, steel wire, etc.) other than the standard fuse.
- Failing to do so may result in electric shock, fire, problems with the product, or injury.

# Safety Information

---

## CAUTION

### Do not place objects or devices under the indoor unit.

- Water dripping from the indoor unit may result in fire or property damage.

**Check that the installation frame of the outdoor unit is not broken at least once a year.**

- Failing to do so may result in injury, death or property damage.

**Max current is measured according to IEC standard for safety and current is measured according to ISO standard for energy efficiency.**

### Do not stand on top of the appliance or place objects (such as laundry, lighted candles, lighted cigarettes, dishes, chemicals, metal objects, etc.) on the appliance.

- This may result in electric shock, fire, problems with the product, or injury.

**Do not operate the appliance with wet hands.**

- This may result in electric shock.

**Do not spray volatile material such as insecticide onto the surface of the appliance.**

- As well as being harmful to humans, it may also result in electric shock, fire or problems with the product.

**Do not drink the water from the air conditioner.**

- The water may be harmful to humans.

**Do not apply a strong impact to the remote controller and do not disassemble the remote controller.**

**Do not touch the pipes connected with the product.**

- This may result in burns or injury.

**Do not use this air conditioner to preserve precision equipment, food, animals, plants or cosmetics, or for any other unusual purposes.**

- This may result in property damage.

**Avoid directly exposing humans, animals or plants from the air flow from the air conditioner for long periods of time.**

- This may result in harm to humans, animals or plants.



This appliance is not intended for use by persons (including children) with reduced physical, sensory or mental capabilities, or lack of experience and knowledge, unless they have been given supervision or instruction concerning use of the appliance by a person responsible for their safety. Children should be supervised to ensure that they do not play with the appliance.

For use in Europe: This appliance can be used by children aged from 8 years and above and persons with reduced physical, sensory or mental capabilities or lack of experience and knowledge if they have been given supervision or instruction concerning use of the appliance in a safe way and understand the hazards involved. Children shall not play with the appliance. Cleaning and user maintenance shall not be made by children without supervision.

## FOR CLEANING

---



### **WARNING**

-  **Do not clean the appliance by spraying water directly onto it. Do not use benzene, thinner, alcohol or acetone to clean the appliance.**
  - This may result in discoloration, deformation, damage, electric shock or fire.

**Before cleaning or performing maintenance, unplug the air conditioner from the wall socket and wait until the fan stops.**

- Failing to do so may result in electric shock or fire.

### **CAUTION**

-  **Take care when cleaning the surface of the heat exchanger of the outdoor unit since it has sharp edges.**
  - To avoid cutting your fingers, wear thick cotton gloves when cleaning it.
  - This should be done by a qualified technician please contact your installer or service centre.
-  **Do not clean the inside of the air conditioner by yourself.**
  - For cleaning inside the appliance, contact your nearest service centre.
  - When cleaning the internal filter, refer to the descriptions in the 'Cleaning and Maintaining' section.
  - Failure to do may result in damage, electric shock or fire.

# Indoor Unit Overview

Congratulations on the purchase of the air conditioner. We hope you enjoy the features of your air conditioner and stay cool or warm with optimal efficiency. Please read the user manual to get started and to make the best use of the air conditioner.

## SLIM DUCT TYPE

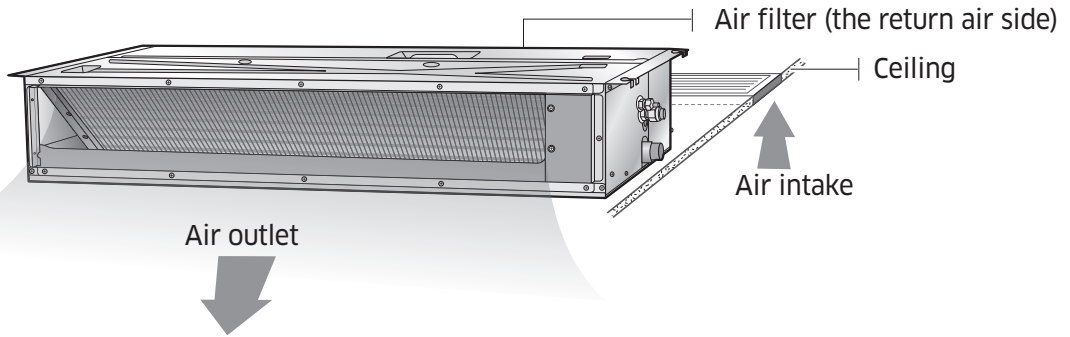

## GLOBAL DUCT TYPE

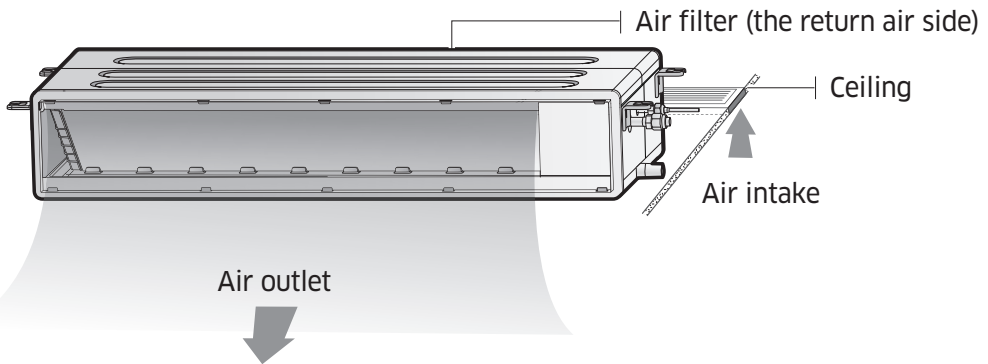

## MA DUCT TYPE

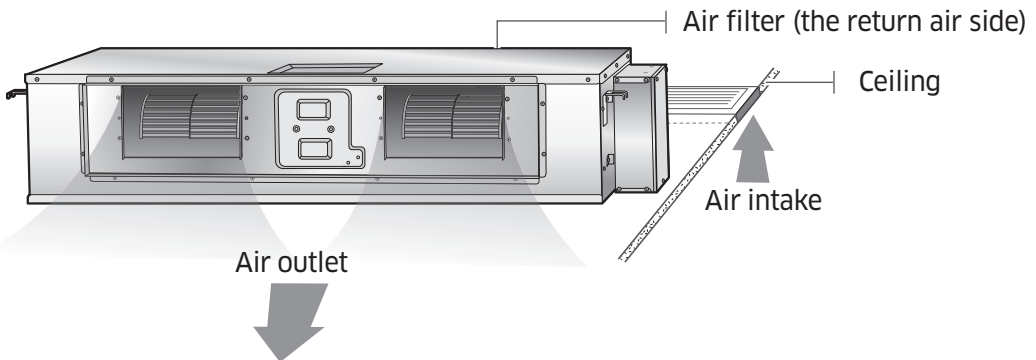

### NOTE

- Your air conditioner and display may look slightly different from the illustration shown above depending on your model.

# Cleaning the Air Conditioner

## Cleaning the air filter

For the best performance from your air conditioner, clean it periodically. When cleaning, make sure to unplug from the unit for user's safety.

When cleaning the filter, make sure to unplug the power from the unit. Washable foam based Air filter captures large particles from the air. The filter is cleaned with a vacuum or by hand washing.

### SLIM DUCT TYPE

1. Slide out the Air filter on the rear side panel to the right side.

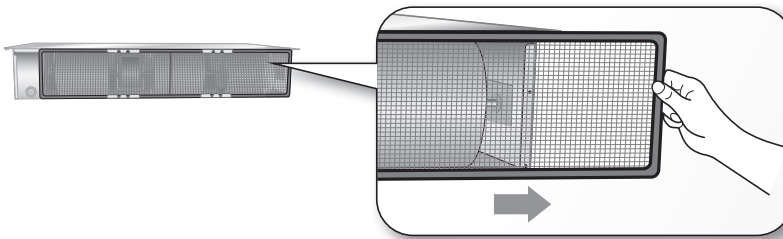

2. Clean the Air filter with a vacuum cleaner or soft brush. If dust is too heavy, then rinse it with running water and dry it in a ventilated area.

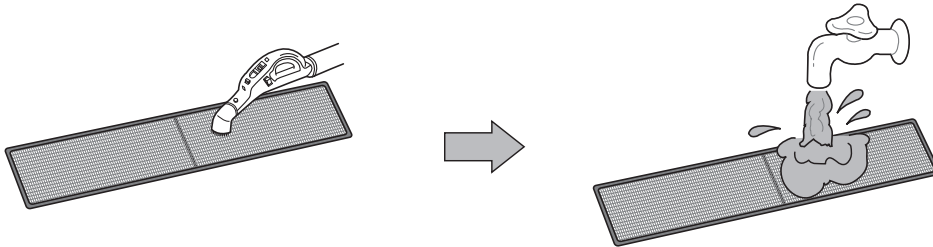

- For best conditions, repeat every two weeks.
- If the Air filter dries in a confined (or humid) area, odors may generate. If it occurs, re-clean and dry it in a ventilated area.

3. Insert the Air filter back in its original position.

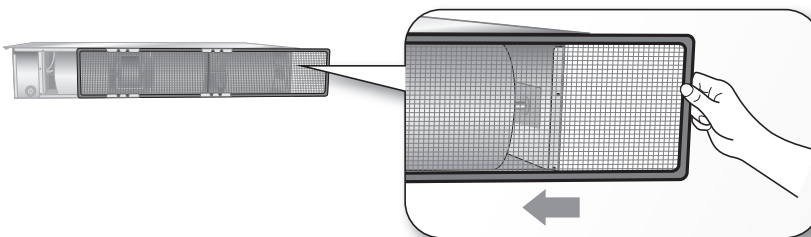

# Cleaning the Air Conditioner

## GLOBAL DUCT (Plastic Type)

1. Press both hooks and take the filter downward.

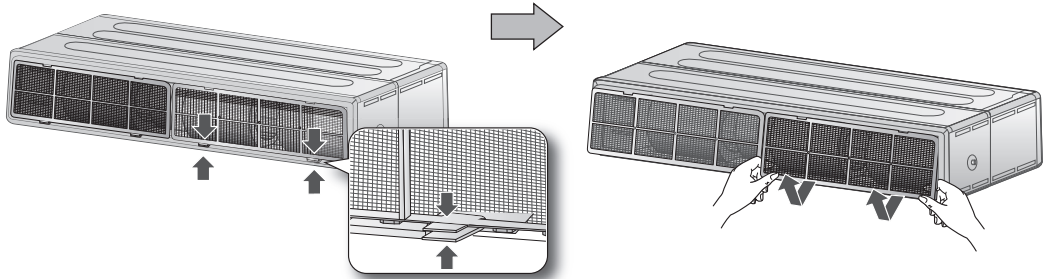

2. Clean the Air filter with a vacuum cleaner or soft brush. If dust is too heavy, then rinse it with running water and dry it in a ventilated area.

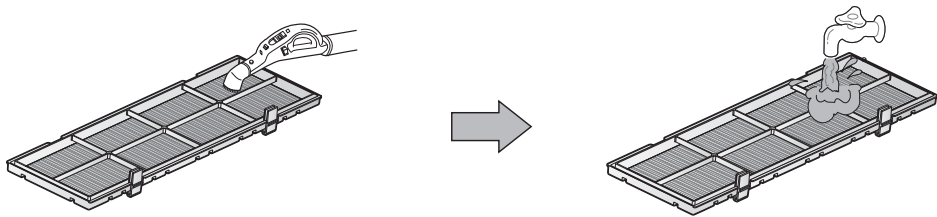

- For best conditions, repeat every two weeks.
- If the Air filter dries in a confined (or humid) area, odors may generate. If it occurs, re-clean and dry it in a ventilated area.

3. Insert the Air filter back in its original position.

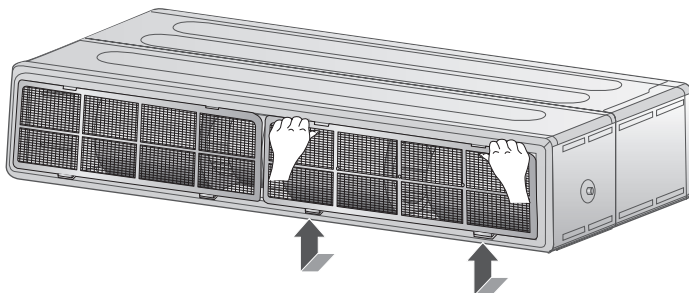

---

## GLOBAL DUCT (Steel wire Type)

1. Pull out the Air filter from the frame .

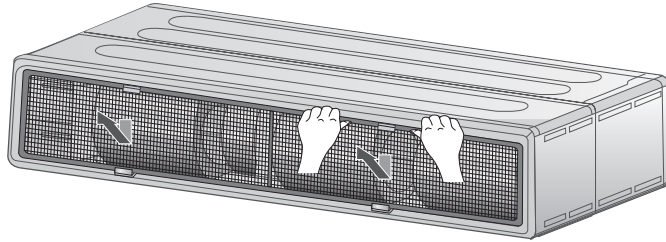

2. Clean the Air filter with a vacuum cleaner or soft brush. If dust is too heavy, then rinse it with running water and dry it in a ventilated area.

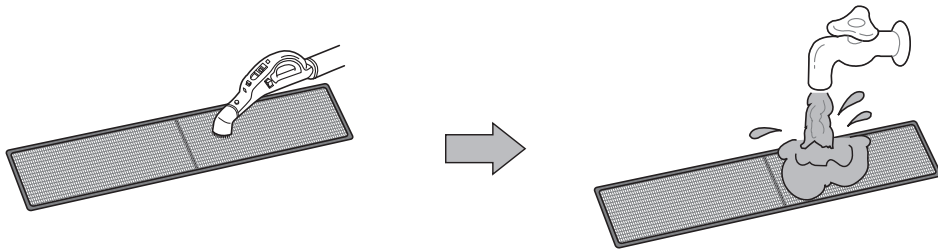

- For best conditions, repeat every two weeks.
- If the Air filter dries in a confined (or humid) area, odors may generate. If it occurs, re-clean and dry it in a ventilated area.

3. Insert the Air filter back in its original position.

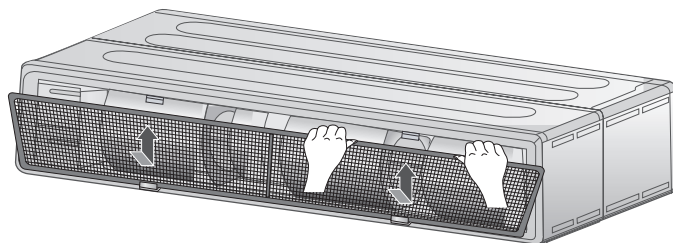

# Cleaning the Air Conditioner

## MA duct type

1. Slide out the Air filter on the rear side panel to the right side.

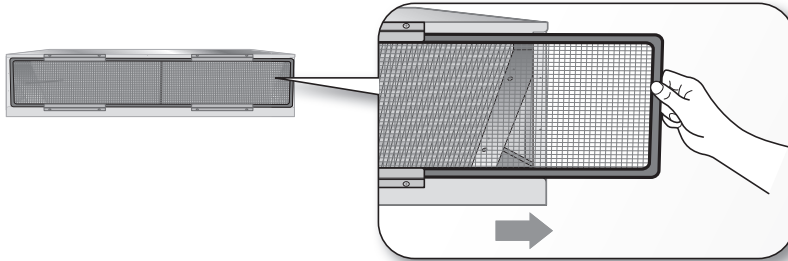

2. Clean the Air filter with a vacuum cleaner or soft brush. If dust is too heavy, then rinse it with running water and dry it in a ventilated area.

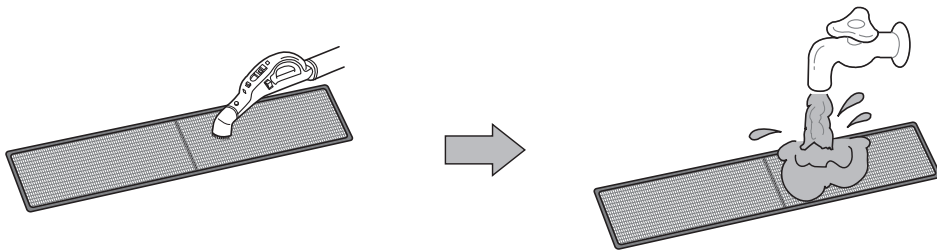

- For best conditions, repeat every two weeks.
- If the Air filter dries in a confined (or humid) area, odors may generate. If it occurs, re-clean and dry it in a ventilated area.

3. Insert the Air filter back in its original position.

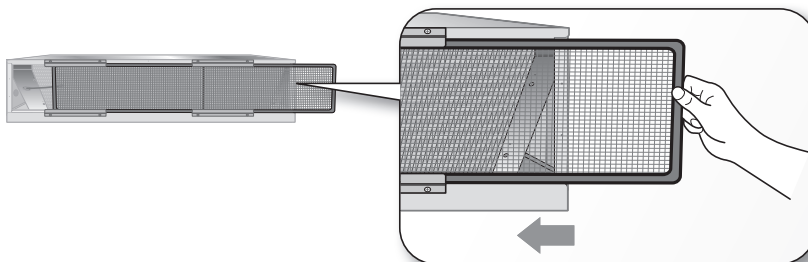

### NOTE

- The illustration shown above may differ from yours depending on your model.
- After cleaning the filter, press the **Filter Reset** button on the remote control for 2 seconds to reset the filter schedule. Filter sign indicator will be on for cleaning time.

# Maintaining the Air Conditioner

If the air conditioner will not be used for an extended period of time, dry the air conditioner to maintain in best conditions.

1. Dry the air conditioner thoroughly by operating in Fan mode for 3 to 4 hours and disconnect the power plug. There may be internal damage if moisture is left in components.
2. Before using the air conditioner again, dry the inner components of the air conditioner again by running in Fan mode for 3 to 4 hours. This helps remove odours that may have generated from dampness.

## Periodical checks

Refer to the following chart to maintain the air conditioner properly.

Type	Description	Monthly	Every 4 months	Once a year
Indoor unit	Clean the air filter (1).	●		
	Clean the condensate drain pan (2).			●
	Thoroughly clean the heat exchanger (2).			●
	Clean the condensate drain pipe (2).		●	
	Replace the remote control batteries (1).			●
Outdoor unit	Clean the heat exchanger on the outside of the unit (2).		●	
	Clean the heat exchanger on the inside of the unit (2).			●
	Clean the electric components with jets of air (2).			●
	Verify that all the electric components are firmly tightened (2).			●
	Clean the fan (2).			●
	Verify that all the fan assembly is firmly tightened (2).			●
	Clean the condensate drain pan (2).			●

### NOTE

- The checks and maintenance operations described above are essential to guarantee the efficiency of the air conditioner. The frequency of these operations may vary depending on the characteristics of the area, the amount of dust, etc.
  - a. The above mentioned operations should be performed more frequently if the area of installation is very dusty.
  - b. These operations must always be performed by qualified personnel. For more detailed information, refer to Installation Manual.

# Maintaining the Air Conditioner

---

## Internal protections via the unit control system

This internal protection operates if an internal fault occurs in the air conditioner.

Type	Description
Against cold air	The internal fan will be off against cold air when the heat pump is heating.
De-ice cycle	The internal fan will be off against cold air when the heat pump is heating.
Anti-protection of internal battery	The compressor will be off to protect internal battery when the air conditioner operates in Cool mode.
Protect compressor	The air conditioner does not start operating immediately to protect the compressor of the outdoor unit after it has been started.



### NOTE

- If the heat pump is operating in Heat mode, the de-ice cycle is actuated to remove frost from an outdoor unit that may have deposited at low temperatures.
- The internal fan is switched off automatically and restarted only after the de-ice cycle is completed.
- When the de-ice cycle is operating, it may generate strange sound. It is normal operation for product safety.







# Troubleshooting

Refer to the following chart if the air conditioner operates abnormally. This may save time and unnecessary expense.

Problem	Solution
<p>The air conditioner does not operate at all.</p>	<ul style="list-style-type: none"> <li>• Check if the power plug is properly connected.</li> <li>• Check whether the auxiliary power switch (MCCB, ELB) is turned on.</li> <li>• If the auxiliary power switch (MCCB, ELB) is turned off, the air conditioner does not work although you press the  (Power) button.</li> <li>• When you clean the air conditioner or do not use it for an extended period of time, turn off the auxiliary power switch (MCCB, ELB).</li> <li>• After the air conditioner is not used for an extended period of time, be sure to turn on the auxiliary power switch (MCCB, ELB) 6 hours before starting operation.</li> </ul> <p> <b>NOTE</b></p> <ul style="list-style-type: none"> <li>• The auxiliary power switch (MCCB, ELB) is sold separately.</li> <li>• Make sure that auxiliary power switch (MCCB, ELB) is installed in the distribution box inside the building.</li> </ul> <ul style="list-style-type: none"> <li>• If the air conditioner is turned off by the Timed off function, turn on the air conditioner again by pressing the  (Power) button.</li> </ul>
<p>The temperature does not change.</p>	<ul style="list-style-type: none"> <li>• Check whether the Fan mode is running. In the Fan mode, the air conditioner controls the set temperature automatically, and you cannot change the set temperature.</li> </ul>
<p>Warm air does not come out of the air conditioner.</p>	<ul style="list-style-type: none"> <li>• Check whether the outdoor unit is designed for cooling only. In this case, warm air does not come out although you select the Heat mode.</li> <li>• Check whether the remote control is designed only for cooling only. Use a remote control that supports both cooling and heating.</li> </ul>
<p>The fan speed does not change.</p>	<ul style="list-style-type: none"> <li>• Check whether the Auto or Dry mode is running. In these modes, the air conditioner controls the fan speed automatically, and you cannot change the fan speed.</li> </ul>
<p>The wireless remote control does not operate.</p>	<ul style="list-style-type: none"> <li>• Check whether the batteries are discharged. Replace the batteries with new ones.</li> <li>• Make sure that nothing is blocking the remote control sensor.</li> <li>• Check whether any strong lighting sources are near the air conditioner. Strong light which comes from fluorescent bulbs or neon signs may interfere with the remote control.</li> </ul>

# Troubleshooting

Problem	Solution
The wired remote control does not operate.	<ul style="list-style-type: none"> <li>Check whether the  indicator is displayed at the bottom right of the remote control display. In this case, turn off both the air conditioner and the auxiliary power switch, and then contact a service centre.</li> </ul>
The air conditioner is not turned on or off immediately with the wired remote control.	<ul style="list-style-type: none"> <li>Check whether the wired remote control is set for group control. In this case, the air conditioners connected to the wired remote control are turned on or off sequentially. This operation takes up to 32 seconds.</li> </ul>
The Timed on/off function does not operate.	<ul style="list-style-type: none"> <li>Check whether you pressed the  (SET) button on the remote control after setting the on/off time. Set the on/off time.</li> </ul>
The indoor unit display blinks continuously.	<ul style="list-style-type: none"> <li>Turn on the air conditioner again by pressing the  (Power) button.</li> <li>Turn off and then turn on the auxiliary power switch, and then turn on the conditioner.</li> <li>If the indoor unit display is still blinking, contact a service centre.</li> </ul>
I want to get cooler air.	<ul style="list-style-type: none"> <li>Operate the air conditioner with a electric fan to save energy and enhance the cooling efficiency.</li> </ul>
The air is not cool or warm enough.	<ul style="list-style-type: none"> <li>In the Cool mode, cool air does not come out if the set temperature is higher than the current temperature.               <ul style="list-style-type: none"> <li>MR-EH00 remote control: Press the Temperature button repeatedly until the set temperature (minimum: 18°C) is set to lower than the current temperature.</li> <li>AR-KH00E remote control: Press the Temperature button on the remote control. Then rotate the Wheel until the set temperature (minimum: 18°C) is set to lower than the current temperature.</li> </ul> </li> <li>In the Heat mode, warm air does not come out if the set temperature is lower than the current temperature.               <ul style="list-style-type: none"> <li>MR-EH00 remote control: Press the Temperature button repeatedly until the set temperature (maximum: 30°C) is set to higher than the current temperature.</li> <li>AR-KH00E remote control: Press the Temperature button on the remote control. Then rotate the Wheel until the set temperature (maximum: 30°C) is set to higher than the current temperature.</li> </ul> </li> </ul>

Problem	Solution
<p>The air is not cool or warm enough.</p>	<ul style="list-style-type: none"> <li>• Both cooling and heating do not operate in the Fan mode. Select the Cool, Heat, Auto, or Dry mode.</li> <li>• Check whether the air filter is blocked with dirt. A dusty filter may decrease the cooling and heating efficiencies. Clean the air filter frequently.</li> <li>• If a cover is on the outdoor unit or any obstacle is present near the outdoor unit, remove them.</li> <li>• Install the outdoor unit in a well-ventilated place. Avoiding places exposed to direct sunlight or close to a heating appliance.</li> <li>• Place a sunscreen over the outdoor unit to protect it from direct sunlight.</li> <li>• If the indoor unit is installed in a place exposed to direct sunlight, pull the curtains on the windows.</li> <li>• Close the windows and doors to maximize the cooling and heating efficiencies.</li> <li>• If the Cool mode is stopped and then started immediately, cool air comes out after about 3 minutes to protect the compressor of the outdoor unit.</li> <li>• When the Heat mode is started, warm air does not come out immediately to prevent cool air from coming out at the beginning.</li> <li>• If the refrigerant pipe is too long, the cooling and heating efficiencies may be decreased. Avoid exceeding the maximum pipe length.</li> </ul>
<p>The air conditioner makes strange noises.</p>	<ul style="list-style-type: none"> <li>• In certain conditions (especially, when the outdoor temperature is lower than 20°C), a hissing, rumbling, or splashing sound may be heard while the refrigerant is circulating through the air conditioner. This is a normal operation.</li> <li>• When you press the  (Power) button on the remote control, noise may be heard from the drain pump inside the air conditioner. This noise is a normal sound.</li> </ul>
<p>Unpleasant odours permeate the room.</p>	<ul style="list-style-type: none"> <li>• If the air conditioner is running in a smoky area or if there is a smell entering from outside, ventilate the room properly.</li> <li>• If both indoor temperature and indoor humidity are high, operate the air conditioner in the Clean or Fan mode for 1 to 2 hours.</li> <li>• If the air conditioner has not been operated for an extended period of time, clean the indoor unit and then operate the air conditioner in the Fan mode for 3 to 4 hours to dry the inside of the indoor unit for removal of unpleasant odours.</li> <li>• If the air filter blocked with dirt, clean the air filter.</li> </ul>

# Troubleshooting

---

Problem	Solution
Steam is produced on the indoor unit.	<ul style="list-style-type: none"><li>• In winter, if the indoor humidity is high, steam may be produced around the air outlet while the defrost function is running. This is a normal operation.</li></ul>
The outdoor unit fan continues to operate when the air conditioner is turned off.	<ul style="list-style-type: none"><li>• When the air conditioner is turned off, the outdoor unit fan may continue to operate to reduce noise of the refrigerant gas. This is a normal operation.</li></ul>
Water drops from the piping connections of the outdoor unit.	<ul style="list-style-type: none"><li>• Condensation may develop due to the difference in temperature. This is a normal condition.</li></ul>
Steam is produced on the outdoor unit.	<ul style="list-style-type: none"><li>• In winter, when the air conditioner runs in the Heat mode, the frost on the heat exchanger melts and steam may be produced. This is a normal operation, neither product malfunction nor a fire.</li></ul>

# Operation Features

---

## Operating temperature and humidity

---

Mode	Outdoor temperature	Indoor temperature	Indoor humidity
Cool mode	-15°C to 50°C	18°C to 32°C	80% or less
Heat mode	-20°C to 24°C	30°C or less	-
Dry mode	-15°C to 50°C	18°C to 32°C	80% or less

### CAUTION

- If you use the air conditioner at a relative humidity above 80%, it may cause a formation of condensation and a leakage of water on the floor.

# Technical specifications

Type	Model	Net weight (kg)	Net dimension (W x D x H) (mm)
Indoor unit	AC026MNLDKH/EU	19.4	700 x 600 x 199
	AC035MNLDKH/EU	19.4	700 x 600 x 199
	AC052MNLDKH/EU	23.4	1100 x 450 x 200
	AC071MNLDKH/EU	23.4	1100 x 450 x 200
	AC035MNMDKH/EU	25.8	850 x 700 x 250
	AC052MNMDKH/EU	25.8	850 x 700 x 250
	AC060MNMDKH/EU	25.8	850 x 700 x 250
	AC071MNMDKH/EU	25.8	850 x 700 x 250
	AC090MNMDKH/EU	33.4	1200 x 700 x 250
	AC100MNMDKH/EU	33.4	1200 x 700 x 250
	AC120MNMDKH/EU	38.6	1300 x 700 x 300
	AC140MNMDKH/EU	38.6	1300 x 700 x 300
	AC052MNMSEH/EU	30.0	1150 x 480 x 260
	AC071MNMSEH/EU	30.0	1150 x 480 x 260
	AC100MNMSEH/EU	33.0	1150 x 480 x 320
	AC120MNMSEH/EU	47.8	1200 x 650 x 360



## QUESTIONS OR COMMENTS?

COUNTRY	CALL	OR VISIT US ONLINE AT
UK	0330 SAMSUNG (7267864)	<a href="http://www.samsung.com/uk/support">www.samsung.com/uk/support</a>
EIRE	0818 717100	<a href="http://www.samsung.com/ie/support">www.samsung.com/ie/support</a>
GERMANY	"0180 6 SAMSUNG bzw. 0180 6 7267864" (*0,20 €/Anruf aus dem dt. Festnetz, aus dem Mobilfunk max. 0,60 €/Anruf) [HHP] 0180 6 M SAMSUNG bzw. 0180 6 67267864* (*0,20 €/Anruf aus dem dt. Festnetz, aus dem Mobilfunk max. 0,60 €/Anruf)"	<a href="http://www.samsung.com/de/support">www.samsung.com/de/support</a>
FRANCE	01 48 63 00 00	<a href="http://www.samsung.com/fr/support">www.samsung.com/fr/support</a>
ITALIA	800-SAMSUNG (800.7267864)	<a href="http://www.samsung.com/it/support">www.samsung.com/it/support</a>
SPAIN	"0034902172678 [HHP] 0034902167267"	<a href="http://www.samsung.com/es/support">www.samsung.com/es/support</a>
PORTUGAL	808 20 7267	<a href="http://www.samsung.com/pt/support">www.samsung.com/pt/support</a>
LUXEMBURG	261 03 710	<a href="http://www.samsung.com/be_fr/support">www.samsung.com/be_fr/support</a>
NETHERLANDS	0900-SAMSUNG (0900-7267864) (€ 0,10/Min)	<a href="http://www.samsung.com/nl/support">www.samsung.com/nl/support</a>
BELGIUM	02-201-24-18	" <a href="http://www.samsung.com/be/support">www.samsung.com/be/support</a> (Dutch) <a href="http://www.samsung.com/be_fr/support">www.samsung.com/be_fr/support</a> (French)"
NORWAY	815 56480	<a href="http://www.samsung.com/no/support">www.samsung.com/no/support</a>
DENMARK	70 70 19 70	<a href="http://www.samsung.com/dk/support">www.samsung.com/dk/support</a>
FINLAND	030-6227 515	<a href="http://www.samsung.com/fi/support">www.samsung.com/fi/support</a>
SWEDEN	0771 726 7864 (0771-SAMSUNG)	<a href="http://www.samsung.com/se/support">www.samsung.com/se/support</a>
POLAND	"801-172-678* lub +48 22 607-93-33* Dedykowana infolinia do obsługi zapytań dotyczących telefonów komórkowych: 801-672-678* lub +48 22 607-93-33* * (koszt połączenia według taryfy operatora)"	<a href="http://www.samsung.com/pl/support">www.samsung.com/pl/support</a>

COUNTRY	CALL	OR VISIT US ONLINE AT
HUNGARY	"0680SAMSUNG (0680-726-786) 0680PREMIUM (0680-773-648)"	<a href="http://www.samsung.com/hu/support">www.samsung.com/hu/support</a>
AUSTRIA	"0800-SAMSUNG (0800-7267864) [Only for Premium HA] 0800-366661 [Only for Dealers] 0810-112233"	<a href="http://www.samsung.com/at/support">www.samsung.com/at/support</a>
SWITZERLAND	0800 726 78 64 (0800-SAMSUNG)	" <a href="http://www.samsung.com/ch/support">www.samsung.com/ch/support</a> (German) <a href="http://www.samsung.com/ch_fr/support">www.samsung.com/ch_fr/support</a> (French)"
CZECH	"800 - SAMSUNG (800-726786)"	<a href="http://www.samsung.com/cz/support">www.samsung.com/cz/support</a>
SLOVAKIA	"0800 - SAMSUNG (0800-726 786)"	<a href="http://www.samsung.com/sk/support">www.samsung.com/sk/support</a>
CROATIA	072 726 786	<a href="http://www.samsung.com/hr/support">www.samsung.com/hr/support</a>
BOSNIA	055 233 999	<a href="http://www.samsung.com/support">www.samsung.com/support</a>
MONTENEGRO	020 405 888	<a href="http://www.samsung.com/support">www.samsung.com/support</a>
SLOVENIA	080 697 267 (brezplačna številka)	<a href="http://www.samsung.com/si">www.samsung.com/si</a>
SERBIA	011 321 6899	<a href="http://www.samsung.com/rs/support">www.samsung.com/rs/support</a>
BULGARIA	*3000 Цена в мрежата 0800 111 31 . Безплатна телефонна линия	<a href="http://www.samsung.com/bg/support">www.samsung.com/bg/support</a>
ROMANIA	"*8000 (apel in retea) 08008-726-78-64 (08008-SAMSUNG) Apel GRATUIT"	<a href="http://www.samsung.com/ro/support">www.samsung.com/ro/support</a>
CYPRUS	8009 4000 only from landline, toll free	<a href="http://www.samsung.com/gr/support">www.samsung.com/gr/support</a>
GREECE	"80111-SAMSUNG (80111 726 7864) only from land line (+30) 210 6897691 from mobile and land line"	<a href="http://www.samsung.com/gr/support">www.samsung.com/gr/support</a>
LITHUANIA	8-800-77777	<a href="http://www.samsung.com/lt/support">www.samsung.com/lt/support</a>
LATVIA	8000-7267	<a href="http://www.samsung.com/lv/support">www.samsung.com/lv/support</a>
ESTONIA	800-7267	<a href="http://www.samsung.com/ee/support">www.samsung.com/ee/support</a>

