

# Air conditioner

---

## User manual

AC\*\*\*RNADKG / AC\*\*\*RNTDKG

---

- Thank you for purchasing this Samsung air conditioner.
- Before operating this unit, please read this user manual carefully and retain it for future reference.



DB68-08134A-02

**SAMSUNG**

# Contents

---

<b>Safety Information</b>	<b>4</b>
Safety Information	4
<b>At a Glance</b>	<b>13</b>
Indoor Unit Overview	13
Main parts • Display	
Remote Control Overview	15
Replacing batteries • Storing the remote control	
<b>Basic Operation</b>	<b>17</b>
Operation Modes	17
Auto • Cool • Dry • Fan • Heat • Turning the air conditioner on • Selecting the operation mode	
Adjusting the temperature • Selecting the fan speed • Selecting air flow direction	
<b>Advanced Operation</b>	<b>21</b>
Setting the On or Off timer	21
Setting the On timer • Setting the Off timer	
Setting the good'sleep Function	23
Using the good'sleep Function	24
Using the Turbo Function	25
Using the Purity Function	26
Controlling Indoor Units	28
<b>Cleaning and Maintenance</b>	<b>29</b>
Cleaning the Air Conditioner	29
Cleaning the exterior • Cleaning the filter	
Maintaining the Air Conditioner	32
<b>Appendix</b>	<b>34</b>
Troubleshooting	34
Operation Ranges	38
Technical specifications	39
Information about refrigerant	39
Important information: regulation regarding the refrigerant used	



***Correct Disposal of This Product  
(Waste Electrical & Electronic Equipment)***

***(Applicable in countries with separate collection systems)***

This marking on the product, accessories or literature indicates that the product and its electronic accessories (e.g. charger, headset, USB cable) should not be disposed of with other household waste at the end of their working life. To prevent possible harm to the environment or human health from uncontrolled waste disposal, please separate these items from other types of waste and recycle them responsibly to promote the sustainable reuse of material resources.

Household users should contact either the retailer where they purchased this product, or their local government office, for details of where and how they can take these items for environmentally safe recycling.

Business users should contact their supplier and check the terms and conditions of the purchase contract. This product and its electronic accessories should not be mixed with other commercial wastes for disposal.

For information on Samsung's environmental commitments and product specific regulatory obligations e.g. REACH, WEEE, Batteries, visit: [samsung.com/uk/aboutsamsung/samsungelectronics/corporatecitizenship/data\\_corner.html](https://samsung.com/uk/aboutsamsung/samsungelectronics/corporatecitizenship/data_corner.html)

# Safety Information

---





Before using your new air conditioner, please read this manual thoroughly to ensure that you know how to safely and efficiently operate the extensive features and functions of your new appliance. Because the following operating instructions cover various models, the characteristics of your air conditioner may differ slightly from those described in this manual. If you have any questions, call your nearest contact centre or find help and information online at [www.samsung.com](http://www.samsung.com).

## **WARNING**

Hazards or unsafe practices that may result in severe personal injury or death.

## **CAUTION**

Hazards or unsafe practices that may result in minor personal injury or property damage.

-  Follow directions.
-  Do NOT attempt.
-  Make sure the machine is grounded to prevent electric shock.
-  Cut off the power supply.
-  Do NOT disassemble.

## FOR INSTALLATION

---

### **WARNING**

-  **Use a power cord with this product's power specifications or higher and use the power cord for this appliance only. In addition, do not use an extension cord.**

- Extending the power cord may result in electric shock or fire.
- Do not use an electric transformer. This may result in electric shock or fire.
- If the voltage/frequency/rated current condition is different, it may cause fire.



---

**The installation of this appliance must be performed by a qualified technician or service company.**

- Failing to do so may result in electric shock, fire, explosion, problems with the product, or injury and may also void warranty on the installed product.

**Install an Isolation Switch next to the Air Conditioner (but not on the panels of the Air Conditioner) and circuit breaker dedicated to the air conditioner.**

- Failing to do so may result in electric shock or fire.

**Fix the outdoor unit firmly so that the electric part of the outdoor unit is not exposed.**

- Failing to do so may result in electric shock, fire, explosion, or problems with the product.

 **Do not install this appliance near a heater, or inflammable material. Do not install this appliance in a humid, oily or dusty location, in a location exposed to direct sunlight and water (or rain). Do not install this appliance in a location where gas may leak.**

- This may result in electric shock or fire.

**Never install the outdoor unit in a location such as on a high external wall where it could fall.**

- If the outdoor unit falls, it may result in injury, death or property damage.

 **This appliance must be properly grounded. Do not ground the appliance to a gas pipe, plastic water pipe, or telephone line.**

- Failing to do so may result in electric shock, fire, and explosion.
- Make sure to use a socket-outlet with ground.

# Safety Information

---

## CAUTION

- !** Please cover the air conditioner with PE BAG after installation, and remove it when you start to run air conditioner.

**Install your appliance on a level and hard floor that can support its weight.**

- Failing to do so may result in abnormal vibrations, noise, or problems with the product.

**Install the drain hose properly so that water drains correctly.**

- Failing to do so may result in water overflowing and property damage. Avoid adding drain to waste pipes as odours may arise in the future.

**The product shall be stored in a room with no ignition sources (e.g. open flames, gas appliance, electric heater, etc.).**

- Note that the refrigerant has no odour.

**When installing the outdoor unit, make sure to connect the drain hose so that draining is performed correctly.**

- The water generated during heating by the outdoor unit may overflow and result in property damage.  
In particular, in winter, if a block of ice falls, it may result in injury, death or property damage.

## FOR POWER SUPPLY

---

### WARNING

- !** When the circuit breaker is damaged, contact your nearest service centre.
- ⊘** Do not pull or excessively bend the power line. Do not twist or tie the power line. Do not hook the power line over a metal object, place a heavy object on the power line, insert the

---

**power line between objects, or push the power line into the space behind the appliance.**

- This may result in electric shock or fire.



### **CAUTION**



**When not using the air conditioner for a long period of time or during a thunder/lightning storm, cut the power at the circuit breaker.**

- Failing to do so may result in electric shock or fire.

## **FOR USING**

---



### **WARNING**



**If the appliance is flooded, please contact your nearest service centre.**

- Failing to do so may result in electric shock or fire.

**If the appliance generates a strange noise, a burning smell or smoke, cut off the power supply immediately and contact the nearest service centre.**

- Failing to do so may result in electric shock or fire.

**In case of a malfunction, immediately stop operation of the air conditioner and disconnect the entire power system. Then consult the authorized service personnel.**

**In the event of a gas leak (such as propane gas, LP gas, etc.), ventilate immediately without touching the power line. Do not touch the appliance or power line.**

- Do not use a ventilating fan.
- A spark may result in an explosion or fire.

# Safety Information

---

**To reinstall the air conditioner, please contact your nearest service centre.**

- Failing to do so may result in problems with the product, water leakage, electric shock, or fire.
- Delivery service for the product is not provided. If you reinstall the product in another location, additional construction expenses and an installation fee will be charged.
- Especially, when you wish to install the product in an unusual location such as in an industrial area or near the seaside where it is exposed to salt in the air, please contact your nearest service centre.
- In the event of a service issue, please refer to the troubleshooting guide of the relevant supporting technical manuals. It is recommended that a skilled service technician be contacted for support. Should urgent support be required then, using the information provided, contact the local Samsung office via email or telephone so that support can be initiated via our approved service centres (ASC'S) within 24hrs.

**⊘ Do not touch the circuit breaker with wet hands.**

- This may result in electric shock.

**Do not turn the air conditioner off with the circuit breaker while it is operating.**

- Turning the air conditioner off and then on again with the circuit breaker may cause a spark and result in electric shock or fire.

**After unpacking the air conditioner, keep all packaging materials well out of the reach of children, as packaging materials can be dangerous to children.**

- If a child places a bag over its head, it may result in suffocation.

---

**Do not touch the air flow blade with your hands or fingers during heating.**

- This may result in electric shock or burns.

**Do not insert your fingers or foreign substances into the air inlet/outlet of the air conditioner.**

- Take special care that children do not injure themselves by inserting their fingers into the product.

**Do not strike or pull the air conditioner with excessive force.**

- This may result in fire, injury, or problems with the product.

**Do not place an object near the outdoor unit that allows children to climb onto the machine.**

- This may result in children seriously injuring themselves.

**Do not use this air conditioner for long periods of time in badly ventilated locations or near infirm people.**

- Since this may be dangerous due to a lack of oxygen, open a window at least once an hour.

**Do not use means to accelerate the defrost operation or to clean, other than those recommended by Samsung.**

**Do not pierce or burn.**

**Be aware that refrigerants may not contain an odour.**



**If any foreign substance such as water has entered the appliance, cut off the power supply and contact the nearest service centre.**

- Failing to do so may result in electric shock or fire.



**Do not attempt to repair, disassemble, or modify the appliance yourself.**

- Do not use any fuse (such as cooper, steel wire, etc.) other than the standard fuse.

# Safety Information

---

- Failing to do so may result in electric shock, fire, problems with the product, or injury.



## CAUTION



### **Do not place objects or devices under the indoor unit.**

- Water dripping from the indoor unit may result in fire or property damage.

### **Check that the installation frame of the outdoor unit is not broken at least once a year.**

- Failing to do so may result in injury, death or property damage.

**Max current is measured according to IEC standard for safety and current is measured according to ISO standard for energy efficiency.**

**When the air conditioner does not operate properly for cooling or heating, there is a possibility of refrigerant leakage. If any leakage, stop operation, ventilate the room, and consult your dealer immediately for recharging refrigerant.**

**The refrigerant is not harmful. However, if it comes in contact with fire, it may generate harmful gases and there is risk of fire.**

**During transportation of the indoor unit, the pipe lines shall be covered with brackets for protection. Do not move the product with holding the pipe lines.**

- It may cause gas leakage.



**Do not stand on top of the appliance or place objects (such as laundry, lighted candles, lighted cigarettes, dishes, chemicals, metal objects, etc.) on the appliance.**

- This may result in electric shock, fire, problems with the product, or injury.

---

**Do not operate the appliance with wet hands.**

- This may result in electric shock.

**Do not spray volatile material such as insecticide onto the surface of the appliance.**

- As well as being harmful to humans, it may also result in electric shock, fire or problems with the product.

**Do not drink the water from the air conditioner.**

- The water may be harmful to humans.

**Do not apply a strong impact to the remote control and do not disassemble the remote control.**

**Do not touch the pipes connected with the product.**

- This may result in burns or injury.

**Do not cut or burn the refrigerant container or pipings.**

**Do not point the air direction to the fireplace or heater.**

**Do not use this air conditioner to preserve precision equipment, food, animals, plants or cosmetics, or for any other unusual purposes.**

- This may result in property damage.

**Avoid directly exposing humans, animals or plants to the air flow from the air conditioner for long periods of time.**

- This may result in harm to humans, animals or plants.

**This appliance is not intended for use by persons (including children) with reduced physical, sensory or mental capabilities, or lack of experience and knowledge, without supervision or instruction concerning use of the appliance by a person responsible for their safety. Children should be supervised to ensure that they do not play with the appliance.**



# Safety Information

---

For use in Europe : This appliance can be used by children aged from 8 years and above and persons with reduced physical, sensory or mental capabilities or lack of experience and knowledge if they have been given supervision or instruction concerning use of the appliance in a safe way and understand the hazards involved. Children shall not play with the appliance. Cleaning and user maintenance shall not be made by children without supervision.

## FOR CLEANING

---



### WARNING



**Do not clean the appliance by spraying water directly onto it. Do not use benzene, thinner or alcohol to clean the appliance.**

- This may result in discolouration, deformation, damage, electric shock or fire.

**Before cleaning or performing maintenance, cut off the power supply and wait until the fan stops.**

- Failing to do so may result in electric shock or fire.



### CAUTION



**Take care when cleaning the surface of the heat exchanger of the outdoor unit since it has sharp edges.**

- This should be done by a qualified technician. Please contact your installer or service centre.



**Do not clean the inside of the air conditioner by yourself.**

- For cleaning inside the appliance, contact your nearest service centre.
- When cleaning the filter, refer to the descriptions in the 'Cleaning at a Glance' section.
- Failing to do so may result in damage, electric shock or fire.
- Make sure to prevent any injury from sharp edges of the surface when handling the heat exchanger.

# Indoor Unit Overview

The actual product may differ slightly from the image depicted below.

## AC\*\*\*RNADKG

### Main parts

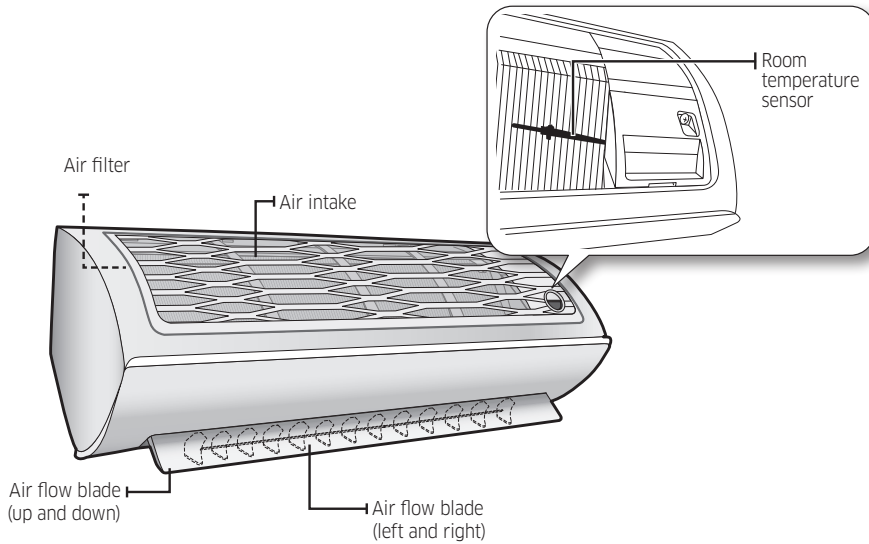

### Display

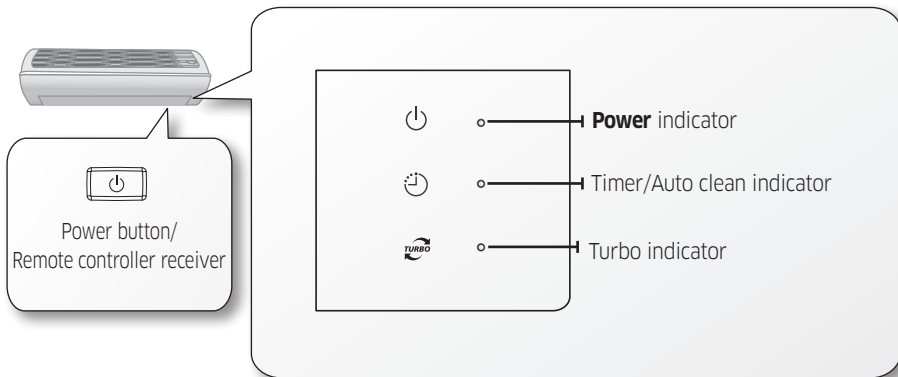

# Indoor Unit Overview

AC\*\*\*RNTDKG

## Main parts

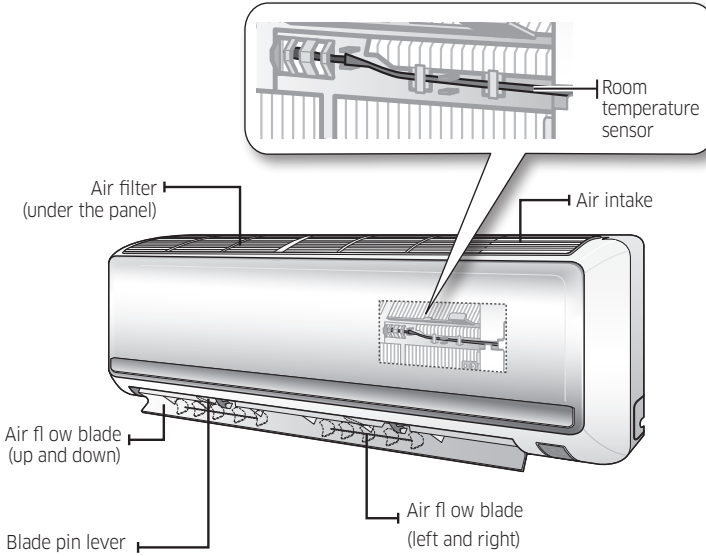

## Display

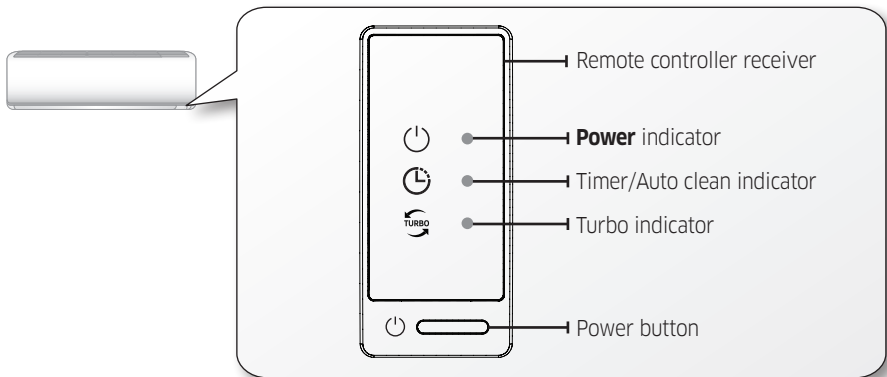

At a Glance

# Remote Control Overview

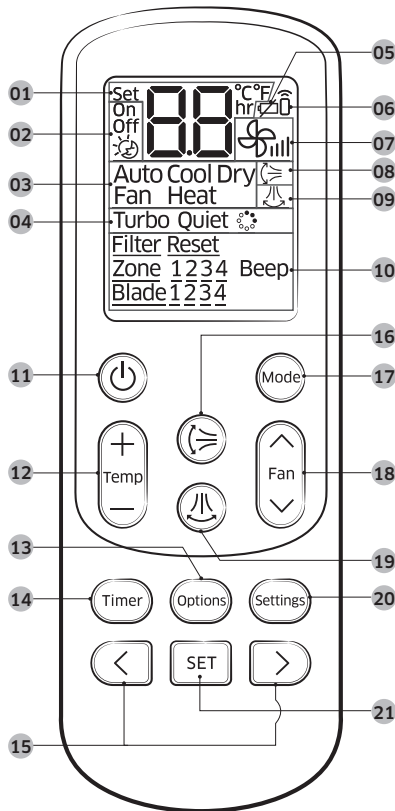

- 01 Set temperature indicator
- 02 Timer option indicator
- 03 Operation mode indicator
- 04 Options indicator
- 05 Low battery indicator
- 06 Transmit indicator

- 07 Fan speed indicator
- 08 Vertical air swing indicator
- 09 Horizontal air swing indicator

**NOTE**

- This function is not available in this model.

- 10 Settings indicator
- 11 Power button
- 12 Temperature button
- 13 Options button
- 14 Timer button
- 15 Direction button/Selection button
- 16 Vertical air swing button
- 17 Mode button
- 18 Fan speed button
- 19 Horizontal air swing button

**NOTE**

- This function is not available in this model.

- 20 Settings button
- 21 SET button

**NOTE**

- The air conditioner may not be operated by the remote control if the controller is placed close to strong light such as a fluorescent lamp or neon sign. In this case, use the remote control right in front of the remote control receiver of the indoor unit.
- If other electrical products are operated by the remote control, call your nearest service center.
- To silence the beep sound, press the **Settings** → <, > or **Settings** → (Beep) blinking → **SET** button. When you press the **Settings** → <, > or **Settings** → (Beep) blinking → **SET** button again, the beep sound will be active again.

# Remote Control Overview

## Replacing batteries

When the  icon appears in the remote control display, replace the batteries with new ones. Two 1.5V AAA type batteries are required.

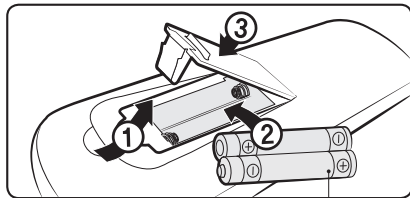

two 1.5V AAA type batteries



### *Correct disposal of batteries in this product*

*(Applicable in countries with separate collection systems)*

This marking on the battery, manual or packaging indicates that the batteries in this product should not be disposed of with other household waste at the end of their working life. Where marked, the chemical symbols Hg, Cd or Pb indicate that the battery contains mercury, cadmium or lead above the reference levels in EC Directive 2006/66.

## Storing the remote control

If the remote control will not be used for an extended period of time, store it in the remote control holder with the batteries removed.

### **CAUTION**

- Make sure that water does not come into the remote control.

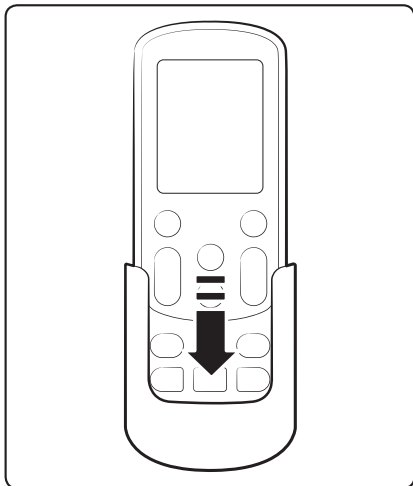

# Operation Modes

---



## Auto

---

In Auto mode, the air conditioner will automatically adjust the temperature and fan speed to maintain your fresh environment.

- When the indoor temperature is too high, the powerful cool breeze is generated and when the indoor room becomes cool enough, the soft breeze is generated.

## Cool

---

The Cool mode is frequently used and you can freely control the temperature, fan speed, and air flow direction in Cool mode.

- When you select the Heat mode while the Cool mode is on, the Cool mode is cancelled.

## Dry

---

The air conditioner in Dry mode acts like a dehumidifier by removing moisture from the indoor air. The Dry mode will provide you with fresh air even on a rainy day.

## Fan

---

The Fan mode provides you with a breeze just like a fan to make fresh environment for you.

# Operation Modes

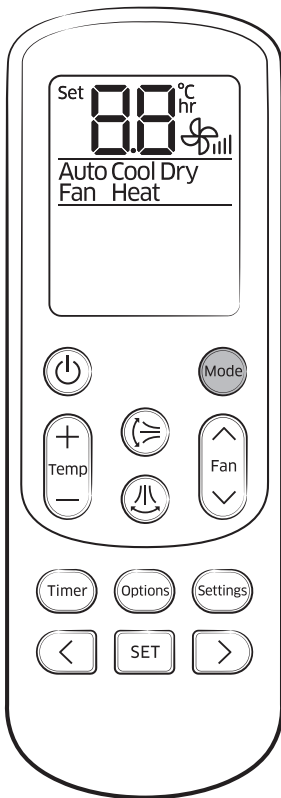

## Heat

In Heat mode, you can warm your room even in fall and winter.

- The fan may not commence immediately to avoid generating a cold breeze.
- In Heat mode, defrost operation may be performed to remove the frost formed on the outdoor unit. (When the frost is removed by the defrost operation in Heat mode, steam is generated from the outdoor unit.)
- If you stop operating the air conditioner after heating operation, the fan will operate for some time to cool the indoor unit.
- When you select the Cool mode while the Heat mode is on, the Heat mode is cancelled.

### NOTE

- When the outdoor temperature is relatively low and the humidity is relatively high in Heat mode, the outdoor unit's heating capacity may decrease due to the frost formed on the outdoor heat exchanger. The defrost operation removes the frost formed on the heat exchanger of the outdoor unit for 5 to 12 minutes. During the defrost operation, the indoor unit does not generate breeze in order to prevent cold breeze blowing out.
  - The interval between defrost operations can decrease depending on the amount of the frost formed on the outdoor unit.
  - The interval between defrost operations can also decrease depending on the humidity level in the air.



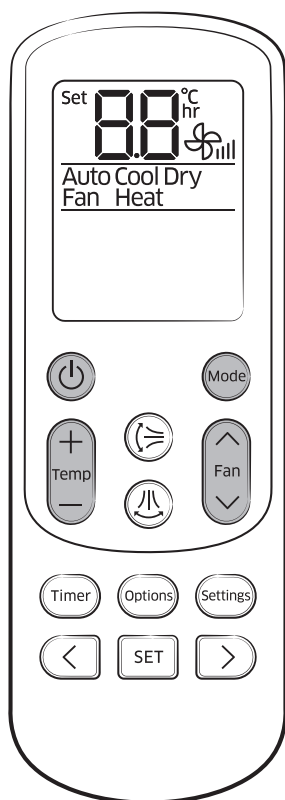

## Turning the air conditioner on

Press the  button to operate the air conditioner.

## Selecting the operation mode

Press the  button to select an operation mode.

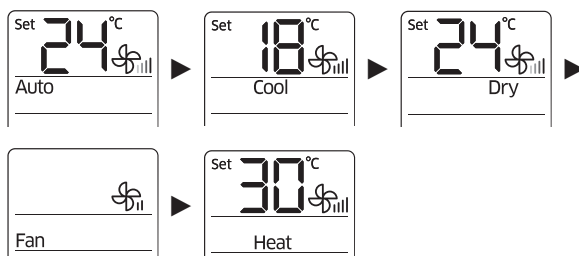









## Adjusting the temperature

Press the  button to adjust the temperature.

Mode	Temperature control
Auto/Cool/ Dry	Adjust by 1 °C between 18 °C and 30 °C.
Heat	Adjust by 1 °C between 16 °C and 30 °C.
Fan	Temperature cannot be adjusted.

## Selecting the fan speed

Press the  button to adjust the fan speed.

Mode	Available fan speeds
Auto/Dry	 (Auto)
Cool/Heat	 (Auto),  (Low),  (Med),  (High)
Fan	 (Low),  (Med),  (High)

# Operation Modes

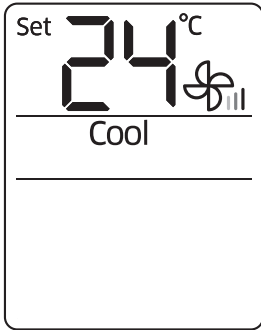
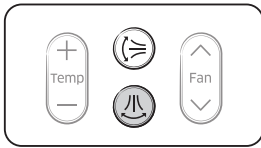

Remote control display

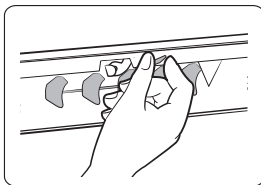

## Selecting air flow direction

Keep the air flow in a constant direction by stopping the movements of the vertical and horizontal air flow blades.

In operation ► 

### NOTE

- If you adjust the vertical air flow blade manually, it may not close completely when you turn off the air conditioner.

## Horizontal air flow (manual)

Keep the horizontal air flow in a constant direction by changing the directions of the horizontal air flow blades manually.

### NOTE

- Although you press the  button, this function does not work.

### CAUTION

- To prevent personal injury, make sure that you change the directions of the horizontal air flow blades after stopping the movements of the vertical air flow blade.

# Setting the On or Off timer

The actual product may differ slightly from the image depicted below.

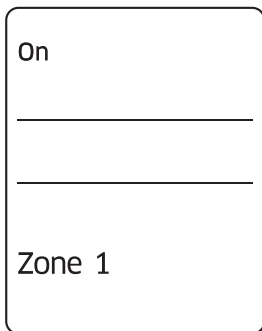
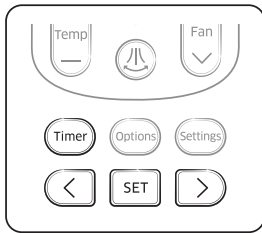

Remote control display

## Setting the On timer

When the air conditioner is turned off:

1. Press the **Timer** button to select (On).
  - The (On) indicator will keep blinking and you can set the time.
2. Press the **<** or **>** button to set the time.
  - You can set the time in half hour intervals from 30 minutes (0.5 on the display) to 3 in hour intervals from 3 to 24 hours.
  - The time can be set from minimum 30 minutes to maximum 24 hours.
3. Press the **SET** button to complete the On timer setting.
  - The (On) indicator and the set time of the timer will be displayed on the remote control display.
  - On timer setting will be cancelled if you don't press the **SET** button within 10 seconds after setting the time. Therefore, check for the (On) indicator on the remote control display.

<b>Cancel</b>	Press the <b>Timer</b> button ► select (On) ► press the <b>&lt;</b> or <b>&gt;</b> button ► set the timer to <b>00</b> ► press the <b>SET</b> button
---------------	--

Additional options available in the On timer	
	Select the mode in the following order: (Auto) ► (Cool) ► (Dry) ► (Fan) and ► (Heat).
	You can adjust the temperature after timer setting is completed. Temperature adjustment is only available in Auto, Cool, Dry, and Heat modes. In Fan mode, the temperature cannot be adjusted.

### NOTE

- When On timer setting is completed, the setting will be displayed for 3 seconds, and then only the (On) indicator will remain on the remote control display.
- You cannot set the Fan speed when setting the On timer.

# Setting the On or Off timer

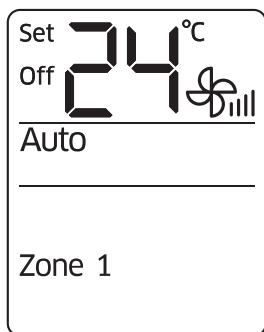
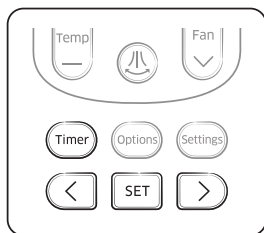

Remote control display

## Setting the Off timer

When the air conditioner is turned on:

1. Press the **Timer** button to select (Off).
  - The (Off) indicator will keep blinking and you can set the time.
2. Press the **<** or **>** button to set the time.
  - You can set the time in half hour intervals from 30 minutes (0,5 on the display) to 3 hours and in hour intervals from 3 to 24 hours.
  - The time can be set from minimum 30 minutes to maximum 24 hours.
3. Press the **SET** button to complete the Off timer setting.
  - The (Off) indicator and the set time of the timer will be displayed on the remote control display.
  - Off timer setting will be cancelled if you don't press the **SET** button within 10 seconds after setting the time. Therefore, check for the (Off) indicator on the remote control display.

<b>Cancel</b>	Press the <b>Timer</b> button ► select (Off) ► press the <b>&lt;</b> or <b>&gt;</b> button ► set the timer to <b>00</b> ► press the <b>SET</b> button
---------------	---

### **NOTE**

- Only the latest timer setting will be applied between the Off timer and good' sleep off timer functions.

### Combining On timer and Off timer

When the air conditioner is turned off	When the air conditioner is turned on
When the set time on On timer is less than that on Off timer e.g. On timer: 3 hours, Off timer: 5 hours <ul style="list-style-type: none"> <li>• The air conditioner will be turned on after 3 hours from the moment you have set the timer and the air conditioner will remain on for 2 hours and then be turned off automatically.</li> </ul>	When the set time on On timer is greater than that on Off timer e.g. On timer: 3 hours, Off timer: 1 hour <ul style="list-style-type: none"> <li>• The air conditioner will be turned off after 1 hour from the moment you have set the timer and will be automatically turned on after 2 hours from the moment it was turned off.</li> </ul>

### **NOTE**

- The set times for the On timer and the Off timer should be different from each other.
- After the On timer or the Off timer is set, the setting can be cancelled by pressing the **Power** button.

# Setting the good'sleep mode

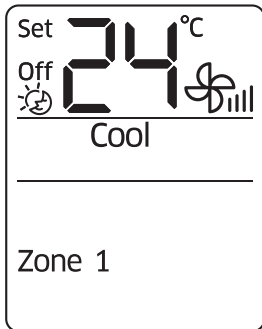
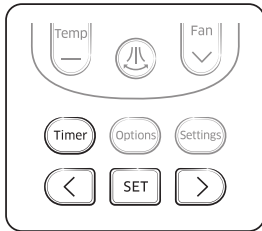

Remote control display

When the air conditioner is operating in **Cool** mode;

1. Press the **Timer** button to select .
  - The () indicator will keep blinking and you can set the time.
2. Press the or button to set the time.
  - You can set the time in half hour intervals from 30 minutes (0.5 on the display) to 3 hours and in hour intervals from 3 to 12 hours.
  - The time can be set from minimum 30 minutes to maximum 12 hours.
  - The default time value for the good'sleep mode is 8 hours.
3. Press the **SET** button to complete the good'sleep mode setting.
  - The () indicator and the set time of the good'sleep mode will be displayed on the remote control display.
  - The good'sleep mode will be cancelled if you don't press the **SET** button within 10 seconds after setting the time. Therefore, check for the () indicator on the remote control display.

<b>Cancel</b>	Press the <b>Timer</b> button ► select () ► press the  or  button ► set the timer to  ► press the <b>SET</b> button
---------------	---

## Additional options available in good'sleep mode





	The temperature can be adjusted by 1 °C (1 °F) within the range of 18 °C (65 °F) to 30 °C (86 °F).
--	--

# Using the good'sleep Function

For a comfortable sleep, the air conditioner will operate in order of 'Fall asleep ► Sound sleep ► Wake up' stages.

- Fall asleep mode: Provides you with comfortable environment for a good sleep by rapid cooling and hypnagogue expedition breeze.
- Sound sleep mode: The sound sleep mode adjusts temperature and air flow in waves to maintain healthy skin temperature while it aids deep sleep. According to the change of good'sleep operation hours, the sound sleep hour can increase or decrease.
- Wake up from good'sleep mode: Provides you with the air flow that adjusts your body temperature to wake you up in a fresh status.

## NOTE

- Recommended set temperature is between 25 °C (77 °F) and 27 °C (81 °F) and the value 26 °C (79 °F) is the most ideal temperature.
- If the set temperature is too low, you may feel cold while sleeping or catch a cold.
- Optimal operation time in good'sleep mode is 8 hours. Therefore, if the time is set too short or long, you may not feel as comfortable as you want.
- If the good'sleep mode is set over 5 hours, The Wake up stage will begin when 1 hour is remaining in the operation time and the air conditioner will stop automatically.
- When the On timer and the good'sleep mode are set simultaneously, the air conditioner will only apply the function that was set later.
- While the good'sleep mode is operating, the  mode can be set additionally by pressing the  button.
- If you press the  button and select the Turbo/quiet function, the good'sleep mode will be cancelled and the selected mode will begin operation.
- If you press the  button, the good'sleep mode will be cancelled and the selected mode will begin operation.

# Using the Turbo Function

You can set the Turbo function to provide fast and powerful cooling.

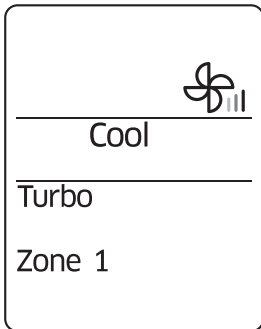
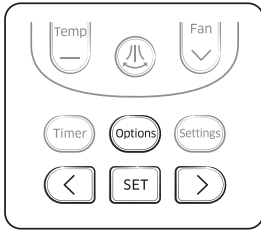

Remote control display

When the air conditioner is operating in Cool mode;

1. Press the **Options** button.
2. Press the **<**, **>** or **Options** button until the (Turbo) indicator starts blinking.
3. Press the **SET** button to set the Turbo function.
  - The (Turbo) indicator will be displayed on the remote control display and Turbo function will operate for 30 minutes.

Cancel	Press the <b>Options</b> button ► press the <b>&lt;</b> , <b>&gt;</b> or <b>Options</b> to make the (Turbo) indicator blink and press the <b>SET</b> button.
--------	--

## **NOTE**

- Turbo function is available in Cool or Heat mode.
- If the Turbo function is selected while the Quiet function is on, the Quiet function will be cancelled.
- The temperature and fan speed cannot be adjusted.



# Using the Purity function

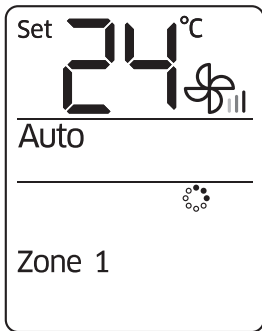
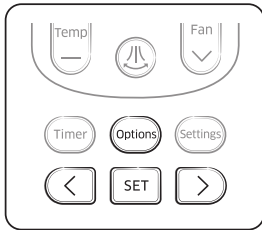

Only for AC\*\*\*RNADKG.

Purity function will remove harmful materials in the air to provide you clean and healthy environment. You can select this function additionally while the air conditioner is in operation.



Remote control display

When the air conditioner is turned on

1. Press the **Options** button.
2. Press the **<**, **>** or **Options** button until the (  ) indicator starts blinking.
3. Press the **SET** button to set the Purity function.
  - (  ) → (  ) indicator will be displayed on the remote controller display and Ionizer function will begin.

Cancel	Press the <b>Options</b> button ► press the <b>&lt;</b> , <b>&gt;</b> or <b>Options</b> to make the (  ) indicator blink and press the <b>SET</b> button.
--------	--

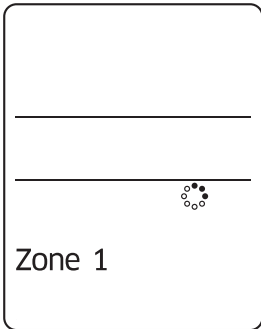
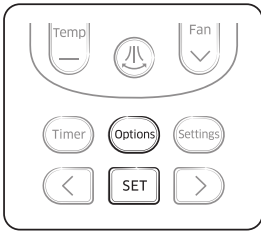

## NOTE

- You may select the purity function additionally during Auto/Cool/Dry/Heat mode and you can adjust the temperature.
- If the purity function is selected additionally in fan mode, the temperature cannot be adjusted.
- When the air conditioner and the purity function are turned on simultaneously and you press the Power button, both air conditioner and purity function will stop operation.
- You can still use the purity function when the On timer is set with the air conditioner is turned off.
- There will not be much difference on energy consumption and operating noise when the purity function is selected additionally while the air conditioner is turned on.



Remote control display

When the air conditioner is turned off

1. Press the **Options** button.
2. Press the **SET** button when (  ) indicator blinks to begin purity function.
  - (  ) → (  ) indicator will be displayed on the remote controller display and lonizer function will begin.

<b>Cancel</b>	Press the <b>Options</b> button to make the (  ) indicator blink and press the <b>SET</b> button.
---------------	--

# Controlling Indoor Units

You can individually select and operate indoor units among 4 indoor units.

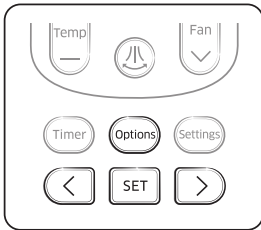

When the air conditioner is turned on:

1. Press the **Settings** button.
2. Press the **<**, **>** or **Settings** button until the (Zone) indicator starts blinking.
3. Press the **SET** button to select the indoor unit to operate.
  - You can select individual units in order of 1 to 4 or select all indoor units at one time.

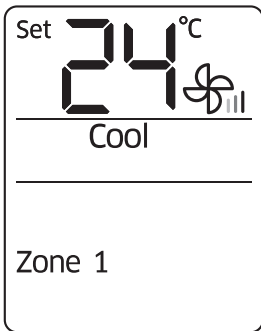

Remote control display

# Cleaning the Air Conditioner

---

## CAUTION

- Before cleaning, be sure to turn off the equipment and disconnect the power plug.

## Cleaning the exterior

---

AC\*\*\*RNADKG

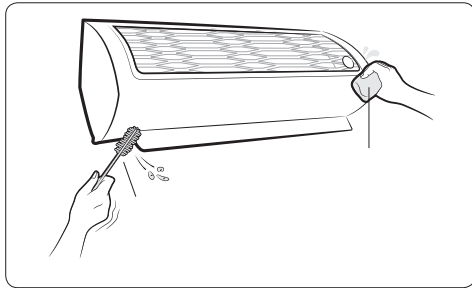

Wipe the surface of the unit with a slightly wet or dry cloth when needed. Wipe off dirt from oddshaped areas by using a soft brush.

## CAUTION

- Do not clean the display by using alkaline detergent.
- Do not use sulphuric acid, hydrochloric acid, or organic solvents (such as thinner, kerosene, and acetone) to clean the surfaces. Do not put any stickers on it as this can damage the surface of the air conditioner.

AC\*\*\*RNTDKG

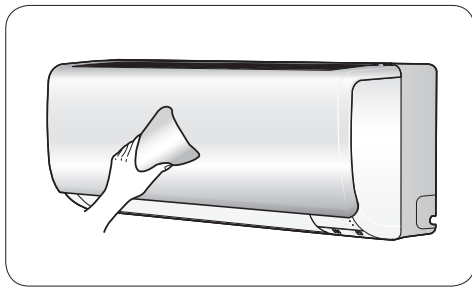

# Cleaning the Air Conditioner

## Cleaning the filter

### AC\*\*\*RNADKG

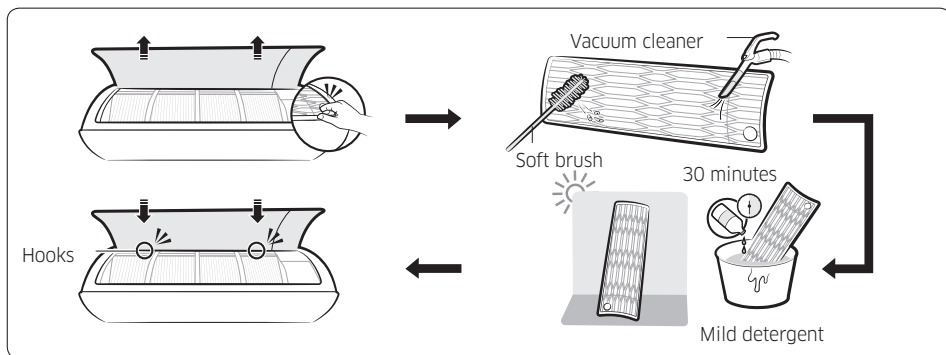

### AC\*\*\*RNTDKG

#### 1. Opening the panel

Tightly grab top of the front panel and pull it down to open. Then slightly lift the panel up.

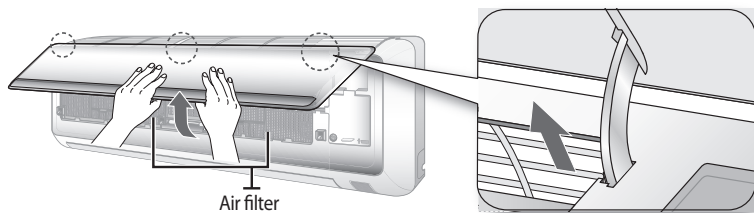

#### 2. Removing the Air filter

Grab the handle and lift it up. Then pull the Air filter towards you and slide it down.

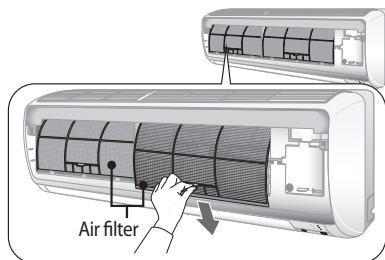

### 3. Cleaning the air filter

Washable foam based air filter captures large particles from the air. The filter is cleaned with a vacuum or by hand washing.

Open the panel and put the Air filter out.

Clean the Air filter with a vacuum cleaner or soft brush. If dust is too heavy, rinse it with running water.

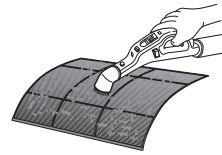

Insert the Air filter back in its original position and close the front panel.

Dry the Air filter in a ventilated area.

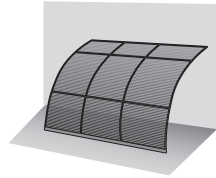

#### CAUTION

- Do not scrub the air filter with a brush or other cleaning utensil. This may damage the filter.
- Do not expose the air filter to direct sunlight when drying it.

#### NOTE

- Clean the air filter every 2 weeks. Cleaning term may vary depending on the usage and environmental conditions.
- If the air filter dries in a humid area, it may produce offensive odours. Clean it again and dry it in a well-ventilated area.

# Maintaining the Air Conditioner

If the air conditioner will not be used for an extended period of time, dry the air conditioner to maintain in best conditions.

1. Dry the air conditioner thoroughly by operating in Fan mode for 3 to 4 hours and disconnect the power plug. There may be internal damage if moisture is left in components.
2. Before using the air conditioner again, dry the inner components of the air conditioner again by running in Fan mode for 3 to 4 hours. This helps remove odours that may have generated from dampness.

## Periodical checks

Refer to the following chart to maintain the air conditioner properly.

Type	Description	Monthly	Every 4 months	Once a year
Indoor unit	Clean the air filter (1).	●		
	Clean the condensate drain pan (2).			●
	Thoroughly clean the heat exchanger (2).			●
	Clean the condensate drain pipe (2).		●	
	Replace the remote control batteries (1).			●
Outdoor unit	Clean the heat exchanger on the outside of the unit (2).		●	
	Clean the heat exchanger on the inside of the unit (2).			●
	Clean the electric components with jets of air (2).			●
	Verify that all the electric components are firmly tightened (2).			●
	Clean the fan (2).			●
	Verify that all the fan assembly is firmly tightened (2).			●
	Clean the condensate drain pan (2).			●

### NOTE

- The checks and maintenance operations described above are essential to guarantee the efficiency of the air conditioner. The frequency of these operations may vary depending on the characteristics of the area, the amount of dust, etc.
  - a. The above mentioned operations should be performed more frequently if the area of installation is very dusty.
  - b. These operations must always be performed by qualified personnel. For more detailed information, refer to Installation Manual.



## Internal protections via the unit control system

This internal protection operates if an internal fault occurs in the air conditioner.

Type	Description
Against cold air	The internal fan will be off against cold air when the heat pump is heating.
De-ice cycle	The internal fan will be off against cold air when the heat pump is heating.
Anti-protection of internal battery	The compressor will be off to protect internal battery when the air conditioner operates in Cool mode.
Protect compressor	The air conditioner does not start operating immediately to protect the compressor of the outdoor unit after it has been started.

### NOTE

- If the heat pump is operating in Heat mode, the de-ice cycle is actuated to remove frost from an outdoor unit that may have deposited at low temperatures.
- The internal fan is switched off automatically and restarted only after the de-ice cycle is completed.
- When the de-ice cycle is operating, it may generate strange sound. It is normal operation for product safety.

# Troubleshooting

---

If the air conditioner operates abnormally, refer to the following chart to save time and unnecessary expenses.

Problem	Solution
<b>The air conditioner does not work at all.</b>	<ul style="list-style-type: none"><li>• Check the power status, then operate the air conditioner again.</li><li>• Switch on the circuit breaker, plug in the power cord, then operate the air conditioner again.</li><li>• Make sure that the isolator is turned on.</li><li>• Check whether the Timed off function is running. Operate the air conditioner again by pressing the Power button.</li></ul>
<b>I cannot change the temperature.</b>	<ul style="list-style-type: none"><li>• Check whether the Fan or Fast mode is running. In these modes, the air conditioner controls the set temperature automatically, and you cannot change the set temperature.</li></ul>

Problem	Solution
<p>Cool/Warm air does not come out the air conditioner or performance is reduced.</p>	<ul style="list-style-type: none"> <li>• Check whether the set temperature is higher in the Cool mode or lower in the Heat mode than the current temperature. Press the Temperature button on the remote control to change the set temperature.</li> <li>• Check whether the air filter is blocked with dirt. If the air filter is blocked, the cooling and heating performance may decrease. Remove dirt regularly.</li> <li>• Check if the outdoor unit is covered or installed near the obstacle. Take the cover off and take the obstacle away. When clearing the obstacle (e.g. snow or ice), use suitable tools so as to be careful not to damage the product nor injure yourself during this process.</li> <li>• Check whether the air conditioner is running the defrost function. When ice forms in winter or the outdoor temperature is too low, the air conditioner runs the defrost function automatically. While this function is running, the indoor fan stops and warm air does not come out.</li> <li>• Check whether doors or windows are open. This may cause poor cooling or heating performance. Close the doors and windows.</li> <li>• Check whether the air conditioner is turned on immediately after the cooling or heating operation stops. In this case, only the fan runs to protect the outdoor unit compressor.</li> <li>• Check whether the pipe length is too long. When the pipe length exceeds the maximum pipe length, the cooling and heating performance may decrease.</li> </ul>

# Troubleshooting

---

Problem	Solution
I cannot change the air flow direction.	<ul style="list-style-type: none"><li>• Check whether the good'sleep function is running. While this function is running, you cannot control the air flow direction. (But you can control the air flow direction if this function is running in the Heat mode.)</li></ul>
I cannot change the fan speed.	<ul style="list-style-type: none"><li>• When the Auto, Dry, or Fast mode is running or the good'sleep function is running in the Cool mode, the air conditioner controls the fan speed automatically and you cannot change the fan speed.</li></ul>
The remote control does not work.	<ul style="list-style-type: none"><li>• Replace the batteries in the remote control with new ones.</li><li>• Make sure that nothing is blocking the remote control sensor.</li><li>• Check whether there are strong lighting apparatus near the air conditioner. Strong light which comes from fluorescent bulbs or neon signs may interrupt the electric waves.</li></ul>
The Timed on/off function does not work.	<ul style="list-style-type: none"><li>• Check whether you pressed the SET button on the remote control after setting the time.</li></ul>
The indicator blinks continuously.	<ul style="list-style-type: none"><li>• Press the Power button to turn off the air conditioner or disconnect the power plug. If the indicator is still blinking, contact the service centre.</li></ul>

Problem	Solution
Odours permeate in the room during operation.	<ul style="list-style-type: none"> <li>• Check whether the air conditioner is running in a smoky area. Ventilate the room or operate the air conditioner in the Fan mode for 3 to 4 hours. (There are no components used in the air conditioner that emit a strong odour.)</li> <li>• Check whether the drains are clean. Clean them regularly.</li> </ul>
An error is indicated.	<ul style="list-style-type: none"> <li>• If the indoor unit indicator blinks, contact the nearest service centre. Be sure to pass the error code to the service centre.</li> </ul>
Noise is generated.	<ul style="list-style-type: none"> <li>• When refrigerant flow changes, noise may be generated, depending on the status of the air conditioner. This is a normal operation.</li> </ul>
'Excessive Noise is Generated' and 'Reduced Performance'	<ul style="list-style-type: none"> <li>• If excessive/irregular noise is generated in conjunction with reduced product performance, please refer to your service engineer to ensure the product is operating correctly.</li> </ul>
Smoke is generated from the outdoor unit.	<ul style="list-style-type: none"> <li>• If may not be a fire but it can be a steam generated from the outdoor heat exchanger while the defrost function is running in the Heat mode in winter.</li> </ul>
Water drops from the pipe connections of the outdoor unit.	<ul style="list-style-type: none"> <li>• Condensation may develop when the ambient temperature changes excessively. This is a normal operation.</li> </ul>

To perform its antimicrobial function this product has been treated with the biocide substance Silver zinc zeolite.

# Operation Ranges

The table below indicates the temperature and humidity ranges the air conditioner can be operated within. Refer to the table for efficient use.

Model	MODE	OPERATIONAL TEMPERATURE		INDOOR HUMIDITY
		INDOOR	OUTDOOR	
AC026RNADKG AC035RNADKG	COOLING	18 °C to 32 °C	-15 °C to 46 °C	80 % or less
	HEATING	30 °C or less	-20 °C to 24 °C	-
	DRYING	18 °C to 32 °C	-15 °C to 46 °C	80 % or less
AC052RNADKG AC071RNADKG AC100RNTDKG	COOLING	18 °C to 32 °C	-15 °C to 50 °C	80 % or less
	HEATING	30 °C or less	-20 °C to 24 °C	-
	DRYING	18 °C to 32 °C	-15 °C to 50 °C	80 % or less

**NOTE**

- The standardized temperature for heating is 7 °C. If the outdoor temperature drops to 0 °C or below, the heating capacity can be reduced depending on the temperature condition.
- If the cooling operation is used at over 32 °C (indoor temperature), it does not cool at its full capacity.

# Technical specifications

Type	Model	Net weight (kg)	Net dimension (W x D x H) (mm)
Indoor unit	AC026RNADKG	7.6	750 x 246 x 249
	AC035RNADKG	7.6	750 x 246 x 249
	AC052RNADKG	10.8	896 x 261 x 261
	AC071RNADKG	14.4	1065 x 294 x 301
	AC100RNTDKG	18.5	1280 x 253 x 345

## Information about refrigerant

### Important information: regulation regarding the refrigerant used

This product contains fluorinated greenhouse gases. Do not vent gases into the atmosphere.

#### CAUTION

- If the system contains 5 tCO<sub>2</sub>e or more of fluorinated greenhouse gases, it must be checked for leakage at least once every 12 months, according to regulation No. 517/2014. This activity must be covered by qualified personnel only. In the case of the situation above, the installer (or authorized person with responsibility for final check) must provide a maintenance book, with all the information recorded, according to REGULATION (EU) No. 517/2014 OF THE EUROPEAN PARLIAMENT AND OF THE COUNCIL of 16 April 2014 on fluorinated greenhouse gases.

Refrigerant type	GWP value
R-32	675

- GWP: Global Warming Potential
- Calculating tCO<sub>2</sub>e: kg x GWP/1000

## QUESTIONS OR COMMENTS?

COUNTRY	CALL	OR VISIT US ONLINE AT
UK	0330 SAMSUNG (7267864)	<a href="http://www.samsung.com/uk/support">www.samsung.com/uk/support</a>
IRELAND (EIRE)	0818 717100	<a href="http://www.samsung.com/ie/support">www.samsung.com/ie/support</a>
GERMANY	06196 77 555 66 *HHP 06196 77 555 77 *OTH	<a href="http://www.samsung.com/de/support">www.samsung.com/de/support</a>
FRANCE	01 48 63 00 00	<a href="http://www.samsung.com/fr/support">www.samsung.com/fr/support</a>
ITALIA	800-SAMSUNG (800.7267864)	<a href="http://www.samsung.com/it/support">www.samsung.com/it/support</a>
SPAIN	0034902172678 [HHP] 0034902167267	<a href="http://www.samsung.com/es/support">www.samsung.com/es/support</a>
PORTUGAL	808 207 267	<a href="http://www.samsung.com/pt/support">www.samsung.com/pt/support</a>
LUXEMBURG	261 03 710	<a href="http://www.samsung.com/be_fr/support">www.samsung.com/be_fr/support</a>
NETHERLANDS	088 90 90 100	<a href="http://www.samsung.com/nl/support">www.samsung.com/nl/support</a>
BELGIUM	02-201-24-18	<a href="http://www.samsung.com/be/support">www.samsung.com/be/support</a> (Dutch) <a href="http://www.samsung.com/be_fr/support">www.samsung.com/be_fr/support</a> (French)
NORWAY	21629099	<a href="http://www.samsung.com/no/support">www.samsung.com/no/support</a>
DENMARK	707 019 70	<a href="http://www.samsung.com/dk/support">www.samsung.com/dk/support</a>
FINLAND	030-6227 515	<a href="http://www.samsung.com/fi/support">www.samsung.com/fi/support</a>
SWEDEN	0771 726 786	<a href="http://www.samsung.com/se/support">www.samsung.com/se/support</a>
POLAND	801-172-678* lub +48 22 607-93-33* Dedykowana infolinia do obsługi zapytań dotyczących telefonów komórkowych: 801-672-678* lub +48 22 607-93-33* * (opłata według taryfy operatora)"	<a href="http://www.samsung.com/pl/support/">http://www.samsung.com/pl/support/</a>
HUNGARY	0680SAMSUNG (0680-726-7864)	<a href="http://www.samsung.com/hu/support">www.samsung.com/hu/support</a>
AUSTRIA	0800-SAMSUNG (0800-7267864) [Only for KNOX customers] 0800 400848 [Only for Premium HA] 0800-366661 [Only for Dealers] 0810-112233 [Only for E-Store] 0800 100 232	<a href="http://www.samsung.com/at/support">www.samsung.com/at/support</a>
SWITZERLAND	0800 726 78 64 (0800-SAMSUNG)	<a href="http://www.samsung.com/ch/support">www.samsung.com/ch/support</a> German) <a href="http://www.samsung.com/ch_fr/support">www.samsung.com/ch_fr/support</a> French)
CZECH	800 - SAMSUNG (800-726786)	<a href="http://www.samsung.com/cz/support">www.samsung.com/cz/support</a>
SLOVAKIA	0800 - SAMSUNG (0800-726 786)	<a href="http://www.samsung.com/sk/support">www.samsung.com/sk/support</a>
CROATIA	072 726 786	<a href="http://www.samsung.com/hr/support">www.samsung.com/hr/support</a>
BOSNIA	055 233 999	<a href="http://www.samsung.com/support">www.samsung.com/support</a>
MONTENEGRO	020 405 888	<a href="http://www.samsung.com/support">www.samsung.com/support</a>
SLOVENIA	080 697 267 (brezplačna številka)	<a href="http://www.samsung.com/si/support">www.samsung.com/si/support</a>
SERBIA	011 321 6899	<a href="http://www.samsung.com/rs/support">www.samsung.com/rs/support</a>
BULGARIA	*3000 Цена в мрежата 0800 111 31 , Безплатна телефонна линия	<a href="http://www.samsung.com/bg/support">www.samsung.com/bg/support</a>
ROMANIA	*8000 (apel in retea) 08008-726-78-64 (08008-SAMSUNG) Apel GRATUIT	<a href="http://www.samsung.com/ro/support">www.samsung.com/ro/support</a>
CYPRUS	8009 4000 only from landline, toll free	<a href="http://www.samsung.com/gr/support">www.samsung.com/gr/support</a>
GREECE	80111-SAMSUNG (80111 726 7864) only from land line (+30) 210 6897691 from mobile and land line	
LITHUANIA	8-800-77777	<a href="http://www.samsung.com/lt/support">www.samsung.com/lt/support</a>
LATVIA	8000-7267	<a href="http://www.samsung.com/lv/support">www.samsung.com/lv/support</a>
ESTONIA	800-7267	<a href="http://www.samsung.com/ee/support">www.samsung.com/ee/support</a>



This appliance is filled with R-32.