



# Remocon module installation

DB68-08843A-00



■ Model : MIM-A00N / A00UN

## Components part

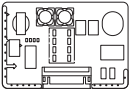
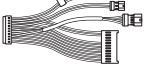
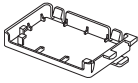
Product Name	Main PBA	COMM. Wire	Case
Quantity	1EA	1EA	1EA
Shape			
Code	DB92-02809A	DB93-17172A	DB61-07433A

## Description

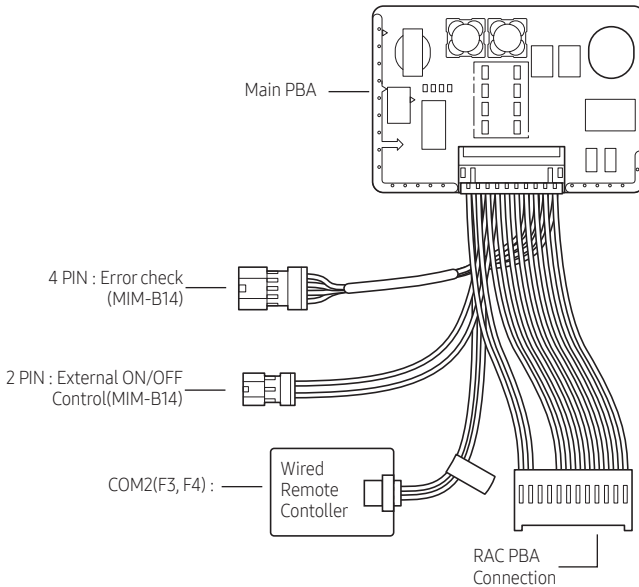
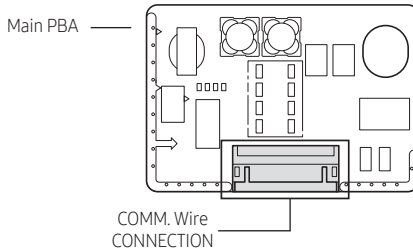

English



# Installation du module avec contrôle à distance

■ Modèle : MIM-A00N / A00UN

## Pièce des composants

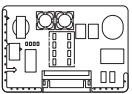
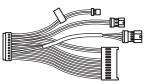
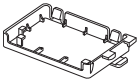
Nom du produit	Carte à circuit imprimé principale	COMM. Câble	Boîtier
Quantité	1EA	1EA	1EA
Forme			
Code	DB92-02809A	DB93-17172A	DB61-07433A

## Description

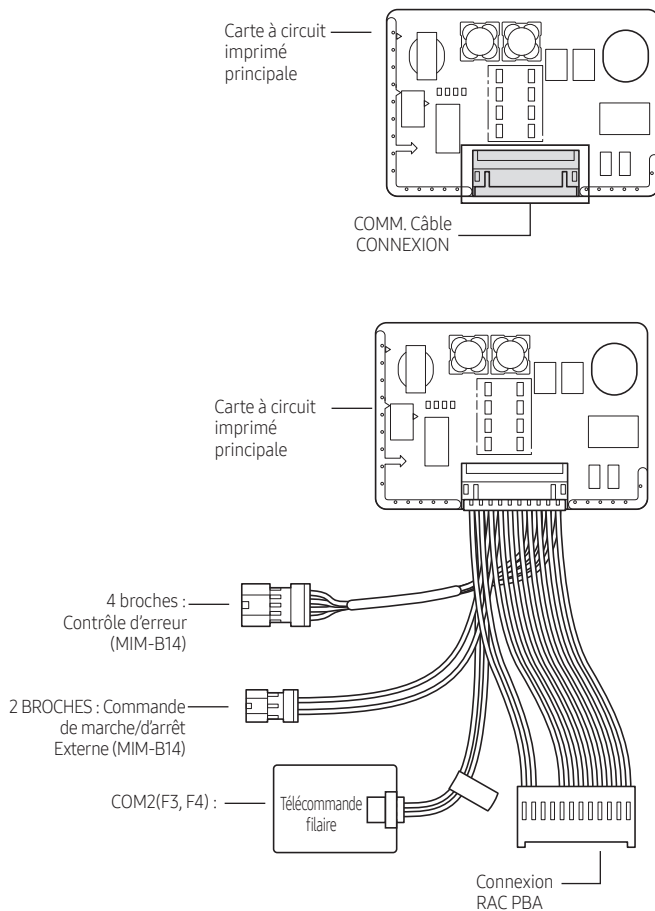

Français